

EBox1007P

User Manual

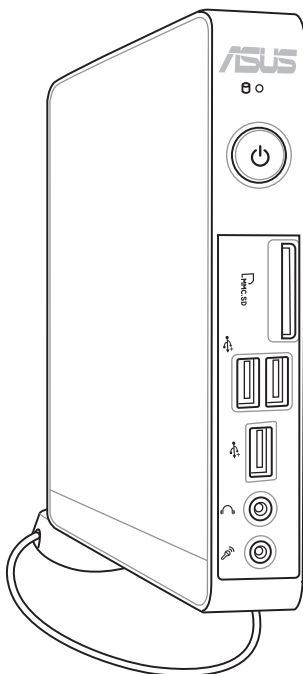

E7312

First Edition

March 2012

Copyright © 2012 ASUSTeK COMPUTER INC. All Rights Reserved.

No part of this manual, including the products and software described in it, may be reproduced, transmitted, transcribed, stored in a retrieval system, or translated into any language in any form or by any means, except documentation kept by the purchaser for backup purposes, without the express written permission of ASUSTeK COMPUTER, INC. ("ASUS").

Products and corporate names mentioned in this manual may or may not be registered trademarks or copyrights of their respective companies, and are used for identification purposes only. All trademarks are the property of their respective owners.

Every effort has been made to ensure that the contents of this manual are correct and up to date. However, the manufacturer makes no guarantee regarding the accuracy of its contents, and reserves the right to make changes without prior notice.

Contents

Contents.....	3
Notices.....	4
Safety information.....	9
Global Environmental Regulation Compliance and Declaration	11
ASUS Recycling/Takeback Services	11
ENERGY STAR complied product.....	12
Notes for this manual	12
Welcome	13
Package contents.....	13
Knowing your PC	14
Front view.....	14
Rear view.....	16
Top view	18
Bottom view	19
Positioning your PC	20
Installing the stand (optional).....	20
Installing your PC to a monitor (optional)	21
Setting up your PC.....	22
Connecting to a display.....	22
Connecting to USB devices	22
Connecting to a network device.....	23
Connecting to LAN	23
Connecting to Wi-Fi via wireless antenna	23
Turning on the system	24
Using your PC.....	25
Configuring wireless connection	25
Configuring wired connection.....	26
ASUS Easy Update	30
Recovering your system	31
Using the recovery partition.....	31
Using the USB storage device (USB Restore)	33

Notices

Federal Communications Commission Statement

This device complies with Part 15 of the FCC Rules. Operation is subject to the following two conditions:

- This device may not cause harmful interference, and
- This device must accept any interference received including interference that may cause undesired operation.

This equipment has been tested and found to comply with the limits for a Class B digital device, pursuant to Part 15 of the FCC Rules. These limits are designed to provide reasonable protection against harmful interference in a residential installation. This equipment generates, uses and can radiate radio frequency energy and, if not installed and used in accordance with manufacturer's instructions, may cause harmful interference to radio communications. However, there is no guarantee that interference will not occur in a particular installation. If this equipment does cause harmful interference to radio or television reception, which can be determined by turning the equipment off and on, the user is encouraged to try to correct the interference by one or more of the following measures:

- Reorient or relocate the receiving antenna.
- Increase the separation between the equipment and receiver.
- Connect the equipment to an outlet on a circuit different from that to which the receiver is connected.
- Consult the dealer or an experienced radio/TV technician for help.

CAUTION: Any changes or modifications not expressly approved by the grantee of this device could void the user's authority to operate the equipment.

RF exposure warning

This equipment must be installed and operated in accordance with provided instructions and the antenna(s) used for this transmitter must be installed to provide a separation distance of at least 20 cm from all persons and must not be co-located or operating in conjunction with any other antenna or transmitter. End-users and installers must be provide with antenna installation instructions and transmitter operating conditions for satisfying RF exposure compliance.

Declaration of Conformity (R&TTE directive 1999/5/EC)

The following items were completed and are considered relevant and sufficient:

- Essential requirements as in [Article 3]
- Protection requirements for health and safety as in [Article 3.1a]
- Testing for electric safety according to [EN 60950]
- Protection requirements for electromagnetic compatibility in [Article 3.1b]
- Testing for electromagnetic compatibility according to [EN 301 489-1] & [EN 301 489-17]
- Effective use of the radio spectrum as in [Article 3.2]
- Radio test suites according to [EN 300 328-2]

CE Marking



CE marking for devices without wireless LAN/Bluetooth

The shipped version of this device complies with the requirements of the EEC directives 2004/108/EC "Electromagnetic compatibility" and 2006/95/EC "Low voltage directive".



CE marking for devices with wireless LAN/ Bluetooth

This equipment complies with the requirements of Directive 1999/5/EC of the European Parliament and Commission from 9 March, 1999 governing Radio and Telecommunications Equipment and mutual recognition of conformity.

Wireless Operation Channel for Different Domains

N. America	2.412-2.462 GHz	Ch01 through CH11
Japan	2.412-2.484 GHz	Ch01 through Ch14
Europe ETSI	2.412-2.472 GHz	Ch01 through Ch13

France Restricted Wireless Frequency Bands

Some areas of France have a restricted frequency band. The worst case maximum authorized power indoors are:

- 10mW for the entire 2.4 GHz band (2400 MHz–2483.5 MHz)
- 100mW for frequencies between 2446.5 MHz and 2483.5 MHz



Channels 10 through 13 inclusive operate in the band 2446.6 MHz to 2483.5 MHz.

There are few possibilities for outdoor use: On private property or on the private property of public persons, use is subject to a preliminary authorization procedure by the Ministry of Defense, with maximum authorized power of 100mW in the 2446.5–2483.5 MHz band. Use outdoors on public property is not permitted.

In the departments listed below, for the entire 2.4 GHz band:

- Maximum authorized power indoors is 100mW
- Maximum authorized power outdoors is 10mW

Departments in which the use of the 2400–2483.5 MHz band is permitted with an EIRP of less than 100mW indoors and less than 10mW outdoors:

01 Ain	02 Aisne	03 Allier
05 Hautes Alpes	08 Ardennes	09 Ariège
11 Aude	12 Aveyron	16 Charente
24 Dordogne	25 Doubs	26 Drôme
32 Gers	36 Indre	37 Indre et Loire
41 Loir et Cher	45 Loiret	50 Manche
55 Meuse	58 Nièvre	59 Nord
60 Oise	61 Orne	63 Puy du Dôme
64 Pyrénées Atlantique	66 Pyrénées Orientales	
67 Bas Rhin	68 Haut Rhin	
70 Haute Saône	71 Saône et Loire	
75 Paris	82 Tarn et Garonne	
84 Vaucluse	88 Vosges	89 Yonne
90 Territoire de Belfort	94 Val de Marne	

This requirement is likely to change over time, allowing you to use your wireless LAN card in more areas within France. Please check with ART for the latest information (www.arcep.fr)



Your WLAN Card transmits less than 100mW, but more than 10mW.

Canadian Department of Communications Statement

This digital apparatus does not exceed the Class B limits for radio noise emissions from digital apparatus set out in the Radio Interference Regulations of the Canadian Department of Communications.

This class B digital apparatus complies with Canadian ICES-003.

IC Radiation Exposure Statement for Canada

This equipment complies with IC radiation exposure limits set forth for an uncontrolled environment. To maintain compliance with IC RF exposure compliance requirements, please avoid direct contact to the transmitting antenna during transmitting. End users must follow the specific operating instructions for satisfying RF exposure compliance.

Operation is subject to the following two conditions:

- This device may not cause interference and
- This device must accept any interference, including interference that may cause undesired operation of the device.

REACH

Complying with the REACH (Registration, Evaluation, Authorization, and Restriction of Chemicals) regulatory framework, we publish the chemical substances in our products at ASUS REACH website at <http://csr.asus.com/english/REACH.htm>.

Safety information

Your PC is designed and tested to meet the latest standards of safety for information technology equipment. However, to ensure your safety, it is important that you read the following safety instructions.

Setting up your system

- Read and follow all instructions in the documentation before you operate your system.
- Do not use this product near water or a heated source such as a radiator.
- Set up the system on a stable surface with the provided stand. Never use the system alone without the stand.
- Openings on the chassis are for ventilation. Do not block or cover these openings. Make sure you leave plenty of space around the system for ventilation. Never insert objects of any kind into the ventilation openings.
- Use this product in environments with ambient temperatures between 0°C and 35°C.
- If you use an extension cord, make sure that the total ampere rating of the devices plugged into the extension cord does not exceed its ampere rating.

Care during use

- Do not walk on the power cord or allow anything to rest on it.
- Do not spill water or any other liquids on your system.
- When the system is turned off, a small amount of electrical current still flows. Always unplug all power, modem, and network cables from the power outlets before cleaning the system.
- If you encounter the following technical problems with the product, unplug the power cord and contact a qualified service technician or your retailer.
 - The power cord or plug is damaged.
 - Liquid has been spilled into the system.

- The system does not function properly even if you follow the operating instructions.
- The system was dropped or the cabinet is damaged.
- The system performance changes.

Lithium-Ion Battery Warning

CAUTION: Danger of explosion if battery is incorrectly replaced. Replace only with the same or equivalent type recommended by the manufacturer. Dispose of used batteries according to the manufacturer's instructions.

LASER PRODUCT WARNING

CLASS 1 LASER PRODUCT

NO DISASSEMBLY

The warranty does not apply to the products that have been disassembled by users



DO NOT throw the PC in municipal waste. This product has been designed to enable proper reuse of parts and recycling. This symbol of the crossed out wheeled bin indicates that the product (electrical, electronic equipment, and mercury-containing button cell battery) should not be placed in municipal waste. Check local technical support services for product recycling.



DO NOT throw the battery in municipal waste. This symbol of the crossed out wheeled bin indicates that the battery should not be placed in municipal waste. Check local technical support services for battery replacement.

Global Environmental Regulation Compliance and Declaration

ASUS follows the green design concept to design and manufacture our products, and makes sure that each stage of the product life cycle of ASUS product is in line with global environmental regulations. In addition, ASUS disclose the relevant information based on regulation requirements.

Please refer to <http://csr.asus.com/english/Compliance.htm> for information disclosure based on regulation requirements ASUS is complied with:

Japan JIS-C-0950 Material Declarations
EU REACH SVHC
Swiss Energy Laws

ASUS Recycling/Takeback Services

ASUS recycling and takeback programs come from our commitment to the highest standards for protecting our environment. We believe in providing solutions for you to be able to responsibly recycle our products, batteries, other components as well as the packaging materials. Please go to <http://csr.asus.com/english/Takeback.htm> for detailed recycling information in different regions.

ENERGY STAR complied product



ENERGY STAR is a joint program of the U.S. Environmental Protection Agency and the U.S. Department of Energy helping us all save money and protect the environment through energy efficient products and practices.

All ASUS products with the ENERGY STAR logo comply with the ENERGY STAR standard, and the power management feature is enabled by default. The monitor and computer are automatically set to sleep after 15 and 30 minutes of user inactivity. To wake your computer, click the mouse or press any key on the keyboard.

Please visit <http://www.energy.gov/powermanagement> for detail information on power management and its benefits to the environment. In addition, please visit <http://www.energystar.gov> for detail information on the ENERGY STAR joint program.



ENERGY STAR is NOT supported on FreeDOS-based products or without OS.

Notes for this manual

To make sure that you perform certain tasks properly, take note of the following symbols used throughout this manual.



WARNING: Vital information that you **MUST** follow to prevent injury to yourself.



IMPORTANT: Instructions that you **MUST** follow to complete a task.



TIP: Tips and useful information that help you complete a task.









NOTE: Additional information for special situations.

Welcome

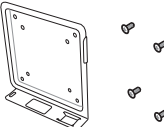
Congratulations on your purchase of the PC. The following illustration displays the package contents of your new PC. If any of the below items is damaged or missing, contact your retailer.

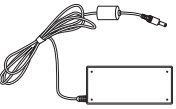
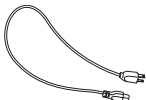
Package contents

		
PC	Stand and screw (optional)	VESA mount and Screw pack (optional)
		
Antenna	AC adapter	Power cord
		
Warranty card	Quick start guide	



If the device or its components fail or malfunction during normal and proper use within the warranty period, bring the warranty card to the ASUS Service Center for replacement of the defective components.

Knowing your PC

Front view

Refer to the diagram below to identify the components on this side of the system.

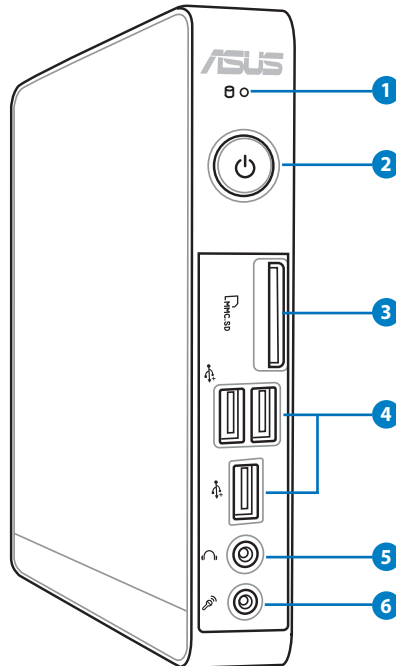





1  **Hard disk LED**

The hard disk LED blinks when data is being written into or read from the hard disk drive.

2  **Power switch**

The power switch allows powering ON and OFF the system.

- 3**  **Memory card slot**
The built-in memory card reader reads MMC/SD/SDHC cards used in devices like digital cameras, MP3 players, mobile phones, and PDAs.
- 4**  **USB port**
The USB (Universal Serial Bus) port is compatible with USB devices such as keyboards, mouse devices, cameras, and hard disk drives. USB allows many devices to run simultaneously on a single computer, with some peripheral acting as additional plug-in sites or hubs.
- 5**  **Headphone/Audio Out jack**
The stereo headphone jack (3.5mm) is used to connect the system's audio out signal to amplified speakers or headphones.
- 6**  **Microphone jack**
The microphone jack is designed to connect the microphone used for video conferencing, voice narrations, or simple audio recordings.

Rear view

Refer to the diagram below to identify the components on this side of the system.

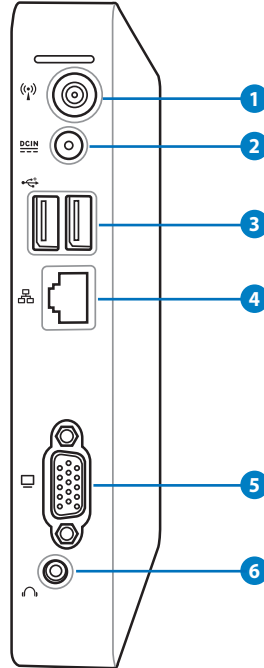

1 Antenna jack

The jack is used to connect the supplied wireless antenna to enhance wireless signal reception.



The antenna is installable/ removable according to need. Fasten the antenna onto the PC for better signal reception when Wi-Fi is in use.

2 Power input (DC 19V)

The supplied power adapter converts AC power to DC power for use with this jack. Power supplied through this jack supplies power to the PC. To prevent damage to the PC, always use the supplied power adapter.



The power adapter may become warm to hot when in use. Do not cover the adapter and keep it away from your body.

3 USB port

The USB (Universal Serial Bus) port is compatible with USB devices such as keyboards, mouse devices, cameras, and hard disk drives. USB allows many devices to run simultaneously on a single computer, with some peripheral acting as additional plug-in sites or hubs.

4 LAN port

The eight-pin RJ-45 LAN port supports a standard Ethernet cable for connection to a local network.

5 Display (Monitor) Output

The 15-pin D-sub monitor port supports a standard VGA-compatible device such as a monitor or projector to allow viewing on a larger external display.

6 Headphone/Audio Out jack

The stereo headphone jack (3.5mm) is used to connect the system's audio out signal to amplified speakers or headphones.

Top view

Refer to the diagram below to identify the components on this side of the system.

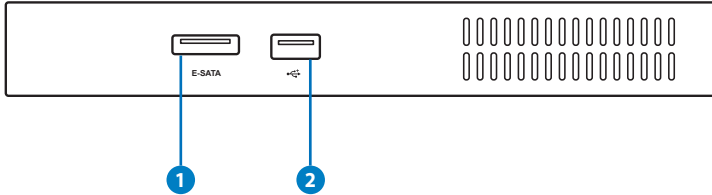

1 ESATA e-SATA Port

External SATA or eSATA allows external connection of Serial-ATA devices originally designed for use inside the computer. It is up to six times faster than existing USB 2.0, & 1394 for external storage solutions and is also hot pluggable using shielded cables and connectors up to two meters.

2 USB port

The USB (Universal Serial Bus) port is compatible with USB devices such as keyboards, mouse devices, cameras, and hard disk drives. USB allows many devices to run simultaneously on a single computer, with some peripheral acting as additional plug-in sites or hubs.

Bottom view

Refer to the diagram below to identify the components on this side of the system.

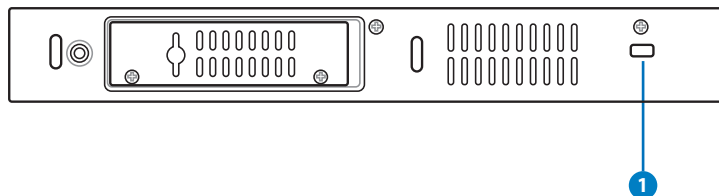

1 Kensington® Lock Port

The Kensington® lock port allows the PC to be secured using Kensington® compatible security products. These security products usually include a metal cable and lock that prevent the PC to be removed from a fixed object.

Positioning your PC

Installing the stand (optional)

Erect your PC with the optional stand. To do so:

1. Locate the screw hole on the bottom of the PC.
2. Align the stand screw to the PC screw hole, and then secure the stand to the PC with a coin.

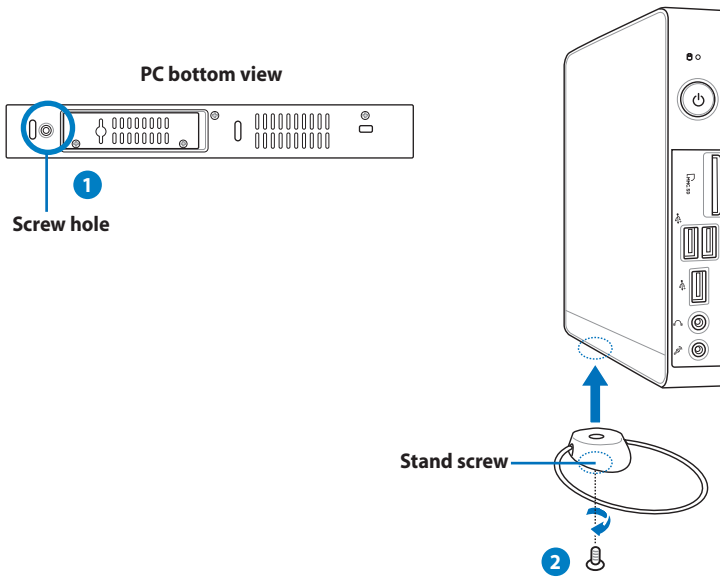

Installing your PC to a monitor (optional)

You can also install your PC to the back of a monitor. To do so:

1. Secure the optional VESA mount to your monitor with four screws (HNM/M4 x 8).



To fasten the VESA mount, your monitor must comply with VESA75 or VESA100 standard.

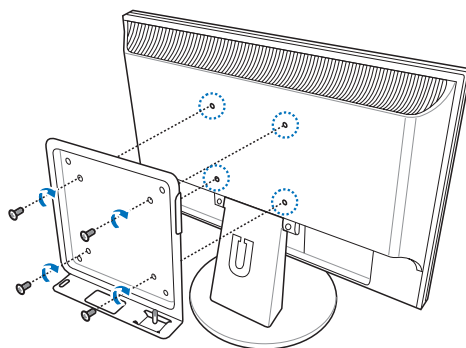

2. Place your PC on the VESA mount noting the correct alignment, and then secure the PC to the VESA mount with a coin.

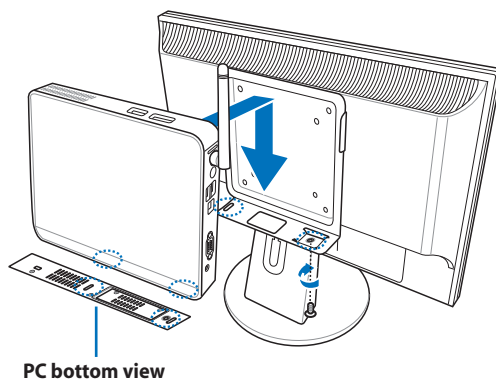

Setting up your PC

You need to connect peripherals before using your PC.

Connecting to a display

Connect one end of the VGA cable to an LCD monitor (1) and the other end to the **Display (Monitor) Output** port on the system rear panel (2).

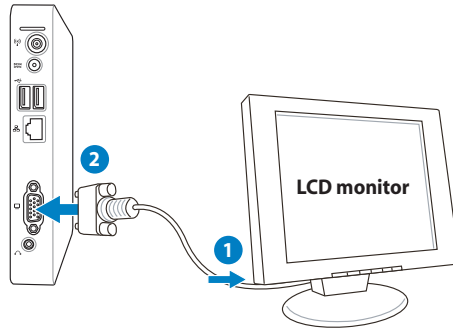

Connecting to USB devices

Connect USB devices like wired/wireless keyboards (varying with areas), mouse devices, and printers to the **USB** ports on the system rear panel.

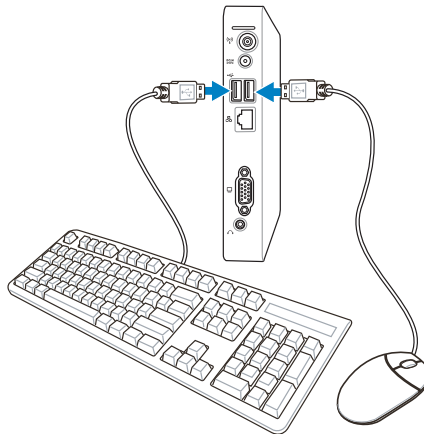

Connecting to a network device

Connecting to LAN

Connect one end of a network cable to the **LAN** port on the system rear panel and the other end to a hub or switch.

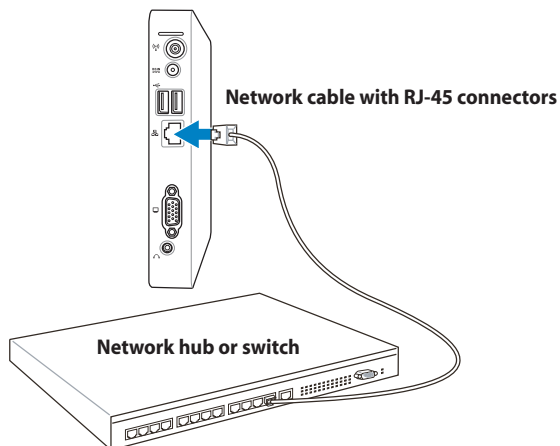

Connecting to Wi-Fi via wireless antenna

The wireless antenna is provided for enhancing wireless signal reception. The antenna is installable/ removable according to need. Fasten the antenna onto the PC for better signal reception when Wi-Fi is in use.

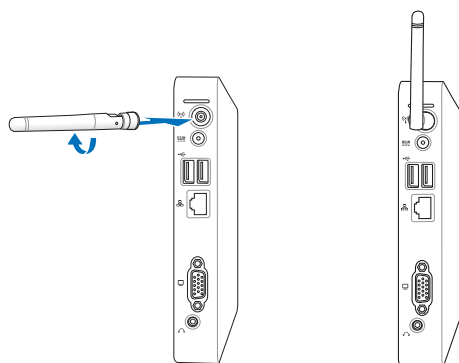

Turning on the system

Connect the supplied AC adapter to the **DC IN** jack on the system rear panel, and then press the **power switch** on the front panel to turn on the system.

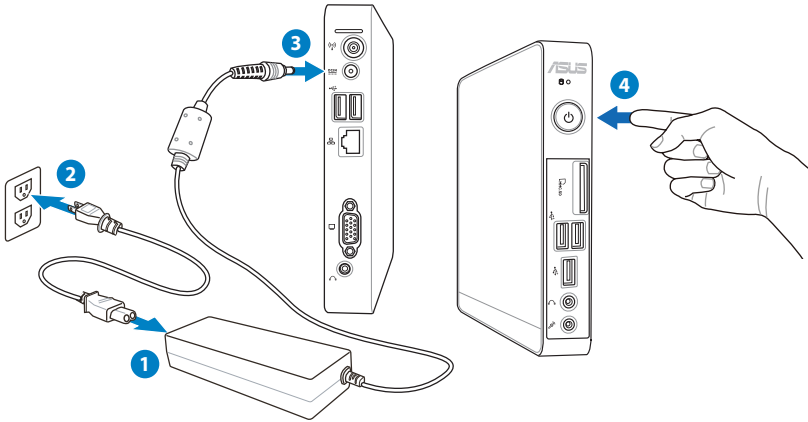

- When your PC is not in use, unplug the power adapter or switch off the AC outlet to save on power consumption.
- Adjust the power management settings in the Windows® Control Panel. This is to ensure that your PC is set to a low power consumption mode and is fully operational at the same time.



To enter the BIOS setup, press **<F2>** repeatedly during bootup.

Using your PC



All screenshots in this section are for reference only. Actual screen images may vary with operating systems. Visit the ASUS website at www.asus.com for the latest information.



This PC is not supported under Windows® 8.

Configuring wireless connection

To connect to a wireless network, follow the instructions below:



For security concerns, DO NOT connect to an unsecured network. Otherwise, the transmitted information without encryption might be visible to others.

1. Click the wireless network icon with an orange star  in the Windows® Notification area.
2. Select the wireless access point you want to connect to from the list and click **Connect** to build the connection.



If you cannot find the desired access point, click the **Refresh** icon  on the upper right corner to refresh and search in the list again.



3. When connecting, you may have to enter a password.
4. After a connection has been established, the connection is shown on the list.
5. You can see the wireless network icon  in the Notification area.

Configuring wired connection

To establish a wired network, follow the instructions below:

Using a dynamic IP / PPPoE network connection:

1. Click the network icon with a yellow warning triangle  in the Windows® Notification area and select **Open Network and Sharing Center**.

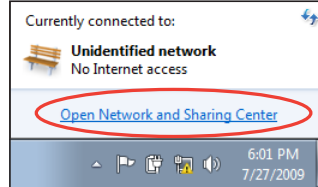

2. Click **Change adapter settings** in the left blue pane.

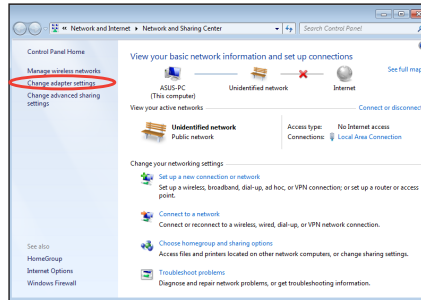

3. Right-click **Local Area Connection** and select **Properties**.

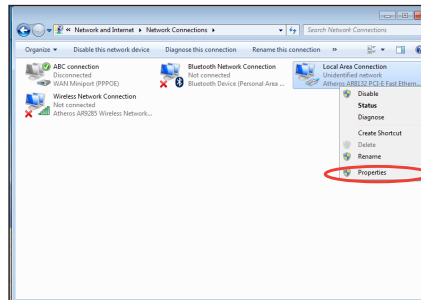

4. Click **Internet Protocol Version 4(TCP/IPv4)** and click **Properties**.
5. Click **Obtain an IP address automatically** and click **OK**.

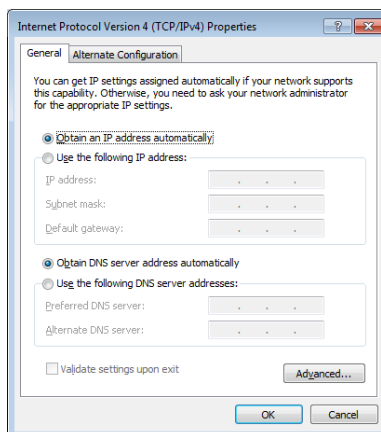
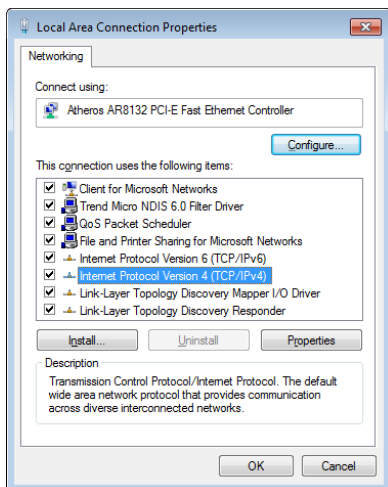

(Continue the following steps if using PPPoE)

6. Return to the **Network and Sharing Center** and then click **Set up a new connection or network**.

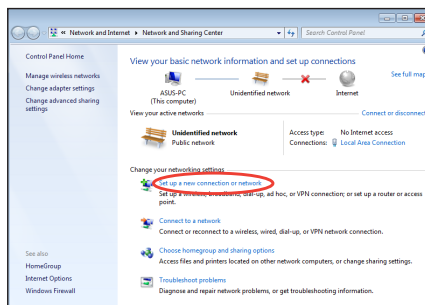

7. Select **Connect to the Internet** and click **Next**.

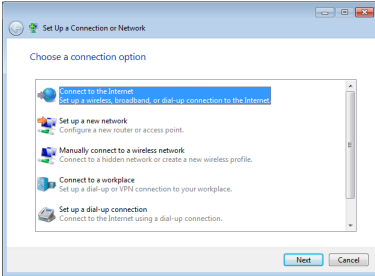

8. Select **Broadband (PPPoE)** and click **Next**.

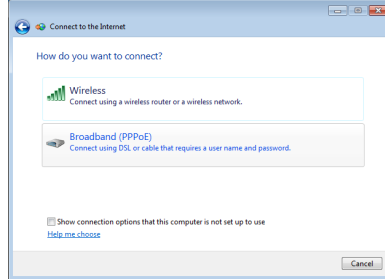

9. Enter your User name and, Password, and Connection name. Click **Connect**.

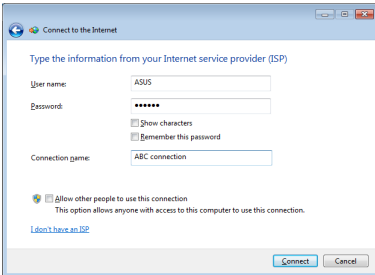

10. Click **Close** to finish the configuration.

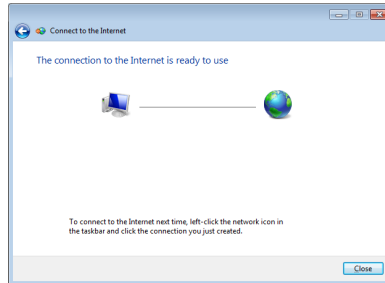

11. Click the network icon in the taskbar and click the connection you just created.

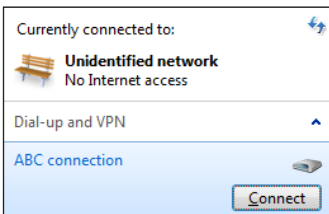

12. Enter your user name and password. Click **Connect** to connect to the Internet.

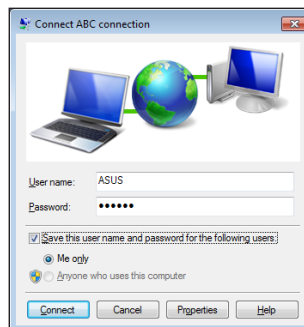

Using a static IP:

1. Repeat steps 1–4 in Using a dynamic IP to start the static IP network configuration.
2. Click **Use the following IP address**.
3. Enter the IP address, Subnet mask and Gateway from your service provider.
4. If needed, enter the preferred DNS Server address and alternative address.
5. After entering all the related values, click OK to build the network connection.

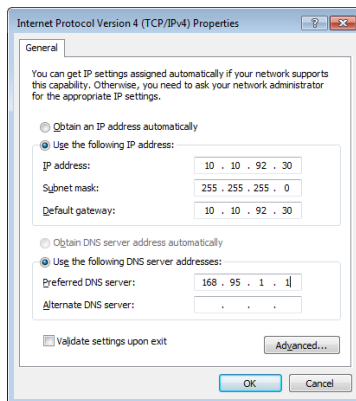

ASUS Easy Update

ASUS Easy Update is a software tool that automatically detects and downloads the latest BIOS, drivers, and applications for your PC.

1. From the Windows® notification area, right-click the **ASUS Easy Update** icon.



2. Select **Schedule** to set how often you want to update your system.
3. Select **Update** to activate the update.

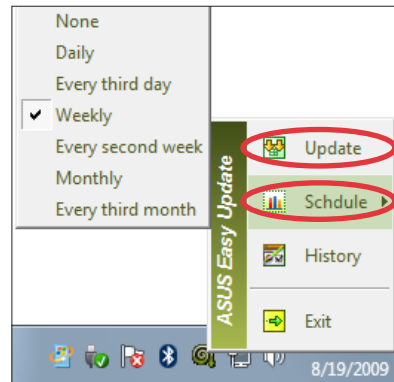

4. Click **OK** to display the items you can download.

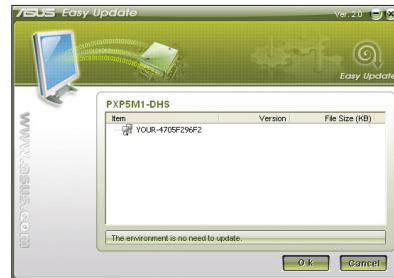

5. Check the item(s) you want to download, and then click **OK**.

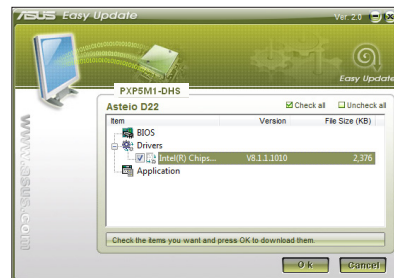

Recovering your system

Using the recovery partition

The Recovery Partition includes an image of the operating system, drivers, and utilities installed on your system at the factory. The recovery partition provides a comprehensive recovery solution that quickly restores your system's software to its original working state, provided that your hard disk drive is in good working order. Before using the recovery partition, copy your data files (such as Outlook PST files) to a USB device or to a network drive and make note of any customized configuration settings (such as network settings).

Recovering the Windows OS to the Factory Default Partition (F9 Recovery)

1. Press [F9] during bootup.
2. Select **Windows setup [EMS Enabled]** when this item appears and press [Enter].
3. Select the language and click **Next**.
4. Select **Recover the OS to the Default Partition** and click **Next**.
5. The factory default partition will be displayed. Click **Next**.
6. Data on the default partition will be cleared. Click **Recover** to start the system recovery.



You will lose all your data on the selected partition. Ensure to back up your important data beforehand.

7. When recovery is successfully completed, click **Reboot** to restart the system.

Backing up the Factory Default Environment Data to a USB Drive (F9 Backup)

1. Repeat steps 1–3 in the previous section.
2. Select **Backup the Factory Environment to a USB Drive** and click Next.
3. Connect a USB storage device to your PC to start the Factory Default Environment backup.



The required size of the connected USB storage device should be larger than 20GB. The actual size may vary with your PC model.

4. Select a desired USB storage device if more than one USB storage device is connected to your PC and click **Next**.



If there is already a partition with proper size in the selected USB storage device (for example, a partition that has been used as the backup partition), the system will show this partition automatically and reuse it for backup.

5. Based on the different situations in the previous step, data on the selected USB storage device or on the selected partition will be cleared. Click **Backup** to start backup.



You will lose all your data on the selected USB storage device or on the selected partition. Ensure to back up your important data beforehand.

6. When backing up the factory default environment is successfully completed, click **Reboot** to restart the system.

Using the USB storage device (USB Restore)

When the Recovery Partition in your system is crashed, use the USB storage device to restore the system to the factory default partition or the factory environment data to the entire hard disk.

1. Connect the USB storage device that you back up the factory environment data to.
2. Press <F8> for on bootup and the **Please select boot device** screen appears. Select USB:XXXXXX to boot from the connected USB storage device.
3. Select the language and click **Next**.
4. Select **Restore** and click **Next**.
5. Select a task and click **Next**. Task options:

Restore the OS to the Default Partition only

Select this option if you simply want to restore the OS to the factory default partition. This option deletes all data on the system partition "C" and keeps the partition "D" unchanged.

After you click Next, the factory default partition will be displayed. Click **Next** again.

Restore the Whole Hard Disk

Select this option if you want to restore your PC to the factory default state. This option deletes all data from your hard disk and creates a new system partition as drive "C", an empty partition as drive "D" and a Recovery Partition.

6. Data on the factory default partition or on the whole hard disk will be cleared depending on the option you selected in the previous step. Click **Restore** to start the task.
7. When restore is successfully completed, click **Reboot** to restart the system.

ASUS contact information

ASUSTeK COMPUTER INC.

Address 15 Li-Te Road, Peitou, Taipei, Taiwan 11259
 Telephone +886-2-2894-3447
 Fax +886-2-2890-7798
 E-mail info@asus.com.tw
 Web site www.asus.com.tw

Technical Support

Telephone +86-21-38429911
 Online support support.asus.com

ASUS COMPUTER INTERNATIONAL (America)

Address 800 Corporate Way, Fremont, CA 94539, USA
 Telephone +1-510-739-3777
 Fax +1-510-608-4555
 Web site usa.asus.com

Technical Support

Telephone +1-812-282-2787
 Support fax +1-812-284-0883
 Online support support.asus.com

ASUS COMPUTER GmbH (Germany and Austria)

Address Harkort Str. 21-23, D-40880 Ratingen, Germany
 Fax +49-2102-959911
 Web site www.asus.de
 Online contact www.asus.de/sales

Technical Support

Component Telephone +49-1805-010923
 System/Notebook/Eee/ +49-1805-010920
 LCD Telephone
 Support Fax +49-2102-9599-11
 Online support support.asus.com

Free Manuals Download Website

<http://myh66.com>

<http://usermanuals.us>

<http://www.somanuals.com>

<http://www.4manuals.cc>

<http://www.manual-lib.com>

<http://www.404manual.com>

<http://www.luxmanual.com>

<http://aubethermostatmanual.com>

Golf course search by state

<http://golfingnear.com>

Email search by domain

<http://emailbydomain.com>

Auto manuals search

<http://auto.somanuals.com>

TV manuals search

<http://tv.somanuals.com>