



CRW-5232AS-U
External CD-RW
52x/32x/52x CD-RW Drive

User Guide



E1532

First Edition V1

February 2004

Copyright © 2004 ASUSTeK COMPUTER INC. All Rights Reserved.

No part of this manual, including the products and software described in it, may be reproduced, transmitted, transcribed, stored in a retrieval system, or translated into any language in any form or by any means, except documentation kept by the purchaser for backup purposes, without the express written permission of ASUSTeK COMPUTER INC. ("ASUS").

Product warranty or service will not be extended if: (1) the product is repaired, modified or altered, unless such repair, modification or alteration is authorized in writing by ASUS; or (2) the serial number of the product is defaced or missing.

ASUS PROVIDES THIS MANUAL "AS IS" WITHOUT WARRANTY OF ANY KIND, EITHER EXPRESS OR IMPLIED, INCLUDING BUT NOT LIMITED TO THE IMPLIED WARRANTIES OR CONDITIONS OF MERCHANTABILITY OR FITNESS FOR A PARTICULAR PURPOSE. IN NO EVENT SHALL ASUS, ITS DIRECTORS, OFFICERS, EMPLOYEES OR AGENTS BE LIABLE FOR ANY INDIRECT, SPECIAL, INCIDENTAL, OR CONSEQUENTIAL DAMAGES (INCLUDING DAMAGES FOR LOSS OF PROFITS, LOSS OF BUSINESS, LOSS OF USE OR DATA, INTERRUPTION OF BUSINESS AND THE LIKE), EVEN IF ASUS HAS BEEN ADVISED OF THE POSSIBILITY OF SUCH DAMAGES ARISING FROM ANY DEFECT OR ERROR IN THIS MANUAL OR PRODUCT.

SPECIFICATIONS AND INFORMATION CONTAINED IN THIS MANUAL ARE FURNISHED FOR INFORMATIONAL USE ONLY, AND ARE SUBJECT TO CHANGE AT ANY TIME WITHOUT NOTICE, AND SHOULD NOT BE CONSTRUED AS A COMMITMENT BY ASUS. ASUS ASSUMES NO RESPONSIBILITY OR LIABILITY FOR ANY ERRORS OR INACCURACIES THAT MAY APPEAR IN THIS MANUAL, INCLUDING THE PRODUCTS AND SOFTWARE DESCRIBED IN IT.

Products and corporate names appearing in this manual may or may not be registered trademarks or copyrights of their respective companies, and are used only for identification or explanation and to the owners' benefit, without intent to infringe.

Contents

Notices	4
ASUS contact information	5
Safety information	6
Conventions used in this guide	7
Package contents	8
Welcome!	9
Product introduction	9
Specifications	9
Features	10
Front panel	14
Rear panel	15
Installation	16
System requirements	16
Drive placement	16
Connecting the drive cables	17
Installing the device driver	18
Checking the drive in the System Properties	20
Unplugging the device properly	21
CD-RW drive basics	22
Placing a disc into the drive	22
Ejecting a disc from the drive	23
Using the emergency eject pinhole	24
Using compact discs	25
Cleaning a disc	25
Handling a disc	25
Technical information	26
Environmental specifications	26
Electrical and audio specifications	26

Notices

Federal Communications Commission Statement

This device complies with Part 15 of the FCC Rules. Operation is subject to the following two conditions:

- This device may not cause harmful interference, and
- This device must accept any interference received including interference that may cause undesired operation.

This equipment has been tested and found to comply with the limits for a Class B digital device, pursuant to Part 15 of the FCC Rules. These limits are designed to provide reasonable protection against harmful interference in a residential installation. This equipment generates, uses and can radiate radio frequency energy and, if not installed and used in accordance with manufacturer's instructions, may cause harmful interference to radio communications. However, there is no guarantee that interference will not occur in a particular installation. If this equipment does cause harmful interference to radio or television reception, which can be determined by turning the equipment off and on, the user is encouraged to try to correct the interference by one or more of the following measures:

- Reorient or relocate the receiving antenna.
- Increase the separation between the equipment and receiver
- Connect the equipment to an outlet on a circuit different from that to which the receiver is connected.
- Consult the dealer or an experienced radio/TV technician for help.



WARNING! The use of shielded cables for connection of the monitor to the graphics card is required to assure compliance with FCC regulations. Changes or modifications to this unit not expressly approved by the party responsible for compliance could void the user's authority to operate this equipment.

Canadian Department of Communications Statement

This digital apparatus does not exceed the Class B limits for radio noise emissions from digital apparatus set out in the Radio Interference Regulations of the Canadian Department of Communications.

This class B digital apparatus complies with Canadian ICES-003.

ASUS contact information

ASUSTeK COMPUTER INC. (Asia-Pacific)

Address 150 Li-Te Road, Peitou, Taipei, Taiwan 112
Telephone +886-2-2894-3447
Web site www.asus.com.tw

Technical Support

Telephone (MB/Component) +886-2-2890-7121 (English)
(Notebook) +886-2-2890-7122 (English)
(Server/PC) +886-2-2890-7123 (English)
(Networking) +886-2-2890-7902 (English)
Support fax +886-2-2890-7698

ASUS COMPUTER INTERNATIONAL (America)

Address 44370 Nobel Drive, Fremont, CA 94538, USA
Fax +1-510-608-4555
E-mail tmd1@asus.com
Web site usa.asus.com

Technical Support

Telephone (General) +1-502-995-0883
(Notebook) +1-510-739-3777
Support fax +1-502-933-8713
Support e-mail tsd@asus.com

ASUS COMPUTER GmbH (Germany and Austria)

Address Harkort Str. 25, D-40880 Ratingen, Germany
Telephone +49-2102-95990
Fax +49-2102-959911
Online contact www.asuscom.de/sales

Technical Support

Telephone +49-2102-95990
Fax +49-2102-959911
Online support www.asuscom.de/support
Web site www.asuscom.de/news

ASUS COMPUTER (Middle East and North Africa)

Address P.O. Box 64133, Dubai, U.A.E.
Telephone +9714-283-1774
Fax +9714-283-1775
Web site www.ASUSarabia.com

Safety information

Observe the following precautions before installing and using the drive!

Installation Notices

Do not place this device in an unstable position, or in one that vibrates.

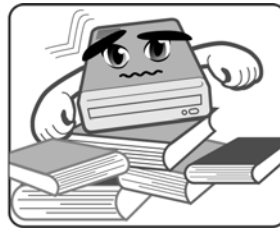

Do not place this device in areas where there is direct sunlight, high humidity, or damp condition.

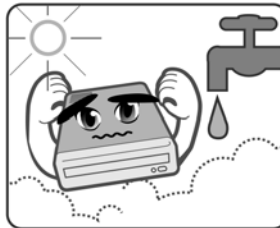

Do not use or place this device near magnetic fields, televisions, or radios, where there is interference that may affect the performance of the drive.

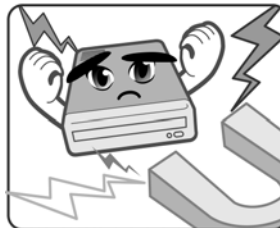

Do not attempt to disassemble or repair the drive. Opening the drive may result to exposure to laser radiation.

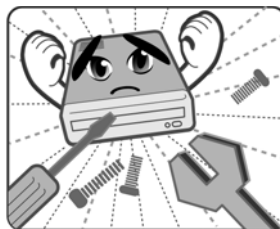

Using the device

- Use of any controls, adjustments, or procedures other than those specified in this manual may result to hazardous radiation exposure.
- Do not attempt to disassemble the drive.
- Do not move the device from a cold to a warm or hot environment. Drastic change of temperature is harmful to the device.
- Before moving or uninstalling the drive, remove disc from it, if any.
- Prevent liquids or any metal to get into the device. If this situation occurs, contact your retailer for help.
- Do not use any evaporating solvents to clean the device. If you accidentally sprayed any solvent on the device, use a clean cloth to wipe it. You may also use a neutral cleaner to dilute the solvent to easily wipe it from the device.
- Try not to interrupt the supply of power while the device is in reading or writing mode.
- Do not place damaged or warped discs inside the device. A warped disc may break while in use and damage the device.
- Do not place discs into the device immediately if they came from a cold environment, specially during cold seasons. Wait until the discs have reached room temperature.

Conventions used in this guide

To make sure that you perform certain tasks properly, take note of the following symbols used throughout this manual.



WARNING/DANGER: Information to prevent injury to yourself when trying to complete a task.



CAUTION: Information to prevent damage to the components when trying to complete a task.



IMPORTANT: Information that you **MUST** follow to complete a task.



NOTE: Tips and additional information to aid in completing a task.

Package contents

Upon opening your ASUS CRW-5232AS-U external CD-RW package, check if all the following items are present and in good condition. If any of the items is damaged or missing, contact your retailer immediately.

- ASUS CRW-5232AS-U external CD-RW drive
- ASUS external CD-RW drive stand
- USB 2.0 cable
- Power cable and adapter
- Emergency eject pin and instruction
- User guide
- Multi-language quick installation poster
- Software CD (includes Windows® 98SE USB 2.0 driver)



The above items are available in retail boxes only.

Welcome!

Thank you for buying the ASUS CRW-5232AS-U external drive!

To ensure proper installation and use of this device, read the instructions and other important information contained in this manual.

Product introduction

Specifications

Speeds	
CD-R Write Speed	52x, 48x, 40x, 32x, 24x, 16x, 8x, 4x
CD-RW Write Speed	32x, 24x, 16x, 12x, 10x, 8x, 4x
Read Speed	52x max (CAV)~7800 KB/Sec
DAE Speed	52x max (CAV)~7800 KB/Sec
Random Access Time	100 ms
Interface	USB 2.0
Technology support	<i>FlextraSpeed™</i> Technology <i>FlextraLink™</i> Technology Double Dynamic Suspension System II (DDSS II) CAV Recording Technology
Buffer memory size	2 MB
Application discs	12cm or 8cm diameter, 1.2mm thick CD-Audio, CD-ROM, CD-ROM/XA, CD-I, Photo CD, CD-Extra, Video CD, CD-Text, Karaoke CD, I-trax
Writing mode	Track-at-Once, Disc-at-Once, Session-at-Once, Packet Write
Dimensions	155.6 (w) x 226 (d) x 50 (h) mm
Mass	1398 g (3.08 lbs)



Refer to the section "Technical information" on page 26 for detailed specifications.

Features

The ASUS CRW-5232AS-U is an external CD-RW drive with 52x Write, 32x ReWrite, and 52x Read capabilities. The drive complies with the Universal Serial Bus 2.0 (USB 2.0) specifications and comes equipped with the latest innovative technologies in CD recording.

ASUS External CD-RW drives are accentuated by the latest innovations in CD-recording technology, namely: *FlextraSpeed™*, *FlextraLink™*, DDSS II (Double Dynamic Suspension System II) and the Constant Angular Velocity (CAV) recording method.

The following sub-sections describe these technologies in detail.

***FlextraSpeed™* technology**

The ASUS *FlextraSpeed™* technology provides the optimum solution to ensure quality recording when using discs that require flexible speeds. The drive employs this technology that allows automatic recording speed adjustment based on the recording media.

In addition to the fact that there are low and high quality recording media, various other factors such as dye layer, temperature, humidity, dust, fingerprints, etc., affect the recording characteristics of CD-R and CD-RW discs. Due to these factors, some discs may not be able to stand the high-speed capabilities of the latest CD-RW drives. The *FlextraSpeed™* technology solves this problem by automatic assessment of the disc quality and recording capability. The recording speed is based on these factors. If you use a high quality recording disc, you can maximize the recording capability of the drive and get the best quality output. If you use a low quality disc, the drive speed adjusts to the level that is most appropriate for the disc, still optimizing the disc recording capability.

The *FlextraSpeed™* technology also helps maintain the CD-RW drive because of the controlled motor rotation speeds and reduced noise caused by spindle air, thus prolonging the drive motor's life and ensuring high-quality recording.

FlextraLink™ technology

The ASUS *FlextraLink™* technology provides a seamless combination of flexibility and ultra-reliable recording quality.

FlextraLink™ incorporates a flexible strategy that prevents buffer underrun problems caused by an empty data buffer. This CD-RW drive technology allows continuous monitoring of the data buffer status during the write process. Once the available data drops to approximately 1% of the total buffer capacity, the drive stops recording and marks the last write position. When new data is received from the host, it is loaded to the data buffer, and the laser is repositioned to link the new data with the data already written. *FlextraLink™* uses minimal system resources so that your PC remains fully operational throughout the writing process, and available for other applications.

The diagram below shows the advantage of the *FlextraLink™* recording technology.

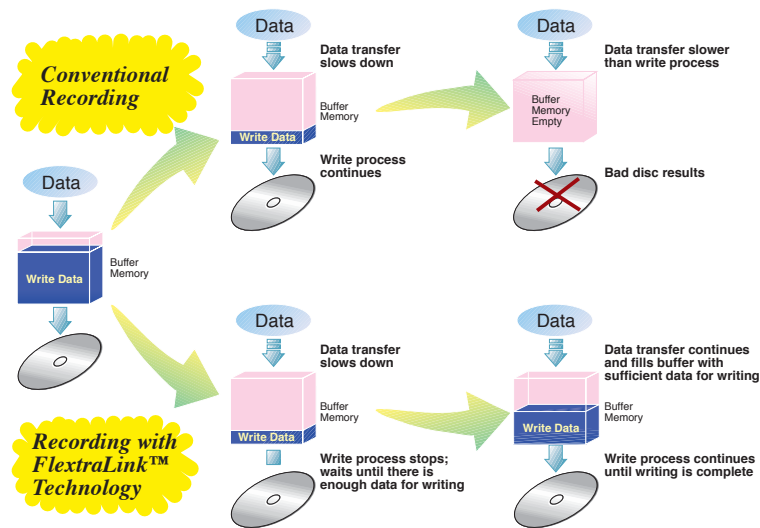

FlextraLink™ Technology Solution



Double Dynamic Suspension System (DDSS II)

The DDSS II is an enhanced follow-up to the DDSS anti-vibration system developed by ASUS. The DDSS CD-ROM technology is designed to reduce the vibration generated from spindle rotation of over 8900 rpm of 40X CD-ROM drives. The DDSS II improves this feature by handling up to over 10,000 rpm of the new 50X drives. In addition, the DDSS II stabilizes the pick-up head of the drive in both horizontal and vertical directions, making tracking and focusing even more precise.

Like the DDSS, the DDSS II vibration absorption structure contains a "dynamic mass" that can absorb the vibration caused by high revolution of spindle motor. However, the DDSS II moves the dynamic mass to be suspended to the chassis, thus providing more stability and accuracy when accessing data from the disc.

The following diagram illustrates the DDSS/DDSS II design structure.

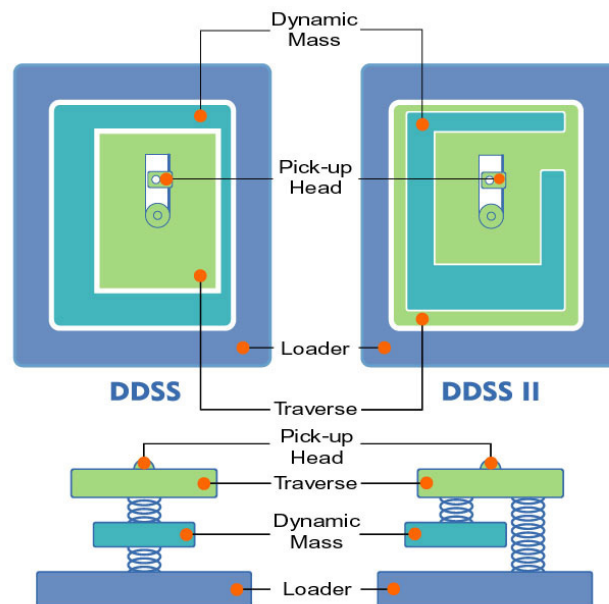

DDSS / DDSS II Design Structure

Constant Angular Velocity (CAV) recording

The drive employs the Constant Angular Velocity (CAV) recording method. With CAV recording, the drive spindle motor rotates the disc at the same speed regardless of the radial position of the pickup head. This means that there is a higher transfer rate when writing data to the outer tracks of the disc than to the inner tracks, as the head traverses a longer linear path on the outer than the inner part of the disc.

Although the transfer rates vary, and may not be at maximum, depending on the part of the disc being written to, the CAV method allows faster recording speed because the rotation speed does not have to change when the head writes data to different areas of the disc.

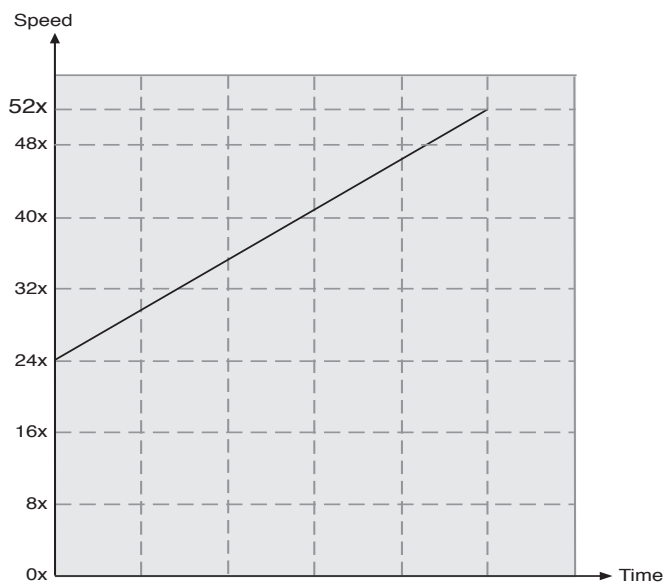

CAV Recording Method

Front panel

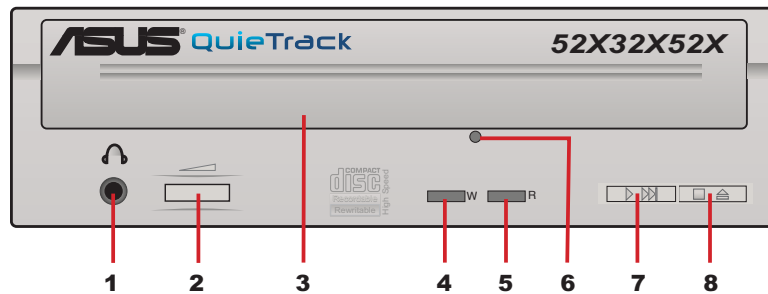

- 1. Headphone jack**

This jack allows you to connect a headphone with a stereo mini-plug. If you enable the *digital CD audio properties* for this device, the audio out function of this jack is disabled.
- 2. Headphone volume dial**

To adjust volume of headphone connected, turn dial to the left to decrease volume; turn to the right to increase volume.
- 3. Disc tray**

This tray holds the disc.
- 4. WRITE indicator (red LED)**

This LED flashes while data is being written on the disc.
- 5. READ indicator (green LED)**

This LED is ON when a disc is present in the drive tray. The LED flashes while data is being read from the disc.
- 6. Emergency eject pinhole**

To manually eject the tray and the disc. See page 24 for details on using the emergency eject pinhole.
- 7. PLAY/SKIP button**

This button has two functions. If the drive is idle, pressing this button will start playing a loaded audio disc from the first track. While in the PLAY mode, pressing this button skips to the next track on the disc.
- 8. STOP/EJECT button**

This button has two functions. Pressing this button at any time ejects the disc tray. While in PLAY mode, pressing this button stops playing the disc loaded in the drive.

Rear panel

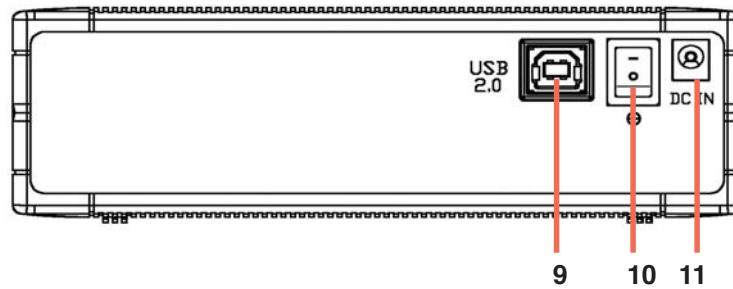

9. USB connector

A standard Universal Serial Bus (USB 2.0) plug and play interface.

10. Power switch

Turns the power supply ON or OFF. Switching to “I” icon means ON and switching to “O” side means OFF.

11. Power jack

This jack is for the AC adaptor power cable.

Installation

System requirements

Before installing and using the drive, make sure that your computer system meets the following requirements.

- IBM-compatible Pentium® II - 333 MHz or higher PC
- Windows® 98SE/ME/2000/XP operating system
- At least 64MB RAM (128MB recommended)



Do not use damaged or warped disc in the drive. The disc may break apart during use and cause potential body injury or damage to your drive.

Drive placement

1. Remove the external CD-RW drive and all the package contents from the box. Place them next to your computer.
2. Place the external drive stand on a stable surface.

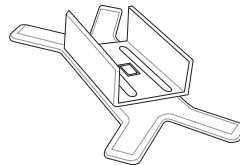

3. Slide the drive into the stand, aligning the side groove to the rectangular slot on the stand.

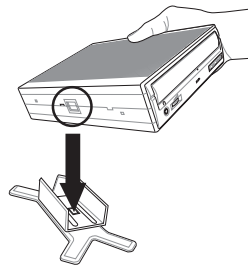

4. Make sure that the drive is securely in place.

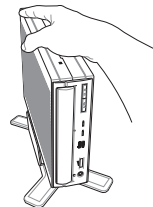

Connecting the drive cables

1. Connect the USB cord B series plug to the USB 2.0 connector on the drive.
2. Connect the USB cord A series plug to the USB 2.0 connector on your PC.
3. Connect the adapter cable to DC IN power connector.
4. Connect the adapter power cord to the AC adapter.
5. Connect the adapter power cord to a power source.



All the cable plugs are slotted so that they fit in only one orientation. If a plug does not fit in completely, try reversing it. DO NOT use too much force when fitting the cable plugs!

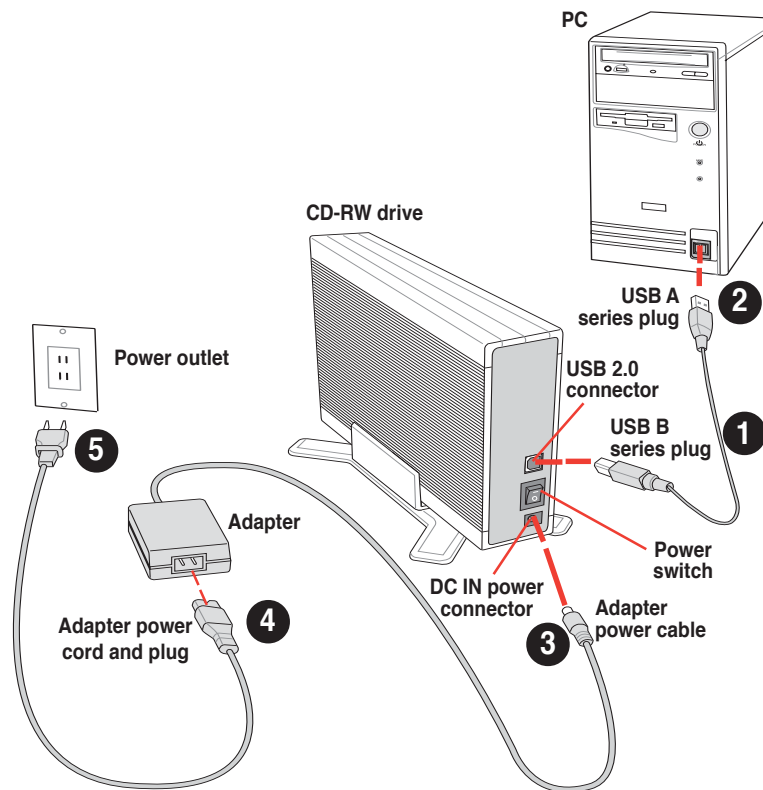

Power plug types may vary in different countries or regions around the world.

Installing the device driver

(for Windows® 98/98SE/ME users)

Windows® 98/98SE/ME users need to install the device driver for the PC to recognize the new hardware installed. A device driver is the program that makes a device work within the operating system (OS).

Follow these steps to install the driver:

1. Make sure all cable connections to the drive and the PC are properly connected.
2. Boot PC.
3. Insert the bundled software CD in the drive.
4. Turn on the drive.
5. After booting, the OS detects the new hardware. Follow the wizard to copy the driver files to your system. Click **Next**.



6. Windows® 98/98SE/ME automatically searches the best driver for the device. Select the (Recommended) option. Click **Next**.

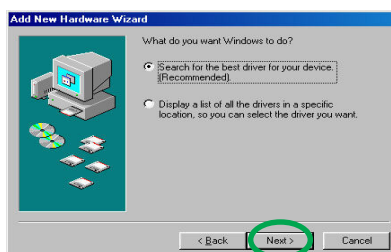

7. Specify the location of the driver .INF file then click **Browse**.

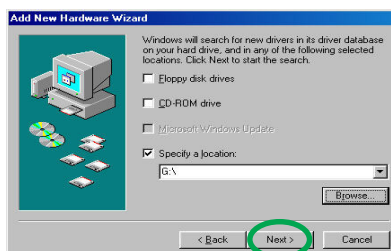

8. Locate the folder
“USB_RW_DRIVER” in the CD.
Click **OK**.

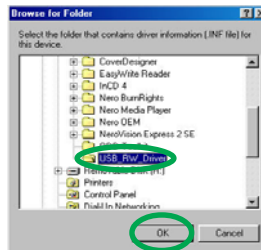

9. The specific location of the drive
appears on the combo list box.
Click **Next**.

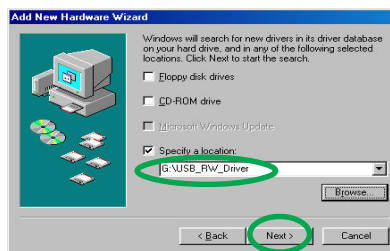

10. After searching, the location of
the driver appears.
Click **Next**.

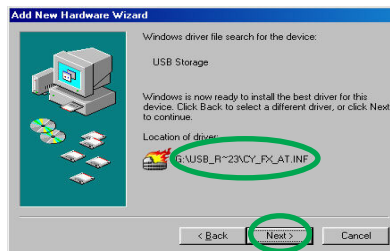

11. Click **Finish** to start using your
external drive!



Checking the drive in the System Properties

To make sure that the drive is recognized by the computer, follow these steps to check the system properties.

1. Right-click **My Computer** icon on your desktop.
2. On the pop-up menu, click **Properties**.
3. Click the **Device Manager** tab on the system properties dialog box.
4. Click on CD-ROM from the list to display the device that you installed.

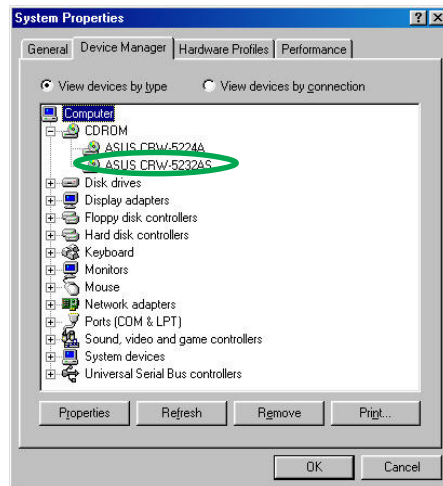

Screen display may vary depending on the operating system (OS) version.

Unplugging the device properly

Make sure that you properly unplug or disconnect the device from the computer to avoid computer crash or possible data loss.

Follow these steps to safely unplug the drive.

1. Locate the **Unplug or Eject Hardware** icon found in the taskbar.
Double-click on the icon.



2. Select the name of the hardware device to unplug.
Click **Stop**.



3. Select the device to be stopped when prompted.
Click **OK**.



4. You may now safely unplug the device from the system.
Click **OK**.



5. The screen display goes back to the **Unplug or Eject Hardware** dialog box. Click on **Close**.

CD-RW drive basics

Placing a disc into the drive

1. Press the eject button on the front of the drive to eject the tray.

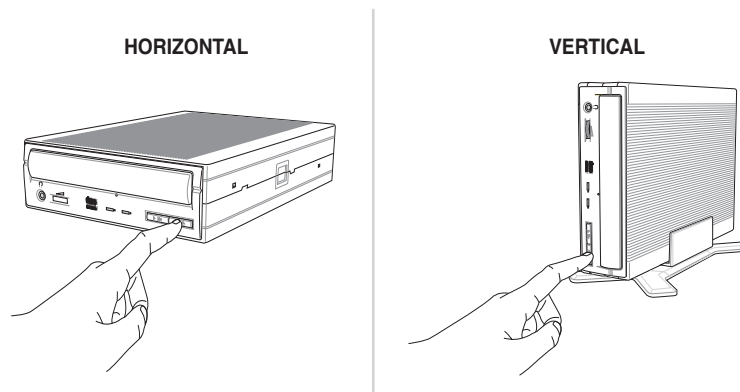

2. When the drive tray ejects out of the drive, place the disc on the tray with the label side facing up.

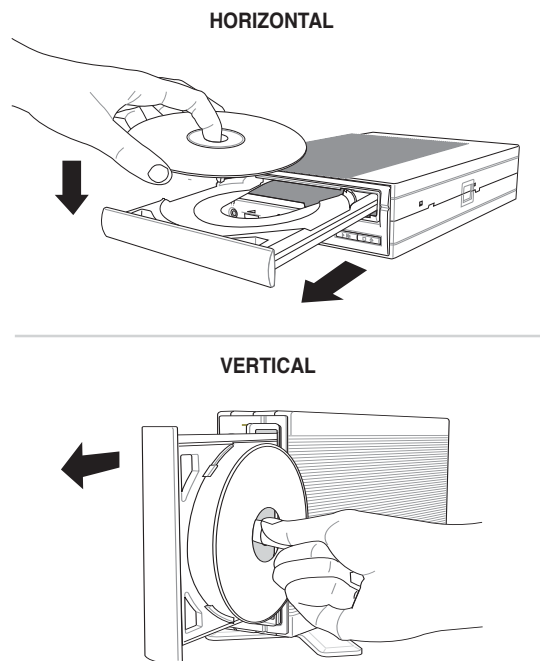



If you are using a 12-cm disc, place it on the tray making sure that it fits the outer circular border. This border helps hold the disc in place. If you are using an 8-cm disc, place it on the inner circular border on the tray. However, you may use 8-cm discs only when your drive is in a horizontal position.

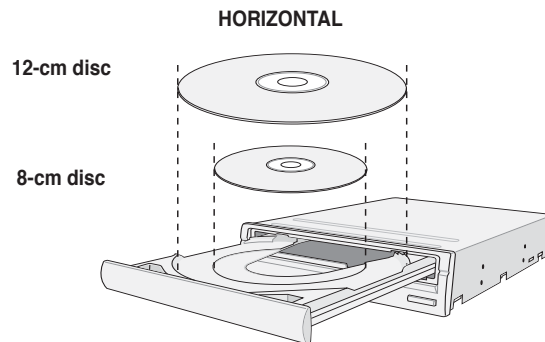

3. Press the drive eject button or lightly push the center of the drive tray to load the tray back into the drive.

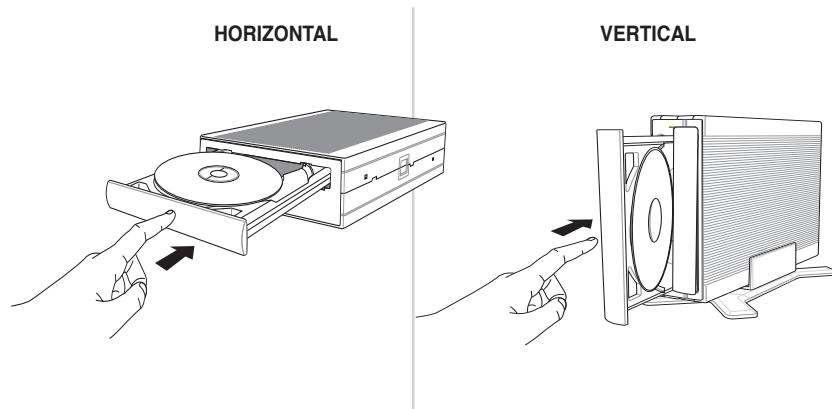

Ejecting a disc from the drive

1. Press the eject button on the front of the drive to eject the tray.
2. Carefully remove the disc from the tray.
3. Press the drive eject button or lightly push the center of the drive tray to load the tray back into the drive.

Using the emergency eject pinhole

The emergency eject pinhole on the front of the drive allows you to manually eject the drive tray and remove a disc from the drive in the following instances:

- supply of power to the computer is cut due to electrical power outage
- the drive malfunctions



Use the manual method only as a last resort when the eject button does not work. Make sure that you have turned off your CD-RW drive before ejecting the drive tray. Locate the power switch button on the rear panel to turn off the drive.

Follow these steps to eject the drive tray using the emergency pinhole.

1. Insert the eject pin that came with the drive package. You may also use a paper clip or any pointed rod small enough to fit into the emergency pinhole.

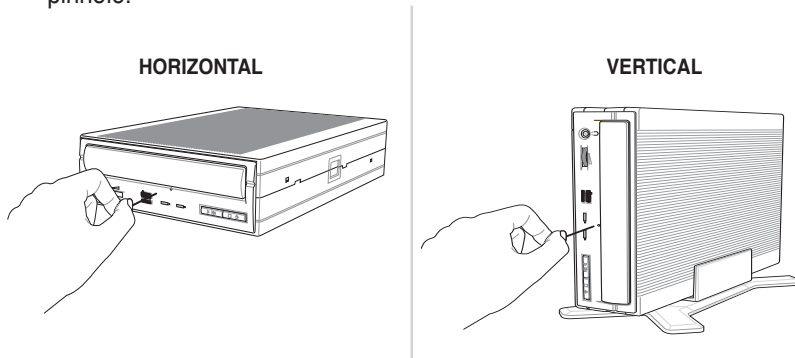

2. Carefully pull the tray out and remove the disc.

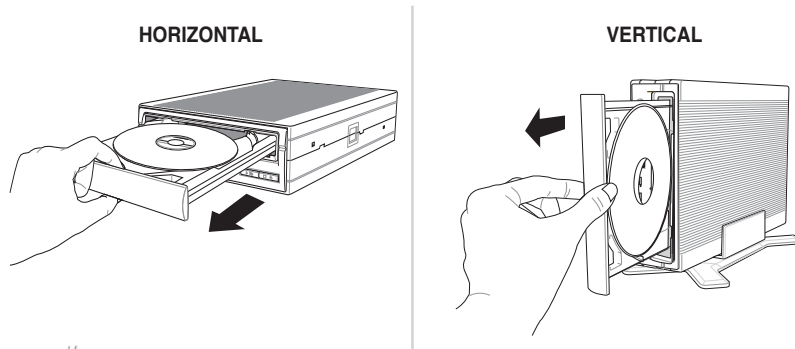

Do not force the tray open; wait until the eject pin has dislodged the tray to avoid breaking the tray panel.

Using compact discs

Take note of the instructions in this section when using compact discs. These instructions will help you avoid damaging discs and your CD-RW drive.

Cleaning a disc

Spray the disc with compressed air for about five seconds to get rid of the dust on a disc.

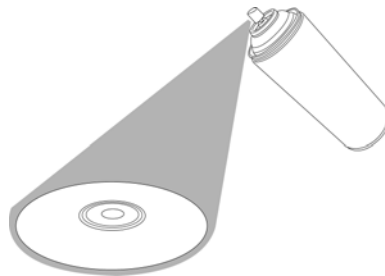

Handling a disc

Hold a disc by the edges. Do not touch the disc surface.

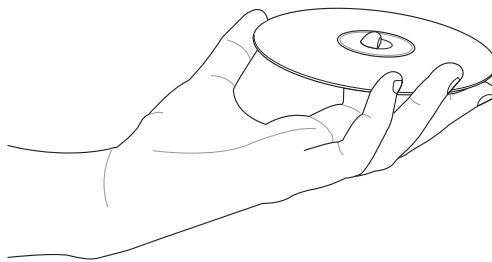

Technical information

Environmental specifications

Temperature	Operation	0°C < to < 45°C
	Storage	- 20°C to < 60°C
Humidity	Operation	20% to 80% non-condensing
	Storage	15% to 85% non-condensing
Vibration	Operation	0.3G peak at 5 ~ 500 Hz
	Storage	2.0G peak at 10 ~ 500 Hz
Impact	Non-operation	1 oct/min – no damage Less than 50G – (at 11ms/half sine wave, 3 shock/each side)
	Packaged	1 oct/min – no damage 91 cm high – (1 corner, 3 edges, 6 surfaces)
Acoustic	Access mode	47.5 dB TYP
	Read mode	45 dB TYP
Reliability	MTBF	100,000 power on hours
	ODC (Read)	20% of power on time
	ODC (Write)	1% of power on time
Mean Time To Repair (MTTR)		30 minutes

*ODC - Operating Duty Cycle

Electrical and Audio specifications

Power source	Input Linear Voltage	100/240 V AC
	Input Linear Frequency	50/60 Hz
	Input Linear Current	1.2 A
I/O terminal	USB terminal	USB B type (High Speed)
Audio	No. of channels	2 (stereo)
	Sampling frequency	44.1 kHz
	Quantization	16 bits
	Distortion	0.2% max. (at 1 kHz)
	S/N ratio	70 dB
	Output: Headphone	0.7 V rms (typical)



ASUS[®]

CRW-5232AS-U

52x/32x/52x CD-RW 外接式燒錄機

使用手冊





給使用者的說明

本產品的所有部分，包括配件與軟體等，其所有權歸華碩電腦公司（以下簡稱華碩）所有，未經華碩公司許可，不得任意地仿製、拷貝、謄抄或轉譯。本使用手冊沒有任何型式的擔保、立場表達或其它暗示。若有任何因本使用手冊或其所提到之產品的所有資訊，所引起直接或間接的資料流失、利益損失或事業終止，華碩及其所屬員工恕不為其擔負任何責任。除此之外，本使用手冊所提到的產品規格及資訊僅供參考，內容亦會隨時更新，恕不另行通知。本使用手冊的所有部分，包括硬體及軟體，若有任何錯誤，華碩沒有義務為其擔負任何責任。

本使用手冊中談論到的產品及公司名稱僅做識別之用，這些名稱可能是屬於其他公司的註冊商標或是版權。

本產品驅動程式改變，使用手冊都會隨之更新。更新的詳細說明請您到華碩的網站瀏覽或是直接與華碩公司聯絡。

版權所有・不得翻印 ©2004華碩電腦

產品名稱：CRW-5232AS-U 燒錄機

手冊版本：1.00 T1532

發表日期：2004 年 2 月



華碩的聯絡資訊

華碩電腦公司 ASUSTeK COMPUTER INC. (亞太地區)

市場訊息

地址 : 台灣臺北市北投區立德路150號
電話 : 886-2-2894-3447

技術支援

免費服務電話 : 0800-093-456
傳真 : 886-2-2890-7698
全球資訊網 : <http://taiwan.asus.com.tw/>

ASUS COMPUTER INTERNATIONAL (美國)

市場訊息

地址 : 44370 Nobel Drive, Fremont, CA 94538, USA
電話 : +1-502-995-0883
傳真 : +1-502-933-8713
電子郵件 : tmdl@asus.com

技術支援

電話 : +1-502-995-0883
傳真 : +1-502-933-8713
電子郵件 : tsd@asus.com
全球資訊網 : <http://www.asus.com>

ASUS COMPUTER GmbH (歐洲/奧地利)

市場訊息

地址 : Harkort Str. 25, D-40880 Ratingen, Germany
電話 : +49-2102-9599-0
傳真 : +49-2102-9599-11
線上連絡 : <http://www.asuscom.de/sales>
電子郵件 Email : sales@asuscom.de (僅回答市場相關事務的問題)

技術支援

電話 : 49-2102-9599-0 ... 主機板/其它產品
: 49-2102-9599-10 ... 筆記型電腦
傳真 : 49-2102-9599-11
線上支援 : <http://www.asuscom.de/support> (提供線上支援)
全球資訊網 : <http://www.asuscom.de>

ASUSTek Middle East & North Africa (中東 & 北非)

地址 : P.O. Box 64133 , Dubai, U.A.E.
電話 : +9714-2831774
傳真 : +9714-2831775
全球資訊網 : www.asusarabia.com



歡迎使用華碩產品

感謝您購買華碩 CRW-5232AS-U 燒錄機！

為了確保燒錄機正確的安裝與使用方式，請先閱讀本手冊的操作指南以及其他重要資訊。

內容

給使用者的說明	2
華碩的聯絡資訊	3
歡迎使用華碩產品	4
關於本使用手冊	5
安全資訊	6
燒錄機安裝注意事項	6
使用燒錄機	7
產品包裝盒	8
產品資訊	9
燒錄機規格	9
特殊功能	10
正面外觀	14
背面外觀	15
安裝	16
系統要求	16
連接裝置排線	17
安裝燒錄機驅動程式 (Windows 98SE)	18
移除 CRW-5232AS-U 燒錄機	21
燒錄機的基本操作	22
放入光碟片	22
退出光碟片	23
緊急退片孔	24
光碟片使用	25
清潔光碟片	25
拿取光碟片	25
技術資訊	26
使用環境規格	26
電氣規格	26



關於本使用手冊

提示符號說明

以下為本手冊所使用到的各式符號說明：



警告/危險：因不當的動作可能會對人體產生傷害或危險。



小心：因不當的動作可能會對產品及零件造成損害。



注意：重點提示，重要的注意事項。



說明：小祕訣，名詞解釋，或是進一步的資訊說明。

哪裡可以找到更多的產品資訊

您可以經由下面所提供的兩個管道來獲得您所使用的華碩產品資訊以及軟硬體的最新資訊等。

1. 華碩網站

您可以到 <http://taiwan.asus.com.tw> 華碩電腦全球資訊網站取得所有關於華碩軟硬體產品的各項資訊。

2. 其他文件

在您的產品包裝盒中除了本手冊所列舉的標準配件之外，也有可能夾帶其他的文件，譬如經銷商所附的產品保證單據等。

代理商查詢

本產品在台灣透過聯強國際與精技電腦兩家代理商出貨，請您參考下列範例圖示找出產品的 10 碼式序號標籤（下圖僅供參考），再至 http://taiwan.asus.com.tw/support/eService/querydist_tw.aspx 查詢您產品的代理商，以方便您有產品諮詢或送修需求時，可尋求代理商服務。（本項服務僅支援台灣使用者）



聯強服務電話：02-25062558

精技服務電話：0800089558



安全資訊

在您安裝和使用華碩 CRW-5232AS-U 燒錄機之前，請先瀏覽並且了解下列圖示的預防措施！

燒錄機安裝注意事項

不要將燒錄機置放在任何容易搖晃或容易產生震動的地方。



不要將燒錄機置放在陽光直接照射到的地方、溼度高的地方或者任何潮溼的地方。



不要將燒錄機置放在磁性物品附近，像電視、收音機等會散發電波干擾的電子產品皆會影響燒錄機的運作效能。



不要擅自拆解或者企圖自行維修燒錄機。打開機殼有可能導致幅射外洩而發生危險。





使用燒錄機

- 請勿將燒錄機從寒冷的環境搬移到溫暖或燥熱的環境。劇烈的溫度改變會損及燒錄機的精密零件。
- 若要搬移燒錄機或者從電腦主機中移出燒錄機，請先確認燒錄機內的光碟片已經先行取出。
- 請避免讓任何液體浸沾到燒錄機或者讓小型金屬物品掉落到燒錄機中。如果有這種情況發生，請聯絡您的經銷商尋求解決之道。
- 不要使用任何易揮發性的溶劑來清潔燒錄機。如果在使用溶劑時不小心噴灑到燒錄機，請使用乾淨的布將燒錄機擦拭乾淨。此外，您也可以先將沾到溶劑的燒錄機時加一點中性清潔劑，藉此來稀釋溶劑的濃度以便能夠更容易地得到清除效果。
- 請勿在燒錄機進行讀取或寫入動作的時候中斷電源。
- 請勿將已損毀或有裂痕的光碟片放入燒錄機內讀寫，劣質的碟片不但會損傷燒錄機，也可能造成您身體的傷害。
- 由於燒錄機讀取光碟片時有一定的工作溫度範圍，因此不要馬上將從寒冷環境中取得的光碟片放入燒錄機中，特別是在冬天。此時請先等待光碟片溫度回復到室溫時再使用。



產品包裝盒

在打開您的華碩 CRW-5232AS-U 燒錄機包裝盒之後，請即刻檢查您的包裝盒中的各項物品是否與下表的清單符合，並且檢查物品外觀上是否有損壞。若有物品遺漏或損壞的情形，請馬上聯絡您的經銷商。

- 華碩 CRW-5232AS-U 外接式燒錄機
- 華碩外接式燒錄機腳座
- USB2.0 裝置連接排線
- 電源線及變壓器
- 緊急退出孔插針與使用說明
- 英文及繁體中文使用手冊
- 多國語言快速安裝指南
- 附贈軟體光碟（內含 Win98SE USB2.0 驅動程式）



注意：以上為零售禮盒包裝內容。



歡迎使用華碩產品

感謝您購買華碩 CRW-5232AS-U 外接式燒錄機！

為了確保燒錄機正確的安裝與使用方式，請先閱讀本手冊的操作指南以及其他重要資訊。

產品資訊

燒錄機規格

華碩 CRW-5232AS-U 燒錄機的規格列舉如下：

- **讀/寫/覆寫速度**

寫入速度	52X, 48X, 40X, 32X, 24X, 16X, 8X, 4X
覆寫速度	32X, 24X, 16X, 12X, 10X, 8X, 4X
讀取速度	最大 52X (CAV)~7800 KB/Sec
DAE 速度最大	最大 52X (CAV)~7800 KB/Sec
平均資料存取時間	100 ms
- **使用介面** USB2.0
- **燒錄技術** *FlextraSpeed™* 智慧型燒錄速度調整技術
FlextraLink™ 廢片終結燒錄技術
DDSSII 第二代雙動態懸吊系統
CAV 等角速寫入技術
- **緩衝記憶體大小** 2 MB
- **適用的光碟片型式** 12 公分或 8公分直徑、1.2 公厘厚度的光碟片
CD-Audio, CD-ROM, CD-ROM/XA, CD-I,
Photo CD, CD-Extra, Video CD, CD-Text,
Karaoke CD, I-trax
- **燒錄規格** Track-at-Once, Disc-at-once,
Session-at-once, Packet Write,
- **燒錄機尺寸** 155.6 (寬) x 226 (長) x 50 (高) mm
- **重量** 1398 g



說明：您可以在第 26 頁「技術資訊」中得到更詳盡的規格說明。



特殊功能

華碩 CRW-5232AS-U 是一款擁有 52 倍速寫入、32 倍速覆寫以及 52 倍速讀取的外接式燒錄機。此款燒錄機相容於 USB2.0 規格，並且在 CD 燒錄的方式上引進了許多革新性的技術。

FlextraSpeed™ 智慧型燒錄速度調整技術

華碩研發團隊網羅近 50 家碟片廠商出廠的可單/多次寫入光碟片，並根據其特質與測試結果為分析參數，評估各種碟片能夠達到最佳燒錄品質的最適燒錄速度。搭載此項技術的燒錄機在實際進行光碟燒錄前，可根據此資料庫的訊息，預先將讀寫頭設置在最適當的雷射功率 (OPC)。

然而在實際燒錄過程中，除了眾多品質參差不齊的光碟片品牌影響燒錄品質之外，縱使光碟片製造廠的品質佳，難保每一個碟片的品質完全相同，溫度、染料、溼度、灰塵、指紋等等的環境因素皆會影響碟片的讀寫特性。內建 *FlextraSpeed™* (Flexible and Strategic Writing Speed Technology) 的燒錄機在燒錄過程中，持續地觀察碟片的寫入狀態，當寫入的碟片因為不能承受高功率雷射與高速燒錄時，即可適時地調整燒錄速度；或是因為碟片上的軌道彎彎曲曲或偏心，使得燒錄器難以追蹤軌跡時，燒錄機會依據碟片的品質自行調整適合該碟片的燒錄速度並繼續燒錄工作。

FlextraSpeed™ 智慧型燒錄速度調整技術可以：

- 使燒錄機效能最大化
- 自動調整至最省時、省事的燒錄
- 佔用最小的系統資源
- 降低使用時噪音
- 延長馬達壽命



FlextraLink™ 廢片終結燒錄技術

FlextraLink™ 廢片終結燒錄技術的名稱乃取自 Flexible and Strategic Writing Technology，用來預防在進行燒錄資料時因資料緩衝區內沒有足夠的資料可供燒錄使用而導致嚴重的 Buffer Underrun 錯誤的產生。此外，它也會在整個燒錄動作中持續地監視資料緩衝區內的狀況。

倘若在燒錄時存放在緩衝區內的資料量已低於整個緩衝區容量的 1% 時，FlextraLink™ 廢片終結燒錄技術會中斷目前的燒錄動作，並且會在中斷的地方設下一個記號。此時新的資料會開始填入緩衝區中，而雷射讀寫頭也將會被重新定位。當緩衝區裡的新資料已儲存到可供再燒錄所需的量時，雷射讀寫頭會移動到被 FlextraLink™ 廢片終結燒錄技術所中斷的資料節區後面，再接續燒錄動作。

這個技術也能夠確保您的電腦能夠在燒錄機燒錄的同時，可以再執行其他的應用程式。

以下的圖示將可說明採用 FlextraLink™ 廢片終結燒錄技術的優點。

FlextraLink™ 廢片終結燒錄技術示意圖

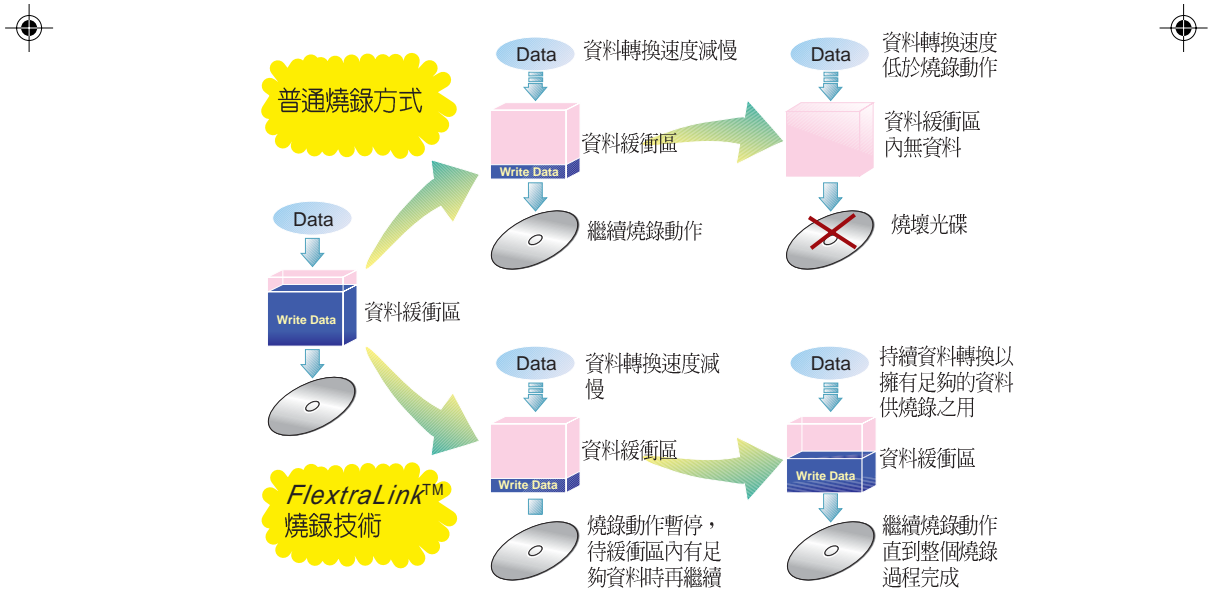



DDSS II 第二代雙動態懸吊系統

DDSS II 技術 (Double Dynamic Suspension System II) 是由華碩研發團隊精心設計出來的一個最先進的光碟機防震機構，針對第一代的 DDSS 技術再加以突破改良而來。第一代的 DDSS 是針對 40 倍速的光碟機超過 8900 rpm 轉速而設計的，它是在讀寫模組及承載機構之間增加一個動態吸振器 (Dynamic Mass)，各層各自獨立，藉著結構力學的設計，將高速旋轉的振動能量由中間的動態吸振器接收，使讀取頭能穩定的讀取資料，而外部的承載機構又能維持相當的平穩。

而 DDSS II 是為了配合 50 倍速以上光碟機超過 10000 rpm 轉速而設計，DDSS II 技術不同於第一代的 DDSS，它的動態吸振器不再介於讀寫模組及承載機構之中，而是將動態吸震機構懸吊在讀寫頭模組上面，以發揮吸收震動的作用。而光碟讀寫頭也因有了承載機構和動態吸震器的雙重支撐，而有了最佳的穩定度。此一設計不只在水平的 Tracking 有減振作用，垂直方向的 Focusing 也同樣的有減振效果，大幅提升了讀取頭循軌的功能。這是以往的設計所無法達到的，因此在 10000rpm 的轉速仍能穩定的讀寫資料。

從以下的圖示中將可清楚看出 DDSS 與 DDSS II 設計架構的不同之處。

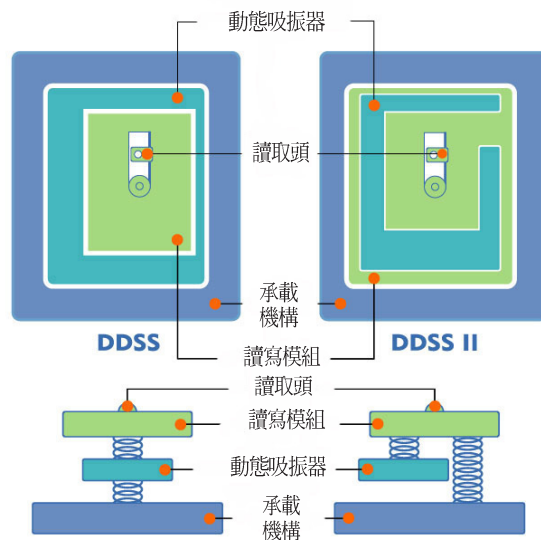



CAV 等角速寫入技術

CAV (Constant Angular Velocity) 等角速寫入技術是指光碟燒錄機的馬達轉速相同，但因光碟片內圈與外圈的資料量不同（內圈的資料量較少，外圈資料量較大），因此，當燒錄工作由內圈進行至外圈時，燒錄的速度將會愈來愈快，如此將可為使用者減少許多燒錄的時間。

以下的圖解範例說明了 CAV 的運作方式。

CAV 燒錄技術

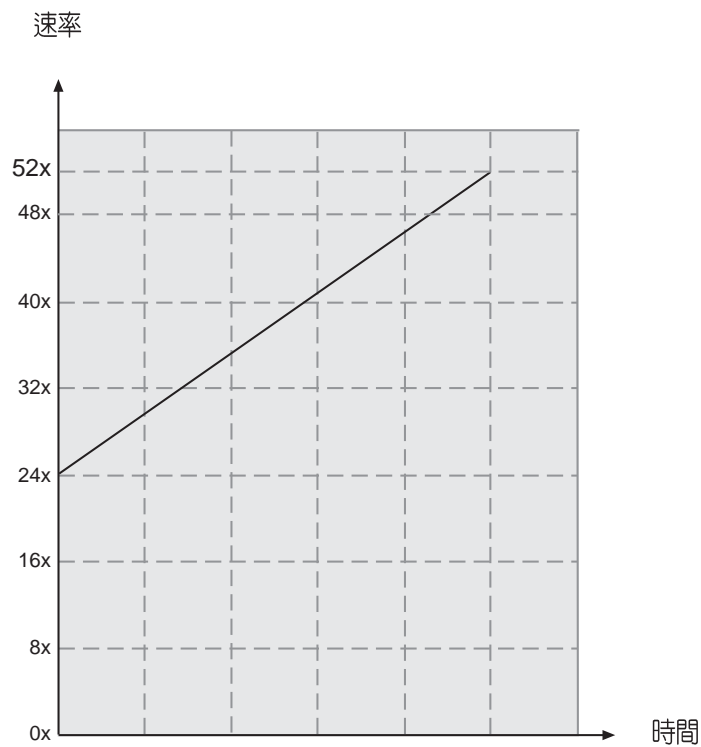



正面外觀

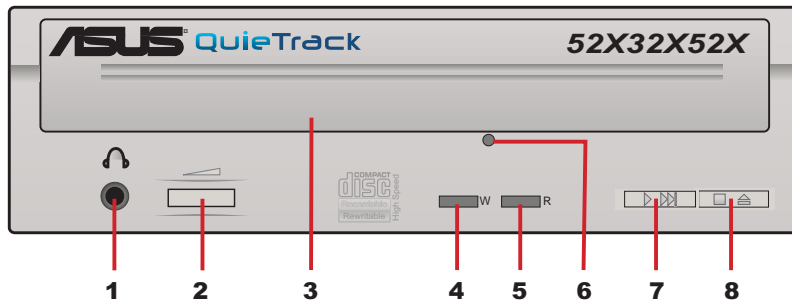

1. 耳機插座
用來連接耳機，以提供您聆聽音樂光碟片時之用。
2. 耳機音量控制旋鈕
向右轉動增加耳機音量；向左轉動減小耳機音量。
3. 光碟片托盤
4. 寫入動作指示燈 (W)
當這個指示燈閃 **紅燈** 時表示目前燒錄機正在將資料寫入至光碟片中。
5. 讀取動作指示燈 (R)
當這個指示燈閃 **綠燈** 時表示正在讀取/連結光碟片中的資料。
6. 緊急退片孔
為避免您無法啟動您的電腦卻又得取出光碟片的情況下，您可以利用約五公分長的針狀物（如迴紋針等），伸入燒錄機面板上的緊急退片孔中並稍加施力迫使燒錄機中的齒輪裝置動作而令托盤退出燒錄機。取出光碟片後再輕輕地將托盤推回燒錄機中。
7. 播放/快轉 按鍵
此一按鍵有兩種功能，當燒錄機閒置時，按下此一按鍵即可開始播放；當燒錄機正在播放時，按下此一按鍵即跳到下一軌播放。
8. 停止/開啓/關閉 按鍵
按下 **開啓/關閉** 按鍵即可退出光碟片托盤。要關閉光碟片托盤只需再按一次 **開啓/關閉** 按鍵或者輕輕地推動托盤的前緣，直到它自動退回燒錄機中為止。使用 **開啓/關閉** 按鍵來置入或退出光碟片是標準的動作，同時也可以避免因直接以手推動托盤使之收回燒錄機所會產生的不良影響，比如導致托盤老化後易脫軌的情形。



背面外觀

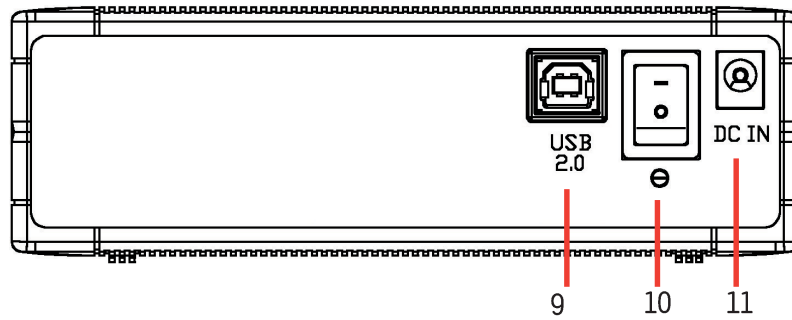

9. USB 2.0 接頭
將包裝中所附的 USB 2.0 連接線的一端接到這個接頭，另一端連接至電腦上的 USB 埠。
10. 電源開關
當您連接好電源線之後，您還必須利用這個開關來開啓或關閉電源。
11. 電源插孔
將電源線插頭接到這個電源插孔。



安裝

系統要求

在您安裝/使用燒錄機之前，請確認您的電腦系統符合下列需求：

- 使用相容於 IBM 個人電腦規格的 Pentium II 333MHz 或更高處理器時脈的個人電腦
- 使用 Windows 98SE/ME/2000/ XP作業系統
- 最少需要 64MB 系統記憶體，我們建議您擴充至 128MB



請勿將已損毀或有裂痕的光碟片放入燒錄機內讀寫，劣質的碟片不但會損傷燒錄機，也可能造成您身體的傷害。



連接裝置排線

1. 將 USB 排線的 B 型 USB 接頭連接到燒錄機的 USB 2.0 連接埠。
2. 將 USB 排線的 A 型 USB 接頭連接到個人電腦的 USB 2.0 連接埠。
3. 將變壓器的電源線接頭連接到燒錄機的電源插孔。
4. 將電源線的一端連接到電源變壓器。
5. 將電源線的插頭連接到電源插座上。



小心：當您連接排線時，請注意所有的排線接頭是否與裝置上相對應的接頭相符，當您發現插頭規格不符而無法插入時，請勿強行插入，以免發生損壞。此時請速洽詢您購買產品時的經銷商。



說明：電源插頭會因各國使用標準不同而有所不同。

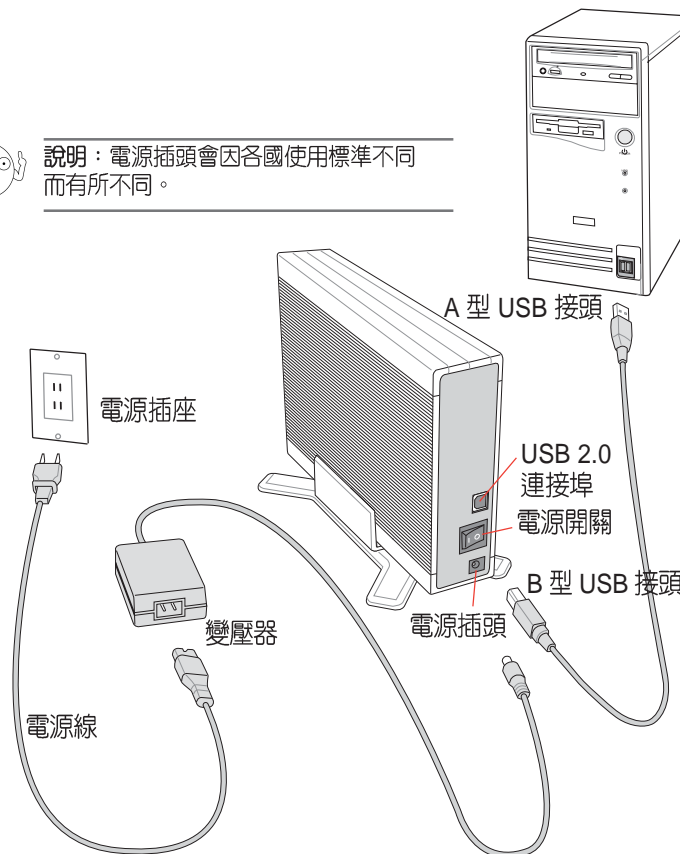



安裝燒錄機驅動程式 (Windows 98SE)

若您使用 Windows 98SE 作業系統，在您使用華碩 CRW-5232AS-U 燒錄機之前，您必須安裝燒錄機的驅動程式。

請依照下面步驟安裝燒錄機驅動程式：

1. 請確定您的燒錄機已安裝妥當，並連接好電源線、USB 連接線。
2. 打開電腦電源。
3. 將附贈軟體光碟置入光碟機中。
4. 打開燒錄機電源。

5. 當您重新啟動電腦之後，系統會偵測到有新的硬體加入，請依照安裝精靈的指示操作以安裝驅動程式。

點選 下一步。



6. Windows 98SE™ 會自動搜尋最適合的驅動程式，請選擇「搜尋裝置的最適用的驅動程式- 建議使用」。

點選 下一步。

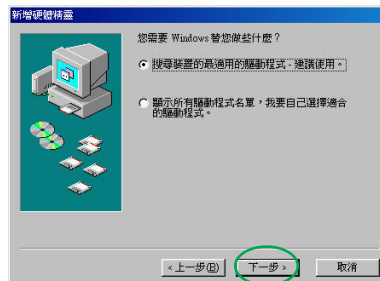

7. 選擇驅動程式 INF 檔所在的位置。

點選 瀏覽。





8. 選擇驅動程式所在光碟的檔案夾 USB_RW_Driver。
點選 確定。



9. 此時，在「指定的位置」下即會出現驅動程式所在目錄的名稱。
點選 下一步。



10. 接下來系統會自動搜尋資料夾中的檔案，並找到一個 INF 驅動程式檔案。
點選 下一步。



11. 接下來系統會開始安裝，待安裝完成時即會出現這個畫面。
點選 完成 即可。





檢查裝置是否出現在裝置管理員中

要確認您是否已正確安裝華碩 CRW-5232AS-U 燒錄機，請依照下面的步驟來檢查：

1. 在桌面上的 **我的電腦** 圖示上按一下滑鼠右鍵。
2. 在繼而出現的選單中選擇 **內容**。
3. 選擇 **裝置管理員** 標籤頁。
4. 在裝置的清單中選擇 **CD-ROM**，看到 **ASUS CRW-5232AS** 的裝置名稱，且無任何錯誤訊息，即表示您已正確安裝此一裝置。

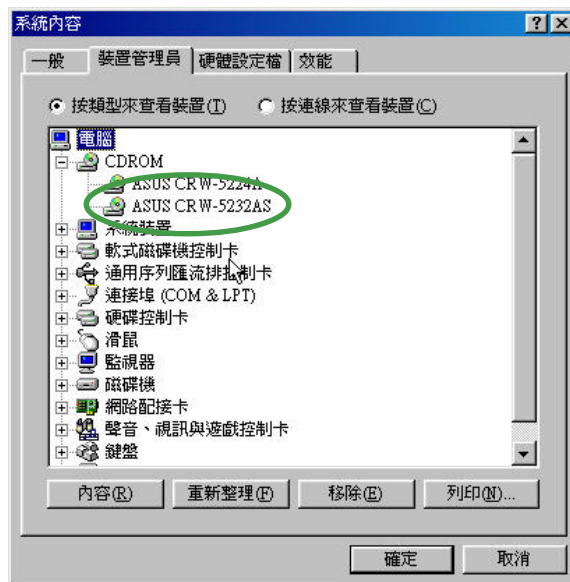

移除 CRW-5232AS-U 燒錄機

當您要將華碩 CRW-5232AS-U 燒錄機移除或暫不連接時，請依照下面的步驟來移除燒錄機，以避免系統資料發生毀損或遺失。

1. 在工作列上的「取出或抽出硬體」圖示上點一下滑鼠左鍵。



2. 將游標移到繼而出現的「ASUS CRW-5232AS(D:)」上。

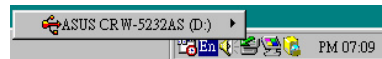

3. 接下來會出現如右圖的選單，請選擇「Safely Remove」。



4. 最後會出現如右圖的請您放心移除硬體的對話框。
點選 **確定** 即可將裝置拔除。





燒錄機的基本操作



說明！以下分別就水平與垂直兩種安裝方式的圖示來說明。

放入光碟片

1. 按下燒錄機面板上的「開啓/關閉」按鍵將托盤推出。

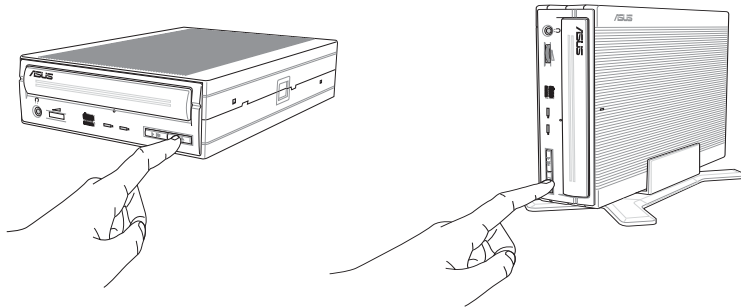

2. 將光碟片印有標籤識別的那一面朝上放入燒錄機的托盤中。

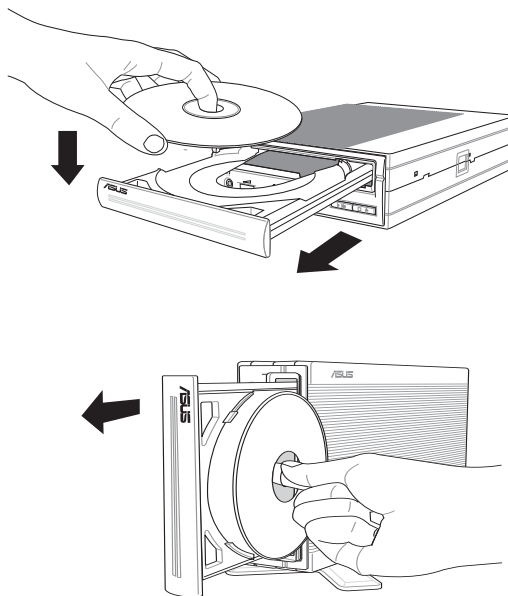



注意：如果您使用的是 12 公分的光碟片，請將之置放在托盤外圈的溝槽中。溝槽有助於固定光碟片。而如果您是使用 8 公分的光碟片，那麼請將之置放在內圈較小的溝槽中。

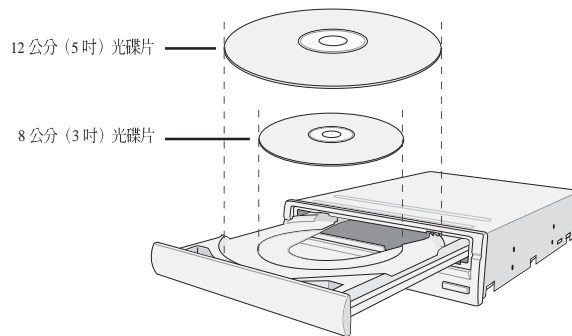

3. 按下燒錄機面板上的「開啓/ 關閉」按鍵再次將托盤送回，您也可以輕推托盤使之退回燒錄機中。

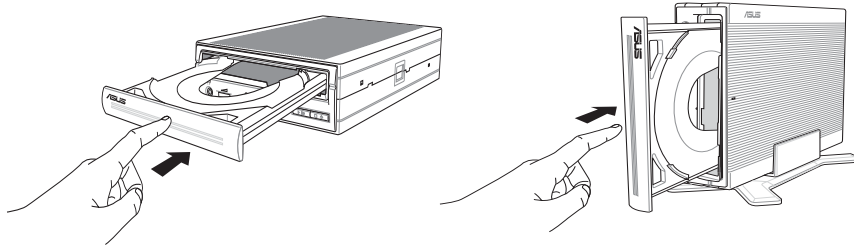

退出光碟片

1. 按下燒錄機面板上的「開啓/關閉」按鍵將托盤推出。
2. 從托盤取出光碟片。
3. 按下燒錄機面板上的「開啓/ 關閉」按鍵再次將托盤送回，您也可以輕推托盤使之退回燒錄機中。



緊急退片孔

位在燒錄機面板上的緊急退片孔可以讓您在遇到下面幾種情況中以手動的方式將光碟片取出：

- 電腦電源遭到不明原因中斷
- 燒錄機發生故障

請依照下面步驟利用緊急退片孔將光碟片由托盤中取出：



注意：請確認您無法利用面板上的開啓托盤鈕退出光碟時，才使用緊急退片孔將光碟片由托盤中取出。且在使用緊急退片孔之前請確認是否已關閉電源。

1. 請將本機所附的緊急退出孔插針輕輕地置入孔中直至托盤跳出。

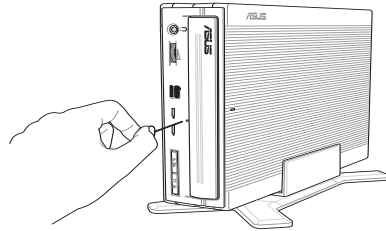
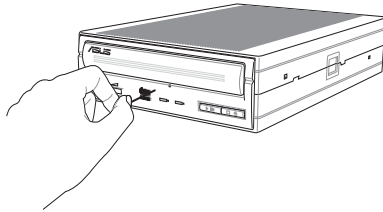

2. 接著慢慢地將托盤拉出直至可以取出光碟片，最後再慢慢推回托盤。

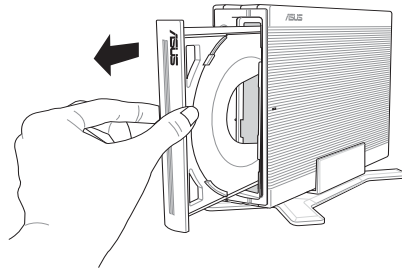
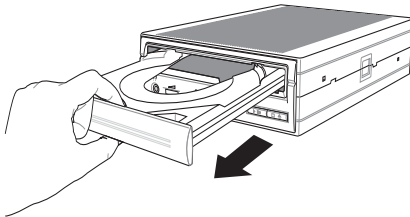

注意：請在緊急退出孔插針已確實將托盤鬆托之後再將托盤輕輕拉出，切勿強行將托盤用力拉出，以免造成損壞。



光碟片使用

請特別留意以下注意事項，它將幫助您避免損壞光碟片及燒錄機：

清潔光碟片

您可以使用壓縮空氣罐朝著光碟片表面噴灑約五秒鐘的時間即可除去表面灰塵。

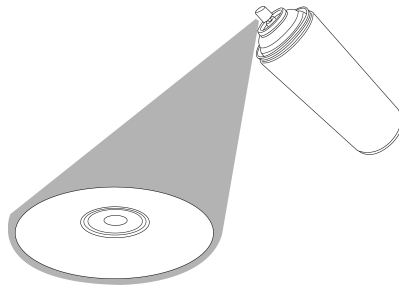

拿取光碟片

拿取光碟片時僅需輕握住光碟片外緣，不要直接觸摸光碟片表面。

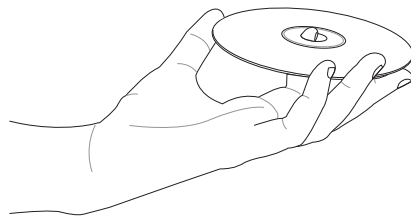



技術資訊

使用環境規格

溫度	工作溫度：0°C < to < 45°C 儲存溫度：-20°C < to < 60°C
濕度	工作濕度：20% to 80% (非壓縮) 儲存濕度：15% to 85% (非壓縮)
震動容許值	操作時：最高 0.3G (at 5 ~ 500 Hz) 未操作：最高 2.0G (at 10 ~ 500 Hz)
碰撞容許值	未操作：低於 50G (at 11ms/half sine wave, 3 shock/each side) 掉落衝擊：91公分高 (1角3菱6面)
音效規格	存取模式：47.5 dB TYP 讀取模式：45 dB TYP
平均故障間隔時間 (MTBF, Mean Time Between Failure)	100,000 Power On Hours ODC 20% of Power On Time (讀取動作) ODC 1% of Power On Time (寫入動作)
平均修復時間 (MTTR, Mean Time To Repair)	30 分鐘

*ODC – Operating Duty Cycle

電氣及音效規格

使用電源	輸入線性電壓 輸入線性頻率 輸入線性電流	100/240 V AC 50/60 Hz 1.2A
I/O 接頭	USB 接頭	高速 USB B 型接頭
音效	聲道 取樣 數位音效 失真率 訊噪比 (S/N ratio) 輸出	2 (立體聲) 44.1 kHz 16 bits 最大 0.2% (at 1kHz) 70 db 耳機：0.7V rms (typical)

Free Manuals Download Website

<http://myh66.com>

<http://usermanuals.us>

<http://www.somanuals.com>

<http://www.4manuals.cc>

<http://www.manual-lib.com>

<http://www.404manual.com>

<http://www.luxmanual.com>

<http://aubethermostatmanual.com>

Golf course search by state

<http://golfingnear.com>

Email search by domain

<http://emailbydomain.com>

Auto manuals search

<http://auto.somanuals.com>

TV manuals search

<http://tv.somanuals.com>