



PB278Q Series LCD Monitor

User Guide

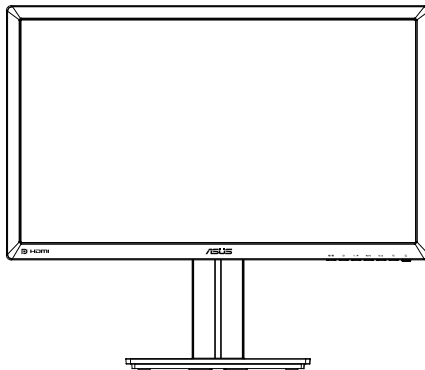

Table of contents

Notices	iii
Safety information	iv
Care & Cleaning	v
1.1 Welcome!	1-1
1.2 Package contents	1-1
1.3 Assembling the monitor	1-2
1.4 Monitor introduction	1-3
1.4.1 Front of the LCD monitor	1-3
1.4.2 Rear of the LCD monitor	1-5
1.4.3 QuickFit Function	1-6
2.1 Detaching the arm/stand (for VESA wall mount)	2-1
2.2 Adjusting the monitor	2-2
2.3 Connecting the cables	2-3
3.1 OSD (On-Screen Display) menu	3-1
3.1.1 How to reconfigure.....	3-1
3.1.2 OSD Function Introduction.....	3-2
3.2 Specifications	3-8
3.3 Troubleshooting (FAQ)	3-9
3.4 Supported Timing List	3-10

Copyright © 2012 ASUSTeK COMPUTER INC. All Rights Reserved.

No part of this manual, including the products and software described in it, may be reproduced, transmitted, transcribed, stored in a retrieval system, or translated into any language in any form or by any means, except documentation kept by the purchaser for backup purposes, without the express written permission of ASUSTeK COMPUTER INC. ("ASUS").

Product warranty or service will not be extended if: (1) the product is repaired, modified or altered, unless such repair, modification or alteration is authorized in writing by ASUS; or (2) the serial number of the product is defaced or missing.

ASUS PROVIDES THIS MANUAL "AS IS" WITHOUT WARRANTY OF ANY KIND, EITHER EXPRESS OR IMPLIED, INCLUDING BUT NOT LIMITED TO THE IMPLIED WARRANTIES OR CONDITIONS OF MERCHANTABILITY OR FITNESS FOR A PARTICULAR PURPOSE. IN NO EVENT SHALL ASUS, ITS DIRECTORS, OFFICERS, EMPLOYEES OR AGENTS BE LIABLE FOR ANY INDIRECT, SPECIAL, INCIDENTAL, OR CONSEQUENTIAL DAMAGES (INCLUDING DAMAGES FOR LOSS OF PROFITS, LOSS OF BUSINESS, LOSS OF USE OR DATA, INTERRUPTION OF BUSINESS AND THE LIKE), EVEN IF ASUS HAS BEEN ADVISED OF THE POSSIBILITY OF SUCH DAMAGES ARISING FROM ANY DEFECT OR ERROR IN THIS MANUAL OR PRODUCT.

SPECIFICATIONS AND INFORMATION CONTAINED IN THIS MANUAL ARE FURNISHED FOR INFORMATIONAL USE ONLY, AND ARE SUBJECT TO CHANGE AT ANY TIME WITHOUT NOTICE, AND SHOULD NOT BE CONSTRUED AS A COMMITMENT BY ASUS. ASUS ASSUMES NO RESPONSIBILITY OR LIABILITY FOR ANY ERRORS OR INACCURACIES THAT MAY APPEAR IN THIS MANUAL, INCLUDING THE PRODUCTS AND SOFTWARE DESCRIBED IN IT.

Products and corporate names appearing in this manual may or may not be registered trademarks or copyrights of their respective companies, and are used only for identification or explanation and to the owners' benefit, without intent to infringe.

Notices

Federal Communications Commission Statement

This device complies with Part 15 of the FCC Rules. Operation is subject to the following two conditions:

- This device may not cause harmful interference, and
- This device must accept any interference received including interference that may cause undesired operation.

This equipment has been tested and found to comply with the limits for a Class B digital device, pursuant to Part 15 of the FCC Rules. These limits are designed to provide reasonable protection against harmful interference in a residential installation. This equipment generates, uses and can radiate radio frequency energy and, if not installed and used in accordance with manufacturer's instructions, may cause harmful interference to radio communications. However, there is no guarantee that interference will not occur in a particular installation. If this equipment does cause harmful interference to radio or television reception, which can be determined by turning the equipment off and on, the user is encouraged to try to correct the interference by one or more of the following measures:

- Reorient or relocate the receiving antenna.
- Increase the separation between the equipment and receiver.
- Connect the equipment to an outlet on a circuit different from that to which the receiver is connected.
- Consult the dealer or an experienced radio/TV technician for help.



As an Energy Star® Partner, our company has determined that this product meets the Energy Star® guidelines for energy efficiency.

Canadian Department of Communications Statement

This digital apparatus does not exceed the Class B limits for radio noise emissions from digital apparatus set out in the Radio Interference Regulations of the Canadian Department of Communications.

This class B digital apparatus complies with Canadian ICES-003.

Safety information

- Before setting up the monitor, carefully read all the documentation that came with the package.
- To prevent fire or shock hazard, never expose the monitor to rain or moisture.
- Never try to open the monitor cabinet. The dangerous high voltages inside the monitor may result in serious physical injury.
- If the power supply is broken, do not try to fix it by yourself. Contact a qualified service technician or your retailer.
- Before using the product, make sure all cables are correctly connected and the power cables are not damaged. If you detect any damage, contact your dealer immediately.
- Slots and openings on the back or top of the cabinet are provided for ventilation. Do not block these slots. Never place this product near or over a radiator or heat source unless proper ventilation is provided.
- The monitor should be operated only from the type of power source indicated on the label. If you are not sure of the type of power supply to your home, consult your dealer or local power company.
- Use the appropriate power plug which complies with your local power standard.
- Do not overload power strips and extension cords. Overloading can result in fire or electric shock.
- Avoid dust, humidity, and temperature extremes. Do not place the monitor in any area where it may become wet. Place the monitor on a stable surface.
- Unplug the unit during a lightning storm or if it will not be used for a long period of time. This will protect the monitor from damage due to power surges.
- Never push objects or spill liquid of any kind into the slots on the monitor cabinet.
- To ensure satisfactory operation, in case use at a PC then it should use the monitor only with computers which have appropriate configured receptacles marked between 100-240V AC.
- If you encounter technical problems with the monitor, contact a qualified service technician or your retailer.
- The wall socket shall be installed near the equipment and shall be easily accessible.

Care & Cleaning

- Before you lift or reposition your monitor, it is better to disconnect the cables and power cord. Follow the correct lifting techniques when positioning the monitor. When lifting or carrying the monitor, grasp the edges of the monitor. Do not lift the display by the stand or the cord.
- Cleaning. Turn your monitor off and unplug the power cord. Clean the monitor surface with a lint-free, non-abrasive cloth. Stubborn stains may be removed with a cloth dampened with mild cleaner.
- Avoid using a cleaner containing alcohol or acetone. Use a cleaner intended for use with the LED. Never spray cleaner directly on the screen, as it may drip inside the monitor and cause an electric shock.

The following symptoms are normal with the monitor:

- The screen may flicker during the initial use due to the nature of the fluorescent light. Turn off the Power Switch and turn it on again to make sure that the flicker disappears.
- You may find slightly uneven brightness on the screen depending on the desktop pattern you use.
- When the same image is displayed for hours, an afterimage of the previous screen may remain after switching the image. The screen will recover slowly or you can turn off the Power Switch for hours.
- When the screen becomes black or flashes, or cannot work anymore, contact your dealer or service center to fix it. Do not repair the screen by yourself!

Conventions used in this guide



WARNING: Information to prevent injury to yourself when trying to complete a task.



CAUTION: Information to prevent damage to the components when trying to complete a task.



IMPORTANT: Information that you **MUST** follow to complete a task.



NOTE: Tips and additional information to aid in completing a task.

Where to find more information

Refer to the following sources for additional information and for product and software updates.

1. ASUS websites

The ASUS websites worldwide provide updated information on ASUS hardware and software products. Refer to <http://www.asus.com>

2. Optional documentation

Your product package may include optional documentation that may have been added by your dealer. These documents are not part of the standard package.

1.1 Welcome!

Thank you for purchasing the ASUS® PB278Q Series LCD monitor!

The latest widescreen LCD monitor from ASUS provides a crisper, broader, and brighter display, plus a host of features that enhance your viewing experience.

With these features, you can enjoy the convenience and delightful visual experience that the PB278Q Series brings you!

1.2 Package contents

Check your PB278Q Series LCD monitor package for the following items:

- ✓ LCD monitor
- ✓ Power Cord
- ✓ VGA Cable
- ✓ DVI Cable (Dual link)
- ✓ DisplayPort Cable
- ✓ HDMI Cable
- ✓ Audio Cable
- ✓ Quick Start Guide
- ✓ Warranty Card



If any of the above items is damaged or missing, contact your retailer immediately.

1.3 Assembling the monitor

To assemble the monitor:

1. Place the display flat on a cloth on the table, assemble the base according to the drawing and use a coin to turn the screw tight.
2. Put the cable clip inset the hole of stand, and adjust the monitor to the angle that is most comfortable for you.

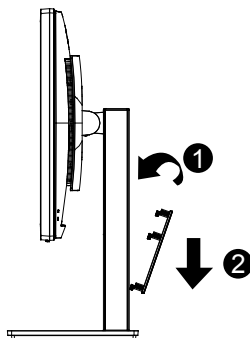
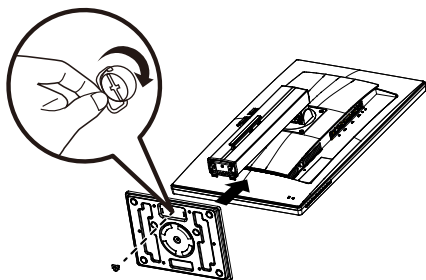



1.4 Monitor introduction

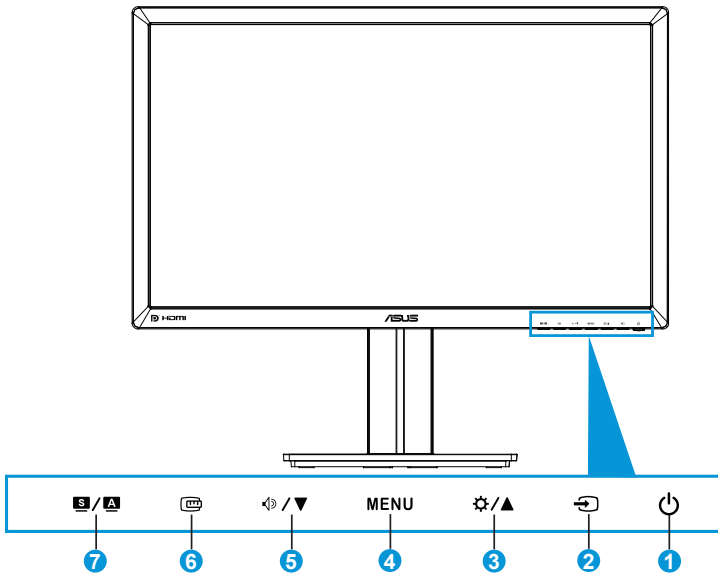



1.4.1 Front of the LCD monitor



1.  Power Button/Power Indicator:
 - Press this button to turn the monitor on/off.
 - The color definition of the power indicator is shown below.

Status	Description
Blue	ON
Amber	Standby mode
OFF	OFF

2.  Input Select Button:
 - Press this button to select input source.
3.   Button:
 - Press this button to increase values or to move your selection right/up.
 - Brightness hotkey
4. MENU Button:
 - Press this button to turn on the OSD menu, or to enact the selected OSD menu item.

- Press this button to exit the hotkey OSD menu.
5.  /  Button:
- Press this button to decrease values or to move your selection left/down.
 - Volume hotkey
6.  QuickFit button:
- Press this button to activate the QuickFit function designed for alignment.
 - The QuickFit function contains 9 pages of common grid patterns, paper sizes, and photo sizes. (Please refer to 1.3.3 QuickFit Function)
7.  Button:
- Press this button to select a desired preset mode.
 - Press this button to exit the OSD menu or to go back to the previous menu when the OSD menu is active.
 - Press this button for 2 ~ 4 seconds to automatically adjust the image to its optimized position, clock, and phase (for VGA mode only).

1.4.2 Rear of the LCD monitor

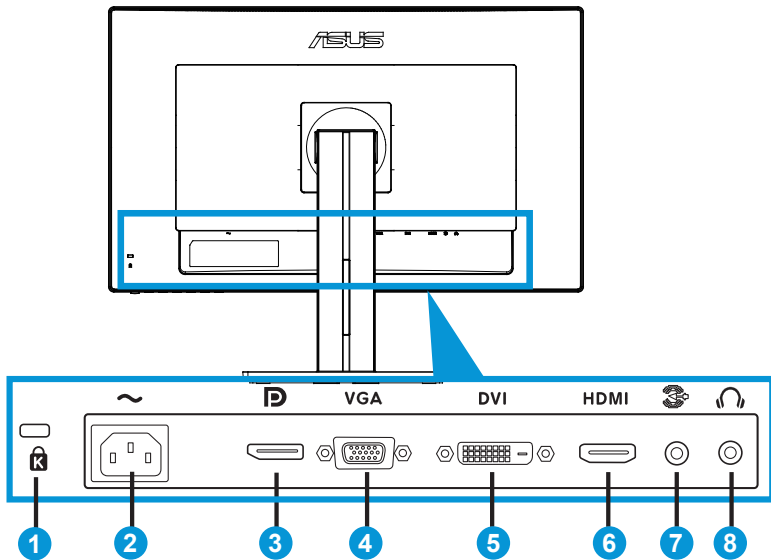

Rear connectors

1. Kensington lock slot.
2. AC-IN port: This port connects the power cord.
3. DisplayPort. This port is for connection with a DisplayPort compatible device.
4. VGA port: This 15-pin port is for PC VGA connection.
5. DVI port: This 24-pin port is for PC (Personal Computer) DVI-D digital signal connection.
6. HDMI port: This port is for connection with an HDMI compatible device.



While the PB278Q supports up to 2560 x 1440 WQHD resolutions including DVI-dual link, HDMI and DisplayPort, some graphics cards only support up to 1920 x 1200 resolution content transmission via HDMI. Please check with your local distributor or retailer on the hardware limitations of your laptop or desktop.

7. Audio Line-in Port
8. Earphone jack.

1.4.3 QuickFit Function

The QuickFit function contains three patterns: (1) Grid (2) Paper size (3) Photo size.

1. Grid patterns

The grid patterns facilitate designers and users to organize content and layout on a page and achieve a consistent look and feel.

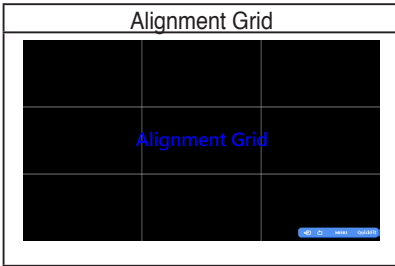

2. Paper size

QuickFit provides numerous commonly used standard paper sizes for users to view their documents in real size on the screen.

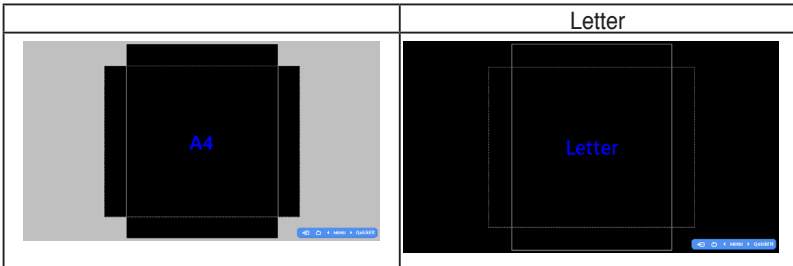

3. Photo size

The various real photo sizes displayed in the QuickFit function provides photographers and other users to accurately view and edit their photos in real size on the screen.

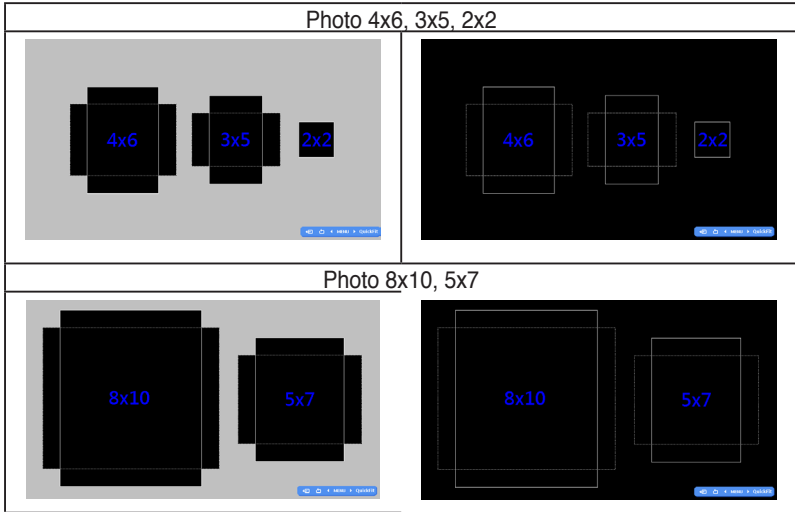

2.1 Detaching the arm/stand (for VESA wall mount)

The detachable stand of this monitor is specially designed for VESA wall mount.

To detach the arm/stand:

1. Disconnect power and signal cables. Carefully put the front of the monitor face down on a clean table.
2. Use a screwdriver to remove the four screws on the arm (Figure 1), and then detach the arm/stand from the monitor (Figure 2).



-
- We recommend that you cover the table surface with soft cloth to prevent damage to the monitor.
 - Hold the stand of the monitor while removing the screws.
-

Figure 1

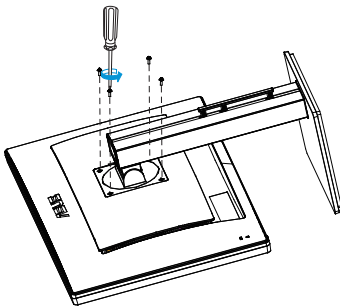
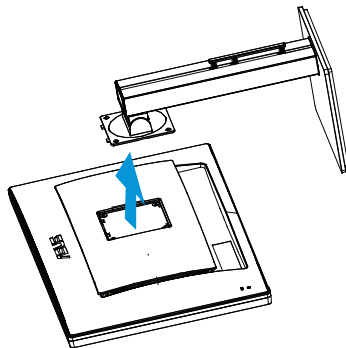

Figure 2



-
- The VESA wall mount kit (100 x 100 mm) is purchased separately.
 - Use only the UL Listed Wall Mount Bracket with minimum weight/ load 28.8 kg (Screw size: 4 x 10 mm).
-

2.2 Adjusting the monitor

- For optimal viewing, we recommend that you look at the full face of the monitor, then adjust the monitor to the angle that is most comfortable for you.
- Hold the stand to prevent the monitor from falling when you change its angle.
- You can adjust the monitor's angle from $+20^{\circ}$ to -5° and it allows 60° swivel adjustment from either left or right. You can also adjust the monitor's height within $\pm 12\text{cm}$.

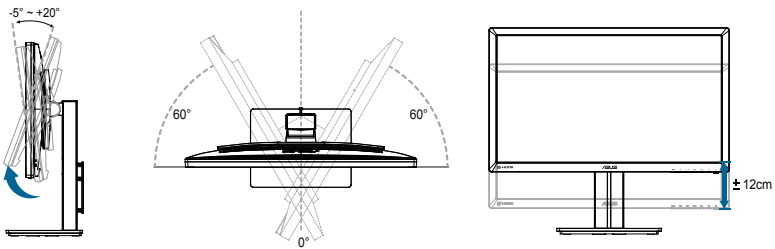

Pivoting the monitor

1. Lift the monitor to the highest position.
2. Tilt the monitor to its maximum angle.
3. Pivot the monitor clockwise to the angle you need.

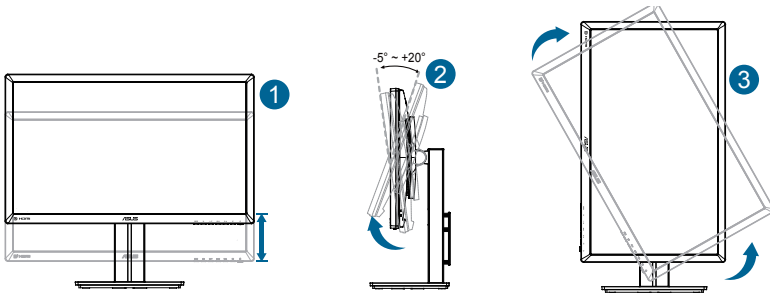

It is normal that the monitor slightly shakes while you adjust the viewing angle.

2.3 Connecting the cables

Connect the cables as the following instructions:

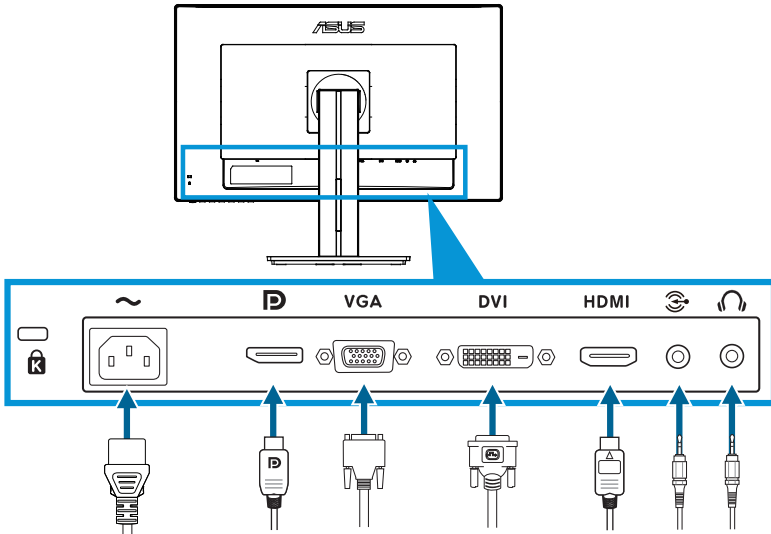

- **To connect the power cord:** Connect one end of the power cord securely to the monitor's AC input port, the other end to a power outlet.
- **To connect the VGA/HDMI/DVI/DisplayPort cable:**
 - a. Plug one end of the VGA/HDMI/DVI/DisplayPort cable to the monitor's VGA/HDMI/DVI/DisplayPort jack.
 - b. Connect the other end of the VGA/HDMI/DVI/DisplayPort cable to your computer's VGA/HDMI/DVI/DisplayPort jack.
 - c. Tighten the two screws to secure the VGA/DVI connector.
- **To connect the audio cable:** Plug one end of the audio cable to the monitor's Audio Line-in Port. Connect the other end of the audio cable to your computer's audio Port.
- **To use the earphone:** Connect the end with plug type to the monitor's earphone jack when an HDMI or DisplayPort signal is fed.



When these cables are connected, you can choose the desired signal from the Input Select item in the OSD menu.

3.1 OSD (On-Screen Display) menu

3.1.1 How to reconfigure

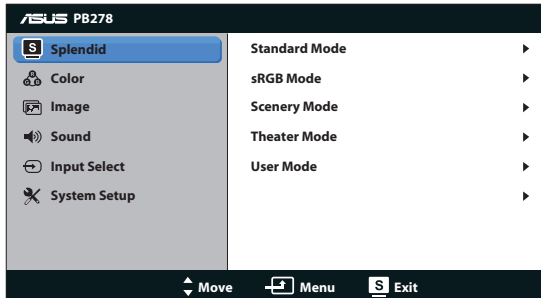

1. Press the MENU button to activate the OSD menu.
2. Press \leftarrow / \blacktriangledown and \rightarrow / \blacktriangle to navigate through the functions. Highlight and activate the desired function by pressing the MENU button. If the function selected has a sub-menu, press \leftarrow / \blacktriangledown and \rightarrow / \blacktriangle again to navigate through the sub-menu functions. Highlight and activate the desired sub-menu function by pressing the MENU button.
3. Press \leftarrow / \blacktriangledown and \rightarrow / \blacktriangle to change the settings of the selected function.
4. To exit the OSD menu, press the $\left[\text{S} \right]$ / $\left[\text{A} \right]$ button. Repeat step 2 and step 3 to adjust any other function.

3.1.2 OSD Function Introduction

1. Splendid

This function contains five sub-functions that you can select for your preference. Each mode has the Reset selection, allowing you to maintain your setting or return to the preset mode.

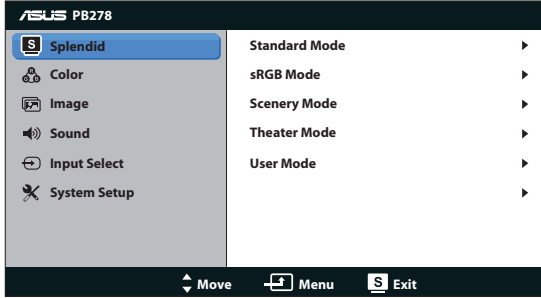

- **Standard Mode:** This is the best choice for document editing with SPLENDID™ Video Intelligence.
- **sRGB Mode:** Compatible with sRGB color space. sRGB mode is the best choice for document editing.

Color Space	White Point		Primaries					
	Xw	Yw	Xr	Yr	Xg	Yg	Xb	Yb
sRGB	0.3127	0.329	0.64	0.33	0.3	0.6	0.15	0.06

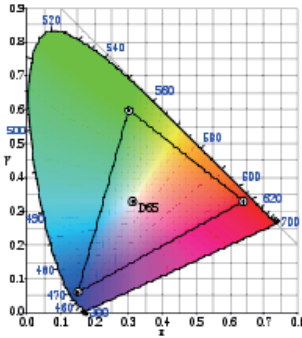

- **Scenery Mode:** This is the best choice for scenery photo displaying with SPLENDID™ Video Intelligence.
- **Theater Mode:** This is the best choice for movie watching with SPLENDID™ Video Intelligence.

- **User Mode:** More items are adjustable in the Color menu.

Function	Standard Mode	sRGB Mode	Scenery Mode	Theater Mode	User Mode
Brightness	Yes	Yes	Yes	Yes	Yes
Contrast	Yes	No	Yes	Yes	Yes
Saturation	No	No	Yes	Yes	Yes
Hue	No	No	No	No	Yes
Color Temperature	Yes	No	Yes	Yes	Yes
Gamma	Yes	No	No	No	Yes
Advanced Setting	Gain	No	No	No	Yes
	Offset	No	No	No	Yes

2. Color

Select the image color you like from this function.

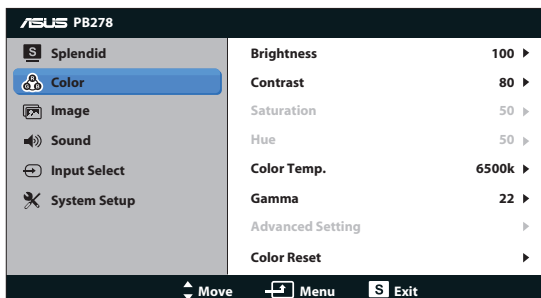

- **Brightness:** The adjusting range is from 0 to 100. The / button is also a hot key to activate this function.
- **Contrast:** The adjusting range is from 0 to 100.
- **Saturation:** The adjusting range is from 0 to 100.
- **Hue:** Shift the image color between green and purple.
- **Color Temp.:** Contain four color modes: 9300K, 6500K, 5500K, and 5000K.



The DDC/CI tool installed at your PC will display “User 1” instead of the “5500K” color temperature you selected for this monitor.

- **Gamma:** Set the color mode to 2.2 or 1.8.
- **Advanced Setting:**
 - Adjust the gain levels for R, G, B.
 - Adjust the black level offset values for R, G, B.
- **Color Reset:**
 - **Current mode color reset:**
Reset the color settings of current color mode to the factory default value.
 - **All modes color reset:**
Reset the color settings of all color modes to the factory default value.

3. Image

You can adjust the image Sharpness, Trace Free, Aspect Control, ASCR, Position (VGA only), and Focus (VGA only) from this main function.

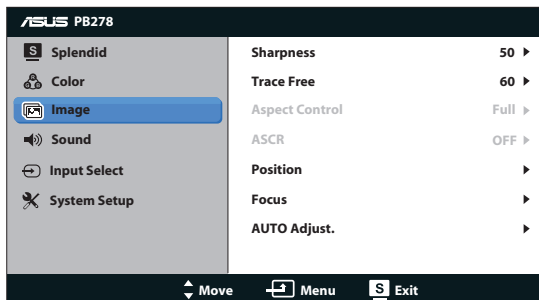

- **Sharpness:** Adjust the picture sharpness. The adjusting range is from 0 to 100.
- **Trace Free:** Speed up the response time by Over Drive technology. The adjusting range is from lower 0 to faster 100.
- **Aspect Control:** Adjust the aspect ratio to “Full”, “4:3”, “1:1”, or “Over Scan”. (The “4:3” ratio is only for 4:3 or 5:4 image source. The “Over Scan” ratio is only available for HDMI input.)
- **ASCR:** Turn on or off the ASCR (ASUS Smart Contrast Ratio) function. (Only available at Scenery Mode and Theater Mode.)
- **Position:** Adjust the horizontal position (H-Position) and the vertical position (V-Position) of the image. The adjusting range is from 0 to 100 (only available for VGA input).
- **Focus:** Reduce Horizontal-line noise and Vertical-line noise of the image by adjusting (Phase) and (Clock) separately. The adjusting range is from 0 to 100 (only available for VGA input).
- **AUTO Adjust.:** Automatically adjust the image to its optimized position, clock, and phase. (Only available for VGA input.)



- Phase adjusts the phase of the pixel clock signal. With a wrong phase adjustment, the screen shows horizontal disturbances.
- Clock (pixel frequency) controls the number of pixels scanned by one horizontal sweep. If the frequency is not correct, the screen shows vertical stripes and the image is not proportional.

4. Sound

Adjust the sound settings to your preference.

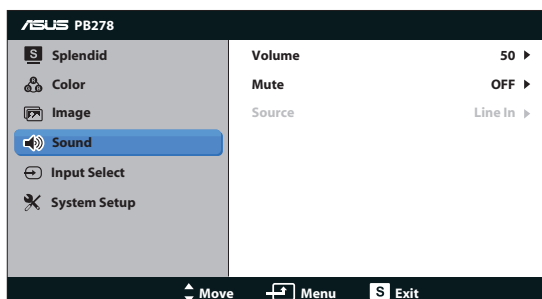

- **Volume:** Adjust the output volume level.
- **Mute:** Mute the output volume.
- **Source:** Adjust audio source to “Line In” or “HDMI” (only available for HDMI input);
Adjust audio source to “Line In” or “DisplayPort” (only available for DisplayPort input).

5. Input Select

Select the input source from **VGA**, **DVI**, **HDMI**, or **DisplayPort**.

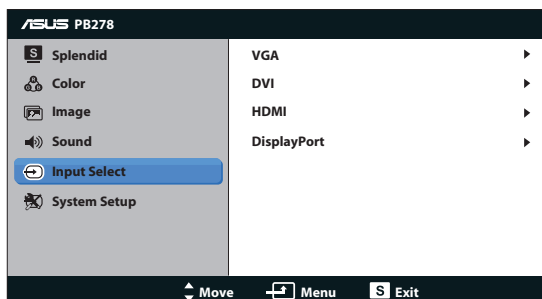

6. System Setup

Adjusts the system configuration.

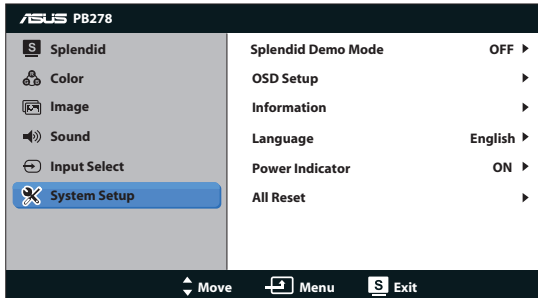



- **Splendid Demo Mode:** Split the screen into two for Splendid modes comparison. (Scenery mode/Theater mode only)
- **OSD Setup:** Adjust the horizontal position (H-Position), vertical position (V-Position), OSD Timeout, DDC/CI, and Transparency of the OSD screen.
- **Information:** Display the monitor information.
- **Language:** Select OSD language. The selections are English, French, German, Spanish, Italian, Dutch, Russian, Traditional Chinese, Simplified Chinese, Japanese, Persian, Thai, Indonesian, Poland, Turkey, Portugal, Czech, Croatia, Hungary, Romania, Korean.
- **Power Indicator:** Turn the power LED indicator on/off.
- **All Reset:** Set to “Yes” to revert all settings to the factory default mode.

3.2 Specifications

Model	PB278Q
Panel Size	27.0"W (68.6 cm)
Max. Resolution	1920x1080 (VGA); 2560 x 1440 (DVI, HDMI, DP)
Brightness (Typ.)	300cd/m ²
Intrinsic Contrast Ratio (Typ.)	1000:1
Viewing Angle (CR=10)	178°(V) /178°(H)
Display Colors	16.7 M(True 8bit)
Response Time	5ms (Gray to Gray)
Satellite Speaker	3W x 2 stereo
Earphone Output	Yes
Sound from HDMI	Yes
HDMI input	Yes
DVI input	DVI (dual link) with HDCP
D-Sub input	Yes
DisplayPort input	Yes
Audio Line-in	Yes
Power ON Consumption	< 60W
Chassis Colors	Black
Tilt	-5° ~ +20°
Swivel(angle)	+60°~-60°
Pivot(angle/direction)	90°(clockwise)
Height Adjustment (mm)	Yes(0~120mm)
VESA Wall Mounting	Yes (100mm x 100mm)
Phys. Dimension (WxHxD)	643 x 552.3 x 218 mm
Box Dimension (WxHxD)	755 x 224 x 470 mm
Net Weight (Esti.)	8.8 kg
Gross Weight (Esti.)	12 kg
Voltage Rating	AC 100~240V(Built-in)

*Specifications are subject to change without notice.

3.3 Troubleshooting (FAQ)

Problem	Possible Solution
Power LED is not ON	<ul style="list-style-type: none"> • Press the  button to check if the monitor is in the ON mode. • Check if the power cord is properly connected to the monitor and the power outlet.
The power LED lights amber and there is no screen image	<ul style="list-style-type: none"> • Check if the monitor and the computer are in the ON mode. • Make sure the signal cable is properly connected the monitor and the computer. • Inspect the signal cable and make sure none of the pins are bent. • Connect the computer with another available monitor to check if the computer is properly working.
Screen image is too light or dark	<ul style="list-style-type: none"> • Adjust the Contrast and Brightness settings via OSD.
Screen image is not centered or sized properly	<ul style="list-style-type: none"> • Press the  button for two seconds to automatically adjust the image. • Adjust the H-Position or V-Position settings via OSD.
Screen image bounces or a wave pattern is present in the image	<ul style="list-style-type: none"> • Make sure the signal cable is properly connected to the monitor and the computer. • Move electrical devices that may cause electrical interference.
Screen image has color defects (white does not look white)	<ul style="list-style-type: none"> • Inspect the signal cable and make sure that none of the pins are bent. • Perform Reset via OSD. • Adjust the R/G/B color settings or select the Color Temperature via OSD.
Screen image is blurry or fuzzy	<ul style="list-style-type: none"> • Press the  button for two seconds to automatically adjust the image (for VGA mode only). • Adjust the Phase and Clock settings via OSD.
No sound or sound is low	<ul style="list-style-type: none"> • Ensure that the audio cable is properly connected to the monitor and the computer. • Adjust the volume settings of both your monitor and computer. • Ensure that the computer sound card driver is properly installed and activated.
HDMI cannot support WQHD	<ul style="list-style-type: none"> • While the PB278Q supports up to 2560 x 1440 WQHD resolutions including DVI-dual link, HDMI and DisplayPort, some graphics cards only support up to 1920 x 1200 resolution content transmission via HDMI. Please check with your local distributor or retailer on the hardware limitations of your laptop or desktop.

3.4 Supported Timing List

PC Supported Primary Timing

Resolution	Refresh Rate	Horizontal Frequency
640x480	60Hz	31.469kHz
640x480	72Hz	37.861kHz
640x480	75Hz	37.5kHz
640x480	85Hz	43.269kHz
800x600	56Hz	35.156kHz
800x600	60Hz	37.879kHz
800x600	72Hz	48.077kHz
800x600	75Hz	46.875kHz
800x600	85Hz	53.674kHz
1024x768	60Hz	48.363kHz
1024x768	70Hz	56.476kHz
1024x768	75Hz	60.023kHz
1024x768	85Hz	68.677kHz
1152x864	75Hz	67.5kHz
1280x960	60Hz	60kHz
1280x1024	60Hz	63.981kHz
1280x1024	75Hz	79.976kHz
1440x900	60Hz	55.935kHz
1440x900	75Hz	70.635kHz
1680x1050	60Hz	65.29kHz
1920x1080	60Hz	67.5kHz

IBM Modes, Factory Preset Timing(D-SUB, DVI-D, HDMI inputs)

Resolution	Refresh Rate	Horizontal Frequency
640x350	70Hz	31.469kHz
640x350	85Hz	37.861kHz
720x400	70Hz	31.469kHz
720x400	85Hz	37.927kHz

MAC Modes, Factory Preset Timing(D-SUB, DVI-D, HDMI inputs)

Resolution	Refresh Rate	Horizontal Frequency
640x480	67Hz	35kHz
832x624	75Hz	49.725kHz

VESA Modes, User Available Timing

Resolution	Refresh Rate	Horizontal Frequency
848x480	60Hz	31.02
1280x720(RB)	60Hz	44.444kHz
1280x720	60Hz	44.772kHz
1280x720	75Hz	56.456kHz
1280x768(RB)	60Hz	47.396kHz
1280x800(RB)	60Hz	49.306kHz

1280x800	60Hz	49.702kHz
1280x800	75Hz	62.795kHz
1366x768	60Hz	47.712kHz
1440x900(RB)	60Hz	55.469kHz
1440x900	75Hz	70.635kHz
1680x1050(RB)	60Hz	64.674kHz
1920x1080	60Hz	66.587kHz
WQHD Mode (DVI (dual link), HDMI and DP only)		
2560x1440	60Hz	88.787kHz

* While the PB278Q supports up to 2560 x 1440 WQHD resolutions including DVI-dual link, HDMI and DisplayPort, some graphics cards only support up to 1920 x 1200 resolution content transmission via HDMI. Please check with your local distributor or retailer on the hardware limitations of your laptop or desktop.

SD/HD Timings (HDMI input only)

HDMI 1.3,CEA-861B Formats, SD/HD Supported Primary Timings of (HDMI input only)

Resolution	Refresh Rate	Horizontal Frequency
640x480P	59.94 / 60Hz	31.469 / 31.5kHz
720x480P	59.94 / 60Hz	31.469 / 31.5kHz
720x576P	50Hz	31.25kHz
1280x720P	50Hz	37.5kHz
1280x720P	59.94 / 60Hz	44.955 /45kHz
1920x1080i	50Hz	28.125kHz
1920x1080i	59.94 / 60Hz	33.716 / 33.75kHz

HDMI 1.3,CEA-861B Formats, SD/HD Supported Optional Timings of (HDMI input only)

Resolution	Refresh Rate	Horizontal Frequency
1440x480P	59.94 / 60Hz	31.469 / 31.5kHz
1440x576P	50Hz	31.25kHz
1920x1080P	50Hz	56.25kHz
1920x1080P	59.94 / 60Hz	67.433 / 67.5kHz

* The modes not listed in the above tables may not be supported. For optimal resolution, we recommend that you choose a mode listed in the above tables.

Free Manuals Download Website

<http://myh66.com>

<http://usermanuals.us>

<http://www.somanuals.com>

<http://www.4manuals.cc>

<http://www.manual-lib.com>

<http://www.404manual.com>

<http://www.luxmanual.com>

<http://aubethermostatmanual.com>

Golf course search by state

<http://golfingnear.com>

Email search by domain

<http://emailbydomain.com>

Auto manuals search

<http://auto.somanuals.com>

TV manuals search

<http://tv.somanuals.com>