

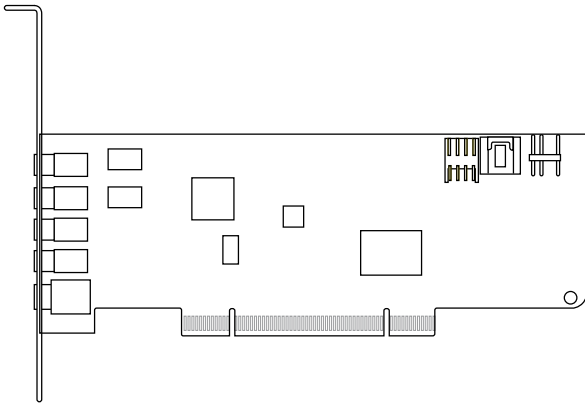

Xonar DS

Audio card

User manual



E7809

Revised Edition V2

October 2012

Copyright © 2012 ASUSTeK COMPUTER INC. All Rights Reserved.

No part of this manual, including the products and software described in it, may be reproduced, transmitted, transcribed, stored in a retrieval system, or translated into any language in any form or by any means, except documentation kept by the purchaser for backup purposes, without the express written permission of ASUSTeK COMPUTER INC. ("ASUS").

Product warranty or service will not be extended if: (1) the product is repaired, modified or altered, unless such repair, modification or alteration is authorized in writing by ASUS; or (2) the serial number of the product is defaced or missing.

ASUS PROVIDES THIS MANUAL "AS IS" WITHOUT WARRANTY OF ANY KIND, EITHER EXPRESS OR IMPLIED, INCLUDING BUT NOT LIMITED TO THE IMPLIED WARRANTIES OR CONDITIONS OF MERCHANTABILITY OR FITNESS FOR A PARTICULAR PURPOSE. IN NO EVENT SHALL ASUS, ITS DIRECTORS, OFFICERS, EMPLOYEES OR AGENTS BE LIABLE FOR ANY INDIRECT, SPECIAL, INCIDENTAL, OR CONSEQUENTIAL DAMAGES (INCLUDING DAMAGES FOR LOSS OF PROFITS, LOSS OF BUSINESS, LOSS OF USE OR DATA, INTERRUPTION OF BUSINESS AND THE LIKE), EVEN IF ASUS HAS BEEN ADVISED OF THE POSSIBILITY OF SUCH DAMAGES ARISING FROM ANY DEFECT OR ERROR IN THIS MANUAL OR PRODUCT.

SPECIFICATIONS AND INFORMATION CONTAINED IN THIS MANUAL ARE FURNISHED FOR INFORMATIONAL USE ONLY, AND ARE SUBJECT TO CHANGE AT ANY TIME WITHOUT NOTICE, AND SHOULD NOT BE CONSTRUED AS A COMMITMENT BY ASUS. ASUS ASSUMES NO RESPONSIBILITY OR LIABILITY FOR ANY ERRORS OR INACCURACIES THAT MAY APPEAR IN THIS MANUAL, INCLUDING THE PRODUCTS AND SOFTWARE DESCRIBED IN IT.

Products and corporate names appearing in this manual may or may not be registered trademarks or copyrights of their respective companies, and are used only for identification or explanation and to the owners' benefit, without intent to infringe.

Contents

Notices	iv
Safety information	v
Trademarks	v
License	v
1. Introduction	1
1.1 Package contents	1
1.2 System requirements	1
1.3 Specifications summary	2
2. Xonar DS card layout	4
3. Installing the hardware	6
3.1 Installing the audio card	6
3.2 Connecting to a TV tuner card	7
4. Installing software	8
Installing the card driver	8
5. Connecting speakers and peripherals	9
5.1 Connecting digital speaker systems (Home Theater)	9
5.2 Connecting stereo headphones	10
5.3 Connecting Analog Speaker Systems.....	12
5.4 Connecting microphone	17
5.5 Connecting Line-In audio sources	18
6. Xonar Audio Center	19
6.1 Xonar Audio Center GUI	19
6.2 Main Setting	21
6.3 Mixer/Volume	27
6.4 Effects	30
6.5 Karaoke.....	32
6.6 FlexBass	34
6.7 Smart Volume Normalization	36
6.8 DS3D GX and DSP Modes	38
6.9 VocalFX.....	40
7. Troubleshooting and FAQs	43
[Troubleshooting]	43
[FAQ]	45

Notices

Federal Communications Commission Statement

This device complies with Part 15 of the FCC Rules. Operation is subject to the following two conditions:

- This device may not cause harmful interference, and
- This device must accept any interference received including interference that may cause undesired operation.

This equipment has been tested and found to comply with the limits for a Class B digital device, pursuant to Part 15 of the FCC Rules. These limits are designed to provide reasonable protection against harmful interference in a residential installation. This equipment generates, uses and can radiate radio frequency energy and, if not installed and used in accordance with manufacturer's instructions, may cause harmful interference to radio communications. However, there is no guarantee that interference will not occur in a particular installation. If this equipment does cause harmful interference to radio or television reception, which can be determined by turning the equipment off and on, the user is encouraged to try to correct the interference by one or more of the following measures:

- Reorient or relocate the receiving antenna.
- Increase the separation between the equipment and receiver.
- Connect the equipment to an outlet on a circuit different from that to which the receiver is connected.
- Consult the dealer or an experienced radio/TV technician for help.

Canadian Department of Communications Statement

This digital apparatus does not exceed the Class B limits for radio noise emissions from digital apparatus set out in the Radio Interference Regulations of the Canadian Department of Communications.

This class B digital apparatus complies with Canadian ICES-003.

Australia statement notice

From 1 January 2012 updated warranties apply to all ASUS products, consistent with the Australian Consumer Law. For the latest product warranty details please visit <http://support.asus.com>. Our goods come with guarantees that cannot be excluded under the Australian Consumer Law. You are entitled to a replacement or refund for a major failure and compensation for any other reasonably foreseeable loss or damage. You are also entitled to have the goods repaired or replaced if the goods fail to be of acceptable quality and the failure does not amount to a major failure.

If you require assistance please call ASUS Customer Service 1300 2787 88 or visit us at <http://support.asus.com>.

Safety information

- Before installing the device on a motherboard, carefully read all the manuals that came with the package.
- To prevent electrical shock hazard or short circuits, switch off the power supply before installing the device on a motherboard or connecting any signal cables to the device.
- If the device is broken, do not try to fix it by yourself. Contact a qualified service technician or your retailer.
- Before using the product, make sure all cables are correctly connected. If you detect any damage, contact your dealer immediately.
- To avoid short circuits, keep paper clips, screws, and staples away from connectors, sockets and circuitry.
- Avoid dust, humidity, and temperature extremes. Do not place the product in any area where it may become wet.
- Place the product on a stable surface.
- If you encounter technical problems with the product, contact a qualified service technician or your retailer.



This symbol of the crossed out wheeled bin indicates that the product (electrical and electronic equipment) should not be placed in municipal waste. Check local regulations for disposal of electronic products.

Trademarks

Xonar and ASUS logo are trademarks of ASUSTek Computer Inc. "Dolby" and "Dolby Digital Live", "Dolby Pro Logic IIX", "Dolby Virtual Speaker", "Dolby Headphone" are trademarks of Dolby Laboratories. EAX and A3D are trademarks of Creative Technology Ltd. Microsoft, DirectSound3D, Windows are trademarks of Microsoft Corporation. Other company and product names may be trademarks of the respective companies with which they are associated. ASIO is a trademark and software of Steinberg Media Technologies GmbH

License

Dolby Master Studio driver is manufactured under license from Dolby Laboratories.

1. Introduction

1.1 Package contents

- ASUS Xonar DS PCI audio card
- S/PDIF TOSLINK optical adapter x1
- Low Profile Bracket x1
- Support CD
- Quick Start Guide

1.2 System requirements

- One PCI 2.2 (or higher) compatible slot for the audio card
- Microsoft® Windows® Vista (32/64bit) / XP (32/64bit) / MCE2005
- Intel® Pentium® 4 1.4 GHz or AMD® Athlon 1400 CPU or faster CPU
- 256 MB (or above) DRAM system memory
- 60 MB available HDD space for driver installation package
- CD-ROM drive (or DVD-ROM drive) for software installation
- High-quality headphones, powered analog speakers, or a Dolby Digital or DTS decoder, to enjoy the ultra-high fidelity sound of the card

1.3 Specifications summary

Items	Description
Audio Performance	
Output Signal-to-Noise Ratio (A-Weighted):	Up to 107dB
Input Signal-to-Noise Ratio (A-Weighted):	100 dB
Output Total Harmonic Distortion + Noise at 1kHz (A-Weighted) :	Up to 0.0017% (-95dB)
Input Total Harmonic Distortion + Noise at 1kHz (A-Weighted) :	Up to 0.0017% (-95dB)
Frequency Response (-3dB, 24-bit/96kHz input) :	<10Hz to 48kHz
Output/Input Full-Scale Voltage	1 Vrms (3Vp-p)
Sample Rate Conversion Quality	Almost lossless, high-fidelity floating-point filters, with: -140dB THD+N (typical value for 44.1K->48KHz, 24bit) 145dB Dynamic Range (typical value for 44.1K->48KHz, 24bit)
Bus Compatibility	
PCI	PCI v2.2 or above bus compatible
Main Chipset	
Audio Processor	ASUS AV200 High-Performance Sound Processor (Max. 192KHz/24bit)
D-A Converter of Digital Sources:	Wolfson WM8776* 1 (108dB SNR, Max. 192kHz/24bit) Wolfson WM8766*1 (103dB SNR, Max. 192kHz/24bit)
A-D Converter for Analog Inputs:	Wolfson WM8776* 1 (102dB SNR, Max. 96kHz/24bit)
Sample Rate and Resolution	
Analog Playback Sample Rate and Resolution	44.1K/48K/96K/192KHz @ 16/24bit for all channels
Analog Recording Sample Rate and Resolution	44.1K/48K/96KHz @ 16/24bit
S/PDIF Digital Output	44.1K/48K/96K/192KHz @ 16/24bit, Dolby Digital, DTS, WMA-Pro
ASIO 2.0 Driver Support:	44.1K/48K/96K/192KHz @ 16/24bit
I/O Ports	
Analog Output Jack:	3.50mm mini jack *4 (Front/Side/Center-Subwoofer/Back)
Analog Input Jack:	3.50mm mini jack *1 (Line-In/Mic-In)
Other line-level analog input (for CD-IN/TV Tuner):	Aux-In (4-pin header on the card)
Digital S/PDIF Output	High-bandwidth Optical Connector supports 192KHz/24bit (shared with Back surround output jack) -additional SPDIF-out header for HDMI audio output
Front-Panel Audio Header	Intel HDA front-panel compatible and supports HP jack-detection and automatically switch audio output from back-panel to front
Driver Features	
Operation System	Windows Vista/XP(32/64bit)/MCE2005
DTS® Technologies	DTS® Connect (DTS Interactive Encoder and DTS Neo:PC) for both XP and Vista -DTS Interactive encodes any 3D gaming audio into true-to-live 5.1 DTS Digital Surround sound experience -DTS Neo:PC could expand any stereo music to 7.1 surround sounds
DirectSound3D Game Extensions 2.5 (DS3D GX 2.5)/DirectX	DS3D GX 2.5.0 supports EAX gaming sound effects and DirectSound 3D hardware enhanced functions on Windows Vista. (DirectX/DirectSound 3D compatible)
Smart Volume Normalizer™	Normalizes the volume of all audio sources into a constant level and also enhances your 3D sound listening range and advantages in gaming
VocalFX™	The latest vocal effect technologies for gaming and VoIP, including: - VoiceEX: produces vivid environmental reverberation for your voice in EAX games - ChatEX: emulates different background environment effects when you chat online - Magic Voice: changes your voice pitch to different types (Monster/Cartoon...) for disguising your real voice or just for fun in online chatting
Karaoke Functions	Music Pitch-Shifting, Vocal Cancellation, and Microphone Echo effects with Stereo Mix recording (Wave and Mic-in) for online Karaoke or online DJ applications

(continued on the next page)

FlexBass™	Professional Bass Management/Enhancement system
Xear 3D™ Virtual Speaker Shifter	Adjustable virtual 7.1-speaker positioning
Other Effects	10-band Equalizer/27 Environment Effects
3D Gaming Sound Engines/APIs	Vista: DirectSound3D® GX 2.5, EAX®2.0&1.0, DirectSound® HW, DirectSound SW, A3D®1.0, OpenAL generic modes, 128 3D sounds processing capability XP: DirectSound3D® GX 2.5, EAX®2.0&1.0, DirectSound® HW, DirectSound SW, A3D®1.0, OpenAL generic modes, 128 3D sounds processing capability
Bundled Software	
RMAA 6.0.6	RightMark Audio Analyzer utility for easily test the audio quality of your sound card in PC
Accessories	
Accessories	-Low-profile bracket -S/PDIF TOSLINK optical adaptor

*Specifications are subject to change without notice.

2. Xonar DS card layout

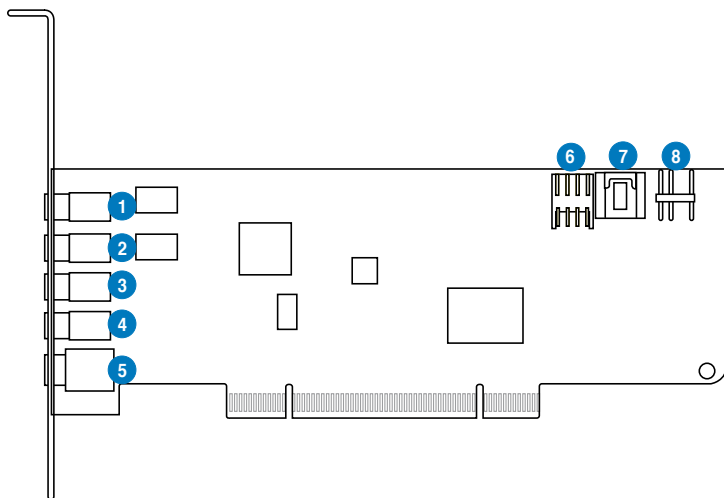

Audio ports

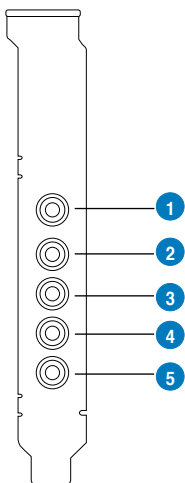

No	Item	Description
1	Microphone In port	Connect your external PC microphone to this 3.5mm port for voice input. Built-in high-quality Microphone pre-amplifier.
1	Line In port	Connect analog devices like MP3 players, CD players, music synthesizers and other line-level sound sources to this 3.5mm port for audio recording or processing. (Through Ultra-high fidelity 102dB SNR A-D converter)
2	Headphone/Front Out port	Connect your headphones or 2/2.1 channel speakers to this 3.5mm port. For multi-channel speaker systems, connects to the front left/right input on the powered speakers.
3	Side Surround Out port	Connects to the surround channel input on 4/4.1/5.1/6.1/7.1 powered analog speakers.
4	Center/Subwoofer Out port	Connects to the center/subwoofer input on 5.1/6.1/7.1 powered analog speakers.
5	Rear/back Surround Out port	Connects to the Back Surround input on 6.1/7.1 powered analog speakers.
5	S/PDIF Out port	Optical TOSLINK digital output port. Connects to external digital decoder or digital speaker systems, Home Theater systems, AV receivers for outputting digital audio including PCM, DTS Digital, DTS, WMA-Pro, etc.
6	Front panel audio header	Intel HDA front-panel compatible and supports HP jack-detection and automatically switch audio output from the back panel to the front panel. Supports both front-panel and sound card mic input mixing
7	Aux Input Header	Usually connects to the Analog Audio output of TV tuner card or other sound source inside your PC system. (To monitor your TV tuner card's audio from this Aux-In, you must enable the "monitor" function for Aux-In in the Xonar DS Audio Center's recording mixer.)
8	S/PDIF Out header	Connects to the graphics card with HDMI support.

3. Installing the hardware

3.1 Installing the audio card



Before you proceed with the following installation steps, it's recommended that you disable your onboard audio device in your BIOS settings, or uninstall any other audio cards on your PC. (For BIOS setting or uninstallation of other sound cards, refer to the user manuals of your motherboard and audio card.)

Installing the Xonar DS card

1. Power OFF the computer, the monitor, and all other peripheral devices connected to your computer.
2. Unplug the computer power cord from your computer and power outlet.
3. Touch the metal back or side panel of the computer to avoid static electricity.
4. Remove the chassis cover.
5. Remove the metal bracket from an available PCI slot for the Xonar DS audio card.
6. Carefully insert the audio card into the PCI slot. Ensure the audio card sits properly in place.
7. Secure the audio card with screws and the metal bracket.
8. Put back the chassis cover.
9. Reconnect all cables.
10. Plug the power cord to the computer and to a power outlet.
11. Power ON the computer.

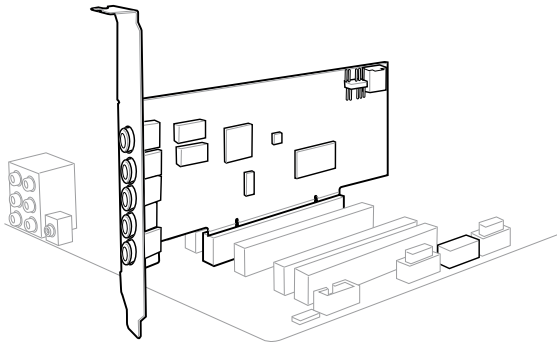

3.2 Connecting to a TV tuner card

1. If you have a traditional PCI or PCI TV tuner card on your PC, you may need to connect it to the Xonar DS card to send the tuner card's sound to your PC speakers.
2. Secure the PCI/PCI TV tuner card and screw it into the back-panel.
3. Connect the audio output header from the TV tuner card to the Aux-In header of the Xonar DS card.



For optimum TV audio quality, Xonar DS uses ADC recording to digitize the signal and loops it back to DAC playback. Select Aux-In as the recording source in the Xonar DS Center's recording mixer and enable the monitoring button to pass this signal to the audio output. Using this setup, you can even turn on sound effects such as Pro-Logic IIx to expand the stereo TV audio to 5.1 or 7.1 channel surround sound. TV audio on your PC will become even better than on your TV set.

4. Installing software

Installing the card driver



Ensure that you have installed the audio card driver before installing the Xonar DS driver. Otherwise, driver installation error may occur.

1. After you have installed the Xonar DS card, turn on your computer. Windows® automatically detects the audio card and searches for device drivers. When prompted for the drivers, click **Cancel**.
2. Insert the support CD into the optical drive. If Autorun is enabled in your system, the setup starts automatically. If not, run **setup.exe** from your support CD.
3. Follow the onscreen instructions to finish the installation.



The version and content of the support CD are subject to change without notice.

5. Connecting speakers and peripherals

5.1 Connecting digital speaker systems (Home Theater)

The Xonar DS supports DTS Interactive technologies, which transcode any audio, including games and music, into industry-standard DTS surround bit-streams. This makes playback through your home theater system possible, creating an immersive and impressive cinema surround sound experience. A single digital cable connection can carry high-quality DTS digital audio from any of your PC audio sources to any digital speakers or AV Receivers with DTS 5.1 decoding capabilities.

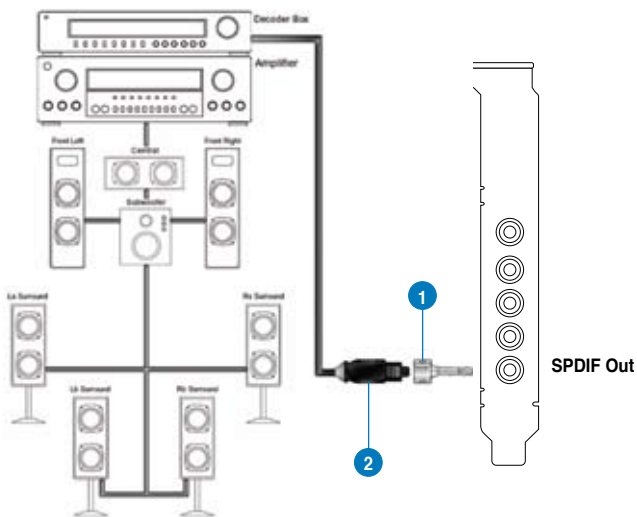

No	Item	Description
1	Optical adapter	Plug the optical TOSLINK adapter into the S/PDIF-Out combo connector.
2	Optical cable	Connect your decoder's S/PDIF-In port to the optical adapter with the TOSLINK optical cable.



You can also use a coaxial cable for a S/PDIF connection. Just plug the coaxial RCA male connector to the S/PDIF-Out combo jack and connect the other end into the coaxial S/PDIF input on your decoder.

5.2 Connecting stereo headphones

5.2.1 Connecting Stereo Headphones

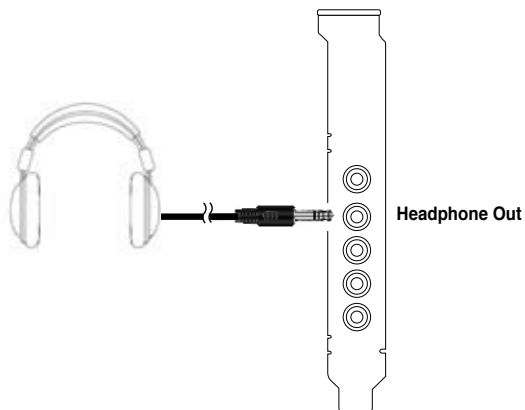

No	Item	Description
1	Front Out/Headphone Jack	The Front Out jack has a built-in high-quality amplifier to drive headphones. Connect your stereo headphones directly to this jack.

5.2.2 Connecting 5.1 channel Headphones

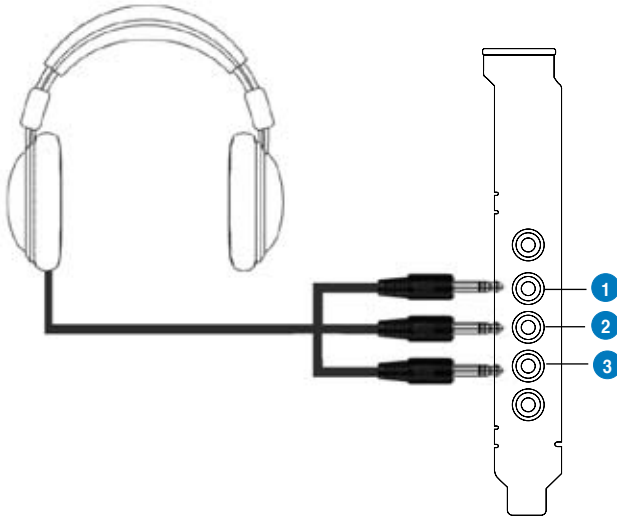

No	Item	Description
1	Front Out	Connect the front-channel 3.5mm plug of your 5.1 headphones into this jack.
2	Side Surround Out	Connect the surround-channel 3.5mm plug of your 5.1 headphone into this jack.
3	Center/Subwoofer Out	Connect the Center/Bass-channel 3.5mm plug of your 5.1 headphone into this jack.

5.3 Connecting Analog Speaker Systems

5.3.1 Connecting Analog Power Amplifier

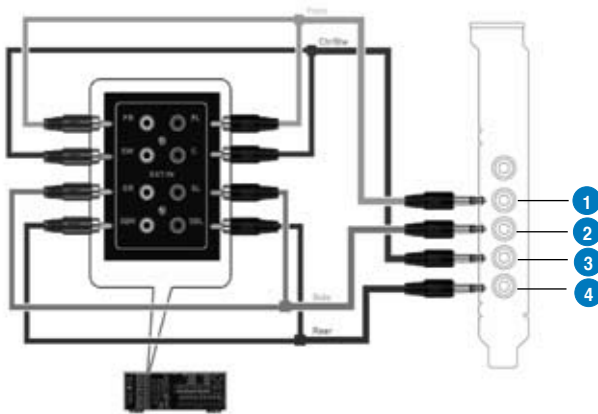

No	Item	Description
1	Front Out	Connects to the "left front" and "right front" input ports of the analog amplifier with the mini-jack to RCA cable.
2	Side Surround Out	Connects to the "left surround" and "right surround" input ports of the analog amplifier with the mini-jack to RCA cable.
3	Center/Subwoofer	Connects to the "Center" and "subwoofer" input ports of the analog amplifier with the mini-jack to RCA cable.
4	Back Surround Out	Connects to the "left back" and "right back" input ports of the analog amplifier with the mini-jack to RCA cable.

5.3.2 Connecting 2/2.1 channel speakers

2 Speakers

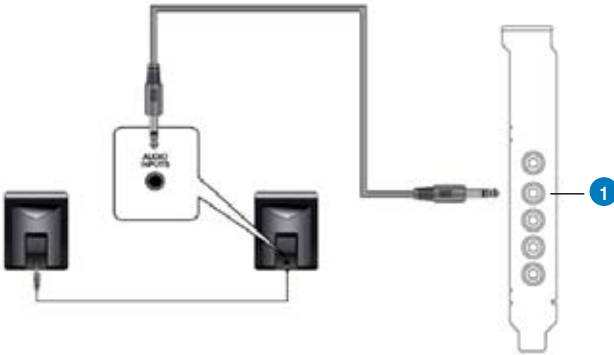

2.1 Speakers

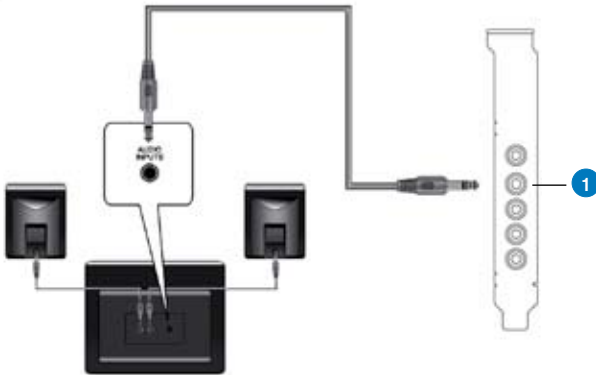

No	Item	Description
1	Front Out/Headphone Jack	Connect the 2/2.1 speaker set's 3.5mm plug into this Front Out jack.

5.3.3 Connecting 4/4.1 Channel Speakers

4 Speakers

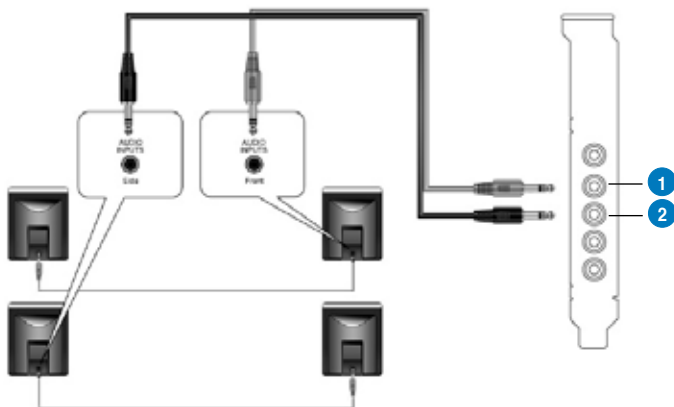

4.1 Speakers

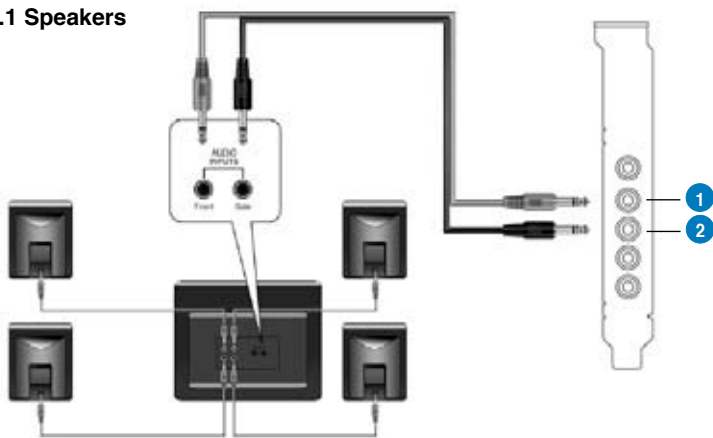

No	Item	Description
1	Front Out	Connects to the Front input port of the 4/4.1 speakers with the mini-jack cable.
2	Side Surround Out	Connects to the Surround input port of the 4/4.1 speakers with the mini-jack cable.

5.3.4 Connecting 5.1 Channel Speakers

5.1 Speakers

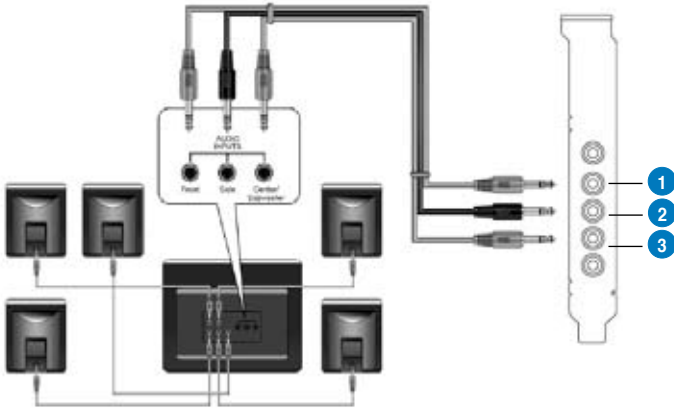

No	Item	Description
1	Front Out	Connects to the Front input port of the 5.1 speakers with the mini-jack cable.
2	Side Surround Out	Connects to the Surround input port of the 5.1 speakers with the mini-jack cable.
3	Center/Subwoofer	Connects to the Center/Subwoofer input port of the 5.1 speakers with the mini-jack cable..

5.3.5 Connecting 6.1/7.1 Channel Speakers

6.1 Speakers

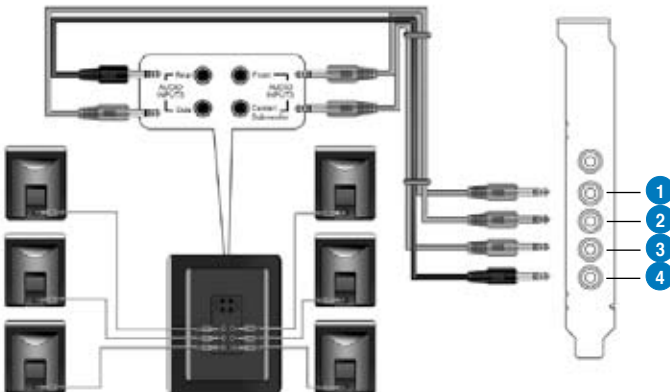

7.1 Speakers

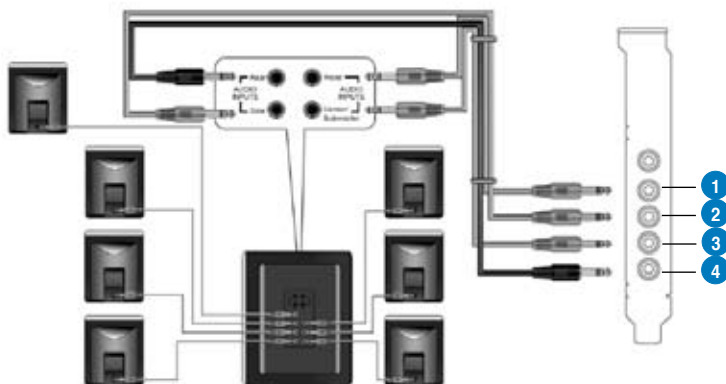

No	Item	Description
1	Front Out	Connects to the Front input port of the 6.1/7.1 speakers with the mini-jack cable.
2	Side Surround Out	Connects to the Surround input port of the 6.1/7.1 speakers with the mini-jack cable.
3	Center/Subwoofer	Connects to the Center/Subwoofer input port of the 6.1/7.1 speakers with the mini-jack cable.
4	Back Surround Out	Connects to the Back Surround input port of the 6.1/7.1 speakers with the mini-jack cable.

5.4 Connecting microphone

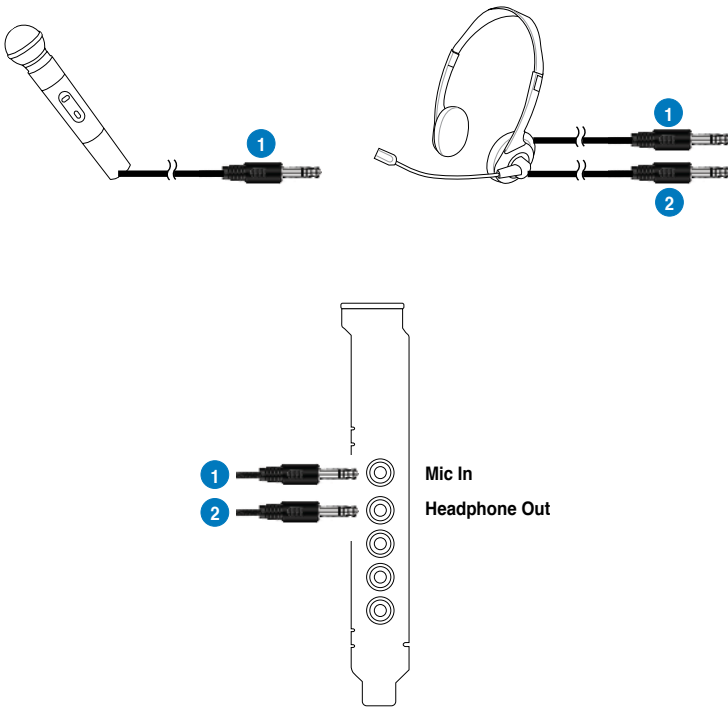

No	Item	Description
1	Microphone Input Jack	Connect the microphone's 3.5mm plug into this Mic-In jack for voice communication, recording, or karaoke.
2	Headphone Jack	The Front Out jack has a built-in high-quality amplifier to drive headphones. Connect your stereo headphones directly to this jack.

5.5 Connecting Line-In audio sources

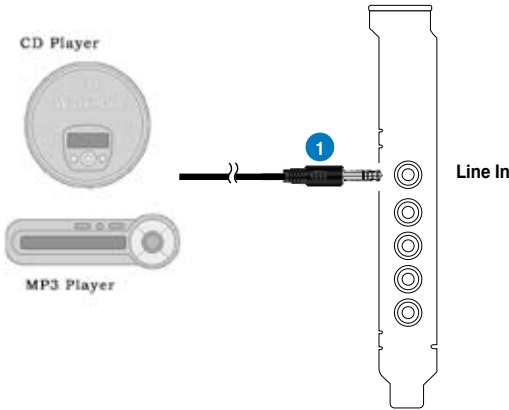

No	Item	Description
1	Line Input Jack	Connect the 3.5mm plug of the CD/MP3 Player or any other Line level analog audio sources into this Line-In jack for sound recording or real-time Dolby sound processing through the Monitoring path (See the "Mixer" section of the driver guide).

6. Xonar Audio Center

6.1 Xonar Audio Center GUI

1. After the driver installation is complete and your computer has been rebooted, you will find the Xonar Audio Center's icon in the system tray on the bottom right-hand corner of the screen. Double click this icon to open the Xonar Audio Center utility.



If the icon could not be found in the system tray, launch the Xonar Audio Center from the Windows desktop by clicking **Start > All Programs > ASUS Xonar DS Audio > Xonar DS Audio Center**.

2. The Xonar Audio Center is the Graphic User Interface (GUI) for the Xonar DS driver. You can control the functions and features of the Xonar DS driver on the Xonar Audio Center. The following picture shows a basic overview of the Xonar Audio Center. The following sections of this manual will describe its functions in more detail.



No	Item	Description
1	Support link	Clicking this button will lead you to the ASUS official website.
2	Display Area	This display area shows the 10-band signal meter, volume level, and the status of the Dolby/DTS technologies, EQ, and DSP modes. Note: this area just displays information, but is not used to alter settings.
3	Setting Menu Panel	This panel gives access to setting tabs, including Main Settings, Mixer/volume, Effects, Karaoke, FlexBass, and VocalFX.
4	Information icon	Clicking this icon will pop up driver's Information window.
5	Menu Open/Close	Clicking this button will move the display area and reveal the configuration area below. Clicking it again will move the display area back down.
6	Master Volume	This rotary knob controls the master playback volume. Drag the small circle inside it to change the volume level.
7	Mute Button	Click this button to mute audio playback; it will display a red light when playback is muted.
8	SVN Button	Click this button to enable the "Smart Volume Normalization" feature for constant volume from all playback sources. It will display a blue light when enabled.
9	DSP Mode	These 2 buttons give access to quick gaming surround sound effect (GX2.5) and effect-free (Hi-Fi) modes.

6.2 Main Setting

6.2.1 Sample Rate

The sample rate determines the number of audio samples per second that the Digital-to-Analog Converters (DAC) and S/PDIF digital interface will output. The Xonar DS card can support sample rates up to 192KHz (44.1K, 48K, 96K, 192KHz). Usually audio CDs and MP3 files are 44.1KHz; DVD-Video uses 48KHz; DVD-Audio or other HD media may contain 96KHz or 192KHz high-definition audio content. Please select the corresponding sample rate for your playback sources to get the best audio fidelity. Even if your setting differs from the audio source's sample rate, the Xonar DS engine will do super high fidelity sample-rate-conversion with a double floating-point filter, which can reduce total harmonic distortion (THD+N) by -140dB.

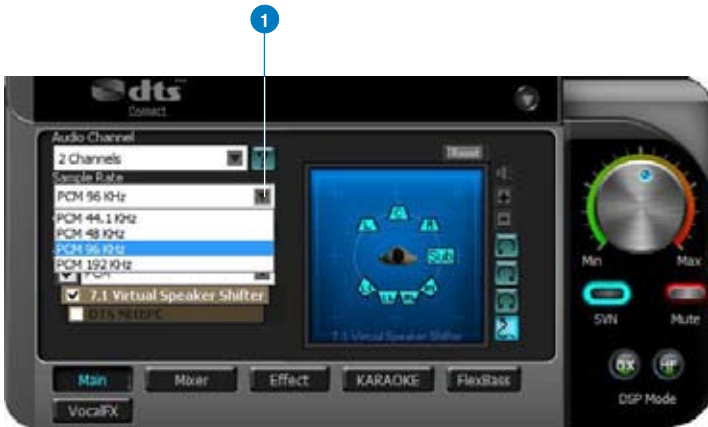

No	Item	Description
1	Sample Rate	Select the sample rate that corresponds to (or exceeds that of) your playback sources, for optimal audio fidelity. The Xonar DS card supports sample rates up to 192KHz (44.1K, 48K, 96K, 192KHz). Typical values: -Audio CD, MP3, WMA, Wave files are 44.1KHz; -The audio of DVD-Video is 48KHz; -DVD-Audio or other HD media may contain 96KHz or 192KHz high-definition audio content.

6.2.2 Analog Out mode

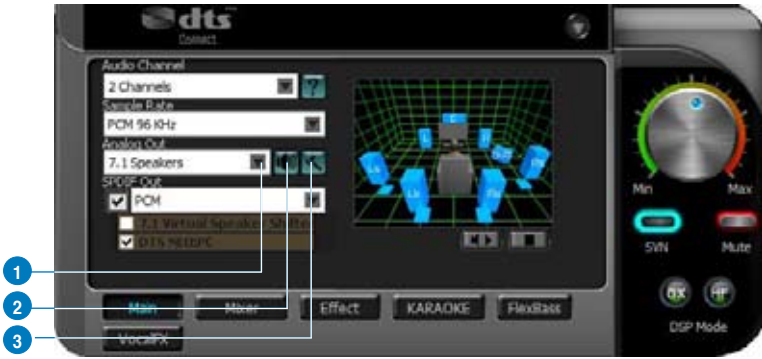

No	Item	Description
1	Analog Out	The Analog Out setting is used to match your actual speaker setting, such as headphones, 2 speakers (or 2.1), 4 speakers (or 4.1), 5.1 speakers, 7.1 speakers, Front Panel Headphone and Front Panel 2 speakers (or 2.1). Xonar DS will play the channels and do the proper 3D/DTS sound processing accordingly. Select the correct speaker type for your connected speakers.
2	Speaker Test	Click this button to show the speaker test window in the right pane. Click the “play” button to test each speaker one by one or click each speaker manually to test.
3	HP Advanced Setting	Clicking this button will pop up an advanced setting window to allow you to: <ul style="list-style-type: none"> – Swap center/bass outputs for 5.1/7.1-speaker set ups – Swap Side/Back Surround outputs for 7.1-speaker set ups Check the box if your speakers are outputting the incorrect channel. Otherwise, leave them blank. <div style="text-align: center;"> </div>

6.2.3 SPDIF Out / DTS Interactive

Xonar DS is capable of outputting DTS Interactive, which are real-time encoders that transcode any audio, including games and music, into industry-standard DTS Digital bit-streams on-the-fly. This is ideal for playback through a home theater system, creating an immersive and impressive cinema surround sound experience. It enables a single digital connection to carry high quality DTS surround audio from your PC to digital speakers and AV Receivers.

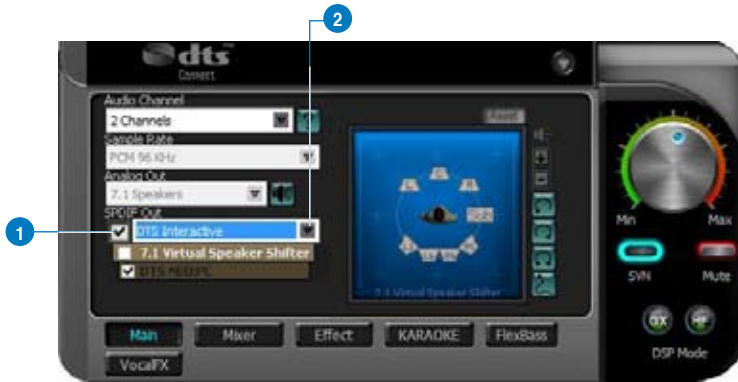

No	Item	Description
1	S/PDIF Out enable/disable	Click this check box to enable S/PDIF output.
2	S/PDIF Output Formats/Functions	This pull-down menu allows you to select one of the following four formats: -PCM (Pulse Code Modulation, which is a typical raw audio data format.) -DTS Interactive, real-time 5.1ch encoding

6.2.5 7.1 Virtual Speaker Shifter

The 7.1 Virtual Speaker Shifter has the following major features:

- Expanding/upmixing audio to 7.1-channel surround sound
- Virtualizing 7.1 surround sound over any set of speakers
- Shiftable virtual speaker positioning allows you to adjust the best sound field easily without moving physical speakers and wires

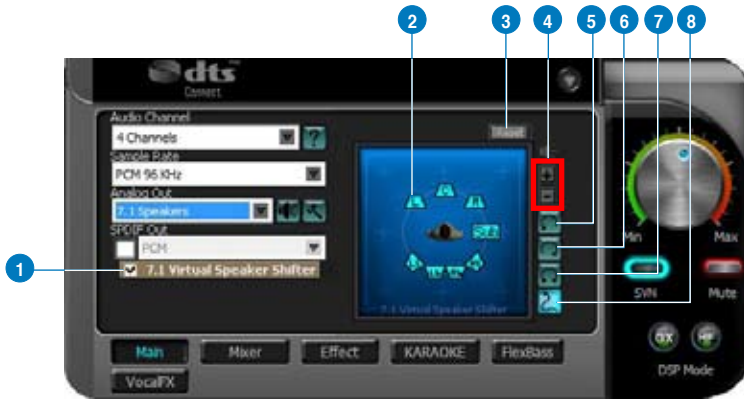

No	Item	Description
1	Shifter enable/disable	Click this check box to enable the 7.1 Virtual Speaker Shifter. Clicking the text bar will switch the right window to the Speaker Shifter page for manual adjustments. <i>Note: The setting will remain when a different Analog Output is selected.</i>
2	Drag speaker or listener	You can drag each speaker or listener to a different relative position “virtually” using only your mouse. The Xonar DS card will process it and virtualize each speaker position in real-time. The Subwoofer has no directional sounds, and hence can be moved only closer or further away.
3	Reset	Reset all Speaker Shifter settings to the defaults.
4	Increase/decrease volume	Click + to increase volume (move speakers closer); click – to decrease volume (move speakers further away)
5	Counter-clockwise	Make all speakers (except Subwoofer) rotate counter-clockwise
6	Clockwise	Make all speakers (except Subwoofer) rotate clockwise
7	Manual Rotation	Manually drag and rotate all speakers (except Subwoofer)
8	Manual Drag Mode	This is the default mode that allows you to manually drag each speaker or the listener with your mouse.

6.2.6 DTS Neo:PC

DTS Neo:PC is a 7.1 surround upmixing technology and is widely used in home theater systems, TVs, game consoles, and car audio systems. It can expand stereo audio, such as MP3, CD, and TV programs into immersive 5.1 or 7.1-channel surround.

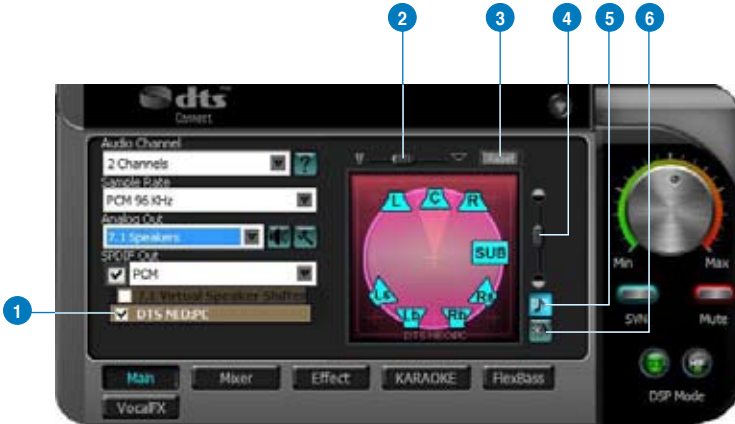

No	Item	Description
1	DTS Neo:PC enable/disable	Click this check box to enable DTS Neo:PC. Clicking the text bar will switch the right window to the Pro-Logic IIx page for manual adjustments.
2	Center Width	This parameter is used to set the spread of the center, mainly for the vocal signals of songs and music. Drag the scroll bar to the left to centralize the vocal signal. Drag to the right side to widen the vocal sound range.
3	Reset	Reset all settings to the defaults.
4	Dimension	The dimension parameter fades sounds to the front or rear of the listener.
5	Music Mode	Music mode is the default mode for regular music playback. In this mode, you can adjust the Center Width and Dimension parameters.
6	Movie Mode	Movie mode is a preset optimized for movie audio.

6.3 Mixer/Volume

The mixer page is designed to control the volume for playback and recording on the Xonar DS. In addition, the Xonar DS also provides a high-quality digital monitoring function for hearing the recorded audio from the speakers. You can also process the input signals with all playback sound effects such as DTS technology.

6.3.1 Playback Volume

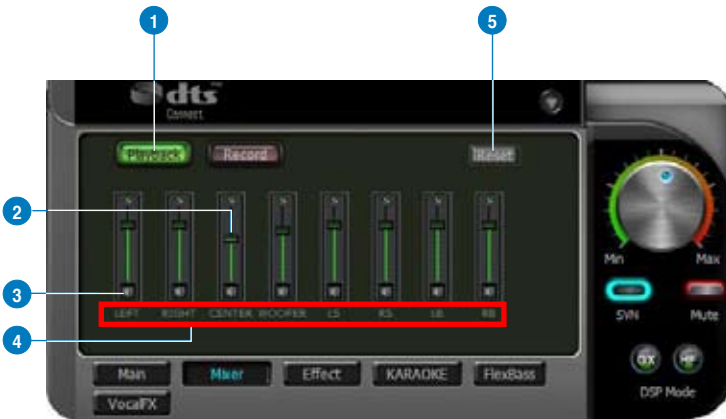

No	Item	Description
1	Playback volume tab	Click this button to show the playback volume page.
2	Volume slider	Drag this slider down to decrease the volume; drag it up to increase the volume. The tool-tip reveals the percentage number from 1 to 100 in terms of the full scale level.
3	Mute button	Click this button to mute the audio channel; click this button again to restore the audio output.
4	Source / path name	This shows the source name for each volume control slider, including: <ul style="list-style-type: none"> - WAVE: All digital audio sources except MIDI files - SW: Software Synthesizer; control the playback volume of the MIDI files - CD: CD-ROM digital playback (CD-DA) volume control - LEFT, RIGHT...: the volume control for each speaker/channel <p><i>NOTE: Windows® Vista does not support WAVE, Synthesizer and CD-In volume controls.</i></p>
5	Reset	Reset all volume controls to the default settings

6.3.2 Recording/Monitoring Volume

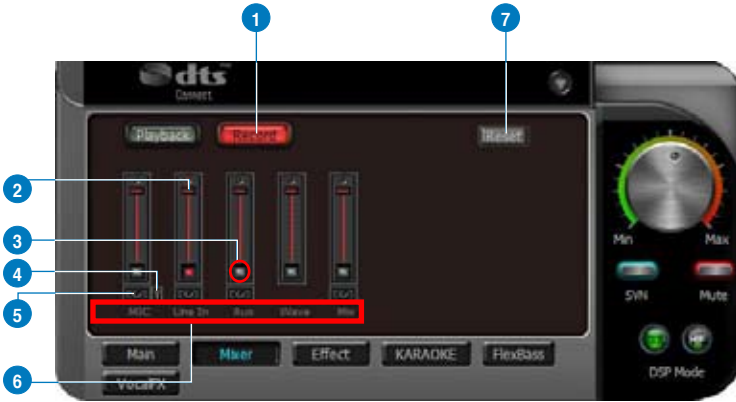

No	Item	Description
1	Recording Volume Tab	Click this button to show the recording volume page.
2	Recording volume slider	Drag this slider down to decrease the recording volume; drag up to increase the recording volume. The tool-tip reveals the percentage number from 1 to 100 in terms of the full scale level.
3	Recording Selector button	Click this button to select the path/source you are going to record. Note that the recording function on Windows is a one-path selector. So, you can select only one default recording source at a time. You may have to restart the recorder program if you switch to a different source. (Note: On Vista, some application programs may allow you to select the recording device/path in the recording programs themselves.)
4	Microphone-In Advanced Setting	Click this button  to open the advanced settings for the Microphone-In: <div data-bbox="391 1114 599 1225" style="border: 1px solid gray; padding: 5px; margin: 10px 0;"> <p>Advanced Setting</p> <p><input checked="" type="checkbox"/> Front Panel Microphone</p> <p><input type="checkbox"/> Microphone Boost</p> <p>OK</p> </div> <p>Enabling “Microphone Boost” will increase a volume gain to boost microphone input signals. If you connect your microphone to the front panel audio module, enable “Front Panel Microphone”. For typical low-cost PC microphone, it’s recommended to enable this function.</p>

(continued on the next page)

5	Monitoring button	Click this button to monitor and loopback recording audio to outputs (PC speakers). Therefore, the recording volume will influence the monitoring signals from speaker outputs. The audio will be mixed into the streams you are playing out from your PC and all DSP effects will be applied to the source, too. A typical benefit is to apply DTS Neo:PC 7.1-ch spreading for your TV audio, CD, MP3, or stereo game console audio from Wii, Xbox, PS2/PS3/PSP, etc.
6	Source / path name	<p>This shows the source name for each volume control slider, including:</p> <p>S/PDIF-In: S/PDIF digital input source</p> <p>MIC: recording from MIC jack</p> <p>Mix: Stereo Mix which will record MIC, AUX, and digital WAVE audio you are playing on PC</p> <p>Aux: recording from Aux-In for typically TV-tuner card audio or other sound sources</p> <p>Line-In: recording from Line-in jack for external audio devices</p> <p>WAVE: recording from digital wave audio you are playing on PC</p>
7	Reset	Click to reset all volume controls to the default settings.

6.4 Effects

6.4.1 Environment Effects

Environment effects can be used to create realistic listening experiences that mimic different environments. There are a total of 27 environment options, which can be applied to all 2D sound sources, like music.



No	Item	Description
1	Default environments	These four buttons activate Bathroom, Concert hall, Underwater, and Music Pub environments, respectively.
2	More options	Clicking this button will apply the environment effect that you select from the pull-down menu on the right side. There are another 23 options in this menu.
3	Environment size	There are three size settings for each environment: Large, Medium, and Small.

6.4.2 10-Band Equalizer

The equalizer can modify the audio output for different frequencies, and be used to compensate for deficiencies in your speakers/systems. There are 12 default patterns and you can also make your own settings.

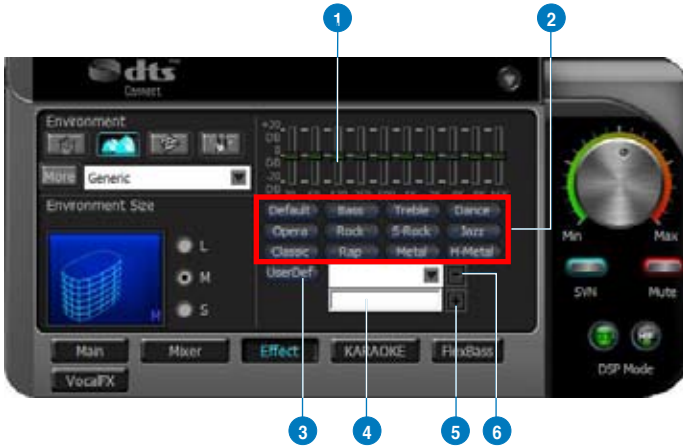

No	Item	Description
1	Default equalizer options	There are 12 available equalizer patterns. Click one to apply it.
2	Equalier slider	Adjust the gain for each band (30~16KHz)
3	User Defined	You can click this button to apply your own defined parameters saved in the pull-down menu.
4	Save name	Key in a name for your own "User Defined" equalizer setting
5	Add / save	Click this "+" button to save the parameters into User Defined list
6	Delete	Click this "-" button to delete the parameters from User Defined list

6.5 Karaoke

The Xonar DS provides powerful features for Karaoke, including Key-Shifting, Vocal Cancellation, and Microphone Echo. Microphone Echo can generate natural echo effects on your singing voice just like a karaoke machine. Key-Shifting can change the pitch of Karaoke background music, and Vocal Cancellation can reduce the original vocal in songs and keep the music and symphony for karaoke.



No	Item	Description
1	On/Off	Click the switch to turn on or off the functions on this page.
2	Key-Shifting	Check the box to enable or disable the key shifting feature for music playback from 4 semitones below, to 4 semitones above.
3	Vocal Cancellation	Check the box to enable or disable the vocal cancellation function and adjust the voice cancellation level from 0 to +100. +100 will eliminate most original vocals (default value is 50).
4	Mic Echo	Select the Mic Echo function and adjust the gain for echo signals (30~16KHz)
5	Reset	Reset all settings to the default.



The following message appears when Mic Echo is selected:



This message implies that the recording device will be set according to your requirement. With Mic, you will only record audio source from microphone with echo effects; but you are able to record all audio sources from Wave, Aux, and Mic with microphone echo effect. Click **OK** to accept it or **Cancel** if you want to enable it later. Checking **Don't remind me again** and this message will not show up again.

6.6 FlexBass

FlexBass, an advanced bass management and enhancement mechanism, allows you to select each satellite speaker's type for optimal sound performance from the speakers. (Small: common speaker that cannot produce low frequencies; Large: wide-band speakers that can produce low frequencies well). It comes with an adjustable crossover frequency for the boundary of the bass signals. FlexBass will filter out the bass signals from small speaker channels and redirect them all to the subwoofer or Large speakers.

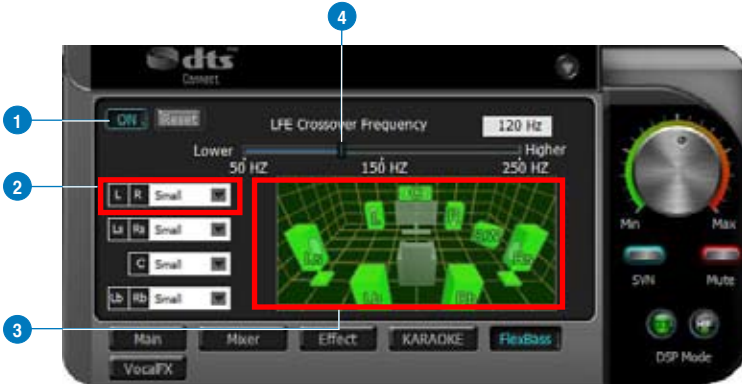

No	Item	Description
1	On/Off	Click this switch to turn on or off all functions on this FlexBass page.
2	Small / Large speaker option	<p>Select the speaker type that you connected. If your speaker type cannot perform low-frequency signals (bass), select "Small" speaker type and Xonar DS will filter out the bass signals and send them to the subwoofer channel. If those speakers are full-range, you can select the "Large" speaker type.</p> <p>Note: Usually, low-cost PC's 2-channel speakers are small-type speakers. Refer to the speaker's specification. If you have any questions, consult your speaker vendor. However, common 2.1 speakers with a subwoofer should be categorized as Large speakers because the subwoofer can redirect the bass signals inside the two channels to the subwoofer speaker automatically.</p>
3	Picture for Small/ Large speaker	<p>Colors for small/large speakers are different.</p> <p>Orange: large speakers</p> <p>Green: small speakers</p>

4

**LFE Crossover
Frequency**

Adjusts the cut-off frequency (50~250Hz) for LFE (low-frequency effects) signals. Xonar DS will filter out the bass signals below the crossover frequency from small speaker channels and forward them to the subwoofer. The higher the crossover frequency, the more bass signals will be subtracted.

6.7 Smart Volume Normalization

Smart Volume Normalization™ (SVN) automatically keeps all music or video/TV audio output at a constant level to reduce manual adjustment hassles inherent with sound sources of different loudness. It allows you to listen to various content, like MP3, TV program, DVD video and even games with consistent sound level. The following graph shows how different signals 1 & 2 will become the same level (for example, 10dB below full scale) after you turn on SVN. Please note that for lower volume music 2, it will become louder when you turn on SVN; and for higher volume music 1, it will become quieter.

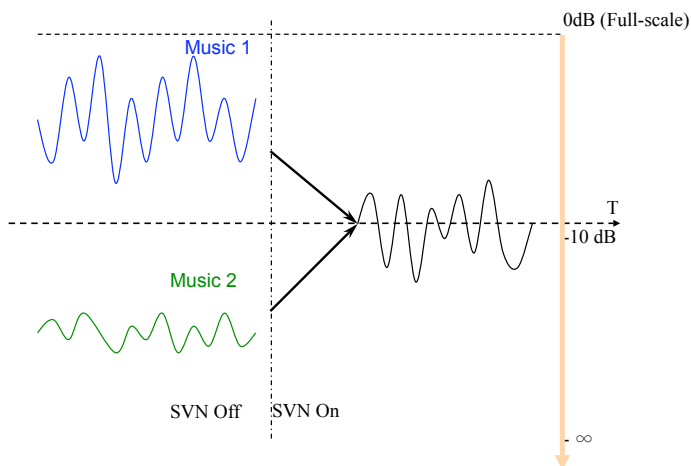



No	Item	Description
1	SVN On/Off	Click this button to enable SVN. This button is outlined blue when active.
2	SVN blue light	When SVN is enabled, the master volume knob will be illuminated by a blue light. It will be lit red if the volume is muted.
3	SVN display	When SVN is enabled, "Smart Volume" will be lit up at the bottom of the volume meter and the volume meter will show the level.

6.8 DS3D GX and DSP Modes

Xonar DS is introducing an innovative technology –DirectSound 3D Game Extensions v2.5 (DS3D GX 2.5)- to restore DirectSound 3D Hardware acceleration mode and its subsidiary EAX effects on Windows Vista for 3D games. Unlike some proprietary API like OpenAL, DS3D GX doesn't require games to support OpenAL API. All existing games compatible with Microsoft DirectX and DirectSound 2D/3D will be supported with DS3D GX technology. Before you start EAX and DS3D HW games, enable DS3D GX on the Xonar Audio Center, and disable the function after the games.

In addition, Xonar DS also offers a Hi-Fi mode for hi-fidelity playback without any effect processing to keep the original audio fidelity. Every time you turn on Hi-Fi mode, Xonar DS will clear all sound effects. It's also recommended to use Hi-Fi mode for audio quality tests (using RMAA software or another machine-based measurement). Use the DSP mode button as the quick setup if you don't wish to know the details of the effect setup.



No sound effects will be applied to high-definition 96KHz/192KHz content.



No	Item	Description
1	GX Mode	DirectSound 3D Game Extensions mode to support EAX and DirectSound 3D Hardware extensions for lots of DirectX/ DirectSound3D games on Windows Vista and XP.
2	Hi-Fi Mode	This mode is set for Hi-Fidelity playback, where all effects will be cleared to keep the original digital data and analog output quality as high as possible.

6.9 VocalFX

VocalFX is an innovative voice processing technology to let your voice get into the realistic game landscape (VoiceEX) or to emulate the background scenes in online chat (ChatEX). It also allows you to change your voice pitch to disguise who you are (Magic Voice). These features dramatically increase the fun for voice communication on PC.

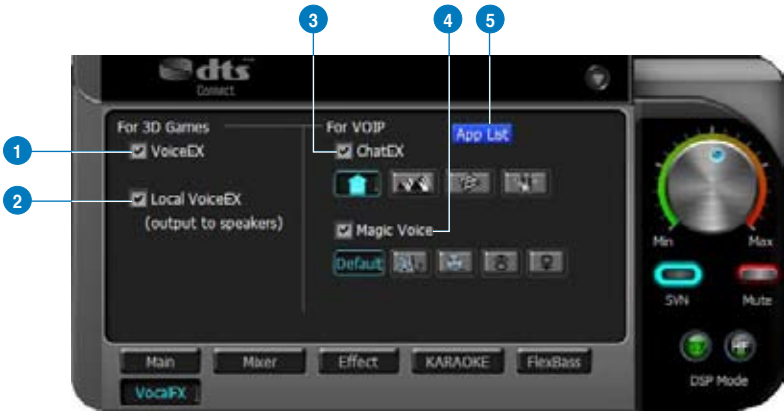

No	Item	Description
1	VoiceEX	It produces realistic and dynamic environmental reverberation for your voice in 3D gaming communication.
2	Local VoiceEX	It produces realistic and dynamic environmental reverberation for your voice in 3D gaming communication. (You can hear your voice form speakers)
3	ChatEX	It emulates different background environment effects when you chat online.
4	Magic Voice	Changes your voice pitch to different types for disguising your real voice or just for fun in online chatting.
5	App List	You can add VOIP application into VOIP application List.

For 3D Games

1. Check the check box of VoiceEX and Local VoiceEX.
2. Make sure you and your team member can talk to each other in the game.

For VOIP

1. Press App List
2. If you don't see the VOIP application of yours in the list, press Add.(Make sure the Skype and MSN Messenger are the latest version)

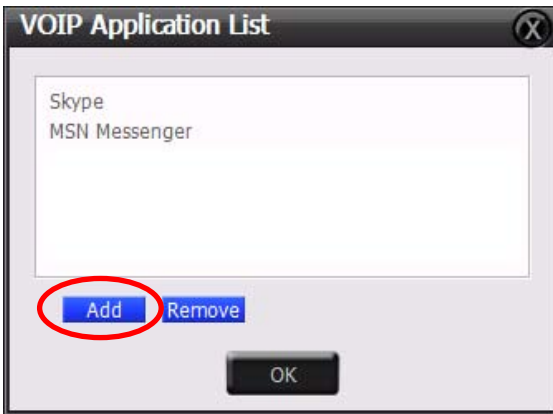

3. Look for the application's location and Open it.

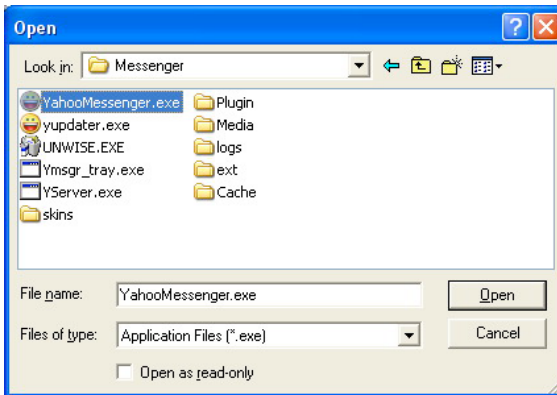

4. Your VOIP application has been added into list.

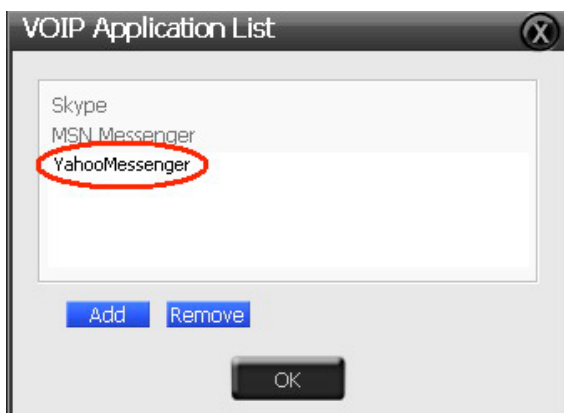

5. Check the check box of ChatEX and Magic Voice.
6. You can use ChatEX and Magic Voice when you chat online.



Click the checkbox to enable VocalFX function, then a prompt message will pop up:

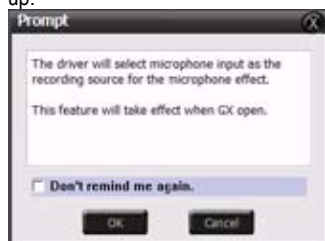

This message implies the record device will be set to microphone. Make sure the GX function is enabled. Click "OK" to accept it, or "Cancel" if you want to enable it later. Check "Don't remind me again" if you don't want to see this message pop up next time.

7. Troubleshooting and FAQs

[Troubleshooting]

The audio card driver could not be installed on my PC.

Instructions:

1. Make sure that you have properly plugged the audio card in the PCI slot on your motherboard.
2. Check that the Windows hardware device manager has discovered a multimedia audio device. If no device is found, please try scanning for new hardware.
3. Try soft reboot (restart) your Windows.
4. Remove the card, plug it into another PCI slot, and try again.

I cannot find the Xonar DS Audio Center

Instructions:

1. Make sure you have installed the driver
2. Locate the Xonar DS Audio Center icon in the system tray on the bottom right-hand corner of the screen. Double-click the icon to open the Xonar DS Audio Center utility.



3. If the icon could not be found in the system tray, go to the Windows Control Panel and double click the “Xonar DS Audio Center” icon to make it visible in the system tray again.
4. After the driver installation is complete, it's recommended that you reboot your computer to complete the setup. If the icon still doesn't appear, please try installing the driver package again.

I cannot hear any sound from my analog speakers

Instructions:

1. Xonar DS card needs the power cable to supply addition power in addition to the basic PCI bus power. Double check you have plugged the small 4-pin power plug onto Xonar DS power connector. If you did not plug the internal power, Xonar DS Audio Center will remind you a warning message and will not allow your operation when you double-click Xonar DS Audio Center icon in the system tray.
2. Ensure that you have connected speakers properly and have powered on your speakers.
3. Ensure that the device master volume or the software player has NOT been muted on the Xonar DS Audio Center.

4. If you are using DTS encoder through the S/PDIF output, the analog output will be muted to get rid of the interference between your digital speaker system and analog speakers or headphones. Check if this is the case.
5. Go to the sound and audio device of Windows Control Panel to check if the playback default device is set to Xonar DS Audio Device, instead of other onboard AC97 or HDA codec device. If it's not, please set it to Xonar DS Audio Device and restart your applications.
6. Try restarting your Windows.

I cannot hear any sound from the S/PDIF output

Instructions:

1. Ensure that you have enabled S/PDIF output in the Audio Center GUI (Main page).
2. Ensure that you are connecting the correct S/PDIF output jack on the card to the decoder's (AV receiver) S/PDIF input jack.
3. You may need to select the correct input and mode of your decoder or AV receiver. For DTS output, you may have to double check that the AV receiver is in that decoding mode.
4. If you are using 192KHz PCM output, please make sure your decoder can support 192KHz decoding. Try changing it to 44.1K or 48KHz first.

I cannot hear audio input (Mic, Line-in, AUX, etc.) from my speakers

Instructions:

1. Go to the mixer recording page in the Audio Center and select the correct input as the recording source. If you are using Windows Vista, also go to system audio control panel to see the current default recording/input device is right.
2. Remember to turn on the digital monitoring button for that recording source.

I cannot hear the TV tuner audio from my speakers

Instructions:

1. If you are using a traditional TV tuner card which has analog audio output, please connect it to the Aux-In header on the audio card
2. Select Aux-In as the recording source and remember to turn on the digital monitoring button on the recording mixer page
3. If you are using a TV tuner card which has digital audio output instead of analog, check that the sound is not muted and whether other applications can play sound out. If you still have problem, read the TV tuner card's software user guide.

[FAQ]

Q1: Does the Xonar DS support Windows Vista?

Answer:

Yes, the Xonar DS driver package does support Windows Vista 32/64 bit and most key features are available. In addition, Xonar DS supports unique DS3D GX on Windows Vista, which can recover DirectSound 3D hardware and EAX gaming sound effects on Vista for a lot of existing DirectX games.

Q2: Why does the Xonar DS support DTS technology?

Answer:

DTS is the well-known brand and technology recognized by the CE industry and available on a wide range of audio equipment. Moreover, DTS Digital Surround 5.1 audio could deliver more high-quality sound even than Dolby Digital does. Xonar includes these features to make your PC a powerful media and entertainment center.

Q3: Why is Xonar DS the best audio card for HTPC and multi-channel speakers?

Answer:

The Xonar DS supports DTS Interactive, which allow a single digital connection to your AV receiver to carry DTS Digital Surround audio. In addition, Xonar DS also provides DTS Neo:PC to upmix TV and other music to multi-channel surround sound in Home Theater environments. Xonar DS also has High Fidelity SNR at 192K/24bit, which is the only high quality consumer audio card in the world. Therefore, it's also the best card to deliver the high quality audio through an analog connection to your home theater system or high-end multi-channel speakers.

Q4: Does the Xonar DS support EAX on Vista?

Answer:

Yes, Xonar DS can support EAX2.0 not only on Windows XP but also on Vista through innovative DirectSound3D Game EXtensions v2.5 (DS3D GX 2.5) technology.

Q5: Why do I need DTS for PC games?

Answer:

DTS Interactive and Neo:PC are available on the latest game consoles, like XBOX360, and PS3. DTS can provide the best gaming sound experience and compatibility with home theater or TV systems.

Q6: What is the most important benefit of the Xonar DS for musicians?

Answer:

1. Ultimate Fidelity: Xonar DS has the highest quality of audio in/out for the cleanest sound production.
2. Duplex HD: Supports audio sampling rates up to 24bit/192KHz for outputs and 24bit/96KHz for inputs.
3. ASIO 2.0: Xonar DS includes an ASIO 2.0 driver for low-latency, low-distortion music creation application.

Q7: Will PCM sound output through S/PDIF be just 2 channels even with different analog output channels?

Answer:

The S/PDIF protocol specification (IEC-60958) can only carry 2-channel PCM data or non-PCM AC3/DTS data. So, when a user selects PCM output for S/PDIF, the Xonar sound card will always deliver 2 channel PCM data through the S/PDIF output port. For attaining 5.1 channel surround sounds, you can select DTS Interactive encoding output from the S/PDIF out menu, which will allow the Xonar DS to deliver upto 7.1 surround sound for games, DVD movies, and even stereo music.

Q8: Why can I hear and record sound from other recording devices when Wave/Digital is selected in Record on Vista?

Answer:

Different from Windows XP, Vista has a multiple devices/streams concept in audio structure, in which the concept can be categorized into Digital Input and Analog Input. In other words, multiple recording devices can be used and working at the same time. In this case, Wave In or SPDIF-In, considered as a Digital Input, is an independent recording device from Analog Devices such as Mic In, Line In, or Aux In. Therefore, if you have analog inputs other than Wave In and set to be monitored, you are able to hear and even record sound from those analog devices even Wave In / SPDIF-In is selected as the default recording device.

If you don't want to hear the analog input sounds at that situation, simply turn off "monitoring" function on other analog input devices.

Q9: Why do I found no sound effects when playing 96K or 192KHz sound sources.

Answer:

Currently Xonar DS effects including DTS support common 44.1K, 48KHz sound sources processing and will assure high-definition audio (96K/192KHz) in hi-fidelity playback. This is also usually the behavior that professional audiophiles and musicians prefer.

If you still want to have the effects, you can use some editing software (Ableton Live, Cakewalk, CoolEdit, Soundforge, etc.) to convert the sounds into 48KHz files. Please note that the frequency meter on Xonar DS Audio Center panel will not take effect either when the playback source is 96KHz or 192KHz sample rate to prevent any processing distortion.

Free Manuals Download Website

<http://myh66.com>

<http://usermanuals.us>

<http://www.somanuals.com>

<http://www.4manuals.cc>

<http://www.manual-lib.com>

<http://www.404manual.com>

<http://www.luxmanual.com>

<http://aubethermostatmanual.com>

Golf course search by state

<http://golfingnear.com>

Email search by domain

<http://emailbydomain.com>

Auto manuals search

<http://auto.somanuals.com>

TV manuals search

<http://tv.somanuals.com>