

M3A78-EM

ASUS®

Motherboard

E3861

First Edition V1

May 2008

Copyright © 2008 ASUSTeK COMPUTER INC. All Rights Reserved.

No part of this manual, including the products and software described in it, may be reproduced, transmitted, transcribed, stored in a retrieval system, or translated into any language in any form or by any means, except documentation kept by the purchaser for backup purposes, without the express written permission of ASUSTeK COMPUTER INC. ("ASUS").

Product warranty or service will not be extended if: (1) the product is repaired, modified or altered, unless such repair, modification or alteration is authorized in writing by ASUS; or (2) the serial number of the product is defaced or missing.

ASUS PROVIDES THIS MANUAL "AS IS" WITHOUT WARRANTY OF ANY KIND, EITHER EXPRESS OR IMPLIED, INCLUDING BUT NOT LIMITED TO THE IMPLIED WARRANTIES OR CONDITIONS OF MERCHANTABILITY OR FITNESS FOR A PARTICULAR PURPOSE. IN NO EVENT SHALL ASUS, ITS DIRECTORS, OFFICERS, EMPLOYEES OR AGENTS BE LIABLE FOR ANY INDIRECT, SPECIAL, INCIDENTAL, OR CONSEQUENTIAL DAMAGES (INCLUDING DAMAGES FOR LOSS OF PROFITS, LOSS OF BUSINESS, LOSS OF USE OR DATA, INTERRUPTION OF BUSINESS AND THE LIKE), EVEN IF ASUS HAS BEEN ADVISED OF THE POSSIBILITY OF SUCH DAMAGES ARISING FROM ANY DEFECT OR ERROR IN THIS MANUAL OR PRODUCT.

SPECIFICATIONS AND INFORMATION CONTAINED IN THIS MANUAL ARE FURNISHED FOR INFORMATIONAL USE ONLY, AND ARE SUBJECT TO CHANGE AT ANY TIME WITHOUT NOTICE, AND SHOULD NOT BE CONSTRUED AS A COMMITMENT BY ASUS. ASUS ASSUMES NO RESPONSIBILITY OR LIABILITY FOR ANY ERRORS OR INACCURACIES THAT MAY APPEAR IN THIS MANUAL, INCLUDING THE PRODUCTS AND SOFTWARE DESCRIBED IN IT.

Products and corporate names appearing in this manual may or may not be registered trademarks or copyrights of their respective companies, and are used only for identification or explanation and to the owners' benefit, without intent to infringe.

Contents

Notices.....	vi
Safety information	vii
About this guide	viii
M3A78-EM specifications summary.....	x
Chapter 1: Product introduction	
1.1 Welcome!	1-2
1.2 Package contents	1-2
1.3 Special features	1-2
1.3.1 Product highlights	1-2
1.3.2 ASUS unique features	1-6
1.3.3 ASUS stylish features	1-8
1.3.4 ASUS intelligent overclocking features	1-8
1.4 Before you proceed	1-9
1.5 Motherboard overview	1-10
1.5.1 Motherboard layout	1-10
1.5.2 Placement direction	1-11
1.5.3 Screw holes	1-11
1.6 Central Processing Unit (CPU)	1-12
1.6.1 Installing the CPU	1-12
1.6.2 Installing the heatsink and fan	1-14
1.7 System memory	1-16
1.7.1 Overview	1-16
1.7.2 Memory configurations.....	1-16
1.7.3 Installing a DIMM	1-20
1.7.4 Removing a DIMM	1-20
1.8 Expansion slots	1-21
1.8.1 Installing an expansion card	1-21
1.8.2 Configuring an expansion card	1-21
1.8.3 PCI slots.....	1-24
1.8.4 PCI Express x1 slot.....	1-24
1.8.5 PCI Express x16 slot.....	1-24
1.9 Jumpers	1-25
1.10 Connectors	1-26
1.10.1 Rear panel connectors.....	1-26
1.10.2 Internal connectors	1-29

Contents

Chapter 2: BIOS setup

2.1	Managing and updating your BIOS	2-2
2.1.1	Creating a bootable floppy disk.....	2-2
2.1.2	AFUDOS utility.....	2-3
2.1.3	ASUS CrashFree BIOS 3 utility	2-6
2.1.4	ASUS EZ Flash 2 utility.....	2-8
2.1.5	ASUS Update utility	2-9
2.2	BIOS setup program	2-12
2.2.1	BIOS menu screen.....	2-13
2.2.2	Menu bar.....	2-13
2.2.3	Navigation keys.....	2-14
2.2.4	Menu items	2-14
2.2.5	Sub-menu items.....	2-14
2.2.6	Configuration fields	2-14
2.2.7	General help	2-14
2.2.8	Pop-up window	2-15
2.3	Main menu	2-16
2.3.1	System Time	2-16
2.3.2	System Date	2-16
2.3.3	Legacy Diskette A	2-16
2.3.4	Primary IDE Master/Slave.....	2-17
2.3.5	SATA 1, 2, 3, 5, 6, and E-SATA	2-18
2.3.6	SATA Configuration.....	2-19
2.3.7	System Information	2-20
2.4	Advanced menu	2-21
2.4.1	JumperFree Configuration	2-21
2.4.2	CPU Configuration.....	2-23
2.4.3	Chipset.....	2-24
2.4.4	Onboard Device Configuration.....	2-27
2.4.5	PCI/PnP	2-28
2.4.6	USB Configuration	2-29
2.5	Power menu.....	2-30
2.5.1	Suspend Mode.....	2-30
2.5.2	ACPI Support.....	2-30
2.5.3	ACPI APIC Support.....	2-30

Contents

2.5.4	APM Configuration	2-31
2.5.5	HW Monitor Configuration.....	2-32
2.6	Boot menu	2-33
2.6.1	Boot Device Priority	2-34
2.6.2	Boot Settings Configuration	2-34
2.6.3	Security	2-36
2.7	Tools menu	2-38
2.7.1	ASUS EZ Flash 2.....	2-38
2.7.2	Express Gate	2-39
2.7.3	AI NET 2.....	2-39
2.8	Exit menu	2-40

Chapter 3: Software support

3.1	Installing an operating system	3-2
3.2	Support DVD information	3-2
3.2.1	Running the Support DVD	3-2
3.2.2	Drivers menu.....	3-3
3.2.3	Utilities menu	3-4
3.2.4	Make Disk menu	3-6
3.2.5	Manual menu	3-7
3.2.6	ASUS Contact information	3-8
3.2.7	Other information	3-8

Appendix: ATI® Hybrid CrossFireX™

A.1	System requirements	A-2
A.2	Before you proceed.....	A-2
A.3	Installing AMD Chipset Driver	A-3
A.4	Using the ATI CATALYST® Control Center	A-3

Notices

Federal Communications Commission Statement

This device complies with Part 15 of the FCC Rules. Operation is subject to the following two conditions:

- This device may not cause harmful interference, and
- This device must accept any interference received including interference that may cause undesired operation.

This equipment has been tested and found to comply with the limits for a Class B digital device, pursuant to Part 15 of the FCC Rules. These limits are designed to provide reasonable protection against harmful interference in a residential installation. This equipment generates, uses and can radiate radio frequency energy and, if not installed and used in accordance with manufacturer's instructions, may cause harmful interference to radio communications. However, there is no guarantee that interference will not occur in a particular installation. If this equipment does cause harmful interference to radio or television reception, which can be determined by turning the equipment off and on, the user is encouraged to try to correct the interference by one or more of the following measures:

- Reorient or relocate the receiving antenna.
- Increase the separation between the equipment and receiver.
- Connect the equipment to an outlet on a circuit different from that to which the receiver is connected.
- Consult the dealer or an experienced radio/TV technician for help.



The use of shielded cables for connection of the monitor to the graphics card is required to assure compliance with FCC regulations. Changes or modifications to this unit not expressly approved by the party responsible for compliance could void the user's authority to operate this equipment.

Canadian Department of Communications Statement

This digital apparatus does not exceed the Class B limits for radio noise emissions from digital apparatus set out in the Radio Interference Regulations of the Canadian Department of Communications.

This class B digital apparatus complies with Canadian ICES-003.

Safety information

Electrical safety

- To prevent electrical shock hazard, disconnect the power cable from the electrical outlet before relocating the system.
- When adding or removing devices to or from the system, ensure that the power cables for the devices are unplugged before the signal cables are connected. If possible, disconnect all power cables from the existing system before you add a device.
- Before connecting or removing signal cables from the motherboard, ensure that all power cables are unplugged.
- Seek professional assistance before using an adapter or extension cord. These devices could interrupt the grounding circuit.
- Make sure that your power supply is set to the correct voltage in your area. If you are not sure about the voltage of the electrical outlet you are using, contact your local power company.
- If the power supply is broken, do not try to fix it by yourself. Contact a qualified service technician or your retailer.

Operation safety

- Before installing the motherboard and adding devices on it, carefully read all the manuals that came with the package.
- Before using the product, make sure all cables are correctly connected and the power cables are not damaged. If you detect any damage, contact your dealer immediately.
- To avoid short circuits, keep paper clips, screws, and staples away from connectors, slots, sockets and circuitry.
- Avoid dust, humidity, and temperature extremes. Do not place the product in any area where it may become wet.
- Place the product on a stable surface.
- If you encounter technical problems with the product, contact a qualified service technician or your retailer.



The symbol of the crossed out wheeled bin indicates that the product (electrical and electronic equipment, and Mercury-containing button cell battery) should not be placed in municipal waste. Please check local regulations for disposal of electronic products.

About this guide

This user guide contains the information you need when installing and configuring the motherboard.

How this guide is organized

This guide contains the following parts:

- **Chapter 1: Product introduction**

This chapter describes the features of the motherboard and the new technology it supports. This chapter also lists the hardware setup procedures that you have to perform when installing system components. It includes description of the jumpers and connectors on the motherboard.

- **Chapter 2: BIOS setup**

This chapter tells how to change system settings through the BIOS Setup menus. Detailed descriptions of the BIOS parameters are also provided.

- **Chapter 3: Software support**

This chapter describes the contents of the support CD/DVD that comes with the motherboard package.

- **Appendix**

This chapter describes how to enable ATI Hybrid CrossFireX under Windows Vista OS.

Where to find more information

Refer to the following sources for additional information and for product and software updates.

1. **ASUS websites**

The ASUS website provides updated information on ASUS hardware and software products. Refer to the ASUS contact information.

2. **Optional documentation**

Your product package may include optional documentation, such as warranty flyers, that may have been added by your dealer. These documents are not part of the standard package.

Conventions used in this guide

To make sure that you perform certain tasks properly, take note of the following symbols used throughout this manual.



DANGER/WARNING: Information to prevent injury to yourself when trying to complete a task.



CAUTION: Information to prevent damage to the components when trying to complete a task.



IMPORTANT: Instructions that you **MUST** follow to complete a task.



NOTE: Tips and additional information to help you complete a task.

Typography

Bold text

Indicates a menu or an item to select.

Italics

Used to emphasize a word or a phrase.

<Key>

Keys enclosed in the less-than and greater-than sign means that you must press the enclosed key.

Example: <Enter> means that you must press the Enter or Return key.

<Key1>+<Key2>+<Key3>

If you must press two or more keys simultaneously, the key names are linked with a plus sign (+).

Example: <Ctrl>+<Alt>+<D>

Command

Means that you must type the command exactly as shown, then supply the required item or value enclosed in brackets.

Example: At the DOS prompt, type the command line:

```
afudos /i [filename]
```

```
afudos /iM3A78EM.ROM
```

M3A78-EM specifications summary

CPU	AMD® Socket AM2+ / AM2 for Phenom™ FX / Phenom / Athlon™ / Sempron™ processor AMD Cool 'n' Quiet™ Technology Supports CPU up to 140W
Chipset	AMD 780G / SB700
System bus	Up to 5200 MT/s HyperTransport™ 3.0 interface for AM2+ CPU 2000 / 1600 MT/s for AM2 CPU
Memory	Dual-channel memory architecture 4 x 240-pin DIMM slots support unbuffered ECC and non-ECC DDR2 1066*/800/667MHz memory modules Supports up to 8GB system memory * Due to AMD CPU limitation, DDR2 1066 is supported by AM2+ CPU for one DIMM per channel only. ** Refer to www.asus.com or user manual for Memory QVL (Qualified Vendors List) *** When you install a total memory of 4GB or more, Windows® 32-bit operation system may only recognize less than 3GB. Hence, a maximum of 3GB system memory is recommended if you are using a Windows 32-bit operation system.
Expansion slots	1 x PCI Express™ x16 slot 1 x PCI Express™ x1 slot 2 x PCI 2.2 slots Supports PCI Express™ 2.0 / 1.0 Architecture
Graphics	Integrated ATI Radeon™ HD 3200 GPU Supports maximum shared memory up to 256MB Supports DisplayPort with max. resolution up to 2560 x 1600@60Hz Supports HDMI™ Technology with max. resolution up to 1920 x 1200(1080P) Supports DVI with max. resolution up to 2560 x 1600 @60Hz Supports D-Sub with max. resolution up to 2456 x 1536 @75Hz Supports Hybrid CrossFireX™ technology (For Windows Vista OS only) Supports Microsoft® DirectX 10, OpenGL 2.0, and Pixel Shader 4.0 * Refer to www.asus.com for the discrete graphics GPU QVL which supports the Hybrid CrossFireX technology. ** Due to chipset limitation, DisplayPort on this motherboard only supports video signals.

(continued on the next page)

M3A78-EM specifications summary

USB	Supports up to 12 USB 2.0/1.1 ports (6 ports at mid-board, 6 ports at back panel)
Storage / RAID	ATI SB700 chipset supports 1 x UltraDMA 133/100 connector 5 x SATA 3Gb/s connectors with RAID 0, RAID 1, and RAID 10 configuration support 1 x ESATA 3Gb/s connector with RAID 0, RAID 1, and RAID 10 configuration support
Audio	Realtek® ALC1200 High Definition Audio 8-channel CODEC Optical S/PDIF out port at back panel
LAN	Gigabit LAN
ASUS overclocking features	SFS (Stepless Frequency Selection) from 200MHz to 300MHz at 1MHz increment Adjustable CPU Voltage at 0.05V increment ASUS C.P.R. (CPU Parameter Recall)
ASUS special features	Express Gate ASUS Q-Fan ASUS CrashFree BIOS3 ASUS EZ Flash2 ASUS MyLogo2 ASUS Noise Filter AI NAP
Back panel I/O ports	1 x PS/2 Keyboard/Mouse Combo port 1 x optical S/PDIF Out port 1 x HDMI port 1 x DVI port 1 x D-Sub port 1 x 1394 port 1 x ESATA port 1 x DisplayPort 1 x RJ45 port 6 x USB 2.0/1.1 ports 8-channel Audio I/O ports
BIOS	8Mb Flash ROM, AMI BIOS, PnP, DMI2.0, WfM2.0, SM BIOS 2.5, ACPI2.0a, ASUS EZ Flash 2

(continued on the next page)

M3A78-EM specifications summary

Internal I/O connectors	3 x USB 2.0 connectors support additional 6 USB 2.0 ports 1 x Floppy disk drive connector 1 x IDE connector 1 x COM connector 5 x SATA connectors 1 x 1394 connector High definition front panel audio connector 1 x system panel connector 1 x CD audio-in connector 1 x S/PDIF out header 1 x Chassis intrusion connector Power/CPU/Chassis fan connectors 24-pin EATX power connector 4-pin ATX 12V power connector
Accessories	User manual 2 x Serial ATA cables 2 x Serial ATA power cables 1 x UltraDMA 133/100/66 cable 1 x FDD cable 2 in 1 Q-Connector
Form Factor	uATX Form factor: 9.6" x 9.6" (24.4cm x 24.4cm)
Support CD	Drivers Express Gate ASUS PC Probe II ASUS LiveUpdate Utility Anti-Virus software (OEM version)

*Specifications are subject to change without notice.

This chapter describes the motherboard features and the new technologies it supports.

1 Product introduction

1.1 Welcome!

Thank you for buying an ASUS® M3A78-EM motherboard!

The motherboard delivers a host of new features and latest technologies, making it another standout in the long line of ASUS quality motherboards!

Before you start installing the motherboard, and hardware devices on it, check the items in your package with the list below.

1.2 Package contents

Check your motherboard package for the following items.

Motherboard	ASUS M3A78-EM motherboard
Cables	2 x Serial ATA signal cables 2 x Serial ATA power cables 1 x Ultra DMA 133/100/66 cable 1 x FDD cable
Accessories	2 in 1 Q-Connector
Application DVD	ASUS motherboard support DVD
Documentation	User manual



If any of the above items is damaged or missing, contact your retailer.

1.3 Special features

1.3.1 Product highlights

Green ASUS



This motherboard and its packaging comply with the European Union's Restriction on the use of Hazardous Substances (RoHS). This is in line with the ASUS vision of creating environment-friendly and recyclable products/packaging to safeguard consumers' health while minimizing the impact on the environment.



AMD® Socket AM2+ Phenom™ FX / Phenom / Athlon™ / Sempron™ CPU support

This motherboard supports AMD® Socket AM2+ multi-core processors with unique L3 cache and delivers better overclocking capabilities with less power consumption. It features dual-channel DDR2 1066 memory support and accelerates data transfer rate up to 5200MT/s via HyperTransport™ 3.0 based system bus. See page 1-12 for details.



AMD Socket AM2 Athlon 64 X2 / Athlon 64 FX / Athlon 64 / Sempron CPU support

The motherboard supports AMD socket AM2 single-core Athlon 64/ Sempron and dual-core Athlon 64 X2/ Athlon 64 FX processors with 2MB / 1MB / 512KB L2 cache, which is based on 64-bit architecture. It features 2000 / 1600 MT/s HyperTransport Bus, dual-channel un-buffered DDR2 800 memory support and AMD Cool 'n' Quiet! Technology. See page 1-12 for details.

AMD Cool 'n' Quiet Technology

The motherboard supports the AMD Cool 'n' Quiet Technology, which monitors system operation and automatically adjusts CPU voltage and frequency for a cool and quiet operating environment. See page 2-23 for details.



AMD® 780G and ATI SB700 chipsets

AMD 780G Northbridge is the latest AMD chipset designed for both HT1.0 and 5200MT/s HyperTransport™ 3.0 (HT 3.0) interface speed and external graphics in PCI Express™ 2.0/1.1 standard. It features the integrated DX10 compliant ATI RV610-based graphics, which supports dual VGA outputs including DVI/HDMI interface with HDCP compliant, and incorporates AMD's UVD with hardware acceleration of H.264, VC1 and Mpeg2 used in HD DVD and BluRay disks. Meanwhile it can also support the future mainstream Hybrid CrossFire Technology that significantly optimizes your 3D performance.



HDMI Interface

HDMI (High-Definition Multimedia Interface) is the first and only industry-supported, uncompressed, all digital audio and video interface via a single cable and is HDCP compliant allowing playback of HD DVD, Blu-Ray Disc and other protected content. See page 1-26 for details.



HDMI/DVI/RGB Support

With an HDMI to DVI conversion adapter, this motherboard can support both DVI and HDMI output. DVI (Digital Visual Interface) provides high quality visuals for digital display devices like LCD monitors. The interface of this motherboard supports digital HDMI/DVI and analog D-Sub standards.



Hybrid CrossFireX

ATI new technology Hybrid CrossFireX greatly boosts graphics performance with an onboard GPU and a discrete graphics card.



-
- Hybrid CrossFireX technology is supported by Windows Vista® OS only.
 - Refer to www.asus.com for the discrete graphics GPU QVL which lists the GPUs that support the Hybrid CrossFireX technology.
-



PCI Express 2.0 support

This motherboard supports the latest PCIe 2.0 devices for double speed and bandwidth which enhances system performance.

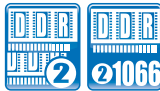

DDR2 memory support

This motherboard is an AMD® platform with DDR2 1066 support. It provides faster data transfer rate and more bandwidth to increase memory data transfer rate and computing efficiency, enhancing system performance in 3D graphics and other memory demanding applications.



Due to AMD CPU limitation, DDR2 1066 is supported by AM2+ CPU for one DIMM per channel only. Refer to www.asus.com for the supported CPU models.

Serial ATA 3Gb/s technology



The motherboard supports next-generation SATA hard drives based on the new SATA 3Gb/s storage specification. The onboard ATI® SB700 allows RAID 0, RAID 1 and RAID 10 configurations for five onboard SATA connectors. See pages 1-33 and 2-19 for details.

Gigabit LAN solution



The on-board LAN controller is a highly integrated Gb LAN controller. It is enhanced with an ACPI management function to provide efficient power management for advanced operating systems.

USB 2.0 technology



USB 2.0 is the latest connectivity standard for next generation components and peripherals. Backwards compatible with current USB 1.1 peripherals, USB 2.0 delivers transfer speeds up to 40 times faster at 480Mb/s, for easy connectivity and ultra-fast data transfers.

8-channel high definition audio



Enjoy high-quality sound system on your PC! The onboard 8-channel HD audio (High Definition Audio, previously codenamed Azalia) CODEC enables high-quality 192KHz/24-bit audio output, jack-detect feature, which automatically detects and identifies what types of peripherals are plugged into the audio I/O jacks and notifies users of inappropriate connection, meaning there will be no more confusion of Line-in, Line-out and Mic jacks. See pages 1-27, 1-35 and 2-27 for details.

DisplayPort



This motherboard introduces the new digital display interface standard - DisplayPort. This new design features a small and user-friendly connector. It delivers higher performances of resolution, refresh rate, and color depth and improves digital display connectivity.



Due to chipset limitation, DisplayPort on this motherboard only supports video signals.

1.3.2 ASUS unique features

ASUS AI Life Features



Taking only 5 seconds to go online from bootup, Express Gate is the one-stop gateway to instant fun! It's a unique motherboard built-in OS. You can utilize the most popular Instant Messengers (IM) like MSN, Skype, Google talk, QQ, and Yahoo! Messenger to keep in touch with friends, or quickly check on the weather and e-mails just before leaving your house. What's more, the user-friendly picture manager lets you view your pictures without entering Windows at anytime!



- The actual boot time is subject to hardware configurations and product models.
- Due to chipset limitation, ASUS Express Gate supports USB devices or SATA HDDs (IDE mode) connected to SATA port 1-4 only. Set the **OnChip SATA Type** item in the BIOS to **[SATA]** before installing and using ASUS Express Gate.
- Currently, ASUS Express Gate does not support PATA IDE HDDs. Visit www.asus.com for future BIOS and Express Gate software updates.

ASUS Power Saving Solution

ASUS Power Saving Solution intelligently and automatically provides balanced computing power and energy consumption.



The ASUS Q-Fan technology smartly adjusts the CPU fan speeds according to the system loading to ensure quiet, cool, and efficient operation. See page 2-33 for details.



4+1 Phase Power Design

ASUS 4+1 Phase Power Design unleashes ultimate memory performances with independent power to core components, while providing fast transient response and stability for the CPU under heavy loading or overclocking modes.



AI Gear 2

AI Gear 2 allows you to choose from profiles to adjust CPU frequency and vCore voltage, minimizing system noise and saving CPU power consumption at most. You can real-time change the mode under operating system to suit your needs.



AI Nap

With AI Nap, the system can continue running at minimum power and noise when you are temporarily away. To wake the system and return to the OS environment, simply click the mouse or press a key.

ASUS EZ DIY

ASUS EZ DIY feature collection provides you with easy ways to install computer components, update the BIOS or back up your favorite settings.



ASUS Q-Connector

ASUS Q-Connector allows you to easily connect or disconnect the chassis front panel cables to the motherboard. This unique module eliminates the trouble of plugging in one cable one at a time, making connection quick and accurate. See page 1-42 for details.



ASUS CrashFree BIOS 3

The ASUS CrashFree BIOS 3 allows users to restore corrupted BIOS data from a USB flash disk containing the BIOS file. See page 2-6 for details.



ASUS EZ Flash 2

EZ Flash 2 is a user-friendly BIOS update utility. Simply press the predefined hotkey to launch the utility and update the BIOS without entering the OS. Update your BIOS easily without preparing a bootable diskette or using an OS-based flash utility. See page 2-8 and 2-38 for details.



ASUS O.C. Profile

The motherboard features the ASUS O.C. Profile that allows users to conveniently store or load multiple BIOS settings. The BIOS settings can be stored in the CMOS or a separate file, giving users freedom to share and distribute their favorite overclocking settings.

ASUS Crystal Sound

This feature can enhance speech-centric applications like Skype, online game, video conference and recording.



Noise Filter

This feature detects repetitive and stationary noises (non-voice signals) like computer fans, air conditioners, and other background noises then eliminates it in the incoming audio stream while recording.

1.3.3 ASUS stylish features



ASUS MyLogo2™

This feature allows you to convert your favorite photo into a 256-color boot logo for a more colorful and vivid image on your screen.

1.3.4 ASUS intelligent overclocking features



C.P.R. (CPU Parameter Recall)

The C.P.R. feature of the motherboard BIOS allows automatic re-setting to the BIOS default settings in case the system hangs due to overclocking failure. When the system hangs due to overclocking failure, C.P.R. eliminates the need to open the system chassis and clear the RTC data. Simply shut down and reboot the system, and the BIOS automatically restores the CPU default settings for each parameter.

1.4 Before you proceed

Take note of the following precautions before you install motherboard components or change any motherboard settings.



- Unplug the power cord from the wall socket before touching any component.
- Use a grounded wrist strap or touch a safely grounded object or a metal object, such as the power supply case, before handling components to avoid damaging them due to static electricity
- Hold components by the edges to avoid touching the ICs on them.
- Whenever you uninstall any component, place it on a grounded antistatic pad or in the bag that came with the component.
- Before you install or remove any component, ensure that the ATX power supply is switched off or the power cord is detached from the power supply. Failure to do so may cause severe damage to the motherboard, peripherals, and/or components.

Onboard LED

The motherboard comes with a standby power LED that lights up to indicate that the system is ON, in sleep mode, or in soft-off mode. This is a reminder that you should shut down the system and unplug the power cable before removing or plugging in any motherboard component. The illustration below shows the location of the onboard LED.

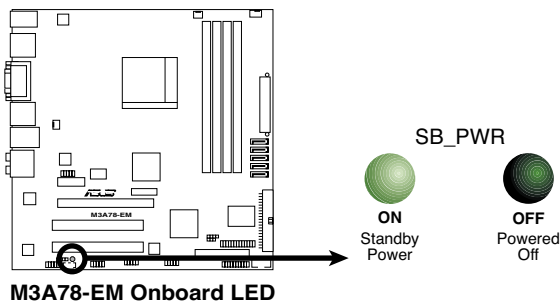

1.5.2 Placement direction

When installing the motherboard, make sure that you place it into the chassis in the correct orientation. The edge with external ports goes to the rear part of the chassis as indicated in the image below.

1.5.3 Screw holes

Place eight (8) screws into the holes indicated by circles to secure the motherboard to the chassis.



Do not overtighten the screws! Doing so can damage the motherboard.

Place this side towards
the rear of the chassis

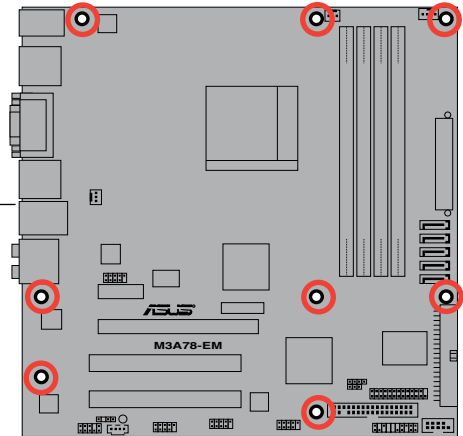

1.6 Central Processing Unit (CPU)

The motherboard comes with an AM2+ / AM2 socket designed for AMD® Phenom™ FX / Phenom / Athlon™ / Sempron™ processor.



The AM2+/AM2 socket has a different pinout from the 940-pin socket designed for the AMD Opteron processor. Ensure you use a CPU designed for the AM2+/AM2 socket. The CPU fits in only one correct orientation. DO NOT force the CPU into the socket to prevent bending the connectors on the socket and damaging the CPU!

1.6.1 Installing the CPU

To install a CPU.

1. Locate the CPU socket on the motherboard.

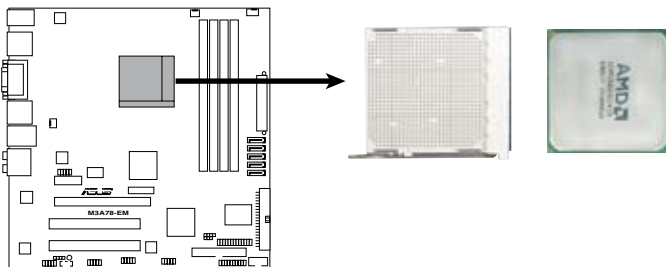

M3A78-EM CPU Socket AM2+

2. Unlock the socket by pressing the lever sideways, then lift it up to a 90°-100° angle.

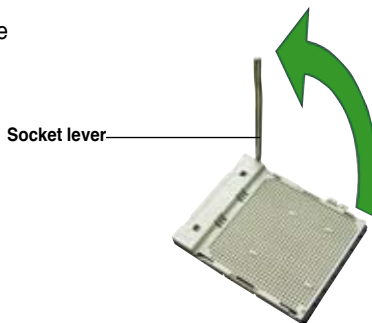

Ensure that the socket lever is lifted up to 90°-100° angle, otherwise the CPU does not fit in completely.

- Position the CPU above the socket such that the CPU corner with the gold triangle matches the socket corner with a small triangle.
- Carefully insert the CPU into the socket until it fits in place.

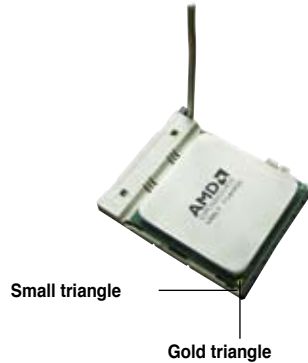

The CPU fits only in one correct orientation. DO NOT force the CPU into the socket to prevent bending the pins and damaging the CPU!

- When the CPU is in place, push down the socket lever to secure the CPU. The lever clicks on the side tab to indicate that it is locked.
- Install a CPU heatsink and fan following the instructions that came with the heatsink package.



- Connect the CPU fan cable to the CPU_FAN connector on the motherboard.

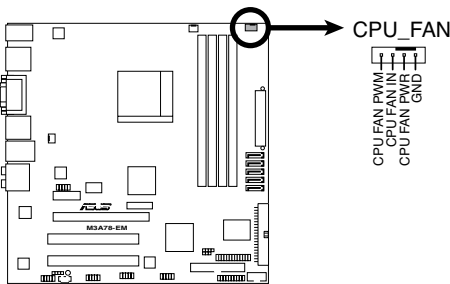

M3A78-EM CPU Fan Connector



Do not forget to connect the CPU fan connector! Hardware monitoring errors can occur if you fail to plug this connector.

1.6.2 Installing the heatsink and fan

The AMD Phenom™ FX / Phenom / Athlon™ / Sempron™ processor requires a specially designed heatsink and fan assembly to ensure optimum thermal condition and performance.



Ensure that you use only qualified heatsink and fan assembly.

Follow these steps to install the CPU heatsink and fan.

1. Place the heatsink on top of the installed CPU, making sure that the heatsink fits properly on the retention module base.



- The retention module base is already installed on the motherboard upon purchase.
 - You do not have to remove the retention module base when installing the CPU or installing other motherboard components.
 - If you purchased a separate CPU heatsink and fan assembly, make sure that a Thermal Interface Material is properly applied to the CPU heatsink or CPU before you install the heatsink and fan assembly.
-

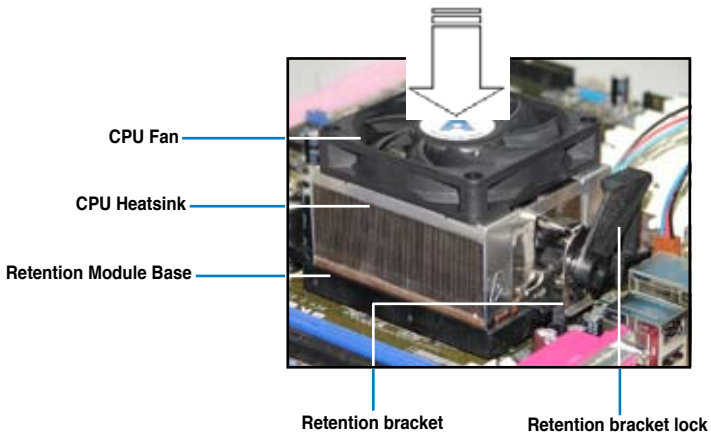

Your boxed CPU heatsink and fan assembly should come with installation instructions for the CPU, heatsink, and the retention mechanism. If the instructions in this section do not match the CPU documentation, follow the latter.

2. Attach one end of the retention bracket to the retention module base.

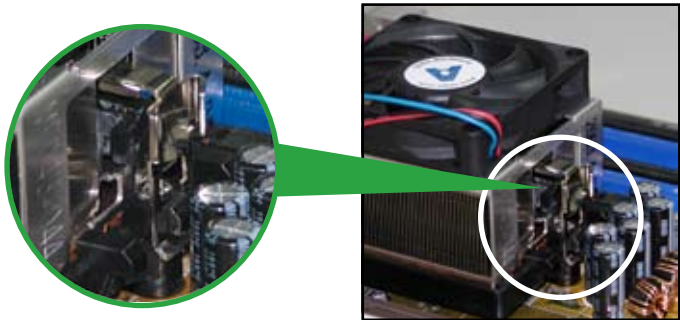

3. Align the other end of the retention bracket (near the retention bracket lock) to the retention module base. A clicking sound denotes that the retention bracket is in place.



Ensure that the fan and heatsink assembly perfectly fits the retention mechanism module base; otherwise, you cannot snap the retention bracket in place.



4. Push down the retention bracket lock on the retention mechanism to secure the heatsink and fan to the module base.

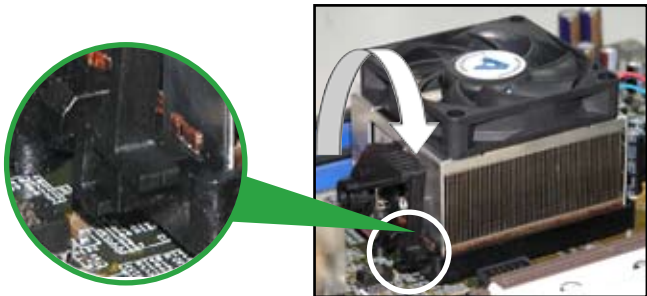

1.7 System memory

1.7.1 Overview

The motherboard comes with four Double Data Rate 2 (DDR2) Dual Inline Memory Modules (DIMM) sockets.

A DDR2 module has the same physical dimensions as a DDR DIMM but has a 240-pin footprint compared to the 184-pin DDR DIMM. DDR2 DIMMs are notched differently to prevent installation on a DDR DIMM socket.

The figure illustrates the location of the DDR2 DIMM sockets:

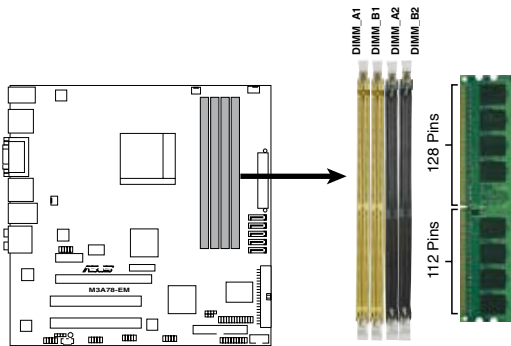

M3A78-EM 240-pin DDR2 DIMM Sockets

Channel	Sockets
Channel 1	DIMM_A1 and DIMM_A2
Channel 2	DIMM_B1 and DIMM_B2

1.7.2 Memory configurations

You may install 256 MB, 512 MB, 1 GB, and 2 GB unbuffered ECC/non-ECC DDR2 DIMMs into the DIMM sockets.

Recommended memory configurations

Mode	Sockets			
	DIMM_A1	DIMM_B1	DIMM_A2	DIMM_B2
Single-Channel	–	Populated	–	–
	Populated	–	–	–
Dual-channel (1)	Populated	Populated	–	–
Dual-channel (2)	Populated	Populated	Populated	Populated



-
- When using only one memory module, start installing the DDR2 DIMM from slot DIMM_A1 or DIMM_B1 for better overclocking capability.
 - For dual-channel configuration (2), you may:
 - install identical DIMMs in all four sockets OR
 - install identical DIMM pair in DIMM_A1 and DIMM_B1 (yellow sockets) and another identical DIMM pair in DIMM_A2 and DIMM_B2 (black sockets)
 - Always use identical DDR2 DIMM pairs for dual channel mode. For optimum compatibility, we recommend that you obtain memory modules from the same vendor.
-



Important notice on installing Windows® Vista / XP 32-bit version

- If you are using a Windows 32-bit version operating system (e.g. 32-bit Windows XP, 32-bit Vista) without the Physical Address Extension (PAE) support, the system will allocate a certain amount of memory space for system devices.
 - We recommend that you install only a maximum of 3GB system memory when using a Windows 32-bit version operating system without the PAE. The excess over 3GB of installed memory will not cause any problem; however, the system can not use this excess memory space and the system will display less than the total size of physical memory installed.
-



The motherboard can support 8 GB physical memory on the operating system listed below. You may install a maximum of 2 GB DIMMs on each slot.

64-bit

Windows® XP Professional x64 Edition

Windows® Vista x64 Edition

M3A78-EM Motherboard Qualified Vendors Lists (QVL) DDR2-1066 MHz capability

Size	Vendor	Part No.	CL	Chip Brand	SS/ DS	Chip No.	DIMM support (Optional)		
							A*	B*	C*
512MB	Kingston	KVR1066D2N7/512	N/A	Elpida	SS	E5108AJBG-1J-E	*	*	*
1G	Kingston	KHX8500D2/1G	N/A	Kingston	DS	Heat-Sink Package	*	*	*
1G	Qimonda	HYS64T128020EU-19F-C	6	Qimonda	DS	HYB18T512800CF19FFSS24313	*	*	*
1G	Kingmax	KLED48F-A8K15	N/A	Kingmax	DS	KKA8FFIXF-JFS-18A	*	*	*
1G	Transcend	TX1066QLJ-2GK1GB	5	Transced	DS	Heat-Sink Package	*	*	*
1G	OCZ	OCZ2N1066SR2DK	N/A	OCZ	DS	Heat-Sink Package	*	*	*
1G	GEIL	GE22GB1066C5DC	5	GEIL	DS	Heat-Sink Package	*	*	*
1G	GEIL	GE24GB1066C5QC	5	GEIL	DS	Heat-Sink Package	*	*	*



Due to AMD CPU limitation, DDR2 1066 is supported by AM2+ CPU for one DIMM per channel only. Refer to www.asus.com for the supported CPU models.

DDR2-800 MHz capability

Size	Vendor	Part No.	CL	Chip Brand	SS/ DS	Chip No.	DIMM support (Optional)		
							A*	B*	C*
1G	Kingston	KHX6400D2LL/1G	N/A	Kingston	DS	Heat-Sink Package	*	*	*
512MB	Kingston	KVR800D2N5/512	N/A	Promos	SS	V59C1512804QCF25SY032406PECPA	*	*	*
2G	Kingston	KHX6400D2/2G	N/A	Kingston	DS	Heat-Sink Package	*	*	*
4G	Kingston	N/A	N/A	Elpida	DS	E2108ABSE-8G-E	*	*	*
512MB	Samsung	M378T6553GZS-CF7	6	Samsung	SS	K4T51083QG-HCF7	*	*	*
2G	Samsung	M378T5663QZ3-CF7	6	Samsung	DS	K4T1G084QQ-HCF7	*	*	*
2G	Samsung	M391T5663QZ3-CF7	6	Samsung	DS	K4T1G084QQ-HCF7(ECC)	*	*	*
512MB	Qimonda	HYS64T64000EU-2.5-B2	6	Qimonda	SS	HYB18T512800B2F25FSS28380	*	*	*
1G	Micron	MT9HTF12872AY-800E1	6	Micron	SS	D9HNP 7YE22(ECC)	*	*	*
1G	Corsair	XMS2-6400	4	Corsair	DS	Heat-Sink Package	*	*	*
512MB	HY	HYMP564U64CP8-S5 AB	5	Hynix	SS	HY5PS12821CFP-S5	*	*	*
1G	HY	HYMP512U64CP8-S5 AB	5	Hynix	DS	HY5PS12821CFPS5	*	*	*
512MB	Kingmax	KLDC28F-A8K15	N/A	Kingmax	SS	KKA8FF1XF-JFS-25A	*	*	*
1G	Kingmax	KLDD48F-A8K15	N/A	Kingmax	DS	KKA8FFIXF-HFS-25A	*	*	*
512MB	Apacer	78.91G91.9K5	5	Apacer	SS	AM4B5708JQSJ8E0751C	*	*	*
2G	Apacer	78.A1GA0.9K4	5	Apacer	DS	AM4B580CQJSJ8E0740E	*	*	*
512MB	Transcend	TS128MLQ64V8J512MB	N/A	Micron	SS	7HD22 D9GMH	*	*	*
1G	Transcend	505485-1034	5	Transcend	DS	TQ123PJF8F0801	*	*	*
512MB	VDATA	M2GVD6G3H3160Q1E52	N/A	VDATA	SS	VD29608A8A-25EG20813	*	*	*
1G	ADATA	M2OAD6G314170Q1E58	N/A	ADATA	DS	AD29608A8A-25EG80810	*	*	*
2G	PSC	AL8E8F73C-8E1	5	PSC	DS	A3R1GE3CFF7734MAA0E	*	*	*
2G	PSC	AL7E8E63H-10E1K	5	PSC	DS	A3R1GE3CFF750RABBP(ECC)	*	*	*
1G	GEIL	GX22GB6400DC	5	GEIL	DS	Heat-Sink Package	*	*	*
2G	GEIL	GE28GB800C5QC	5	GEIL	DS	Heat-Sink Package	*	*	*
1G	Super Talent	T800UB1GC4	4	Super Talent	DS	Heat-Sink Package	*	*	*
1G	G.SKILL	F2-6400CL4D-2GBPK	4	G.SKILL	DS	Heat-Sink Package	*	*	*
2G	G.SKILL	F2-6400CL5D-4GBPQ	5	G.SKILL	DS	Heat-Sink Package	*	*	*
4G	G.SKILL	F2-6400CL5Q-16GNQ	5	G.SKILL	DS	Heat-Sink Package	*	*	*
1G	OCZ	OCZ2VU8004GK	6	OCZ	DS	Heat-Sink Package	*	*	*
1G	Elixir	M2Y1G64TU8H08B-25C	5	Elixir	DS	N2TU51280BE-25C802006Z1DV	*	*	*

DDR2-667MHz capability

Size	Vendor	Part No.	CL	Chip Brand	SS/ DS	Chip No.	DIMM support (Optional)		
							A*	B*	C*
512MB	Kingston	KVR667D2N5/512	N/A	Hynix	SS	HY5PS12821EFP-Y5	•	•	
1G	Kingston	KVR667D2N5/1G	N/A	Hynix	DS	HY5PS12821EFP-Y5	•	•	
512MB	Qimonda	HYS64T64000EU-3S-B2	5	Qimonda	SS	HYB18T512B00B2F3SFSS28171	•	•	
1G	Qimonda	HYS64T128020EU-3S-B2	5	Qimonda	DS	HYB18T512B00B2F3SFSS28171	•	•	
1G	Corsair	XMS2-5400	4	Corsair	DS	Heat-Sink Package	•	•	
512MB	Kingmax	KLCC28F-A8KB5	N/A	Kingmax	SS	KKEA88B4LAUG-29DX	•	•	
1G	Kingmax	KLCD48F-A8KB5	N/A	Kingmax	DS	KKEA88B4LAUG-29DX	•	•	
512MB	Apacer	78.91G92.9K5	5	Apacer	SS	AM4B5708JQS7E0751C	•	•	
1G	Apacer	AU01GE667C5KBGC	N/A	Apacer	DS	AM4B5708GQS7E0636B	•	•	
2G	Apacer	78.A1G9O.9K4	5	Apacer	DS	AM4B5808CQS7E0749B	•	•	
1G	Transcend	506010-4894	5	Elpida	DS	E5108AJBG-6E-E	•	•	
1G	ADATA	M2OAD5G314170Q1C58	N/A	ADATA	DS	AD29608A8A-3EG80814	•	•	
2G	ADATA	M2OAD5H3J4170I1C53	N/A	ADATA	DS	AD20908A8A-3EG 30724	•	•	
512MB	PSC	AL6E8E63J-6E1	5	PSC	SS	A3R12E3JFF717B9A00	•	•	
1G	PSC	AL7E8F73C-6E1	5	PSC	SS	A3R1GE3CFF734MAA0J	•	•	
512MB	Nanya	NT512T64U88A1BY-3C	N/A	Nanya	SS	NT5T064M8AE-3C	•	•	
1G	GEIL	GX21GB5300SX	3	GEIL	DS	Heat-Sink Package	•	•	
2G	GEIL	GX24GB5300LDC	5	GEIL	DS	Heat-Sink Package	•	•	
512MB	Twinmos	8D-A3JK5MPETP	5	PSC	SS	A3R12E3GEF633ACA0Y	•	•	
1G	Leadmax	LRMP512U64A8-Y5	N/A	Hynix	DS	HY5PS12821CFP-Y5 C 702AA	•	•	



SS - Single-sided / DS - Double-sided

DIMM support:

A*: Supports one module inserted in any slot as Single-channel memory configuration

B*: Supports one pair of modules inserted into either the yellow slots or the black slots as one pair of Dual-channel memory configuration

C*: Supports four modules inserted into both the yellow slots and the black slots as two pairs of Dual-channel memory configuration



Visit the ASUS website for the latest DDR2 DIMM modules for this motherboard.

1.7.3 Installing a DIMM



Make sure to unplug the power supply before adding or removing DIMMs or other system components. Failure to do so may cause severe damage to both the motherboard and the components.

1. Unlock a DIMM socket by pressing the retaining clips outward.
2. Align a DIMM on the socket such that the notch on the DIMM matches the break on the socket.
3. Firmly insert the DIMM into the socket until the retaining clips snap back in place and the DIMM is properly seated.

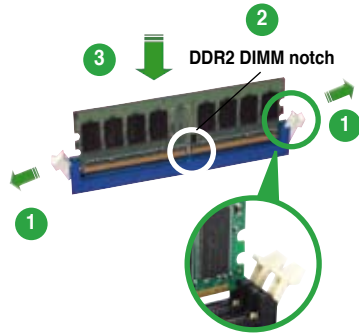

Unlocked retaining clip



- A DDR2 DIMM is keyed with a notch so that it fits in only one direction. DO NOT force a DIMM into a socket to avoid damaging the DIMM.
- The DDR2 DIMM sockets do not support DDR DIMMs. Do not install DDR DIMMs to the DDR2 DIMM sockets.

1.7.4 Removing a DIMM

To remove a DIMM:

1. Simultaneously press the retaining clips outward to unlock the DIMM.

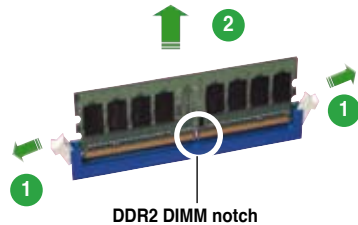

Support the DIMM lightly with your fingers when pressing the retaining clips. The DIMM might get damaged when it flips out with extra force.

2. Remove the DIMM from the socket.

1.8 Expansion slots

In the future, you may need to install expansion cards. The following sub-sections describe the slots and the expansion cards that they support.



Make sure to unplug the power cord before adding or removing expansion cards. Failure to do so may cause you physical injury and damage motherboard components.

1.8.1 Installing an expansion card

To install an expansion card:

1. Before installing the expansion card, read the documentation that came with it and make the necessary hardware settings for the card.
2. Remove the system unit cover (if your motherboard is already installed in a chassis).
3. Remove the bracket opposite the slot that you intend to use. Keep the screw for later use.
4. Align the card connector with the slot and press firmly until the card is completely seated on the slot.
5. Secure the card to the chassis with the screw you removed earlier.
6. Replace the system cover.

1.8.2 Configuring an expansion card

After installing the expansion card, configure it by adjusting the software settings.

1. Turn on the system and change the necessary BIOS settings, if any. See Chapter 2 for information on BIOS setup.
2. Assign an IRQ to the card. Refer to the tables on the next page.
3. Install the software drivers for the expansion card.

Interrupt assignments

IRQ	Standard function
0	System timer
1	Standard 101/102-Key or Microsoft Natural Keyboard
2	Programmable interrupt controller
3	Standard OpenHCI USB Host Controller
4	Communications Port (COM 1)
5	ACPI IRQ Holder for PCI IRQ Steering
6	(free)
7	(free)
8	System CMOS / Real Time Clock
9	SCI IRQ used by ACPI bus
10	Standard PCI Graphics Adapter (VGA)
11	(free)
12	Microsoft PS/2 Port Mouse
13	Numeric data processor
14	Primary IDE controller (single fifo)
15	Secondary IDE controller (single fifo)

* These IRQs are usually available for ISA or PCI devices.

IRQ assignments for this motherboard

	A	B	C	D	E	F	G	H	I
PCIEX1 Slot	shared	-	-	-	-	-	-	-	-
PCIEX16 Slot	-	-	shared	-	-	-	-	-	-
Onboard USB1.1 Controller 1	shared	-	-	-	-	-	-	-	-
Onboard USB1.1 Controller 2	-	-	-	-	-	-	-	-	-
Onboard USB1.1 Controller 3	-	-	shared	-	-	-	-	-	-
Onboard USB1.1 Controller 4	-	-	-	-	-	-	-	-	-
Onboard USB1.1 Controller 5	-	-	shared	-	-	-	-	-	-
Onboard USB2.0 Controller 1	-	-	-	-	-	-	-	-	-
Onboard USB2.0 Controller 2	-	-	-	-	-	-	-	-	-
Onboard ATI RS780G AZALIA	-	-	shared	-	-	-	-	-	-
Onboard IDE PORT	shared	-	-	-	-	-	-	-	-
Onboard HD Audio	shared	-	-	-	-	-	-	-	-
Onboard LAN	-	-	shared	-	-	-	-	-	-
Onboard VGA	-	-	shared	-	-	-	-	-	-
Onchip SATA	-	-	-	-	-	-	shared	-	-
JMB1394	-	shared	-	-	-	-	-	-	-
PCI Card1	-	-	-	-	shared	-	-	-	-
PCI Card2	-	-	-	-	-	shared	-	-	-



When using PCI cards on shared slots, ensure that the drivers support “Share IRQ” or that the cards do not need IRQ assignments; otherwise, conflicts will arise between the two PCI groups, making the system unstable and the card inoperable.

1.8.3 PCI slots

The PCI slots support cards such as a LAN card, SCSI card, USB card, and other cards that comply with PCI specifications. The photo shows a LAN card installed on a PCI slot.

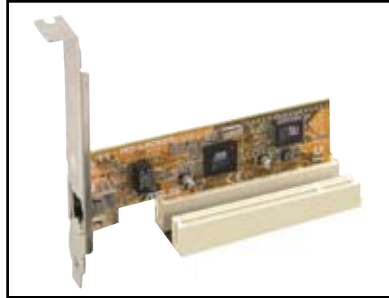

1.8.4 PCI Express x1 slot

This motherboard supports PCI Express x1 network cards, SCSI cards and other cards that comply with the PCI Express specifications. The photo shows a network card installed on the PCI Express x1 slot.



1.8.5 PCI Express x16 slot

This motherboard supports PCI Express x16 graphics cards that comply with PCI Express specifications. The photo shows a graphics card installed on the PCI Express x16 slot.



- The Surroundview function works only when you install an ATI graphics card on the PCI Express x16 slot and enable the **Surround View** item in the BIOS. See page 2-26 for details.
- The Surroundview function supports up to four monitors, two from the onboard VGA and DVI-D/HDMI out ports, with the other two from the VGA and DVI-D/HDMI out ports on an ATI graphics card.

1.9 Jumpers

1. Clear RTC RAM (CLRRTC)

This jumper allows you to clear the Real Time Clock (RTC) RAM in CMOS. You can clear the CMOS memory of date, time, and system setup parameters by erasing the CMOS RTC RAM data. The onboard button cell battery powers the RAM data in CMOS, which include system setup information such as system passwords.

To erase the RTC RAM:

1. Turn OFF the computer and unplug the power cord.
2. Remove the onboard battery.
3. Move the jumper cap from pins 1-2 (default) to pins 2-3. Keep the cap on pins 2-3 for about 5~10 seconds, then move the cap back to pins 1-2.
4. Reinstall the battery.
5. Plug the power cord and turn ON the computer.
6. Hold down the key during the boot process and enter BIOS setup to re-enter data.



Except when clearing the RTC RAM, never remove the cap on CLRRTC jumper default position. Removing the cap will cause system boot failure!

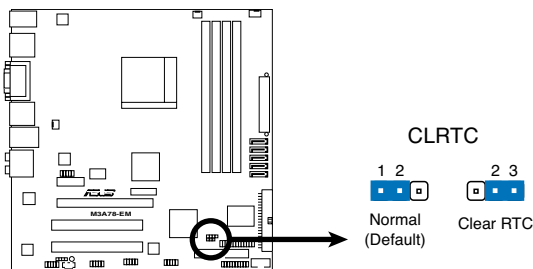

M3A78-EM Clear RTC RAM



You do not need to clear the RTC when the system hangs due to overclocking. For system failure due to overclocking, use the C.P.R. (CPU Parameter Recall) feature. Shut down and reboot the system so the BIOS can automatically reset parameter settings to default values.

1.10 Connectors

1.10.1 Rear panel connectors

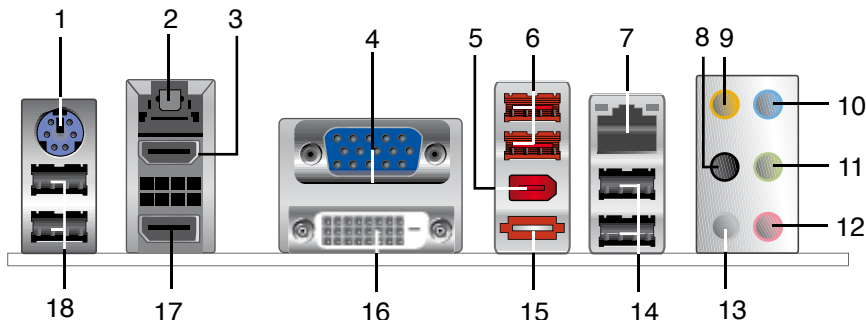

1. **PS/2 keyboard/Mouse Combo port (purple).** This port is for a PS/2 keyboard or mouse.
2. **Optical S/PDIF Out port.** This port connects an external audio output device via a optical S/PDIF cable.
3. **HDMI port.** This port is for a High-Definition Multimedia Interface (HDMI) connector, and is HDCP compliant allowing playback of HD DVD, Blu-Ray and other protected content.



- This motherboard comes with dual-VGA output that features different display on 2 monitors at the same time if you connect 2 monitors to both the onboard VGA and DVI-D/HDMI out ports.
- DVI-D can't be converted to output RGB Signal to CRT and isn't compatible with DVI-I.
- To play HD DVD or Blu-Ray Disc, make sure to use an HDCP compliant monitor.

Playback of HD DVD and Blu-Ray Discs

The speed and bandwidth of the CPU/Memory, DVD player, and drivers will affect the playback quality. Using the CPU/Memory of higher speed and bandwidth with the higher-version DVD player and drivers will upgrade the playback quality.

4. **Video Graphics Adapter (VGA) port.** This 15-pin port is for a VGA monitor or other VGA-compatible devices.
5. **IEEE 1394a port.** This 6-pin IEEE 1394a port provides high-speed connectivity for audio/video devices, storage peripherals, PCs, or portable devices.
6. **USB 2.0 ports 3 and 4.** These two 4-pin Universal Serial Bus (USB) ports are available for connecting USB 2.0 devices.

7. **LAN (RJ-45) port.** This port allows Gigabit connection to a Local Area Network (LAN) through a network hub.

LAN port LED indications

Activity/Link Speed LED			
Status	Description	Status	Description
OFF	No link	OFF	10 Mbps connection
ORANGE	Linked	ORANGE	100 Mbps connection
BLINKING	Data activity	GREEN	1 Gbps connection

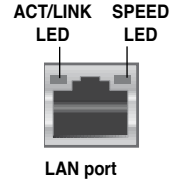

8. **Rear Speaker Out port (black).** This port connects the rear speakers in a 4-channel, 6-channel, or 8-channel audio configuration.
9. **Center/Subwoofer port (orange).** This port connects the center/subwoofer speakers.
10. **Line In port (light blue).** This port connects the tape, CD, DVD player, or other audio sources.
11. **Line Out port (lime).** This port connects a headphone or a speaker. In 4-channel, 6-channel, and 8-channel configuration, the function of this port becomes Front Speaker Out.
12. **Microphone port (pink).** This port connects a microphone.
13. **Side Speaker Out port (gray).** This port connects the side speakers in an 8-channel audio configuration.



Refer to the audio configuration table for the function of the audio ports in 2, 4, 6, or 8-channel configuration.

Audio 2, 4, 6, or 8-channel configuration

Port	Headset 2-channel	4-channel	6-channel	8-channel
Light Blue	Line In	Line In	Line In	Line In
Lime	Line Out	Front Speaker Out	Front Speaker Out	Front Speaker Out
Pink	Mic In	Mic In	Mic In	Mic In
Orange	–	–	Center/Subwoofer	Center/Subwoofer
Black	–	Rear Speaker Out	Rear Speaker Ou	Rear Speaker Out
Gray	–	–	–	Side Speaker Out



Ensure the audio device of Sound playback is **Realtek High Definition Audio** (the name may be different based on the OS). Go to **Start > Control Panel > Sounds and Audio Devices > Sound Playback** to configure the setting.

- 14. USB 2.0 ports 1 and 2.** These two 4-pin Universal Serial Bus (USB) ports are available for connecting USB 2.0 devices.
- 15. External SATA port.** This port connects to an external Serial ATA hard disk drive.



DO NOT insert different connectors to the external SATA port.



To use hot-plug, set the **OnChip SATA Type** in the BIOS settings to **[AHCI]**. See section 2.3.6 SATA Configuration for details.

- 16. DVI-D Out port.** This port is for any DVI-D compatible device and is HDCP compliant allowing playback of HD DVD, Blu-Ray and other protected content.
- 17. DisplayPort.** This port connects a display monitor or a home-theater system.



- Due to chipset limitation, DisplayPort on this motherboard only supports video signals.
 - Due to chipset limitation, when a DisplayPort monitor is plugged in, PCIe x16 slot will not be able to support an add-on card. Set the **DisplayPort Configuration** item in the BIOS to **[Enabled]** to use the DisplayPort. See page 2-26 for details.
-

- 18. USB 2.0 ports 5 and 6.** These two 4-pin Universal Serial Bus (USB) ports are available for connecting USB 2.0 devices.

1.10.2 Internal connectors

1. Floppy disk drive connector (34-1 pin FLOPPY)

This connector is for the provided floppy disk drive (FDD) signal cable. Insert one end of the cable to this connector, then connect the other end to the signal connector at the back of the floppy disk drive.



Pin 5 on the connector is removed to prevent incorrect cable connection when using an FDD cable with a covered Pin 5.

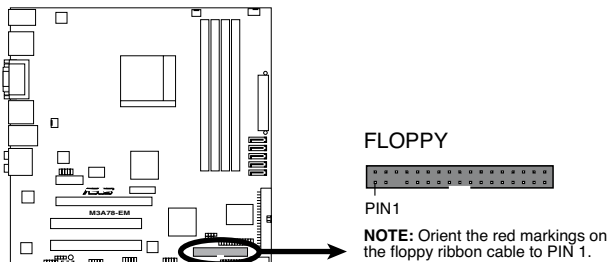

M3A78-EM Floppy Disk Drive Connector

2. Serial port connector (10-1 pin COM1)

The connector is for a serial (COM) port. Connect the serial port module cable to the connector, then install the module to a slot opening at the back of the system chassis.



The serial port bracket (COM1) is purchased separately.

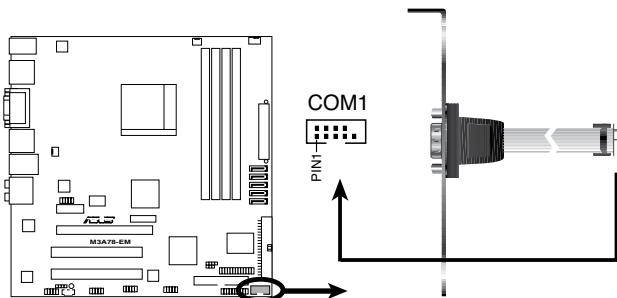

M3A78-EM COM Port Connector

3. IDE connector (40-1 pin PRI_IDE)

The onboard IDE connector is for an Ultra DMA 133/100/66 signal cable. There are three connectors on each Ultra DMA 133/100/66 signal cable: blue, black, and gray. Connect the blue connector to the motherboard's IDE connector, then select one of the following modes to configure your device(s).

	Drive jumper setting	Mode of device(s)	Cable connector
Single device	Cable-Select or Master	-	Black
Two devices	Cable-Select	Master	Black
		Slave	Gray
	Master	Master	Black or gray
	Slave	Slave	



- Pin 20 on the IDE connector is removed to match the covered hole on the Ultra DMA cable connector. This prevents incorrect insertion when you connect the IDE cable.
- Use the 80-conductor IDE cable for Ultra DMA 133/100/66 IDE devices.



If any device jumper is set as "Cable-Select," make sure all other device jumpers have the same setting.

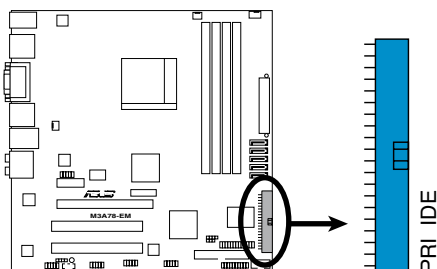

M3A78-EM IDE Connector

4. Serial ATA connectors (7-pin SATA1, SATA2, SATA3, SATA5, SATA6)

These connectors are for the Serial ATA signal cables for Serial ATA 3Gb/s hard disk and optical disk drives. The Serial ATA 3Gb/s is backward compatible with Serial ATA 1.5Gb/s specification. The data transfer rate of the Serial ATA 3Gb/s is faster than the standard parallel ATA with 133 MB/s (Ultra DMA133).

If you install Serial ATA hard disk drives, you can create a RAID 0, RAID 1, and RAID 10 configuration through the onboard SB700 controller.

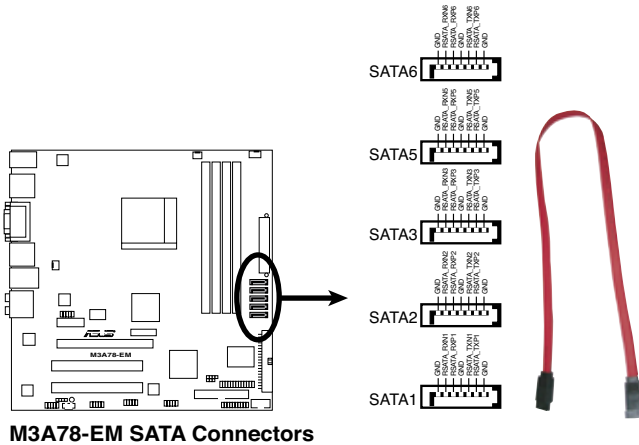

M3A78-EM SATA Connectors



Important note on Serial ATA

Install the Windows® XP Service Pack 1 before using Serial ATA.



- For detailed instructions on how to configure RAID 0, RAID 1, and RAID 10, refer to the RAID manual in the Support DVD.
- If you intend to create a Serial ATA RAID set using these connectors, set the **OnChip SATA Type** item in the BIOS to **[RAID]**. See page 2-20 for details.
- If you want to do the task as GHOST, we suggest you connect the original disk to the SATA5 or SATA6.

5. Power, CPU, and Chassis Fan connectors (3-pin PWR_FAN, 4-pin CPU_FAN, 3-pin CHA_FAN)

The fan connectors support cooling fans of 350mA~740mA (8.88W max.) or a total of 1A~2.22A (26.64W max.) at +12V. Connect the fan cables to the fan connectors on the motherboard, making sure that the black wire of each cable matches the ground pin of the connector.



Do not forget to connect the fan cables to the fan connectors. Insufficient air flow inside the system may damage the motherboard components. These are not jumpers! DO NOT place jumper caps on the fan connectors.



Only CPU Fan supports Q-Fan.

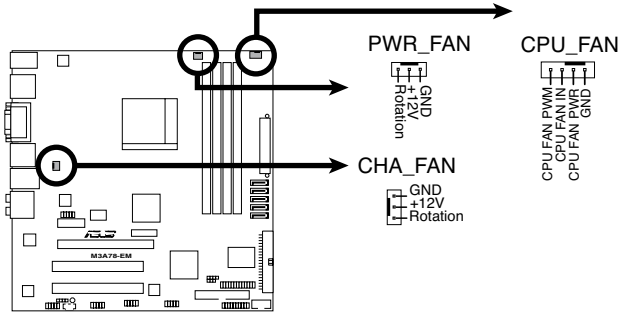

M3A78-EM Fan Connectors

6. USB connectors (10-1 pin USB78, USB910, USB1112)

These connectors are for USB 2.0 ports. Connect the USB module cable to any of these connectors, then install the module to a slot opening at the back of the system chassis. These USB connectors comply with USB 2.0 specification that supports up to 480 Mbps connection speed.

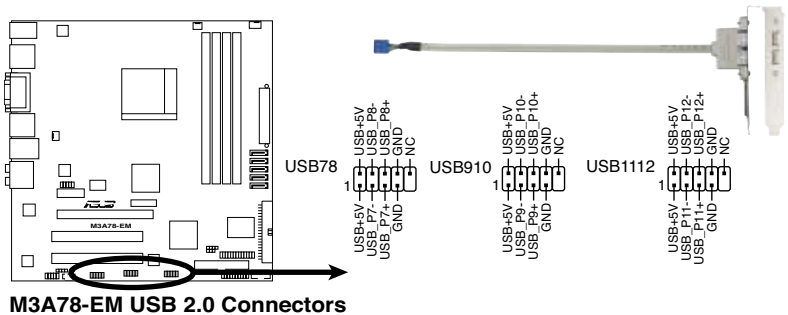

Never connect a 1394 cable to the USB connectors. Doing so will damage the motherboard!



The USB 2.0 module is purchased separately.

7. Optical drive audio in connector (4-pin CD)

This connector allows you to receive stereo audio input from sound sources such as a CD-ROM, TV tuner, or MPEG card.

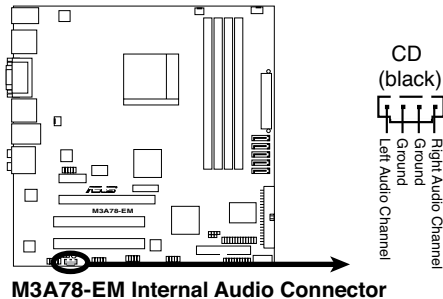

8. Digital audio connector (4-1 pin SPDIF_OUT)

This connector is for an additional Sony/Philips Digital Interface (S/PDIF) port(s). Connect the HDMI module cable to this connector, then install the module to a slot opening at the back of the system chassis.

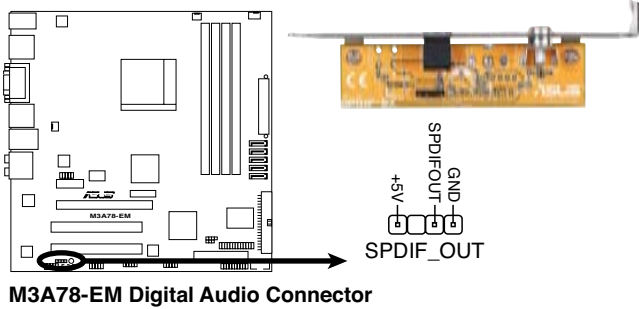

M3A78-EM Digital Audio Connector



Ensure the audio device of Sound playback is **Realtek High Definition Audio** (the name may be different based on the OS). Go to **Start > Control Panel > Sounds and Audio Devices > Sound Playback** to configure the setting.

9. LPT connector

The LPT (Line Printing Terminal) connector supports devices such as a printer. LPT standardizes as IEEE 1284, which is the parallel port interface on IBM PC-compatible computers.

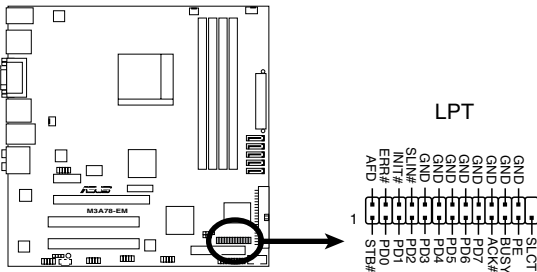

M3A78-EM Parallel Port Connector

10. Front panel audio connector (10-1 pin AAFP)

This connector is for a chassis-mounted front panel audio I/O module that supports either High Definition Audio or AC'97 audio standard. Connect one end of the front panel audio I/O module cable to this connector.

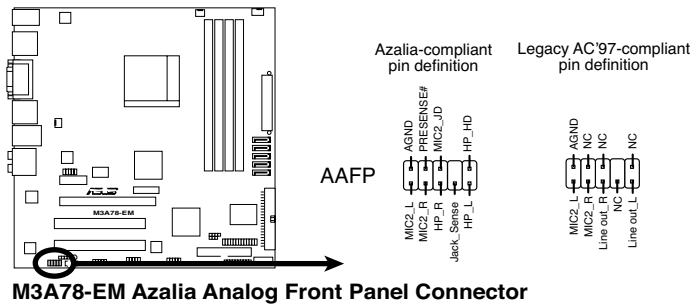

- We recommend that you connect a high-definition front panel audio module to this connector to avail of the motherboard high-definition audio capability.
- If you want to connect a high-definition front panel audio module to this connector, ensure that the **Front Panel Select** item in the BIOS is set to **[HD Audio]**; if you want to connect an AC'97 front panel audio module to this connector, set the item to **[AC97]**. See page 2-27 for details.
- Make sure the audio device of Sound playback is **Realtek High Definition Audio (the name may be different based on the OS)**. Go to **Start > Control Panel > Sounds and Audio Devices > Sound Playback** to configure the setting.

11. Chassis intrusion connector (4-1 pin CHASSIS)

This connector is for a chassis-mounted intrusion detection sensor or switch. Connect one end of the chassis intrusion sensor or switch cable to this connector. The chassis intrusion sensor or switch sends a high-level signal to this connector when a chassis component is removed or replaced. The signal is then generated as a chassis intrusion event.

By default, the pins labeled “Chassis Signal” and “GND” are shorted with a jumper cap. Remove the jumper caps only when you intend to use the chassis intrusion detection feature.

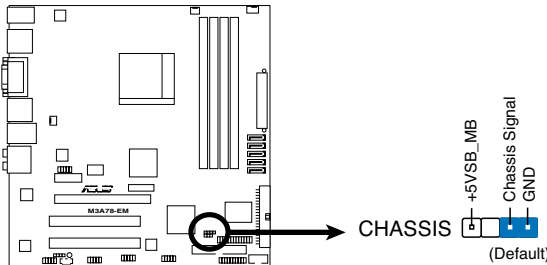

M3A78-EM Intrusion Connector

12. IEEE 1394a port connector (10-1 pin IE1394_1)

This connector is for a IEEE 1394a port. Connect the IEEE 1394a module cable to this connector, then install the module to a slot opening at the back of the system chassis.

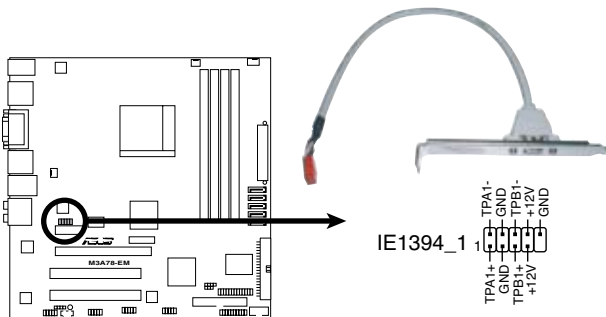

M3A78-EM IEEE 1394a Connector



Never connect a USB cable to the IEEE 1394a connector. Doing so will damage the motherboard!



You can attach a FireWire/1394 cable to this connector if your chassis supports the front panel IEEE 1394 port. Connect the 1394 cable to ASUS Q-Connector (1394, red) first, and then install the Q-Connector (1394) to the 1394 connector onboard.

13. ATX power connectors (24-pin EATXPWR, 4-pin ATX12V)

These connectors are for an ATX power supply. The plugs from the power supply are designed to fit these connectors in only one orientation. Find the proper orientation and push down firmly until the connectors completely fit.

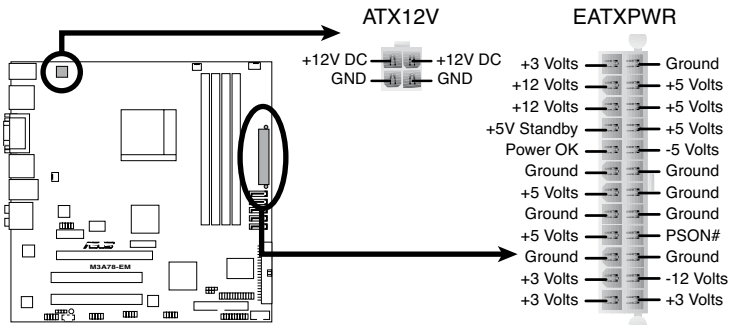

M3A78-EM ATX Power Connector



- We recommend that you use an ATX 12 V Specification 2.0-compliant power supply unit (PSU) with a minimum of 300 W power rating. This PSU type has 24-pin and 4-pin power plugs.
- If you intend to use a PSU with 20-pin and 4-pin power plugs, make sure that the 20-pin power plug can provide at least 15 A on +12 V and that the PSU has a minimum power rating of 300 W. The system may become unstable or may not boot up if the power is inadequate.
- Do not forget to connect the 4-pin ATX +12 V power plug; otherwise, the system will not boot up.
- We recommend that you use a PSU with higher power output when configuring a system with more power-consuming devices. The system may become unstable or may not boot up if the power is inadequate.
- If you are uncertain about the minimum power supply requirement for your system, refer to the Recommended Power Supply Wattage Calculator at <http://support.asus.com/PowerSupplyCalculator/PSCalculator.aspx?SLanguage=en-us> for details.
- You must install a PSU with a higher power rating if you intend to install additional devices.

14. System panel connector (20-8 pin PANEL)

This connector supports several chassis-mounted functions.

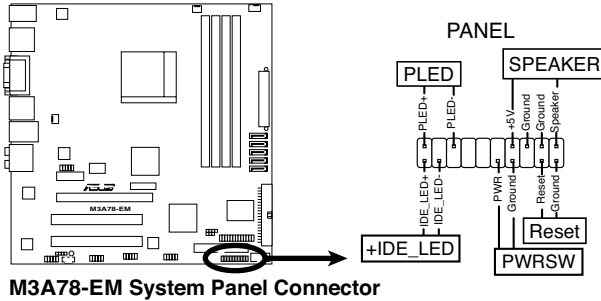

- **System power LED**
This 2-pin connector is for the system power LED. Connect the chassis power LED cable to this connector. The system power LED lights up when you turn on the system power, and blinks when the system is in sleep mode.
- **Hard disk drive activity LED**
This 2-pin connector is for the HDD Activity LED. Connect the HDD Activity LED cable to this connector. The IDE LED lights up or flashes when data is read from or written to the HDD.
- **System warning speaker**
This 4-pin connector is for the chassis-mounted system warning speaker. The speaker allows you to hear system beeps and warnings.
- **Power/Soft-off button**
This 2-pin connector is for the system power button. Pressing the power button turns the system ON or puts the system in SLEEP or SOFT-OFF mode depending on the BIOS settings. Pressing the power switch for more than four seconds while the system is ON turns the system OFF.
- **Reset button**
This 2-pin connector is for the chassis-mounted reset button for system reboot without turning off the system power.

Q-Connector (system panel)

You can use ASUS Q-Connector to connect / disconnect chassis front panel cables by only a few steps. Directions below shows how to install ASUS Q-Connector.

Step1.

Connect correct front panel to ASUS Q-Connector first. You can refer to the marking on Q-Connector itself to know the detail pin definition.

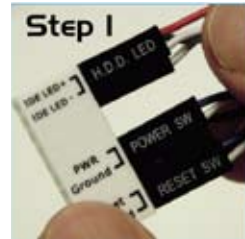

Step2.

Properly install the ASUS Q-Connector to the System panel connector.



Step3.

Front panel functions are enabled.



This chapter tells how to change the system settings through the BIOS Setup menus. Detailed descriptions of the BIOS parameters are also provided.

BIOS setup **2**

2.1 Managing and updating your BIOS

The following utilities allow you to manage and update the motherboard Basic Input/Output System (BIOS) setup.

1. **ASUS AFUDOS:** Updates the BIOS in DOS mode using a bootable floppy disk.
2. **ASUS CrashFree BIOS 3:** Updates the BIOS using a bootable floppy disk, a USB flash disk or the motherboard Support DVD when the BIOS file fails or gets corrupted.
3. **ASUS EZ Flash 2:** Updates the BIOS using a floppy disk or a USB flash disk during POST.
4. **ASUS Update:** Updates the BIOS in Windows® environment.

Refer to the corresponding sections for details on these utilities.



Save a copy of the original motherboard BIOS file to a bootable floppy disk in case you need to restore the BIOS in the future. Copy the original motherboard BIOS using the ASUS Update or AFUDOS utilities.

2.1.1 Creating a bootable floppy disk

1. Do either one of the following to create a bootable floppy disk.

DOS environment

- a. Insert a 1.44MB floppy disk into the drive.
- b. At the DOS prompt, type `format A: /s` then press <Enter>.

Windows® XP environment

- a. Insert a 1.44 MB floppy disk to the floppy disk drive.
- b. Click **Start** from the Windows® desktop, then select My Computer.
- c. Select the 3 1/2 Floppy Drive icon.
- d. Click File from the menu, then select Format. A Format 3 1/2 Floppy Disk window appears.
- e. Windows® XP users: Select Create an MS-DOS startup disk from the format options field, then click **Start**.

Windows® Vista environment

- a. Insert a formatted, high density 1.44 MB floppy disk to the floppy disk drive.
 - b. Click  from the Windows® desktop, then select **Computer**.
 - c. Right-click **Floppy Disk Drive** then click **Format** to display the **Format 3 1/2 Floppy** dialog box.
 - d. Select the **Create an MS-DOS startup disk** check box.
 - e. Click **Start**.
-
2. Copy the original or the latest motherboard BIOS file to the bootable floppy disk.

2.1.2 AFUDOS utility

The AFUDOS utility allows you to update the BIOS file in DOS environment using a bootable floppy disk with the updated BIOS file. This utility also allows you to copy the current BIOS file that you can use as backup when the BIOS fails or gets corrupted during the updating process.

Copying the current BIOS

To copy the current BIOS file using the AFUDOS utility:



-
- Make sure that the floppy disk is not write-protected and has at least 1.2 MB free space to save the file.
 - The succeeding BIOS screens are for reference only. The actual BIOS screen displays may not be same as shown.
-

1. Copy the AFUDOS utility (afudos.exe) from the motherboard Support DVD to the bootable floppy disk you created earlier.
2. Boot the system in DOS mode, then at the prompt type:

```
afudos /o[filename]
```

where the [filename] is any user-assigned filename no more than eight alphanumeric characters for the main filename and three alphanumeric characters for the extension name.

```
A:\>afudos /oOLDBIOS1.rom
```

Main filename Extension name

3. Press <Enter>. The utility copies the current BIOS file to the floppy disk.

```
A:\>afudos /oOLDBIOS1.rom
AMI Firmware Update Utility - Version 1.19 (ASUS V2.07(03.11.24BB))
Copyright (C) 2002 American Megatrends, Inc. All rights reserved.
  Reading flash ..... done
  Write to file..... ok
A:\>
```

The utility returns to the DOS prompt after copying the current BIOS file.

Updating the BIOS file

To update the BIOS file using the AFUDOS utility:

1. Visit the ASUS website at www.asus.com and download the latest BIOS file for the motherboard. Save the BIOS file to a bootable floppy disk.



Write the BIOS filename on a piece of paper. You need to type the exact BIOS filename at the DOS prompt.

2. Copy the AFUDOS utility (afudos.exe) from the motherboard Support DVD to the bootable floppy disk you created earlier or a USB flash disk.
3. Boot the system in DOS mode, then at the prompt type:

```
afudos /i[filename]
```

where [filename] is the latest or the original BIOS file on the bootable floppy disk.

```
A:\>afudos /iM3A78EM.rom
```

4. The utility verifies the file and starts updating the BIOS.

```
A:\>afudos /iM3A78EM.rom
AMI Firmware Update Utility - Version 1.19 (ASUS V2.07 (03.11.24BB))
Copyright (C) 2002 American Megatrends, Inc. All rights reserved.

WARNING!! Do not turn off power during flash BIOS
Reading file ..... done
Reading flash ..... done

Advance Check .....
Erasing flash ..... done
Writing flash ..... 0x0008CC00 (9%)
```



Do not shut down or reset the system while updating the BIOS to prevent system boot failure!

5. The utility returns to the DOS prompt after the BIOS update process is completed. Reboot the system from the hard disk drive.

```
A:\>afudos /iM3A78EM.rom
AMI Firmware Update Utility - Version 1.19 (ASUS V2.07 (03.11.24BB))
Copyright (C) 2002 American Megatrends, Inc. All rights reserved.

WARNING!! Do not turn off power during flash BIOS
Reading file ..... done
Reading flash ..... done

Advance Check .....
Erasing flash ..... done
Writing flash ..... done
Verifying flash .... done

Please restart your computer

A:\>
```

2.1.3 ASUS CrashFree BIOS 3 utility

The ASUS CrashFree BIOS 3 is an auto recovery tool that allows you to restore the BIOS file when it fails or gets corrupted during the updating process. You can update a corrupted BIOS file using the motherboard Support DVD, the floppy disk or the USB flash disk that contains the updated BIOS file.



- Prepare the motherboard Support DVD, the floppy disk or the USB flash disk containing the updated motherboard BIOS before using this utility.
- Ensure that you rename the original or updated BIOS file in the floppy disk or the USB flash disk to **M3A78EM.ROM**.

Recovering the BIOS from a floppy disk

To recover the BIOS from a floppy disk:

1. Turn on the system.
2. Insert the floppy disk with the original or updated BIOS file to the floppy disk drive.
3. The utility displays the following message and automatically checks the floppy disk for the original or updated BIOS file.

```
Bad BIOS checksum. Starting BIOS recovery...
Checking for floppy...
```

When found, the utility reads the BIOS file and starts flashing the corrupted BIOS file.

```
Bad BIOS checksum. Starting BIOS recovery...
Checking for floppy...
Floppy found!
Reading file "M3A78EM.ROM". Completed.
Start flashing...
```

4. Restart the system after the utility completes the updating process.

Recovering the BIOS from the Support DVD

To recover the BIOS from the Support DVD:

1. Remove any floppy disk from the floppy disk drive, then turn on the system.
2. Insert the Support DVD to the optical drive.
3. The utility displays the following message and automatically checks the floppy disk for the original or updated BIOS file.

```
Bad BIOS checksum. Starting BIOS recovery...
Checking for floppy...
```

When no floppy disk is found, the utility automatically checks the optical drive for the original or updated BIOS file. The utility then updates the corrupted BIOS file.

```
Bad BIOS checksum. Starting BIOS recovery...
Checking for floppy...
Floppy not found!
Checking for CD-ROM...
CD-ROM found!
Reading file "M3A78EM.ROM". Completed.
Start flashing...
```

4. Restart the system after the utility completes the updating process.



The recovered BIOS may not be the latest BIOS version for this motherboard. Visit the ASUS website at www.asus.com to download the latest BIOS file.

Recovering the BIOS from the USB flash disk

To recover the BIOS from the USB flash disk:

1. Insert the USB flash disk that contains BIOS file to the USB port.
2. Turn on the system.
3. The utility will automatically checks the devices for the BIOS file. When found, the utility reads the BIOS file and starts flashing the corrupted BIOS file.
4. Restart the system after the utility completes the updating process.



- Only the USB flash disk with FAT 32/16 format and single partition can support ASUS CrashFree BIOS 3. The device size should be smaller than 8GB.
- DO NOT shut down or reset the system while updating the BIOS! Doing so can cause system boot failure!

2.1.4 ASUS EZ Flash 2 utility

The ASUS EZ Flash 2 feature allows you to update the BIOS without having to go through the long process of booting from a floppy disk and using a DOS-based utility. The EZ Flash 2 utility is built-in the BIOS chip so it is accessible by pressing **<Alt> + <F2>** during the Power-On Self Tests (POST).

To update the BIOS using EZ Flash 2:

1. Visit the ASUS website at www.asus.com to download the latest BIOS file for the motherboard.
2. Save the BIOS file to a floppy disk or a USB flash disk, then restart the system.
3. You can launch the EZ Flash 2 by two methods.
 - (1) Insert the floppy disk / USB flash disk that contains the BIOS file to the floppy disk drive or the USB port.

Press **<Alt> + <F2>** during POST to display the following.

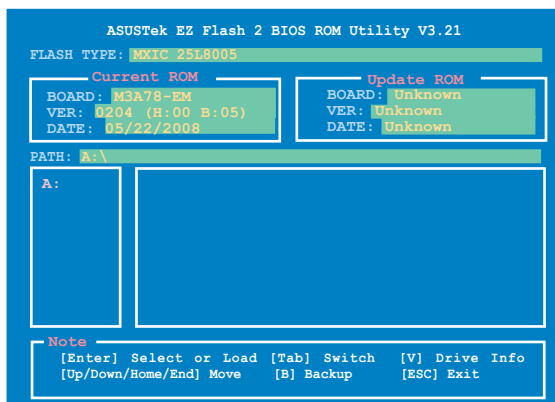

- (2) Enter BIOS setup program. Go to the **Tools** menu then select **EZ Flash2** and press **<Enter>**.

You can switch between drives by pressing **<Tab>** before the correct file is found. Then press **<Enter>**.

4. When the correct BIOS file is found, EZ Flash 2 performs the BIOS update process and automatically reboots the system when done.



-
- This function can support devices such as USB flash disk, or floppy disk with **FAT 32/16** format and single partition only.
 - **DO NOT** shut down or reset the system while updating the BIOS to prevent system boot failure!
-

2.1.5 ASUS Update utility

The ASUS Update is a utility that allows you to manage, save, and update the motherboard BIOS in Windows® environment. The ASUS Update utility allows you to:

- Save the current BIOS file
- Download the latest BIOS file from the Internet
- Update the BIOS from an updated BIOS file
- Update the BIOS directly from the Internet, and
- View the BIOS version information.

This utility is available in the Support DVD that comes with the motherboard package.



ASUS Update requires an Internet connection either through a network or an Internet Service Provider (ISP).

Installing ASUS Update

To install ASUS Update:

1. Place the Support DVD in the optical drive. The Drivers menu appears.
2. Click the Utilities tab, then click Install ASUS Update VX.XX.XX. See page 3-4 for the Utilities screen menu.
3. The ASUS Update utility is copied to your system.



Quit all Windows® applications before you update the BIOS using this utility.

Updating the BIOS through the Internet

To update the BIOS through the Internet:

1. Launch the ASUS Update utility from the Windows® desktop by clicking **Start > Programs > ASUS > ASUSUpdate > ASUSUpdate**. The ASUS Update main window appears.

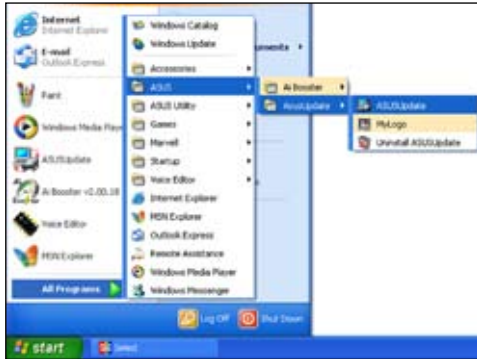

2. Select Update BIOS from the Internet option from the drop-down menu, then click **Next**.
3. Select the ASUS FTP site nearest you to avoid network traffic, or click Auto Select. Click **Next**.



- From the FTP site, select the BIOS version that you wish to download. Click **Next**.
- Follow the screen instructions to complete the update process.



The ASUS Update utility is capable of updating itself through the Internet. Always update the utility to avail all its features.



Updating the BIOS through a BIOS file

To update the BIOS through a BIOS file:

- Launch the ASUS Update utility from the Windows® desktop by clicking **Start > Programs > ASUS > ASUSUpdate > ASUSUpdate**. The ASUS Update main window appears.
- Select Update BIOS from a file option from the drop-down menu, then click **Next**.



- Locate the BIOS file from the Open window, then click **Open**.
- Follow the screen instructions to complete the update process.

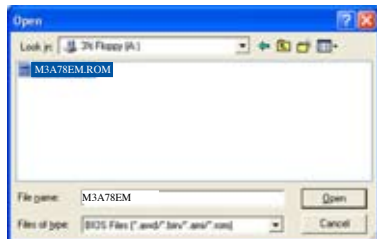

2.2 BIOS setup program

This motherboard supports a programmable Serial Peripheral Interface (SPI) chip that you can update using the provided utility described in section “2.1 Managing and updating your BIOS.”

Use the BIOS Setup program when you are installing a motherboard, reconfiguring your system, or prompted to “Run Setup”. This section explains how to configure your system using this utility.

Even if you are not prompted to use the Setup program, you can change the configuration of your computer in the future. For example, you can enable the security password feature or change the power management settings. This requires you to reconfigure your system using the BIOS Setup program so that the computer can recognize these changes and record them in the CMOS RAM of the SPI chip.

The SPI chip on the motherboard stores the Setup utility. When you start up the computer, the system provides you with the opportunity to run this program. Press during the Power-On Self-Test (POST) to enter the Setup utility; otherwise, POST continues with its test routines.

If you wish to enter Setup after POST, reboot the system by doing any of the following procedures:

- Restart using the OS standard shut-down procedure.
- Press <Ctrl>+<Alt>+ simultaneously.
- Press the reset button on the system chassis.
- Press the power button to turn the system off then back on.



Using the **power button**, **reset button**, or the <Ctrl>+<Alt>+ keys to force reset from a running operating system can cause damage to your data or system. We recommend to always shut-down the system properly from the operating system.

The Setup program is designed to make it as easy to use as possible. Being a menu-driven program, it lets you scroll through the various sub-menus and make your selections from the available options using the navigation keys.



-
- The default BIOS settings for this motherboard apply for most conditions to ensure optimum performance. If the system becomes unstable after changing any BIOS settings, load the default settings to ensure system compatibility and stability. Select the **Load Default Settings** item under the Exit Menu. See section “2.8 Exit Menu.”
 - The BIOS setup screens shown in this section are for reference purposes only, and may not exactly match what you see on your screen.
 - Visit the ASUS website at www.asus.com to download the latest BIOS file for this motherboard.
-

2.2.1 BIOS menu screen

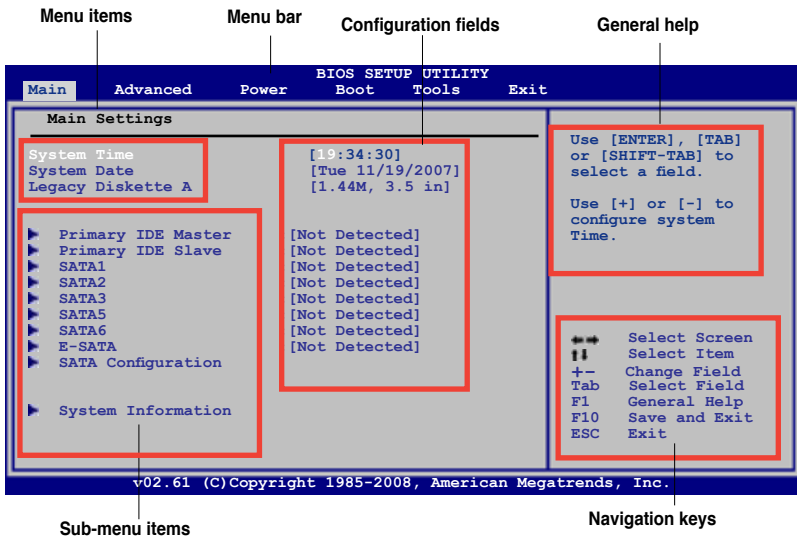

2.2.2 Menu bar

The menu bar on top of the screen has the following main items:

Main	For changing the basic system configuration
Advanced	For changing the advanced system settings
Power	For changing the advanced power management (APM) configuration
Boot	For changing the system boot configuration
Tools	For changing the system tools configuration
Exit	For selecting the exit options and loading default settings

To select an item on the menu bar, press the right or left arrow key on the keyboard until the desired item is highlighted.



- The BIOS setup screens shown in this chapter are for reference purposes only, and may not exactly match what you see on your screen.
- Visit the ASUS website (www.asus.com) to download the latest BIOS information.

2.2.3 Navigation keys

At the bottom right corner of a menu screen are the navigation keys for that particular menu. Use the navigation keys to select items in the menu and change the settings.



Some of the navigation keys differ from one screen to another.

2.2.4 Menu items

The highlighted item on the menu bar displays the specific items for that menu. For example, selecting Main shows the Main menu items.

The other items (Advanced, Power, Boot, Tools, and Exit) on the menu bar have their respective menu items.

2.2.5 Sub-menu items

A solid triangle before each item on any menu screen means that the item has a sub-menu. To display the sub-menu, select the item and press **<Enter>**.

2.2.6 Configuration fields

These fields show the values for the menu items. If an item is user-configurable, you can change the value of the field opposite the item. You cannot select an item that is not user-configurable.

A configurable field is enclosed in brackets, and is highlighted when selected. To change the value of a field, select it then press **<Enter>** to display a list of options. Refer to “2.2.8 Pop-up window.”

2.2.7 General help

At the top right corner of the menu screen is a brief description of the selected item.

2.2.8 Pop-up window

Select a menu item then press <Enter> to display a pop-up window with the configuration options for that item.

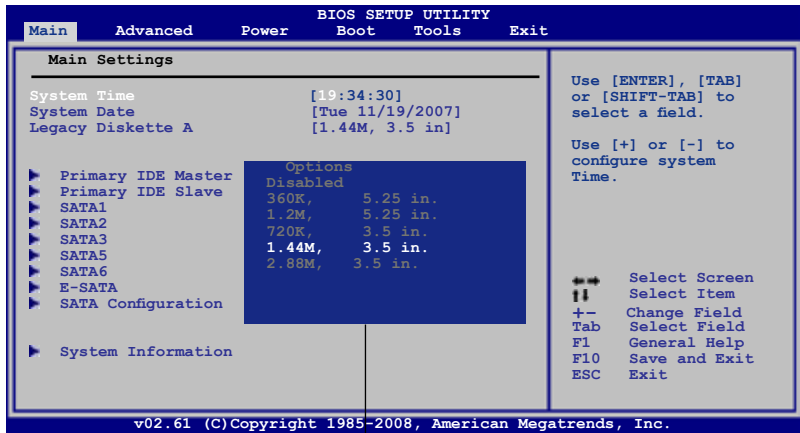

Pop-up Window

2.3 Main menu

When you enter the BIOS Setup program, the Main menu screen appears, giving you an overview of the basic system information.



Refer to section “2.2.1 BIOS menu screen” for information on the menu screen items and how to navigate through them.

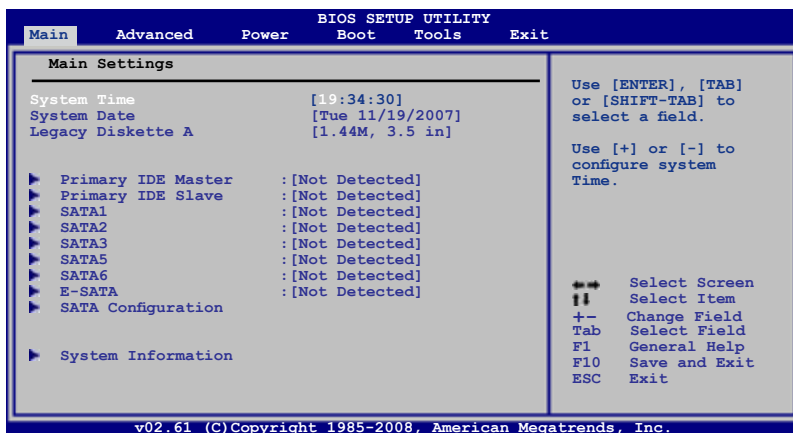

2.3.1 System Time [xx:xx:xx]

Allows you to set the system time.

2.3.2 System Date [Day xx/xx/xxxx]

Allows you to set the system date.

2.3.3 Legacy Diskette A [1.44M, 3.5 in.]

Sets the type of floppy drive installed. Configuration options: [Disabled] [360K , 5.25 in.] [1.2M , 5.25 in.] [720K , 3.5 in.] [1.44M, 3.5 in.] [2.88M , 3.5 in.]

2.3.4 Primary IDE Master/Slave

While entering Setup, the BIOS automatically detects the presence of IDE devices. There is a separate sub-menu for each IDE device. Select a device item then press <Enter> to display the IDE device information.



The BIOS automatically detects the values opposite the dimmed items (Device, Vendor, Size, LBA Mode, Block Mode, PIO Mode, Async DMA, Ultra DMA, and SMART monitoring). These values are not user-configurable. These items show Not Detected if no IDE device is installed in the system.

Type [Auto]

Selects the type of IDE drive. Setting to [Auto] allows automatic selection of the appropriate IDE device type. Select [CDROM] if you are specifically configuring a CD-ROM drive. Select [ARMD] (ATAPI Removable Media Device) if your device is either a ZIP, LS-120, or MO drive.

Configuration options: [Not Installed] [Auto] [CDROM] [ARMD]

LBA/Large Mode [Auto]

Enables or disables the LBA mode. Setting to [Auto] enables the LBA mode if the device supports this mode, and if the device was not previously formatted with LBA mode disabled. Configuration options: [Disabled] [Auto]

Block (Multi-Sector Transfer) M [Auto]

Enables or disables data multi-sectors transfers. When set to [Auto], the data transfer from and to the device occurs multiple sectors at a time if the device supports multi-sector transfer feature. When set to [Disabled], the data transfer from and to the device occurs one sector at a time.

Configuration options: [Disabled] [Auto]

PIO Mode [Auto]

Selects the PIO mode.

Configuration options: [Auto] [0] [1] [2] [3] [4]

DMA Mode [Auto]

Selects the DMA mode.

Configuration options: [Auto]

SMART Monitoring [Auto]

Sets the Smart Monitoring, Analysis, and Reporting Technology.

Configuration options: [Auto] [Disabled] [Enabled]

32Bit Data Transfer [Disabled]

Enables or disables 32-bit data transfer.

Configuration options: [Disabled] [Enabled]

2.3.5 SATA 1, 2, 3, 5, 6, and E-SATA

While entering Setup, the BIOS automatically detects the presence of Serial ATA devices. There is a separate sub-menu for each SATA device. Select a device item then press <Enter> to display the SATA device information.

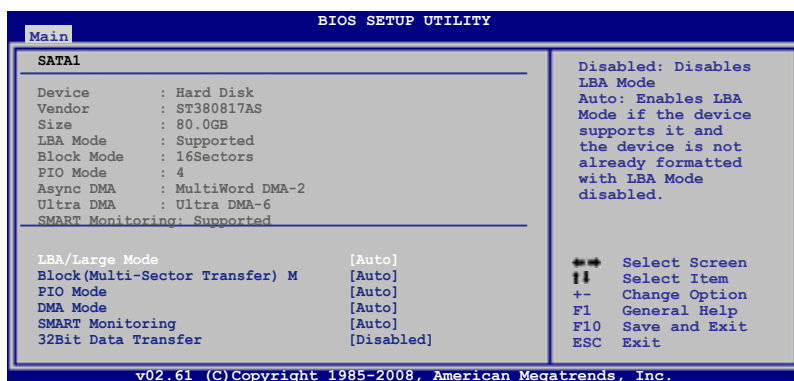

The BIOS automatically detects the values opposite the dimmed items (Device, Vendor, Size, LBA Mode, Block Mode, PIO Mode, Async DMA, Ultra DMA, and SMART monitoring). These values are not user-configurable. These items show N/A if no IDE device is installed in the system.

LBA/Large Mode [Auto]

Enables or disables the LBA mode. Setting to [Auto] enables the LBA mode if the device supports this mode, and if the device was not previously formatted with LBA mode disabled.

Configuration options: [Disabled] [Auto]

Block (Multi-sector Transfer) M [Auto]

Enables or disables data multi-sectors transfers. When set to [Auto], the data transfer from and to the device occurs multiple sectors at a time if the device supports multi-sector transfer feature. When set to [Disabled], the data transfer from and to the device occurs one sector at a time.

Configuration options: [Disabled] [Auto]

PIO Mode [Auto]

Selects the PIO mode.

Configuration options: [Auto] [0] [1] [2] [3] [4]

DMA Mode [Auto]

Selects the DMA mode.

Configuration options: [Auto]

SMART Monitoring [Auto]

Sets the Smart Monitoring, Analysis, and Reporting Technology.

Configuration options: [Auto] [Disabled] [Enabled]

32Bit Data Transfer [Disabled]

Enables or disables 32-bit data transfer.

Configuration options: [Disabled] [Enabled]

2.3.6 SATA Configuration

The **Storage Configuration** menu allows you to configure your storage device(s). Select an item then press <Enter> to display the sub-menu.

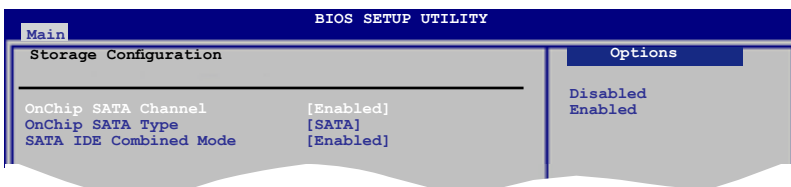

OnChip SATA Channel [Enabled]

Enables or disables OnChip SATA Channel.

Configuration options: [Disabled] [Enabled]

OnChip SATA Type [SATA]

This item appears only when you set the OnChip SATA Channel item to [Enabled].

Allows you to set the OnChip SATA Type.

Configuration options: [SATA] [RAID] [AHC]



If you want to boot the system from a hard disk drive included in a created RAID set, copy the RAID driver from the Support DVD to a floppy before you install an operating system to the selected hard disk drive.

SATA IDE Combined Mode [Enabled]

Enables or disables SATA IDE Combined Mode

Configuration options: [Disabled] [Enabled]

2.3.7 System Information

This menu gives you an overview of the general system specifications. The BIOS automatically detects the items in this menu.

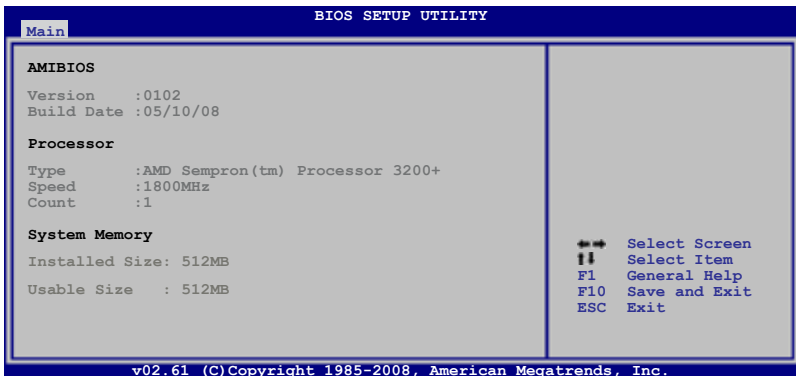

AMI BIOS

Displays the auto-detected BIOS information.

Processor

Displays the auto-detected CPU specification.

System Memory

Displays the auto-detected system memory.

2.4 Advanced menu

The **Advanced** menu items allow you to change the settings for the CPU and other system devices.



Take caution when changing the settings of the Advanced menu items. Incorrect field values can cause the system to malfunction.

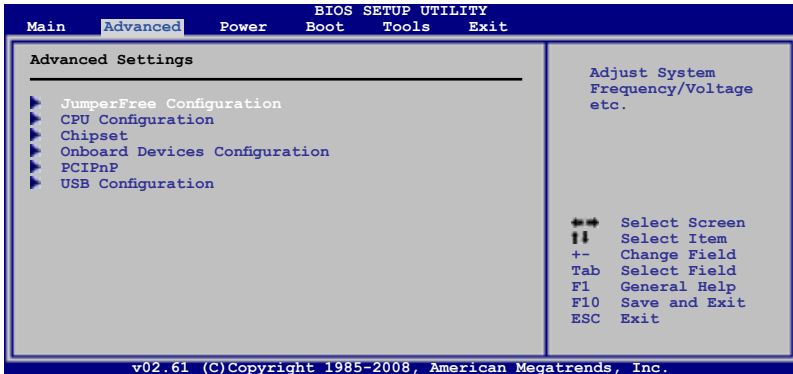

2.4.1 JumperFree Configuration

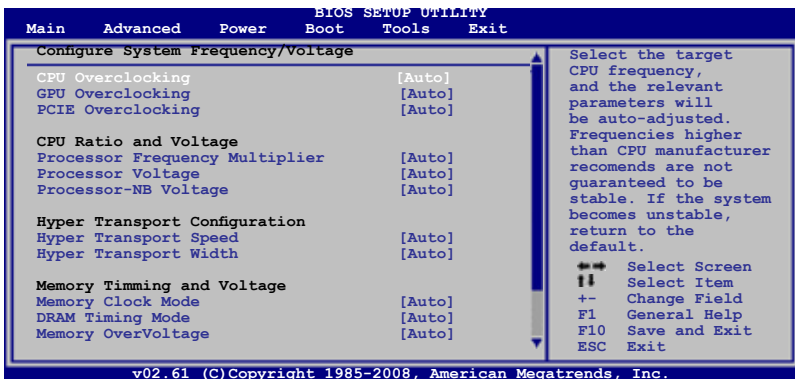

Scroll down to display the following items:



CPU Overclocking [Auto]

Allows selection of CPU overclocking options to achieve desired CPU internal frequency. Select either one of the preset overclocking. Configuration options: [Auto] [Manual] [Overclock Profile] [Test Mode]

GPU Overclocking [Auto]

Allows you to configure overclocking of GPU. Configuration options: [Auto] [Manual]

PCIe Overclocking [Auto]

Allows you to to configure overclocking of PCIe. Configuration options: [Auto] [Manual]

Processor Frequency Multiplier [Auto]

Allows you to set the processor frequency multiplier. Configuration options: [Auto] [x4.0 800MHz] [x5.0 1000MHz] [x6.0 1200MHz] [x7.0 1400MHz] [x8.0 1600MHz] [x9.0 1800MHz]

Processor Voltage [Auto]

Allows you to set the processor voltage. Configuration options: [Auto] [+50mv] [+100mv] [+150mv]

Processor-NB Voltage [Auto]

Allows you to set the processor-NB voltage. Configuration options: [Auto] [+50mv] [+100mv] [+150mv]

Hyper Transport Speed [Auto]

Allows you to set the HyperTransport link speed. Configuration options: [200MHz] [400MHz] [600MHz] [800 MHz] [1 GHz] [Auto]

Hyper Transport Width [Auto]

Allows you to set the HyperTransport link width. Configuration options: [Auto] [4 Bit] [8 Bit] [16 Bit]

Memory Clock Mode [Auto]

Allows you to set the memory clock mode. Configuration options: [Auto] [Manual]

DRAM Timing Mode [Auto]

Allows you to set the DRAM timing mode. Configuration options: [Auto] [DCT 0]

Memory Over Voltage [Auto]

Allows you to set the memory over voltage. The value ranges from 1.85000V to 2.24375V with a 0.00625V interval. Configuration options: [Auto]

Chipset Over Voltage [Auto]

Allows you to set the chipset over voltage. Configuration options: [Auto] [+50mv] [+100mv] [+150mv]

2.4.2 CPU Configuration

The items in this menu show the CPU-related information that the BIOS automatically detects.

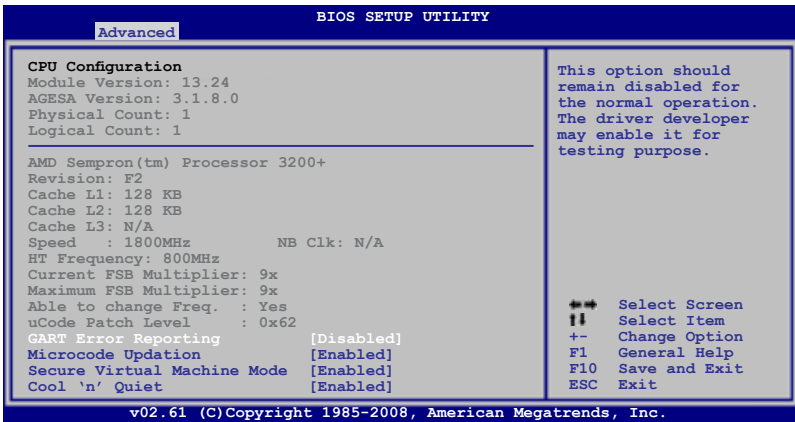

GART Error Reporting [Disabled]

This option should remain disabled for the normal operation. The driver developer may enable it for testing purpose.

Configuration options: [Disabled] [Enabled]

Microcode Updation [Enabled]

Enables or disables Microcode Updation.

Configuration options: [Disabled] [Enabled]

Secure Virtual Machine Mode [Enabled]

Enables or disables Secure Virtual Machine Mode (SVM)

Configuration options: [Disabled] [Enabled]

Cool 'n' Quiet [Enabled]

Enables or disables the AMD Cool 'n' Quiet technology.

Configuration options: [Enabled] [Disabled]

2.4.3 Chipset

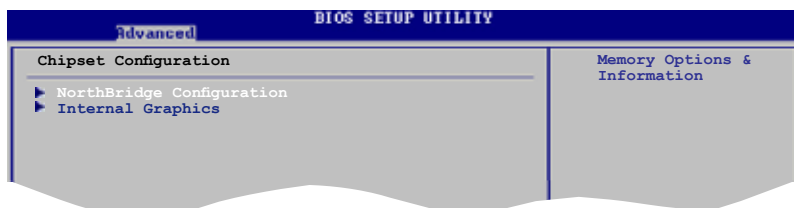

NorthBridge Configuration

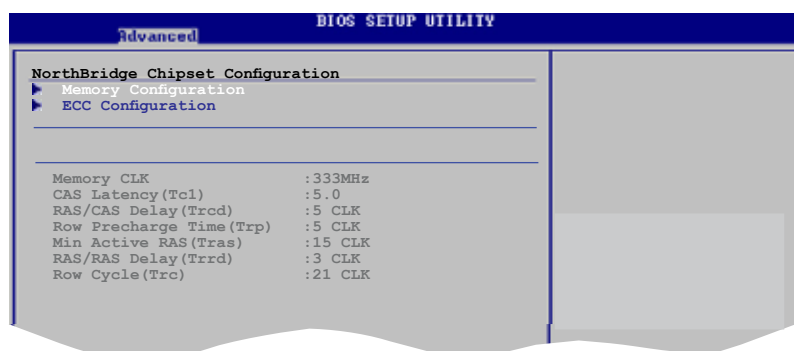

Memory Configuration

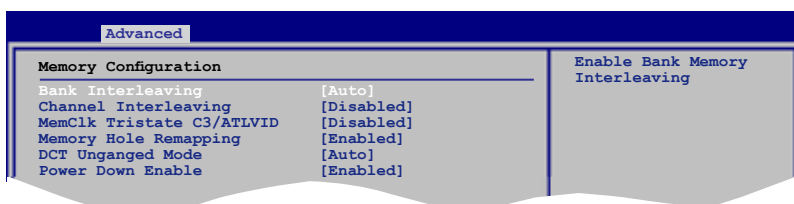

Bank Interleaving [Auto]

Allows you to enable the bank memory interleaving.

Configuration options: [Disabled] [Auto]

Channel Interleaving [Disabled]

Allows you to enable the channel memory interleaving.

Configuration options: [Disabled] [Address bits 6]

[Address bits 12] [XOR of Address bits [20:16, 6]]

[XOR of Address bits [20:16, 9]]

MemClk Tristate C3/ATLVID [Disabled]

Allows you to enable or disable MemClk Tri-Stating during C3 and Alt VID.
Configuration options: [Disabled] [Enabled]

Memory Hole Remapping [Enabled]

Allows you to enable or disable memory remapping around memory hole.
Configuration options: [Disabled] [Enabled]

DCT Unganged Mode [Auto]

Allows you to select unganged DRAM mode (64-bit width).
Configuration options: [Auto] [Always]

Power Down Enable [Enabled]

Allows you to enable or disable DDR power down mode.
Configuration options: [Disabled] [Enabled]

ECC Configuration

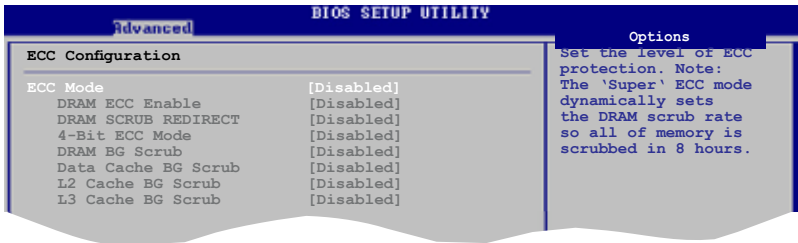

ECC Mode [Disabled]

Allows you to set the ECC mode. Configuration options: [Disabled] [Basic] [Good] [Super] [Max] [User]

Internal Graphics

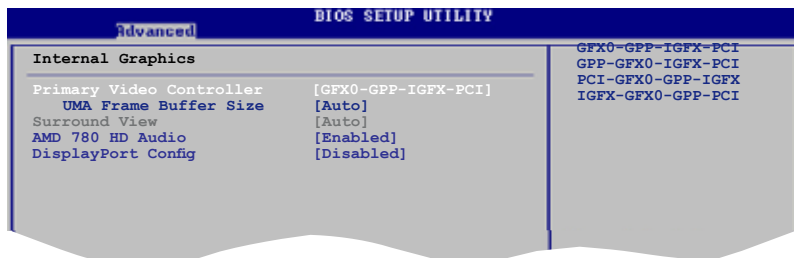

Primary Video Controller [GFX0-GPP-IGFX-PCI]

Configuration options: [GFX0-GPP-IGFX-PCI] [GPP-GFX0-IGFX-PCI]
[PCI-GFX0-GPP-IGFX] [IGFX-GFX0-GPP-PCI]



GFX0: VGA out port on a graphics card connected into a PCIe x16 slot
GPP: VGA out port on a graphics card connected into a PCIe x1 slot
IGFX: Internal VGA out port
PCI: VGA out port on a graphics card connected into a PCI slot

UMA Frame Buffer Size [Auto]

Configuration options: [Auto] [32MB] [64MB] [128MB] [256MB]

Surround View [Auto]

Allows you to disable or enable the Surround View function.

Configuration options: [Auto] [Disabled] [Enabled]



This item becomes user-configurable when you install an ATI graphics card into the PCI Express x16 slot.

AMD 780 HD Audio [Enabled]

Allows you to enable or disable AMD 780 HD audio.

Configuration options: [Enabled] [Disabled]

DisplayPort Configuration [Disabled]

Enables or disables the DisplayPort. Configuration options: [Disabled] [Enabled]

2.4.4 Onboard Device Configuration

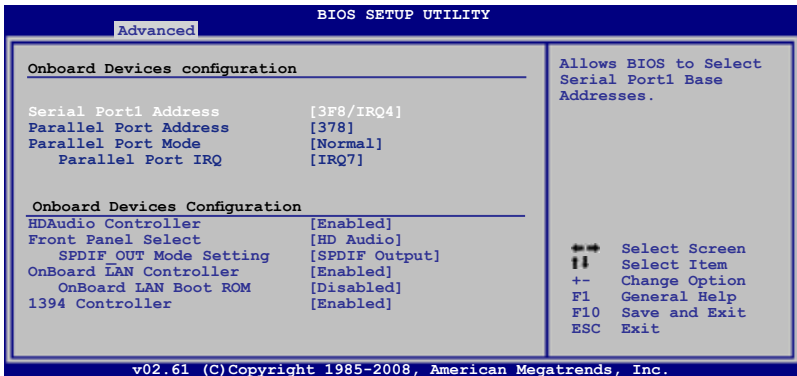

Serial Port1 Address [3F8/IRQ4]

Allows you to select the Serial Port1 base address.

Configuration options: [Disabled] [3F8/IRQ4][2F8/IRQ3] [3E8/IRQ4] [2E8/IRQ3]

Parallel Port Address [378]

Allows you to select the Parallel Port base addresses.

Configuration options: [Disabled] [378] [278] [3BC]

Parallel Port Mode [Normal]

Allows you to select the Parallel Port mode.

Configuration options: [Normal] [EPP] [ECP] [EPP+ECP]

Parallel Port IRQ [IRQ7]

Configuration options: [IRQ5] [IRQ7]

HDAudio Controller [Enabled]

Enables or disables the high definition audio controller.

Configuration options: [Enabled] [Disabled]

Front Panel Select [HD Audio]

Configuration options: [HD Audio] [AC97]

SPDIF_OUT Mode Setting [SPDIF Output]

Allows you to set the SPDIF_OUT mode.

Configuration options: [HDMI Output] [SPDIF Output]

OnBoard LAN Controller [Enabled]

Configuration options: [Enabled] [Disabled]

OnBoard LAN Boot ROM [Disabled]

Configuration options: [Disabled] [Enabled]

1394 Controller [Enabled]

Allows you to enable or disable the 1394 controller. Configuration options: [Disabled] [Enabled]

2.4.5 PCIPnP

The **PCI PnP** menu items allow you to change the advanced settings for PCI/PnP devices. The menu includes setting IRQ and DMA channel resources for either PCI/PnP or legacy ISA devices, and setting the memory size block for legacy ISA devices.



Take caution when changing the settings of the PCI PnP menu items. Incorrect field values can cause the system to malfunction.

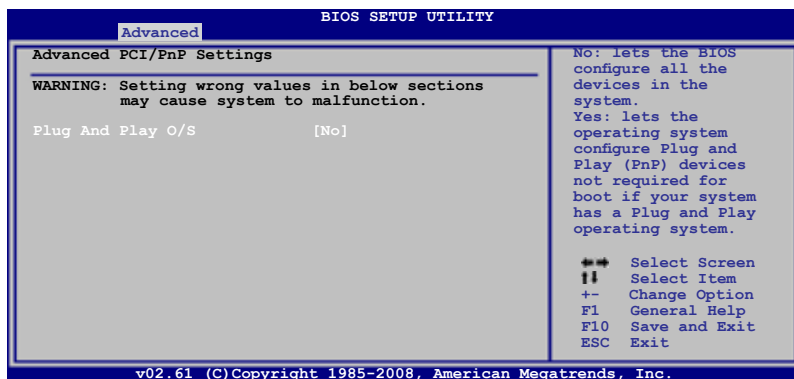

Plug and Play O/S [No]

When set to [No], BIOS configures all the devices in the system. When set to [Yes] and if you install a Plug and Play operating system, the operating system configures the Plug and Play devices not required for boot.

Configuration options: [No] [Yes]

2.4.6 USB Configuration

The items in this menu allows you to change the USB-related features. Select an item then press <Enter> to display the configuration options.

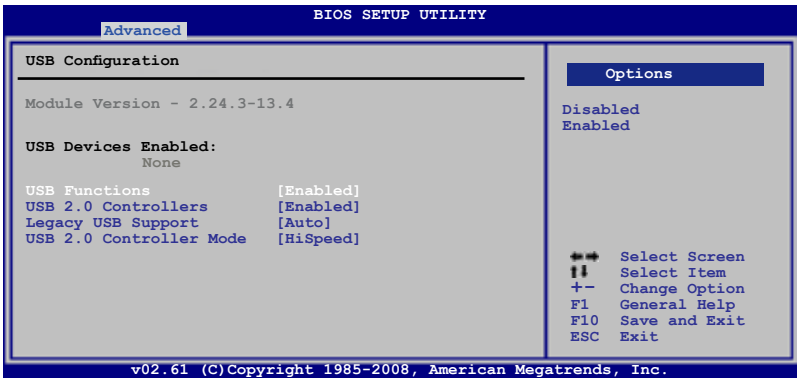

The Module Version and USB Devices Enabled items show the auto-detected values. If no USB device is detected, the item shows **None**.

USB Functions [Enabled]

Allows you to enable or disable the USB functions. Configuration options: [Disabled] [Enabled]

USB 2.0 Controllers [Enabled]

Enables or disables USB 2.0 Controllers. Configuration options: [Disabled] [Enabled]

Legacy USB Support [Auto]

Allows you to enable or disable support for Legacy USB storage devices, including USB flash drives and USB hard drives. Setting to Auto allows the system to detect the presence of USB devices at startup. If detected, the USB controller legacy mode is enabled. If no USB device is detected, the legacy USB support is disabled. Configuration options: [Disabled] [Enabled] [Auto]

USB 2.0 Controller Mode [HiSpeed]

Allows you to configure the USB 2.0 controller in HiSpeed (480 Mbps) or Full Speed (12 Mbps). Configuration options: [FullSpeed] [HiSpeed]

2.5 Power menu

The Power menu items allow you to change the settings for the Advanced Configuration and Power Interface (ACPI) and the Advanced Power Management (APM). Select an item then press <Enter> to display the configuration options.

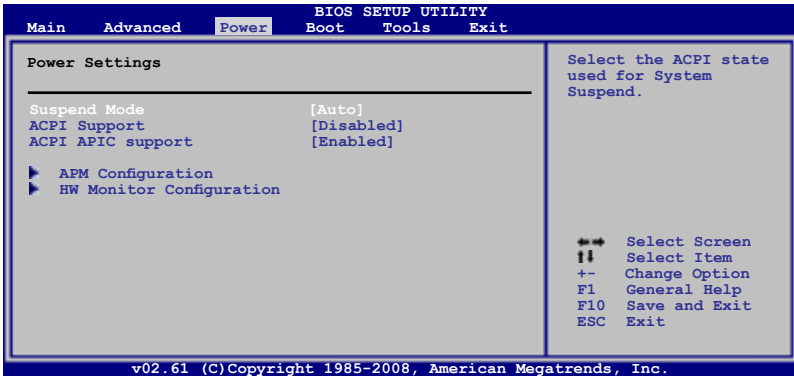

2.5.1 Suspend Mode [Auto]

Allows you to select the Advanced Configuration and Power Interface (ACPI) state to be used for system suspend.

Configuration options: [S1 (POS) Only] [S3 Only] [Auto]

2.5.2 ACPI Support [Disabled]

Allows you to enable or disable the Advanced Configuration and Power Interface (ACPI) 2.0 support. Configuration options: [Disabled] [Enabled]

2.5.3 ACPI APIC Support [Enabled]

Allows you to enable or disable the Advanced Configuration and Power Interface (ACPI) support in the Advanced Programmable Interrupt Controller (APIC). When set to Enabled, the ACPI APIC table pointer is included in the RSDT pointer list.

Configuration options: [Disabled] [Enabled]

2.5.4 APM Configuration

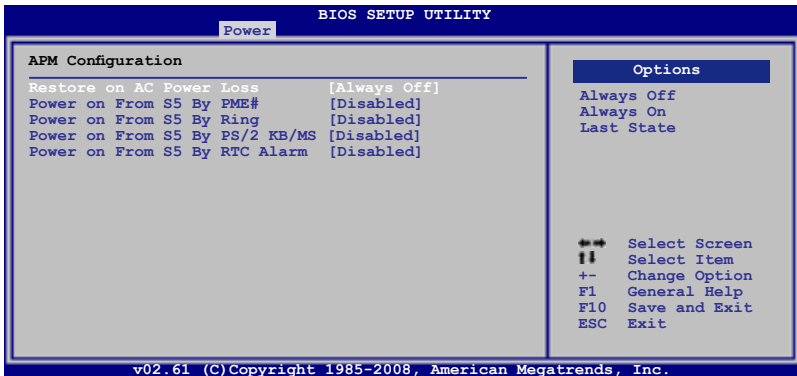

Restore on AC Power Loss [Always Off]

When set to Power Off, the system goes into off state after an AC power loss.

When set to Power On, the system goes on after an AC power loss.

Configuration options: [Always Off] [Always On] [Last State]

Power on From S5 By PME# [Disabled]

Enables or disables PME wake from sleep states.

Configuration options: [Disabled] [Enabled]

Power on From S5 By Ring [Disabled]

Enables or disables ring to generate a wake event.

Configuration options: [Disabled] [Enabled]

Power on From S5 By PS/2 KB/MS [Disabled]

Enables or disables PS/2 Keyboard/Mouse to generate a wake event.

Configuration options: [Disabled] [Enabled]

Power on From S5 By RTC Alarm [Disabled]

Enables or disables RTC to generate a wake event.

Configuration options: [Disabled] [Enabled]

2.5.5 HW Monitor Configuration

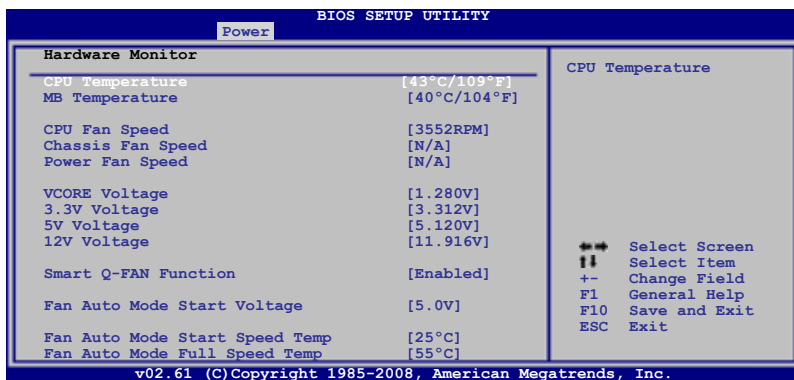

CPU Temperature [xxx°C/xxx°F] or [Ignored] MB Temperature [xxx°C/xxx°F] or [Ignored]

The onboard hardware monitor automatically detects and displays the motherboard and CPU temperatures. Select Ignored if you do not wish to display the detected temperatures.

CPU Fan Speed [xxxxRPM] or [Ignored]

The onboard hardware monitor automatically detects and displays the CPU fan speed in rotations per minute (RPM). If the fan is not connected to the motherboard, the field shows N/A. Select Ignored if you do not wish to display the detected speed.

Chassis Fan Speed [N/A] or [Ignored]

The onboard hardware monitor automatically detects and displays the chassis fan speed in rotations per minute (RPM). If the fan is not connected to the motherboard, the specific field shows N/A. Select Ignored if you do not wish to display the detected speed.

Power Fan Speed [N/A] or [Ignored]

The onboard hardware monitor automatically detects and displays the power fan speed in rotations per minute (RPM). If the fan is not connected to the motherboard, the specific field shows N/A. Select Ignored if you do not wish to display the detected speed.

VCORE Voltage, 3.3V Voltage, 5V Voltage, 12V Voltage [xx.xxxV] or [Ignored]

The onboard hardware monitor automatically detects the voltage output through the onboard voltage regulators.

Smart Q-Fan Function [Enabled]

Allows you to enable or disable the ASUS Q-Fan feature that smartly adjusts the fan speeds for more efficient system operation.

Configuration options: [Disabled] [Enabled]

Fan Auto Mode Start Voltage [5.0V]

Allows you to select the fan auto mode start voltage. Configuration options: [4.0V] [4.5V] [5.0V] [5.5V] [6.0V]

Fan Auto Mode Start Speed Temp [25°C]

Allows you to set the smart Q-Fan start working temperature. Configuration options: [25°C] ~ [40°C]

Fan Auto Mode Full Speed Temp [55°C]

Allows you to set the smart Q-Fan full speed temperature. Configuration options: [51°C] ~ [66°C]

2.6 Boot menu

The **Boot** menu items allow you to change the system boot options. Select an item then press **<Enter>** to display the sub-menu.

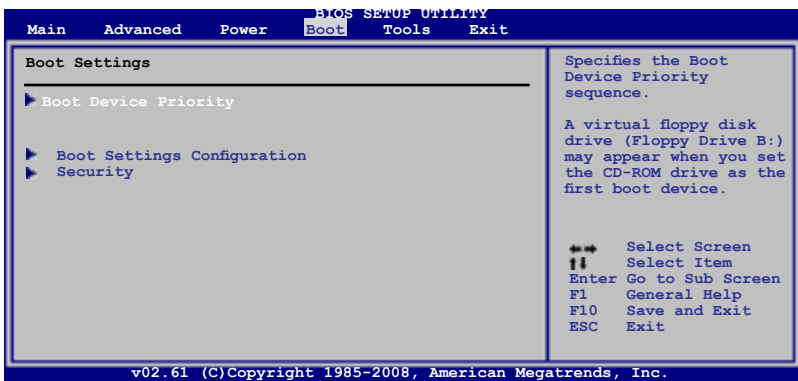

2.6.1 Boot Device Priority

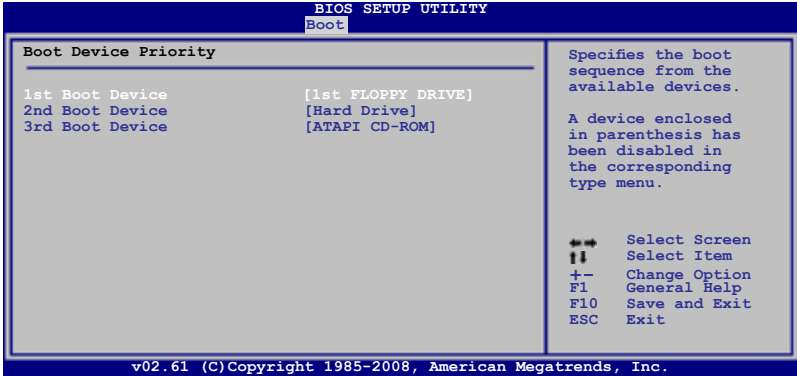

1st ~ xxx Boot Device [xxx Drive]

These items specify the boot device priority sequence from the available devices. The number of device items that appears on the screen depends on the number of devices installed in the system.

Configuration options: [1st FLOPPY DRIVE] [Hard Drive] [ATAPI CD-ROM] [Disabled]

2.6.2 Boot Settings Configuration

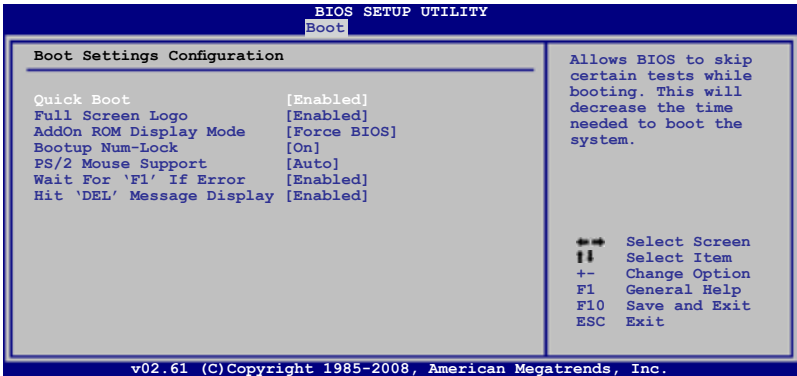

Quick Boot [Enabled]

Enabling this item allows the BIOS to skip some power on self tests (POST) while booting to decrease the time needed to boot the system. When set to [Disabled], BIOS performs all the POST items. Configuration options: [Disabled] [Enabled]

Full Screen Logo [Enabled]

This allows you to enable or disable the full screen logo display feature.
Configuration options: [Disabled] [Enabled]



Set this item to **[Enabled]** to use the ASUS MyLogo2™ feature.

AddOn ROM Display Mode [Force BIOS]

Sets the display mode for option ROM.
Configuration options: [Force BIOS] [Keep Current]

Bootup Num-Lock [On]

Allows you to select the power-on state for the NumLock.
Configuration options: [Off] [On]

Wait for 'F1' If Error [Enabled]

When set to Enabled, the system waits for the F1 key to be pressed when error occurs. Configuration options: [Disabled] [Enabled]

Hit 'DEL' Message Display [Enabled]

When set to **Enabled**, the system displays the message **Press DEL to run Setup** during POST. Configuration options: [Disabled] [Enabled]

2.6.3 Security

The Security menu items allow you to change the system security settings. Select an item then press **<Enter>** to display the configuration options.

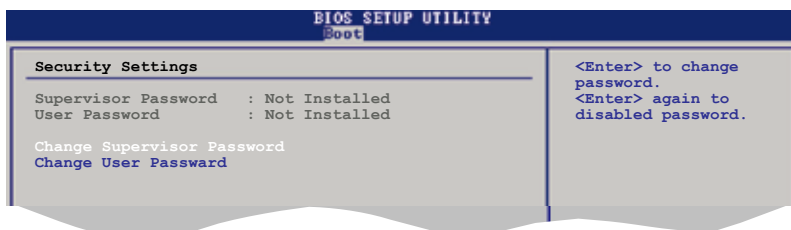

Change Supervisor Password

Select this item to set or change the supervisor password. The **Supervisor Password** item on top of the screen shows the default **Not Installed**. After you set a password, this item shows **Installed**.

To set a Supervisor Password:

1. Select the **Change Supervisor Password** item and press **<Enter>**.
2. From the password box, type a password composed of at least six letters and/or numbers, then press **<Enter>**.
3. Confirm the password when prompted.

The message "**Password Installed**" appears after you successfully set your password.

To change the supervisor password, follow the same steps as in setting a supervisor password.

To clear the supervisor password, select the **Change Supervisor Password** then press **<Enter>**. The message "**Password uninstalled**" appears.



If you forget your BIOS password, you can clear it by erasing the CMOS Real Time Clock (RTC) RAM. See section "1.9 Jumpers" for information on how to erase the RTC RAM.

After you have set a supervisor password, the other items appear to allow you to change other security settings.



User Access Level [Full Access]

This item allows you to select the access restriction to the Setup items. Configuration options: [No Access] [View Only] [Limited] [Full Access]

No Access prevents user access to the Setup utility.

View Only allows access but does not allow change to any field.

Limited allows changes only to selected fields, such as Date and Time.

Full Access allows viewing and changing all the fields in the Setup utility.

Change User Password

Select this item to set or change the user password. The **User Password** item on top of the screen shows the default **Not Installed**. After you set a password, this item shows **Installed**.

To set a User Password:

1. Select the **Change User Password** item and press **<Enter>**.
2. On the password box that appears, type a password composed of at least six letters and/or numbers, then press **<Enter>**.
3. Confirm the password when prompted.

The message "**Password Installed**" appears after you set your password successfully.

To change the user password, follow the same steps as in setting a user password.

Clear User Password

Select this item to clear the user password.

Password Check [Setup]

When set to **[Setup]**, BIOS checks for user password when accessing the Setup utility. When set to **[Always]**, BIOS checks for user password both when accessing Setup and booting the system. Configuration options: [Setup] [Always]

2.7 Tools menu

The **Tools** menu items allow you to configure options for special functions. Select an item then press **<Enter>** to display the sub-menu.

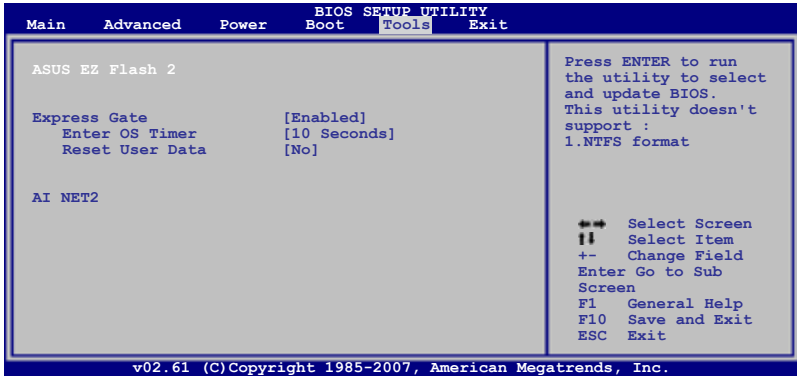

2.7.1 ASUS EZ Flash 2

Allows you to run ASUS EZ Flash 2. When you press **<Enter>**, a confirmation message appears. Use the left/right arrow key to select between **[Yes]** or **[No]**, then press **<Enter>** to confirm your choice. Please see section 2.1.4 for details.

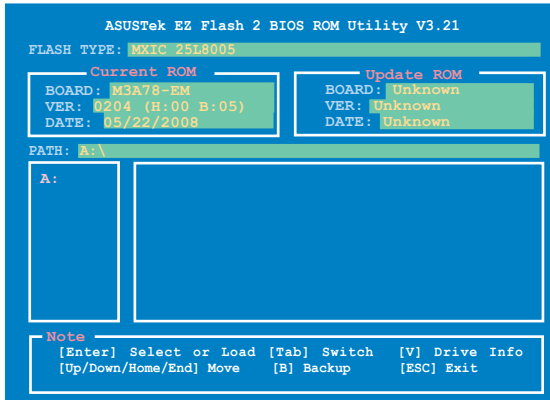

2.7.2 Express Gate [Enabled]

Allows you to enable or disable the ASUS Express Gate feature. The ASUS Express Gate feature is a unique instant-on environment that provides quick access to the Internet browser and Skype. Configuration options: [Enabled] [Disabled]

Enter OS Timer [10 Seconds]

Sets countdown duration that the system waits at the Express Gate's first screen before starting Windows or other installed OS. Choose **[Prompt User]** to stay at the first screen of Express Gate for user action.

Configuration options: [Prompt User] [1 second] [3 seconds] [5 seconds] [10 seconds] [15 seconds] [20 seconds] [30 seconds]

Reset User Data [No]

Allows you to clear Express Gate's user data.

Configuration options: [No] [Reset]

When setting this item to **[Reset]**, make sure to save the setting to the BIOS so that the user data will be cleared the next time you enter the Express Gate. User data includes the Express Gate's settings as well as any personal information stored by the web browser (bookmarks, cookies, browsing history, etc.). This is useful in the rare case where corrupt settings prevent the Express Gate environment from launching properly.



The first time wizard will run again when you enter the Express Gate environment after clearing its settings.

2.7.3 AI NET 2



Check Realtek LAN cable [Disabled]

Enables or disables checking of the Realtek LAN cable during the Power-On Self-Test (POST).

Configuration options: [Disabled] [Enabled]

2.8 Exit menu

The **Exit** menu items allow you to load the optimal or failsafe default values for the BIOS items, and save or discard your changes to the BIOS items.

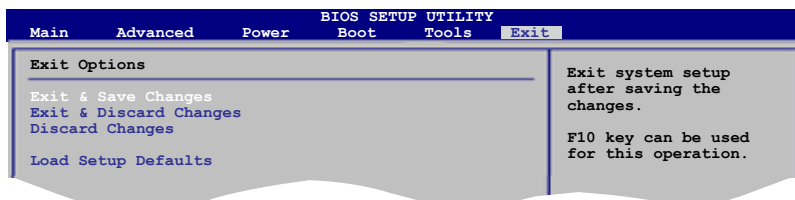

Pressing **<Esc>** does not immediately exit this menu. Select one of the options from this menu or **<F10>** from the legend bar to exit.

Exit & Save Changes

Once you are finished making your selections, choose this option from the Exit menu to ensure the values you selected are saved to the CMOS RAM. An onboard backup battery sustains the CMOS RAM so it stays on even when the PC is turned off. When you select this option, a confirmation window appears. Select **OK** to save changes and exit.



If you attempt to exit the Setup program without saving your changes, the program prompts you with a message asking if you want to save your changes before exiting. Press **<Enter>** to save the changes while exiting.

Exit & Discard Changes

Select this option only if you do not want to save the changes that you made to the Setup program. If you made changes to fields other than System Date, System Time, and Password, the BIOS asks for a confirmation before exiting.

Discard Changes

This option allows you to discard the selections you made and restore the previously saved values. After selecting this option, a confirmation appears. Select **OK** to discard any changes and load the previously saved values.

Load Setup Defaults

This option allows you to load the default values for each of the parameters on the Setup menus. When you select this option or if you press **<F5>**, a confirmation window appears. Select **OK** to load default values. Select **Exit & Save Changes** or make other changes before saving the values to the non-volatile RAM.

This chapter describes the contents of the Support DVD that comes with the motherboard package.

3 Software support

3.1 Installing an operating system

This motherboard supports Windows® XP/ Vista operating systems (OS). Always install the latest OS version and corresponding updates to maximize the features of your hardware.



- Motherboard settings and hardware options vary. Use the setup procedures presented in this chapter for reference only. Refer to your OS documentation for detailed information.
- Make sure that you install the Windows® XP Service Pack 1 or later versions before installing the drivers for better compatibility and system stability.

3.2 Support DVD information

The Support DVD that came with the motherboard package contains the drivers, software applications, and utilities that you can install to avail all motherboard features.



The contents of the Support DVD are subject to change at any time without notice. Visit the ASUS website at www.asus.com for updates.

3.2.1 Running the Support DVD

Place the Support DVD to the optical drive. The DVD automatically displays the **Drivers** menu if Autorun is enabled in your computer.



Click an icon to display Support DVD motherboard information

Click an item to install



If Autorun is NOT enabled in your computer, browse the contents of the Support DVD to locate the file ASSETUP.EXE from the BIN folder. Double-click the ASSETUP.EXE to run the DVD.

3.2.2 Drivers menu

The **Drivers** menu shows the available device drivers if the system detects installed devices. Install the necessary drivers to activate the devices.



ASUS InstAll - Installation Wizard for Drivers

Launches the ASUS InstallAll - drivers installation wizard.

AMD Chipset Driver

Installs the AMD chipset driver.

Realtek Audio Driver

Installs the Realtek audio driver.

ATI HDMI Driver

Installs the ATI HDMI driver.

AMD VGA Driver

Installs the AMD VGA driver.

Realtek RTL8111B/C 10/100/1000M LAN Driver

Installs the Realtek® RTL8111B/C 10/100/1000M LAN driver

AMD Cool'n'Quiet Driver

Installs the AMD Cool 'n' Quiet driver.



The screen display and drivers option may not be the same for different operating system versions.

3.2.3 Utilities menu

The **Utilities** menu shows the applications and other software that the motherboard supports.



ASUS InstAll - Installation Wizard for Utilities

Launches the ASUS InstAll - installation wizard for utilities.

ASUS Cool'n'Quiet Utility

This item guides you in installing the ASUS Cool'n'Quiet utility.

ASUS PC Probe II

This smart utility monitors the fan speed, CPU temperature, and system voltages, and alerts you of any detected problems. This utility helps you keep your computer in healthy operating condition.

ASUS Update

The ASUS Update utility allows you to update the motherboard BIOS in a Windows® environment. This utility requires an Internet connection either through a network or an Internet Service Provider (ISP).

AMD Raid/AHCI RaidXpert

Installs the AMD Raid/AHCI RaidXpert.

Realtek Diagnostics Utility

Installs the Realtek diagnostics utility.

Microsoft DirectX 9.0c

Installs the Microsoft® DirectX 9.0c driver. The Microsoft DirectX® 9.0c is a multimedia technology that enhances computer graphics and sound. DirectX® improves the multimedia features of your computer so you can enjoy watching TV and movies, capturing videos, or playing games in your computer. Visit the Microsoft website at www.microsoft.com for updates.

Corel MediaOne Starter

Installs the Corel MediaOne Starter application to easily manage, edit share and protect your multimedia data.

CyberLink PowerBackup

Installs CyberLink PowerBackup to back up and restore your data easily.

Adobe Acrobat Reader 8

Installs the Adobe® Acrobat® Reader that allows you to open, view, and print documents in Portable Document Format (PDF).



Click  to show the rest of the utilities under the **Utilities** menu.



WinZip 11

Installs the Winzip utility for easy file-compression and protection.

Ulead Burn.Now

Installs the Ulead Burn.Now application for Audio DVD, CD and data disc creation.

Ulead PhotoImpact 12 SE

Installs the PhotoImpact image editing software.

ASUS Express Gate Installer

Installs the ASUS Express Gate.

Anti-Virus Utility

Installs the anti-virus application that detects and protects your computer from viruses that destroy data.

Anti-Virus Utility Download

Downloads and installs the latest anti-virus application.

ASUS AI Nap

Installs the ASUS AI Nap.

3.2.4 Make Disk menu

The **Make disk** menu allows you to make a RAID driver disk.



Make ATI RAID/AHCI Vista32 Driver

Allows you to create an ATI® Serial ATA (SATA) RAID/AHCI Vista32 driver disk.

Make ATI RAID/AHCI Vista64 Driver

Allows you to create an ATI® Serial ATA (SATA) RAID/AHCI Vista64 driver disk.

Make ATI RAID/AHCI Driver XP 32/64bit Driver

Allows you to create an ATI® Serial ATA (SATA) RAID/AHCI driver for XP/XP 64bit.

3.2.5 Manual menu

The **Manual** menu contains a list of supplementary user manuals. Click an item to open the folder of the user manual.



Most user manual files are in Portable Document Format (PDF). Install the Adobe® Acrobat® Reader from the Utilities menu before opening a user manual file.

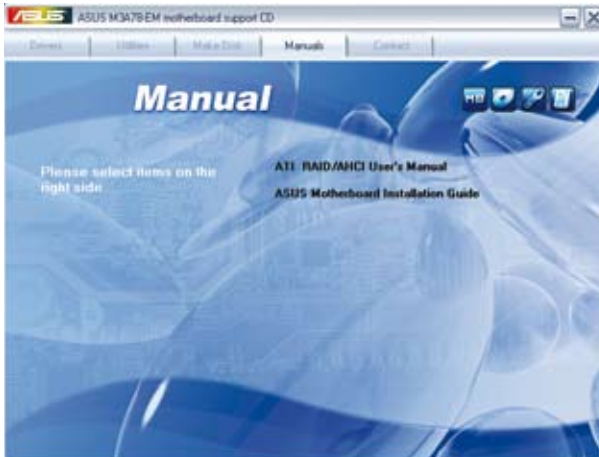

3.2.6 ASUS Contact information

Click the **Contact** tab to display the ASUS contact information. You can also find this information on the inside front cover of this user guide.

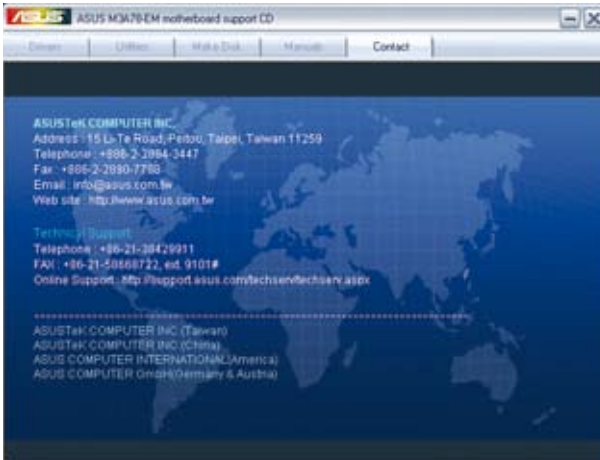

3.2.7 Other information

The icons on the top right corner of the screen give additional information on the motherboard and the contents of the Support DVD. Click an icon to display the specified information.

Motherboard Info

Displays the general specifications of the motherboard.



Browse this DVD

Displays the Support DVD contents in graphical format.

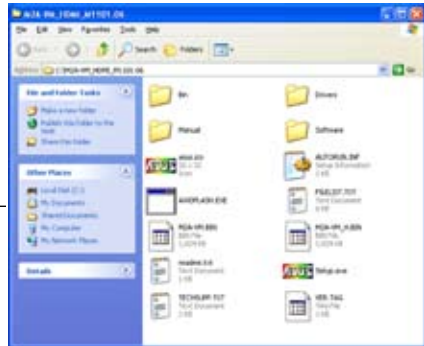

Technical support Form

Displays the ASUS Technical Support Request Form that you have to fill out when requesting technical support.

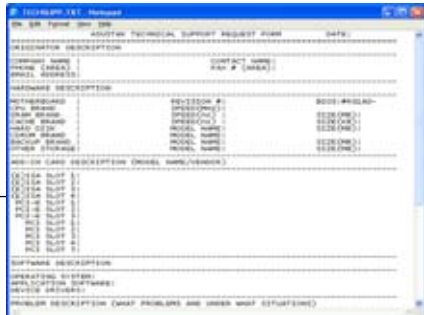

Filelist

Displays the contents of the Support DVD and a brief description of each in text format.



This chapter describes how to enable ATI Hybrid CrossFireX under Windows Vista OS.

Appendix

ATI® Hybrid CrossFire™

The motherboard supports the ATI® Hybrid CrossFire™ technology that allows you to install multi-graphics processing units (GPU) CrossFireX cards.

A.1 System requirements

Before using ATI Hybrid CrossFireX, ensure that your system meets the following basic requirements:

Operating System: Windows® Vista

Memory capacity: Minimum 1GB

CPU: AM2+

On-board graphics card RAM: 256MB

Add-on GPU: HD2400 PRO/HD2400 XT/HD3450/HD3470



We recommend that you use a graphics card with an HD2400 PRO GPU.

A.2 Before you proceed

Configure the BIOS settings for the graphics card to support ATI Hybrid CrossFireX.

To set Internal Graphics:

1. Press during the Power-On-Self-Test (POST) to enter the BIOS Setup utility.
2. Select **Advanced > Chipset > Internal Graphics**, set the **UMA Frame Buffer Size** to **[256M]**, and set the **Surround View** to **[Enabled]**.

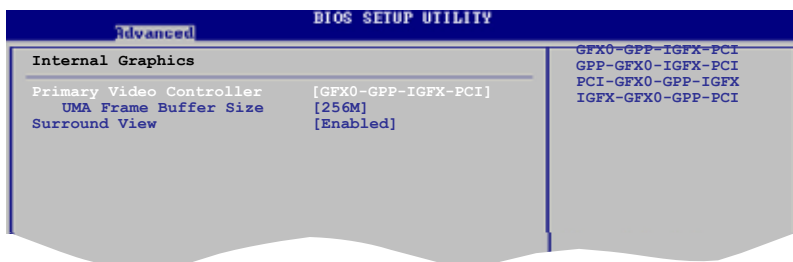

3. Press <F10> to save the changes and exit BIOS settings. Select **OK** to confirm.

A.3 Installing AMD Chipset Driver

To install the driver that supports Hybrid CrossFireX technology:

1. Insert the Support DVD that comes with your M3A78-EM into the optical drive. The DVD automatically displays the Drivers menu if Autorun is enabled in your computer.



If Autorun is NOT enabled in your computer, browse the contents of the support DVD to locate the file ASSETUP.EXE from the BIN folder. Double-click the ASSETUP.EXE to run the DVD.

2. From the Drivers menu, click **AMD Chipset Driver** to install it. Follow the onscreen instructions to finish the installation.
3. Restart your computer after the installation is completed.
4. When the system restarts, wait for a few seconds for the driver to load automatically.

A.4 Using the ATI CATALYST® Control Center

Using an add-on graphics card

1. Install a graphics card onto your motherboard. Refer to the User Guide that comes with your graphics card for details.
2. Right-click on the Windows® desktop, then click **ATI CATALYST(R) Control Center** from the shortcut menu. The ATI CATALYST Control Center screen appears.
3. Click **Graphics Settings > CrossFire™**, then select the **Enable CrossFire™** check box. When a confirmation message pops up, click **Yes**. The screen blacks out for about one minute.
4. Click **OK**. The add-on graphics card is set to be the main monitor.



Using the onboard graphics card

1. Right-click on the Windows® desktop, then click **ATI CATALYST(R) Control Center** from the shortcut menu. The ATI CATALYST Control Center screen appears.
2. Click **Graphics Settings > CrossFire™**, then clear the **Enable CrossFire™** check box. When a confirmation message pops up, click **Yes**. The screen blacks out for about one minute.



3. Click **OK**.
4. Right-click on the Windows® desktop, then click **Personalize** from the shortcut menu.
5. Click **Display Settings**. Select **[Default Monitor]** on **ATI Radeon HD 3200 Graphics**, then select the check boxes of **This is my main monitor** and **Extend the desktop onto this monitor**. Click **OK**, and then **Yes** from the confirmation window.



6. Restart the system. Right-click on the Windows® desktop, then click **ATI CATALYST(R) Control Center** from the shortcut menu. The ATI CATALYST Control Center screen appears.
7. Click **Graphics Settings > CrossFire™**, then select the **Enable CrossFire™** check box. When a confirmation pops up, click **Yes**. The screen blacks out for about one minute.
8. Click **OK**. The onboard graphics card is set to be the main monitor.



If you are using both an add-on and the on-board graphics cards at same time and want to set the onboard graphics card as your main monitor, follow the instructions on the next page.

1. Follow steps 1 to 3 on **Using the onboard graphics card**.
2. From the ATI CATALYST(R) Control Center screen, click **Display Manager > Graphics Adapter**. Select **ATI Radeon HD 3200 Graphics [Gabbs, G HW173]**. Click **OK**, and then **Yes** from the confirmation window.



3. Follow steps 6 to step 8 on **Using the onboard graphics card** to complete the process of setting up the onboard graphics card as your main monitor.

Free Manuals Download Website

<http://myh66.com>

<http://usermanuals.us>

<http://www.somanuals.com>

<http://www.4manuals.cc>

<http://www.manual-lib.com>

<http://www.404manual.com>

<http://www.luxmanual.com>

<http://aubethermostatmanual.com>

Golf course search by state

<http://golfingnear.com>

Email search by domain

<http://emailbydomain.com>

Auto manuals search

<http://auto.somanuals.com>

TV manuals search

<http://tv.somanuals.com>