



# *A8V Deluxe*

User Guide

# Motherboard

**E1878**

**Revised Edition V3**

**January 2005**

**Copyright © 2005 ASUSTeK COMPUTER INC. All Rights Reserved.**

No part of this manual, including the products and software described in it, may be reproduced, transmitted, transcribed, stored in a retrieval system, or translated into any language in any form or by any means, except documentation kept by the purchaser for backup purposes, without the express written permission of ASUSTeK COMPUTER INC. ("ASUS").

Product warranty or service will not be extended if: (1) the product is repaired, modified or altered, unless such repair, modification or alteration is authorized in writing by ASUS; or (2) the serial number of the product is defaced or missing.

ASUS PROVIDES THIS MANUAL "AS IS" WITHOUT WARRANTY OF ANY KIND, EITHER EXPRESS OR IMPLIED, INCLUDING BUT NOT LIMITED TO THE IMPLIED WARRANTIES OR CONDITIONS OF MERCHANTABILITY OR FITNESS FOR A PARTICULAR PURPOSE. IN NO EVENT SHALL ASUS, ITS DIRECTORS, OFFICERS, EMPLOYEES OR AGENTS BE LIABLE FOR ANY INDIRECT, SPECIAL, INCIDENTAL, OR CONSEQUENTIAL DAMAGES (INCLUDING DAMAGES FOR LOSS OF PROFITS, LOSS OF BUSINESS, LOSS OF USE OR DATA, INTERRUPTION OF BUSINESS AND THE LIKE), EVEN IF ASUS HAS BEEN ADVISED OF THE POSSIBILITY OF SUCH DAMAGES ARISING FROM ANY DEFECT OR ERROR IN THIS MANUAL OR PRODUCT.

SPECIFICATIONS AND INFORMATION CONTAINED IN THIS MANUAL ARE FURNISHED FOR INFORMATIONAL USE ONLY, AND ARE SUBJECT TO CHANGE AT ANY TIME WITHOUT NOTICE, AND SHOULD NOT BE CONSTRUED AS A COMMITMENT BY ASUS. ASUS ASSUMES NO RESPONSIBILITY OR LIABILITY FOR ANY ERRORS OR INACCURACIES THAT MAY APPEAR IN THIS MANUAL, INCLUDING THE PRODUCTS AND SOFTWARE DESCRIBED IN IT.

Products and corporate names appearing in this manual may or may not be registered trademarks or copyrights of their respective companies, and are used only for identification or explanation and to the owners' benefit, without intent to infringe.

# Contents

Notices .....	vii
Safety information .....	viii
About this guide .....	ix
How this guide is organized .....	ix
Where to find more information .....	ix
Conventions used in this guide .....	x
Typography .....	x
A8V Deluxe specifications summary .....	xi
<b>Chapter 1: Product introduction</b>	
1.1 Welcome! .....	1-1
1.2 Package contents .....	1-1
1.3 Special features .....	1-2
1.3.1 Product Highlights .....	1-2
1.3.2 Unique ASUS features .....	1-4
<b>Chapter 2: Hardware information</b>	
2.1 Before you proceed .....	2-1
2.2 Motherboard overview .....	2-2
2.2.1 Placement direction .....	2-2
2.2.2 Screw holes .....	2-2
2.2.3 Motherboard layout .....	2-3
2.2.4 Layout Contents .....	2-4
2.3 Central Processing Unit (CPU) .....	2-6
2.3.1 Overview .....	2-6
2.3.2 Installing the CPU .....	2-6
2.3.3 Installing the heatsink and fan .....	2-8
2.3.4 Connecting the CPU fan cable .....	2-10
2.4 System memory .....	2-11
2.4.1 Overview .....	2-11
2.4.2 Memory configurations .....	2-11
2.4.3 Installing a DIMM .....	2-14
2.4.4 Removing a DIMM .....	2-14
2.5 Expansion slots .....	2-15
2.5.1 Installing an expansion card .....	2-15
2.5.2 Configuring an expansion card .....	2-15
2.5.3 Interrupt assignments .....	2-16

# Contents

2.5.4	PCI slots .....	2-17
2.5.5	AGP slot .....	2-17
2.6	Jumpers .....	2-18
2.7	Connectors .....	2-20
2.7.1	Rear panel connectors .....	2-20
2.7.2	Internal connectors .....	2-22

## Chapter 3: Powering up

3.1	Starting up for the first time .....	3-1
3.2	Powering off the computer .....	3-2
3.2.1	Using the OS shut down function .....	3-2
3.2.2	Using the dual-function power switch .....	3-2
3.3	ASUS POST Reporter™ .....	3-3
3.3.1	Vocal POST messages .....	3-3
3.3.2	Winbond Voice Editor .....	3-5

## Chapter 4: BIOS setup

4.1	Managing and updating your BIOS .....	4-1
4.1.1	Creating a bootable floppy disk .....	4-1
4.1.2	Using AFUDOS to update the BIOS .....	4-2
4.1.3	Using AFUDOS to copy BIOS from PC .....	4-3
4.1.4	Using ASUS EZ Flash to update the BIOS .....	4-4
4.1.5	Recovering the BIOS with CrashFree BIOS 2 .....	4-5
4.1.6	ASUS Update .....	4-7
4.2	BIOS Setup program .....	4-9
4.2.1	BIOS menu screen .....	4-10
4.2.2	Menu bar .....	4-10
4.2.3	Navigation keys .....	4-10
4.2.4	Menu items .....	4-11
4.2.5	Sub-menu items .....	4-11
4.2.6	Configuration fields .....	4-11
4.2.7	Pop-up window .....	4-11
4.2.8	Scroll bar .....	4-11
4.2.9	General help .....	4-11
4.3	Main menu .....	4-12
4.3.1	System Time .....	4-12
4.3.2	System Date .....	4-12
4.3.3	Legacy Diskette A .....	4-12

# Contents

4.3.4	Language .....	4-12
4.3.5	Primary and Secondary IDE Master/Slave .....	4-13
4.3.6	System Information .....	4-14
4.4	Advanced menu .....	4-15
4.4.1	CPU Configuration .....	4-15
4.4.2	Chipset .....	4-21
4.4.3	Onboard Devices Configuration .....	4-24
4.4.4	PCI PnP .....	4-26
4.4.5	JumperFree Configuration .....	4-27
4.4.6	Speech Configuration .....	4-29
4.4.7	Instant Music Configuration .....	4-29
4.5	Power menu .....	4-30
4.5.1	Suspend Mode .....	4-30
4.5.2	Repost Video on S3 Resume .....	4-30
4.5.3	ACPI 2.0 Support .....	4-31
4.5.4	ACPI APIC Support .....	4-31
4.5.5	APM Configuration .....	4-31
4.5.6	Hardware Monitor .....	4-33
4.6	Boot menu .....	4-34
4.6.1	Boot Device Priority .....	4-35
4.6.2	Boot Settings Configuration .....	4-35
4.6.3	Security .....	4-36
4.7	Exit menu .....	4-39

## Chapter 5: Software support

5.1	Installing an operating system .....	5-1
5.2	Support CD information .....	5-1
5.2.1	Running the support CD .....	5-1
5.2.2	Drivers menu .....	5-2
5.2.3	Utilities menu .....	5-3
5.2.4	Manuals menu .....	5-4
5.2.5	ASUS Contact information .....	5-5
5.2.6	Other information .....	5-5
5.3	Software Information .....	5-7
5.3.1	ASUS MyLogo2™ .....	5-7
5.3.2	ASUS Instant Music .....	5-9
5.4	AI Net feature .....	5-11
5.5	Audio configurations .....	5-12

# Contents

5.5.1	Sound Effect options .....	5-12
5.5.2	S/PDIF options .....	5-13
5.5.3	Speaker Configuration .....	5-14
5.5.4	AI Audio feature .....	5-15
5.5.5	HRTF Demo .....	5-16
5.5.6	General settings .....	5-17
5.5.7	Rear panel audio ports function variation .....	5-17
5.6	RAID configurations .....	5-18
5.6.1	Installing hard disks .....	5-19
5.6.2	Promise® RAID configurations .....	5-20
5.6.3	VIA RAID configurations .....	5-26
5.7	Creating a RAID driver disk .....	5-33
5.8	Cool 'n' Quiet!™ Technology .....	5-34
5.8.1	Enabling Cool 'n' Quiet! Technology .....	5-34
5.8.2	Launching the Cool 'n' Quiet software .....	5-36

# Notices

## Federal Communications Commission Statement

This device complies with Part 15 of the FCC Rules. Operation is subject to the following two conditions:

- This device may not cause harmful interference, and
- This device must accept any interference received including interference that may cause undesired operation.

This equipment has been tested and found to comply with the limits for a Class B digital device, pursuant to Part 15 of the FCC Rules. These limits are designed to provide reasonable protection against harmful interference in a residential installation. This equipment generates, uses and can radiate radio frequency energy and, if not installed and used in accordance with manufacturer's instructions, may cause harmful interference to radio communications. However, there is no guarantee that interference will not occur in a particular installation. If this equipment does cause harmful interference to radio or television reception, which can be determined by turning the equipment off and on, the user is encouraged to try to correct the interference by one or more of the following measures:

- Reorient or relocate the receiving antenna.
- Increase the separation between the equipment and receiver.
- Connect the equipment to an outlet on a circuit different from that to which the receiver is connected.
- Consult the dealer or an experienced radio/TV technician for help.



---

The use of shielded cables for connection of the monitor to the graphics card is required to assure compliance with FCC regulations. Changes or modifications to this unit not expressly approved by the party responsible for compliance could void the user's authority to operate this equipment.

---

## Canadian Department of Communications Statement

This digital apparatus does not exceed the Class B limits for radio noise emissions from digital apparatus set out in the Radio Interference Regulations of the Canadian Department of Communications.

**This class B digital apparatus complies with Canadian ICES-003.**

# Safety information

## Electrical safety

- To prevent electrical shock hazard, disconnect the power cable from the electrical outlet before relocating the system.
- When adding or removing devices to or from the system, ensure that the power cables for the devices are unplugged before the signal cables are connected. If possible, disconnect all power cables from the existing system before you add a device.
- Before connecting or removing signal cables from the motherboard, ensure that all power cables are unplugged.
- Seek professional assistance before using an adapter or extension cord. These devices could interrupt the grounding circuit.
- Make sure that your power supply is set to the correct voltage in your area. If you are not sure about the voltage of the electrical outlet you are using, contact your local power company.
- If the power supply is broken, do not try to fix it by yourself. Contact a qualified service technician or your retailer.

## Operation safety

- Before installing the motherboard and adding devices on it, carefully read all the manuals that came with the package.
- Before using the product, make sure all cables are correctly connected and the power cables are not damaged. If you detect any damage, contact your dealer immediately.
- To avoid short circuits, keep paper clips, screws, and staples away from connectors, slots, sockets and circuitry.
- Avoid dust, humidity, and temperature extremes. Do not place the product in any area where it may become wet.
- Place the product on a stable surface.
- If you encounter technical problems with the product, contact a qualified service technician or your retailer.



# About this guide

This user guide contains the information you need when installing the motherboard.

## How this guide is organized

This manual contains the following parts:

- **Chapter 1: Product introduction**  
This chapter describes the motherboard features and the new technologies it supports.
- **Chapter 2: Hardware information**  
This chapter lists the hardware setup procedures that you have to perform when installing system components. It includes description of the jumpers and connectors on the motherboard.
- **Chapter 3: Powering up**  
This chapter describes the power up sequence, the vocal POST messages, and ways of shutting down the system.
- **Chapter 4: BIOS setup**  
This chapter tells how to change system settings through the BIOS Setup menus. Detailed descriptions of the BIOS parameters are also provided.
- **Chapter 5: Software support**  
This chapter describes the contents of the support CD that comes with the motherboard package.

## Where to find more information

Refer to the following sources for additional information and for product and software updates.

### 1. ASUS websites

The ASUS website provides updated information on ASUS hardware and software products. Refer to the ASUS contact information.

### 2. Optional documentation

Your product package may include optional documentation, such as warranty flyers, that may have been added by your dealer. These documents are not part of the standard package.

## Conventions used in this guide

To make sure that you perform certain tasks properly, take note of the following symbols used throughout this manual.



**DANGER/WARNING:** Information to prevent injury to yourself when trying to complete a task.



**CAUTION:** Information to prevent damage to the components when trying to complete a task.



**IMPORTANT:** Information that you **MUST** follow to complete a task.



**NOTE:** Tips and additional information to aid in completing a task.

## Typography

<b>Bold text</b>	Indicates a menu or an item to select.
<i>Italics</i>	Used to emphasize a word or a phrase.
<Key>	Keys enclosed in the less-than and greater-than sign indicates that you must press the enclosed key. Example: <Enter> indicates that you must press the Enter or Return key.
<Multiple key names>	If you must press two or more keys simultaneously, the key names are linked with a plus sign (+). Example: <Ctrl+Alt+D>
<b>Command</b>	Means that you must enter the command exactly as shown then supply the appropriate values that appear in brackets. Example:  At the DOS prompt, type the command line:  <b>afudos /i[filename]</b>  In this example, you must supply a filename for [filename].  <b>afudos /iA8V.ROM</b>

# A8V Deluxe specifications summary

<b>CPU</b>	Socket 939 for AMD Athlon™ 64FX / Athlon™ 64 processor Supports AMD 64 architecture that enables simultaneous 32-bit and 64-bit computing Supports AMD Cool 'n' Quiet! Technology
<b>Chipset</b>	VIA K8T800Pro VIA VT8237
<b>System Bus</b>	2000 MT/s
<b>Memory</b>	Dual-channel memory architecture 4 x 184-pin DDR DIMM sockets for up to 4GB unbuffered ECC and non-ECC PC3200/PC2700/PC2100/PC1600 DDR DIMMs
<b>Expansion slots</b>	1 x AGP 8X/4X 5 x PCI
<b>Storage</b>	SouthBridge supports <ul style="list-style-type: none"> <li>- 2 x UltraDMA 133 connectors</li> <li>- 2 x Serial ATA with RAID 0, RAID 1, and JBOD</li> </ul> Promise® PDC20378 RAID controller <ul style="list-style-type: none"> <li>- 1 x UltraDMA 133 connector</li> <li>- 2 x Serial ATA connectors</li> <li>- support for RAID 0, RAID 1, RAID 0+1, and Multiple RAID configurations</li> </ul>
<b>AI Audio</b>	Realtek® ALC850 8-channel CODEC Audio Sensing and Enumeration Technology S/PDIF out interface support
<b>AI Net</b>	Marvell® 88E8001 Gigabit Ethernet controller Virtual Cable Tester (VCT) Technology support
<b>IEEE 1394</b>	VIA VT6307 IEEE1394 controller supports <ul style="list-style-type: none"> <li>- 2 x 1394 ports</li> </ul>
<b>USB</b>	Maximum of eight USB 2.0 ports
<b>AI BIOS</b>	ASUS CrashFree BIOS 2 ASUS Q-Fan 2 Technology ASUS POST Reporter™
<b>AI Overclocking Features</b>	CPU, Memory, and AGP voltage adjustable SFS (Stepless Frequency Selection) from 200 MHz up to 300 MHz at 1 MHz increment ASUS JumperFree ASUS C.P.R. (CPU Parameter Recall)

*(continued on the next page)*

# A8V Deluxe specifications summary

<b>Special features</b>	ASUS AI NET ASUS AI BIOS ASUS POST Reporter™ ASUS C.P.R. (CPU Parameter Recall) ASUS EZ Flash ASUS CrashFree BIOS 2 ASUS MyLogo2™ ASUS Instant Music ASUS Q-Fan 2 Technology AMD Cool 'n' Quiet!™ Technology Multi-language BIOS Support S/PDIF out interface
<b>Back panel I/O</b>	1 x Parallel port 1 x Serial port 1 x PS/2 keyboard port 1 x PS/2 mouse port 4 x USB 2.0 ports 1 x IEEE 1394 port 1 x Optical S/PDIF output port 1 x Coaxial S/PDIF output port 1 x RJ-45 port 1 x 8-channel audio ports
<b>Internal I/O</b>	2 x USB 2.0 connector for 4 additional USB ports CPU/Chassis/Power fan connectors 20-pin/4-pin ATX 12V power connectors CD/AUX connectors GAME/MIDI connector IEEE 1394 connector COM2 connector
<b>BIOS features</b>	4Mb Flash EEPROM AMI BIOS with enhanced ACPI, PnP, DMI2.0, Green
<b>Industry standard</b>	PCI 2.2, USB 2.0/1.1
<b>Manageability</b>	DMI 2.0, WOL by PME, WOR by PME
<b>Power Requirement</b>	ATX power supply (with 4-pin 12V plug)
<b>Form Factor</b>	ATX form factor: 12 in x 9.6 in (30.5 cm x 24.4 cm)
<b>Support CD contents</b>	Device drivers ASUS PC Probe Anti-virus utility

\* Specifications are subject to change without notice.

# ***Chapter 1***

This chapter describes the motherboard features and the new technologies it supports.

## **Product introduction**

## **Chapter summary**

<b>1.1</b>	<b>Welcome! .....</b>	<b>1-1</b>
<b>1.2</b>	<b>Package contents .....</b>	<b>1-1</b>
<b>1.3</b>	<b>Special features .....</b>	<b>1-2</b>

# 1.1 Welcome!

## Thank you for buying the ASUS® A8V Deluxe motherboard!

The motherboard delivers a host of new features and latest technologies making it another standout in the long line of ASUS quality motherboards!

The motherboard combines the powers of the AMD Athlon™ 64FX or Athlon™ 64 processor and the VIA K8T800Pro chipset to set a new benchmark for an effective desktop platform solution.

Supporting a system bus of 2000 MT/s, up to 4GB of dual-channel system memory with PC3200/PC2700/PC2100/PC1600 DDR SDRAM, high-resolution graphics via an AGP 8X slot, Dual Serial ATA RAID, IEEE 1394, USB 2.0, and 8-channel audio features, the motherboard takes you ahead in the world of power computing!

Before you start installing the motherboard and hardware devices on it, check the items in your package with the list below.

## 1.2 Package contents

Check your motherboard package for the following items.

- ✓ ASUS A8V Deluxe motherboard
- ✓ ASUS motherboard support CD
- ✓ 4 x Serial ATA cable
- ✓ 2 x 2-port Serial ATA power cable
- ✓ 1 x 2-port USB2.0/Game module
- ✓ 1 x IEEE1394 cable
- ✓ 2 x 80-conductor ribbon cable for Ultra DMA 133/100/66 IDE drives
- ✓ 1 x 40-conductor IDE cable
- ✓ 1 x Ribbon cable for a 3.5-inch floppy drive
- ✓ WinDVD Platinum (Retail boxes only)
- ✓ Instant Music label (Retail boxes only)
- ✓ I/O shield
- ✓ Bag of extra jumper caps
- ✓ User guide



---

If any of the above items is damaged or missing, contact your retailer.

---

## 1.3 Special features

### 1.3.1 Product highlights

#### Latest processor technology



The AMD Athlon™ 64FX and Athlon™ 64 desktop processors are based on AMD's 64-bit and 32-bit architecture, which represents the landmark introduction of the industry's first x86-64 technology. These processors provide a dramatic leap forward in compatibility, performance, investment protection, and reduced total cost of ownership and development.

See page 2-6.

#### HyperTransport™ Technology



HyperTransport™ Technology is a high-speed, low latency, point-to-point link designed to increase the communication speed between integrated circuits in computers, networking and telecommunications equipment up to 48 times faster than other existing technologies.

#### AMD Cool 'n' Quiet!™ Technology



The motherboard supports the AMD Cool 'n' Quiet!™ Technology that dynamically and automatically changes the CPU speed, voltage and amount of power depending on the task the CPU performs. See pages 4-20, 5-34.

#### Dual Channel DDR memory support



Employing the Double Data Rate (DDR) memory technology, the motherboard supports up to 4GB of system memory using DDR400/333/266 DIMMs. The ultra-fast 400MHz memory bus delivers the required bandwidth for the latest 3D graphics, multimedia, and Internet applications.

See page 2-11.

#### Serial ATA solution



The motherboard supports four interfaces compliant to the Serial ATA (SATA) specification, an evolutionary replacement of the Parallel ATA storage interface. The Serial ATA specification allows for thinner, more flexible cables with lower pin count, reduced voltage requirement, up to 150 MB/s data transfer rate. See pages 2-24, 2-24.



## Dual Serial ATA RAID

The motherboard provides two high-performance Serial ATA RAID controllers that enhance hard disk performance and data backup protection without the cost of additional RAID cards. The Promise® PDC20378 RAID controller incorporates two Serial ATA and one parallel connector with RAID 0, RAID 1, RAID 0+1, and multiple RAID functions while the onboard VIA VT8237 RAID controller provides an additional two Serial ATA connectors for RAID 0, RAID 1, and JBOD functions. See pages 2-24, 2-25, 5-18.

## AGP 8X support

AGP 8X (AGP 3.0) is the VGA interface specification that enables enhanced graphics performance with maximum bandwidth speed of up to 2.12 GB/s. See page 2-17, 4-22.

## S/PDIF out

The motherboard's S/PDIF out function turns your computer into a high-end entertainment system with digital connectivity to powerful speaker systems. See page 2-21.

## IEEE 1394 support

The IEEE 1394 interface provides high-speed and flexible PC connectivity to a wide range of peripherals and devices compliant to IEEE 1394a standards. The IEEE 1394 interface allows up to 400Mbps transfer rates through simple, low-cost, high-bandwidth asynchronous (real-time) data interfacing between computers, peripherals, and consumer electronic devices such as camcorders, VCRs, printers, TVs, and digital cameras. See pages 2-20, 2-29.

## USB 2.0 technology

The motherboard implements the new Universal Serial Bus (USB) 2.0 specification, extending the connection speed from 12 Mbps on USB 1.1 to a fast 480 Mbps on USB 2.0 - supporting up to eight USB 2.0 ports. The higher bandwidth of USB 2.0 allows connection of devices such as high resolution video conferencing cameras, next generation scanners and printers, and fast storage units. USB 2.0 is backward compatible with USB 1.1. See pages 2-20 1, 2-28.

## 1.3.2 Unique ASUS features

### AI NET solution

The Marvell® Gigabit LAN controller chipset is onboard to provide a single-chip solution for LAN on Motherboard (LOM) applications. The controller integrates a 32-bit IEEE 802.3 compliant Gigabit Ethernet Media Access Controller (GMAC) and Physical Layer Transceiver solution to support high performance network applications. The controller is equipped with the Virtual Cable Tester™ (VCT) net-diagnosing utility that intelligently diagnoses and reports cable faults from a remote location up to 100 meters. This feature helps maintain a more stable network connection. See page 2-20, 5-11.

### AI Audio technology

The motherboard supports 8-channel audio through the onboard ALC850 CODEC with 16-bit DAC, a stereo 16-bit ADC, and an AC97 2.3 compatible multi-channel audio designed for PC multimedia systems. It also provides Jack-Sensing function, S/PDIF out support, interrupt capability and includes the Realtek® proprietary UAJ® (Universal Audio Jack) technology. See page 2-20, 5-12.

### AI BIOS solution

The AI BIOS is a combination of three ASUS intelligent solutions: Q-Fan 2, POST Reporter™, and CrashFree BIOS 2.

### ASUS Q-Fan 2 technology

The ASUS Q-Fan 2 technology smartly adjusts the CPU and chassis fan speeds according to the system load and temperature to ensure quiet, cool, and efficient operation. See page 4-33.

### CrashFree BIOS 2

This feature allows you to restore the original BIOS data from the ASUS support CD in case when the BIOS codes and data are corrupted. This protection eliminates the need to buy a replacement ROM chip. See page 4-5.

## ASUS POST Reporter™



The motherboard offers an exciting feature called the ASUS POST Reporter™ to provide friendly voice messages and alerts during the Power-On Self-Tests (POST). Through an added external speaker, you will hear the messages informing you of the system boot status and causes of boot errors, if any. The bundled Winbond Voice Editor software allows you to customize the voice messages, and provides multi-language support. See pages 3-3, 4-29

## AI Overclocking



This feature allows convenient overclocking up to 30% (depending on the installed CPU and DRAM) to enhance system performance while maintaining system stability. See page 4-27.

## ASUS MyLogo2™



This new feature present in the motherboard allows you to personalize and add style to your system with customizable boot logos. See pages 4-35, 5-7.

## C.P.R. (CPU Parameter Recall)



The C.P.R. feature of the motherboard BIOS allows automatic re-setting to the BIOS default settings in case the system hangs due to overclocking. When the system hangs due to overclocking, C.P.R. eliminates the need to open the system chassis and clear the RTC data. Simply reboot the system to restore the previously saved settings. See page 2-18.

## ASUS EZ Flash BIOS



With the ASUS EZ Flash, you can easily update the system BIOS even before loading the operating system. No need to use a DOS-based utility or boot from a floppy disk. See page 4-4.

## ASUS Multi-language BIOS



The multi-language BIOS allows you to select the language of your choice from the available options. The localized BIOS menus allow you to configure easier and faster. See page 4-12.

## ASUS Instant Music

This unique feature allows you to playback audio files even without booting the system to Windows™. Just press the ASUS Instant Music special function keys and enjoy the music! See pages 4-29, 5-9.

# ***Chapter 2***

This chapter lists the hardware setup procedures that you have to perform when installing system components. It includes description of the jumpers and connectors on the motherboard.

## **Hardware information**

## **Chapter summary**

<b>2.1</b>	<b>Before you proceed .....</b>	<b>2-1</b>
<b>2.2</b>	<b>Motherboard overview .....</b>	<b>2-2</b>
<b>2.3</b>	<b>Central Processing Unit (CPU) .....</b>	<b>2-6</b>
<b>2.4</b>	<b>System memory .....</b>	<b>2-11</b>
<b>2.5</b>	<b>Expansion slots .....</b>	<b>2-15</b>
<b>2.6</b>	<b>Jumpers .....</b>	<b>2-18</b>
<b>2.7</b>	<b>Connectors .....</b>	<b>2-20</b>

## 2.1 Before you proceed

Note of the following precautions before you install motherboard components or change any motherboard settings.



- Unplug the power cord from the wall socket before touching any component.
- Use a grounded wrist strap or touch a safely grounded object or to a metal object, such as the power supply case, before handling components to avoid damaging them due to static electricity.
- Hold components by the edges to avoid touching the ICs on them.
- Whenever you uninstall any component, place it on a grounded antistatic pad or in the bag that came with the component.
- Before you install or remove any component, ensure that the ATX power supply is switched off or the power cord is detached from the power supply. Failure to do so may cause severe damage to the motherboard, peripherals, and/or components.

### Onboard LED

The motherboard comes with a standby power LED. When lit, this green LED indicates that the system is ON, in sleep mode, or in soft-off mode, a reminder that you should shut down the system and unplug the power cable before removing or plugging in any motherboard component. The illustration below shows the location of the onboard LED.

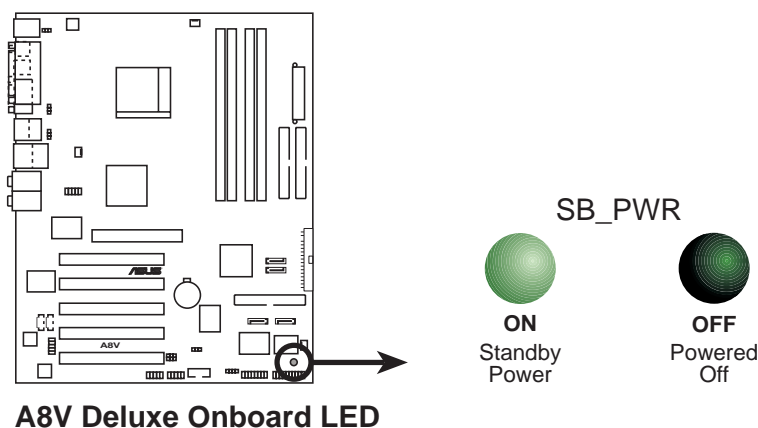

## 2.2 Motherboard overview

Before you install the motherboard, study the configuration of your chassis to ensure that the motherboard fits into it.



Unplug the power cord before installing or removing the motherboard. Failure to do so can cause you physical injury and damage motherboard components.

### 2.2.1 Placement direction

When installing the motherboard, make sure that you place it into the chassis in the correct orientation. The edge with external ports goes to the rear part of the chassis as indicated in the image below.

### 2.2.2 Screw holes

Place nine (9) screws into the holes indicated by circles to secure the motherboard to the chassis.



Do not overtighten the screws! Doing so can damage the motherboard.

Place this side towards the rear of the chassis

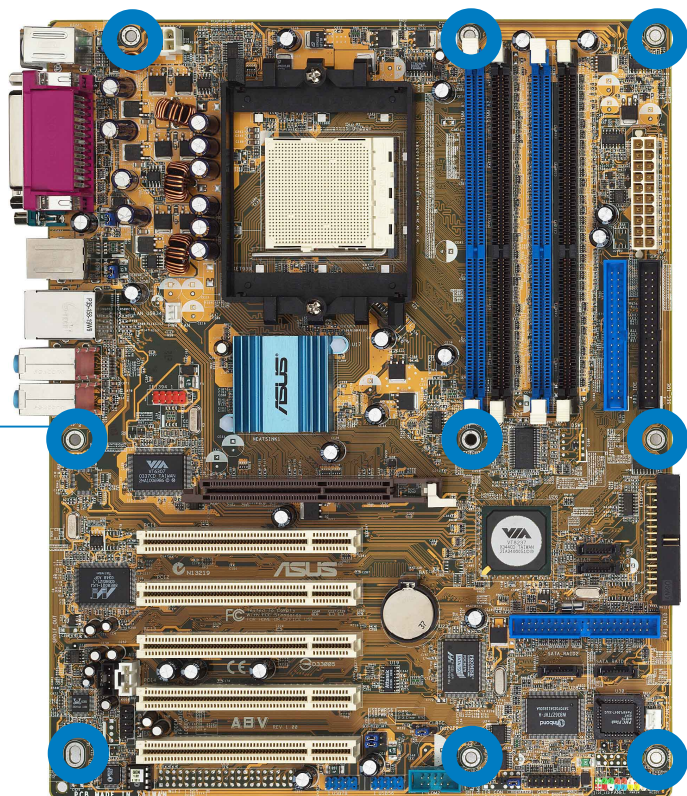



## 2.2.3 Motherboard layout

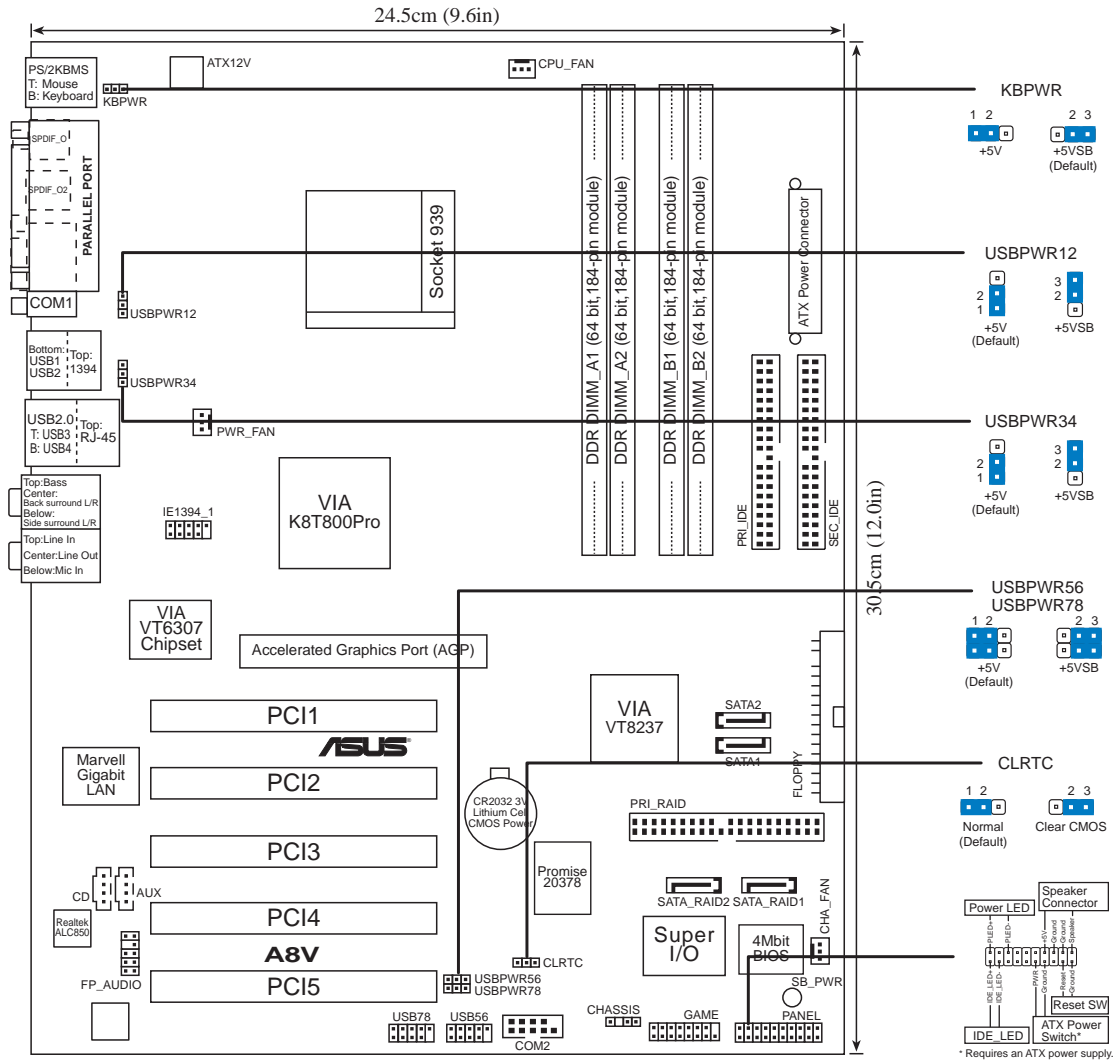

## 2.2.4 Layout Contents

Slots	Page
1. DDR DIMM slots	2-11
2. PCI slots	2-17
3. AGP slot	2-17

Jumpers	Page
1. Clear RTC RAM (3-pin CLRTC)	2-18
2. Keyboard power (3-pin KBPWR)	2-19
3. USB device wake-up (3-pin USBPWR12, USBPWR34, USBPWR56, USBPWR78)	2-19

Rear Panel Connectors	Page
1. PS/2 mouse port	2-20
2. Parallel port	2-20
3. IEEE 1394 port	2-20
4. Gigabit LAN port (RJ-45)	2-20
5. Center/Subwoofer jack	2-20
6. Rear Speaker out jack	2-20
7. Line In jack	2-20
8. Line Out jack	2-20
9. Microphone jack	2-20
10. Side Speaker out jack	2-20
11. USB 2.0 ports 3 and 4	2-21
12. USB 2.0 ports 1 and 2	2-21
13. Serial connector	2-21
14. S/PDIF optical cable jack	2-21
15. S/PDIF coaxial cable jack	2-21
16. PS/2 keyboard port	2-21

<b>Internal Connectors</b>	<b>Page</b>
1. Primary IDE connector (40-1 pin PRI_IDE)	2-22
2. Secondary IDE connector (40-1 pin SEC_IDE)	2-22
3. Floppy disk connector (34-1 pin FLOPPY)	2-23
4. RAID ATA connector (40-1 pin PRI_RAID)	2-23
5. Serial ATA connectors (7-pin SATA1, SATA2)	2-24
6. RAID Serial ATA connectors (7-pin SATA_RAID1, SATA_RAID2)	2-25
7. CPU fan connector (3-pin CPU_FAN)	2-26
8. Power fan connector (3-pin PWR_FAN)	2-26
9. Chassis fan connector (3-pin CHA_FAN)	2-26
10. Serial Port 2 connector (10-1 pin COM2)	2-26
11. ATX power connector (20-pin ATXPWR)	2-27
12. ATA 12V power connector (4-pin ATX12V)	2-27
13. USB headers (10-1 pin USB56, USB78)	2-28
14. CD connector (4-pin CD)	2-29
15. AUX connector (4-pin AUX)	2-29
16. IEEE 1394 connector (10-1 pin IE1394_1)	2-29
17. Front panel audio connector (10-1 pin FP_AUDIO)	2-30
18. GAME/MIDI connector (16-1 pin GAME)	2-30
19. Chassis intrusion connector (4-1 pin CHASSIS)	2-31
20. System panel connector (20-pin PANEL)	2-31
- System power LED (Green 3-pin PLED)	
- System warning speaker (Orange 4-pin SPEAKER)	
- Reset switch (Blue 2-pin RESET)	
- ATX Power switch (Yellow 2-pin PWRSW)	
- Hard Disk activity LED (Red 2-pin IDE_LED)	

## 2.3 Central Processing Unit (CPU)

### 2.3.1 Overview

The motherboard comes with a surface mount 939-pin Zero Insertion Force (ZIF) socket designed for the AMD Athlon™ 64FX or AMD Athlon 64™ processor.

The 128-bit-wide data paths of these processors can run applications faster than processors with only 32-bit or 64-bit wide data paths.

Take note of the marked corner (with gold triangle) on the CPU. This mark should match a specific corner on the socket to ensure correct installation.

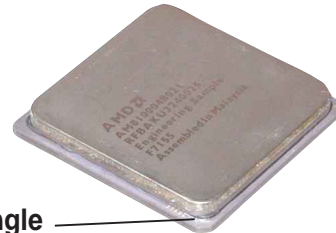

Gold triangle

### 2.3.2 Installing the CPU

Follow these steps to install a CPU.

1. Locate the 939-pin ZIF socket on the motherboard.

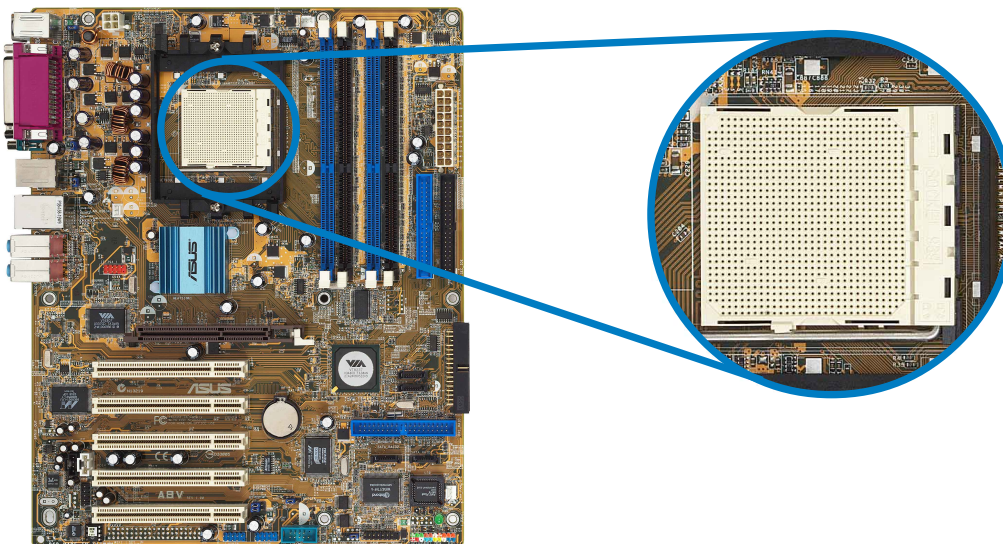

2. Unlock the socket by pressing the lever sideways, then lift it up to a 90°-100° angle.

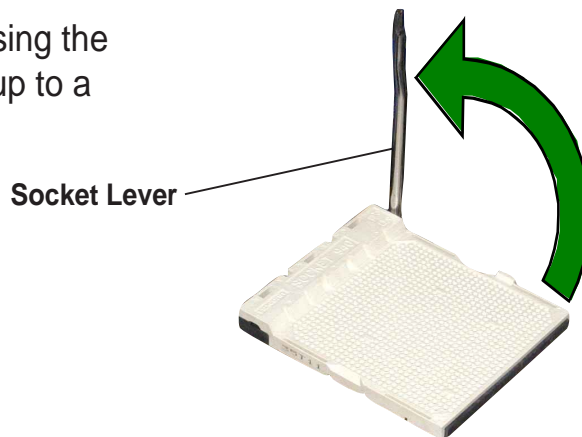

---

Make sure that the socket lever is lifted up to 90°-100° angle, otherwise the CPU does not fit in completely.

---

3. Position the CPU above the socket such that the CPU corner with the gold triangle matches the socket corner with a small triangle.

4. Carefully insert the CPU into the socket until it fits in place.

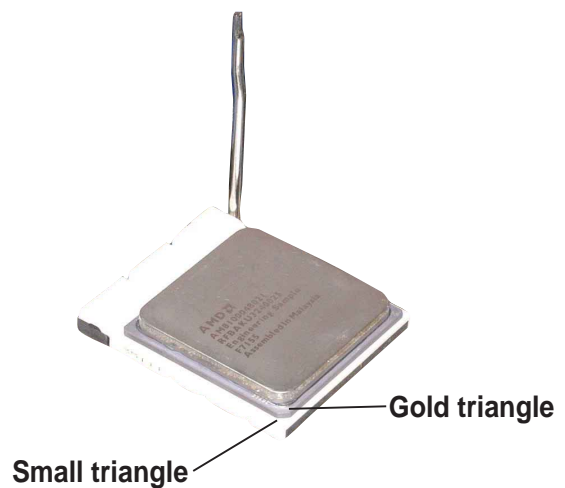

---

The CPU fits only in one correct orientation. DO NOT force the CPU into the socket to prevent bending the pins and damaging the CPU!

---

5. When the CPU is in place, push down the socket lever to secure the CPU. The lever clicks on the side tab to indicate that it is locked.

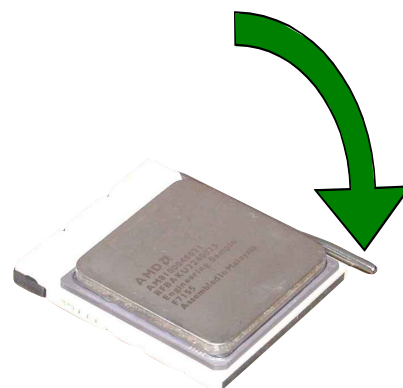

## 2.3.3 Installing the heatsink and fan

The AMD Athlon™ 64FX or AMD Athlon 64™ processor require a specially designed heatsink and fan assembly to ensure optimum thermal condition and performance.



---

Make sure that you use only qualified heatsink and fan assembly.

---

Follow these steps to install the CPU heatsink and fan.

1. Place the heatsink on top of the installed CPU, making sure that the heatsink fits properly on the retention module base.



- 
- The retention module base is already installed on the motherboard upon purchase.
  - You do not have to remove the retention module base when installing the CPU or installing other motherboard components.
- 

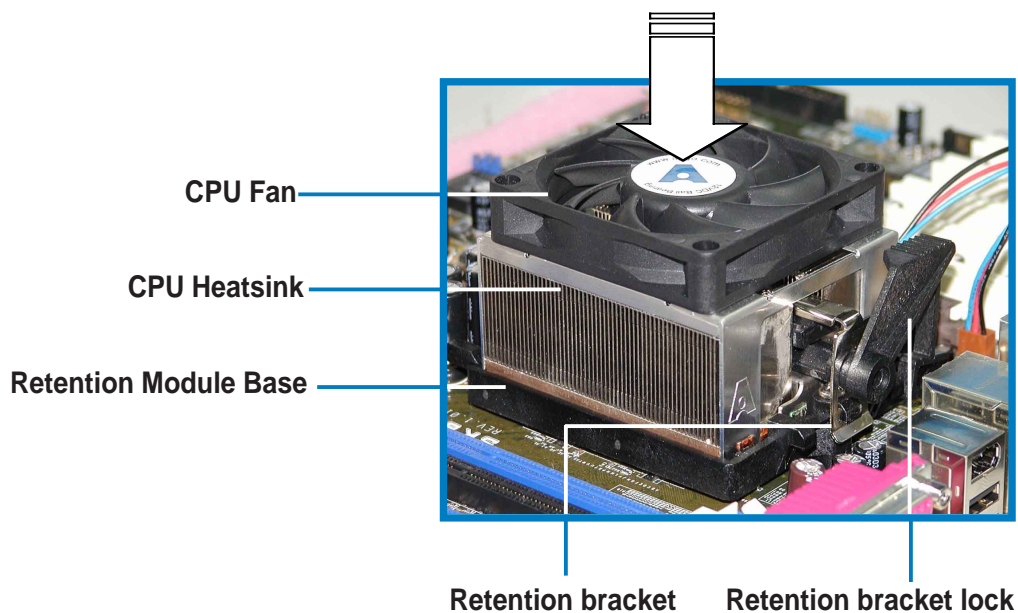

---

Your boxed CPU heatsink and fan assembly should come with installation instructions for the CPU, heatsink, and the retention mechanism. If the instructions in this section do not match the CPU documentation, follow the latter.

---

2. Attach one end of the retention bracket to the retention module base.

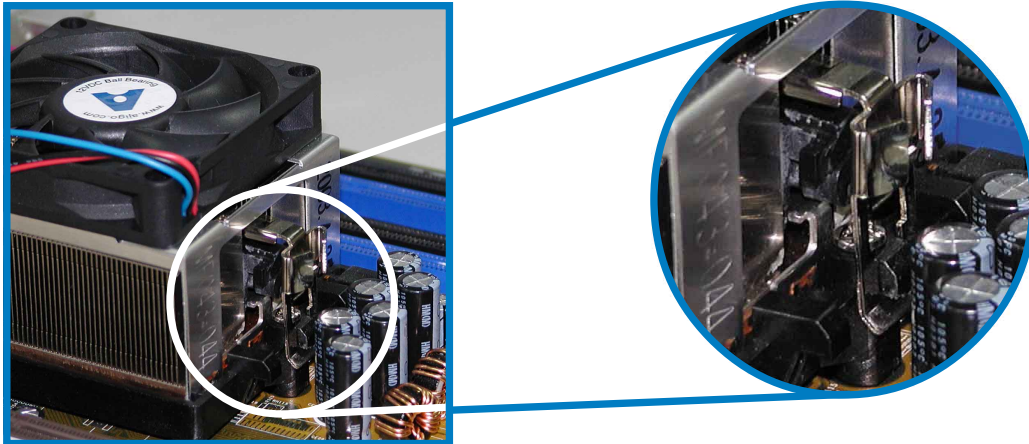

3. Align the other end of the retention bracket (near the retention bracket lock) to the retention module base. A clicking sound denotes that the retention bracket is in place.



Make sure that the fan and heatsink assembly perfectly fits the retention mechanism module base, otherwise you cannot snap the retention bracket in place.

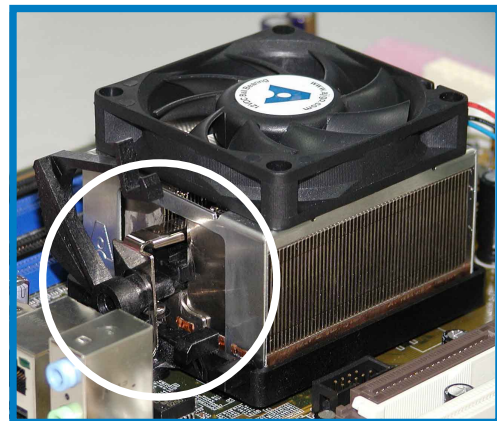

4. Push down the retention bracket lock on the retention mechanism to secure the heatsink and fan to the module base.

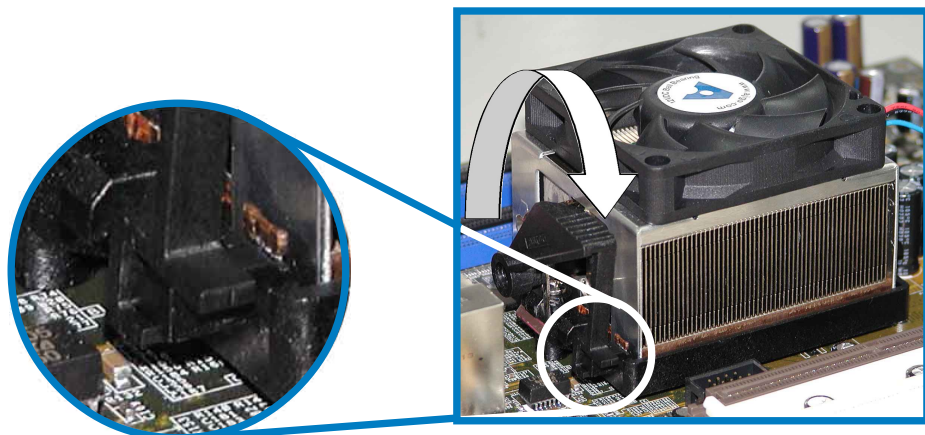

## 2.3.4 Connecting the CPU fan cable

When the heatsink and fan assembly is in place, connect the CPU fan cable to the connector on the motherboard labeled CPU\_FAN.

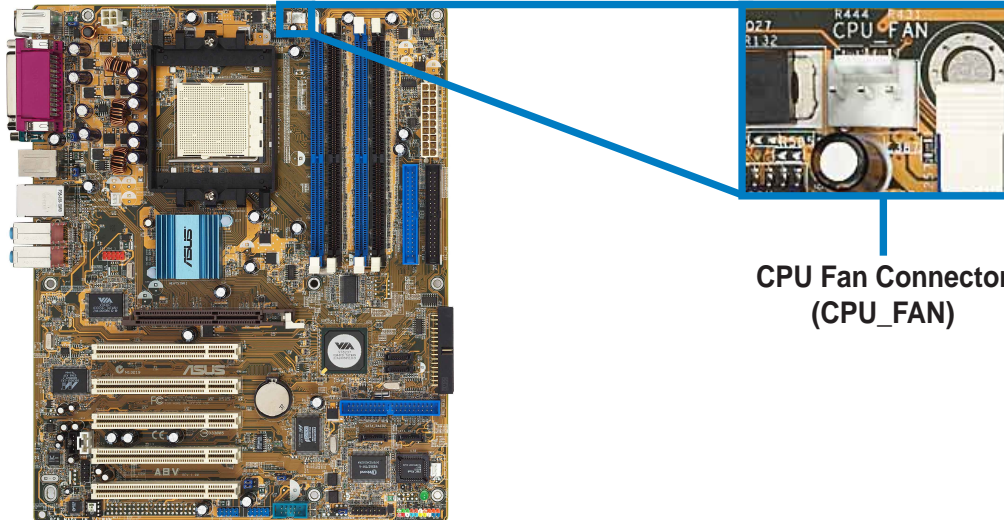

---

Do not forget to connect the CPU fan connector! CPU overheating and hardware monitoring errors may occur if you fail to plug this connector.

---



## 2.4 System memory

### 2.4.1 Overview

The motherboard comes with four Double Data Rate (DDR) Dual Inline Memory Module (DIMM) sockets.

The following figure illustrates the location of the sockets.

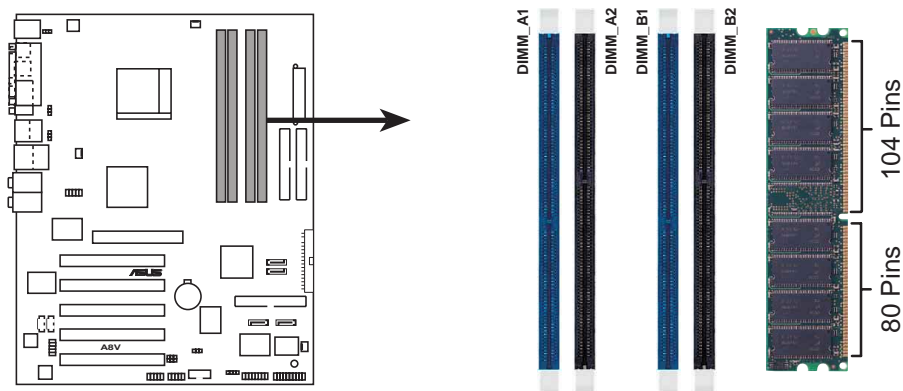

**A8V Deluxe 184-Pin DDR DIMM Sockets**

### 2.4.2 Memory configurations

You may install 64MB, 128MB, 256MB, 512MB, and 1GB unbuffered ECC and non-ECC DDR DIMMs into the DIMM sockets using the memory configurations in this section.

#### Important notes on memory configurations



- Installing DDR DIMMs other than the recommended configurations may cause memory sizing error or system boot failure. Use any of the recommended configurations in Table 1.
- In Dual-channel configurations, install only identical (the same type and size) DDR DIMM pairs for each channel.
- Use the blue DIMM slots first.
- Stacked RAM and DDR DIMM modules with more than 18 chips are not supported.
- Always install DIMMs with the same CAS Latency. For optimum compatibility, obtain memory modules from the same vendors. See Qualified Vendors List on page 2-13.
- When all four sockets are populated with 1GB DIMMs (total 4GB), the system may detect only 3+GB (a little less than 4GB) due to the Southbridge resource allocation.

**Table 1 Recommended memory configurations**

Mode		Sockets			
		DIMM_A1	DIMM_A2	DIMM_B1	DIMM_B2
Single-channel	(1)	—	—	Populated	—
Dual-channel*	(1)	Populated	—	Populated	—
	(2)	Populated	Populated	Populated	Populated

\* Use only identical DDR DIMM pairs.

\* For dual-channel configuration (3), you may:

- *install identical DIMMs in all four sockets*

*or*

- *install identical DIMM pair in DIMM\_A1 and DIMM\_B1 (blue sockets)*

## DDR Qualified Vendors List

The following table lists the PC3200 (DDR400) memory modules that have been tested and qualified for use with this motherboard.

**Table 2 DDR400 Qualified Vendors List**

Size	Vendor	Model	CL	Brand	SS/DS	Component	DIMM support		
							A*	B*	C*
256MB	KINGSTON	KVR400X64C3A/256	N/A	Hynix	SS	HY5DU56822BT-D43	•	•	•
512MB	KINGSTON	KVR400X64C3A/512	N/A	Hynix	DS	HY5DU56822BT-D43	•	•	•
256MB	KINGSTON	KVR400X72C3A/256	N/A	Mosel	SS	V58C2256804SAT5(ECC)	•	•	•
512MB	KINGSTON	KVR400X72C3A/512	N/A	Mosel	DS	V58C2256804SAT5(ECC)	•	•	•
256MB	KINGSTON	KVR400X64C3A/256	N/A	Infineon	SS	HYB25D256800BT-5B	•	•	•
512MB	KINGSTON	KVR400X64C3A/512	N/A	Infineon	DS	HYB25D256809BT-5B	•	•	•
256MB	KINGSTON	KVR400X64C3A/256	N/A	KINGSTON	SS	D3208DL2T-5	•	•	•
512MB	KINGSTON	KVR400X64C3A/512	N/A	KINGSTON	DS	D328DIB-50	•	•	•
512MB	KINGSTON	KHX3200A/512	N/A	N/A	DS	Heat-Sink Package	•	•	•
256MB	SAMSUNG	M381L3223ETM-CCC	3ECC	SAMSUNG	SS	K4H560838E-TCCC(ECC)	•	•	•
512MB	SAMSUNG	M381L6423ETM-CCC	N/A	SAMSUNG	DS	K4H560838E-TCCC(ECC)	•	•	•
256MB	SAMSUNG	M368L3223ETM-CCC	N/A	SAMSUNG	SS	K4H560838E-TCCC	•	•	•
512MB	SAMSUNG	M368L6423ETM-CCC	3	SAMSUNG	DS	K4H560838E-TCCC	•	•	•
256MB	SAMSUNG	M368L3223FTN-CCC	3	SAMSUNG	SS	K4H560838F-TCCC	•	•	•
512MB	SAMSUNG	M368L6423FTN-CCC	N/A	SAMSUNG	DS	K4H560838F-TCCC	•	•	•
512MB	Hynix	HYMD264646B8J-D43 AA	N/A	Hynix	DS	HY5DU56822BT-D43	•	•	•
256MB	MICRON	MT8VDDT3264AG-40BCB	N/A	MICRON	SS	MT46V32M8TG-5BC	•	•	•
512MB	MICRON	MT16VDDT6464AG-40BCB	N/A	MICRON	DS	MT46V32M8TG-5BC	•	•	•
256MB	Infineon	HYS64D32300GU-5-B	3	Infineon	SS	HYB25D256800BT-5B	•	•	•
512MB	Infineon	HYS64D64320GU-5-B	3	Infineon	DS	HYB25D256800BT-5B	•	•	•
256MB	Infineon	HYS64D32300HU-5-C	3	Infineon	SS	HYB25D256800CE-5C	•	•	•
512MB	Infineon	HYS64D64320HU-5-C	N/A	Infineon	DS	HYB25D256800CE-5C	•	•	•
256MB	CORSAIR	CMX256A-3200C2PT	2	Winbond	SS	W942508BH-5	•	•	•
512MB	CORSAIR	CMX512-3200C2	2	Winbond	DS	Heat-Sink Package	•	•	•
512MB	CORSAIR	VS512MB400	2.5	VALUE seLecT	DS	VS32M8-5	•	•	•

A\* - Supports one module inserted in DIMM\_B1 (blue) slot.

B\* - Supports one pair of modules inserted into the blue slots as one pair of Dual-channel memory configuration.

C\* - Supports 4 modules inserted into both the blue and black slots as two pairs of Dual-channel memory configuration.



Visit the ASUS website ([www.asus.com](http://www.asus.com)) for the latest DDR 400 Qualified Vendor List for this motherboard.



Obtain DDR DIMMs only from ASUS qualified vendors for better system performance.

## 2.4.3 Installing a DIMM



Make sure to unplug the power supply before adding or removing DIMMs or other system components. Failure to do so may cause severe damage to both the motherboard and the components.

1. Unlock a DIMM socket by pressing the retaining clips outward.
2. Align a DIMM on the socket such that the notch on the DIMM matches the break on the socket.

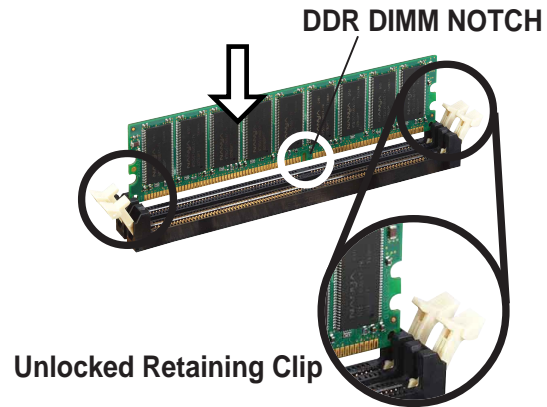

A DDR DIMM is keyed with a notch so that it fits in only one direction. DO NOT force a DIMM into a socket to avoid damaging the DIMM.

3. Firmly insert the DIMM into the socket until the retaining clips snap back in place and the DIMM is properly seated.

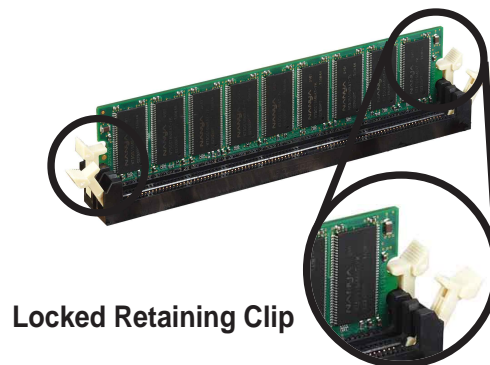

## 2.4.4 Removing a DIMM

Follow these steps to remove a DIMM.

1. Simultaneously press the retaining clips outward to unlock the DIMM.

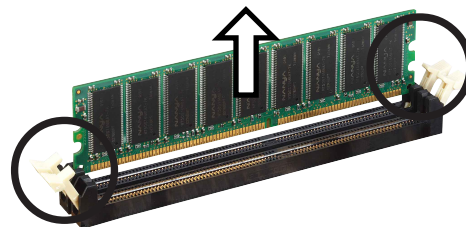

Support the DIMM lightly with your fingers when pressing the retaining clips. The DIMM might get damaged when it flips out with extra force.

2. Remove the DIMM from the socket.

## 2.5 Expansion slots

In the future, you may need to install expansion cards. The motherboard has available PCI slots and an Accelerated Graphics Port (AGP) slot. The following sub-sections describe the slots and the expansion cards that they support.



---

Make sure to unplug the power cord before adding or removing expansion cards. Failure to do so may cause you physical injury and damage motherboard components.

---

### 2.5.1 Installing an expansion card

Follow these steps to install an expansion card.

1. Read the documentation that came with the expansion card and make the necessary hardware settings for the card.
2. Remove the system unit cover (if your motherboard is already installed in a chassis).
3. Remove the bracket opposite the slot that you intend to use. Keep the screw for later use.
4. Align the card connector with the slot and press firmly until the card is completely seated on the slot.
5. Secure the card to the chassis with screws.
6. Replace the system cover.

### 2.5.2 Configuring an expansion card

After installing the expansion card, configure the card by adjusting the software settings.

1. Turn on the system and change the necessary BIOS settings, if any. See Chapter 4 for information on BIOS setup.
2. Assign an IRQ to the card. Refer to the tables on the next page.
3. Install the software drivers for the expansion card.

## 2.5.3 Interrupt assignments

### Standard Interrupt Assignments

IRQ	Priority	Standard Function
0	1	System Timer
1	2	Keyboard Controller
2	N/A	Programmable Interrupt
3*	11	Communications Port (COM2)
4*	12	Communications Port (COM1)
5*	13	Sound Card (sometimes LPT2)
6	14	Floppy Disk Controller
7*	15	Printer Port (LPT1)
8	3	System CMOS/Real Time Clock
9*	4	ACPI Mode when used
10*	5	IRQ Holder for PCI Steering
11*	6	IRQ Holder for PCI Steering
12*	7	PS/2 Compatible Mouse Port
13	8	Numeric Data Processor
14*	9	Primary IDE Channel
15*	10	Secondary IDE Channel

\* These IRQs are usually available for ISA or PCI devices.

### IRQ assignments for this motherboard

	INT A	INT B	INT C	INT D
PCI slot 1	shared	—	—	—
PCI slot 2	—	shared	—	—
PCI slot 3	—	—	shared	—
PCI slot 4	—	—	—	used
PCI slot 5	shared	—	—	—
Gigabit LAN	—	shared	—	—
Onboard RAID	—	—	shared	—
Onboard 1394	shared	—	—	—
Serial ATA	—	—	shared	—
AGP slot	shared	—	—	—



When using PCI cards on shared slots, ensure that the drivers support “Share IRQ” or that the cards do not need IRQ assignments. Otherwise, conflicts will arise between the two PCI groups, making the system unstable and the card inoperable.

## 2.5.4 PCI slots

The PCI slots support PCI cards such as a LAN card, SCSI card, USB card, and other cards that comply with PCI specifications. The following figure shows a LAN card installed on a PCI slot.

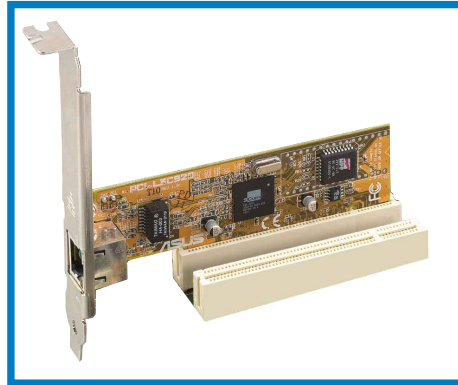

## 2.5.5 AGP slot

The Accelerated Graphics Port (AGP) slot supports AGP8X/4X cards. When you buy an AGP card, make sure that you ask for one with +1.5V specification. Note the notches on the card golden fingers to ensure that they fit the AGP slot on your motherboard.



Install only 1.5V AGP cards on this motherboard! 3.3V AGP cards are not supported in this motherboard.

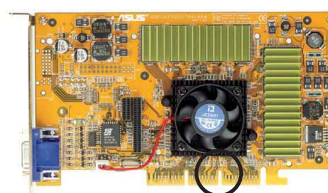
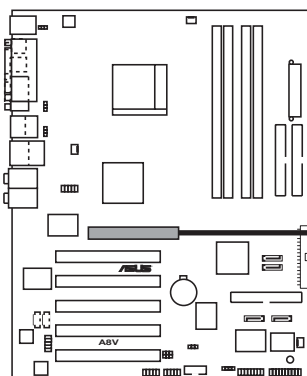

Keyed for 1.5v

### A8V Deluxe Accelerated Graphics Port (AGP)



If installing the ATI® 9500 or 9700 Pro Series VGA cards, use only the card version **PN xxx-xxxxx-30** or later, for optimum performance and overclocking stability.

## 2.6 Jumpers

### 1. Clear RTC RAM (CLRRTC)

This jumper allows you to clear the Real Time Clock (RTC) RAM in CMOS. You can clear the CMOS memory of date, time, and system setup parameters by erasing the CMOS RTC RAM data. The RAM data in CMOS, that include system setup information such as system passwords, is powered by the onboard button cell battery.

To erase the RTC RAM:

1. Turn OFF the computer and unplug the power cord.
2. Remove the onboard battery.
3. Move the jumper from pins 1-2 (default) to pins 2-3. Keep the cap on pins 2-3 for about 5~10 seconds, then move the cap back to pins 1-2.
4. Replace the battery.
5. Plug the power cord and turn ON the computer.
6. Hold down the <Del> key during the boot process and enter BIOS setup menu.
7. Load the BIOS default settings or key-in data.

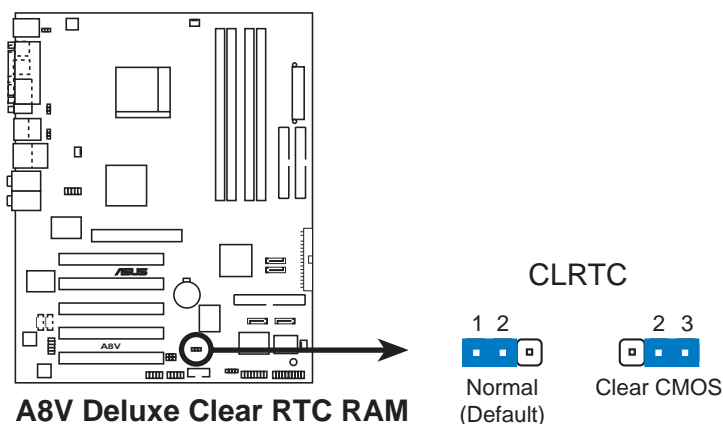

You do not need to clear the RTC when the system hangs due to overclocking. For system failure due to overclocking, use the C.P.R. (CPU Parameter Recall) feature. Shut down and reboot the system so the BIOS can automatically reset the parameter settings to the default values.



## 2. Keyboard power (3-pin KBPWR)

This jumper allows you to enable or disable the keyboard wake-up feature. Set this jumper to pins 2-3 (+5VSB) if you wish to wake up the computer when you press a key on the keyboard. This feature requires an ATX power supply that can supply at least 1A on the +5VSB lead, and a corresponding setting in the BIOS (See section “4.5.5 APM Configuration”).

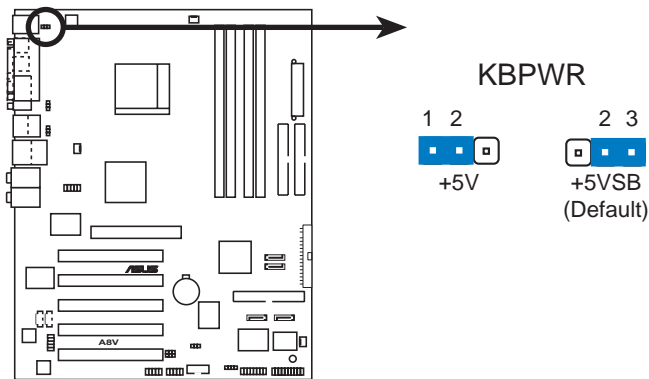

**A8V Deluxe Keyboard Power Setting**

## 3. USB device wake-up (3-pin USBPWR12, USBPWR34, USBPWR56, USBPWR78)

Set these jumpers to +5V to wake up the computer from S1 sleep mode (CPU stopped, DRAM refreshed, system running in low power mode) using the connected USB devices. Set to +5VSB to wake up from S3 and S4 sleep modes (no power to CPU, DRAM in slow refresh, power supply in reduced power mode).

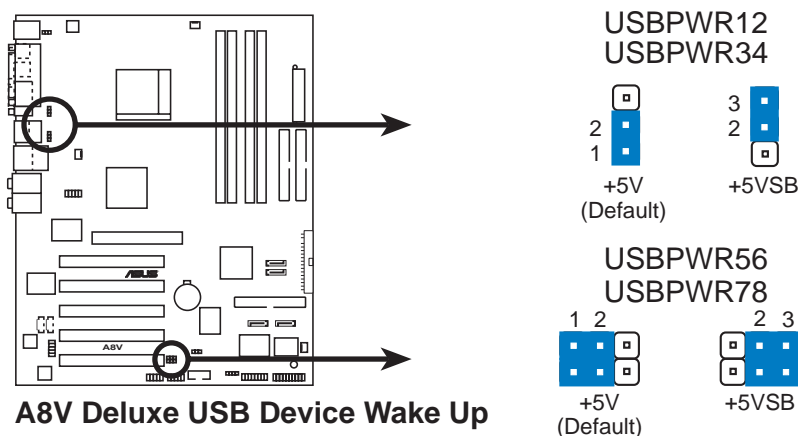

**A8V Deluxe USB Device Wake Up**



- The USB device wake-up feature requires a power supply that can provide 500mA on the +5VSB lead for each USB port. Otherwise, the system would not power up.
- The total current consumed must NOT exceed the power supply capability (+5VSB) whether under normal condition or in sleep mode.

## 2.7 Connectors

### 2.7.1 Rear panel connectors

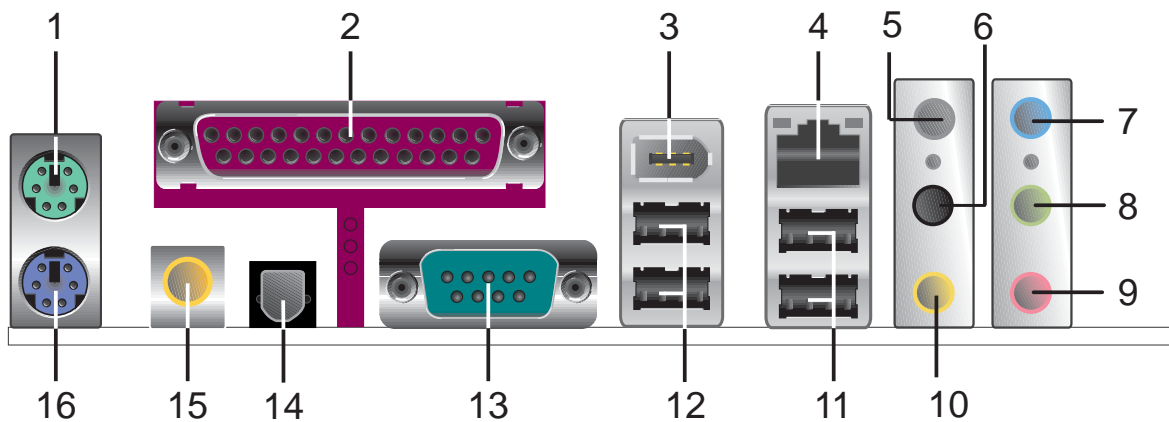

1. **PS/2 mouse port.** This green 6-pin connector is for a PS/2 mouse.
2. **Parallel port.** This 25-pin port connects a parallel printer, a scanner, or other devices.
3. **IEEE 1394 port.** This 6-pin IEEE 1394 port provides high-speed connectivity for audio/video devices, storage peripherals, other PCs and/or portable devices.
4. **RJ-45 port.** This port allows connection to a Local Area Network (LAN) through a network hub.
5. **Rear Speaker-Out port.** This Rear Speaker (gray) port connects to the rear speakers on a 4-channel, 6-channel or 8-channel audio configuration.
6. **Side Speaker-Out port.** This Side Speaker out (black) port connects to the side speakers in an 8-channel audio configuration.
7. **Line-In port.** This Line In (light blue) port connects a tape player or other audio sources.
8. **Line-Out port.** This Line Out (lime) port connects a headphone or a speaker. In 4-channel, 6-channel and 8-channel mode, the function of this jack becomes Front Speaker Out.
9. **Microphone port.** This Mic (pink) port connects a microphone.
10. **Center/Subwoofer port.** This Center/Subwoofer (yellow orange) port connects to the center/subwoofer speakers on a 6-channel or 8-channel audio configuration.

## Audio 2, 4, 6, or 8-channel configuration

	Headset/ 2-channel	4-channel	6-channel	8-channel
Light Blue	Line In	Line In	Line In	Line In
Lime	Line Out	Front Speaker Out	Front Speaker Out	Front Speaker Out
Pink	Mic In	Mic In	Mic In	Mic In
Gray	-	Rear Speaker Out	Rear Speaker Out	Rear Speaker Out
Black	-	-	-	Side Speaker Out
Yellow Orange	-	-	Center/Subwoofer	Center/Subwoofer

- 11. USB 2.0 ports 3 and 4.** These two 4-pin Universal Serial Bus (USB) ports are available for connecting USB 2.0 devices.
- 12. USB 2.0 ports 1 and 2.** These two 4-pin Universal Serial Bus (USB) ports are available for connecting USB 2.0 devices.
- 13. Serial connector.** This 9-pin COM1 port is for serial devices.
- 14. S/PDIF optical out port.** This port connects to external audio output devices with optical cable connectors.
- 15. S/PDIF coaxial out port.** This port connects to external audio output devices with coaxial cable connectors.
- 16. PS/2 keyboard port.** This purple connector is for a PS/2 keyboard.

## 2.7.2 Internal connectors

### 1. IDE connectors (40-pin PRI\_IDE, SEC\_IDE)

This connector supports the provided UltraDMA IDE hard disk ribbon cable. Connect the cable's blue connector to the primary (recommended) or secondary IDE connector, then connect the gray connector to the UltraDMA slave device (hard disk drive) and the black connector to the UltraDMA master device.



- Follow the hard disk drive documentation when setting the device in master or slave mode.
- Pin 20 on each IDE connector is removed to match the covered hole on the UltraDMA cable connector. This prevents incorrect orientation when you connect the cables.

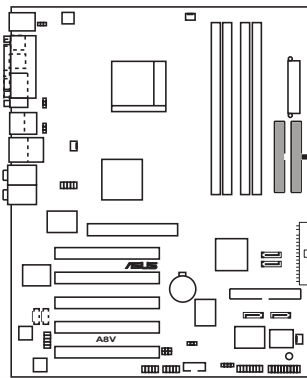

**A8V Deluxe IDE Connectors**

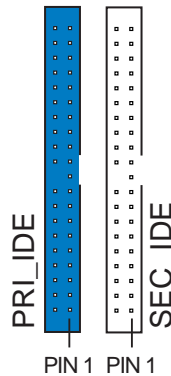

**NOTE:** Orient the red markings (usually zigzag) on the IDE ribbon cable to PIN 1.

## 2. Floppy disk drive connector (34-1 pin FLOPPY)

This connector supports the provided floppy drive ribbon cable. After connecting one end to the motherboard, connect the other end to the floppy drive. (Pin 5 is removed to prevent incorrect insertion when using ribbon cables with pin 5 plug).

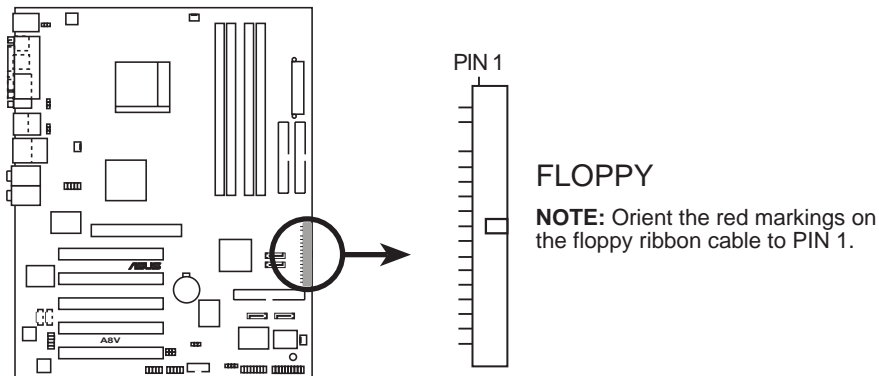

**A8V Deluxe Floppy Disk Drive Connector**

## 3. RAID ATA connector (40-1 pin PRI\_RAID)

This connector supports ATA133 devices that you can configure as a RAID set. Through the onboard Promise® PDC20378 controller, you can configure either a RAID 0, RAID 1, or RAID 0 + 1 set with the RAID Serial ATA connectors. You can use the RAID feature to set up a disk array configuration and to support additional IDE devices.

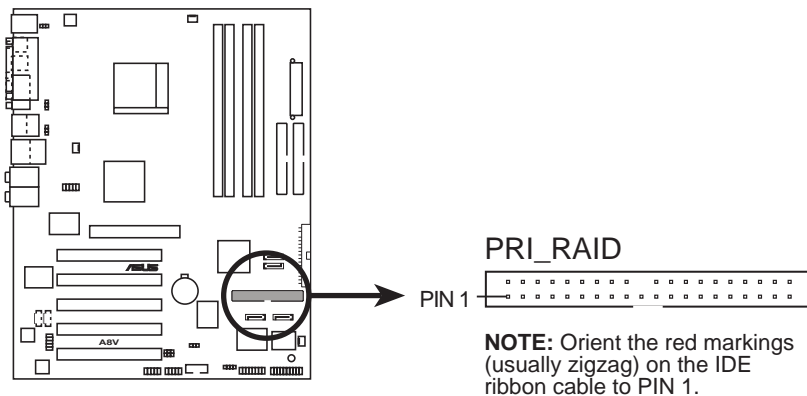

**A8V Deluxe RAID Connectors**



- By default, the RAID connector is set as RAID. If you want to use an independent drive, set the **Operation Mode** to IDE Mode under Advanced menu of the BIOS. Refer to “Chapter 4: BIOS Setup” for details.
- The Promise® PDC20378 controller does not support ATAPI devices such as CD-ROMs, DVD-ROMs, etc.
- Refer to section “5.6.2 Promise® RAID configurations” for details.

#### 4. Serial ATA connectors (7-pin SATA1, SATA2)

These connectors support the thin Serial ATA cables for primary internal storage devices. The current Serial ATA interface allows up to 150 MB/s data transfer rate, faster than the standard parallel ATA with 133 MB/s (UltraDMA133).

You can configure a RAID 0, RAID 1, or JBOD set using these connectors.

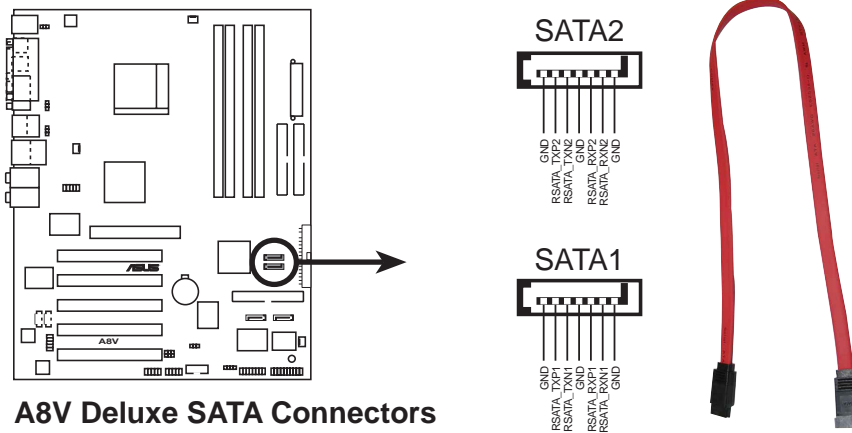

**A8V Deluxe SATA Connectors**



---

#### Important notes on Serial ATA solution:

- The Serial ATA cable is smaller and more flexible, allowing easier routing inside the chassis. The lower pin count of the Serial ATA cable eliminates the problem caused by the wide, flat ribbon cables of the Parallel ATA interface.
  - Hot plug support for Serial ATA drive and connections is not available on this motherboard.
  - Install Windows® XP Service Pack 1 when using Serial ATA drives.
  - Refer to section “5.6.3 VIA RAID configurations” for details on SATA RAID configuration.
-

## 5. RAID Serial ATA connectors (7-pin SATA\_RAID1, SATA\_RAID2)

These Serial ATA connectors support SATA hard disks that you can configure as a RAID set. Through the onboard Promise® PDC20378 RAID controller, you can create a RAID 0, RAID 1, or RAID 0+1 configuration together with the RAID ATA133 connector (PRI\_RAID).

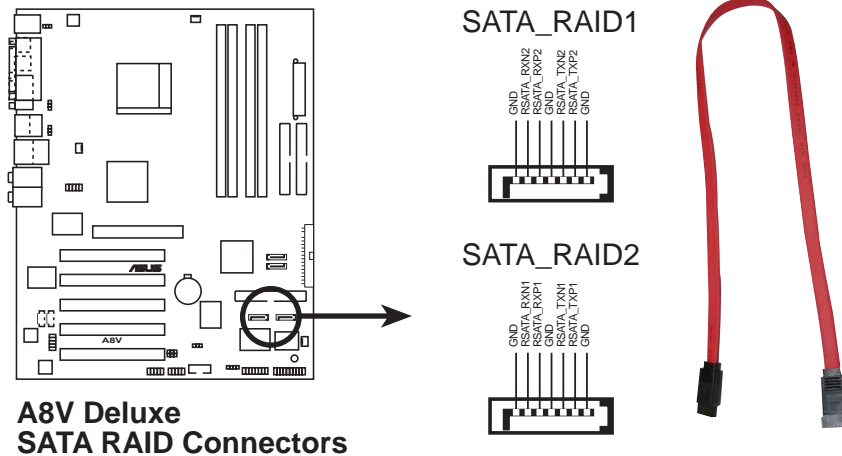

- By default, the RAID connector is set as RAID. If you want to use it as an independent drive, set the **Operation Mode** to IDE Mode under the Advanced menu.
- To create a RAID set, make sure that you have connected the Serial ATA cable and installed Serial ATA devices. You cannot enter the SATARaid™ utility and SATA BIOS setup during POST if no Serial ATA device is connected.
- The Promise® PDC20378 RAID controller does not support ATAPI devices such as CD-ROMs, DVD-ROMs, etc.
- Refer to section “5.6.2 Promise® RAID Configurations” for details on SATA RAID configuration.

## 6. CPU, Power and Chassis Fan Connectors (3-pin CPU\_FAN, PWR\_FAN, CHA\_FAN)

The fan connectors support cooling fans of 350mA~740mA (8.88W max.) or a total of 1A~2.22A (26.64W max.) at +12V. Connect the fan cables to the fan connectors on the motherboard, making sure that the black wire of each cable matches the ground pin of the connector.



Do not forget to connect the fan cables to the fan connectors. Lack of sufficient air flow within the system may damage the motherboard components. These are not jumpers! **DO NOT** place jumper caps on the fan connectors!

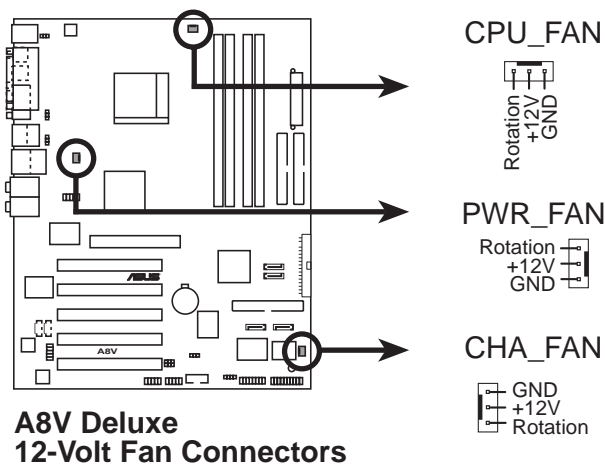

## 7. Serial Port 2 connector (10-1 pin COM2)

This connector accommodates a serial port using a serial port bracket. Connect the bracket cable to this connector then install the bracket into a slot opening at the back of the system chassis.

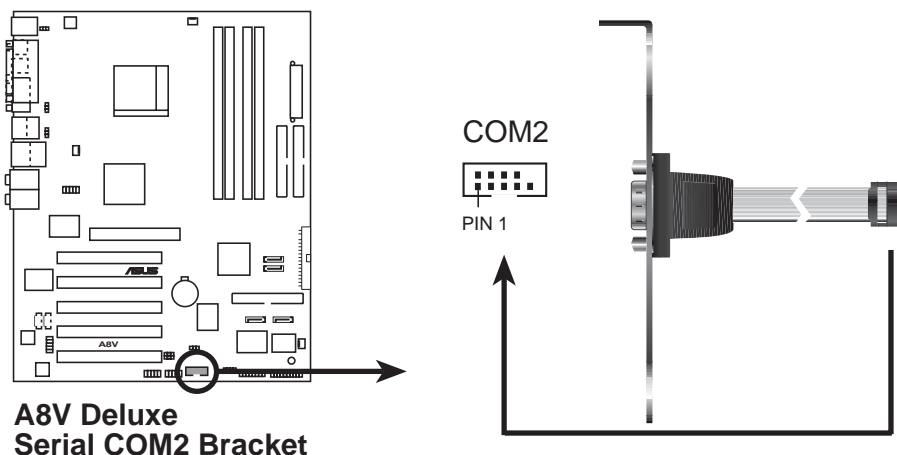

The serial port bracket is purchased separately.



## 8. ATX power connectors (20-pin ATXPWR, 4-pin ATX12V)

These connectors are for ATX 12V power supply. The plugs from the power supply are designed to fit these connectors in only one orientation. Find the proper orientation and push down firmly until the connectors completely fit.

In addition to the 20-pin ATX power connector, this motherboard requires that you connect the 4-pin ATX +12V power plug to provide sufficient power to the CPU.



- Do not forget to connect the 4-pin ATX +12V power plug. Otherwise, the system does not boot up.
- Make sure that your ATX 12V power supply can provide 8A on the +12V lead and at least 1A on the +5-volt standby lead (+5VSB). The minimum recommended wattage is 300W, or 350W for a fully configured system. The system may become unstable or might not boot up, if the power is inadequate.

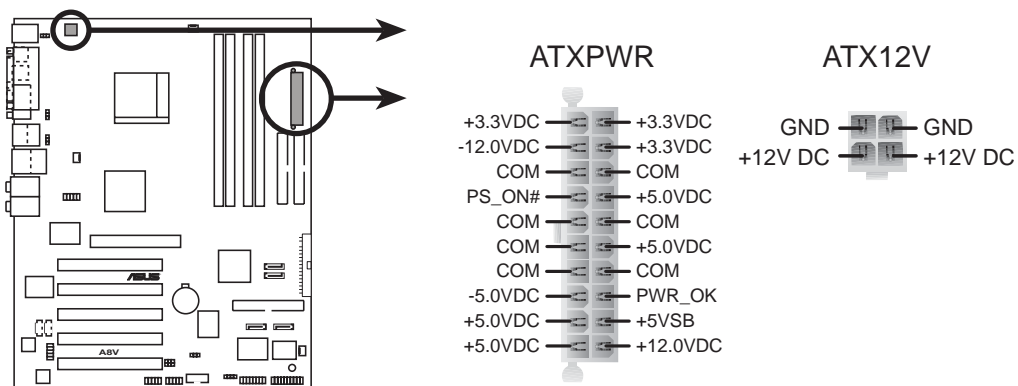

**ASUS A8V Deluxe ATX Power Connectors**

## 9. USB headers (10-1 pin USB56, USB78)

If the USB ports on the rear panel are inadequate, a USB header is available for additional USB ports. The USB header complies with USB 2.0 specification that supports up to 480 Mbps connection speed. This speed advantage over the conventional 12 Mbps on USB 1.1 allows faster Internet connection, interactive gaming, and simultaneous running of high-speed peripherals.



You must install the driver before you can use the USB 2.0 capability.

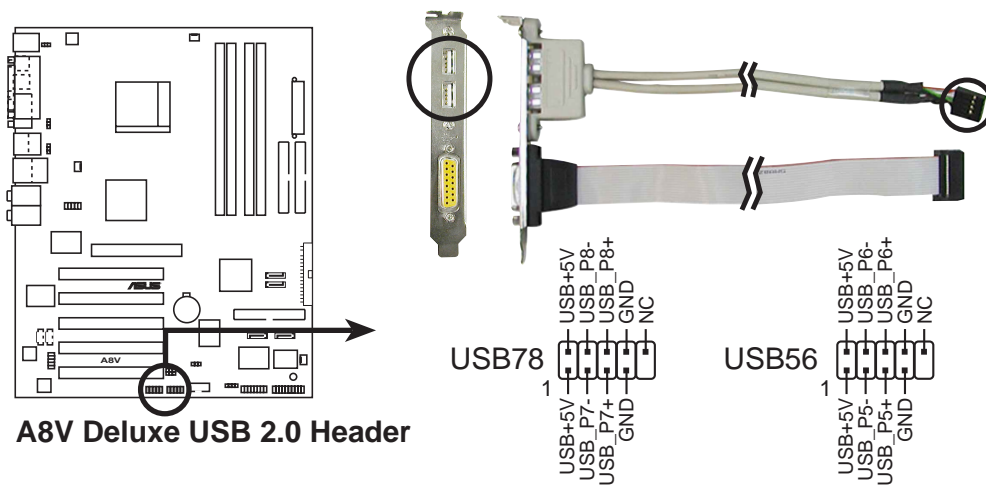

NEVER connect a **1394 cable** to any of the USB (blue) connectors. Doing so will damage the motherboard!

## 10. Internal audio connectors (4-pin CD, AUX)

These connectors allow you to receive stereo audio input from sound sources such as a CD-ROM, TV tuner, or MPEG card.

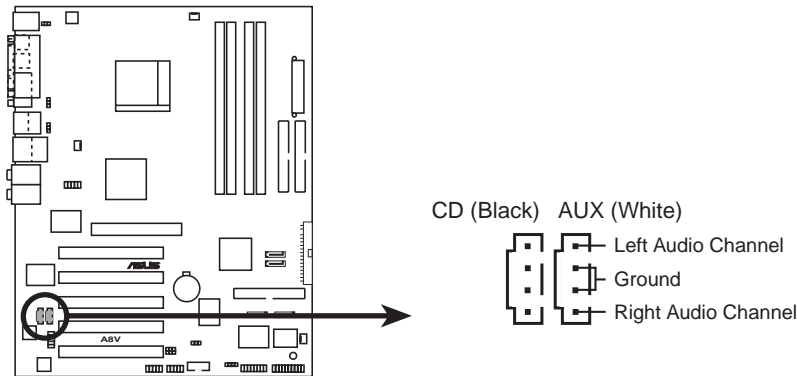

**A8V Deluxe Internal Audio Connectors**

## 11. IEEE 1394 connectors (10-1 pin IE1394\_1)

This connector is for the bundled IEEE 1394 module. Attach the 10-1 pin cable plug to this connector. You can also connect a 1394-compliant internal hard disk to this connector.

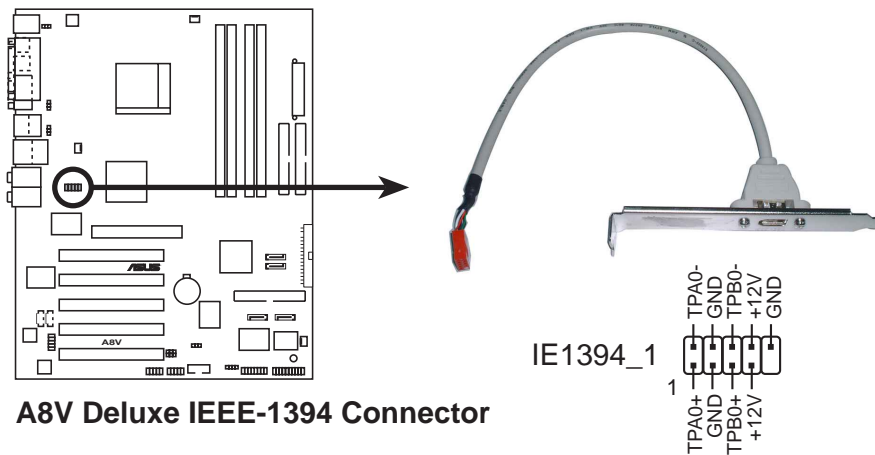

**A8V Deluxe IEEE-1394 Connector**



**NEVER** connect a **USB cable** to the IEEE 1394 (orange) connector. Doing so will damage the motherboard!

## 12. Front panel audio connector (10-1 pin FP\_AUDIO)

This is an interface for the front panel audio cable that allows convenient connection and control of audio devices.

By default, the pins labeled LINE\_OUT\_R/BLINE\_OUT\_R and the pins LINE\_OUT\_L/BLINE\_OUT\_L are shorted with jumper caps. Remove the caps only when you are connecting the front panel audio cable.

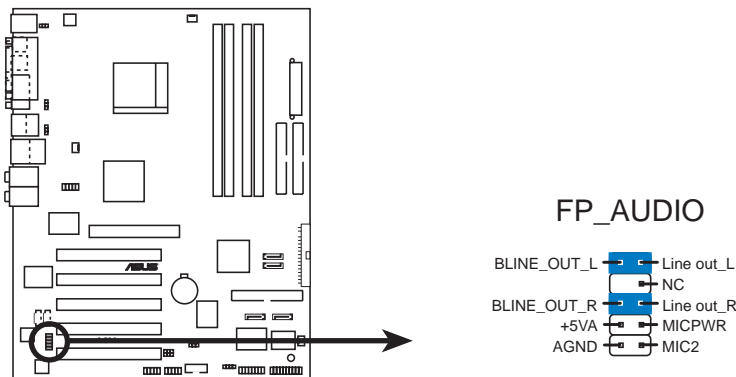

**A8V Deluxe Front Panel Audio Connector**

## 13. GAME/MIDI connector (16-1 pin GAME)

This connector supports a GAME/MIDI module. If a GAME/MIDI module is available, connect the GAME/MIDI cable to this connector. The GAME/MIDI port on the module connects a joystick or a game pad for playing games, and MIDI devices for playing or editing audio files.

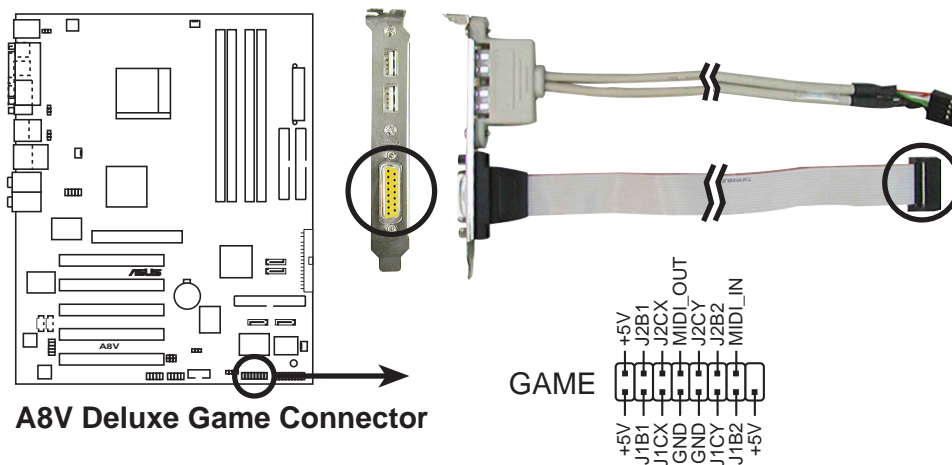

**A8V Deluxe Game Connector**

## 14. Chassis intrusion connector (4-1 pin CHASSIS)

This lead is for a chassis designed with intrusion detection feature. This requires an external detection mechanism such as a chassis intrusion sensor or microswitch. When you remove any chassis component, the sensor triggers and sends a high-level signal to this lead to record a chassis intrusion event.

By default, the pins labeled “Chassis Signal” and “Ground” are shorted with a jumper cap. To use the chassis intrusion detection feature, remove the jumper cap from the pins.

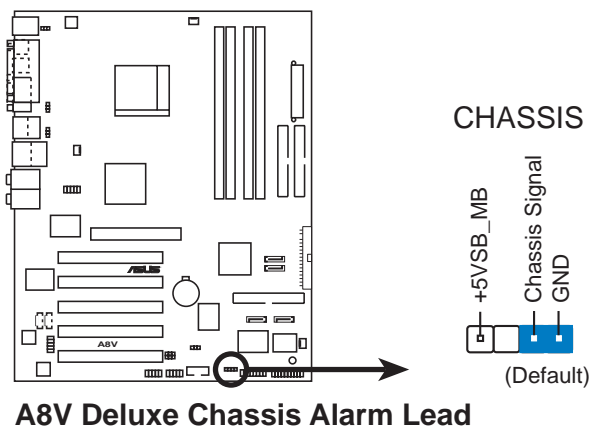

## 15. System panel connector (20-pin PANEL)

This connector accommodates several system front panel functions.

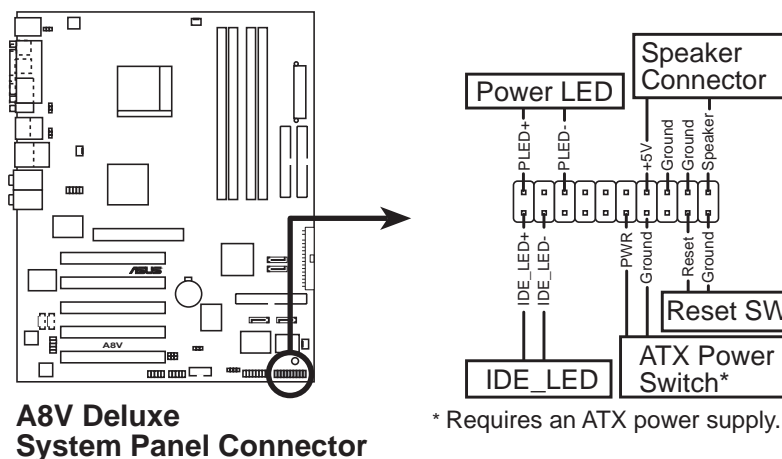

The System Panel connector is color-coded for easy and foolproof connection. Take note of the specific connector colors as described.

- **System Power LED Lead (Green 3-1 pin PLED)**  
This 3-1 pin connector connects to the system power LED. The LED lights up when you turn on the system power, and blinks when the system is in sleep mode.
- **System Warning Speaker Lead (Orange 4-pin SPKR)**  
This 4-pin connector is for the case-mounted speaker. It allows you to hear system beeps and warnings.
- **Reset Switch Lead (Blue 2-pin RESET)**  
This 2-pin connector is for the case-mounted reset switch to reboot the system without turning off the system power.
- **ATX Power Switch / Soft-Off Switch Lead (Yellow 2-pin PWRBTN )**  
This connector is for the system power switch. Pressing the power switch turns the system between ON and SLEEP, or ON and SOFT OFF, depending on the BIOS or OS settings. Pressing the power switch while in the ON mode for more than four seconds turns the system OFF.
- **Hard disk activity LED (Red 2-pin IDE\_LED)**  
This connector supplies power to the hard disk activity LED. Any read or write activity of an IDE device causes this LED to light up.

# ***Chapter 3***

This chapter describes the power up sequence, the vocal POST messages and ways of shutting down the system.

## **Powering up**

## **Chapter summary**

<b>3.1</b>	<b>Starting up for the first time .....</b>	<b>3-1</b>
<b>3.2</b>	<b>Powering off the computer .....</b>	<b>3-2</b>
<b>3.3</b>	<b>ASUS POST Reporter™ .....</b>	<b>3-3</b>



## 3.1 Starting up for the first time

1. After making all the connections, replace the system case cover.
2. Make sure that all switches are off.
3. Connect the power cord to the power connector at the back of the system chassis.
4. Connect the power cord to a power outlet that is equipped with a surge protector.
5. Turn on the devices in the following order:
  - a. Monitor
  - b. External SCSI devices (starting with the last device on the chain)
  - c. System power (if you are using an ATX power supply, you need to switch on the power supply as well as press the ATX power switch on the front of the chassis).
6. After applying power, the power LED on the system front panel case lights up. For ATX power supplies, the system LED lights up when you press the ATX power switch. If your monitor complies with “green” standards or if it has a “power standby” feature, the monitor LED may light up or switch between orange and green after the system LED turns on. The system then runs the power-on tests. While the tests are running, the BIOS beeps or additional messages appear on the screen. If you do not see anything within 30 seconds from the time you turned on the power, the system may have failed a power-on test. Check the jumper settings and connections or call your retailer for assistance.
7. At power on, hold down <Del> to enter BIOS Setup. Follow the instructions in Chapter 4.

## 3.2 Powering off the computer

### 3.2.1 Using the OS shut down function

If you are using Windows® 98SE/ME/2000:

1. Click the **Start** button then click **Shut Down...**
2. Make sure that the **Shut down** option button is selected, then click the **OK** button to shut down the computer.
3. The power supply should turn off after Windows® shuts down.

If you are using Windows® XP:

1. Click the **Start** button then select **Turn Off Computer.**
2. Click the **Turn Off** button to shut down the computer.
3. The power supply should turn off after Windows® shuts down.

### 3.2.2 Using the dual-function power switch

While the system is ON, pressing the power switch for less than four seconds puts the system to sleep mode or to soft-off mode, depending on the BIOS setting. If you press the power switch for more than four seconds, the system enters the soft-off mode regardless of the BIOS setting. See section “4.5 Power Menu” in Chapter 4.

## 3.3 ASUS POST Reporter™

This motherboard includes the Winbond speech controller to support a special feature called the ASUS POST Reporter™. This feature gives you vocal POST messages and alerts you of system events and boot status. In case of a boot failure, you will hear the specific cause of the problem.

These POST messages are customizable using the Winbond Voice Editor software that came with your package. You can record your own messages to replace the default messages.

### 3.3.1 Vocal POST messages

Following is a list of the default POST messages and their corresponding actions:

POST Message	Action
No CPU installed	<ul style="list-style-type: none"><li>• Install a supported processor into the CPU socket. See section “2.3 Central Processing Unit (CPU)” for supported processors.</li></ul>
System failed CPU test	<ul style="list-style-type: none"><li>• Check the CPU if properly installed.</li><li>• Call ASUS technical support for assistance. See the “ASUS contact information” on the inside front cover of this manual.</li></ul>
System failed memory test	<ul style="list-style-type: none"><li>• Install supported DDR DIMMs into the sockets.</li><li>• Check if the DIMMs on the DIMM sockets are properly installed.</li><li>• Make sure that your DIMMs are not defective.</li><li>• Refer to section “2.4 System memory” for instructions on installing a DIMM.</li></ul>
System failed VGA test	<ul style="list-style-type: none"><li>• Install a PCI VGA card into one of the PCI slots, or a 1.5V AGP card into the AGP slot.</li><li>• Make sure that your VGA/AGP card is not defective.</li></ul>
System failed due to CPU overclocking	<ul style="list-style-type: none"><li>• Check your CPU settings in the BIOS and make sure you only set to the recommended settings. See section “4.4 Advanced menu.”</li></ul>

POST Message	Action
No keyboard detected	<ul style="list-style-type: none"> <li>• Check your keyboard if it is properly connected to the purple PS/2 connector on the rear panel.</li> <li>• See section “2.7.1 Rear panel connectors” for the location of the connector.</li> </ul>
No IDE hard disk detected	<ul style="list-style-type: none"> <li>• Make sure you have connected an IDE hard disk drive to one of the IDE connectors on the motherboard.</li> </ul>
CPU temperature too high	<ul style="list-style-type: none"> <li>• Check CPU fan if it is working properly.</li> </ul>
CPU fan failed	<ul style="list-style-type: none"> <li>• Check the CPU fan and make sure it turns on after you apply power to the system.</li> <li>• Make sure that your CPU fan supports the fan speed detection function.</li> </ul>
CPU voltage out of range	<ul style="list-style-type: none"> <li>• Check your power supply and make sure it is not defective.</li> <li>• Call ASUS technical support for assistance. See the “ASUS contact information” on the inside front cover of this manual.</li> </ul>
System completed Power-On Self Test	<ul style="list-style-type: none"> <li>• No action required</li> </ul>
Computer now booting from operating system	<ul style="list-style-type: none"> <li>• No action required</li> </ul>



---

You can disable the ASUS POST Reporter™ in the BIOS setup. See section “4.4.6 Speech Configuration”.

---

## 3.3.2 Winbond Voice Editor

The Winbond Voice Editor software allows you to customize the vocal POST messages. Install the software from the utilities menu of the support CD. See section “5.2.3 Utilities menu” for details.



---

To avoid conflicts, do not run the Winbond Voice Editor while running the ASUS PC Probe.

---

Follow these steps to use the Winbond Voice Editor.

### Launching the program

Launch the program either from the Winbond Voice Editor icon on your desktop, or from the Windows Start menu, select **Programs->Winbond Voice Editor->Voice Editor**.

The Winbond Voice Editor screen appears.

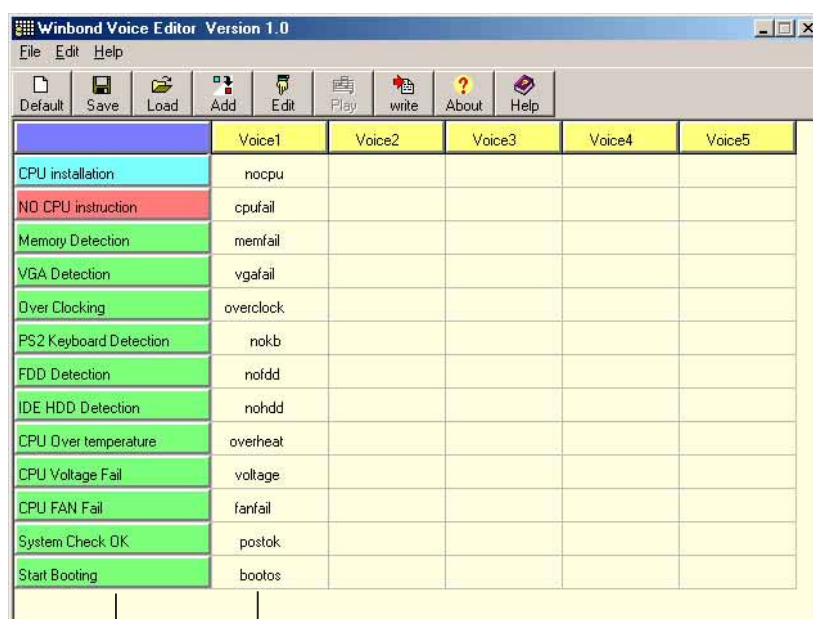

Default Messages

POST Events

### Playing the default wave files

To play the default wave files, simply click on a POST event on the left side of the screen, then click the Play button.



---

The default language setting is English.

---

## Changing the default language

1. Click the **Load** button. A window showing the available languages appears.
2. Select your desired language then click **Open**. The event messages for the language you selected appear on the Voice Editor screen.

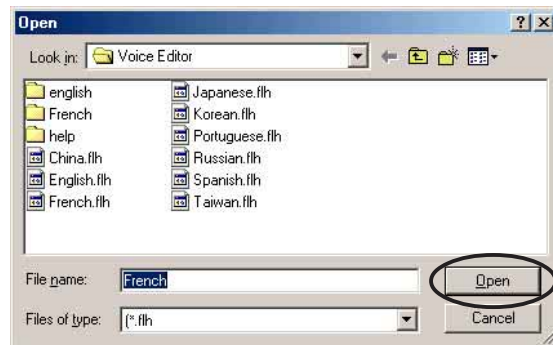

For some languages, not all events have a corresponding message due to file size constraints.

3. Click the **Write** button to update the EEPROM.
4. Click **Yes** on the confirmation window that appears. The next time you boot your computer, the POST messages are announced in the language that you selected.

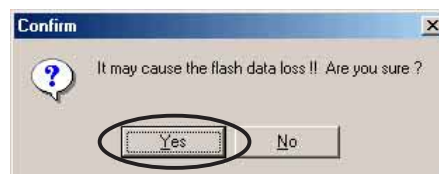

## Customizing your POST messages

If your language is not in the selection or if you want to record your own POST messages to replace the pre-installed wave files, you can easily do so.

Follow these steps to customize your POST messages.

1. Launch the Voice Editor and take note of the list of POST events on the leftmost column of the screen.
2. Prepare your message for each event.



The total compressed size for all the wave files must not exceed 1Mbit, so make your messages as short as possible.

3. Use a recording software, such as Windows Recorder, to record your messages.
4. Save the messages as wave files (.WAV). We recommend that you save your files in low quality to keep them small. For example, use 8-bit, mono quality at 22Khz sampling rate.



We suggest that you create a separate folder for your wave files so you can locate them easily in one place.

5. From the Voice Editor screen, click the **Add** button to display the Add Wave File window.
6. Copy the wave files that you recorded to the database. Close the window when done.

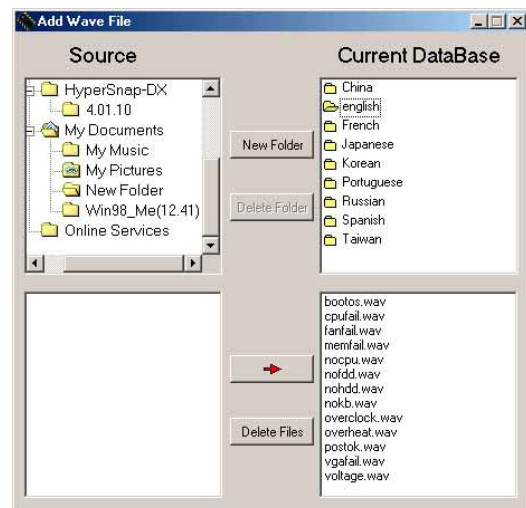

7. Select a POST event on the Voice Editor screen, then click the **Edit** button. The Event Sound Editor window appears.
8. Locate and select your wave file for the event then click on the arrow opposite Voice1. The file you selected appears on the space next to it.
9. Click **OK** to return to the Voice Editor screen.
10. Repeat steps 7 to 9 for the other events.
11. When done, click **Save**. A window appears prompting you to save your configuration.
12. Type a file name with a **.flh** extension, then click Save.
13. Click the **Write** button to compress the file and copy into the EEPROM.
14. Click **Yes** on the confirmation window that appears.

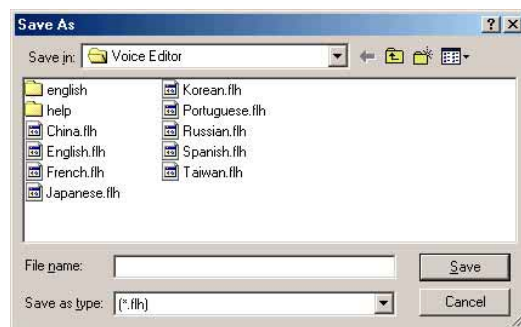
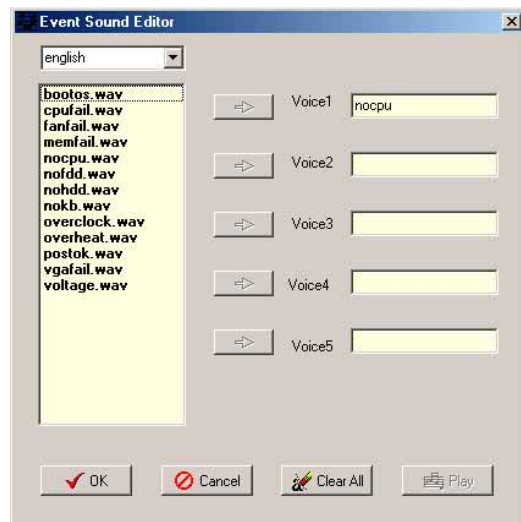

If you receive an error message telling you that the files exceed the total allowable size, do one or all of the following.

- Modify your messages to make them shorter.
- Save the wave files at a lower quality.
- Skip lesser used events like FDD Detection, IDE HDD Detection, etc.



# ***Chapter 4***

This chapter tells how to change the system settings through the BIOS Setup menus. Detailed descriptions of the BIOS parameters are also provided.

## **BIOS setup**

## Chapter summary

4.1	Managing and updating your BIOS .....	4-1
4.2	BIOS Setup program .....	4-9
4.3	Main menu .....	4-12
4.4	Advanced menu .....	4-15
4.5	Power menu .....	4-30
4.6	Boot menu .....	4-34
4.7	Exit menu .....	4-39

## 4.1 Managing and updating your BIOS

The following utilities allow you to manage and update the motherboard Basic Input/Output System (BIOS) setup.

1. ASUS AFUDOS - Updates the BIOS using a bootable floppy disk in DOS mode.
2. ASUS EZ Flash - Updates the BIOS using a floppy disk during POST.
3. ASUS CrashFree BIOS 2 - Updates the BIOS using a bootable floppy disk or the motherboard support CD.
4. ASUS Update - Updates the BIOS in a Windows® environment.

Refer to the corresponding sections for details on these utilities.

### Important notes



- Save a copy of the original motherboard BIOS file to a bootable floppy disk in case you need to restore the BIOS in the future. Copy the original motherboard BIOS using the AFUDOS utility.
- Visit the ASUS website ([www.asus.com](http://www.asus.com)) and download the latest BIOS file for this motherboard using the ASUS Update utility.

### 4.1.1 Creating a bootable floppy disk

1. Do either one of the following to create a bootable floppy disk.

#### DOS environment

Insert a 1.44 MB floppy disk into the drive. At the DOS prompt, type:

```
format A: /S then press <Enter>.
```

#### Windows® 98SE/ME/XP environment

- a. Insert a 1.44 MB floppy disk into the floppy disk drive.
- b. From your Windows desktop, click on **Start**, then select **My Computer**.
- c. Select the **3 1/2 Floppy Drive** icon.
- d. Click **File** from the menu, then select **Format**. A **Format 3 1/2 Floppy Disk** window appears.
- e. If you are using Windows® XP, select **Create an MS-DOS startup disk** from the format options field, then click **Start**.

OR

If you are using Windows® 98SE/ME, select **Full** option button from the format type, then click **Start**.

2. Copy the original (or the latest) motherboard BIOS to the bootable floppy disk.

## 4.1.2 Using AFUDOS to update the BIOS

To update the BIOS using the AFUDOS.EXE utility:

1. Visit the ASUS website to download the latest BIOS file for your motherboard. Save the BIOS file to a bootable floppy disk.



---

Write the BIOS file name on a piece of paper. You need to type the exact BIOS file name at the prompt.

---

2. Copy the AFUDOS.EXE utility from the support CD to the bootable floppy disk that contains the BIOS file.
3. Boot the system from the floppy disk.
4. At the DOS prompt, type the command line:

```
afudos /i[filename]
```

where **[filename]** means the latest (or original) BIOS file that you copied to the bootable floppy disk.

5. Press <Enter>. The succeeding screen displays the status of the update process.



---

The BIOS information on the screen is for reference only. What you see on your screen may not be exactly the same as shown.

---

```
A:\>afudos /iA8V.ROM
AMI Firmware Update Utility - Version 1.10
Copyright (C) 2002 American Megatrends, Inc. All rights reserved.

Reading file ..... done
Erasing flash .... done
Writing flash .... 0x0008CC00 (9%)
```



---

**DO NOT** shut down or reset the system while updating the BIOS!  
Doing so can cause system boot failure!

---



3. The utility will copy the current system BIOS by default to the floppy disk. Make sure that the floppy disk has at least 600KB of free disk space and is not write-protected.

```
A:\>afudos /oMYBIOS03.rom
AMI Firmware Update Utility - Version 1.10
Copyright (C) 2002 American Megatrends, Inc. All rights reserved.

Reading flash ..... done

A:\>
```

When the copy process is complete, the utility returns to the DOS prompt.

#### 4.1.4 Using ASUS EZ Flash to update the BIOS

The ASUS EZ Flash feature allows you to easily update the BIOS without having to go through the long process of booting from a diskette and using a DOS-based utility. The EZ Flash is built-in to the BIOS firmware so it is accessible by simply pressing <Alt + F2> during the Power-On Self Tests (POST).

##### To update the BIOS using ASUS EZ Flash:

1. Visit the ASUS website ([www.asus.com](http://www.asus.com)) to download the latest BIOS file for your motherboard and rename the downloaded file as **A8V.ROM**. Save the BIOS file to a floppy disk.
2. Reboot the system.
3. To launch EZ Flash, press <Alt+F2> during POST to display the following.

```
User recovery requested. Starting BIOS recovery...
Checking for floppy...
```



- If there is no floppy disk in the drive, the error message “Floppy not found!” appears.
- If the correct BIOS file is not in the floppy disk, the error message “Floppy not found!” is displayed. Make sure to rename the downloaded BIOS file as “A8V.ROM”.

4. Insert the floppy disk that contains the BIOS file. If all the necessary files are found in the floppy disk, EZ Flash performs the BIOS update process and automatically reboots the system when done.



---

DO NOT shut down or reset the system while updating the BIOS!  
Doing so can cause system boot failure!

---

```
User recovery requested. Starting BIOS recovery...
Checking for floppy...
Floppy found!
Reading file "A8V.ROM". Completed.
Start flashing...
Flashed successfully. Rebooting.
```

## 4.1.5 Recovering the BIOS with CrashFree BIOS 2

The CrashFree BIOS 2 auto recovery tool allows you to restore BIOS from the motherboard support CD, or from a floppy disk that contains the BIOS file, in case the current BIOS on the motherboard fails or gets corrupted.



- Prepare the support CD that came with the motherboard or a floppy disk that contains the motherboard BIOS before proceeding with the BIOS update process.
- If you have saved a copy of the original motherboard BIOS to a bootable floppy disk, you can also use this disk to restore the BIOS. See section "4.1.1 Creating a bootable floppy disk."

### To recover the BIOS from a floppy disk:

1. Boot the system.
2. When a corrupted BIOS is detected, the following screen message appears.

```
Bad BIOS checksum. Starting BIOS recovery...
Checking for floppy...
```

3. Insert a floppy disk that contains the original or the latest BIOS file for this motherboard. If all the necessary files are found in the floppy disk, the BIOS update process continues.



---

Make sure that the BIOS file in the floppy disk is renamed as "A8V.ROM".

---

```
Bad BIOS checksum. Starting BIOS recovery...
Checking for floppy...
Floppy found!
Reading file "A8V.ROM". Completed.
Start flashing...
```



---

DO NOT shut down or reset the system while updating the BIOS! Doing so can cause system boot failure!

---

4. When the BIOS update process is complete, reboot the system.

### To recover the BIOS from the support CD:

1. Boot the system.
2. When a corrupted BIOS is detected, the following screen message appears.

```
Bad BIOS checksum. Starting BIOS recovery...
Checking for floppy...
```



---

If there is no floppy disk found in the drive, the system automatically checks the CD-ROM.

---

3. Place the support CD in the CD-ROM. The support CD contains the original BIOS for this motherboard.

```
Bad BIOS checksum. Starting BIOS recovery...
Checking for floppy...
Floppy not found!
Checking for CD-ROM...
CD-ROM found.
Reading file "A8V.ROM". Completed.
Start flashing...
```





---

DO NOT shut down or reset the system while updating the BIOS!  
Doing so might cause system boot failure!

---

4. When the BIOS update process is complete, reboot the system.



---

The recovered BIOS might not be the latest BIOS version for this motherboard. Visit ASUS website ([www.asus.com](http://www.asus.com)) to download the latest BIOS file.

---

## 4.1.6 ASUS Update

The ASUS Update is a utility that allows you to update the motherboard BIOS in Windows® environment. This utility is available in the support CD that comes with the motherboard package. ASUS Update requires an Internet connection either through a network or an Internet Service Provider (ISP).

To install ASUS Update:

1. Insert the support CD into the CD-ROM drive. The **Drivers** menu appears.
2. Click the **Utilities** tab, then click **Install ASUS Update VX.XX.XX**. See page 5-3 for the **Utilities** menu screen.
3. The ASUS Update utility is copied into your system.

To update the BIOS using ASUS Update:

1. Launch the utility from the Windows desktop by clicking **Start > Programs > ASUS > ASUSUpdate > ASUSUpdate**. The ASUS Update initial screen appears.
2. Select your desired update method, then click **Next**.

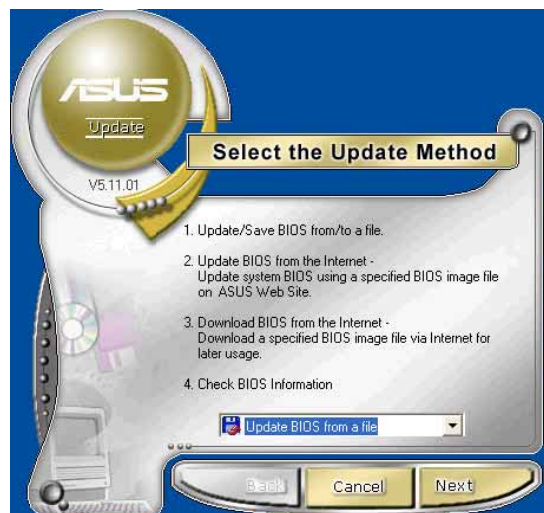

3. If you select updating/ downloading from the Internet, select the ASUS FTP site nearest you to avoid network traffic, or choose **Auto Select**. Click **Next**.

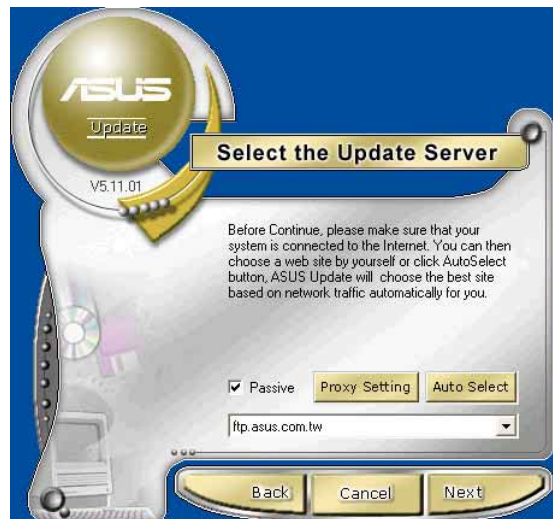

4. From the FTP site, select the BIOS version that you wish to download. Click **Next**.
5. Follow the instructions on the succeeding screens to complete the update process.

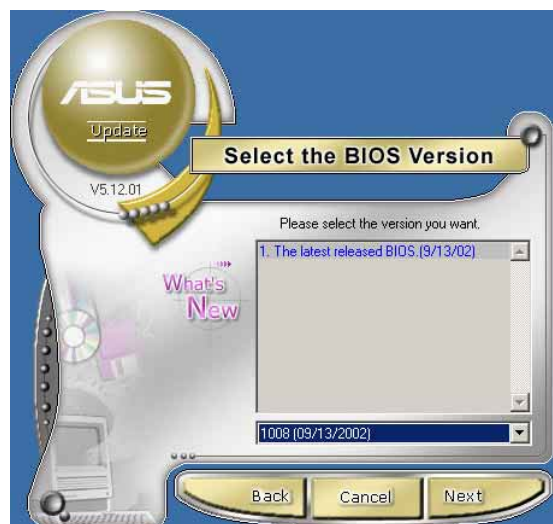

6. If you select the option to update the BIOS from a file, a window prompts you to locate the file. Select the file, click **Save**, then follow the screen instructions to complete the update process.

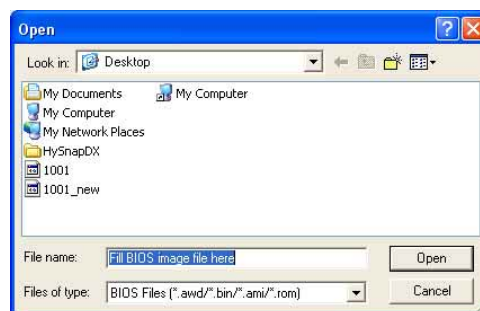

## 4.2 BIOS Setup program

This motherboard supports a programmable firmware chip that you can update using the provided utility described in section “4.1 Managing and updating your BIOS.”

Use the BIOS Setup program when you are installing a motherboard, reconfiguring your system, or prompted to “Run Setup”. This section explains how to configure your system using this utility.

Even if you are not prompted to use the Setup program, you may want to change the configuration of your computer in the future. For example, you may want to enable the security password feature or change the power management settings. This requires you to reconfigure your system using the BIOS Setup program so that the computer can recognize these changes and record them in the CMOS RAM of the firmware hub.

The firmware hub on the motherboard stores the Setup utility. When you start up the computer, the system provides you with the opportunity to run this program. Press <Del> during the Power-On Self Test (POST) to enter the Setup utility. Otherwise, POST continues with its test routines.

If you wish to enter Setup after POST, restart the system by pressing <Ctrl+Alt+Delete>, or by pressing the reset button on the system chassis. You can also restart by turning the system off and then back on. Do this last option only if the first two failed.

The Setup program is designed to make it as easy to use as possible. As a menu-driven program, it lets you scroll through the various sub-menus and make your selections from the available options using the navigation keys.



---

The default BIOS settings for this motherboard apply for most conditions to ensure optimum performance. If the system becomes unstable after changing any BIOS settings, load the default settings to ensure system compatibility and stability. Select the **Load Default Settings** item under the Exit Menu. See section “4.7 Exit Menu.”

---



- The BIOS setup screens shown in this chapter are for reference purposes only, and may not exactly match what you see on your screen.
  - Visit the ASUS website ([www.asus.com](http://www.asus.com)) to download the latest product and BIOS information.
-

## 4.2.1 BIOS menu screen

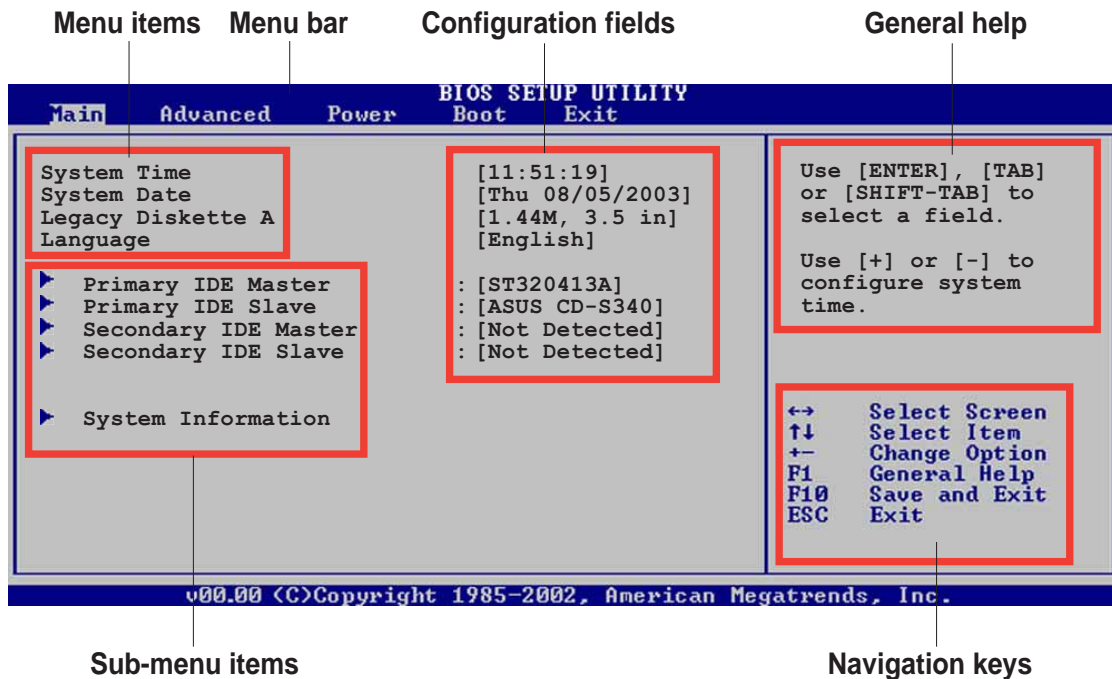

## 4.2.2 Menu bar

The menu bar on top of the screen has the following main items:

- Main** For changing the basic system configuration
- Advanced** For changing the advanced system settings
- Power** For changing the advanced power management (APM) configuration
- Boot** For changing the system boot configuration
- Exit** For selecting the exit options and loading default settings

To select an item on the menu bar, press the right or left arrow key on the keyboard until the desired item is highlighted.

## 4.2.3 Navigation keys

At the **bottom right corner** of a menu screen are the navigation keys for that particular menu. Use the navigation keys to select items in the menu and change the settings.



Some of the navigation keys differ from one screen to another.

## 4.2.4 Menu items

The highlighted item on the menu bar displays the specific items for that menu. For example, selecting **Main** shows the Main menu items.

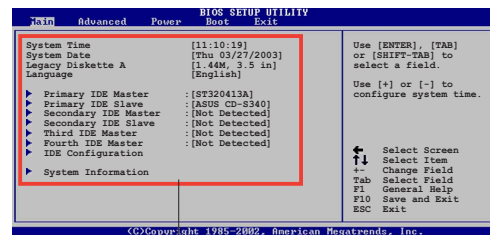

Main menu items

The other items (Advanced, Power, Boot, and Exit) on the menu bar have their respective menu items.

## 4.2.5 Sub-menu items

An item with a sub-menu on any menu screen is distinguished by a solid triangle before the item. To display the sub-menu, select the item and press <Enter>.

## 4.2.6 Configuration fields

These fields show the values for the menu items. If an item is user-configurable, you may change the value of the field opposite the item. You can not select an item that is not user-configurable.

A configurable field is enclosed in brackets, and is highlighted when selected. To change the value of a field, select it then press <Enter> to display a list of options. Refer to “4.2.7 Pop-up window.”

## 4.2.7 Pop-up window

Select a menu item then press <Enter> to display a pop-up window with the configuration options for that item.

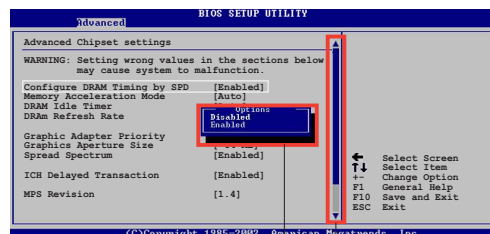

Pop-up window

Scroll bar

## 4.2.8 Scroll bar

A scroll bar appears on the right side of a menu screen when there are items that do not fit on the screen. Press **Up/Down arrow keys** or **PageUp/PageDown keys** to display the other items on the screen.

## 4.2.9 General help

At the top right corner of the menu screen is a brief description of the selected item.

## 4.3 Main menu

When you enter the BIOS Setup program, the Main menu screen appears, giving you an overview of the basic system information.



Refer to section “4.2.1 BIOS menu screen” for information on the menu screen items and how to navigate through them.

```

BIOS SETUP UTILITY
Main  Advanced  Power  Boot  Exit

System Time           [11:51:19]
System Date           [Thu 08/05/2003]
Legacy Diskette A    [1.44M, 3.5 in]
Language              [English]

▶ Primary IDE Master   : [ST320413A]
▶ Primary IDE Slave    : [ASUS CD-S340]
▶ Secondary IDE Master : [Not Detected]
▶ Secondary IDE Slave  : [Not Detected]

▶ System Information

Use [ENTER], [TAB]
or [SHIFT-TAB] to
select a field.

Use [+] or [-] to
configure system
time.

↔ Select Screen
↑↓ Select Item
+- Change Option
F1 General Help
F10 Save and Exit
ESC Exit

v00.00 <C>Copyright 1985-2002, American Megatrends, Inc.
```

### 4.3.1 System Time [xx:xx:xxxx]

Allows you to set the system time.

### 4.3.2 System Date [Day xx/xx/xxxx]

Allows you to set the system date.

### 4.3.3 Legacy Diskette A [1.44M, 3.5 in.]

Sets the type of floppy drive installed.

Configuration options: [Disabled] [360K, 5.25 in.] [1.2M , 5.25 in.] [720K , 3.5 in.] [1.44M, 3.5 in.] [2.88M, 3.5 in.]

### 4.3.4 Language [English]

Allows you to choose the BIOS language version from the available options. Configuration options: [Français] [German] [English]

## 4.3.5 Primary and Secondary IDE Master/Slave

While entering Setup, BIOS auto-detects the presence of IDE devices. There is a separate sub-menu for each IDE device. Select a device item then press <Enter> to display the IDE device information.

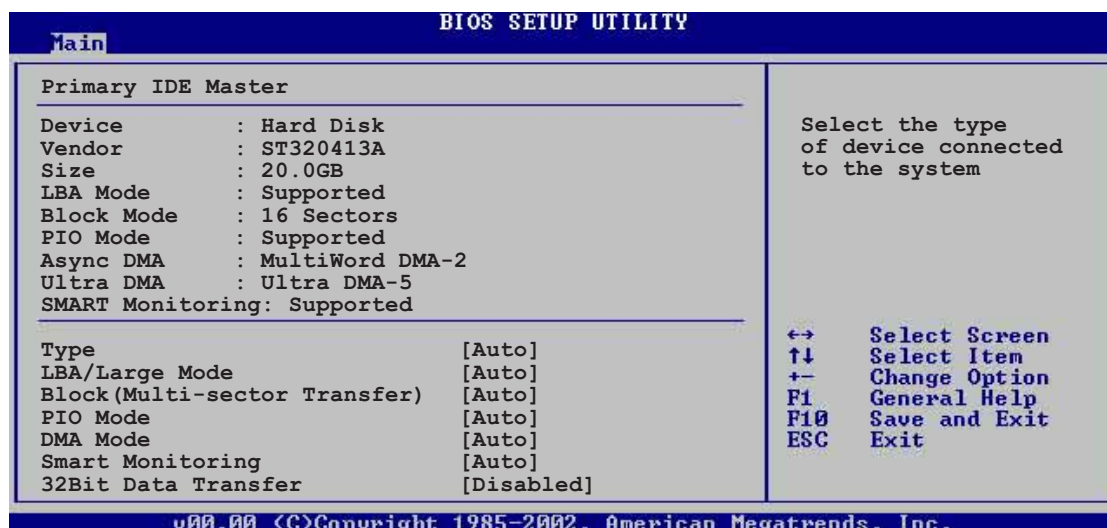

The values opposite the dimmed items (Device, Vendor, Size, LBA Mode, Block Mode, PIO Mode, Async DMA, Ultra DMA, and SMART monitoring) are auto-detected by BIOS and are not user-configurable. These items show N/A if no IDE device is installed in the system.

### Type [Auto]

Selects the type of IDE drive. Setting to Auto allows automatic selection of the appropriate IDE device type. Select CDROM if you are specifically configuring a CD-ROM drive. Select ARMD (ATAPI Removable Media Device) if your device is either a ZIP, LS-120, or MO drive. Configuration options: [Not Installed] [Auto] [CDROM] [ARMD]

### LBA/Large Mode [Auto]

Enables or disables the LBA mode. Setting to Auto enables the LBA mode if the device supports this mode, and if the device was not previously formatted with LBA mode disabled. Configuration options: [Disabled] [Auto]

### Block (Multi-sector Transfer) [Auto]

Enables or disables data multi-sectors transfers. When set to Auto, the data transfer from and to the device occurs multiple sectors at a time if the device supports multi-sector transfer feature. When set to Disabled, the data transfer from and to the device occurs one sector at a time. Configuration options: [Disabled] [Auto]

### PIO Mode [Auto]

Selects the PIO mode. Configuration options: [Auto] [0] [1] [2] [3] [4]

### DMA Mode [Auto]

Selects the DMA mode. Configuration options: [Auto] [SWDMA0] [SWDMA1] [SWDMA2] [MWDMA0] [MWDMA1] [MWDMA2] [UDMA0] [UDMA1] [UDMA2] [UDMA3] [UDMA4] [UDMA5]

### SMART Monitoring [Auto]

Sets the Smart Monitoring, Analysis, and Reporting Technology.  
Configuration options: [Auto] [Disabled] [Enabled]

### 32Bit Data Transfer [Disabled]

Enables or disables 32-bit data transfer.  
Configuration options: [Disabled] [Enabled]

## 4.3.6 System Information

This menu gives you an overview of the general system specifications. The items in this menu are auto-detected by BIOS.

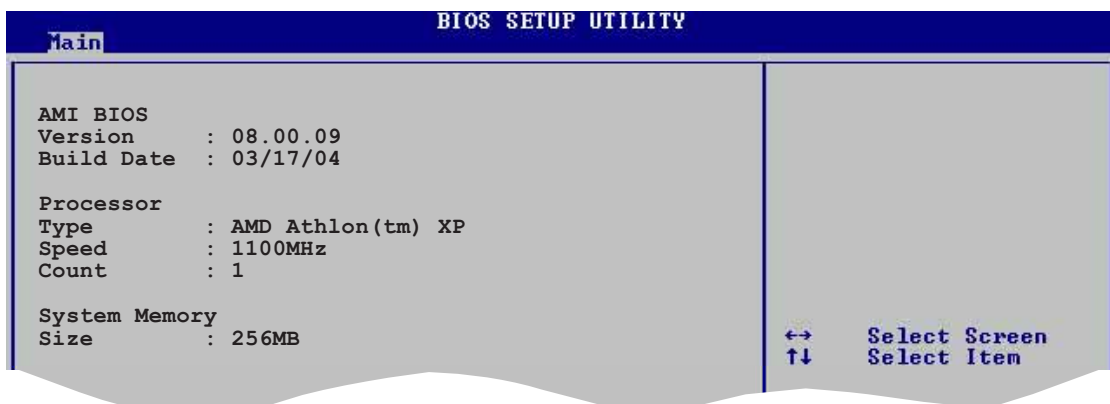

### **AMI BIOS**

Displays the auto-detected BIOS information.

### **Processor**

Displays the auto-detected processor information.

### **System Memory**

Displays the auto-detected system memory.



## 4.4 Advanced menu

The Advanced menu items allow you to change the settings for the CPU and other system devices.



Take caution when changing the settings of the Advanced menu items. Incorrect field values can cause the system to malfunction.

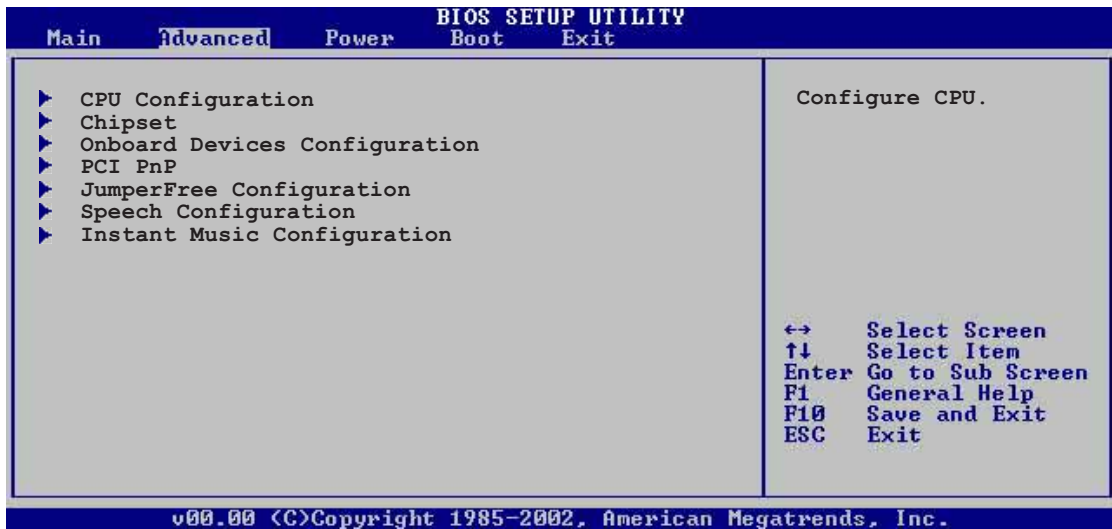

### 4.4.1 CPU Configuration

The items in this menu show the CPU-related information auto-detected by BIOS.

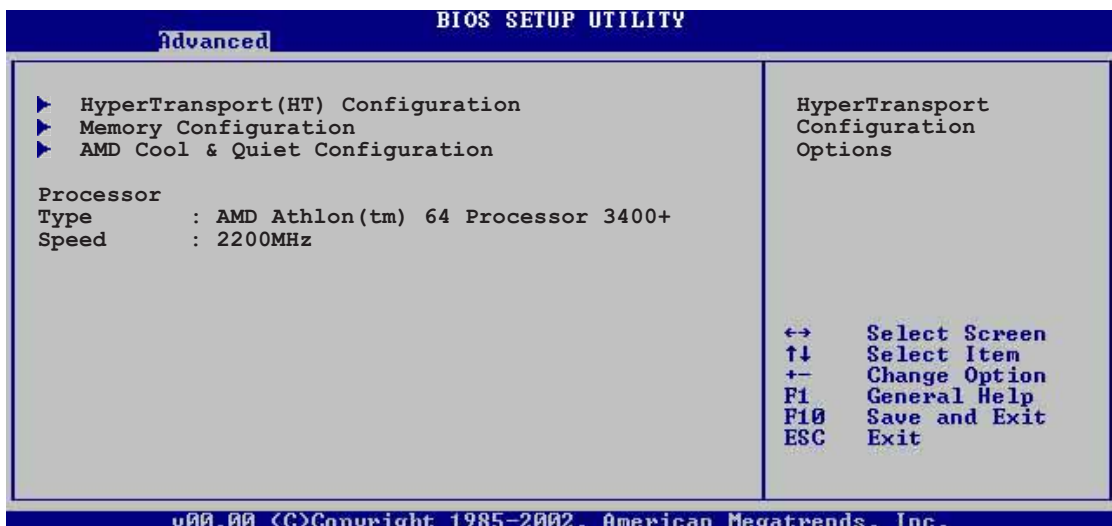

## HyperTransport Configuration

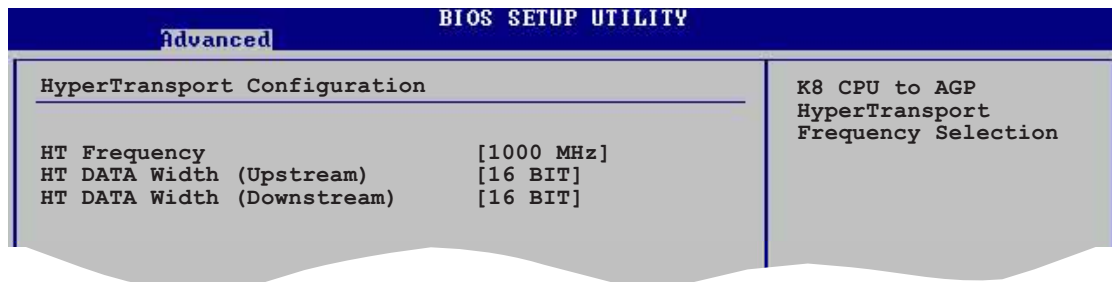

### HT Frequency [1000 MHz]

Allows frequency selection of HyperTransport transfer from K8 CPU to AGP. Configuration options: [200 MHz] [400 MHz] [600 MHz] [800 MHz] [1000 MHz]

### HT DATA Width (Upstream) [16 BIT]

Allows selection of HyperTransport upstream data width. Configuration options: [16 BIT] [8 BIT]

### HT DATA Width (Downstream) [16 BIT]

Allows selection of HyperTransport downstream data width. Configuration options: [16 BIT] [8 BIT]

## Memory Configuration

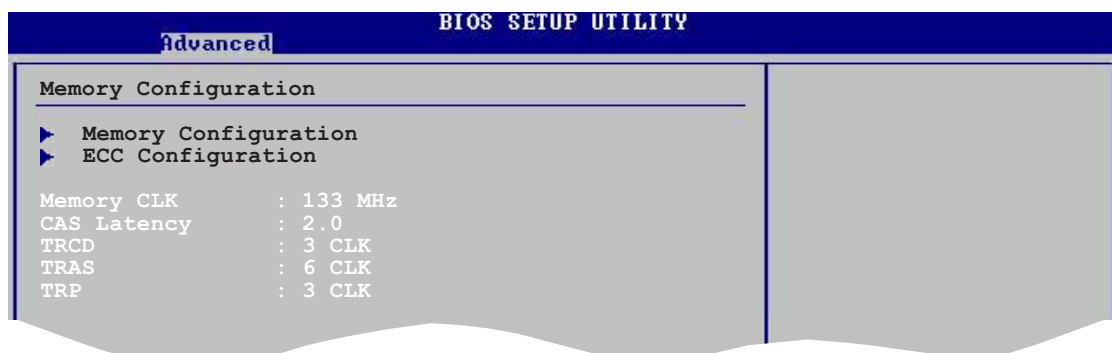

### Memory Configuration

The Memory configuration menu item allows you to change the memory settings. Select an item then press <Enter> to display the sub-menu.

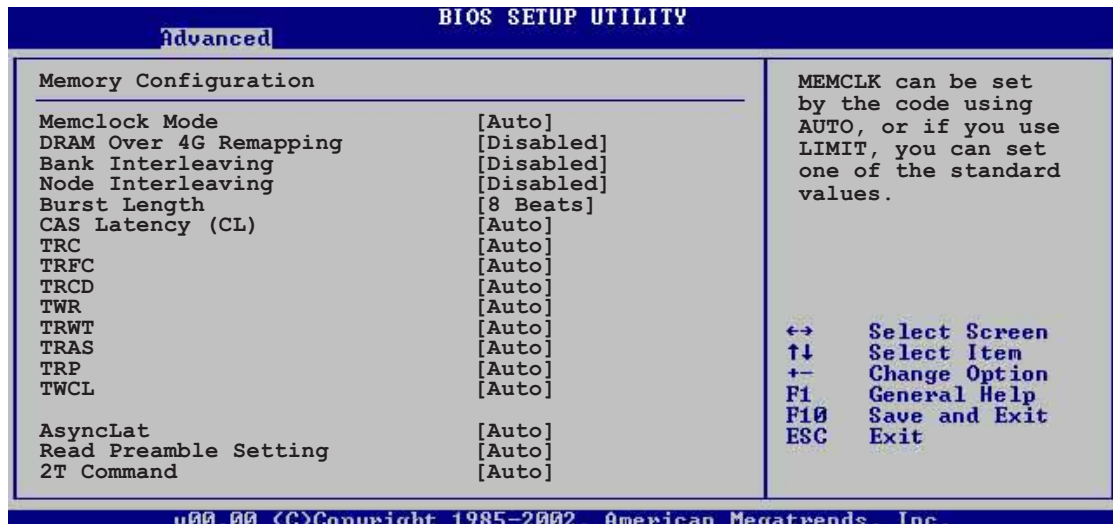

Memclock Mode [Auto]

Allows you to set the memory clock mode. Set by the code using [Auto] or select [Manual] to set using one of the standard values.

Configuration options: [Auto] [Limit]

DRAM Over 4G Remapping [Disabled]

Enable this item when 4 gigabytes or more DRAM is installed to remap the memory block just below 4G and move it above 4G.

Configuration options: [Disabled] [Enabled]

Bank Interleaving [Disabled]

Sets whether to allow memory accesses to be spread out over BANKS on the same node or across nodes, decreasing access contention.

Configuration options: [Auto] [Enabled] [Disabled]

Node Interleaving [Disabled]

Sets whether to allow memory accesses to be spread out over BANKS on the same node or across nodes, decreasing access contention.

Configuration options: [Auto] [Disabled]

Burst Length [8 Beats]

Sets the burst length in beats. Set to 4 Beats when using 64-bit Dq.

Configuration options: [8 Beats] [4 Beats]

CAS Latency (CL) [Auto]

Sets the CAS Latency. Configuration options: [Auto] [2.0] [3.0] [2.5]

TRC [Auto]

Sets the TRC.

Configuration options: [Auto] [7 CLK] [8 CLK] [9 CLK] [10 CLK] [11 CLK] [12 CLK] [13 CLK]

TRFC [Auto]

Sets the TRFC.

Configuration options: [Auto] [9 CLK] [10 CLK] [11 CLK] [12 CLK]  
[13 CLK] [14 CLK] [15 CLK]

TRCD [Auto]

Sets the TRCD.

Configuration options: [Auto] [2 CLK] [3 CLK] [4 CLK] [5 CLK] [6 CLK]

TWR [Auto]

Sets the TWR. Configuration options: [Auto] [2 CLK] [3 CLK]

TRWT [Auto]

Sets the TRWT.

Configuration options: [Auto] [1 CLK] [2 CLK] [3 CLK] [4 CLK] [5 CLK]  
[6 CLK]

TRAS [Auto]

Sets the TRAS.

Configuration options: [Auto] [5 CLK] [6 CLK] [7 CLK] [8 CLK] [9 CLK]  
[10 CLK] [11 CLK] [12 CLK] [13 CLK] [14 CLK] [15 CLK]

TRP [Auto]

Sets the TRP.

Configuration options: [Auto] [2 CLK] [3 CLK] [4 CLK] [5 CLK] [6 CLK]

TWCL [Auto]

Sets the TWCL.

Configuration options: [Auto] [1 CLK] [2 CLK]

Asynclat [Auto]

Sets the Asynclat. Configuration options: [Auto] [4 CLK] [5 CLK]  
[6 CLK] [7 CLK] [8 CLK] [9 CLK]

Read Preamble Setting [Auto]

Sets the Read Preamble in nano seconds.

Configuration options: [Auto] [2.0 ns] [2.5 ns] [3.0 ns] [3.5 ns] [4.0 ns]  
[4.5 ns] [5.0 ns] [5.5 ns] [6.0 ns] [6.5 ns] [7.0 ns] [7.5 ns] [8.0 ns]  
[8.5 ns] [9.0 ns]

2T Command [Auto]

Sets the 2T Command.

Configuration options: [Auto] [Enabled]

## ECC Configuration

Advanced		BIOS SETUP UTILITY
ECC Configuration		Master ECC Enables support on all nodes for ECC error detect and correction.
Master ECC Enable	[Disabled]	

### Master ECC Enable [Disabled]

Enables or disables support on all nodes for ECC error detect and correction. Configuration options: [Disabled] [Enabled]



The following items appear only when the **Master ECC Enable** item is set to [Enabled].

### DRAM ECC Enable [Disabled]

Enables or disables the DRAM ECC that allows hardware to report and correct memory errors automatically to maintain system integrity. Configuration options: [Disabled] [Enabled]



The following items appear only when the **DRAM ECC Enable** item is set to [Enabled].

#### **DRAM BG Scrub [60ns]**

Disables or sets the DRAM scrubbing functionality that corrects and rewrites memory errors so later reads are correct. Doing this while the memory is not being used improves performance. Configuration options: [Disabled] [40ns] [80ns] [160ns] [320ns] [640ns] [1.28us] [2.56us] [5.12us] [10.2us] [20.5us] [41.0us] [81.9us] [163.8us] [327.7us] [655.4us] [1.31ms] [2.62ms] [5.24ms] [10.49ms] [20.97ms] [42.00ms] [84.00ms]

#### **DRAM SCRUB REDIRECT [Disabled]**

Sets the system to correct DRAM ECC errors immediately when they occur, even if background scrubbing is on. Configuration options: [Disabled] [Enabled]

#### **ECC Chip Kill [Disabled]**

Enables or disables the ECC chip kill feature. Configuration options: [Disabled] [Enabled]

### L2 Cache BG Scrub [Disabled]

Disables or sets the L2 data cache RAM to be corrected when idle.  
Configuration options: [Disabled] [40ns] [80ns] [160ns] [320ns] [640ns]  
[1.28us] [2.56us] [5.12us] [10.2us] [20.5us] [41.0us] [81.9us] [163.8us]  
[327.7us] [655.4us] [1.31ms] [2.62ms] [5.24ms] [10.49ms] [20.97ms]  
[42.00ms] [84.00ms]

### Data Cache BG Scrub [Disabled]

Disables or sets the L1 data cache RAM to be corrected when idle.  
Configuration options: [Disabled] [40ns] [80ns] [160ns] [320ns] [640ns]  
[1.28us] [2.56us] [5.12us] [10.2us] [20.5us] [41.0us] [81.9us] [163.8us]  
[327.7us] [655.4us] [1.31ms] [2.62ms] [5.24ms] [10.49ms] [20.97ms]  
[42.00ms] [84.00ms]

## AMD Cool & Quiet Configuration

BIOS SETUP UTILITY	
Advanced	
AMD Cool & Quiet Configuration	Enable/Disable AMD K8 Cool N'Quiet function.
Cool N'Quiet [Disabled]	

### Cool N' Quiet [Disabled]

Allows you to enable or disable the AMD Cool 'n' Quiet!™ Technology feature. Configuration options: [Enabled] [Disabled]



- Make sure that the above item is set to **Enabled** if you want to use the AMD CPU Cool 'n' Quiet!™ Technology feature.
- This feature requires the AMD CPU heatsink and fan assembly with monitor chip. If you purchased a separate heatsink and fan package, use the ASUS Q-Fan Technology feature to automatically adjust the CPU fan speed according to your system loading.

### Processor

Displays the processor type and speed.

## 4.4.2 Chipset

The Chipset menu items allow you to change the advanced chipset settings. Select an item then press <Enter> to display the sub-menu.

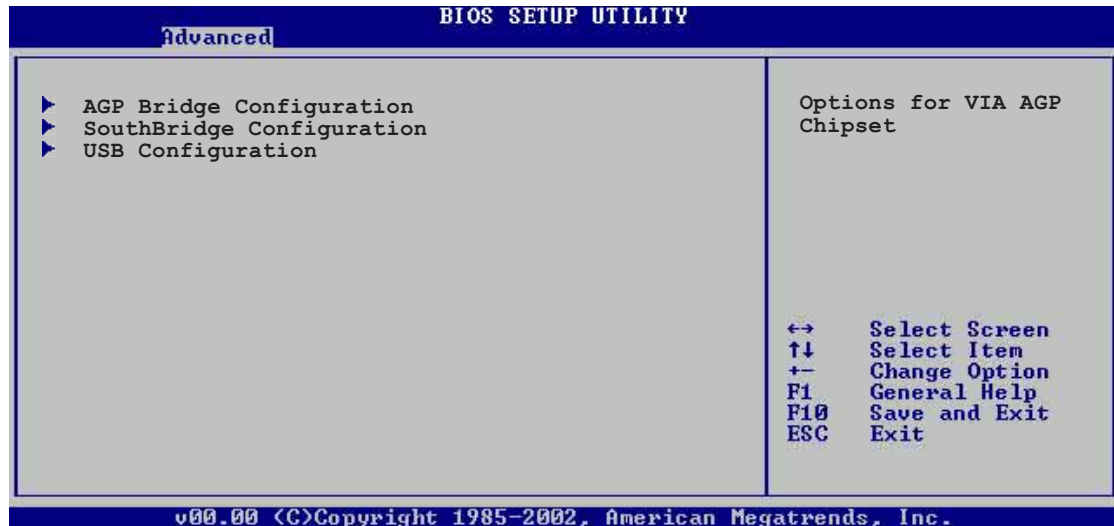

### AGP Bridge Configuration

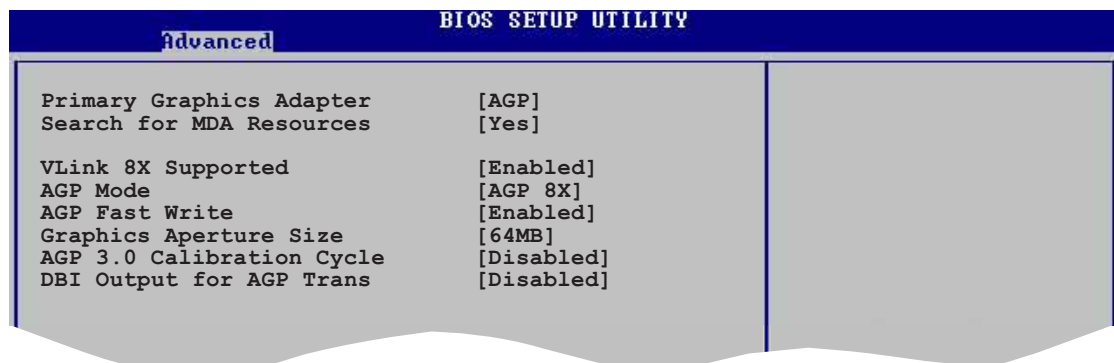

#### Primary Graphics Adapter [AGP]

Switches the PCI Bus scanning order while searching for a video card. This allows you to select the type of Primary VGA in case of multiple video controllers. Configuration options: [PCI] [AGP]

#### Search for MDA Resources [Yes]

Sets whether to allow search for MDA resources. Configuration options: [Yes] [No]

#### VLink 8X Supported [Enabled]

Enables or disables VLink 8X support. Configuration options: [Disabled] [Enabled]

## **AGP Mode [AGP 8X]**

Allows you to set the data throughput of your AGP graphics card. This motherboard supports the AGP 8X interface that transfers video data at 2.12GB/s. The default and configuration options vary depending on the speed of AGP card you installed. If you installed an AGP 8X graphics card, the configuration options are as follows: [8X] [4X] or if you installed an AGP 4X graphics card, the configuration options are as follows: [4X] [2X].

## **AGP Fast Write [Enabled]**

Enables or disables the AGP Fast Write feature.  
Configuration options: [Disabled] [Enabled]

## **Graphics Aperture Size [64MB]**

Allows you to select the size of mapped memory for AGP graphic data.  
Configuration options: [32MB] [64MB] [128MB] [256MB]

## **AGP 3.0 Calibration Cycle [Disabled]**

Enables or disables the AGP 3.0 Calibration cycle.  
Configuration options: [Disabled] [Enabled]

## **DBI Output for AGP Trans [Disabled]**

Enables or disables the DBI Output for AGP trans.  
Configuration options: [Disabled] [Enabled]

## ***SouthBridge Configuration***

The items in this menu allows you to change the Southbridge-related features. Select an item then press <Enter> to display the configuration options.

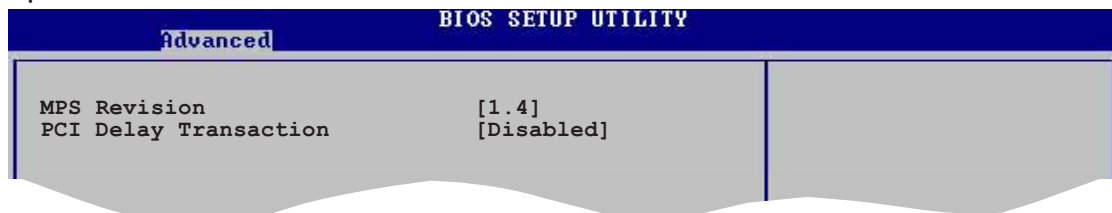

## **MPS Revision [1.4]**

Sets the MPS revision value. Configuration options: [1.1] [1.4]

## **PCI Delay Transaction [Disabled]**

Enables or disables the PCI Delay transaction feature.  
Configuration options: [Disabled] [Enabled]



## USB Configuration

The items in this menu allows you to change the USB-related features. Select an item then press <Enter> to display the configuration options.

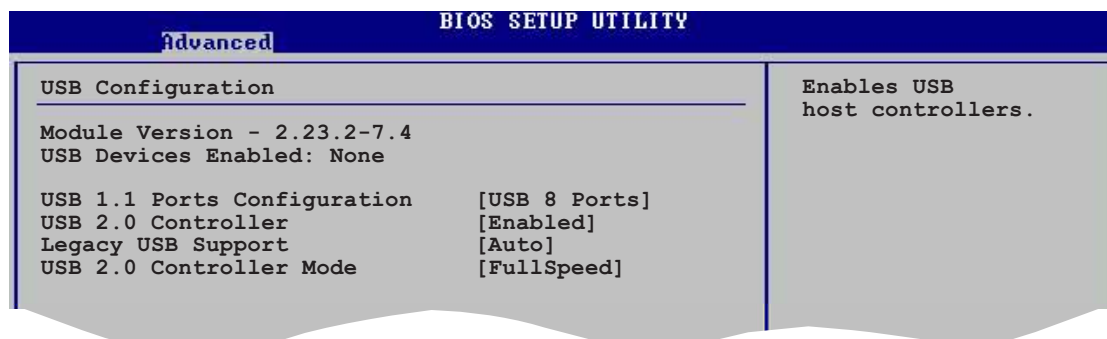

The Module Version and USB Devices Enabled items show the auto-detected values. If no USB device is detected, the item shows None.

### USB 1.1 Ports Configuration [USB 8 Ports]

Allows you to set the number of USB ports to activate.

Configuration options: [Disabled] [USB 2 Ports] [USB 4 Ports] [USB 6 Ports] [USB 8 Ports]

### USB 2.0 Controller [Enabled]

Allows you to enable or disable the USB 2.0 ports controller.

Configuration options: [Disabled] [Enabled]

### Legacy USB Support [Auto]

Allows you to enable or disable support for legacy USB devices. Setting to Auto allows the system to detect the presence of USB devices at startup. If detected, the USB controller legacy mode is enabled. If no USB device is detected, the legacy USB support is disabled.

Configuration options: [Disabled] [Enabled] [Auto]

### USB 2.0 Controller Mode [FullSpeed]

Allows you to configure the USB 2.0 controller in HiSpeed (480 Mbps) or Full Speed (12 Mbps). Configuration options: [HiSpeed] [Full Speed]

## 4.4.3 Onboard Devices Configuration

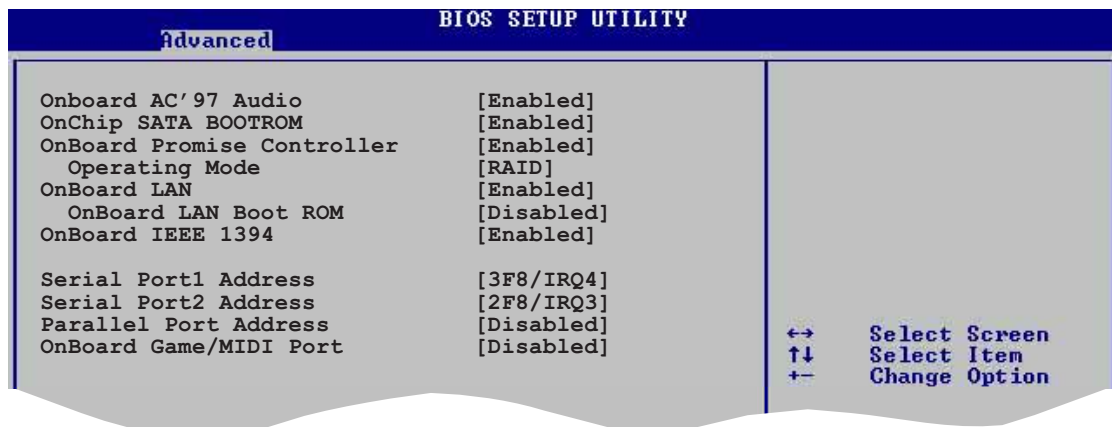

### OnBoard AC'97 Audio [Enabled]

[Auto] allows the BIOS to detect whether you are using any audio device. If an audio device is detected, the onboard audio controller is enabled; if no audio device is detected, the controller is disabled.

Configuration options: [Disabled] [Enabled]

### OnChip SATA Boot ROM [Enabled]

Allows you to enable or disable the onchip Serial ATA boot ROM.

Configuration options: [Disabled] [Enabled]

### OnBoard Promise Controller [Enabled]

Allows you to enable or disable the onboard Promise® RAID controller.

Configuration options: [Disabled] [Enabled]

#### Operating Mode [RAID Mode]

This item sets the onboard Promise controller operating mode. This item appears only when the Onboard Promise Controller item is set to Enabled. Configuration options: [RAID Mode] [IDE Mode]

### OnBoard LAN [Enabled]

Allows you to enable or disable the onboard LAN controller.

Configuration options: [Disabled] [Enabled]

#### OnBoard LAN Boot ROM [Disabled]

Allows you to enable or disable the onboard LAN boot ROM.

Configuration options: [Disabled] [Enabled]

### **OnBoard IEEE 1394 [Enabled]**

Allows you to enable or disable the onboard IEEE1394 controller.

Configuration options: [Disabled] [Enabled]

### **Serial Port1 Address [3F8/IRQ4]**

Allows you to select the Serial Port1 base address.

Configuration options: [Disabled] [3F8/IRQ4] [3E8/IRQ4] [2E8/IRQ3]

### **Serial Port2 Address [2F8/IRQ3]**

Allows you to select the Serial Port2 base address.

Configuration options: [Disabled] [2F8/IRQ3] [3E8/IRQ4] [2E8/IRQ3]

### **Parallel Port Address [378]**

Allows you to select the Parallel Port base addresses.

Configuration options: [Disabled] [378] [278] [3BC]

#### *Parallel Port Mode [Normal]*

Allows you to select the Parallel Port mode.

Configuration options: [Normal] [Bi-directional] [EPP] [ECP]

#### **ECP Mode DMA Channel [DMA3]**

Appears only when the Parallel Port Mode is set to [ECP]. This item allows you to set the Parallel Port ECP DMA.

Configuration options: [DMA0] [DMA1] [DMA3]

#### **EPP Version [1.9]**

Allows selection of the Parallel Port EPP version. This item appears only when the **Parallel Port Mode** is set to **EPP**.

Configuration options: [1.9] [1.7]

#### *Parallel Port IRQ [IRQ7]*

Configuration options: [IRQ5] [IRQ7]

### **Onboard Game/MIDI Port [Disabled]**

Enables or disables the onboard Game/MIDI port.

Configuration options: [Disabled] [Enabled]

## 4.4.4 PCI PnP

The PCI PnP menu items allow you to change the advanced settings for PCI/PnP devices. The menu includes setting IRQ and DMA channel resources for either PCI/PnP or legacy ISA devices, and setting the memory size block for legacy ISA devices.



Take caution when changing the settings of the PCI PnP menu items. Incorrect field values can cause the system to malfunction.

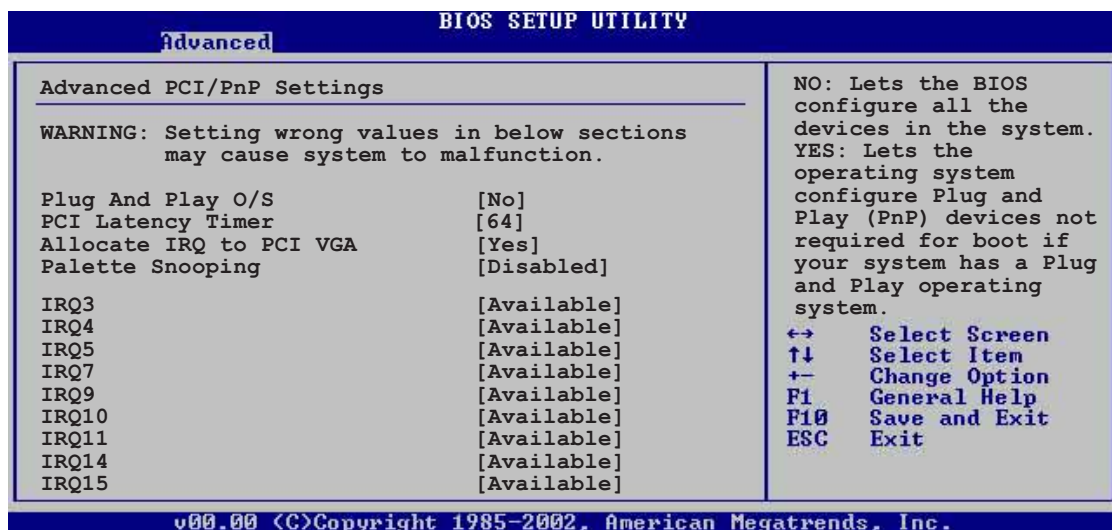

### Plug and Play O/S [No]

When set to [No], BIOS configures all the devices in the system. When set to [Yes] and if you installed a Plug & Play operating system, the operating system configures the Plug & Play devices not required for boot.

Configuration options: [No] [Yes]

### PCI Latency Timer [64]

Allows you to select the value in units of PCI clocks for the PCI device latency timer register. Configuration options: [32] [64] [96] [128] [160] [192] [224] [248]

### Allocate IRQ to PCI VGA [Yes]

When set to [Yes], BIOS assigns an IRQ to PCI VGA card if the card requests for an IRQ. When set to [No], BIOS does not assign an IRQ to the PCI VGA card even if requested. Configuration options: [Yes] [No]

## Palette Snooping [Disabled]

When set to [Enabled], the palette snooping feature informs the PCI devices that an ISA graphics device is installed in the system so that the latter can function correctly. Setting to [Disabled] deactivates this feature.  
Configuration options: [Disabled] [Enabled]

## IRQ xx [Available]

When set to [Available], the specific IRQ is free for PCI/PnP devices to use. When set to [Reserved], the IRQ is reserved for legacy ISA devices.  
Configuration options: [Available] [Reserved]

## 4.4.5 JumperFree Configuration

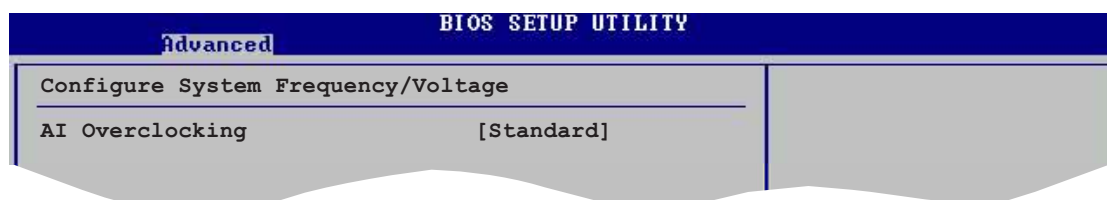

### AI Overclocking [Standard]

Allows selection of CPU overclocking options to achieve desired CPU internal frequency. Select either one of the preset overclocking options and the relevant parameters will appear.

Configuration options: [Auto] [Manual] [Standard] [Overclock 3%]  
[Overclock 5%] [Overclock 7%] [Overclock 10%] [Adaptive Overclocking]



The following items appear only when the **AI Overclocking** field is set to Manual.

### CPU FSB Frequency [200MHz]

Allows you to adjust the CPU FSB operating frequency.

Configuration options: [200MHz] [201 MHz] ~ [300MHz]



Selecting a very high CPU frequency may cause the system to become unstable! If this happens, revert to the default setting.

### CPU Speed/Voltage Setting [Auto]

Allows you to set a specific VCore offset voltage.

Configuration options: [Auto] [Manual]

### **CPU Speed [800 MHz]**

Allows you to manually set the CPU speed. The configuration options vary depending on the speed of the processor installed. This item appears only when the **CPU Speed/Voltage Setting** item is set to Manual.

### **CPU Voltage [1.450 V]**

Allows you to manually set the CPU voltage. The configuration options vary depending on the speed of the processor installed. This item appears only when the **CPU Speed/Voltage Setting** item is set to Manual.



---

Setting a low CPU voltage can cause system boot failure!

---

### **DDR Voltage [Auto]**

Allows you to automatically detect or select from a list the DDR operating voltage. Configuration options: [Auto] [2.6V] [2.7V] [2.8V]

### **AGP Voltage [1.5V]**

Adjusts the AGP voltage setting.  
Configuration options: [1.5V] [1.6V]

### **V-Link Voltage [2.5V]**

Adjusts the V-Link voltage setting. Configuration options: [2.5V] [2.6V]



---

The following item appears only when the **AI Overclocking** field is set to Adaptive Overclocking.

---

### **Adaptive Overclocking [3%]**

Allows you to set the overclocking percentage.  
Configuration options: [3%] [5%] [8%] [17%]



---

Selecting a very high overclocking percentage can cause the system to become unstable! If this happens, press the power button for over 4 seconds to turn OFF the system. Turn the computer back ON and enter the BIOS to revert default settings.

---

## 4.4.6 Speech Configuration

Advanced		BIOS SETUP UTILITY
Speech Option		Disabled/Enable Speech
Speech Post Reporter	[Enabled]	
Report IDE Error	[Disabled]	
Report System Checking	[Disabled]	
Report System Booting	[Disabled]	

### Speech POST Reporter [Enabled]

Allows you to enable or disable the ASUS Speech POST Reporter™ feature. Configuration options: [Disabled] [Enabled]



The following items appear only when Speech POST Reporter™ is set to Enabled.

### Report IDE Error [Disabled]

Enables or disables the Report IDE Error feature. Configuration options: [Disabled] [Enabled]

### Report System Checking [Disabled]

Enables or disables the Report System Checking feature. Configuration options: [Disabled] [Enabled]

### Report System Booting [Disabled]

Enables or disables the Report System Booting feature. Configuration options: [Disabled] [Enabled]

## 4.4.7 Instant Music Configuration

Advanced		BIOS SETUP UTILITY
Instant Music Option		If enabled, power up by PS/2 keyboard function will be disabled.
Instant Music	[Disabled]	

### Instant Music [Disabled]

Allows you to enable or disable the Instant Music feature in BIOS. Configuration options: [Disabled] [Enabled]



Enabling Instant Music automatically disables the PS/2 keyboard power up feature. See page 5-9 for details.

### Instant Music CD-ROM Drive [IDE Secondary Master]

Allows you to select the CD-ROM drive that you wish to use for the Instant Music CD playback. Configuration options: [IDE Primary Master] [IDE Primary Slave] [IDE Secondary Master] [IDE Secondary Slave]



The above item appears only if you enable the Instant Music item.

## 4.5 Power menu

The Power menu items allow you to change the settings for the Advanced Power Management (APM) feature. Select an item then press <Enter> to display the configuration options.

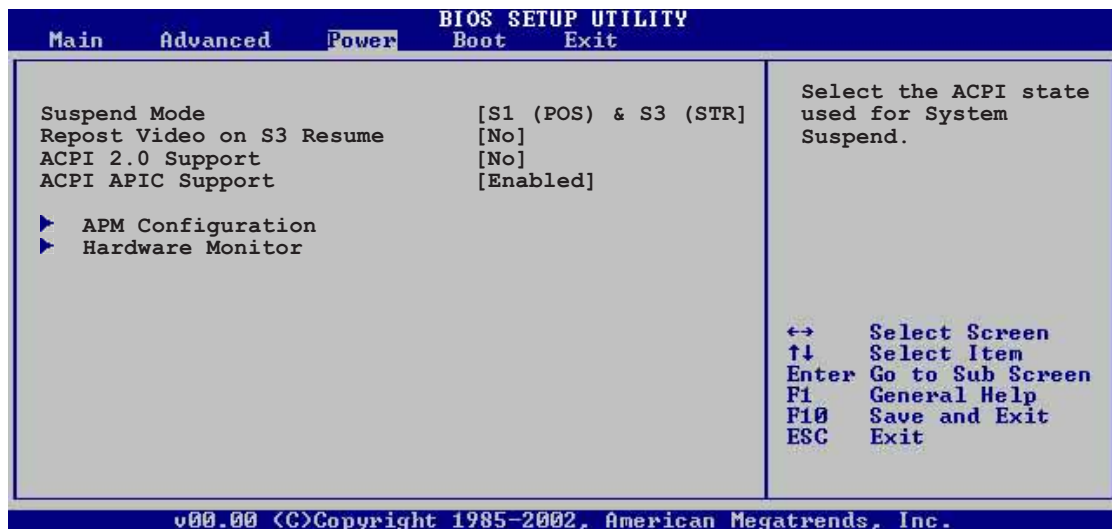

### 4.5.1 Suspend Mode [S1 (POS) & S3 (STR)]

Allows you to select the ACPI state to be used for system suspend. Configuration options: [S1 (POS) Only] [S3 Only] [S1 (POS) & S3 (STR) Auto]

### 4.5.2 Repost Video on S3 Resume [No]

Determines whether to invoke VGA BIOS POST on S3/STR resume. Configuration options: [No] [Yes]



### 4.5.3 ACPI 2.0 Support [No]

Allows you to add more tables for ACPI 2.0 specifications.  
Configuration options: [No] [Yes]

### 4.5.4 ACPI APIC Support [Enabled]

Enables or disables the ACPI support in the ASIC. When set to Enabled, the ACPI APIC table pointer is included in the RSDT pointer list.  
Configuration options: [Disabled] [Enabled]

### 4.5.5 APM Configuration

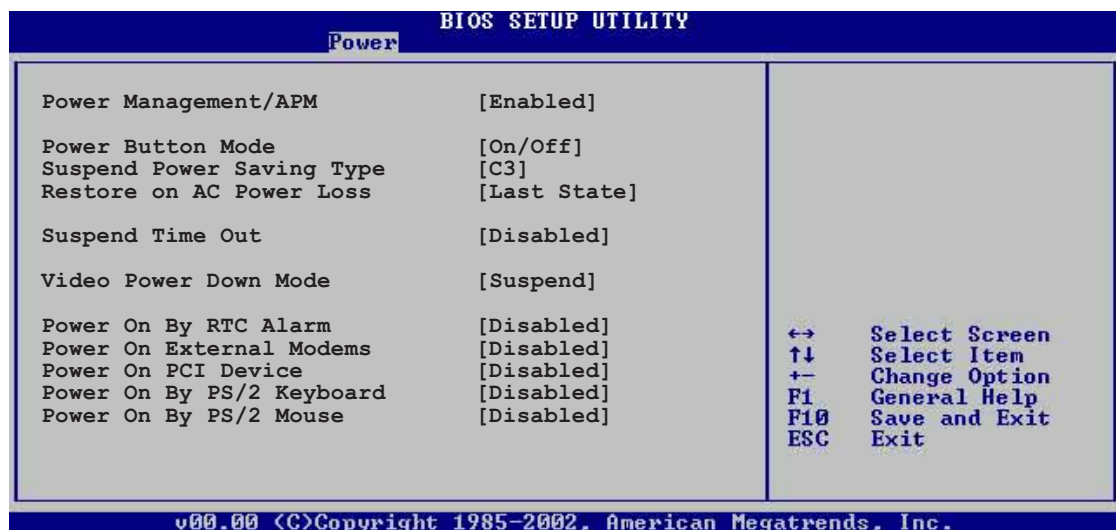

#### Power Management/APM [Enabled]

Allows you to enable or disable the Advanced Power Management (APM) feature. Configuration options: [Disabled] [Enabled]



The following items appear only when the Power Management/APM item is set to [Enabled].

#### Power Button Mode [On/Off]

Allows the system to go into On/Off mode or suspend mode when the power button is pressed. Configuration options: [On/Off] [Suspend]

#### Suspend Power Saving Type [C3]

Sets the Suspend Power Saving Type. Configuration options: [C3] [S1]

### **Restore on AC Power Loss [Last State]**

When set to Power Off, the system goes into off state after an AC power loss. When set to Power On, the system goes on after an AC power loss. When set to Last State, the system goes into either off or on state whatever the system state before the AC power loss.

Configuration options: [Power Off] [Power On] [Last State]

### **Suspend Time Out [Disabled]**

Allows you to select the specified time at which the system goes on suspend mode. Configuration options: [Disabled] [1 Min] [2 Min] [4 Min] [8 Min] [10 Min] [20 Min] [30 Min] [40 Min] [50 Min] [60 Min]

### **Video Power Down Mode [Suspend]**

Allows you to select the video power down mode.

Configuration options: [Disabled] [Suspend]

### **Power On By RTC Alarm [Disabled]**

Allows you to enable or disable RTC to generate a wake event. When this item is set to Enabled, the items RTC Alarm Date, RTC Alarm Hour, RTC Alarm Minute, and RTC Alarm Second appear with set values. This feature requires an ATX power supply that provides at least 1A on the +5VSB lead. Configuration options: [Disabled] [Enabled]

### **Power On External Modems [Disabled]**

Allows either settings of [Enabled] or [Disabled] for powering up the computer when the external modem receives a call while the computer is in Soft-off mode. Configuration options: [Disabled] [Enabled]



---

The computer cannot receive or transmit data until the computer and applications are fully running. Thus, connection cannot be made on the first try. Turning an external modem off and then back on while the computer is off causes an initialization string that turns the system power on.

---

### **Power On PCI Device [Disabled]**

Allows you to enable or disable the PME# to generate a wake event. This feature requires an ATX power supply that provides at least 1A on the +5VSB lead. Configuration options: [Disabled] [Enabled]

## Power On By PS/2 Keyboard [Disabled]

Allows you to enable or disable the keyboard wake-up feature. This feature requires an ATX power supply that provides at least 1A on the +5VSB lead. Configuration options: [Disabled] [Enabled]

## Power On By PS/2 Mouse [Disabled]

When set to [Enabled], this parameter allows you to use the PS/2 mouse to resume the system. This feature requires an ATX power supply that provides at least 1A on the +5VSB lead.

Configuration options: [Disabled] [Enabled]

## 4.5.6 Hardware Monitor

BIOS SETUP UTILITY	
Power	
Hardware Monitor	
CPU Temperature	[48°C/118°F]
MB Temperature	[35°C/95°F]
Power Temperature	[57°C/134.5°F]
CPU Fan Speed	[3260RPM]
Chassis Fan Speed	[N/A]
Power Fan Speed	[N/A]
Chassis Q-Fan Control	[Disabled]
CPU Q-Fan Control	[Disabled]
VCORE Voltage	[ 1.504V]
3.3V Voltage	[ 3.360V]
5V Voltage	[ 5.160V]
12V Voltage	[11.328V]
CPU Temperature	
↔	Select Screen
↑↓	Select Item
+−	Change Option
F1	General Help
F10	Save and Exit
ESC	Exit

### CPU Temperature [xxx °C/xxx °F]

### MB Temperature [xxx °C/xxx °F]

### Power Temperature [xxx °C/xxx °F]

The onboard hardware monitor automatically detects and displays the CPU, motherboard and power temperatures. Select Disabled if you do not wish to display the detected temperatures.

### CPU Fan Speed [xxxxRPM] or [N/A]

### Chassis Fan Speed [xxxxRPM] or [N/A]

### Power Fan Speed [xxxxRPM] or [N/A]

The onboard hardware monitor automatically detects and displays the CPU, chassis, and power fan speeds in rotations per minute (RPM). If any of the fans is not connected to the motherboard, the specific field shows N/A.

## Chassis Q-Fan Control [Disabled]

Allows you to enable or disable the Chassis fan control function. When this field is set to [Enabled], the item **Chassis Fan Ratio** appears.

Configuration options: [Disabled] [Enabled]

### Chassis Fan Ratio [11/16]

Allows you to select the fan speed ratio. This item appears only if the **Chassis Q-Fan Control** item is Enabled.

Configuration options: [11/16] [12/16] [13/16] [14/16] [15/16]

## CPU Q-Fan Control [Disabled]

Allows you to enable or disable the Chassis fan control function. When this field is set to [Enabled], the item **CPU Fan Ratio** appears.

Configuration options: [Disabled] [Enabled]

### CPU Fan Ratio [11/16]

Allows you to select the fan speed ratio. This item appears only if the **CPU Q-Fan Control** item is Enabled.

Configuration options: [11/16] [12/16] [13/16] [14/16] [15/16]

## VCORE Voltage, +3.3V Voltage, +5V Voltage, +12V Voltage

The onboard hardware monitor automatically detects the voltage output through the onboard voltage regulators.

## 4.6 Boot menu

The Boot menu items allow you to change the system boot options. Select an item then press <Enter> to display the sub-menu.

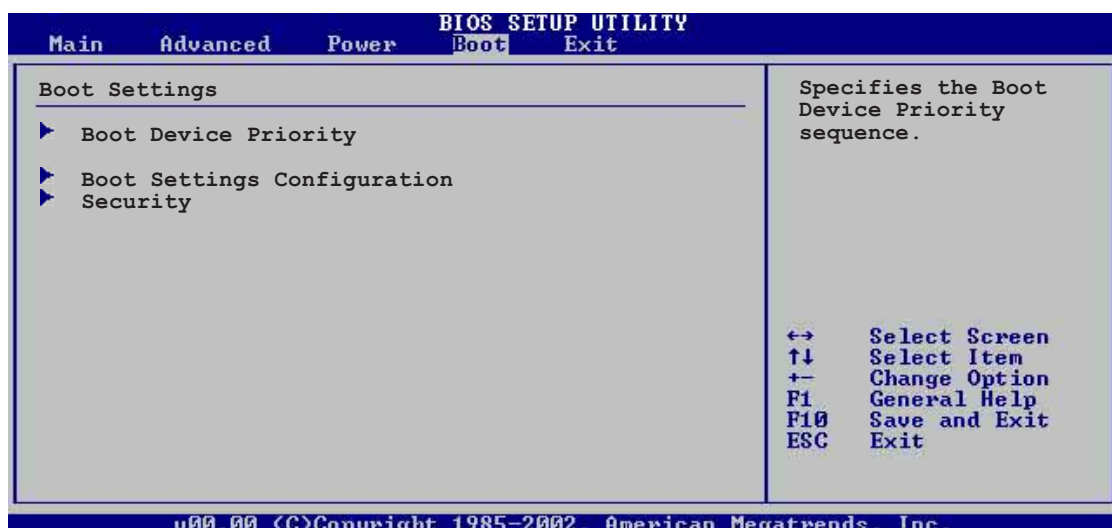

## 4.6.1 Boot Device Priority

BIOS SETUP UTILITY	
Boot	
<b>Boot Device Priority</b>	
1st Boot Device	[1st FLOPPY DRIVE]
2nd Boot Device	[PM-ST320413A]
3rd Boot Device	[SM-ASUS CD-S360]

Specifies the boot sequence from the available devices.

A device enclosed in parenthesis has been disabled in the corresponding type menu.

### 1st ~ xxth Boot Device [1st Floppy Drive]

These items specify the boot device priority sequence from the available devices. The number of device items that appear on the screen depends on the the number of devices installed in the system.

Configuration options: [xxxxx Drive] [Disabled]

## 4.6.2 Boot Settings Configuration

BIOS SETUP UTILITY	
Boot	
<b>Boot Settings Configuration</b>	
Quick Boot	[Enabled]
Full Screen Logo	[Enabled]
AddOn ROM Display Mode	[Force BIOS]
Bootup Num-Lock	[On]
PS/2 Mouse Support	[Auto]
Wait for 'F1' If Error	[Enabled]
Hit 'DEL' Message Display	[Enabled]
Interrupt 19 Capture	[Disabled]

Allows BIOS to skip certain tests while booting. This will decrease the time needed to boot the system.

↔ Select Screen

### Quick Boot [Enabled]

Enabling this item allows the BIOS to skip some Power On Self Tests (POST) while booting to decrease the time needed to boot the system. When set to [Disabled], BIOS performs all the POST items.

Configuration options: [Disabled] [Enabled]

### Full Screen Logo [Enabled]

Allows you to enable or disable the full screen logo display feature.

Configuration options: [Disabled] [Enabled]



Make sure that the above item is set to [Enabled] if you want to use the ASUS MyLogo2™ feature.

## Add On ROM Display Mode [Force BIOS]

Sets the display mode for option ROM.

Configuration options: [Force BIOS] [Keep Current]

## Bootup Num-Lock [On]

Allows you to select the power-on state for the NumLock.

Configuration options: [Off] [On]

## PS/2 Mouse Support [Auto]

Allows you to enable or disable support for PS/2 mouse.

Configuration options: [Disabled] [Enabled] [Auto]

## Wait for 'F1' If Error [Enabled]

When set to Enabled, the system waits for F1 key to be pressed when error occurs. Configuration options: [Disabled] [Enabled]

## Hit 'DEL' Message Display [Enabled]

When set to Enabled, the system displays the message "Press DEL to run Setup" during POST. Configuration options: [Disabled] [Enabled]

## Interrupt 19 Capture [Disabled]

When set to [Enabled], this function allows the option ROMs to trap Interrupt 19. Configuration options: [Disabled] [Enabled]

## 4.6.3 Security

The Security menu items allow you to change the system security settings. Select an item then press <Enter> to display the configuration options.

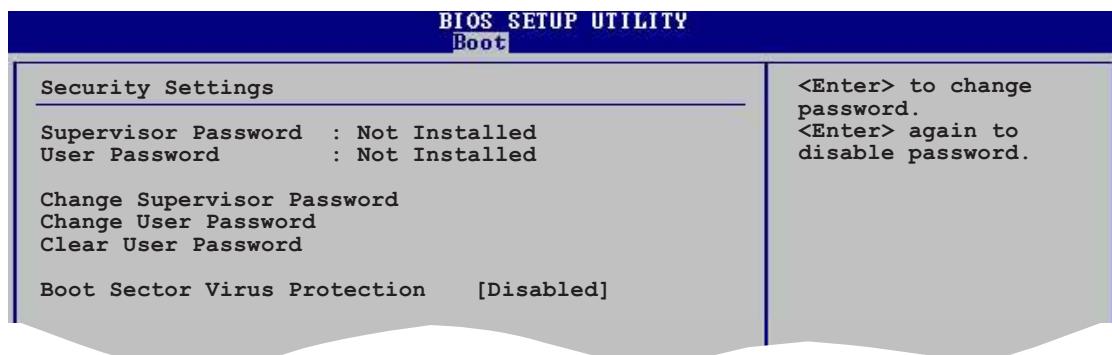

### Change Supervisor Password

Select this item to set or change the supervisor password. The Supervisor Password item on top of the screen shows the default **Not Installed**. After you have set a password, this item shows **Installed**.

To set a Supervisor Password:

1. Select the Change Supervisor Password item and press **<Enter>**.
2. From the password box, type a password combination of at least six (6) letters and/or numbers, then press **<Enter>**.
3. Confirm the password when prompted.  
The message "Password Installed" appears after you have successfully set your password.  
The Supervisor Password item now shows **Installed**.

To change the supervisor password, follow the same steps as in setting a user password.

To clear the supervisor password, select the Change Supervisor Password then press **<Enter>**. The message "Password Uninstalled" appears.



If you forget your BIOS password, you can clear it by erasing the CMOS Real Time Clock (RTC) RAM. See section "2.6 Jumpers" for information on how to erase the RTC RAM.

After you have set a supervisor password, the other items appear to allow you to change other security settings.

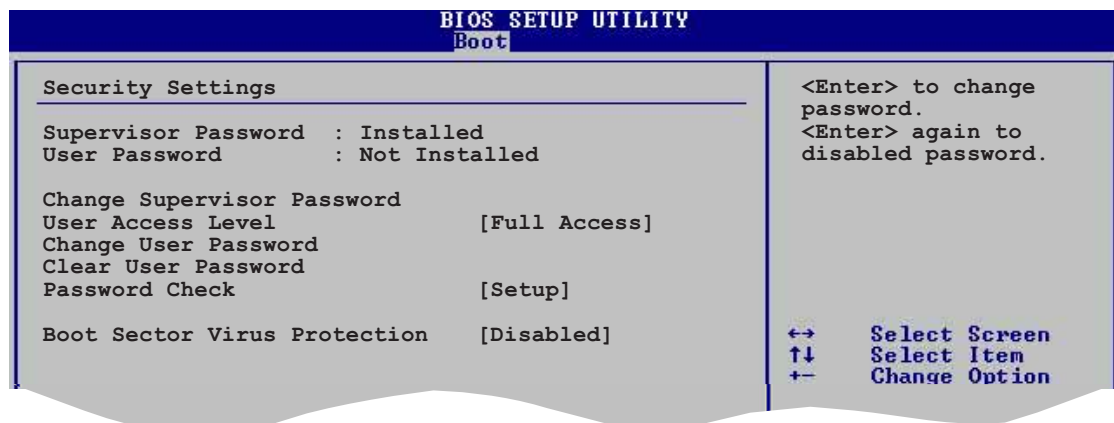

### User Access Level (Full Access)

Allows you to select the access restriction to the Setup items.

Configuration options: [No Access] [View Only] [Limited] [Full Access]

**No Access** prevents user access to the Setup utility.

**View Only** allows access but does not allow change to any field.

**Limited** allows change only to selected fields, such as Date and Time.

**Full Access** allows viewing and changing all the fields in the Setup utility.

## Change User Password

Select this item to set or change the user password. The User Password item on top of the screen shows the default **Not Installed**. After you have set a password, this item shows **Installed**.

To set a User Password:

1. Select the Change User Password item and press <Enter>.
2. On the password box that appears, type a password combination of at least six (6) letters and/or numbers, then press <Enter>.
3. Confirm the password when prompted.  
The message "Password Installed" appears after you have successfully set your password.  
The User Password item now shows **Installed**.

To change the user password, follow the same steps as in setting a user password.

## Clear User Password

Select this item to clear the user password.

## Password Check [Setup]

When set to [Setup], BIOS checks for user password when accessing the Setup utility. When set to [Always], BIOS checks for user password both when accessing Setup and booting the system.

Configuration options: [Setup] [Always]

## Boot Sector Virus Protection [Disabled]

Allows you to enable or disable the boot sector virus protection.

Configuration options: [Disabled] [Enabled]



## 4.7 Exit menu

The Exit menu items allow you to load the optimal or failsafe default values for the BIOS items, and save or discard your changes to the BIOS items.

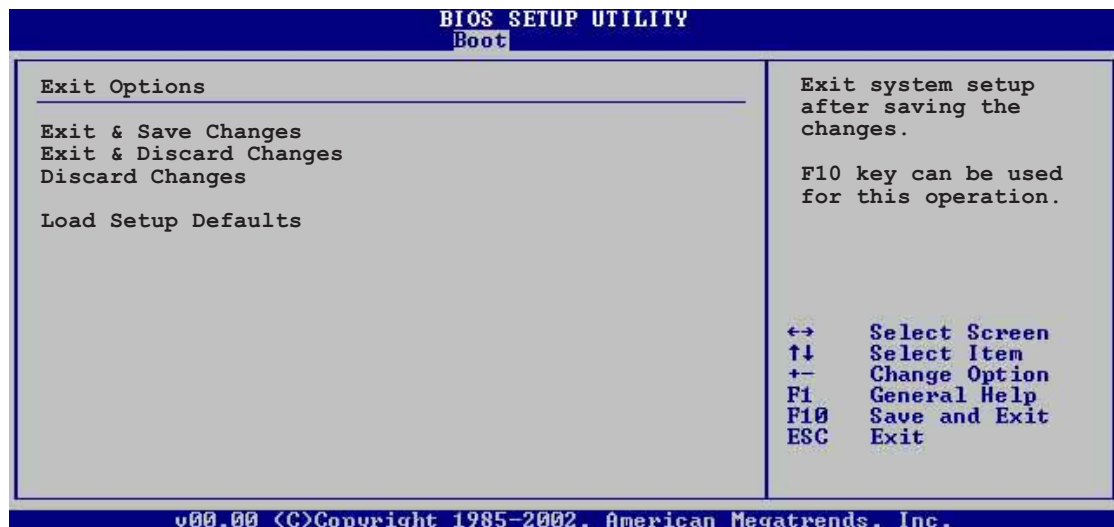

Pressing <Esc> does not immediately exit this menu. Select one of the options from this menu or <F10> from the legend bar to exit.

### Exit & Save Changes

Once you are finished making your selections, choose this option from the Exit menu to ensure that the values you selected are saved to the CMOS RAM. An onboard backup battery sustains the CMOS RAM and stays on even when the PC is turned off. When you select this option, a confirmation window appears. Select **Yes** to save changes and exit.



If you attempt to exit the Setup program without saving your changes, the program prompts you with a message asking if you want to save your changes before exiting. Press <Enter> to save the changes while exiting.

### Exit & Discard Changes

Select this option only if you do not want to save the changes that you made to the Setup program. If you made changes to fields other than System Date, System Time, and Password, the BIOS asks for a confirmation before exiting.

## **Discard Changes**

Allows you to discard the selections you made and restore the previously saved values. After selecting this option, a confirmation appears. Select **Yes** to discard any changes and load the previously saved values.

## **Load Setup Defaults**

This option allows you to load the default values for each of the parameters on the Setup menus. When you select this option or if you press <F5>, a confirmation window appears. Select **Yes** to load default values. Select **Exit Saving Changes** or make other changes before saving the values to the non-volatile RAM.

# ***Chapter 5***

This chapter describes the contents of the support CD that comes with the motherboard package.

## **Software support**

## Chapter summary

5.1	Installing an operating system .....	5-1
5.2	Support CD information .....	5-1
5.3	Software Information .....	5-7
5.4	AI Net feature .....	5-11
5.5	Audio configurations .....	5-12
5.6	RAID configurations .....	5-18
5.7	Creating a RAID driver disk .....	5-33
5.8	Cool 'n' Quiet!™ Technology .....	5-34

## 5.1 Installing an operating system

This motherboard supports Windows® 98SE/ME/2000/XP/2003 Server operating systems (OS). Always install the latest OS version and corresponding updates to maximize the features of your hardware.



Motherboard settings and hardware options vary, so use the setup procedures presented in this chapter for general reference only. Refer to your OS documentation for more information.

## 5.2 Support CD information

The support CD that came with the motherboard contains useful software and several utility drivers that enhance the motherboard features.



The contents of the support CD are subject to change at any time without notice. Visit the ASUS website for updates.

### 5.2.1 Running the support CD

To begin using the support CD, simply insert the CD into your CD-ROM drive. The CD automatically displays the **Drivers** menu if Autorun is enabled in your computer.

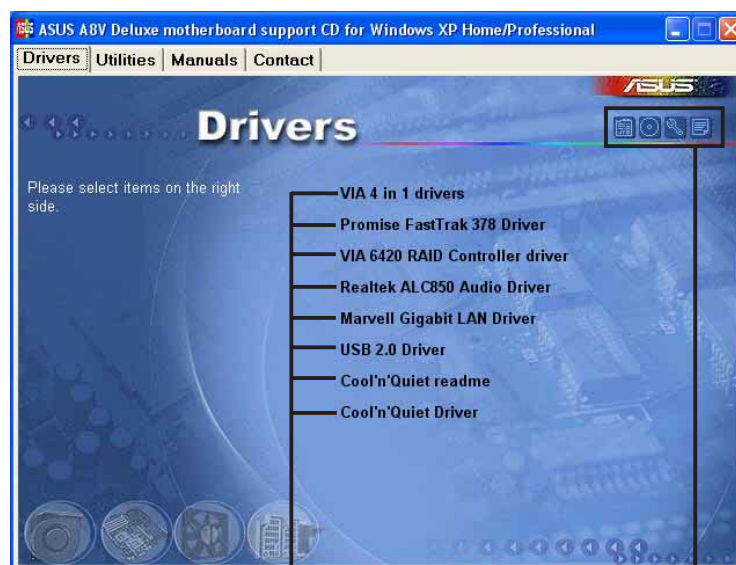

Click an item to install

Click an icon to display more information



If **Autorun** is NOT enabled in your computer, browse the contents of the support CD to locate the file **ASSETUP.EXE** from the **BIN** folder. Double-click the **ASSETUP.EXE** to run the CD.

## 5.2.2 Drivers menu

The drivers menu shows the available device drivers if the system detects installed devices. Install the necessary drivers to activate the devices.



### VIA 4 in 1 drivers

This item installs the following drivers:

- VIA Registry (INF) driver
- VIA AGP VxD driver
- VIA ATAPI vendor support driver
- VIA PCI IRQ Miniport driver.

### Promise FastTrak 378 Driver

Installs the Promise FastTrak 378 driver for Serial ATA and RAID features.

### VIA 6420 RAID Controller driver

Installs the VIA 6420 RAID controller driver and application.

### Realtek ALC850 Audio Driver

Installs the Realtek® ALC850 audio controller and application.

### Marvell Gigabit LAN Driver

Installs the Marvell® 88E8001 Gigabit LAN drivers for Gigabit LAN solution that provides up to 1000Mbps data transfer rates.

### USB 2.0 Driver

Installs the USB 2.0 driver.

### Cool 'n' Quiet readme

Launches the AMD Cool 'n' Quiet!™ Technology readme file.

## Cool 'n' Quiet Driver

Installs the AMD Cool 'n' Quiet!™ Technology driver.



---

The screen display and drivers option may not be the same for different operating system versions.

---

## 5.2.3 Utilities menu

The Utilities menu shows the applications and other software that the motherboard supports.

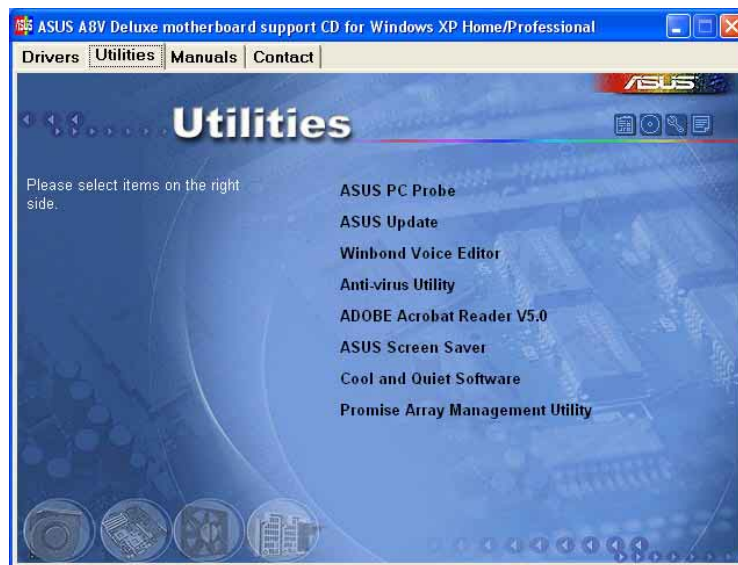

### ASUS PC Probe

This smart utility monitors the fan speed, CPU temperature, and system voltages, and alerts you of any detected problems. This utility helps you keep your computer in healthy operating condition.

### ASUS Update

Allows you to download the latest version of the BIOS from the ASUS website.



---

Before using the ASUS Update, make sure that you have an Internet connection so you can connect to the ASUS website.

---

### Winbond Voice Editor

This program is for recording and customizing wave files for the ASUS POST Reporter™. Use this program to change the default vocal POST messages. See section “3.2 Vocal POST Messages” for a list of the default messages.

## Anti-virus Utility

The anti-virus application scans, identifies, and removes computer viruses. View the online help for detailed information.

## ADOBE Acrobat Reader

Installs the Adobe Acrobat® Reader V5.0.

## ASUS Screen Saver

Installs the ASUS screen saver.

## Cool 'n' Quiet Software

Installs the Cool 'n' Quiet! Technology software.

## Promise Array Management Utility

Installs the Promise Array Management Utility. Use this utility to configure a disk array for RAID installations.

## 5.2.4 Manuals menu

The Manuals menu contains a list of supplementary user manuals. Click an item to open the manual.

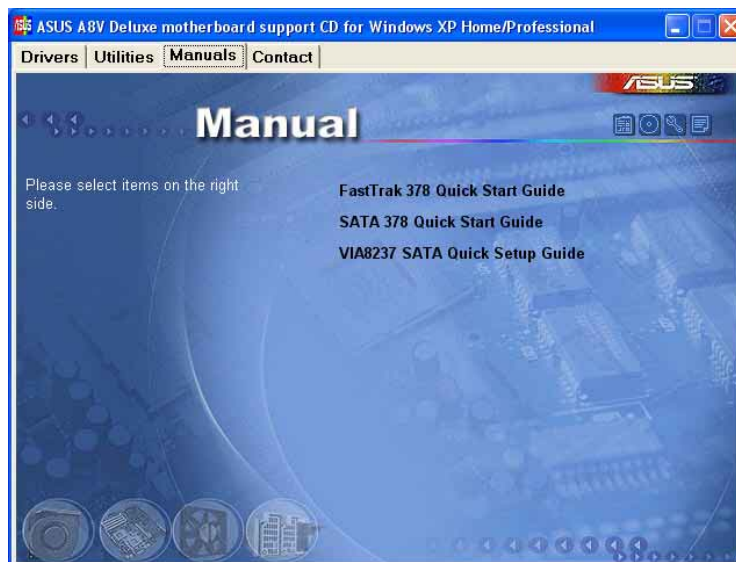

---

Install the Adobe® Acrobat® Reader from the Utilities menu to open the manual files in PDF.

---



## 5.2.5 ASUS Contact information

Clicking the ASUS Contact Information tab displays as stated. You can also find this information on the inside front cover of this user guide.



## 5.2.6 Other information

The icons on the top right corner of the screen give additional information on the motherboard and the contents of the support CD. Click an icon to display the specified information.

### Motherboard Info

Displays the general specifications of the motherboard.

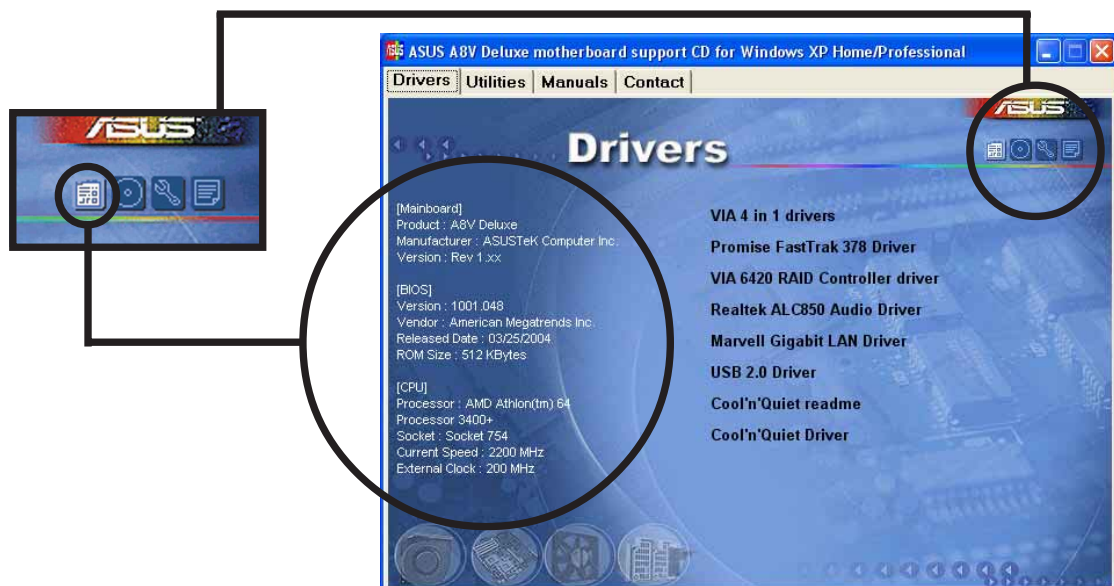

## Browse this CD

Displays the support CD contents in graphical format.

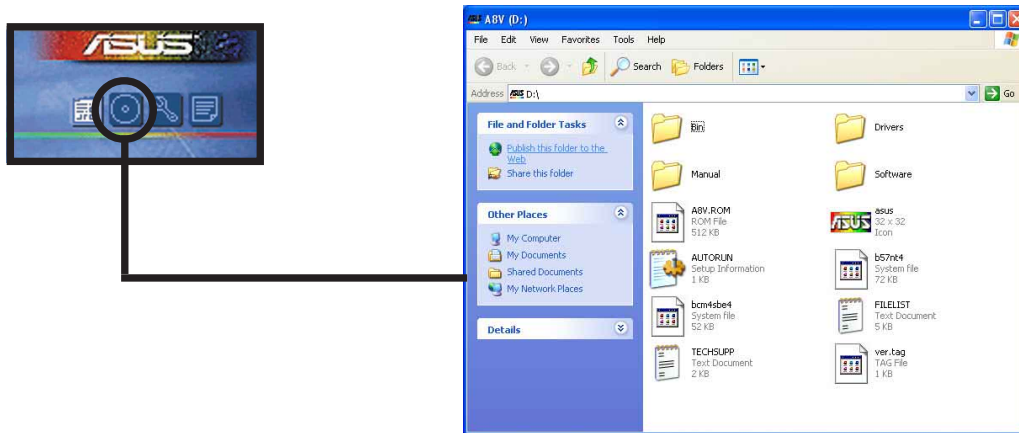

## Technical Support Form

Displays the ASUS Technical Support Request Form that you have to fill out when requesting technical support.

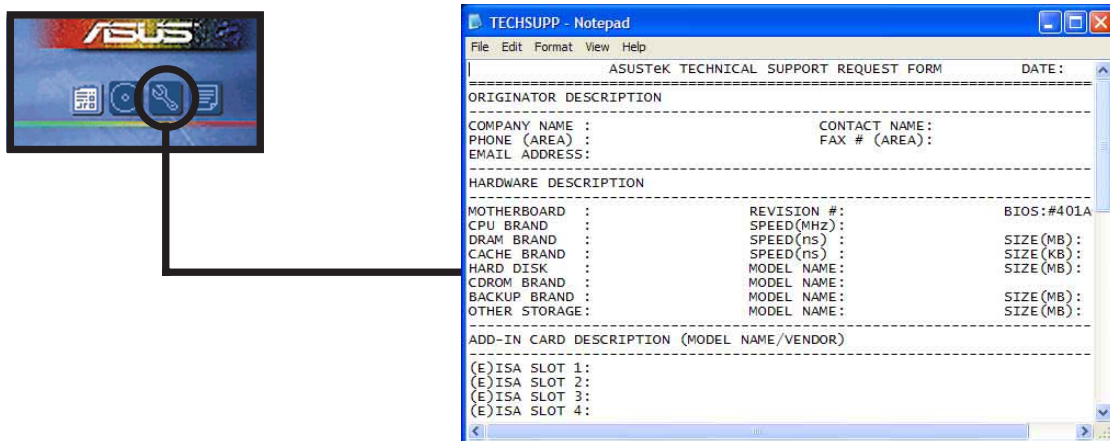

## Filelist

Displays the contents of the support CD and a brief description of each in text format.

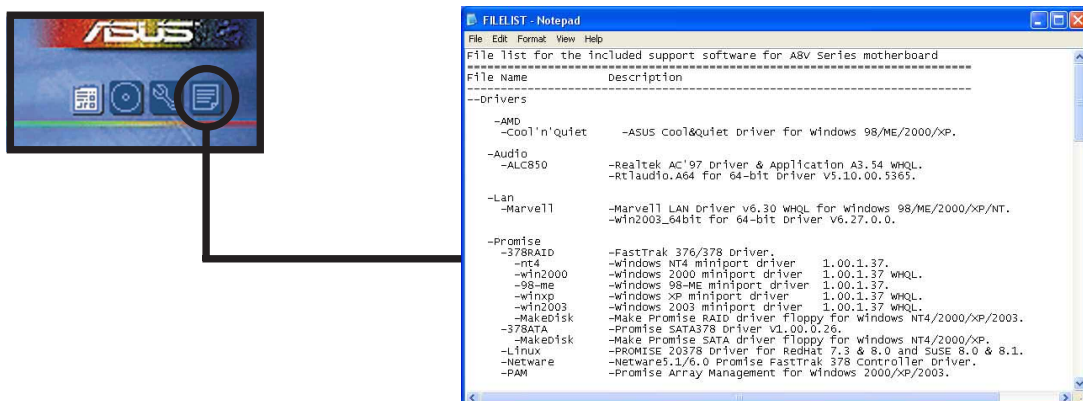

## 5.3 Software Information

Most of the applications in the support CD have wizards that will conveniently guide you through the installation. View the online help or readme file that came with the software for more information.

This section provides details of the software applications that the motherboard supports.

### 5.3.1 ASUS MyLogo2™

The ASUS MyLogo2™ is automatically installed when you install the ASUS Update utility from the software menu. See section “5.2.3 Utilities menu”.



Before using ASUS MyLogo2™ feature, use the AFUDOS utility to make a copy of your original BIOS file, or obtain the latest BIOS version from the ASUS website.



Make sure that the BIOS Item Full Screen Logo is set to [Enabled] if you want to use ASUS MyLogo2™. See section “4.6.2 Boot Settings Configuration”.

Follow these steps to use ASUS MyLogo2.

1. Launch the ASUS Update utility. See section “4.1.6 ASUS Update.”
2. When prompted for the BIOS update method, select the option “Update BIOS from a file.”
3. Specify the location of the BIOS file, such as from a floppy disk. Click **Next**.



- From the selection that appears, choose a logo image. Click **Next**.



You can create your own boot logo image in GIF, JPG, or BMP file formats.



- When you click on an image, it displays larger on the MyLogo2™ screen.



- ASUS MyLogo2™ might encounter problems with complex images. If a problem occurs, replace with a simpler image or make the image smaller.
- To reduce the logo image, click on the arrow on the Ratio item and select your desired scale.



- The next screen prompts you to flash the original BIOS to update it with the new boot logo. Click **Flash** to update the BIOS.

- When finished, click **Exit**, then reboot your computer. Your system boots with the new boot logo.

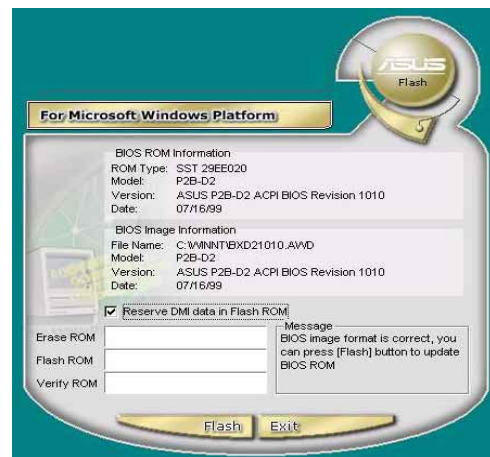

Instead of starting from ASUS Update, you can also launch ASUS MyLogo2™ directly from the Windows Start menu to change your BIOS boot logo. After you have modified the BIOS file with the new logo, use the ASUS Update utility to upload the new BIOS.

## 5.3.2 ASUS Instant Music

The motherboard is equipped with a BIOS-based audio playback feature called **Instant Music**. The onboard audio AC'97 CODEC supports this feature, which requires an optical drive (CD-ROM, DVD-ROM, or CD-RW).



- 
- Instant Music only supports CDs in audio format.
  - Instant Music does not work if you installed and enabled an add-on sound card.
  - Instant Music only supports PS/2 keyboard.
- 

To enable ASUS Instant Music:

1. Connect the analog audio cable from the optical drive (CD-ROM, DVD-ROM, or CD-RW drive) to the 4-pin CD-In connector (labeled CD) on the motherboard. See section “2.7 Connectors” for the location.



---

Make sure to connect the CD-ROM audio cable; otherwise, you cannot control the audio volume using the Instant Music function keys.

---

2. Turn on the system and enter the BIOS by pressing the <Del> key during the Power On Self-Tests (POST).
3. From the BIOS screen select **Advanced** then **Instant Music Configuration**.
4. In the **Instant Music Configuration** menu, select the item **Instant Music** and set it to **Enabled**. See section “4.4.7 Instant Music Configuration”.
5. The **Instant Music CD-ROM Drive** item appears if you enabled Instant Music. Highlight the item then press <Enter> to display the CD-ROM options.
6. Save your changes and exit BIOS Setup.



- 
- The Scroll Lock LED is fixed to ON after enabling Instant Music.
  - The Caps Lock LED turns ON when you pause the CD playback.
  - When set to Instant Music mode, the system wake-up features (LAN, keyboard, mouse, USB) are deactivated. In this case, power up the system using the power switch.
  - If the system loses connection or does not detect any optical drive, the Instant Music feature turns OFF (disabled) automatically. A “beep” indicates this condition.
-

## To use ASUS Instant Music:

1. Ensure that the power cord is plugged to a grounded power source, so that the system has standby power.
2. Use either one of the two sets of special function keys on your keyboard to play audio CDs. These keys only function as indicated if you enabled the Instant Music item in BIOS.

### *Instant Music function keys (Set 1)*

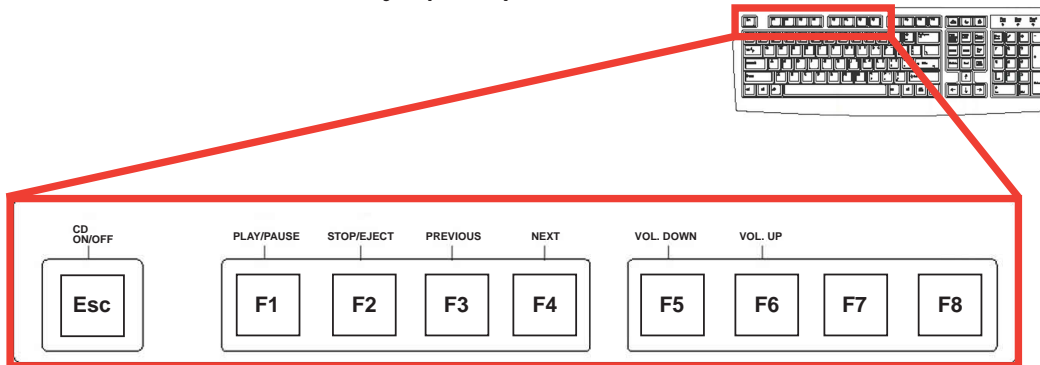

To guide you in using Instant Music, place the Instant Music label over the function keys on the keyboard. The Instant Music keyboard label comes with your motherboard package.

### *Instant Music function keys (Set 2)*

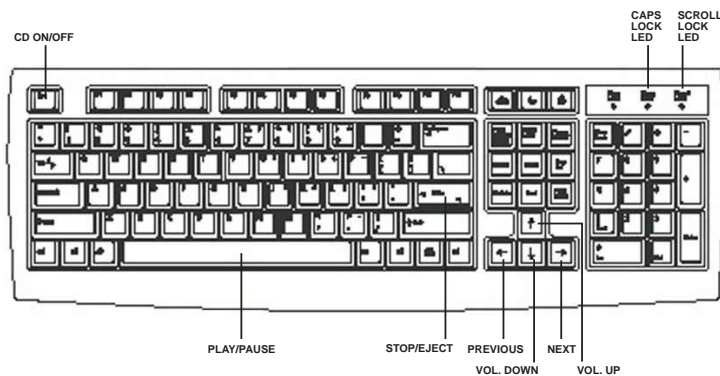

3. Connect speakers or a headphone to the Line Out (lime colored) port on the rear panel for audio output. You may also connect a headphone to the headphone jack on the CD-ROM drive front panel.
4. Press <Esc> to turn ON Instant Music.
5. Place an audio CD into the CD-ROM drive.
6. Press <F1> or the <Space Bar> to play the first track on the CD.



If there is no CD in the drive and you press <F1> or <Space Bar>, the drive tray ejects.

7. Refer to the Instant Music function key definitions on the previous page to select other tracks or control the volume.
8. Press <F2> or <Enter> *once* to stop playing the CD.  
Press <F2> or <Enter> *one more time* to eject the CD.

## 5.4 AI Net feature

The motherboard supports the Marvell® Virtual Cable Tester (VCT) Technology. The VCT virtually diagnoses and reports cable faults using the Time Domain Reflectometry (TDR). The VCT technology detects and reports open and shorted cables with up to one meter of accuracy. It also detects impedance mismatches, pair swaps, pair polarity problems, and pair skew problems of up to 64ns.

VCT remarkably reduces networking and support costs complementing a highly manageable and controlled network system. Also, this tool can be incorporated in the network systems software, making it ideal for field support as well as development diagnostics.

### Using the Virtual Cable Tester™

To use the the Marvell® Virtual Cable Tester™ on your computer.

1. Click the **Start** button. Select **All Programs > Marvell > Virtual Cable Tester**.
2. From the menu, click **Virtual Cable Tester**. The following screen display appears.
3. Click on **Run** to execute test.

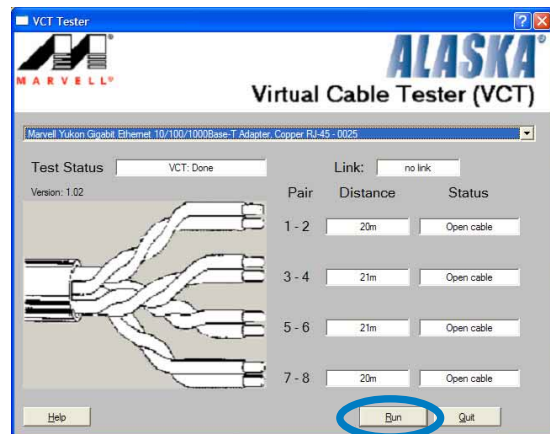

- The Virtual Cable Tester™ (VCT) feature is supported in Windows® XP and Windows® 2000 operating systems only.
- The Virtual Cable Tester™ (VCT) feature works in Gigabit LAN only.
- The **Run** button on the VCT Tester dialogue box is disabled if no problem is detected on the network.

## 5.5 Audio configurations

The Realtek® ALC850 AC '97 audio CODEC provides 8-channel audio capability to deliver the ultimate audio experience on your PC. The software provides Jack-Sensing function (Line-In, Line-Out, Mic-In), S/PDIF out support and interrupt capability. The ALC850 also includes the Realtek® proprietary UAJ® (Universal Audio Jack) technology for three ports (Line-In, Line-Out and Mic-In), eliminating cable connection errors and giving users plug and play convenience.

Follow the installation wizard to install the **Realtek ALC850 Audio Driver and Application** from the support CD that came with the motherboard package.

If the Realtek audio software is correctly installed, you will find the SoundEffect icon on the taskbar.



Realtek SoundEffect icon

From the taskbar, double-click on the **SoundEffect** icon to display the **Realtek Audio Control Panel**.



The Jack-sensing and UAJ® technology features are supported on the Line-In, Line-Out, and Mic jacks only.

### 5.5.1 Sound Effect options

The Realtek® ALC850 Audio CODEC allows you to set your listening environment, adjust the equalizer, set the karaoke, or select pre-programmed equalizer settings for your listening pleasure.



To set the sound effect options:

1. From the Realtek Audio Control Panel, click the **Sound Effect** button.
2. Click the shortcut buttons to change the acoustic environment, adjust the equalizer, or set the karaoke to your desired settings.
3. The audio settings take effect immediately after you click on the buttons.
4. Click the Exit (**X**) button on the upper-right hand corner of the window to exit.



## 5.5.2 S/PDIF options

The Sony/Philips Digital Interface (S/PDIF) options allows you to change your S/PDIF output settings.

To set the S/PDIF options:

1. From the Realtek Audio Control Panel, click the **SPDIF** button.
2. Click the option buttons to change your S/PDIF out settings.
3. Click the Exit (**X**) button on the upper-right hand corner of the window to exit.



### 5.5.3 Speaker Configuration

This option allows you to set your speaker configuration.

To set the speaker configuration:

1. From the Realtek Audio Control Panel, click the **Speaker Configuration** button.
2. Select from the combo list box your current speaker setup, then click **Auto Test** to test your settings.
3. Click the **UAJ Automatic** button to enable or disable the Universal Audio Jack(UAJ®) technology feature.
4. Click the Exit (X) button on the upper-right hand corner of the window to exit.



## 5.5.4 AI Audio feature

The AI Audio feature works through the connector sensing option that allows you to check if your audio devices are connected properly.

To start the connector sensing:

1. From the Realtek Audio Control Panel, click the **Connector Sensing** button.
2. Click the **Bracket** button to display connected audio devices.
3. Click the **Option** button to change sensing options.
4. Click the **Start** button to start connection sensing. A progress bar displays current connector sensing status.



---

Make sure to exit all audio applications before starting this function.

---

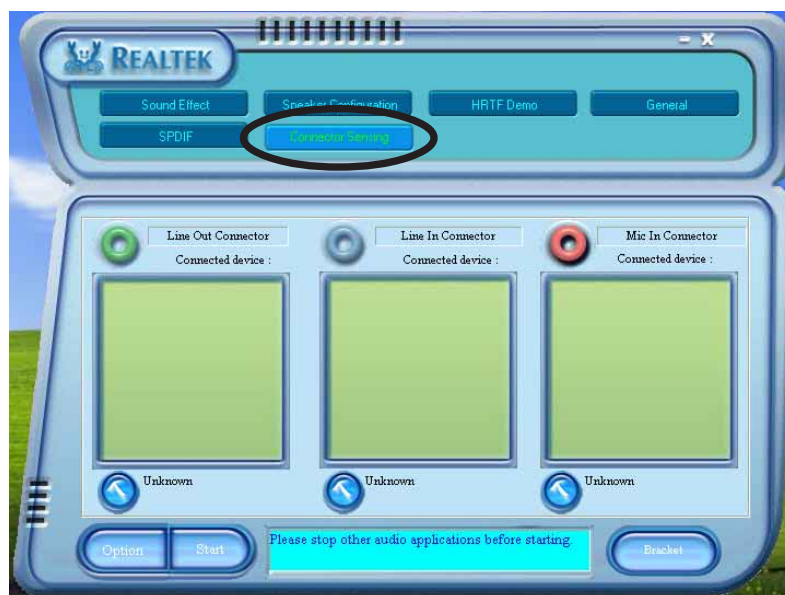

5. When finished, the utility prompts the Realtek® EZ-connection dialog box showing your current audio connections. The text at the bottom of the box explains your audio connection status. An *X* mark denotes an incorrect connection.

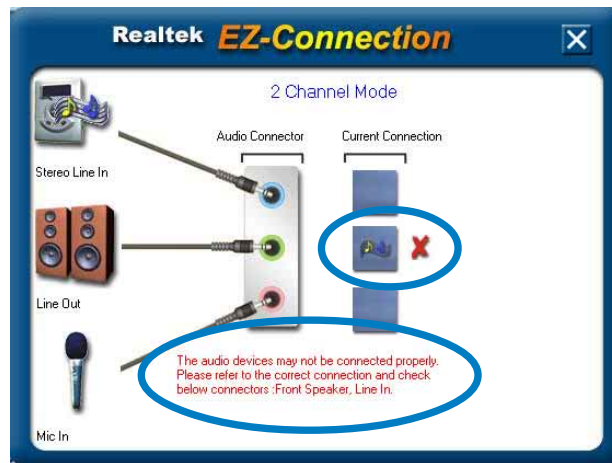

6. If there are detected problems, make sure that your audio cables are connected to the proper audio jack and repeat connector sensing.
7. Click the **X** button to exit EZ-connection dialog box.
8. Click the Exit (**X**) button on the upper-right hand corner of the window to exit audio control panel.

## 5.5.5 HRTF Demo

This option shows a demo of the Head-Related Transfer Functions (HRTF).

To start the HRTF demo:

1. From the Realtek Audio Control Panel, click the **HRTF Demo** button.
2. Click the option buttons to change the sound, moving path or EAX settings.
3. Click the **Play** button to start or the **Stop** button to stop.
4. Click the Exit (**X**) button on the upper-right hand corner of the window to exit.



## 5.5.6 General settings

This option shows the audio settings and allows you to change the language setting or toggle the SoundEffect icon display on the Windows taskbar.

To display the general settings:

1. From the Realtek Audio Control Panel, click the **General** button.
2. Click the option button to enable or disable the icon display on the Windows taskbar.
3. Click the **Language** combo list box to change language display.
4. Click the Exit (X) button on the upper-right hand corner of the window to exit.



## 5.5.7 Rear panel audio ports function variation

The functions of the Line Out (lime), Line In (blue), Mic (pink), Rear Speaker Out (gray), Side Speaker Out (black), and Center/Subwoofer (yellow orange) ports on the rear panel change when you select the 4-channel, 6-channel or 8-channel audio configuration as shown in the following table.

	Headset/ 2-channel	4-channel	6-channel	8-channel
Light Blue	Line In	Line In	Line In	Line In
Lime	Line Out	Front Speaker Out	Front Speaker Out	Front Speaker Out
Pink	Mic In	Mic In	Mic In	Mic In
Gray	-	Rear Speaker Out	Rear Speaker Out	Rear Speaker Out
Black	-	-	-	Side Speaker Out
Yellow Orange	-	-	Center/Subwoofer	Center/Subwoofer

## 5.6 RAID configurations

The motherboard includes the Promise® PDC20378 controller chipset and the VIA VT8237 controller integrated in the SouthBridge to support Redundant Array of Independent Disks (RAID) configurations. Using four Serial ATA hard disks and two UltraDMA133 hard disks, you can set up RAID 0, RAID 1, RAID 0+1, Multi-RAID and JBOD configurations. The following defines the different RAID set configurations:

**RAID 0** (called *data striping*) optimizes two identical hard disk drives to read and write data in parallel, interleaved stacks. Two hard disks perform the same work as a single drive but at a sustained data transfer rate, double that of a single disk alone, thus improving data access and storage.

**RAID 1** (called *data mirroring*) copies and maintains an identical image of data from one drive to a second drive. If one drive fails, the disk array management software directs all applications to the surviving drive as it contains a complete copy of the data in the other drive. This RAID configuration provides data protection and increases fault tolerance to the entire system.

**RAID 0+1** is *data striping* and *data mirroring* combined without parity (redundancy data) having to be calculated and written. The advantage of RAID 0 + 1 is fast data access (like RAID 0), but with the ability to lose one drive and have a complete duplicate surviving drive or set of drives (like RAID 1).

**Multiple RAID** allows both RAID 0 and RAID 1 configurations to co-exist on a system. This RAID configuration delivers the advantages of data striping and data mirroring on separate RAID sets in one system.

**JBOD** stands for *Just a Bunch of Disks* or also called *spanning*, refers to hard disks that are not yet configured according to RAID. The JBOD configuration stores the same data redundantly on multiple disks that appear as a single disk on the operating system. Spanning does not deliver any advantage over using separate disks independently and does not provide fault tolerance or performance benefits of RAID.



---

If you use either Windows® XP or Windows® 2000 operating system (OS), copy first the RAID driver from the support CD to a floppy disk before creating RAID configurations. Refer to section “5.7 Creating a RAID driver disk” for details.

---

## 5.6.1 Installing hard disks

The motherboard supports UltraDMA 133/100/66 and Serial ATA hard disk drives. For optimal performance, install identical drives of the same model and capacity when creating a disk array.



- 
- If you are creating a **RAID 0 (striping)** array for performance, use two new drives.
  - If you are creating a **RAID 1 (mirroring)** array for protection, you can use two new drives or use an existing drive and a new drive with the same or larger size than the existing drive.
  - If you are creating a **RAID 0+1** array for protection, you can use four new drives or use an existing drive and three new drives.
- 

### Installing Parallel ATA hard disks

To install the hard disks for RAID configuration:

1. Set the jumpers of each hard disk as Master/Slave.
2. Install the hard disks into the drive bays.
3. Connect the HDD signal cables.
4. Connect the power cable to the power connector on each drive.
5. Boot the system and enter the BIOS Setup Utility.
6. Go to the **Advanced > Onboard Devices Configuration** and make sure the **Onboard Promise Controller** item is Enabled.
7. Set the **Operating Mode** as RAID.
8. Save your changes and Exit Setup.

### Installing Serial ATA (SATA) hard disks

To install the SATA hard disks for RAID configuration:

1. Install the Serial ATA hard disks into the drive bays.
2. Connect the Serial ATA signal cables.
3. Connect the Serial ATA power cable to the power connector on each drive.
4. Boot the system and enter the BIOS Setup Utility.
5. Go to **Advanced > Onboard Devices Configuration** and make sure the **Onboard Promise Controller** item is Enabled.
6. Set the **Operating Mode** as RAID.
7. Save your changes and Exit Setup.

## 5.6.2 Promise® RAID configurations

The Promise® PDC20378 controller supports RAID 0, RAID 1, RAID 0+1, and Multi-RAID configurations. Use the MBFastTrak378™ BIOS and the FastBuild™ utility to configure a disk array.



Refer to the **FastTrak 378 Quick Start Guide** and **SATA Quick Start Guide** in the support CD for detailed information on RAID configurations under different operating systems.

### Entering the MBFastBuild™ utility

1. Boot the system.

If this is the first time you boot the system with the new hard disks installed and connected to the ATA/IDE connectors on the motherboard, the MBFastTrak378™ BIOS displays the following:

```
MBFastTrak378 (tm) BIOS version 1.00
(c)2000-2005 Promise Technology, Inc. All Rights Reserved.

No Array defined...

Press <Ctrl-F> to enter FastBuild (tm) Utility
Or press <ESC> key to continue booting.
```

2. Press <Ctrl+F> to display the FastBuild™ utility main menu.

```
FastBuild (tm) Utility 2.00 (c) 2002-2005 Promise Technology, Inc.
[ Main Menu ]

Auto Setup . . . . . [ 1 ]
View Drive Assignments . . . . [ 2 ]
Define Array . . . . . [ 3 ]
Delete Array . . . . . [ 4 ]
Rebuild Array. . . . . [ 5 ]

[ Keys Available ]

Press 1..5 to select Option [ESC] Exit
```



## Creating a RAID 0 array (Performance)

1. In the FastBuild™ utility main menu, press <1> to select Auto Setup. The following screen appears.

```
FastBuild (tm) Utility 2.00 (c) 2002-2005 Promise Technology, Inc.
[ Auto Setup Options Menu ]
Optimize Array for:      Performance
[ Array Setup Configuration ]
Mode ..... Stripe
Spare Drive..... 0
Drive(s) Used in Array..... 2
Array Disk Capacity (size in MB)..... 8650
[ Keys Available ]
[ ↑ ] Up [ ↓ ] Down [ ←,→,Space ] Change Option [ ESC ] Exit [ CTRL-Y ] Save
```

2. Use the arrow keys to go to the field **Optimize Array for** and select **Performance** using the space bar. The **Mode** field displays *Stripe*.
3. After making a selection, press <Ctrl+Y> to save and create a RAID 0 array.
4. Press any key to reboot the system. During the boot process, the MBFastTrak378 BIOS checks and displays the disk array information.

```
MBFastTrak376 (tm) BIOS Version 1.00
(c) 2000-2005 Promise Technology, Inc. All Rights Reserved.
ID      MODE          SIZE      TRACK-MAPPING  STATUS
-----
1*      2+0 Stripe      3257M     723/192/48     Functional
Press <Ctrl-F> to enter FastBuild (tm) Utility
```

5. Once the array is created, use the FDISK utility to format the array as a single hard drive.
6. After you have formatted the arrayed drives, install an operating system (OS). The OS will treat the RAID 0 array as a single drive unit.



During the OS installation, the system prompts you to install third-party SCSI or RAID driver. Refer to section “5.7 Creating a RAID driver disk” for details.

## Creating a RAID 1 array (Security)

### Creating a Security Array with New Drives

1. In the FastBuild™ utility main menu, press <1> to select Auto Setup.

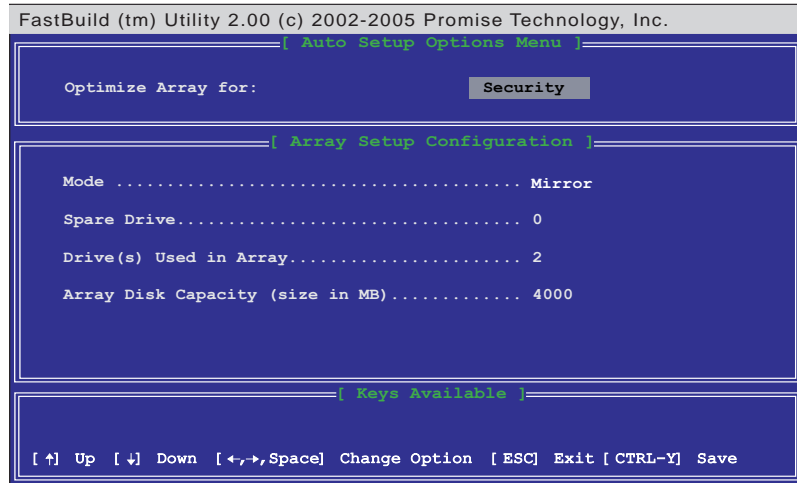

2. Use the arrow keys to go to the field **Optimize Array for** and select **Security** using the space bar. The **Mode** field displays *Mirror*.
3. Press <Ctrl+Y> to save your selection.
4. The following message appears:

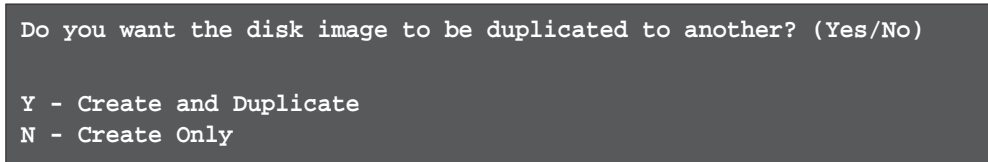

5. Press <N> to select the *Create Only* option. The utility prompts a confirmation message that your Security array has been created.

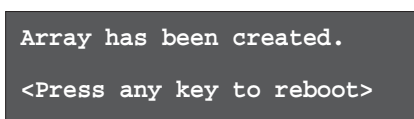

6. Press any key to reboot the system. During the boot process, the MBFastTrak378 BIOS checks and displays the disk array information.

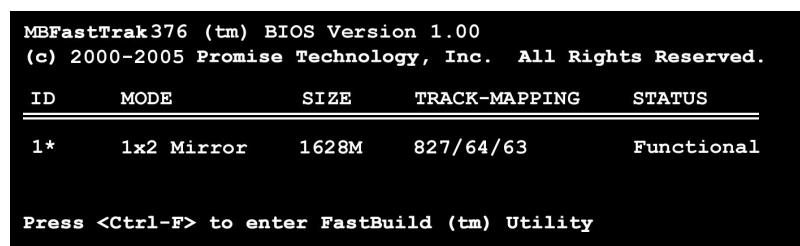

7. Use the FDISK utility and follow the format procedure to install a new hard drive. After you have formatted the arrayed drives, install an operating system (OS).



---

During the OS installation, the system prompts you to install third-party SCSI or RAID driver. Refer to section “5.7 Creating a RAID driver disk” for details.

---

### ***Creating a Security Array with Existing Data Drive***

If you would like to use an existing drive that already contains data and/or is the bootable drive in your system, make sure that the new hard drive you will use in the array has the same or larger capacity as the existing drive.



---

Back up all important data before creating an array.

---

1. In the FastBuild™ utility main menu, press <1> to select Auto Setup.
2. Use the arrow keys to move to the field **Optimize Array for** and select **Security** using the space bar. The **Mode** field displays *Mirror*.
3. Press <Ctrl+Y> to save your selection. The following message appears:

```
Do you want the disk image to be duplicated to another? (Yes/No)

Y - Create and Duplicate
N - Create Only
```

5. Press <Y> to select the *Create and Duplicate* option.
6. From the source drive window, use the arrow keys to select the source drive.
7. Press <Ctrl+Y> to save the selection and start the duplication. The following message appears:

```
Start to duplicate the image...
Do you want to continue? (Yes/No)

Y - Continue    N - Abort
```

8. Press <Y> to continue. Press <N> to return to the main menu.
9. When complete, the utility prompts that your Security array has been created.
10. Press any key to reboot the system.
11. Install an operating system.



---

During the OS installation, the system prompts you to install third-party SCSI or RAID driver. Refer to section “5.7 Creating a floppy with RAID driver” for details.

---

### Other FastBuild Utility Commands

Command options 3-6 on the FastBuild™ Utility main menu are not required for setting up an array, but they are useful for reconfiguring an array.

**View Array (3):** This command allows you to view the drive assignments of hard disks in an array.

**Delete Array (4):** This command deletes an array to reconfigure the system. Deleting an array does not remove information on the hard disks. If an array is deleted by mistake, recover it immediately by redefining it as the deleted array.

**Rebuild Array (5):** This command restores the array and system data after faults on RAID 1 arrays.

To rebuild and restore data in the array:

1. During the boot-up process, an error message notifies of a system failure.
2. Press <Ctrl+F> to enter the FastBuild™ Main Menu.
3. Press <3> to View Array and verify the ID of the defunct hard disk.
4. Power off the system and replace the hard disk with an identical model.
5. Reboot and enter the FastBuild™ Main Menu again.
6. Press <5> to Rebuild Array. The malfunctioning array is highlighted. Press <Enter> to select malfunctioning array.

```

FastBuild (tm) Utility 2.00 (c) 2002-2005 Promise Technology, Inc.
----- [ Rebuild Array Menu ] -----
  Array No   RAID Mode   Total Drv   Capacity   Status
-----
  Array 1   Mirror/Stripe   4           7999   Critical
  Array 2   -----
  Array 3   -----
  Array 4   -----

----- [ Keys Available ] -----

[ ↑ ] Up [ ↓ ] Down [ ESC ] Exit [ Enter ] Select

```

7. Select the replacement drive then press <Enter>.

```

FastBuild (tm) Utility 2.00 (c) 2002-2005 Promise Technology, Inc.
----- [ View Array Definition Menu ] -----
  Array No   RAID Mode   Total Drv   Status
-----
  Array 1   Mirror/Stripe   4           Critical

  Stripe Block: Not Available           Gigabyte Boundary: ON

----- [ Select Drive for Rebuild ] -----
  Channel: ID   Drive Model   Capacity (MB)
-----
  3:Mas FUJITSU MPD3043AT           4325

----- [ Keys Available ] -----

[ ↑ ] Up [ ↓ ] Down [ ESC ] Exit [ Enter ] Select

```

8. Confirm the command to copy data from the intact source hard disk into a new replacement hard disk. A progress bar displays the copy progress for the duration of the task.
9. When completed, the utility prompts you to reboot the system. Press any key to reboot your system.

**Controller Configuration (6):** This command shows the default for Controller Configuration. The default value is [Enabled].

## 5.6.3 VIA RAID configurations

The motherboard includes a high performance IDE RAID controller integrated in the VIA VT8237 southbridge chipset. It supports RAID 0 and RAID 1 with two independent Serial ATA channels.



Refer to **VIA8237 SATA Quick Setup guide** found in the support CD for detailed information on RAID configurations under different operating systems.

### Entering VIA Tech RAID BIOS Utility

1. Boot-up your computer.
2. During POST, press <Tab> to enter VIA RAID configuration utility. The following menu options will appear.



The RAID BIOS information on the setup screen shown below is for reference only. What you see on your screen may not exactly match what is shown here.

```
VIA Tech. RAID BIOS Ver 1.xx

▶ Create Array
▶ Delete Array
▶ Create/Delete Spare
▶ Select Boot Array
▶ Serial Number View

Create a RAID array with
the hard disks attached to
VIA RAID controller

F1 : View Array/Disk Status
↑,↓ : Move to next item
Enter : Confirm the selection
ESC : Exit

Channel      Drive Name      Array Name Mode  Size (GB) Status
Serial_Ch0 Master XXXXXXXXXXXXX  ARRAY 0  SATA  999.99  XXXXXXXX
Serial_Ch1 Master XXXXXXXXXXXXX  ARRAY 0  SATA  999.99  XXXXXXXX
```

On the upper-right side of the screen is the message and legend box. The keys on the legend box allows you to navigate through the setup menu options. The message describes the function of each menu item. The following lists the keys found in the legend box with their corresponding functions.

- <F1> : View Array/Disk Status
- ↑, ↓ : Move to the next item
- <Enter> : Confirm the selection
- <ESC> : Exit

## Create Array

1. From the VIA RAID BIOS utility main menu, select **Create Array** then press **<Enter>**. The main menu items on the upper-left corner of the screen are replaced with create array menu options.

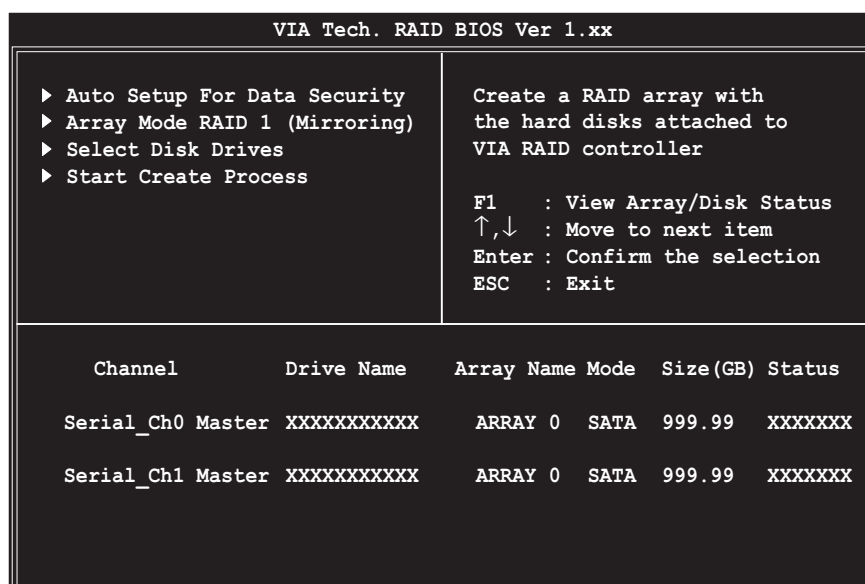

## RAID 0 for performance

1. From the create array menu, select **Array Mode**, then press **<Enter>**. The supported RAID configurations appear on a pop-up menu.

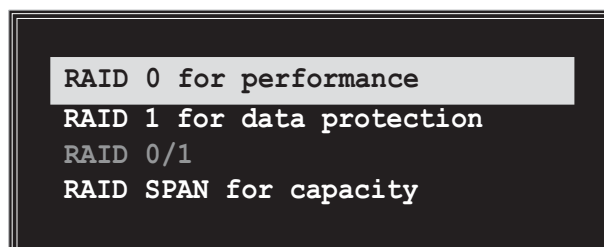

2. Select **RAID 0 for performance** then press **<Enter>**.

From this point, you may choose to auto-configure the RAID array by selecting **Auto Setup for Performance** or manually configure the RAID array for striped sets. If you want to auto-configure, proceed to the next step, otherwise, skip to step 5.

3. Select **Auto Setup for Performance** and press **<Enter>**. The following confirmation message appears.

```
Auto create array will destroy all
data on disks, Continue? (Y/N)
```

4. Press <Y> to confirm or <N> to return to the configuration options. If you selected <Y>, proceed to step 9.
5. Select **Select Disk Drives**, then press <Enter>. Use arrow keys to select disk drive, then press <Enter> to mark selected drive. An asterisk appears before a selected drive.
6. Select **Block Size**, then press <Enter> to set array block size. A list of valid array block sizes are displayed on a pop-up menu.



---

**TIP:** For server systems, use of a lower array block size is recommended. For multimedia computer systems used mainly for audio and video editing, a higher array block size is recommended for optimum performance.

---

Use arrow keys to move selection bar on items and press <Enter> to select.

7. Select **Start Create Process** and press <Enter> to set up hard disk for RAID system. The following confirmation message appears:

```
The data on the selected disks will
be destroyed. Continue? (Y/N)
```

8. Press <Y> to confirm or <N> to return to the configuration options.
9. Press <Esc> to go back to main menu.

### ***RAID 1 for data protection***

1. From the create array menu, select **Array Mode**, then press <Enter>. The supported RAID configurations appear on a pop-up menu.

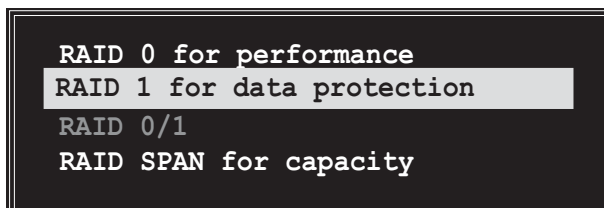

2. Select **RAID 1 for data protection** then press <Enter>.



3. From this point, you can auto-configure the RAID array by selecting **Auto Setup for Data Security** or manually configure the RAID array for mirrored sets. If you want to auto-configure, proceed to the next step, otherwise, skip to step 6.
4. Select **Auto Setup for Data Security** and press <Enter>. The following confirmation message appears.

```
Auto create array will destroy all
data on disks, Continue? (Y/N)
```

5. Press <Y> to confirm or <N> to return to the configuration options. If you selected <Y>, proceed to step 11.
6. Select **Select Disk Drives**, then press <Enter>. Use arrow keys to select disk drive/s, then press <Enter>. An asterisk appears before a selected drive.
7. Select **Start Create Process** and press <Enter> to setup hard disk for RAID system. The following inquiry appears:

```
Save the data on source disk to
mirror after creation? (Y/N)
```

8. If you select <Y> the utility will duplicate your data. Press <Y> anytime if you want to exit the duplication process.

```
Duplicating...
Press Yes (Y) to Escape
```

9. If you select <N>, the following confirmation message appears.

```
The data on the selected disks will
be destroyed. Continue? (Y/N)
```

10. Press <Y> to confirm or <N> to return to the configuration options.
11. Press <Esc> to go back to main menu.

## ***RAID Span for capacity***

1. From the create array menu, select **Array Mode**, then press <Enter>. The supported RAID configurations appear on a pop-up menu.

```
RAID 0 for performance
RAID 1 for data protection
RAID 0/1
RAID SPAN for capacity
```

2. Select **RAID SPAN for capacity** then press <Enter>.
3. From this point, you can auto-configure the RAID array by selecting **Auto Setup for Capacity** or manually configure the RAID array for spanned sets. If you want to auto-configure, continue with next step; otherwise, proceed to step 6.
4. Select **Auto Setup for Capacity** and press <Enter>. The following confirmation message appears.

```
Auto create array will destroy all
data on disks, Continue? (Y/N)
```

5. Press <Y> to confirm or <N> to return to the configuration options. If you selected <Y>, proceed to step 11.
6. Select **Select Disk Drives**, then press <Enter>. Use arrow keys to select disk drive/s, then press <Enter>. An asterisk appears before a selected drive.
7. Select **Start Create Process** and press <Enter> to start RAID system setup. The following inquiry appears:

```
Save the data on Span 0 disk
after creation? (Y/N)
```

8. If you select <Y>, the utility will save your disk data on Span 0 disk then configure the RAID set. Proceed to step 11.
9. If you select <N>, the following confirmation message appears.

```
The data on the selected disks will
be destroyed. Continue? (Y/N)
```

10. Press <Y> to confirm or <N> to return to the configuration options.
11. Press <Esc> to go back to main menu.

## Delete Array

1. From the VIA RAID BIOS utility main menu, select **Delete Array** then press <Enter>.

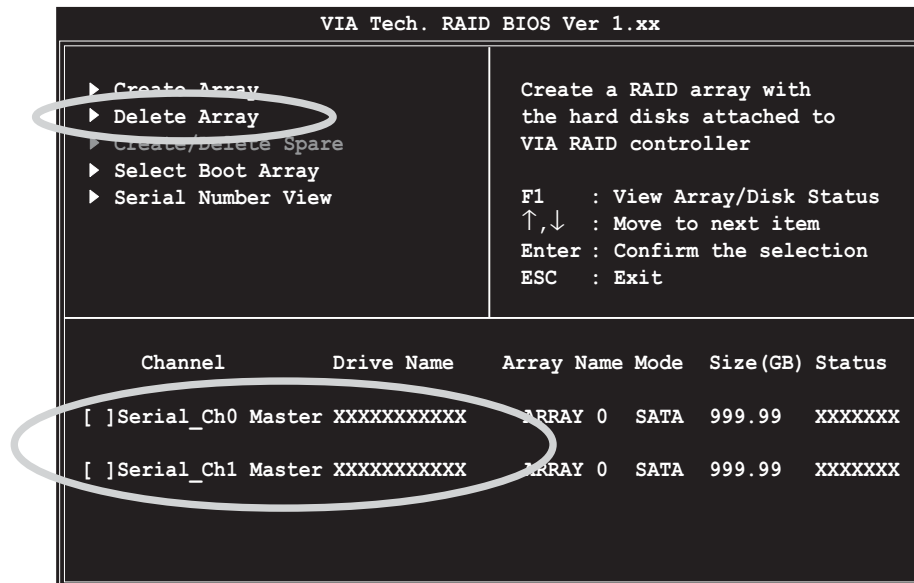

2. From the list of channel used for IDE RAID arrays, press <Enter> to select a RAID array to delete. The following confirmation message appears.

The selected array will be destroyed.  
Are you sure? Continue? Press Y/N

3. Press <Y> to confirm or <N> to return to the configuration options.

## Select Boot Array

1. From the VIA RAID BIOS utility main menu, select **Select Boot Array** then press <Enter>.
2. From the list of channel used for IDE RAID arrays, press <Enter> to select a RAID array for boot. After selection, the **Status** of the selected array will change to Boot.
3. Press <ESC> to return to the menu items. Follow the same procedure to deselect the the boot array.

## Serial Number View

1. From the VIA RAID BIOS utility main menu, select **Serial Number View** then press <Enter>.
2. From the list of channel used for IDE RAID arrays, use the arrow keys to move the selection bar on each item. The serial number for the selected drive is displayed at the bottom of the screen.



This option is useful for identifying same model disks.

```
VIA Tech. RAID BIOS Ver 1.xx
```

<ul style="list-style-type: none"><li>▶ Create Array</li><li>▶ Delete Array</li><li>▶ Create/Delete Spare</li><li>▶ Select Best Array</li><li>▶ <b>Serial Number View</b></li></ul>	<p>Create a RAID array with the hard disks attached to VIA RAID controller</p> <p>F1 : View Array/Disk Status ↑,↓ : Move to next item Enter : Confirm the selection ESC : Exit</p>
---	--

Channel	Drive Name	Array Name	Mode	Size(GB)	Status
<b>Serial_Ch0 Master</b>	XXXXXXXXXXXX	ARRAY 0	SATA	999.99	XXXXXXX
Serial_Ch1 Master	XXXXXXXXXXXX	ARRAY 0	SATA	999.99	XXXXXXX

Serial Number: XXXXXXXX

## 5.7 Creating a RAID driver disk

A floppy disk with the RAID driver is required when installing Windows® XP/2000 operating system. You can create a RAID driver disk using Makedisk.exe utility.

To create a RAID driver disk:

1. Insert the motherboard support CD into the CD-ROM drive and locate the Makedisk.exe utility for your RAID controller.
  - a. The Makedisk.exe utility for the FastTrak 378 driver is located in “\Drivers\Promise\378RAID\Makedisk.exe” of the motherboard support CD.
  - b. The Makedisk.exe utility for the VIA RAID driver is located in “\Drivers\VIARAID\6420RAID\DriverDisk\Makedisk.exe” of the motherboard support CD.
2. Insert a clean floppy disk into the floppy disk drive and execute Makedisk.exe. Follow succeeding screen instructions to complete the process.
3. Write-protect the floppy disk to avoid computer virus infection.

To install the RAID driver:

1. During the OS installation, the system prompts you to press the **F6** key to install third-party SCSI or RAID driver.
2. Press <F6> then insert the floppy disk with RAID driver into the floppy disk drive.
3. Follow the succeeding screen instructions to complete the installation.



---

For additional information on RAID installation and configuration, refer to the Manuals menu of the support CD.

---

## 5.8 Cool 'n' Quiet!™ Technology

The motherboard supports the AMD Cool 'n' Quiet!™ Technology that dynamically and automatically change the CPU speed, voltage, and amount of power depending on the task the CPU performs.

### 5.8.1 Enabling Cool 'n' Quiet!™ Technology

To enable Cool 'n' Quiet!™ Technology:

1. Turn on the system and enter BIOS by pressing the <Del> key during the Power On Self-Tests (POST).
2. In the **Advanced > CPU Configuration > AMD CPU Cool & Quiet Configuration** menu, select the item **Cool N'Quiet** and set it to **Enabled**. See section "4.4 Advanced Menu" in the user guide.
3. In the **Power** menu, select the item **ACPI 2.0 Support** and set it to **Yes**. See section "4.5 Power Menu" in the user guide.
4. Save your changes and exit BIOS Setup.
5. Reboot your computer and set your Power Option Properties depending on your operating system.

### Windows® 2000/XP

1. From the Windows® 2000/XP operating system, click the **Start** button. Select **Settings**, then **Control Panel**.
2. Make sure the Control Panel is set to Classic View.
3. Double-click the **Display** icon in the Control Panel then select the **Screen Saver** tab.
4. Click the **Power...** button. The following dialog box appears.
5. From the **Power schemes** combo list box, select **Minimal Power Management**.
6. Click **OK** to effect settings.

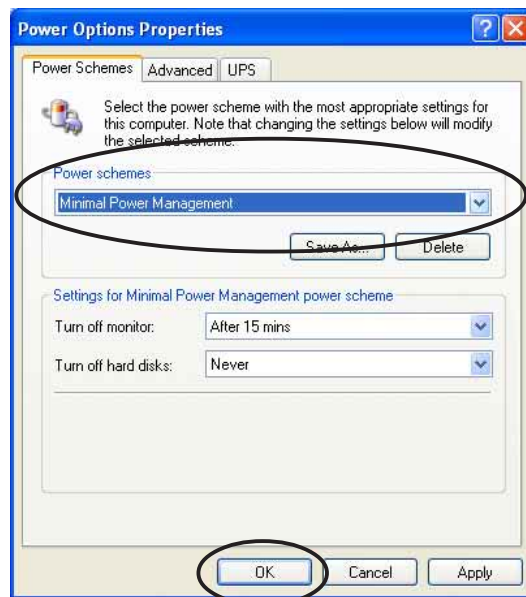

Make sure to install the Cool 'n' Quiet!™ driver and application before using this feature.

## Windows® 98SE/ME

1. From the Windows® 98SE/ME operating system, click the **Start** button. Select **Settings**, then **Control Panel**.
2. Double-click the **Display** icon in the Control Panel then select the **Screen Saver** tab.
3. From the **Energy saving features of monitor** group, click the **Settings...** button.

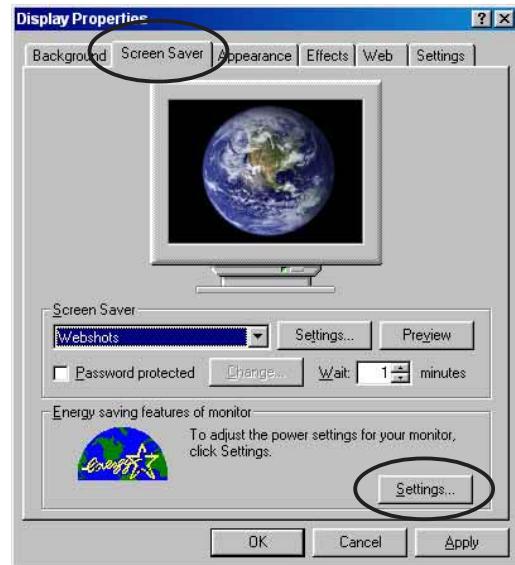

4. From the **Power Options Properties** dialog box, select the **AMD's Cool 'n' Quiet(tm) Technology** tab.
5. Click the **Performance** combo list box to select desired mode. Automatic Mode is the recommended setting.
6. Click **OK** to effect settings.

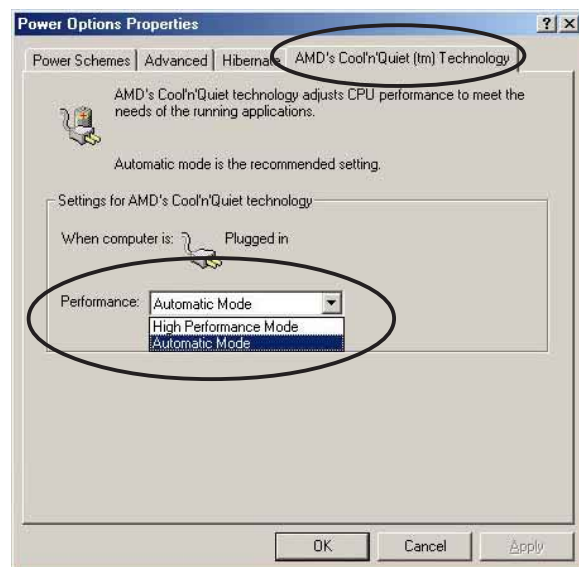

- Make sure to install the AMD Cool 'n' Quiet!™ driver and application before using this feature.
- The AMD Cool 'n' Quiet!™ Technology feature works only with the AMD heatsink and fan assembly with monitor chip.
- If you purchased a separate heatsink and fan package, use the ASUS Q-Fan Technology feature to automatically adjust the CPU fan speed according to your system loading.

## 5.8.2 Launching the Cool 'n' Quiet!™ software

The motherboard support CD includes the Cool 'n' Quiet!™ software that enables you to view your system's real-time CPU Frequency and voltage.



Make sure to install the Cool 'n' Quiet!™ software from the motherboard support CD. Refer to section "5.2.3 Utilities menu", for details.

To launch the Cool 'n' Quiet!™ program:

1. If you are using Windows® 98SE/ME/2000, click the **Start** button. Select **Programs > ASUS > Cool & Quiet > Cool & Quiet**.
2. If you are using Windows® XP, click the **Start** button. Select **All Programs > ASUS > Cool & Quiet > Cool & Quiet**.
3. The Cool 'n' Quiet!™ technology screen appears and displays the current CPU Frequency and CPU Voltage.

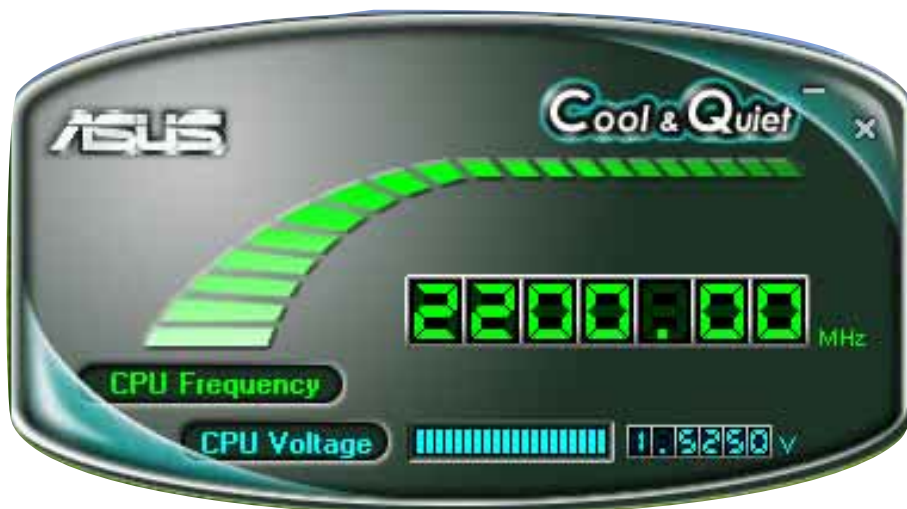



## Free Manuals Download Website

<http://myh66.com>

<http://usermanuals.us>

<http://www.somanuals.com>

<http://www.4manuals.cc>

<http://www.manual-lib.com>

<http://www.404manual.com>

<http://www.luxmanual.com>

<http://aubethermostatmanual.com>

Golf course search by state

<http://golfingnear.com>

Email search by domain

<http://emailbydomain.com>

Auto manuals search

<http://auto.somanuals.com>

TV manuals search

<http://tv.somanuals.com>