



A7N8X-LA ***(Focus)***

User Guide

Motherboard

Contents

A7N8X-LA (Focus) specifications summary	iii
1. Motherboard layout	1
2. Central Processing Unit (CPU)	2
Installing the CPU	2
3. System memory	3
Installing a DIMM	3
4. Expansion slots	4
Standard interrupt assignments	4
IRQ assignments for this motherboard	4
PCI slots	5
AGP slot	5
5. Jumpers	6
6. Connectors	8

Product Name:	A7N8X-LA Focus
Manual Revision:	E1317 V1
Release Date:	May 2003

A7N8X-LA (Focus) specifications summary

CPU	Socket A for AMD Athlon™/Athlon XP™ Supports up to Athlon XP™ 3200+
Chipset	nVidia nForce2 400 SPP nVidia MCP-T
Front Side Bus (FSB)	400/333/266 MHz
Memory	2 x 184-pin DDR DIMM sockets for up to 2GB memory Supports PC2700/PC2100 double-sided DDR
Expansion slots	1 x AGP 8X slot 3 x PCI slots
IDE	2 x UltraDMA100/66/33 connectors, PIO Mode 3/4 Supports ATAPI IDE, CD-ROM, CD-R, CD-RW and LS-120
Onboard Audio	RealTek ALC650 6-channel audio CODEC subsystem AC'97 2.2 compliant
Onboard LAN	Realtek 8201BL LAN PHY supports 10/100 Mbps
Onboard IEEE 1394	Agere FW802C PHY supports 2 x 1394 ports with 400/200/100Mbps data transfer rate
Hardware monitoring	Super I/O integrated monitoring of CPU and chassis fan rotations and CPU/chassis temperature
Special features	Wakeup on Ring, LAN, Keyboard, PS/2 Mouse, RTC Timer Supports ACPI STR (S3) function Restart/Off Setup of AC recovery from power failure
Rear panel I/O	1 x Parallel port 1 x Serial port 1 x PS/2 keyboard port 1 x PS/2 mouse port 4 x USB 2.0 ports 1 x RJ-45 port 1 x IEEE 1394 port Line In/Line Out/Microphone ports
Internal I/O	1 x USB 2.0 connector for 2 additional USB ports 1 x IEEE 1394 connector for additional 1394 port CPU/chassis fan connectors 20-pin ATX power connectors S/PDIF out connector CD/AUX audio connectors Front headphone connector Front MIC-IN connector

(Continued next page)

A7N8X-LA (Focus) specifications summary

BIOS features	4Mb Flash ROM, AMI BIOS with Enhanced ACPI, DMI, Green, PnP features
Industry Standard	USB 2.0/1.1, PCI 2.2
Form factor	MicroATX form factor: 9.6 in x 9.6 in (24.5 cm x 24.5 cm)

** Specifications are subject to change without notice*

1. Motherboard layout

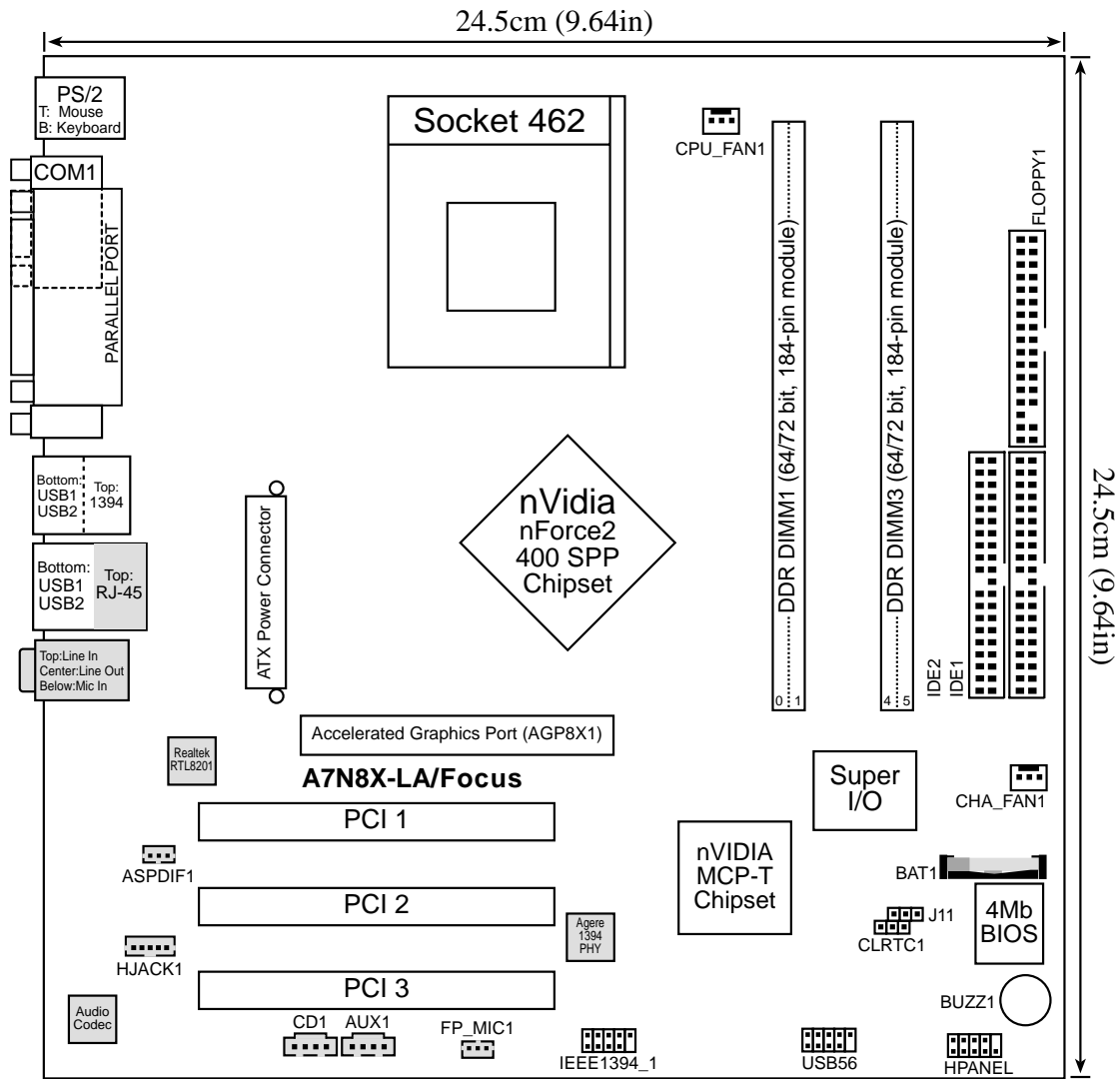

2. Central Processing Unit (CPU)

The motherboard provides a Socket A (462) for CPU installation. AMD processors offer gigahertz speeds to support all latest computing platforms and applications. The A7N8X-LA supports AMD Athlon™/Athlon XP™ 3200+ processors. This motherboard supports 400/333/266MHz front side bus (FSB), and allows data transfers of up to 2.7GB/s with PC2700 DDR.

Each AMD CPU has a “marked” corner. This corner is usually indicated with a notch and/or a golden square or triangle. Refer to this indicator while orienting the CPU. A fan and a heatsink should be attached to the CPU to prevent overheating.

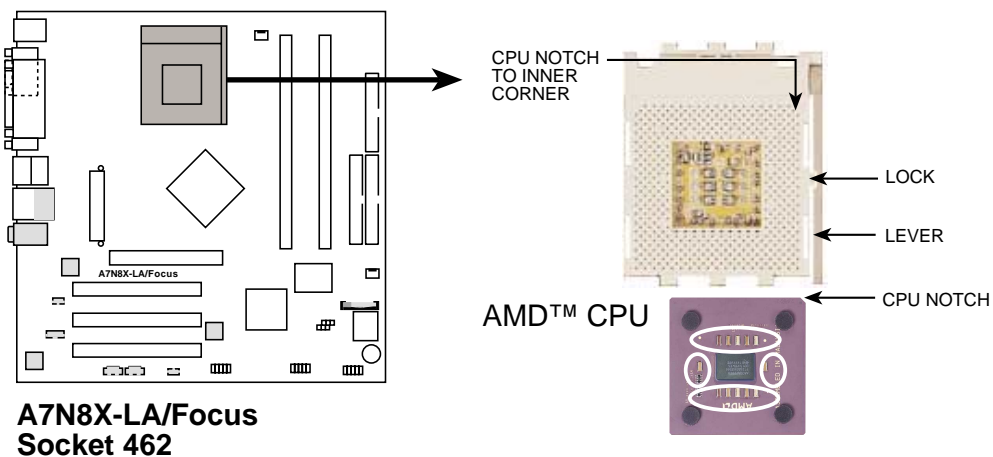

Installing the CPU

Follow these steps to install a CPU.

1. Locate the Socket 462 and open it by pulling the lever gently sideways away from the socket. Then lift the lever upwards. The socket lever must be fully opened (90 to 100 degrees).
2. Insert the CPU with the correct orientation. The notched or golden corner of the CPU must be oriented toward the inner corner of the socket base nearest to the lever hinge.

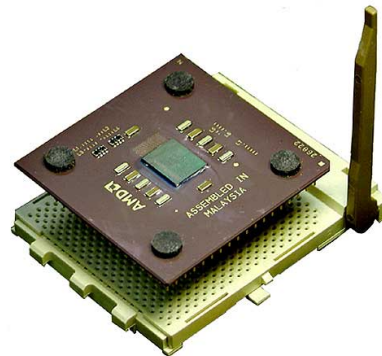

The CPU fits only in one correct orientation. DO NOT force the CPU into the socket to prevent bending the pins and damaging the CPU!

3. System memory

The motherboard comes with two Double Data Rate (DDR) Dual Inline Memory Module (DIMM) sockets. These sockets support up to 2GB system memory using 184-pin unbuffered non-ECC PC2700/PC2100 double-sided DDR DIMMs.

The following figure illustrates the location of the DDR DIMM sockets.

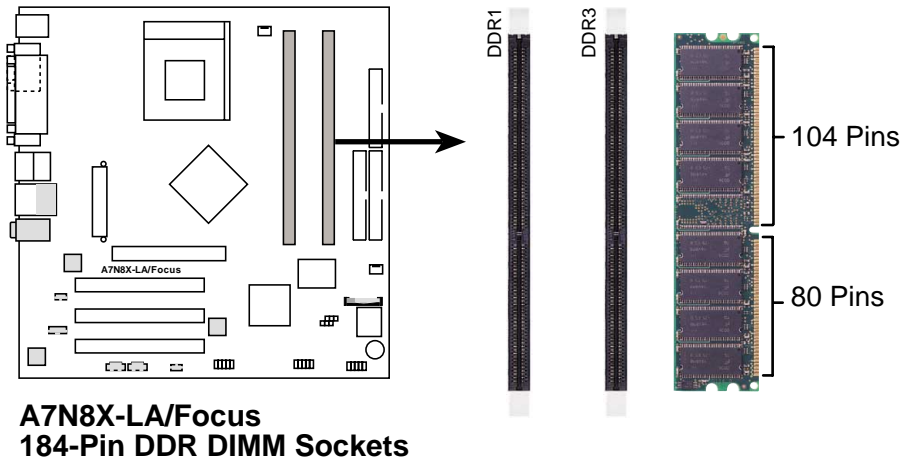

CAUTION: DIMMs are keyed to fit with only one direction. DO NOT force a DIMM into a socket to avoid damaging the DIMM.

Installing a DIMM

You may install 64MB, 128MB, 256MB, 512MB, and 1GB DDR DIMMs into the DIMM sockets using the memory configurations in this section.



Make sure to unplug the power supply before adding or removing DIMMs or other system components. Failure to do so may cause severe damage to both the motherboard and the components.

Follow these steps to install a DIMM.

1. Unlock a DIMM socket by pressing the retaining clips outward.
2. Align a DIMM on the socket such that the notch on the DIMM matches the break on the socket.
3. Firmly insert the DIMM into the socket until the retaining clips snap back in place and the DIMM is properly seated.

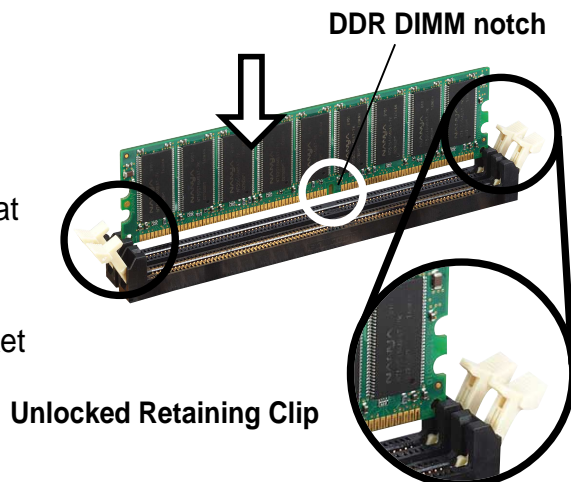

4. Expansion slots

The motherboard has three PCI slots and one Accelerated Graphics Port (AGP) slot.

To install and configure an expansion card:

1. Install an expansion card following the instructions that came with the chassis.
2. Turn on the system and change the necessary BIOS settings, if any.
3. Assign an IRQ to the card. Refer to the tables below.
4. Install the drivers and/or software applications for the expansion card according to the card documentation.

Standard interrupt assignments

IRQ	Priority	Standard Function
0	1	System Timer
1	2	Keyboard Controller
2	N/A	Programmable Interrupt
3*	11	Communications Port (COM2)
4*	12	Communications Port (COM1)
5*	13	Sound Card (sometimes LPT2)
6	14	Floppy Disk Controller
7*	15	Printer Port (LPT1)
8	3	System CMOS/Real Time Clock
9*	4	ACPI Mode when used
10*	5	IRQ holder for PCI steering
11*	6	IRQ holder for PCI steering
12*	7	PS/2 Compatible Mouse Port
13	8	Numeric Data Processor
14*	9	Primary IDE Channel
15*	10	Secondary IDE Channel

* These IRQs are usually available for ISA or PCI devices.

IRQ assignments for this motherboard

	A	B	C	D	E	F	G	H
PCI slot 1	shared							
PCI slot 2				used				
PCI slot 3			used					
AGP slot	shared							
Onboard USB controller 1								
Onboard LAN								
Onboard audio								
Onboard 1394 controller								

PCI slots

There are three (3) 32-bit PCI slots on this motherboard. The slots support PCI cards such as a LAN card, SCSI card, USB card, and other cards that comply with PCI specifications. The figure below shows a typical PCI card installed into a slot.

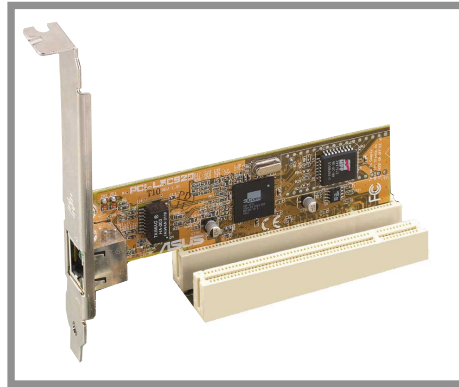

AGP slot

This motherboard has an Accelerated Graphics Port (AGP) slot that supports AGP 8X cards. When you buy an AGP card, make sure that you ask for one with +1.5V specification.

Note the notches on the card golden fingers to ensure that they fit the AGP slot on your motherboard.



Install only +1.5V AGP cards on this motherboard!

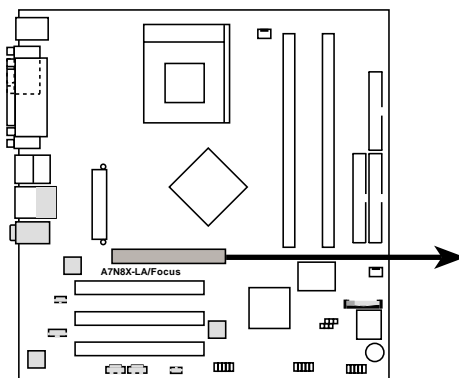

AGP Card without Retention Notch

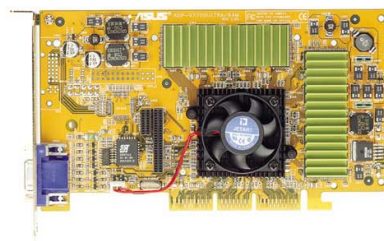

A7N8X-LA/Focus
Accelerated Graphics Port (AGP8X)

5. Jumpers

1. Clear RTC (3-pin CLRTC1)

This jumper allows you to clear the Real Time Clock (RTC) RAM in CMOS. You can clear the CMOS memory of date, time, and system setup parameters by erasing the CMOS RTC RAM data. The RAM data in CMOS, that include system setup information, is powered by the onboard button cell battery.

To erase the RTC RAM:

1. Turn OFF the computer and unplug the power cord.
2. Move the jumper cap from pins 1-2 (Default) to pins 2-3 (Clear CMOS). Keep the cap on pins 2-3 for about 5~10 seconds, then move the cap back to pins 1-2.
3. Plug the power cord and turn ON the computer.
4. Hold down the key during the boot process and enter BIOS setup to re-enter data.



Except when clearing the RTC RAM, never remove the jumper caps on default position. Removing the cap will cause system boot failure!

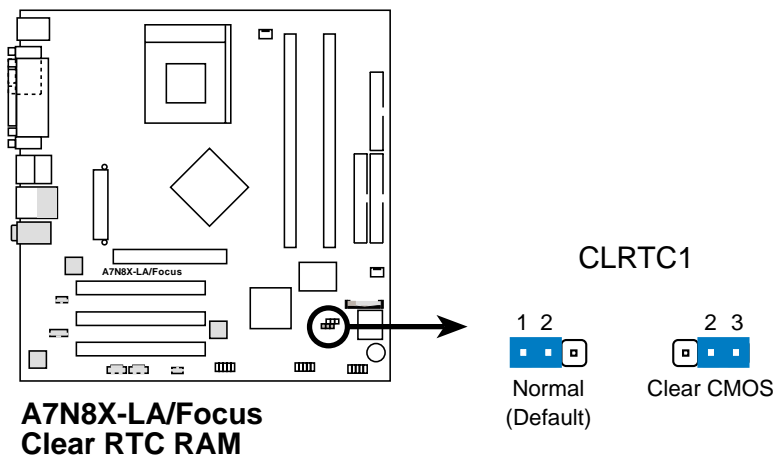

2. Clear Password (3-pin J11)

This jumper allows you to clear the password in CMOS. To erase the Password move the jumper cap from pins 1-2 (Default) to pins 2-3 (Clear Password). Keep the cap on pins 2-3 for about 5~10 seconds, then move the cap back to pins 1-2. Plug the power cord and turn ON the computer. Hold down the key during the boot process and enter BIOS setup to re-enter data.

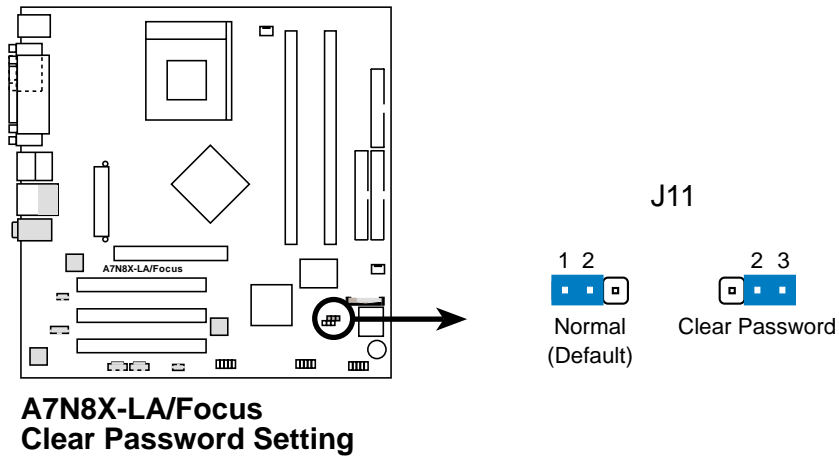

6. Connectors

This section describes and illustrates the internal connectors on the motherboard.

1. Floppy disk drive connector (34-1 pin FLOPPY1)

This connector supports the provided floppy drive ribbon cable. After connecting one end to the motherboard, connect the other end to the floppy drive. (Pin 5 is removed to prevent incorrect insertion when using ribbon cables with pin 5 plug).

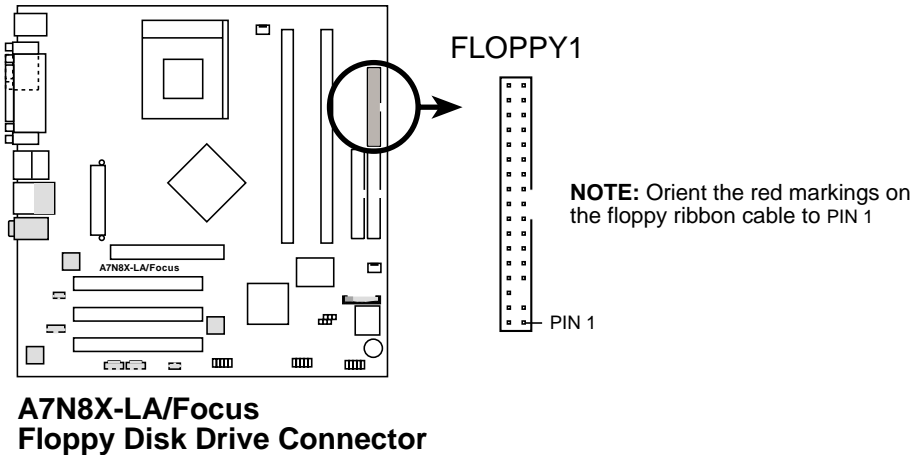

2. ATX power connectors (20-pin ATXPWR1)

These connectors connect to an ATX 12V power supply. The plugs from the power supply are designed to fit these connectors in only one orientation. Find the proper orientation and push down firmly until the connectors completely fit.



Make sure that your ATX 12V power supply can provide 8A on the +12V lead and at least 1A on the +5-volt standby lead (+5VSB). The minimum recommended wattage is 230W, or 300W for a fully configured system. The system may become unstable and may experience difficulty powering up if the power supply is inadequate.

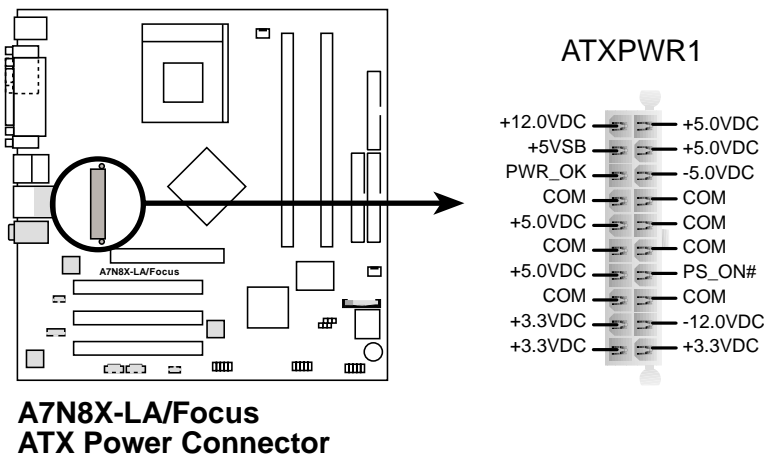

3. IDE connectors (40-1 pin IDE1, IDE2)

This connector supports the provided UltraDMA100/66/33 IDE hard disk ribbon cable. Connect the cable's blue connector to the primary (recommended) or secondary IDE connector, then connect the gray connector to the UltraDMA100/66/33 slave device (hard disk drive) and the black connector to the UltraDMA100/66/33 master device. It is recommended that you connect non-UltraDMA100/66/33 devices to the secondary IDE connector. If you install two hard disks, you must configure the second drive as a slave device by setting its jumper accordingly. Refer to the hard disk documentation for the jumper settings. BIOS supports specific device bootup. If you have more than two UltraDMA100/66/33 devices, purchase another UltraDMA100/66/33 cable. You may configure two hard disks to be both master devices with two ribbon cables – one for the primary IDE connector and another for the secondary IDE connector.



1. Pin 20 on each IDE connector is removed to match the covered hole on the UltraDMA cable connector. This prevents incorrect orientation when you connect the cables.
2. The hole near the blue connector on the UltraDMA100/66/33 cable is intentional.

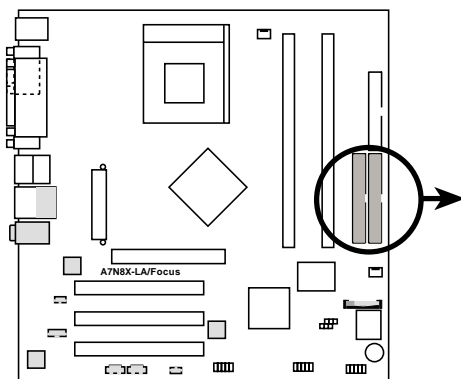

**A7N8X-LA/Focus
IDE Connectors**

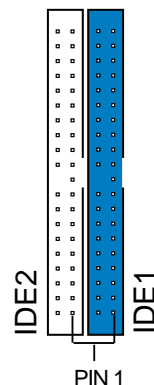

NOTE: Orient the red markings (usually zigzag) on the IDE ribbon cable to PIN 1.

4. CPU and Chassis Fan Connectors (3-pin CPU_FAN1, CHA_FAN1)

The fan connectors support cooling fans of 350mA~740mA (8.88W max.) or a total of 1A~2.22A (26.64W max.) at +12V. Connect the fan cables to the fan connectors on the motherboard, making sure that the black wire of each cable matches the ground pin of the connector.



Do not forget to connect the fan cables to the fan connectors. Lack of sufficient air flow within the system may damage the motherboard components. These are not jumpers! DO NOT place jumper caps on the fan connectors!

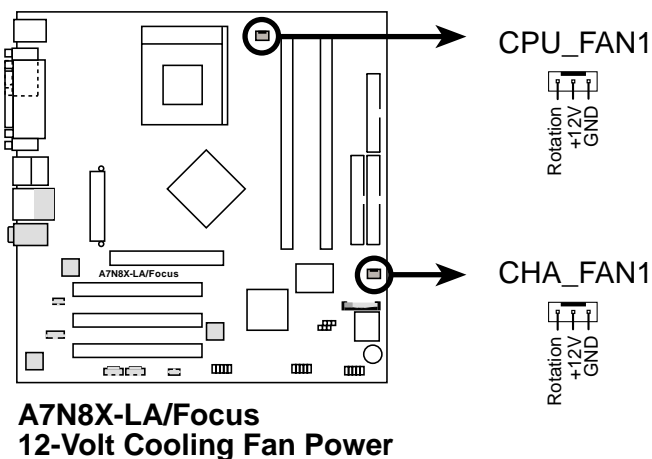

5. Internal audio connectors (4-pin CD1, AUX1)

These connectors allow you to receive stereo audio input from sound sources such as a CD-ROM, TV tuner, or MPEG card.

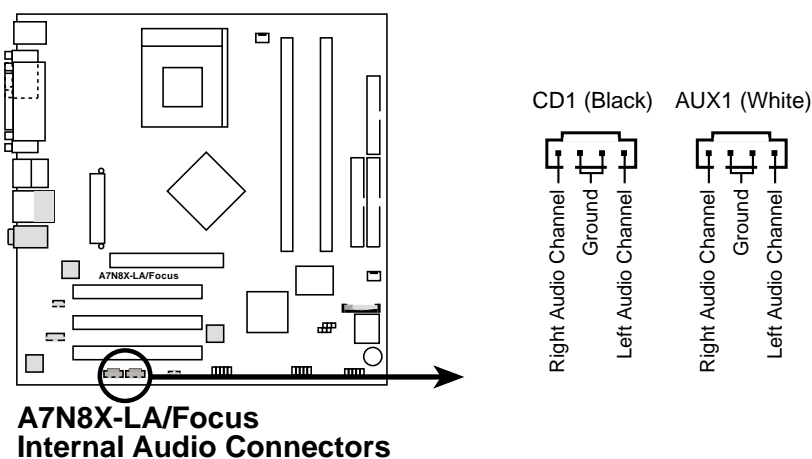

6. USB headers (10-1 pin USB56)

If the USB ports on the rear panel are inadequate, a USB header is available for additional USB ports. The USB header complies with USB 2.0 specification that supports up to 480 Mbps connection speed. This speed advantage over the conventional 12 Mbps on USB 1.1 allows faster Internet connection, interactive gaming, and simultaneous running of high-speed peripherals. You may connect a USB module to the USB header.



The USB module is purchased separately.

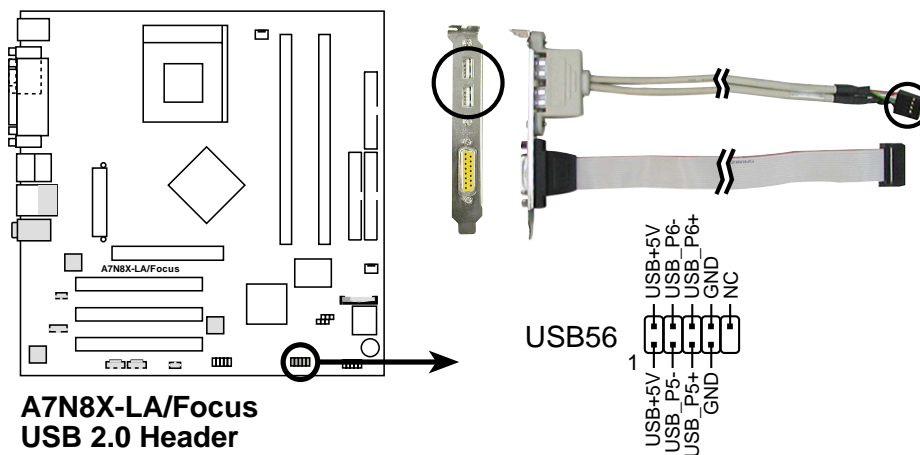

7. IEEE 1394 connector (10-1 pin IEEE1394_1)

This connector is for a 10-to-6-pin 1394 serial connector cable that connects to a 1394 module. Attach the 10-1 pin cable plug to this connector, and the 6-pin cable plug to the 1394 module. You may also connect a 1394-compliant internal hard disk to this connector.



NEVER connect a **USB cable** to any of the IEEE 1394 connectors. Doing so will damage the motherboard!

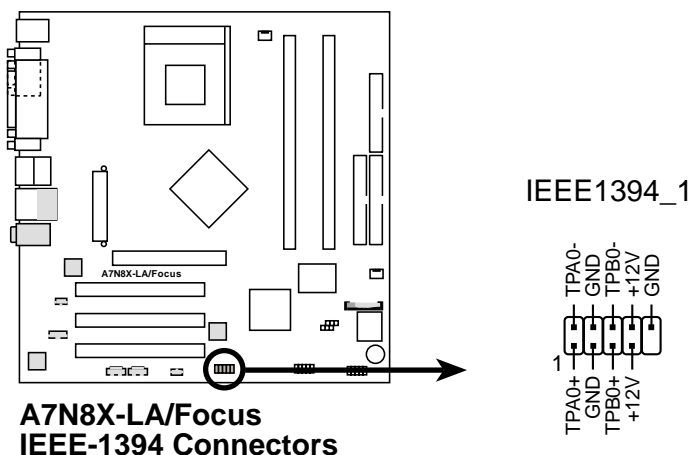

8. Front headphone connector (5-pin HJACK1)

This connector is for a chassis-mounted front panel headphone jack.

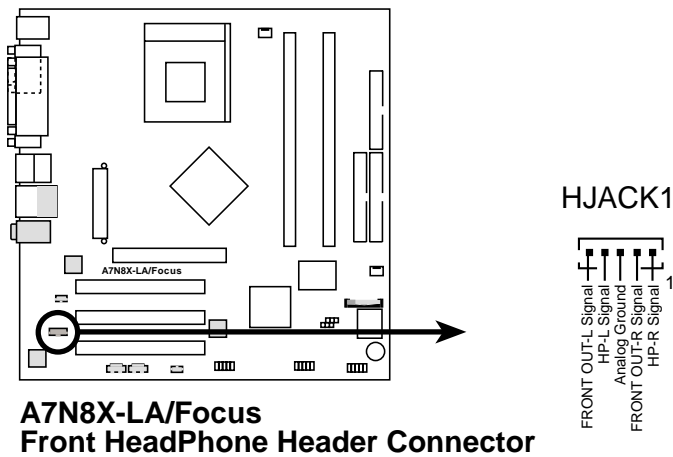

9. Front microphone connector (3-pin FP_MIC1)

This connector is for a chassis-mounted front panel microphone jack. Use a 3-pin audio cable to connect the microphone jack to this connector.

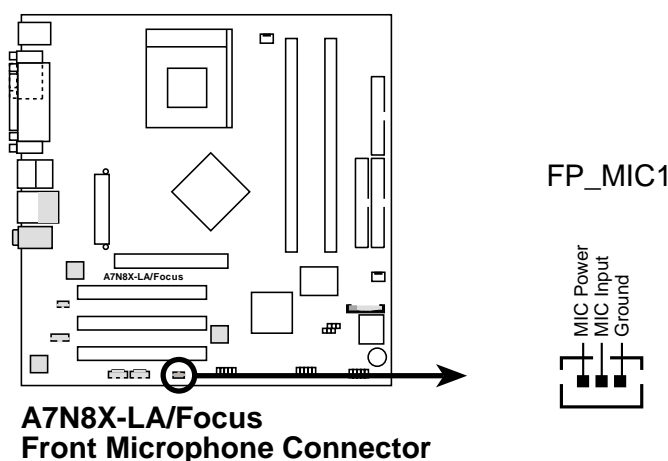

10. Digital audio connector (3-pin ASPDIF1)

This connector is for an S/PDIF audio module that allows digital instead of analog sound output. Connect one end of the audio cable to this connector and the other end to the S/PDIF module.

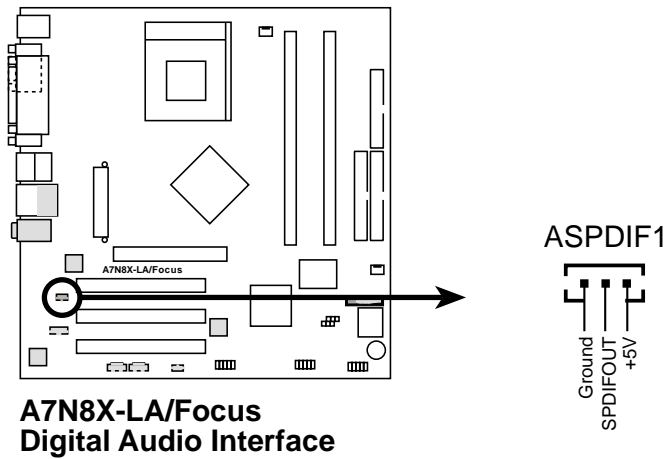

11. System panel connector (10-pin HPANEL)

This connector accommodates several system front panel functions.

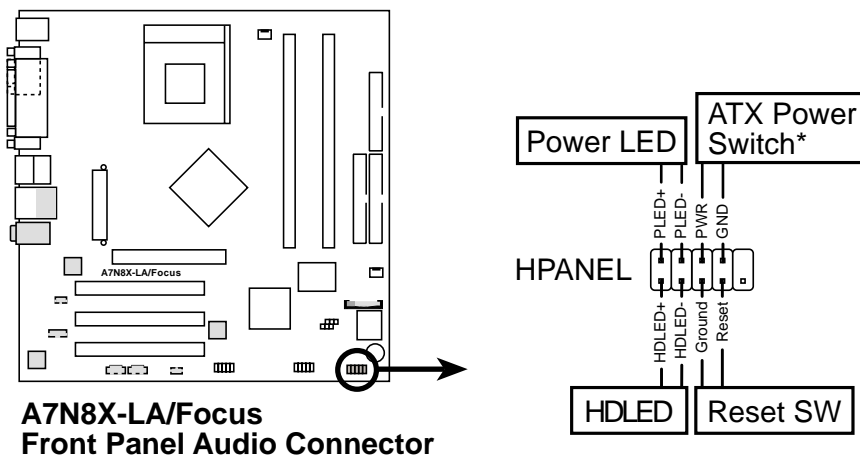

- **System Power LED Lead (2-pin PLED)**

This 3-1 pin connector connects to the system power LED. The LED lights up when you turn on the system power, and blinks when the system is in sleep mode.

- **Hard Disk Activity LED Lead (2-pin HDLED)**

This 2-pin connector is for the HDD LED cable. The read or write activities of the device connected to the any of IDE connectors cause the IDE LED to light up.

- **ATX Power Switch / Soft-Off Switch Lead (2-pin PWR)**

This connector connects a switch that controls the system power. Pressing the power switch turns the system between ON and SLEEP, or ON and SOFT OFF, depending on the BIOS or OS settings. Pressing the power switch while in the ON mode for more than 4 seconds turns the system OFF.

- **Reset Switch Lead (2-pin RESET)**

This 2-pin connector connects to the case-mounted reset switch for rebooting the system without turning off the system power.

Free Manuals Download Website

<http://myh66.com>

<http://usermanuals.us>

<http://www.somanuals.com>

<http://www.4manuals.cc>

<http://www.manual-lib.com>

<http://www.404manual.com>

<http://www.luxmanual.com>

<http://aubethermostatmanual.com>

Golf course search by state

<http://golfingnear.com>

Email search by domain

<http://emailbydomain.com>

Auto manuals search

<http://auto.somanuals.com>

TV manuals search

<http://tv.somanuals.com>