

NEW GENERATIONS

ASSA[®]

High Security Locks



We secure the world

ASSA® Twin V-10, Twin Exclusive and Twin Pro High Security Cylinders

The ASSA Twin family of cylinders and keyblanks were developed for a new generation of lock technology. Most conventional cylinders can be manipulated or defeated by force. Many cylinders marketed as "high security" have no patents protecting the keys and/or cylinder and therefore, no method for key blank control. The ASSA Twin family meets all of today's demanding requirements of high security cylinders—uncompromising physical security and patented key control.

Physical Security

All Twin family cylinders are built to U.L. 437 standards, a set of tests for determining the cylinder's physical resistance against various forms of attack. Two independent locking mechanisms ensure optimum pick resistance. Inactive "false" grooves in the side pins catch the side bar when improperly positioned. When rotational force is applied to pick the lock, the spooled driver pin tumblers, close tolerances, and counter-milled pin chambers protect the cylinder from virtually every known picking method.

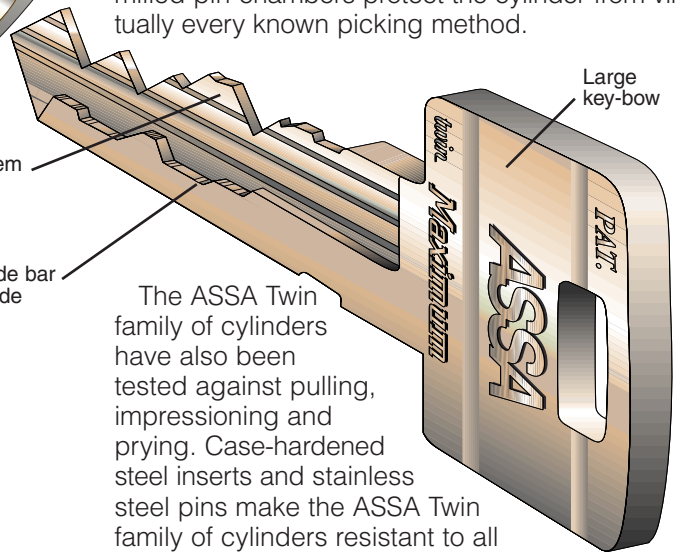
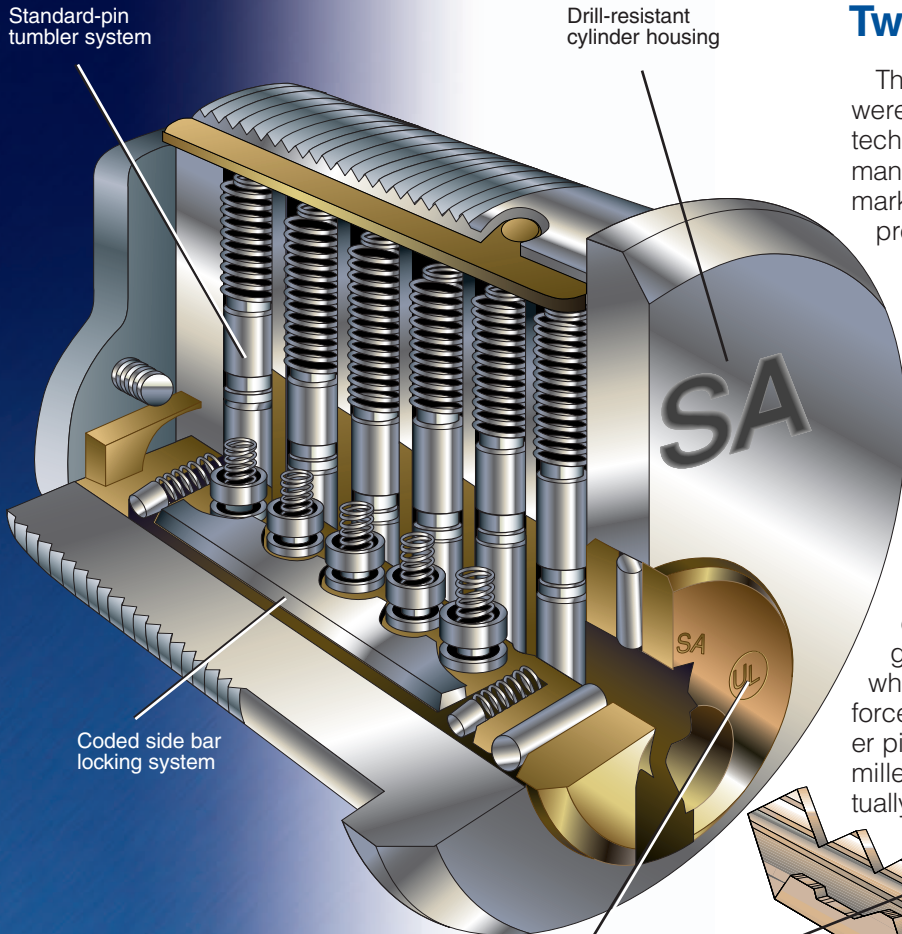

The ASSA Twin family of cylinders have also been tested against pulling, impressioning and prying. Case-hardened steel inserts and stainless steel pins make the ASSA Twin family of cylinders resistant to all types of drilling attack.

Key Control

Precision crafted for the highest security, the ASSA Twin series key has two sets of bittings (or key cuts) to operate independent double locking mechanisms. Each key, reinforced to help eliminate breakage, has a rounded back for smooth operation and minimal wear. The enlarged key bow accommodates use by manually impaired people.

Patented in the U.S. and internationally, the innovative ASSA key design eliminates unauthorized key duplication and maintains a key control system that is unmatched in the industry. For local, regional or national key control, the ASSA Twin family of cylinders provide proprietary keyways for any facility.

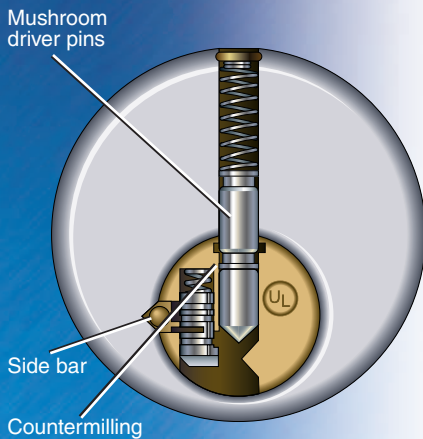

Drill-resistant cylinder plug

No key inserted:

- Standard pins block the shear line.
- Side bar rests in groove of cylinder housing, blocking movement of plug.

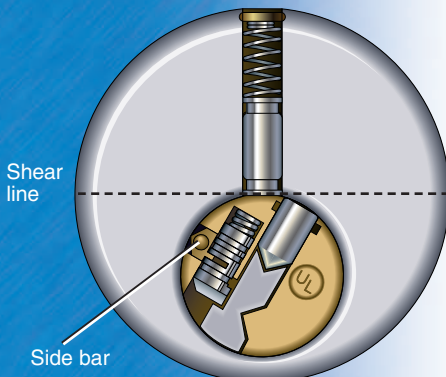

Correct key inserted:

- System code of key lifts standard pins to shear line.
- Side bar code of key lifts side pins into a position where the side bar can be received. Side bar then recesses into plug as key is turned.

High Security Cylinders For Demanding Applications

Mortise and Rim Cylinders

ASSA Twin V-10, Twin Exclusive, Twin Pro and Twin Maximum mortise and rim cylinders are designed to replace original cylinders in many types of common locks. Made to standard dimensions and available in a variety of finishes, these reliable cylinders withstand even the heaviest usage.

Mortise cylinders will improve the security of locks installed in aluminum storefront doors as well as standard mortise locks by Arrow, Corbin/Russwin, Sargent, Schlage, Yale and many other manufacturers. These mortise cylinders can also be applied to a wide variety of special locking devices including detention hardware.

Commonly used on apartment and condominium doors, rim-type Twin series cylinders are used on vertical deadbolt locks and are also designed for commercial exit and panic devices.



Mortise and Rim Type Cylinders



Key-in-Knob / Key-in-Lever Cylinders



High Security Deadbolts



Padlocks

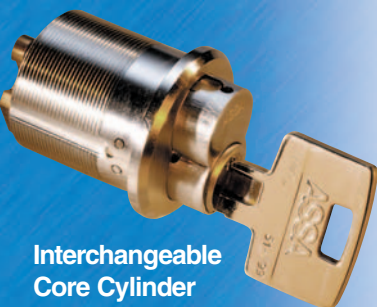

Interchangeable Core Cylinder

Key-In-Knob Cylinders/Key-In-Lever Cylinders

Knob and lever locks by Arrow, Corbin/Russwin, Sargent, Schlage, Yale and other manufacturers can be retrofitted with ASSA Twin series high security cylinders. To improve key control, the original cylinder can be switched without incurring the entire lock replacement cost.

High Security Deadbolts

ASSA Twin V-10, Twin Exclusive, Twin Pro and Twin Maximum deadbolt locks can be used to replace existing deadbolts or improve security on other doors. ASSA grade 1 deadbolts are U.L. 437 listed, providing superior resistance against physical attack. Available in double cylinder and single cylinder with inside thumb turn, the two types of bolts, mortise and drive in, simplify installation in either wood or metal doors. The ASSA deadbolt is also available in a single cylinder with no inside thumb turn for special requirements commonly used in detention facilities.

Padlocks

Providing independent security on gates, machines, and vehicles, various grades of ASSA padlocks expand the application of master key systems. Case-hardened shackles and ball-locking mechanisms are housed in brass or steel bodies.

Re-keyable padlocks offer the same high standards of key control and pick and drill resistance common to all ASSA Twin products.

Interchangeable Core Cylinder

Addressing the three major security concerns of today's business owners and security directors, the ASSA Interchangeable Core Cylinder provides security and the ability to re-key instantly.

Today's single most violated security policy, key duplication, is controlled with patent-protected key blanks and geographic proprietary keyways. The ASSA IC physical security is strengthened with strategically placed, case-hardened drill inserts. Two independent locking mechanisms within each cylinder render the cylinder virtually pick-proof. ASSA IC is also listed by Underwriters Laboratories and has passed the U.L. 437 test.

By simply changing or reversing the ASSA IC sidebar, cylinder re-keying can be done on-site in less than 30 seconds. Therefore, the end-user is not required to stock or purchase additional spare cores.

ASSA CLIQ™ Concept 4

ASSA CLIQ™ intelligent locking systems gives control over all keys, which can easily be upgraded and can be tailor-made to suit any needs. Since every key has its own identity, it becomes the "personal property" of the key holder. CLIQ makes intelligent, flexible and high security lock systems possible. The key's mechanical design creates the basic foundation made up of different security zones in the same way as in mechanical lock systems. The electronic programming of the keys gives authorization to individuals or to group of individuals. CLIQ technology's basic idea is the creation of an intelligent security system. That means a lock system that retains a high level of security despite upgrading, alterations or expansion. Even after many years of use by a continual flow of new tenants, new employees or changes occurring in the workplace, the level of security will remain the same.

ASSA[®]

CLIQ™ **4** Technology
 Concept 4



Unparalleled Key Control For Today's Industry

Over the past twenty years, high security cylinder needs have changed from an emphasis on pick resistance to maximum key control for the cylinder locks. In the past, many lock manufacturers addressed only pick and drill resistance for patent purposes. The ASSA Twin V-10, Twin Exclusive and Twin Pro carry patents to protect both the key and cylinder. This additional protection is easy to obtain with ASSA's Twin family of cylinders that upgrade existing cylinders to a new level of security.

Today's Technology

Once a cylinder is patented, the high security status of that cylinder is merely conjectural until it passes the widely accepted tests to qualify the cylinder as listed under U.L. 437. ASSA believes these tests and listings are paramount in security of the cylinder, therefore, all our Twin series high security cylinders are U.L. 437 listed.

The ASSA Twin series high security cylinder was designed with key control in mind. Each side bar contains a code and is combined by its matching key. Available in multitude for a given key profile, the side bar codes are milled on the lower portion of the key and are precut at the ASSA factory.

Each side bar code represents a unique key section and unlimited key sections and levels of control. The result is unparalleled key control and the ability to meet our customers' demands for highly restricted or proprietary key sections.

We meet even more demands with the Twin Exclusive series upgrade available in 851, 852 and 862 profiles. The Twin Exclusive series is a direct upgrade to the existing Twin 6000 series. The new key profiles will bypass and integrate with corresponding 51, 52 and 62 cylinder plug broaching. ASSA is the answer for cost-effective, technically advanced security.



The Baltimore Ravens Stadium
Baltimore, Maryland



The Desert Samaritan Medical Center
Phoenix, Arizona



The Evergreen State College
Olympia, Washington

Proprietary Keyways

In today's world, security is a demanding priority. Accepted key control methods from the past with "shared geographical key sections" no longer meet the needs of security in any industry.

To meet those needs, ASSA has created the latest in physical security and key control with the Twin V-10, Twin Exclusive and Twin Pro and Twin Maximum high security cylinders. To eliminate unauthorized key duplication, the Twin family of cylinders features patented, geographically exclusive keyways. Computerized biting charts and keyway control audits assure each user of an ASSA master key system that is unique to their facility. Sectional keyways are available for the ASSA V-10 Twin series within the side cut configuration. This allows one key to operate multiple master key systems while segregating various areas within the same facility, for the ultimate in key control security.

The ASSA Twin Maximum is the newest Twin product series. A Mechanical cylinder launching in 2006 that can be integrated by the ASSA CLIQ electro mechanical key as one credential that will access both the electro mechanical CLIQ cylinder as well as the Twin Maximum mechanical cylinder. National keyways can be obtained through a written agreement with ASSA for guaranteed exclusivity.

These advanced security control systems have been proven successful for industry and businesses throughout the world. After experiencing major key control problems, firms not using ASSA have recognized the benefits of our system design and cost-efficiency, as ASSA also manufactures retrofit cylinders for each company's existing lock sets.

ASSA meets and exceeds tough demands on security through in-house or authorized locksmiths, or indirect factory service. Today's facilities look to ASSA for all their security needs for this generation and beyond.

Factory-Generated Master Key Systems

ASSA can provide computer-generated biting charts, custom-designed for each facility's individual requirements. Systems are provided on IBM-compatible disk or printed. Full expansion for each system is also available. With over 160,000 change keys available under a single master key, ASSA can meet the master key system demands of virtually any end-user's needs.

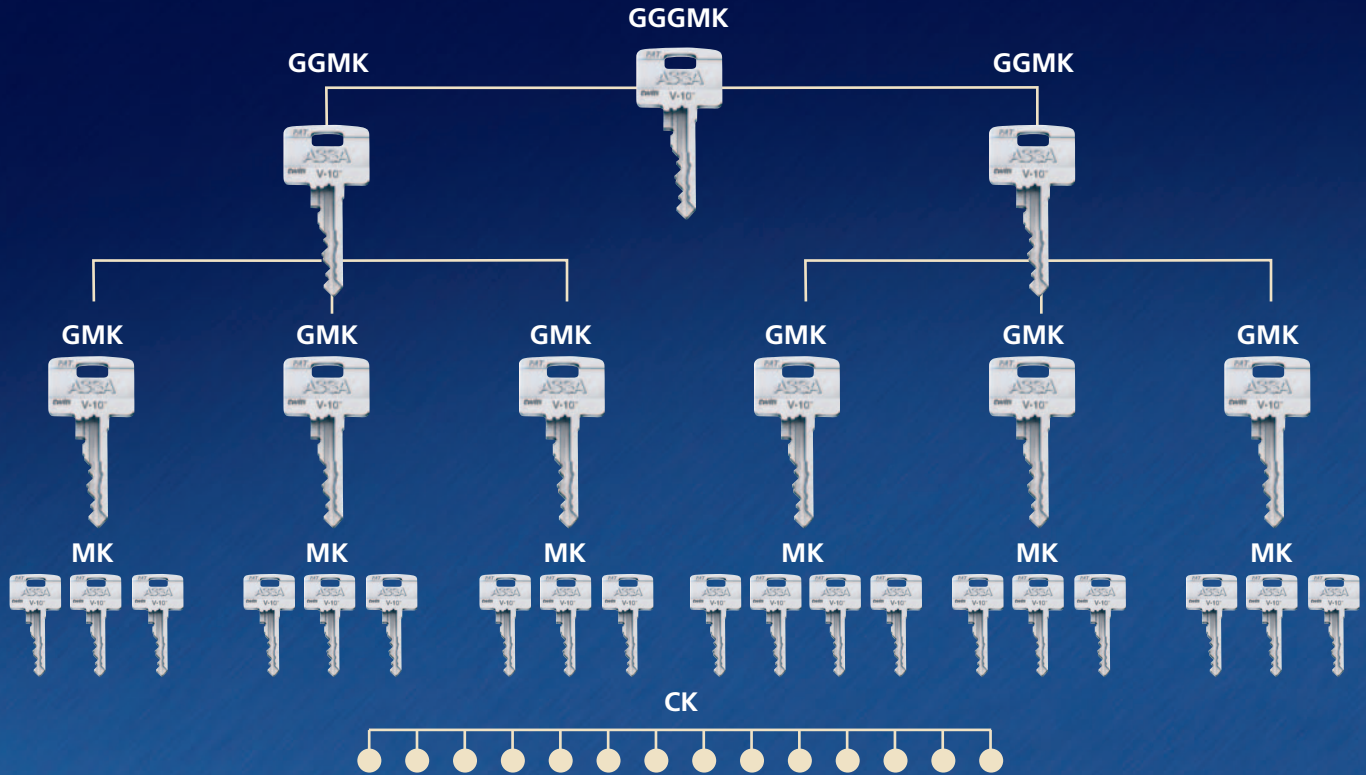

ANSI Model and CLIQ™

Grand Master Keys

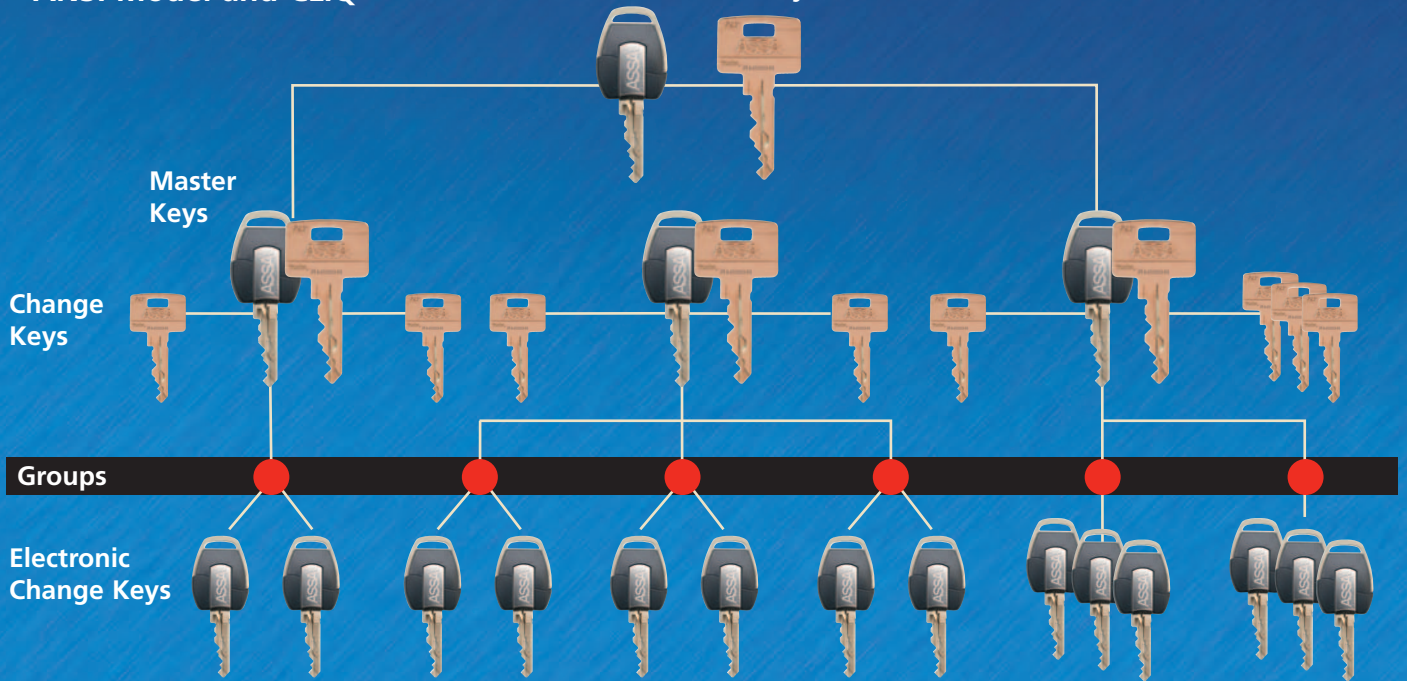

ASSA, Inc. • 110 Sargent Drive • P.O. Box 9453 • New Haven • CT 06534-0453
 Phone: 800-235-7482 • Fax: 800-892-3256 • Website: www.assalock.com

ASSA, Canada • 3475 14th Avenue • Markham, Ontario L3R 0H4 • Phone: 905 940-2040 • Fax: 905 940-3242

Free Manuals Download Website

<http://myh66.com>

<http://usermanuals.us>

<http://www.somanuals.com>

<http://www.4manuals.cc>

<http://www.manual-lib.com>

<http://www.404manual.com>

<http://www.luxmanual.com>

<http://aubethermostatmanual.com>

Golf course search by state

<http://golfingnear.com>

Email search by domain

<http://emailbydomain.com>

Auto manuals search

<http://auto.somanuals.com>

TV manuals search

<http://tv.somanuals.com>