



**KVM Over the NET™**  
**KN2124v / KN2140v / KN4124v / KN4140v**  
**KN2116A / KN2132 / KN4116 / KN4132**

**User Manual**



[www.aten.com](http://www.aten.com)

## FCC Information

This is an FCC Class A product. In a domestic environment this product may cause radio interference in which case the user may be required to take adequate measures.

This equipment has been tested and found to comply with the limits for a Class A digital device, pursuant to Part 15 of the FCC Rules. These limits are designed to provide reasonable protection against harmful interference when the equipment is operated in a commercial environment. This equipment generates, uses and can radiate radio frequency energy and, if not installed and used in accordance with the instruction manual, may cause harmful interference to radio communications. Operation of this equipment in a residential area is likely to cause harmful interference in which case the user will be required to correct the interference at his own expense.

## RoHS

This product is RoHS compliant.

## SJ/T 11364-2006

The following contains information that relates to China.

部件名称	有毒有害物质或元素					
	铅	汞	镉	六价铬	多溴联苯	多溴二苯醚
电器部件	●	○	○	○	○	○
机构部件	○	○	○	○	○	○

- : 表示该有毒有害物质在该部件所有均质材料中的含量均在SJ/T 11363-2006规定的限量要求之下。
- : 表示符合欧盟的豁免条款, 但该有毒有害物质至少在该部件的某一均质材料中的含量超出SJ/T 11363-2006的限量要求。
- ×: 表示该有毒有害物质至少在该部件的某一均质材料中的含量超出SJ/T 11363-2006的限量要求。



## User Information

---

### Online Registration

Be sure to register your product at our online support center:

International	<a href="http://support.aten.com">http://support.aten.com</a>
North America	<a href="http://www.aten-usa.com/product_registration">http://www.aten-usa.com/product_registration</a>

### Telephone Support

For telephone support, call this number:

International		886-2-8692-6959
China		86-10-5160-1602
Japan		81-3-5323-7178
Korea		82-2-467-6789
North America	ATEN TECH	1-888-999-ATEN
	ATEN NJ	1-732-356-1703
United Kingdom		44-8-4481-58923

### User Notice

All information, documentation, and specifications contained in this manual are subject to change without prior notification by the manufacturer. The manufacturer makes no representations or warranties, either expressed or implied, with respect to the contents hereof and specifically disclaims any warranties as to merchantability or fitness for any particular purpose. Any of the manufacturer's software described in this manual is sold or licensed *as is*. Should the programs prove defective following their purchase, the buyer (and not the manufacturer, its distributor, or its dealer), assumes the entire cost of all necessary servicing, repair and any incidental or consequential damages resulting from any defect in the software.

The manufacturer of this system is not responsible for any radio and/or TV interference caused by unauthorized modifications to this device. It is the responsibility of the user to correct such interference.

The manufacturer is not responsible for any damage incurred in the operation of this system if the correct operational voltage setting was not selected prior to operation. PLEASE VERIFY THAT THE VOLTAGE SETTING IS CORRECT BEFORE USE.

## Package Contents

---

The KVM Over the NET™ switch package consists of:

- 1 KN2124v, KN2140v, KN4124v, KN4140v, KN2116A, KN2132, KN4116, or KN4132 KVM Over the Net™ Switch
- 2 SA0142 Serial Adapters (RJ45-F to DB9-M; DTE to DCE)
- 1 Grounding Wire
- 1 Power Cord (KN2116A / KN4116 / KN2132 / KN4132 only)
- 2 Power Cords (KN2124v / KN2140v / KN4124v / KN4140v only)
- 2 Utility Power Cords (KN2124v / KN2140v / KN4124v / KN4140v only)
- 1 5-in-1 Console Cable (KN2124v / KN2140v / KN4124v / KN4140v only)
- 1 Rack Mount Kit
- 1 Foot Pad Set (4 pcs.)
- 1 User Manual\*
- 1 Quick Start Guide

Check to make sure that all of the components are present and in good order. If anything is missing, or was damaged in shipping, contact your dealer.

Read this manual thoroughly and follow the installation and operation procedures carefully to prevent any damage to the switch or to any other devices on the installation.

---

\* Features may have been added since this manual was printed. Please visit our website to download the most up to date version of the manual.

---

Copyright © 2006–2009 ATEN® International Co., Ltd.  
Manual Part No. PAPE-0296-AX4G  
F/W Version: 1.1.108  
Manual Date: 2010-01-12

Altusen and the Altusen logo are registered trademarks of ATEN International Co., Ltd. All rights reserved.  
All other brand names and trademarks are the registered property of their respective owners.



# Contents

---

FCC Information . . . . .	ii
SJ/T 11364-2006 . . . . .	ii
User Information . . . . .	iii
Online Registration . . . . .	iii
Telephone Support . . . . .	iii
User Notice . . . . .	iii
Package Contents . . . . .	iv
About This Manual . . . . .	xiii
Overview . . . . .	xiii
Conventions . . . . .	xiv
Terminology . . . . .	xv
Product Information . . . . .	xv

## **Chapter 1.** **Introduction**

Overview . . . . .	1
Features . . . . .	4
Hardware . . . . .	4
Management . . . . .	4
Ease-to-Use Interface . . . . .	5
Advanced Security . . . . .	5
Virtual Media . . . . .	6
Virtual Remote Desktop . . . . .	6
V-Series Exclusive . . . . .	6
System Requirements . . . . .	7
Remote User Computers . . . . .	7
Servers . . . . .	7
Video . . . . .	8
KVM Adapter Cables . . . . .	8
Operating Systems . . . . .	9
Browsers . . . . .	9
Components . . . . .	10
KN2124v / KN2140v / KN4124v / KN4140v Front View . . . . .	10
KN2116A / KN2132 / KN4116 / KN4132 Front View . . . . .	10
KN2124v / KN2140v / KN4124v / KN4140v Rear View . . . . .	12
KN2116A / KN2132 / KN4116 / KN4132 Rear View . . . . .	12

## **Chapter 2.** **Hardware Setup**

Overview . . . . .	15
Before You Begin . . . . .	15

Stacking and Rack Mounting . . . . .	16
Stacking . . . . .	16
Rack Mounting . . . . .	17
Rack Mounting - Front . . . . .	17
Rack Mounting - Rear . . . . .	19
Single Stage Installation . . . . .	21
KN2124v / KN2140v / KN4124v / KN4140v	
Single Stage Installation Diagram . . . . .	23
KN2116A / KN2132 / KN4116 / KN4132	
Single Stage Installation Diagram . . . . .	24
Adapter Cable Connection Diagram . . . . .	25
Two Stage Installation . . . . .	26
Two Stage Installation Diagram . . . . .	27
Hot Plugging . . . . .	28
The Adapter ID Function . . . . .	28
Powering Off and Restarting . . . . .	28
Port ID Numbering . . . . .	29
Port Selection . . . . .	29

### **Chapter 3.**

#### **Super Administrator Setup**

Overview . . . . .	31
First Time Setup . . . . .	31
Network Setup . . . . .	33
Changing the Super Administrator Login . . . . .	34
Moving On . . . . .	36

### **Chapter 4.**

#### **Logging In**

Overview . . . . .	37
Local Console Login . . . . .	37
Browser Login . . . . .	38
WinClient AP Login . . . . .	39
The Connection Screen . . . . .	40
The File Menu . . . . .	41
Java Client AP Login . . . . .	42

### **Chapter 5.**

#### **The User Interface**

The Web Browser Main Page . . . . .	45
Page Components . . . . .	46
The Tab Bar . . . . .	47
The GUI Main Page . . . . .	48
The Local Console GUI Main Page . . . . .	50
The Control Panel . . . . .	51
WinClient Control Panel . . . . .	51
WinClient Control Panel Functions . . . . .	53

Macros . . . . .	55
Hotkeys . . . . .	55
User Macros . . . . .	57
System Macros . . . . .	61
Video Settings . . . . .	64
Gamma Adjustment . . . . .	66
The Message Board . . . . .	67
Button Bar . . . . .	68
Message Display Panel . . . . .	68
Compose Panel . . . . .	68
User List Panel . . . . .	69
Virtual Media . . . . .	70
Virtual Media Icons . . . . .	72
Zoom . . . . .	73
The On-Screen Keyboard . . . . .	74
Mouse Pointer Type . . . . .	75
Mouse DynaSync Mode . . . . .	76
Automatic Mouse Synchronization (DynaSync) . . . . .	76
Mac and Linux Considerations . . . . .	77
Manual Mouse Synchronization . . . . .	77
Control Panel Configuration . . . . .	78
The Java Control Panel . . . . .	80

## **Chapter 6.**

### **Port Access**

Overview . . . . .	81
Web Browser Interface . . . . .	81
GUI Interface . . . . .	81
The Port Selection Sidebar . . . . .	83
The Port Selection Tree . . . . .	83
Port Views . . . . .	84
Port Utilities . . . . .	84
Port Properties . . . . .	86
Port Naming . . . . .	88
Scan . . . . .	89
Array . . . . .	89
Filter . . . . .	90
Connections . . . . .	91
Device Level . . . . .	91
Port Level . . . . .	92
History . . . . .	93
Favorites . . . . .	94
Adding a Favorite . . . . .	94
Modifying a Favorite . . . . .	95
User Preferences . . . . .	96

Log . . . . .	98
Filter . . . . .	99
Sessions . . . . .	100
Access . . . . .	101
Device Level . . . . .	101
Port Level . . . . .	102
The Status Panel . . . . .	103
The Properties Panel . . . . .	103
Saving Changes . . . . .	103

## **Chapter 7.** **User Management**

Overview . . . . .	105
Web Browser Interface . . . . .	105
GUI Interface . . . . .	105
Users . . . . .	107
Adding Users . . . . .	107
Modifying User Accounts . . . . .	110
Deleting User Accounts . . . . .	110
Groups . . . . .	111
Creating Groups . . . . .	111
Modifying Groups . . . . .	113
Deleting Groups . . . . .	113
Users and Groups . . . . .	114
Assigning Users to a Group From the User's Notebook . . . . .	114
Removing Users From a Group From the User's Notebook . . . . .	115
Assigning Users to a Group From the Group's Notebook . . . . .	116
Removing Users From a Group From the Group's Notebook . . . . .	117
Device Assignment . . . . .	118
Assigning Device Permissions From the User's Notebook . . . . .	118
Filters . . . . .	120
Assigning Device Permissions From the Groups' Notebook . . . . .	120

## **Chapter 8.** **Device Management**

Overview . . . . .	121
Web Browser Interface . . . . .	121
GUI Interface . . . . .	121
Device Information . . . . .	122
Network . . . . .	124
Service Ports . . . . .	125
NIC Settings . . . . .	126
Redundant NIC . . . . .	126
IP Address . . . . .	127
DNS Server . . . . .	127
Network Transfer Rate . . . . .	127
Finishing Up . . . . .	127

ANMS	128
IP Installer	129
SMTP Settings	129
Log Server	130
SNMP Settings	130
Syslog Server	130
Disable Local Authentication	130
RADIUS Settings	131
LDAP / LDAPS Authentication and Authorization Settings	132
CC Management Settings	132
OABC	133
Security	134
IP and MAC Filtering	135
Adding Filters	135
Modifying Filters	135
Deleting Filters	136
Login String	136
Account Policy	136
Encryption	137
Private Certificate	137
Generating a Self-Signed Certificate	137
Obtaining a CA Signed SSL Server Certificate	137
Importing the Private Certificate	137
Customization	138
Login Failures	138
Working Mode	139
Miscellaneous	140
Adapter Attributes	140
Reset on Exit	141
Date/Time	142
Time Zone	142
Date	143
Network Time	143

## **Chapter 9.**

### **Maintenance**

Overview	145
Web Browser Interface	145
GUI Interface	145
Page Layout	146
Firmware File	146
Options	146
The Main Panel	147
Upgrading the Main Firmware	148
Adapter Firmware Upgrade	149
Firmware Upgrade Recovery	150

Adapter Cable Firmware Upgrade Recovery . . . . .	150
Backup/Restore . . . . .	151
Backup . . . . .	151
Restore . . . . .	152

## **Chapter 10.**

### **Download**

Overview . . . . .	153
--------------------	-----

## **Chapter 11.**

### **Port Operation**

Overview . . . . .	155
The Port Toolbar . . . . .	156
The Toolbar Icons . . . . .	157
Toolbar Hotkey Port Switching . . . . .	158
Auto Scanning . . . . .	158
Setting the Scan Interval: . . . . .	158
Invoking Auto Scan . . . . .	158
Pausing Auto Scan . . . . .	159
Exiting Auto Scan . . . . .	159
Skip Mode . . . . .	159
Recalling the Port Access Page . . . . .	160
OSD Hotkey Summary Table . . . . .	160
Panel Array Mode . . . . .	161
Panel Array Toolbar . . . . .	162
Multuser Operation . . . . .	163
Users and Buses . . . . .	164

## **Chapter 12.**

### **The Log Server**

Installation . . . . .	165
Starting Up . . . . .	166
The Menu Bar . . . . .	167
Configure . . . . .	167
Events . . . . .	168
Search: . . . . .	168
Maintenance: . . . . .	169
Options . . . . .	170
Help . . . . .	170
The Log Server Main Screen . . . . .	171
Overview . . . . .	171
The List Panel . . . . .	172
The Event Panel . . . . .	172

## **Chapter 13.**

### **LDAP Server Configuration**

Introduction . . . . .	173
Install the Windows 2003 Support Tools . . . . .	173

Install the Active Directory Schema Snap-in . . . . .	174
Create a Start Menu Shortcut Entry . . . . .	174
Extend and Update the Active Directory Schema . . . . .	175
Creating a New Attribute . . . . .	175
Extending the Object Class With the New Attribute . . . . .	177
Editing Active Directory Users . . . . .	179
OpenLDAP . . . . .	182
OpenLDAP Server Installation . . . . .	182
OpenLDAP Server Configuration . . . . .	183
Starting the OpenLDAP Server . . . . .	184
Customizing the OpenLDAP Schema . . . . .	185
LDAP DIT Design and LDIF File . . . . .	186
LDAP Data Structure . . . . .	186
DIT Creation . . . . .	187
Using the New Schema . . . . .	188

## Appendix

Safety Instructions . . . . .	189
General . . . . .	189
Rack Mounting . . . . .	191
Technical Support . . . . .	192
International . . . . .	192
North America . . . . .	192
Specifications . . . . .	193
KN2124v / KN4124v . . . . .	193
KN2140v / KN4140v . . . . .	194
KN2116A / KN4116 . . . . .	195
KN2132 / KN4132 . . . . .	196
Troubleshooting . . . . .	197
General Operation . . . . .	197
Mouse Problems . . . . .	199
Virtual Media . . . . .	201
Web Browser . . . . .	201
The WinClient ActiveX Viewer and the WinClient AP . . . . .	202
The Java Applet and Java Client AP . . . . .	203
Sun Systems . . . . .	204
Mac Systems . . . . .	204
Redhat Systems . . . . .	205
The Log Server . . . . .	205
Panel -Array Mode . . . . .	205
IP Address Determination . . . . .	208
The Local Console . . . . .	208
IP Installer . . . . .	208
Browser . . . . .	209
Port Forwarding . . . . .	210
Keyboard Emulation . . . . .	211
PPP Modem Operation . . . . .	212

Basic Setup . . . . .	212
Connection Setup Example (Windows XP) . . . . .	213
KA7140 Configuration and Operation . . . . .	214
Configuration . . . . .	214
Operation . . . . .	215
KA7140 Pin Assignments . . . . .	215
Additional Mouse Synchronization Procedures . . . . .	216
Windows: . . . . .	216
Sun / Linux . . . . .	217
Additional Video Resolution Procedures . . . . .	218
Trusted Certificates . . . . .	219
Overview . . . . .	219
Installing the Certificate . . . . .	220
Certificate Trusted . . . . .	221
Mismatch Considerations . . . . .	222
Self-Signed Private Certificates . . . . .	223
Examples . . . . .	223
Importing the Files . . . . .	223
Fan Location and Speed Information . . . . .	224
Fan Location . . . . .	224
Fan Speed . . . . .	224
Temperature Sensor Location and Information . . . . .	225
Clear Login Information . . . . .	226
Factory Default Settings . . . . .	227
Serial Adapter Pin Assignments . . . . .	227
Supported KVM Switches . . . . .	228
Virtual Media Support . . . . .	229
WinClient ActiveX Viewer / WinClient AP . . . . .	229
Java Applet Viewer / Java Client AP . . . . .	229
Limited Warranty . . . . .	230



## About This Manual

---

This User Manual is provided to help you get the most from your KVM Over the NET™ system. It covers all aspects of installation, configuration and operation. An overview of the information found in the manual is provided below.

### Overview

**Chapter 1, Introduction**, introduces you to the KN2124v / KN2140v / KN4124v / KN4140v / KN2116A / KN2132 / KN4116 / KN4132 KVM Over the NET™ System. Its purpose, features and benefits are presented, and its front and back panel components are described.

**Chapter 2, Hardware Setup**, provides step-by-step instructions for setting up your installation, and explains some basic operation procedures.

**Chapter 3, Super Administrator Setup**, explains the procedures that the super administrator employs to set up the KVM Over the NET™ switch network environment, and change the default username and password.

**Chapter 4, Logging In**, describes how to log in to the KVM Over the NET™ switch with each of the available access methods: from a local console; an internet browser; a stand-alone Windows application (AP) program; and a stand-alone Java application (AP) program.

**Chapter 5, The User Interface**, describes the layout and explains the components of the KVM Over the NET™ user interface.

**Chapter 6, Port Access**, describes the Port Access page and how to configure the options it provides regarding port manipulation.

**Chapter 7, User Management**, shows super administrators and administrators how to create, modify, and delete users and groups, and assign attributes to them.

**Chapter 8, Device Management**, shows super administrators how to configure and control overall KVM Over the NET™ switch operations.

**Chapter 9, Maintenance**, explains how to upgrade the KVM Over the NET™ switch firmware, as well as the firmware of the KVM Adapter Cables used to connect its ports to the installed devices.

**Chapter 10, Download**, describes how to download stand-alone AP versions of the Win Client, the Java Client, the Log Server, and Power Over the Net (PON) programs.

**Chapter 11, Port Operation**, provides detailed information on accessing and operating the devices connected to the KVM Over the NET™ switch ports.

**Chapter 12, The Log Server**, explains how to install and configure the Log Server.

**Chapter 13, LDAP Server Configuration**, explains how to configure the KVM Over the NET™ switch for LDAP / LDAPS authentication and authorization with Active Directory or OpenLDAP.

**An Appendix**, at the end of the manual provides technical and troubleshooting information.

## **Conventions**

This manual uses the following conventions:

- |  |  |
|--|--|
| Monospaced   | Indicates text that you should key in.   |
| [ ]  | Indicates keys you should press. For example, [Enter] means to press the <b>Enter</b> key. If keys need to be chorded, they appear together in the same bracket with a plus sign between them: [Ctrl+Alt]. |
| 1.   | Numbered lists represent procedures with sequential steps.   |
| ◆  | Bullet lists provide information, but do not involve sequential steps.   |
| →  | Indicates selecting the option (on a menu or dialog box, for example), that comes next. For example, Start → Run means to open the <i>Start</i> menu, and then select <i>Run</i> .                         |
|  | Indicates critical information.  |

## Terminology

Throughout the manual we make reference to the terms *Local* and *Remote* in regard to the operators and equipment deployed in a KVM Over the NET™ switch installation. Depending on the point of view, users and servers can be considered *Local* under some circumstances, and *Remote* under others:

- ◆ Switch's Point of View
  - ◆ Remote users – We refer to a user as a *Remote* user when we think of him as someone who logs into the switch over the net from a location that is *remote from the switch*.
  - ◆ Local Console – The keyboard mouse and monitor connected directly to the switch.
  - ◆ Servers – The servers attached to the switch via KVM Adapter Cables.
- ◆ User's Point of View
  - ◆ Local client users – We refer to a user as a *Local client user* when we think of him as sitting at his computer performing operations on the servers connected to the switch that is *remote from him*.
  - ◆ Remote servers – We refer to the servers as *Remote servers* when we think of them from the Local Client User's point of view – since, although they are locally attached to the switch, they are *remote from him*.

When we describe the overall system architecture we are usually speaking from the switch's point of view – in which case the users are considered remote. When we speak about operations users perform via the browser, viewers, and AP programs over the net, we are usually speaking from the user's point of view – in which case the switch and the servers connected to it are considered remote.

## Product Information

For information about all ALTUSEN products and how they can help you connect without limits, visit ALTUSEN on the Web or contact an ALTUSEN Authorized Reseller. Visit ALTUSEN on the Web for a list of locations and telephone numbers:

International		<a href="http://www.aten.com">http://www.aten.com</a>
North America	ATEN TECH	<a href="http://www.aten-usa.com">http://www.aten-usa.com</a>
	ATEN NJ	<a href="http://www.aten.com">http://www.aten.com</a>

This Page Intentionally Left Blank

# Chapter 1 Introduction

## Overview

The KVM Over the NET™ series of switches are IP-based KVM control units that allow both local and remote operators to monitor and access multiple servers from a single console. A single KN4140v can control up to 40 servers, and by cascading up to 40 compatible 16 port switches, as many as 640 servers can be controlled on a complete two stage installation.

The switches are differentiated according to the number of buses they support and the number of KVM ports they provide – as shown in the table below:

Model	Bus Support	KVM Ports
KN2124v	1 Local; 2 Remote	24
KN2140v	1 Local; 2 Remote	40
KN4124v	1 Local; 4 Remote	24
KN4140v	1 Local; 4 Remote	40
KN2116A	1 Local; 2 Remote	16
KN2132	1 Local; 2 Remote	32
KN4116	1 Local; 4 Remote	16
KN4132	1 Local; 4 Remote	32

Each bus permits a separate user session so that up to three (1 Local; 2 Remote) or five (1 Local; 4 Remote) concurrent independent connections to the attached servers can take place.

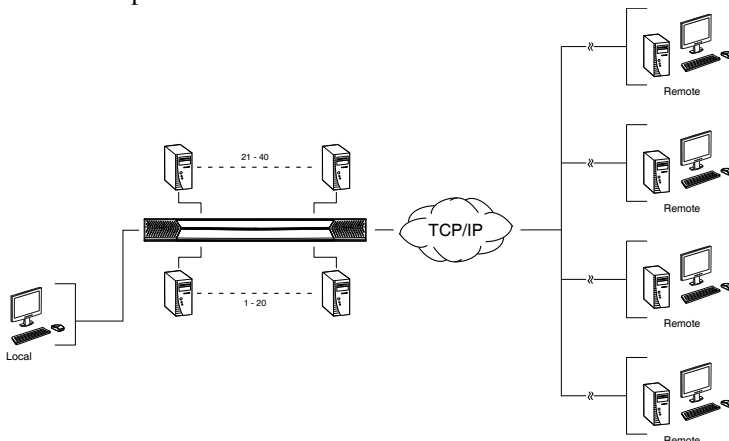

Since KVM Over the NET™ switches use TCP/IP for their communications protocol, they can be accessed via their IP addresses from anywhere on the LAN, WAN, or Internet – whether the connecting computer is located down the hall, down the street, or half-way around the world. Remote operators can log in via their browser or make use of stand-alone Windows or Java GUI applications. Java allows the switches to work with JRE (Sun's Java Runtime Environment) enabled operating systems – ensuring multi-platform operability.

The client software allows operators to exchange keyboard, video and mouse signals with the servers attached to the KVM Over the NET™ switches as if they were present locally and working on the equipment directly.

Up to 32 users can share the switch's buses. A *Message Board* feature allows them to communicate with each other to facilitate port sharing.

Administrators can handle a multitude of maintenance tasks with ease – from installing and running GUI applications, to BIOS level troubleshooting, routine monitoring, concurrent maintenance, system administration, rebooting and even pre-booting functions.

Local console operation is easily accomplished either by entering *hotkey* combinations from the keyboard with a full screen GUI display.

Monitoring the installation's activities couldn't be easier. An convenient *Auto Scan* feature permits automatic switching from port to ports at user-specified intervals, while the *Panel Array Mode* can display the video output of up to 40 servers at the same time.

The switches feature RJ-45 connectors allowing them to use CAT 5e cable to link to the servers. This space-saving innovation means that a full 16, 24, 32 or 40 port switch can be conveniently installed in a 1U system rack, and the installation can take advantage of the internal network wiring built into most modern commercial buildings.

Setup is fast and easy; plugging cables into their appropriate ports is all that is entailed. Because the switch intercepts keyboard input directly, there is no need to get involved in complex software installation routines, or to be concerned with incompatibility problems.

Since the firmware is upgradeable over the Net, you can stay current with the latest functionality improvements simply by downloading firmware updates from our website as they become available.

With its advanced security features, the KVM Over the NET™ switch provides the fastest, most reliable, most cost effective way to remotely access and manage widely distributed multiple server installations.

KVM Over the NET™ switches have an *Adapter ID* function that stores port information like the adapter ID, OS, keyboard language, adapter name, operation modes and more, so that when you move a KVM Adapter Cable from one port to another, the switch recognizes the same adapter cable at the new location. Also, for greater ease of use when moving the adapter cable to another switch, the adapter ID, OS, keyboard language, adapter name, and operation modes of the port stay with the adapter.

With its advanced virtual media features, the KN2124v / KN2140v / KN4124v / KN4140v series of switches let you map DVD/CD drives and other storage media to a server. This function allows you to conduct file transfers, install applications and OS patches, and perform diagnostics remotely. You can upgrade your entire installation from a single remote console located anywhere in the world.

The KN4140v offers dual power supplies so that if one of the power supplies fails, the second power supply automatically takes over. In addition to supporting dual power, the KN4140v guards against power failure from your server room outlets. If your server room has more than one power source, connecting the KN4140v power supplies to different power sources is a wise choice. If one of the server room power supplies loses power, the KN4140v will automatically adjust the power it draws from the second source to keep functioning.

The KN2124v, KN2140v, KN4124v, and KN4140v models support four temperature sensors that can control up to six fans. The sensors regulate the fans so that they run at optimum speed depending on the server room temperature – throttling down when necessary, to use energy more efficiently and prolong the life of both the fans and the switch.

The KN2124v, KN2140v, KN4124v, and KN4140v models are also audio enabled. Microphone and speakers are supported on the Local Console for the servers; speakers are supported on the remote users' computers.

## Features

---

### Hardware

- ◆ High port density – RJ-45 connectors for up to 40 ports in a 1U housing
- ◆ Two or four separate buses for remote KVM over IP access
- ◆ Two 10/100/1000 Mbps NICs for redundant LAN or two IP operation
- ◆ Supports PS/2, USB, Sun Legacy (13W3) and serial (RS-232) connectivity
- ◆ Local console provides PS/2 and USB keyboard and mouse support
- ◆ Supports multiplatform server environments: Windows, Mac, Sun, Linux and VT100 based serial devices
- ◆ High video resolution – up to 1600 x 1200 @ 60Hz – 32 bit color depth for the local console; up to 1600 x 1200 @ 60Hz with 24 bit color depth for remote sessions, at up to 50 m
- ◆ Monitor and control up to 16, 24, 32, or 40 servers on a single level, or control up to 640 servers in a two-level cascade\*

---

**Note:** Cascade-compatible KVM Switches include the following:  
CS9134, CS9138, CS88A, KH1508, and KH1516

---

### Management

- ◆ Up to 64 user accounts – up to 32 users simultaneously share the control
- ◆ Fan speed varies according to temperature
- ◆ End session feature – administrators can terminate running sessions
- ◆ Event logging and Windows-based Log Server support
- ◆ Critical system events sent by email and SNMP trap; and Syslog support
- ◆ Firmware upgradeable
- ◆ Modem dial-in/dial back support
- ◆ Adapter ID
- ◆ Port Share Mode allows multiple users to gain access to a server simultaneously
- ◆ Integration with ALTUSEN CC2000 Management software
- ◆ Power Over the NET™ integration for remote power control



## **Ease-to-Use Interface**

- ◆ Local Console, browser-based, and AP GUIs offer a unified multilanguage interface to minimize user training time and increase productivity
- ◆ Multiplatform client support (Windows, Mac OS X, Linux, Sun)
- ◆ Multibrowser support (IE, Mozilla, Firefox, Safari, Opera, Netscape)
- ◆ Browser-based UI in pure Web technology allows administrators to perform administrative tasks without pre-installed Java software package required
- ◆ User can launch multiple Virtual Remote Desktops to control multiple connected servers from the same login session
- ◆ Magic Panel
- ◆ Full-screen or sizable and scalable Virtual Remote Desktop
- ◆ Panel Array Mode

## **Advanced Security**

- ◆ Remote authentication support: RADIUS, LDAP, LDAPS, and MS Active Directory
- ◆ Advanced security features include password protection and advanced encryption technologies – 1024 bit RSA; 56 bit DES; 256 bit AES; and 128 bit SSL
- ◆ Flexible encryption design allows users to choose any combination of 56-bit DES, 168-bit 3DES 256-bit AES, 128-bit RC4, or Random for independent KB/Mouse, video, and virtual media data encryption
- ◆ Support for IP/MAC Filter
- ◆ Supports strong password protection
- ◆ Configurable user and group permissions for server access and control
- ◆ Local and remote access logged and authenticated
- ◆ Private CA

## **Virtual Media**

- ◆ Virtual media enables file applications, OS patching, software installation and diagnostic testing
- ◆ Works with USB enabled servers in operating system and BIOS level
- ◆ Supports DVD/CD drives, USB mass storage devices, PC hard drives and ISO images

## **Virtual Remote Desktop**

- ◆ Video quality and video tolerance can be adjusted to optimize data transfer speed; monochrome color depth setting, threshold and noise settings for compression of the data bandwidth in low bandwidth situations
- ◆ Full screen video display or scalable video display
- ◆ Message Board for communication among remote users
- ◆ Mouse DynaSync™
- ◆ Keyboard pass through support
- ◆ Exit Macros support
- ◆ On-screen keyboard with multilanguage support
- ◆ BIOS-level access

## **V-Series Exclusive**

Features found only with the V-Series KVM Over the NET™ switches (KN2124v, KN2140v, KN4124v, and KN4140v) include the following:

- ◆ Audio – a microphone and speakers are supported on the Local Console; speakers (only) are supported on the remote user computers.
- ◆ Dual power supply support – Log and UI reflect the power status
- ◆ Virtual Media support
- ◆ Variable fan speed – speed changes according to the switch's temperature

## System Requirements

---

### Remote User Computers

Remote user computers (also referred to as client computers) are the ones the users log into the switch with from remote locations over the internet (see *Terminology*, page xv). The following equipment must be installed on these computers:

- ◆ For best results we recommend that the computers used to access the switch have at least a P III 1 GHz processor, with their screen resolution set to 1024 x 768.
- ◆ Browsers must support 128 bit SSL encryption.
- ◆ For best results, a network transfer speed of at least 512kbps is recommended.
- ◆ For the Windows Client AP, DirectX 8 must be present, and at least 90MB of memory must be available after installation.
- ◆ For the Java Client AP, the latest version of Sun's Java Runtime Environment (JRE) must be installed, and at least 145MB of memory must be available after installation.
- ◆ For the browser-based WinClient ActiveX Viewer, DirectX 8 must be present, and at least 150MB of memory must be available after installation.
- ◆ For the browser-based Java Applet Viewer the latest version of Sun's Java Runtime Environment (JRE) must be installed, and at least 205MB of memory must be available after installation.
- ◆ For the *Log Server*, you must have the Microsoft Jet OLEDB 4.0 or higher driver installed.

### Servers

Servers are the computers connected to the switch via KVM Adapter Cables (see *Terminology*, page xv). The following equipment must be installed on these servers:

- ◆ A VGA, SVGA or multisync port
- ◆ For USB KVM Adapter Cable Connections: a Type A USB port and USB host controller
- ◆ For PS/2 KVM Adapter Cable Connections: 6-pin Mini-DIN keyboard and mouse ports

## Video

Only the following **non-interlaced** video signals are supported:

Resolution	Refresh Rates
640 x 480	60, 70, 72, 75, 85
720 x 400	70, 75
800 x 600	56, 60, 70, 72, 75, 85
1024 x 768	60, 70, 75, 85
1152 x 864	60, 70, 75, 85
1152 x 900	66, 76
1280 x 1024	60, 70, 75, 85
1600 x 1200	60

## KVM Adapter Cables

- ♦ Cat 5e (or higher) cable is required to connect the KVM Over the NET™ switch to the KVM Adapter Cables (see page 21).
- ♦ The following KVM Adapter Cables are required for use with the KVM Over the NET™ switch:

Function	Module
Connect to devices with PS/2 ports	KA9120 / KA7120
Connect to devices with USB ports (All platforms – PC, Mac, Sun)	KA9170 / KA7170
Connect to Sun Legacy Computers	KA9130 / KA7130
Connect to serial based devices	KA9140 / KA7140
Connect to devices with USB ports and virtual media support	KA7175*
Connect to devices with USB ports, virtual media and audio support	KA7176*

---

**Note:** 1. The KVM Adapter cables marked with an asterisk (\*) are for use with the KN2124v, KN2140v, KN4124v and KN4140v switches only.

2. If you use Adapter Cables that were purchased prior to your switch purchase, you may have to upgrade the Adapter Cable's firmware. You can upgrade the Adapter Cable's firmware from the Maintenance page (see page 149 for details).
-

## **Operating Systems**

- ◆ Supported operating systems for remote user computers that log into the KVM Over the NET™ switch include Windows 2000 and higher, and those capable of running Sun's Java Runtime Environment (JRE) 6, Update 3, or higher (Linux, Mac, Sun, etc.).
- ◆ Supported operating systems for the servers that are connected to the switch's ports are shown in the table, below:

<b>OS</b>		<b>Version</b>
Windows		2000 and higher
Linux	RedHat	7.1 and higher
	Fedora	Core 2 and higher
	SuSE	9.0 and higher
	Mandriva (Mandrake)	9.0 and higher
UNIX	AIX	4.3 and higher
	FreeBSD	4.2 and higher
	Sun	Solaris 8 and higher
Novell	Netware	5.0 and higher
Mac		OS 9 and higher*
DOS		6.2 and higher

## **Browsers**

Supported browsers for users that log into the KVM Over the NET™ switch include the following:

<b>Browser</b>	<b>Version</b>
IE	6 and higher
Firefox	1.5 and higher
Mozilla	1.7 and higher
Safari	2.0 and higher*
Opera	9.0 and higher
Netscape	8.1 and higher

\* See *Mac Systems*, page 204, for further information.

## Components

---

### **KN2124v / KN2140v / KN4124v / KN4140v Front View**

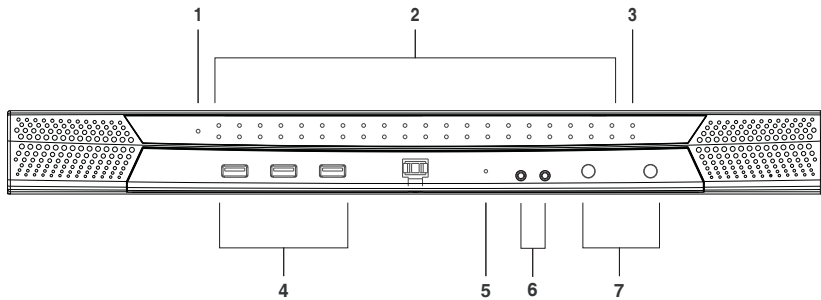

---

**Note:** The figure above shows the front panel of a KN2140v / KN4140v.  
The KN2124v / KN4124v differs in that there are fewer port LEDs.

---

### **KN2116A / KN2132 / KN4116 / KN4132 Front View**

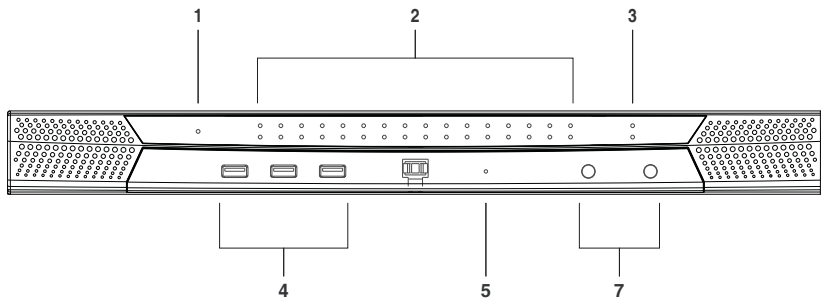

---

**Note:** The figure above shows the front panel of a KN4132 / KN2132.  
The KN2116A / KN4116 differs in that it only has a single row of port LEDs.

---

No.	Component	Description
1	Power LED	Lights when the unit is powered up and ready to operate.
2	Port LEDs	<p>The Port LEDs provide status information about their corresponding KVM Ports.</p> <ul style="list-style-type: none"> <li>◆ GREEN: The computer attached to the port is On Line.</li> <li>◆ RED: The computer attached to the port is Selected (has KVM focus).</li> <li>◆ GREEN + RED (ORANGE): The computer attached to the port is On Line and Selected.</li> </ul> <p>The LEDs are steady under normal conditions, but a LED flashes at half second intervals when its corresponding port is accessed under Auto Scan Mode or Skip Mode (see pages 158 and 159).</p>
3	LAN LEDs	<p>Primary and Secondary 10/100/1000 Mbps LAN LEDs.</p> <ul style="list-style-type: none"> <li>◆ RED: 10 Mbps</li> <li>◆ RED + GREEN (ORANGE): 100 Mbps</li> <li>◆ GREEN: 1000 Mbps</li> <li>◆ Flashes to indicate that the switch is being accessed over the Net.</li> </ul>
4	USB Ports	A USB keyboard and mouse can plug in here. This can either be in place of, or in addition to, plugging a keyboard and mouse into the ports on the rear panel. (This port can be used to connect USB flash storage only on the KN4140v.)
5	Reset Switch	<p><b>Note:</b> This switch is recessed and must be pushed with a small object such as the end of a paper clip, or a ballpoint pen.</p> <ul style="list-style-type: none"> <li>◆ Pressing and releasing this switch when the unit is running performs a system reset.</li> <li>◆ Pressing and holding this switch in for more than three seconds when the unit is running resets its configuration to the factory default settings.</li> </ul> <p><b>Note:</b> This does not clear User Account information. See <i>Clear Login Information</i>, page 226, for information on clearing user account information.</p> <ul style="list-style-type: none"> <li>◆ Pressing and holding this switch while powering on the switch returns the unit to its factory default firmware level, rather than the firmware version that the switch has been upgraded to. This allows you to recover from a failed firmware upgrade and gives you the opportunity to try upgrading the firmware again.</li> </ul> <p><b>Note:</b> This operation should only be performed in the event of a firmware upgrade failure that results in the device becoming inoperable.</p>
6	Audio Ports	Speakers and microphone plug in here. (KN4140v only)
7	Port Switching Buttons	<ul style="list-style-type: none"> <li>◆ Press <b>PORT DOWN</b> to switch from the current port to the previous port on the installation.</li> <li>◆ Press <b>PORT UP</b> to switch from the current port to the next port on the installation.</li> </ul>

## **KN2124v / KN2140v / KN4124v / KN4140v Rear View**

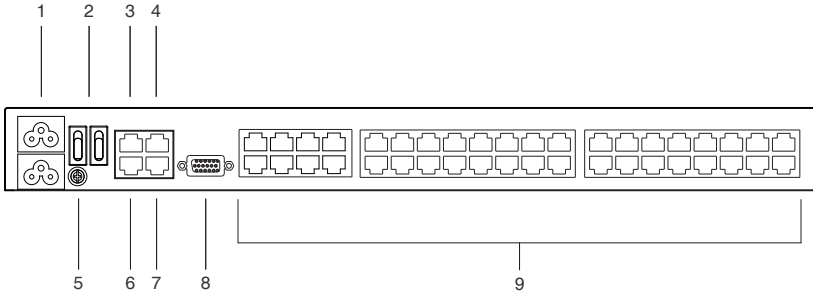

**Note:** The figure above shows the rear panel of a KN2140v / KN4140v with two blocks of 16 KVM ports and one block of 8 (40 ports in total). The KN2124v / KN4124v differs in that it only has a single block of 16 KVM ports and one block of 8 (24 ports in total).

## **KN2116A / KN2132 / KN4116 / KN4132 Rear View**

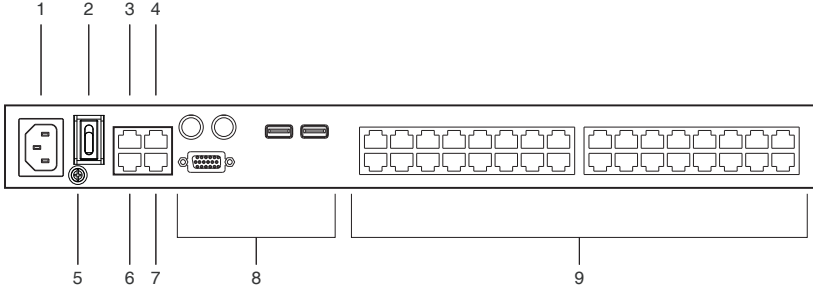

**Note:** The figure above shows the rear panel of a KN2132 / KN4132 with two blocks of 16 KVM ports (32 ports in total). The KN2116A / KN4116 differs in that it only has a single block of KVM ports (16 ports in total).



No.	Component	Description
1	Power Socket	The power cable(s) plugs in here. <b>Note:</b> For the KN2124v, KN2140v, KN4124v and the KN4140v units, the top power socket corresponds to the left power switch, and the bottom power socket corresponds to the right power switch.
2	Power Switch	This standard slide switch powers the unit on and off.
3	Secondary LAN Port	The cable that connects the unit to the backup network interface (10/100/1000 Mbps) plugs in here.
4	PON Port	This connector is provided for a Power over the Net™ (PON) unit which allows servers attached to the KVM Over the NET™ switch to be booted remotely over the net. See <i>Single Stage Installation</i> , page 21, step 6 for installation details. Contact your dealer for more information regarding PON units.
5	Grounding Terminal	The wire used to ground the unit connects here.
6	Primary LAN Port	The cable that connects the unit to the primary network interface (10/100/1000 Mbps) plugs in here.
7	Modem Port	For dial in connection should the unit be unavailable over the network. See <i>Single Stage Installation</i> , page 21, step 7 for installation details.
8	Local Console Port(s)	The unit can be accessed via a local console as well as over the Net. The local console devices (keyboard, monitor and mouse), plug in here. Any combination of USB and PS/2 keyboards and mice can be used. <b>Note:</b> For the KN2124v, KN2140v, KN4124v and the KN4140v units, use the 5-in-1 cable supplied with the package to connect your console devices to the unit.
9	KVM Ports	The Cat 5e cables that link the unit to the KVM Adapter Cables (which connect to the servers), plug in here.

This Page Intentionally Left Blank

# Chapter 2

## Hardware Setup

### Overview

---

For convenience and flexibility that allows mixing the PS/2 and USB interfaces, as well as multiple platforms, the KVM Over the NET™ switch design utilizes KVM Adapter Cables, that serve as intermediaries between the switch and the connected devices (refer to the installation diagram on p. 16).

A separate KVM Adapter Cable is required for each server or device connection. The model numbers of the Adapters are given in the *KVM Adapter Cables* section, page 8.

### Before You Begin

---



1. Important safety information regarding the placement of this device is provided on page 189. Please review it before proceeding.
2. Make sure that the power to any device that you connect to the installation has been turned off. You must unplug the power cords

## Stacking and Rack Mounting

---

The KVM Over the NET™ switch can be stacked on the desktop or rack mounted in a variety of ways. The following sections take you through the procedures for each method.

### Stacking

The KVM Over the NET™ switch can be placed on any appropriate level surface that can safely support its weight plus the weight of its attached cables. To place the KVM Over the NET™ switch, or to stack units if you are daisy-chaining them, remove the backing material from the bottom of the rubber feet that came with this package, and stick them onto the switch's bottom panel at the corners, as shown in the diagram, below:

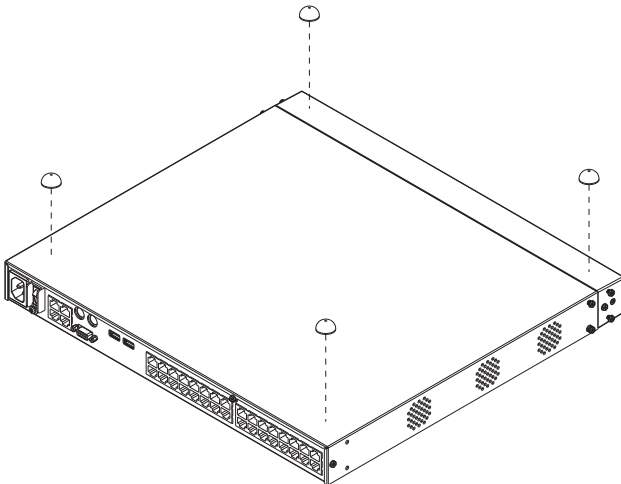

---

**Note:** To ensure adequate ventilation, allow at least 5.1 cm on each side, and 12.7 cm behind the unit for power cord and cable clearance.

---

## Rack Mounting

The KVM Over the NET™ switch can be mounted in a 19" (1U) rack. The mounting brackets can screw into either the front or the back of the unit so that it can attach to the front or the back of the rack.

### Rack Mounting - Front

To mount the unit at the front of the rack, do the following:

1. Remove the two screws at the front of the unit.

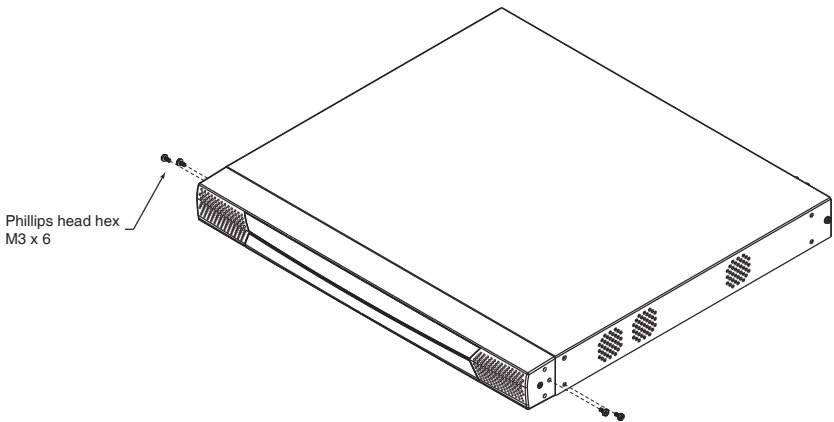

2. Use the M3 x 8 Phillips head hex screws supplied with the rack mount kit to screw the rack mounting brackets into the front of the unit.

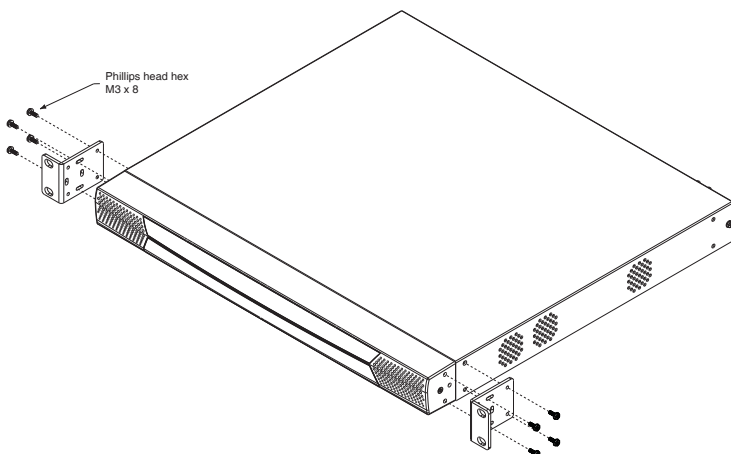

3. Position the device in the front of the rack and align the holes in the mounting brackets with the holes in the rack.
4. Screw the mounting brackets to the rack.

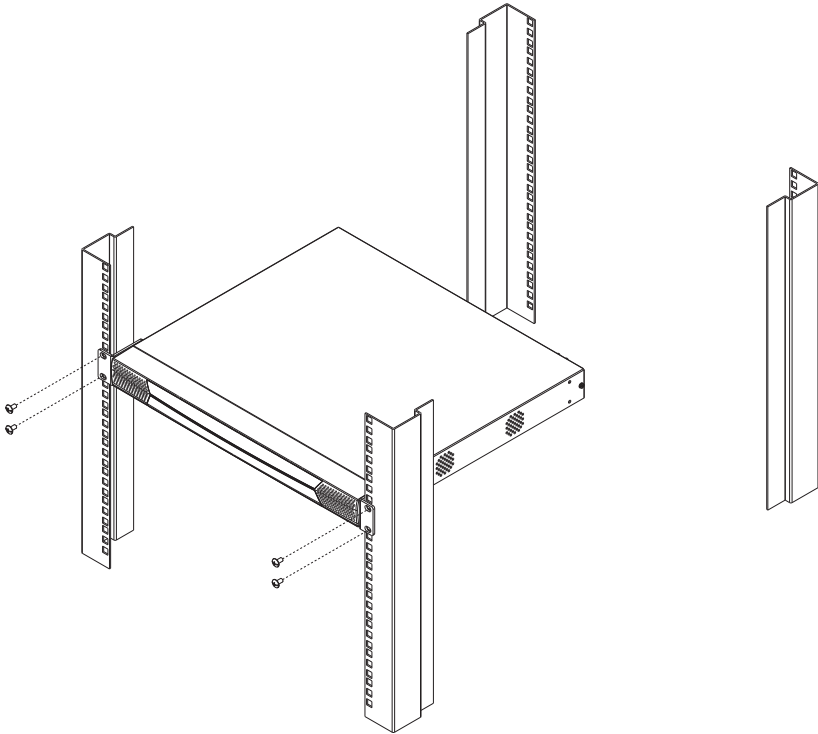

---

**Note:** Cage nuts are provided for racks that are not prethreaded.

---

## Rack Mounting - Rear

To mount the unit at the rear of the rack, do the following:

1. Remove the two screws at the rear of the unit.

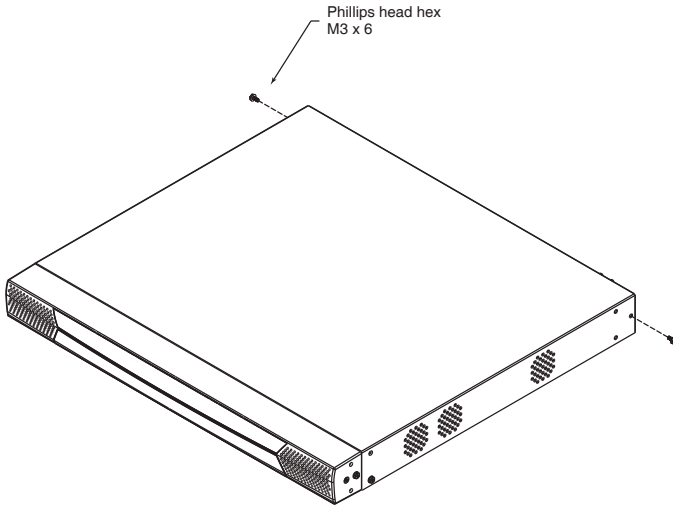

2. Use the M3 x 8 Phillips head hex screws supplied with the rack mounting kit to screw the rack mounting brackets into the rear of the unit.

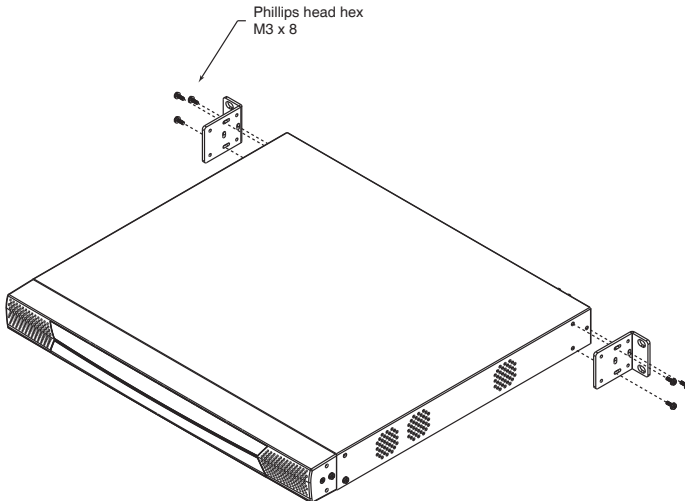

3. Position the device in the rack and align the holes in the mounting brackets with the holes in the rack.

4. Screw the mounting brackets to the rear of the rack.

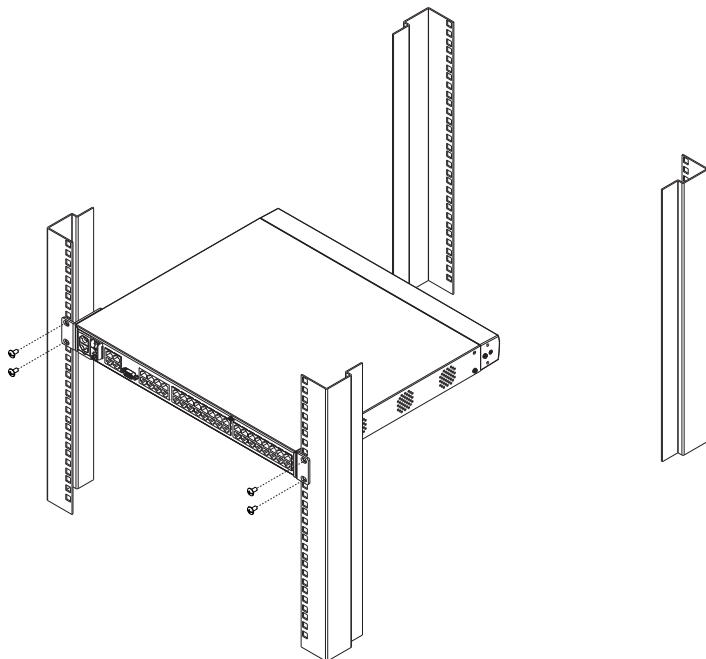

---

**Note:** Cage nuts are provided for racks that are not prethreaded.

---



---

## Single Stage Installation

---

In a single stage installation, there are no additional switches cascaded from the KVM Over the NET™ switch. To set up a single stage installation, refer to the installation diagrams starting on page 23 (the numbers in the diagram correspond with the numbers of the instruction steps), and do the following:

1. For the KN2124v, KN2140v, KN4124v and KN4140v, use the 5-in-1 Console Cable supplied with the package to connect your Local Console devices to the unit.

For the KN2132, KN4116, and KN4132, plug your Local Console's keyboard, monitor, and mouse into the unit's Console Ports. Each port is color coded and marked with an appropriate icon.

- 
- Note:**
1. You can use any combination of keyboard and mouse connections. For example, you can use a PS/2 keyboard with a USB mouse.
  2. USB keyboards and mice can plug into the USB ports on the front panel, as well as into the ports in the console port section.
  3. The KVM Over the NET™ switch does not support distances that exceed 20m between itself and the local monitor.
- 

2. Use Cat 5e cable to connect any available KVM port to a KVM Adapter Cable that is appropriate for the server you are installing (see the table on page 8 for details).

- 
- Note:**
1. If you are using a KA7120, KA7130, KA9120, KA9130, or KA9131 Adapter Cable, refer to page 216 for mouse pointer synchronization information.
  2. If you are using a KA9131 Adapter Cable, refer to page 204 for video and mouse adjustment information.
  3. If you are using a KA7140 Adapter Cable, refer to page 214 for setup and operation information.
  4. The distance between the switch and the KVM Adapter Cable must not exceed these lengths: KA7140: 300m; KA71xx: 50m; KA91xx: 40m.
- 

3. Plug the connectors on the KVM Adapter Cable into the appropriate ports of the server you are installing. (See *Adapter Cable Connection Diagram*, page 25.)

4. Plug a cable from the LAN or WAN into the KVM Over the NET™ switch primary network interface socket.
5. (Optional) Plug another cable from the LAN or WAN into the KVM Over the NET™ switch backup (secondary) network interface socket.
6. (Optional) Use Cat 5e cable to connect the KVM Over the NET™ switch PON port to an SA0142 Adapter. Connect the Adapter to the PON IN port of a PN0108 Power Over the Net™ unit.
7. (Optional) Use Cat 5e cable to connect the KVM Over the NET™ switch Modem port to an SA0142 Adapter. Connect the Adapter's serial connector to the modem's DB-9 port.
8. Use the grounding wire supplied with this package to ground the unit by connecting one end of the wire to the grounding terminal, and the other end of the wire to a suitable grounded object.

---

**Note:** Do not omit this step. Proper grounding helps to prevent damage to the unit from surges or static electricity.

---

9. Plug the power cord(s) supplied with this package into the KVM Over the NET™ switch power socket, and then into an AC power source.

For the KN2124v, KN2140v, KN4124v and KN4140v, when using a single power socket, be sure to turn on the correct power switch (see *Power Switch*, page 13). When using both power sockets, either of the power switches can be used to turn on the KVM switch – or, to enable dual power, turn on both power switches.

---

**Note:** If you are connecting the power to a UPS or an ALTUSEN PN9108/PN0108 use the utility power cords supplied with this package instead of the standard power cords.

---

After the KVM Over the NET™ switch is cabled up you can turn on the power. After it is powered up, you can turn on the servers.

## KN2124v / KN2140v / KN4124v / KN4140v Single Stage Installation Diagram

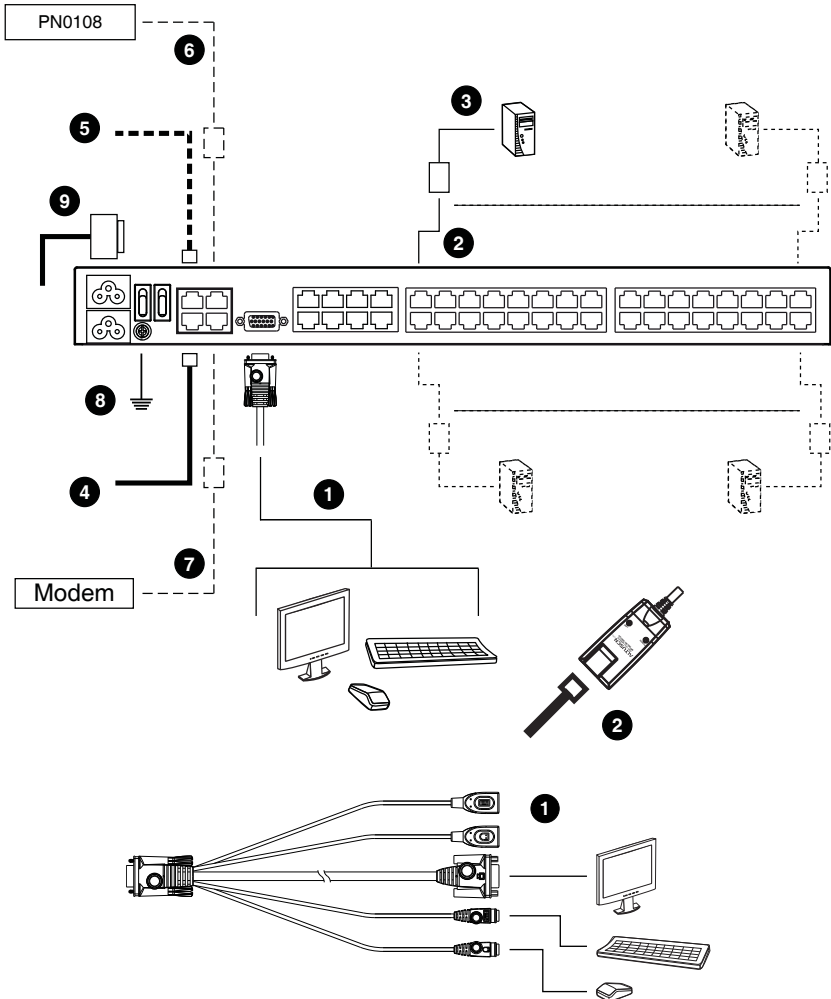

## **KN2116A / KN2132 / KN4116 / KN4132** **Single Stage Installation Diagram**

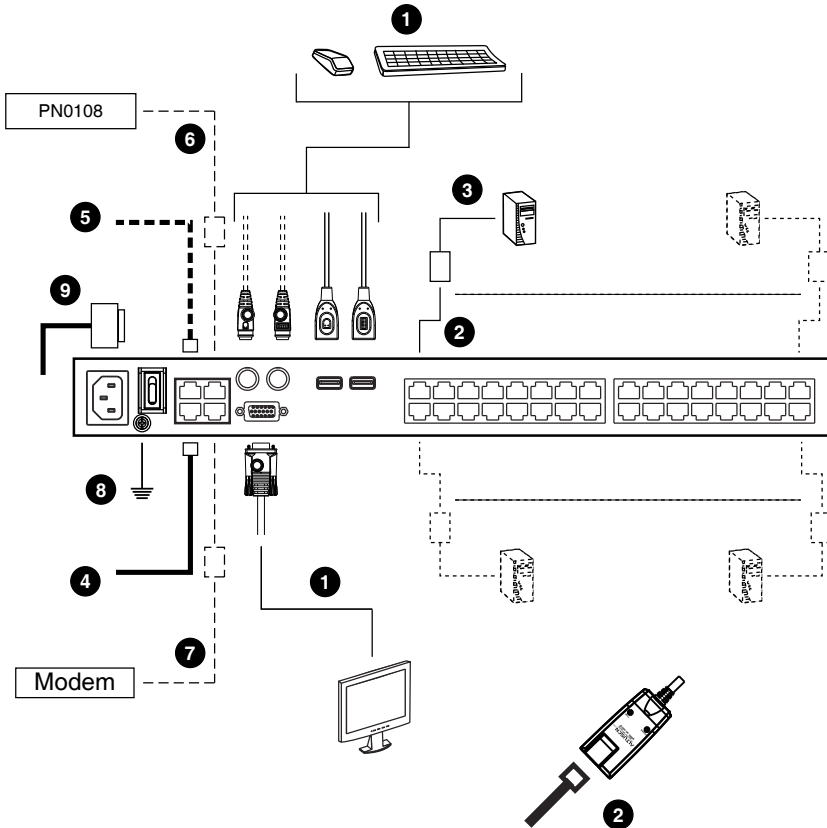

## Adapter Cable Connection Diagram

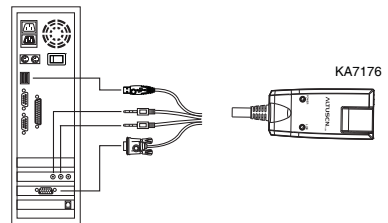
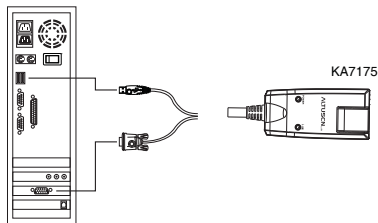
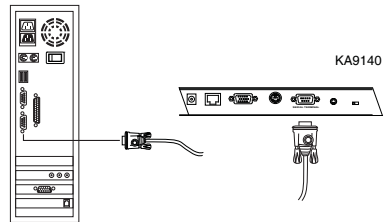
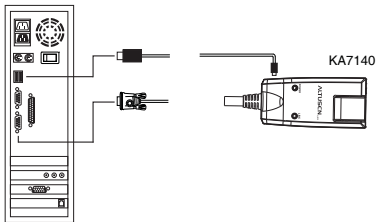
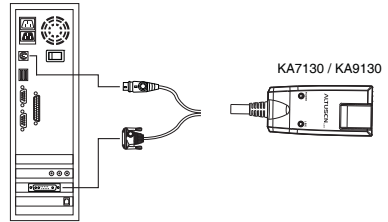
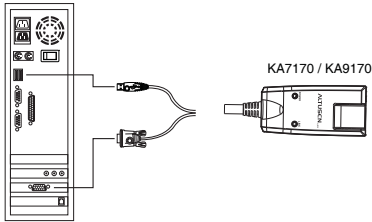
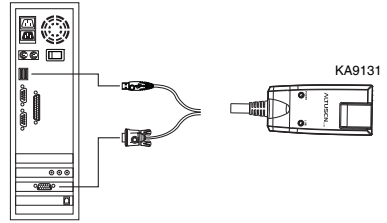
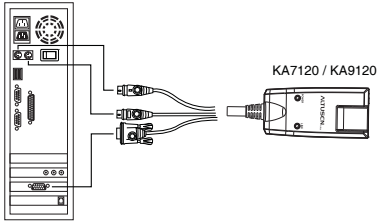

## Two Stage Installation

---

To control even more servers, up to 40 additional KVM switches can be cascaded from the KVM ports of the KVM Over the NET™ switch. As many as 640 servers can be controlled in a complete two stage installation.

In a cascaded installation, the KVM Over the NET™ switch is considered the *First Stage* unit, the cascaded switches are considered *Second Stage* units.

---

**Note:** The cascaded KVM switch shown in the example is the KH1516.  
See *Supported KVM Switches*, page 228, for a list of other switches.

---

To set up a two stage installation, refer to the diagram on page 27, and do the following:

1. Make sure that power to all the devices you will be connecting, including all preexisting devices on the installation, have been turned off.
2. Use Cat 5e cable to connect any available KVM Port on the First Stage unit (the KVM Over the NET™ switch) to a KVM Adapter Cable (as described under *KVM Adapter Cables*, page 8).
3. Plug the adapter cable's KVM connectors to the Keyboard, Video, and Mouse Console ports of the Second Stage unit.

---

**Note:** The distance between the *First Stage* unit and the *Second Stage* unit must not exceed 40m or 50m based on the KVM adapter cable used.

---

4. Use KVM cable sets (as described in the Cables section of the cascaded KVM switch's User Manual), to connect any available KVM port on the *Second Stage* unit to the Keyboard, Video, and Mouse ports of the server you are installing.
5. Plug the power cord that came with the cascaded KVM switch into its Power Socket, and then into an AC power source.
6. Repeat these steps for any other *Second Stage* units you wish to connect.
7. Power on the *Second Stage* unit(s), then power on the *First Stage* unit.
8. Turn on the power to all the servers.

---

**Note:** The Power On sequence requires that all *Second Stage* switches be powered on first. After all *Second Stage* switches are powered on, the *First Stage* switch can be powered on. After all the switches are powered on, the servers can be powered on.

---

## Two Stage Installation Diagram

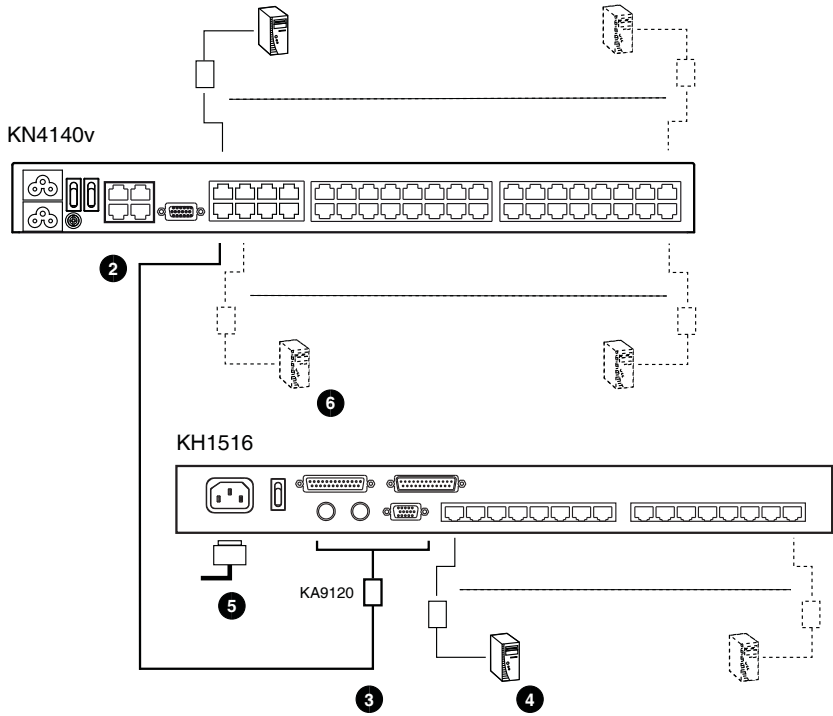

## Hot Plugging

---

The KVM Over the NET™ switch supports hot plugging – components can be removed and added back into the installation by unplugging and replugging cables from the ports without the need to shut the unit down.

---

**Note:** If the server's Operating System does not support hot plugging, this function may not work properly.

---

### The Adapter ID Function

Adapter Cable information that includes the Adapter ID, port name, OS, keyboard language, and access mode is stored on the adapter. The Adapter ID function stores this information, as well as the adapter cable's configuration information (such as access rights, etc.), in the switch's database.

When you move a server together with its adapter cable from one port to another, you don't have to reconfigure its settings – the Adapter ID function restores them at the new location. The only change is in the port number.

When moving the server and adapter cable to another switch, however, only the information that is stored on the adapter is retained. For the other settings you must either reconfigure them, or use the Port Utilities export/function (see page 84) to restore them.

Since port settings are stored with the adapter, if you move a server to a new port without its original adapter; or if you connect a different server to the adapter, you must manually configure the port settings for the new server. See *Port Utilities*, page 84 for port configuration details.

## Powering Off and Restarting

---

If it becomes necessary to power off the switch, or if the switch loses power and needs to be restarted, wait 10 seconds before powering it back on. The servers should not be affected by this, but if any of them should fail, simply restart them.



## Port ID Numbering

---

Each server on the installation is assigned a unique Port ID. The Port ID is a one or two segment number that is determined by the Stage Level and KVM Port number of the KVM switch that the server is connected to.

The first segment represents the KVM Port number of the First Stage unit; the second segment represents the KVM Port number of the Second Stage unit.

A server attached to a First Stage unit has a one segment Port ID (from 1–40) that corresponds to the KVM Port number that it is connected to.

A server attached to a Second Stage unit has a two segment Port ID:

- ◆ The second segment (from 1–16), represents the KVM Port number on the Second Stage unit that the server is connected to. The first segment (from 1–40) represents the KVM Port number on the First Stage unit that the Second Stage unit links back to.
- ◆ For example, a Port ID of 12 - 3 refers to a server that is connected to KVM Port 3 of a Second Stage unit that links back to KVM Port 12 of the First Stage unit.

## Port Selection

---

Port selection is accomplished by means of the GUI. Port selection details are discussed in Chapter 6, *Port Access*.

This Page Intentionally Left Blank

# Chapter 3

## Super Administrator Setup

### Overview

---

The KVM Over the NET™ switch supports three types of user, as shown in the table, below:

User Type	Role
Super Administrator	Access and manage ports and devices. Manage Users, and Groups. Configure the overall installation. Configure personal working environment.
Administrator	Access and manage authorized ports and devices. Manage Users and Groups. Configure personal working environment.
User	Access authorized ports and devices. Manage authorized ports and devices; configure personal working environment.

This chapter discusses the administrative procedures that the Super Administrator performs.

### First Time Setup

---

Once the KVM Over the NET™ switch has been cabled up, the Super Administrator needs to set the unit up for user operation. This involves setting the network parameters and adding users. The most convenient way to do this for the first time is from the local console.

---

**Note:** For remote methods of setting up the network, see *IP Address Determination*, page 208.

---

After the local console has been connected (see *Single Stage Installation*, page 21), and the KVM Over the NET™ switch turned on, a login prompt appears on the console monitor:



Since this is the first time you are logging in, use the default Username: *administrator*; and the default Password: *password*.

**Note:** For security purposes, you should change these to a unique Username and Password. (See *Changing the Super Administrator Login*, page 34 for details.)

After you successfully log in, the Local Console Main Page appears:

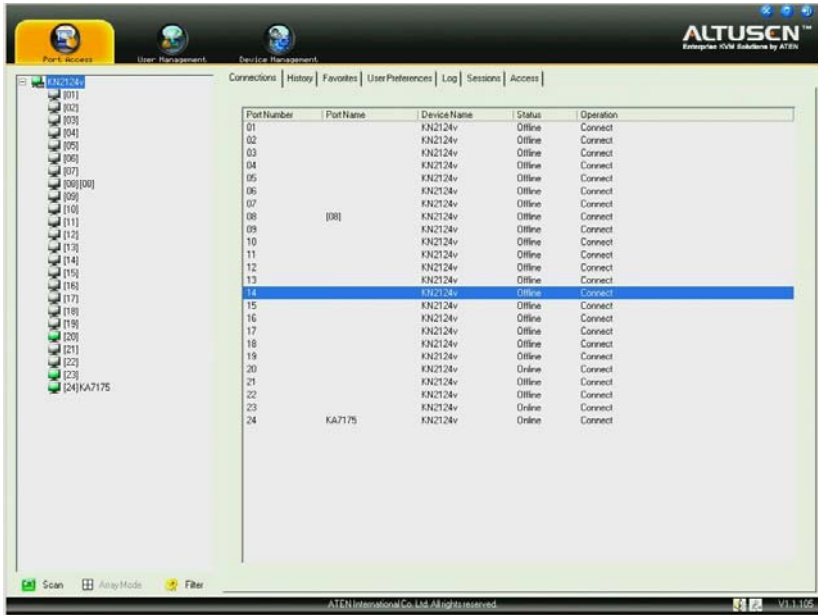

## Network Setup

To set up the network, do the following:

1. Click the **Device Management** tab.
2. Select the **Network** tab.

The screenshot shows the ALTUSCN Configuration window with the 'Network' tab selected. The 'Network' tab is circled in red. The window displays the following settings:

- Service Ports:**
  - Program: 8000
  - HTTP: 80
  - HTTPS: 443
- NIC Settings:**
  - Redundant NIC
  - 1000M Network Adapter 1 (selected)
  - IP Address:
    - Obtain IP address automatically (DHCP)
    - Set IP address manually (Fixed IP)
  - IP Address: 172 . 17 . 17 . 23
  - Subnet Mask: 255 . 255 . 255 . 0
  - Default Gateway: 172 . 17 . 17 . 1
- DNS Server:**
  - Obtain DNS server address automatically
  - Set DNS server address manually
  - Preferred DNS server: 10 . 0 . 1 . 23
  - Alternate DNS server: 0 . 0 . 0 . 0
- Network Transfer Rate:**
  - 99999 Kbps

A 'Close' button is located at the bottom right of the window.

3. Fill in the fields according to the information provided under *Network*, page 124.

## **Changing the Super Administrator Login**

To change the default Super Administrator Username and Password, do the following:

1. At the top of the screen, click **User Management**.

The User Management page has a list of Users and Groups in the left hand panel, and a more detailed list of users – with more information about them – in a large central panel. Since this is the first time the page is being accessed, only the Super Administrator appears:

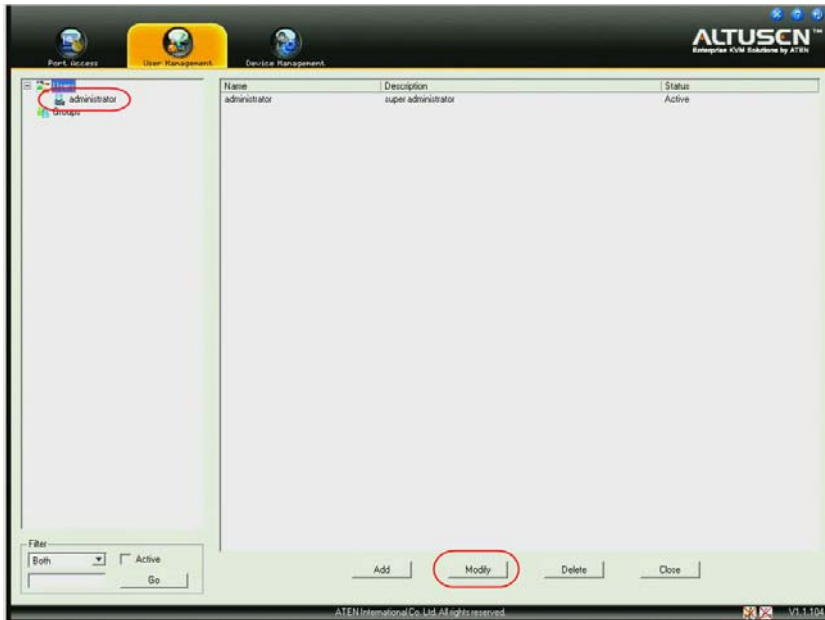

2. Click **administrator** in the left panel  
– or –

Select *administrator* in the central panel, then click **Modify** (at the bottom of the page.)

(Continues on next page.)

(Continued from previous page.)

The *User Information* page appears:

User Information

Username:

Password:

Confirm Password:

Description:

Role

Super Administrator  Administrator  User

Permissions:

Windows Client  Java Client  View only

Power Management  Force to Grayscale

Status

Disable account

Account never expires

Account expires on

User must change password at next logon

User cannot change password

Password never expires

Password expires after  days

Save

3. Change the Username and Password to something unique.
4. Re-enter the password to confirm it is correct.
5. Click **Save**.
6. When the dialog box informing you that the change completed successfully appears, Click **OK**.
7. Click on another item on the Local Console Main Page, to close this page.

## Moving On

---

After setting up the network and changing the default Super Administrator password, you can proceed to other administration activities. These include User Management, Device Management, and Firmware Upgrade Maintenance.

These activities can be accomplished using any of the KVM Over the NET™ switch GUI utilities. These include the Local Console; the browser-based Windows ActiveX Viewer; the browser-based Java Applet Viewer; the stand-alone Windows Client AP; and the stand-alone Java Client AP. Choose the approach that suits you best.

---

**Note:** Firmware Upgrade Maintenance cannot be performed from the local console. You must log in remotely with one of the KVM Over the NET™ switch other GUI utilities for this operation.

---



# Chapter 4

## Logging In

### Overview

---

KVM Over the NET™ switches can be accessed from a local console; an internet browser; a Windows application (AP) program; and a Java application (AP) program.

No matter which access method you choose, the KVM Over the NET™ switch's authentication procedure requires you to submit a valid username and password. If you supply an invalid login, the authentication routine will return an *Invalid Username or Password*, or *Login Failed* message. If you see this type of message, log in again with a correct username and password.

---

**Note:** If the number of invalid login attempts exceeds an amount specified by the switch's Super Administrator, a timeout period is invoked. You must wait until the timeout period expires before you can attempt to log in again. See *Login Failures*, page 138 for further details.

---

### Local Console Login

---

When the local console is attached (see *Single Stage Installation*, page 21) and there is no user logged in, the KVM Over the NET™ login screen appears on the display:



The image shows a login interface for a device labeled 'KN2124v'. It features a dark grey header with the text 'KN2124v Login'. Below the header, there are two input fields: 'Username:' followed by a text box with a cursor, and 'Password:' followed by a text box. At the bottom of the screen, there are two buttons: 'Login' and 'Reset'.

Simply key in your Username and Password, then click **Login** to bring up the Local Console Main Page. The Local Console Main Page is similar to the Web Browser, WinClient and Java Client Main Pages. For a description of the Web Browser Main Page, see page 45.

## Browser Login

---

The KVM Over the NET™ switch can be accessed via an Internet browser running on any platform. To access the switch, do the following:

1. Open the browser and specify the IP address of the switch you want to access in the browser's location bar.

---

**Note:** For security purposes, a login string may have been set by the administrator (see page 136 for details). If so, you must include a forward slash and the login string along with the IP address when you log in. For example:

192.168.0.100/kn4140v

If you don't know the IP address and login string, ask your Administrator.

---

2. When a Security *Alert* dialog box appears, accept the certificate – it can be trusted. (See *Trusted Certificates*, page 219, for details.) If a second certificate appears, accept it as well.

Once you accept the certificate(s), the login page appears:

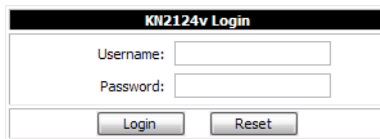

The image shows a web browser window displaying a login page for a device labeled 'KN2124v'. The page has a black title bar with the text 'KN2124v Login' in white. Below the title bar, there are two input fields: 'Username:' and 'Password:'. At the bottom of the page, there are two buttons: 'Login' and 'Reset'.

3. Provide your username and password (set by the administrator), then click **Login** to bring up the Web Main Page. For a discussion of the Web Main Page, see page 45.

## WinClient AP Login

In some cases, the Administrator may not want the KVM Over the NET™ switch to be available via browser access. The Windows AP Client allows direct remote access to Windows systems users, without having to go through a browser.

You initially download the Windows AP Client program from the browser page (see Chapter 10, *Download*). To connect to the KVM Over the NET™ switch, go to the location on your hard disk that you downloaded the Windows AP Client program to, and double-click its icon (*WinClient.exe*) to bring up the Windows Client Connection Screen:

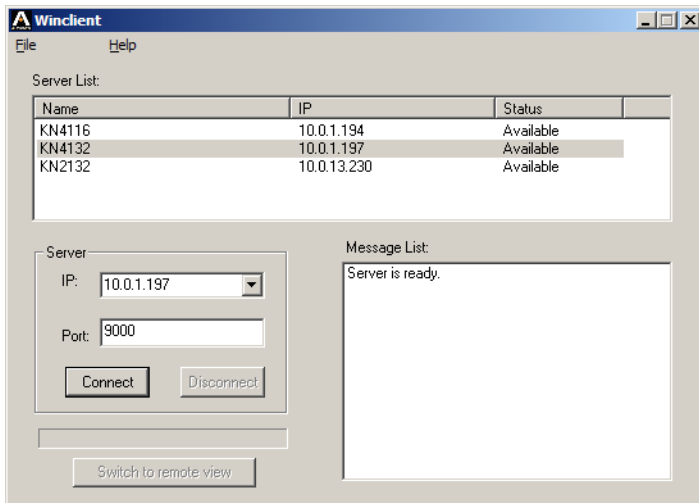

## The Connection Screen

A description of the Connection Screen is given in the following table:

Item	Description
Menu Bar	<p>The Menu Bar contains two items: File and Help.</p> <ul style="list-style-type: none"> <li>◆ The <i>File Menu</i> allows the operator to Create, Save, and Open user created Work files (see <i>The File Menu</i>, page 41).</li> <li>◆ The <i>Help Menu</i> displays the WinClient AP version.</li> </ul>
Server List	<p>Each time the WinClient.exe file is run, it searches the User's local LAN segment for KVM Over the NET™ units, and lists whichever ones it finds in this box. If you want to connect to one of these units, <b>double-click</b> it.</p> <p><b>Note:</b> 1. The switch will not appear in the list unless its <i>Enable Device List</i> configuration parameter has been enabled. See <i>Working Mode</i>, page 139 for details.</p> <p>2. Only units whose Access Port settings for <i>Program</i> (see <i>Service Ports</i>, page 125) match the number specified for <i>Port</i> in the Server area of this dialog box appear in the Server List window.</p>
Server	<p>This area is used when you want to connect to a KVM Over the NET™ switch at a remote location. You can drop down the IP list box and select an address from the list. If the address you want isn't listed, you can key in the target IP address in the IP field, and its port number in the Port field. (If you don't know the port number, contact your Administrator.)</p> <ul style="list-style-type: none"> <li>◆ When the IP address and Port number have been specified, click <b>Connect</b> to bring up a login dialog box. Provide your Username and Password then click <b>OK</b> to bring up the WinClient Main Page. For a description of the WinClient Main Page, see page 48.</li> <li>◆ When you have finished with your session, click <b>Disconnect</b> to end the connection.</li> </ul>
Message List	<p>Lists status messages regarding the connection to the KVM Over the NET™ switch.</p>
Switch to Remote View	<p>Once a connection with a KVM Over the NET™ switch has been established, this button becomes active. Click it to switch to the WinClient Main Page. The WinClient Main Page is described on page 48.</p>

---

## The File Menu

The *File Menu* allows the operator to Create, Save, and Open user created Work files. A Work File consists of all the information specified in a Client session. This includes the Server List and Server IP list items, as well as the Hotkey settings.

Whenever a user runs the Client program, it opens with the values contained in the *current work file*. The current work file consists of the values that were in effect the last time the program was closed.

The File menu consists of the following items:

New	Allows the user to create a named work file so its values will not be lost, and it will be available for future recall.
Open	Allows the user to open a previously saved work file and use the values contained in it.
Save	Allows the user to save the values presently in effect as the <i>current work file</i> .
Exit	Exits the WinClient.

## Java Client AP Login

In those cases in which the Administrator does not want the KVM Over the NET™ switch to be available via browser access, but the local client users aren't running Windows, the Java AP Client provides direct remote access to non-Windows systems users.

You initially download the Java AP Client program from the browser page (see Chapter 10, *Download*). To connect to the KVM Over the NET™ switch, go to the location on your hard disk that you downloaded the Java AP Client program to, and double-click its icon (JavaClient.jar) to bring up the *Address Input* dialog box:

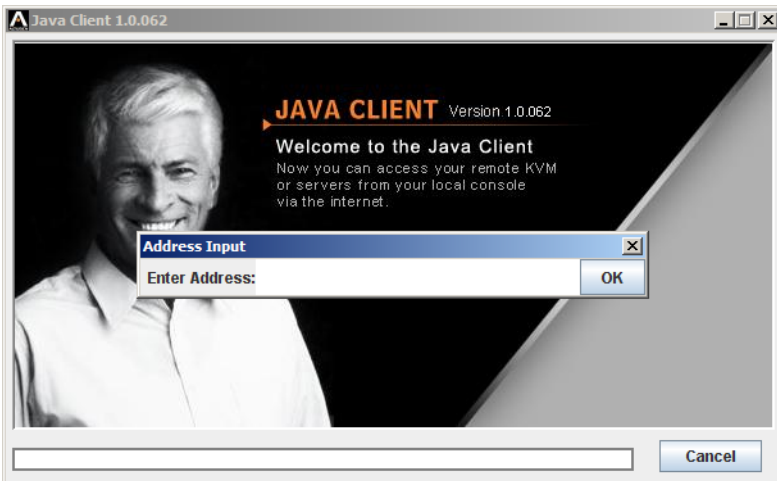

1. Key in the IP address for the unit you want to connect to. For example:

192.168.0.132

---

**Note:** If the system administrator set the switch's *Program* port to something other than the default you must specify the port number along with the IP address. For example: 192.168.0.132:9111  
See *Program*, page 125 for details.

---

Click **OK**. A *Login* dialog box appears:

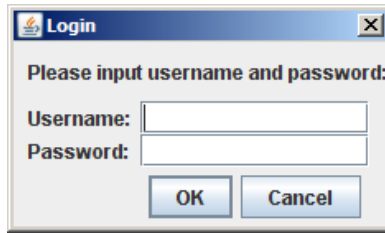

Provide a valid Username and Password, and then click **OK** to switch to the Java Client AP Main Page. The Java Client AP Main Page is similar to that of the WinClient AP Main Page. For a description of the Main Page, see page 48.

This Page Intentionally Left Blank



# Chapter 5

## The User Interface

### Overview

Once you have successfully logged in the KVM Over the NET™ user interface Main Page appears. The look of the page varies slightly, depending on which method you used to log in. Each of the interfaces is described in the sections that follow.

### The Web Browser Main Page

To ensure multi-platform operability, access to the KVM Over the NET™ switches can be accomplished with most standard web browsers. Once users log in and are authenticated (see page 38), the *Web Browser Main Page* comes up, with the Port Access page displayed:

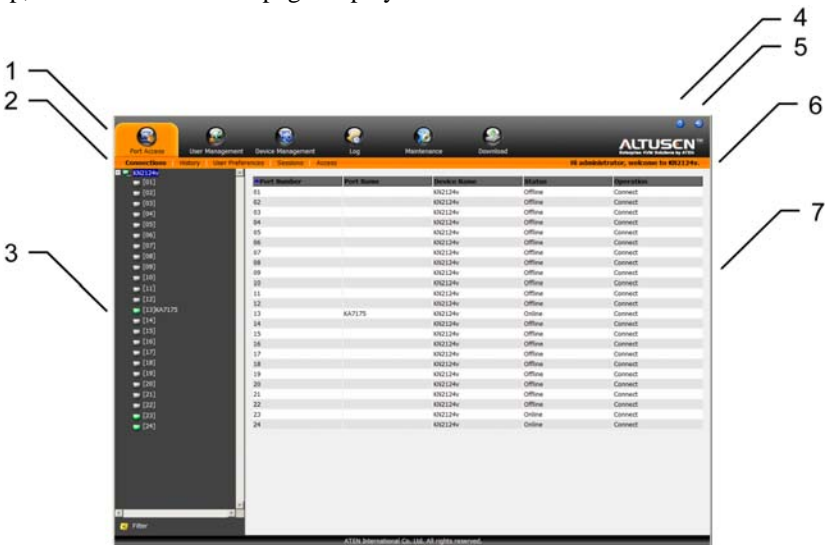

**Note:** 1. The screen depicts a Super Administrator's page. Depending on a user's type and permissions, not all of these elements appear.

2. When logging in from the Local Console, the *Maintenance* and *Download* icons do not appear, and *Array Mode* is not available (it is grayed out).

The web page components are described in the table below:







## **Page Components**

The web page screen components are described in the table, below:



<b>No.</b>	<b>Item</b>	<b>Description</b>
1	Tab Bar	The tab bar contains the KVM Over the NET™'s main operation categories. The items that appear in the tab bar are determined by the user's type, and the authorization options that were selected when the user's account was created.
2	Menu Bar	The menu bar contains operational sub-categories that pertain to the item selected in the tab bar. The items that appear in the menu bar are determined by the user's type, and the authorization options that were selected when the user's account was created.
3	Sidebar	<p>The Sidebar provides a tree view listing of ports that relate to the various tab bar and menu bar selections. Clicking a node in the Sidebar brings up a page with the details that are relevant to it.</p> <p>There is a <i>Filter</i> button at the bottom of the Sidebar that lets you expand or narrow the scope of the ports that appear in the tree. The Filter function is discussed in detail on page 90</p>
4	About	About provides information regarding the switch's current firmware version.
5	Logout	Click this button to log out of your KVM Over the NET™ session.
6	Welcome Message	If this function is enabled (see <i>Welcome Message*</i> , page 97), a welcome message displays here.
7	Interactive Display Panel	This is your main work area. The screens that appear reflect your menu choices and Sidebar node selection.

## The Tab Bar

The number and type of icons that appear on the Tab Bar at the top of the page are determined by the user's type (Super Administrator, Administrator, User) and the permissions assigned when the user's account was created. The functions associated with each of the icons are explained in the table below:

Icon	Function
	<b>Port Access:</b> The Port Access page is used to access and control the devices on the KVM Over the NET™ installation. This page is available to all users.
	<b>User Management:</b> The User Management page is used to create and manage Users and Groups. It can also be used to assign devices to them. User Management is discussed on page 105. This page is available to the Super Administrator and Administrators. The icon doesn't display on the page of ordinary users.
	<b>Device Management:</b> The Device Management page is used by the Super Administrator (and Administrators and Users with Configuration permission) to configure and control the overall operation of the KVM Over the NET™ switch. This page is available to the Super Administrator. The icon doesn't display on the page of ordinary administrators and users.
	<b>Log:</b> The Log page displays the contents of the log file. The Log page is discussed on page 98.
	<b>Maintenance:</b> The Maintenance page is used this icon to install new versions of the KVM Over the NET™ switch's firmware. See <i>Upgrading the Main Firmware</i> , page 148, for details. This page is available to the Super Administrator (and Administrators and Users with Configuration permission). The icon doesn't display on the page of ordinary administrators and users.
	<b>Download:</b> Users with appropriate permission can click this icon to download AP versions of the Windows Client; the Java Client; the Log Server; and the PON program. This page is available to all users. The programs that can be downloaded depend on the user's permissions.

There are two small icons at the extreme right of the page. Their functions are described in the table, below:

Icon	Function
	Click this icon to bring up a panel with information about the KVM Over the NET™ switch firmware version.
	Click this icon to log out and end your KVM Over the NET™ switch session.

## The GUI Main Page

With WinClient AP, and Java Client AP access, once users log in (see *Logging In*, page 37), the *GUI Main Page* comes up:

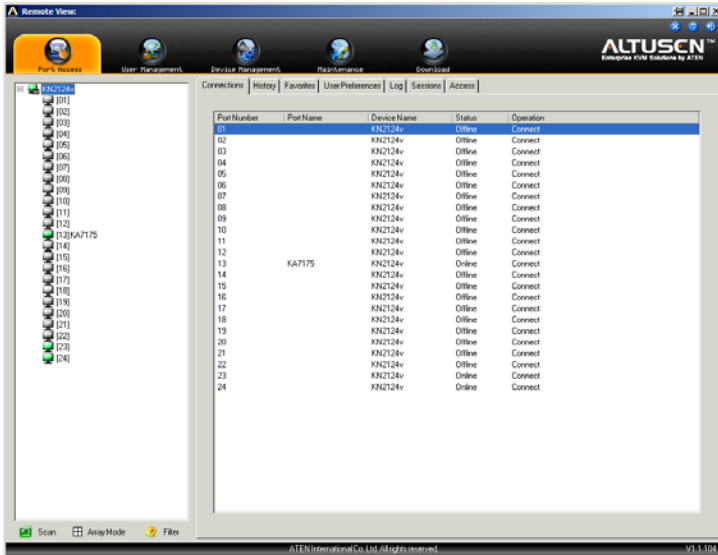

The GUI Main Page is similar to that of the Web Browser. The differences between them are as follows:

1. The GUI version doesn't have a menu bar below the tab bar; it has a series of tabs like a notebook, instead. Like the Web Browser interface, however, the makeup of the tabbed notebook changes depending on the items selected on the main Tab Bar and in the Sidebar.
2. The GUI version doesn't have a *Log* tab on the icon bar. (It's *Log* tab can be found in the notebook under the *Port Access* Tab – see *Log*, page 98.)
3. In addition to *Filter*, there are also buttons for *Scan* and *Array Mode* at the bottom of the Sidebar. These functions are discussed in Chapter 6, *Port Access*.
4. There is a hidden *Control Panel* at the upper or lower center of the screen that becomes visible when you mouse over it. (The default is at the upper center of the screen.)

5. There is an additional icon at the extreme right of the page: . Click this icon to close the GUI Main Page and go to the display of the last selected port.
6. The GUI can be navigated via the keyboard as shown in the table, below:

Keys	Action
Ctrl + P	Opens the Port Access page.
Ctrl + U	Opens the User Management page.
Ctrl + C	Opens the Device Management page.
Ctrl + F	Opens the Maintenance page.
Ctrl + D	Opens the Download page.
F1	To see <i>About</i> information
F2	To edit the port name of the selected port.
F4	Selects the Sidebar (left) panel.
F5	Selects the main (right) panel
F7	Closes the GUI.
F8	To log out.

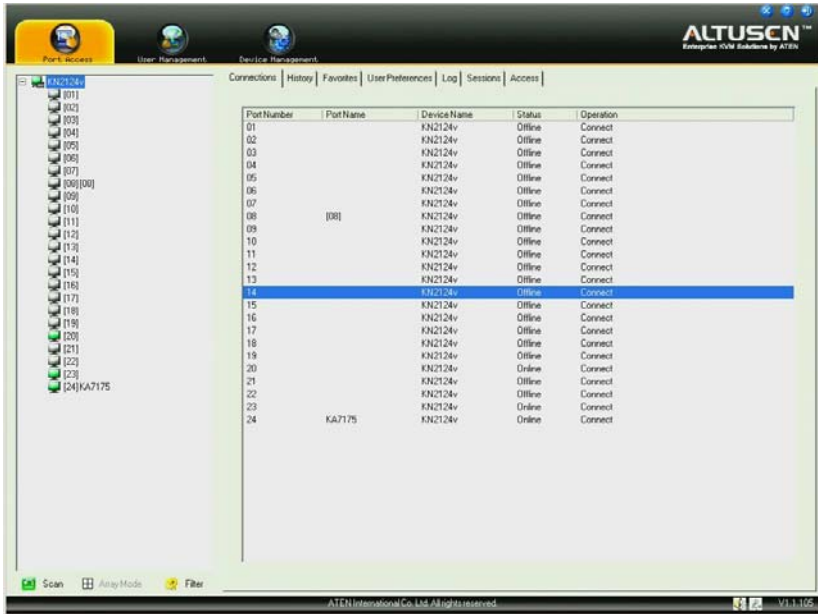

## The Local Console GUI Main Page

The Local Console GUI Main Page is similar to the Java and Windows GUI Main Page:



The major difference is that the Local Console Main Page doesn't have tabs for *Maintenance* or *Download*, and *Array Mode* isn't available.

In addition, there are two small icons at the bottom right – as described in the following table.

Icon	Function
	Speaker. Allows sound output from the servers connected to the switch's ports to be heard on the speakers connected to the Local Console. Click the icon to toggle speaker support On and Off. When Off, a red X displays across the icon.
	Microphone. Allows microphone input from the Local Console to be sent to the servers connected to the switch's ports. Click the icon to toggle microphone support On and Off. When Off, a red X displays across the icon.

---

## The Control Panel

---

### WinClient Control Panel

Since the WinClient ActiveX Viewer and WinClient AP Control Panel contains the most complete functionality of all the user interface control panels, this section describes the WinClient Control Panel. Although the other control panels may not have all of the features that this one does, you can refer to the information described here when using them.

The WinClient Control Panel consists of three rows: a row of icons at the top, with two text rows below it:



---

**Note:** The above image shows the complete Control Panel. The icons that appear can be customized. See *Control Panel Configuration*, page 78, for details.

---

- ♦ By default, the top text row shows the video resolution of the remote display. As the mouse pointer moves over the icons in the icon bar, however, the information in the top text row changes to describe the icon's function. In addition, if a message from another user is entered in the message board, and you have not opened the message board in your session, the message will appear in the top row.
- ♦ The lower row shows the IP address of the device you are accessing at the left. In the center of the bar, the number before the slash indicates which bus the user is on, while the number behind the slash indicates the number of users on that bus.

---

**Note:** See *Multiuser Operation*, page 163 for further information regarding the KVM Over the NET™ switch's bus assignments.

---

(Continues on next page.)

(Continued from previous page.)

- ◆ Right clicking in the text row area brings up a menu that allows you to select options for the *Screen Mode*, *Zoom*, *Mouse Pointer* type, and *Mouse Sync Mode*. These functions are discussed in the sections that follow.

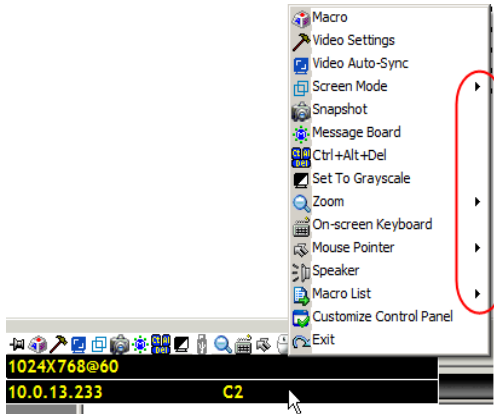



















- ◆ To move the Control Panel to a different location on the screen, place the mouse pointer over the text bar area, then click and drag.



## WinClient Control Panel Functions

The Control Panel functions are described in the table below.

Icon	Function
	This is a toggle. Click to make the Control Panel persistent – i.e., it always displays on top of other screen elements. Click again to have it display normally.
	Click to bring up the Macros dialog box (see page 55 for details).
	Click to bring up the Video Options dialog box. Right-click to perform a quick Auto Sync (see <i>Video Settings</i> , page 64, for details).
	Click to perform a video and mouse autosync operation. It is the same as clicking the Auto-sync button in the <i>Video Options</i> dialog box (see <i>Video Settings</i> , page 64).
	Toggles the display between <i>Full Screen Mode</i> and <i>Windowed Mode</i> .
	Click to take a snapshot (screen capture) of the remote display. See <i>Snapshot</i> , page 79, for details on configuring the Snapshot parameters.
	Click to bring up the Message Board (see <i>The Message Board</i> , page 67).
	Click to send a Ctrl+Alt+Del signal to the remote system.
	Click to toggle the remote display between color and gray scale views.
	<p>Click to bring up the <i>Virtual Media</i> dialog box. The icon changes when a virtual media device is started on the port. See <i>Virtual Media</i>, page 70, for specific details.</p> <p>Note: 1. This icon is displayed on the KN2124v, KN2140v, KN4124v and KN4140v switches only.</p> <p>2. This icon displays in gray when the function is disabled or not available.</p>
	<p>Click to zoom the remote display window.</p> <p><b>Note:</b> This feature is only available in windowed mode (Full Screen Mode is off). See <i>Zoom</i>, page 73, for details.</p>
	Click to bring up the on-screen keyboard (see <i>The On-Screen Keyboard</i> , page 74).

	<p>Click to select the mouse pointer type.</p> <p><b>Note:</b> This icon changes depending on which mouse pointer type is selected (see <i>Mouse Pointer Type</i>, page 75).</p>
	<p>Click to toggle Automatic or Manual mouse sync.</p> <ul style="list-style-type: none"> <li>◆ When the selection is <i>Automatic</i>, a green ✓ appears on the icon.</li> <li>◆ When the selection is <i>Manual</i>, a red X appears on the icon.</li> </ul> <p>See <i>Mouse DynaSync Mode</i>, page 76 for a complete explanation of this feature.</p>
	<p>Click to toggle sound from the remote server to be heard on the client computer's speakers on or off. The "prohibited" symbol (a red circle with a diagonal bar) displays on the icon when the speaker is toggled Off.</p>
	<p>Click to display a dropdown list of <i>User</i> macros. Access and run macros more conveniently rather than using the Macros dialog box (see the <i>Macros</i> icon in the table above, and the <i>Macros</i> section on page 55).</p>
	<p>Click to bring up the Control Panel Configuration dialog box. See <i>Control Panel Configuration</i>, page 78, for details on configuring the Control Panel.</p>
	<p>Click to exit the viewer.</p> <ul style="list-style-type: none"> <li>◆ Exiting from a viewer accessed session brings you back to the web browser Main Page.</li> <li>◆ Exiting from a WinClient AP session logs you out and brings you back to the login dialog box (see page 39).</li> <li>◆ Exiting from a Java Client AP session logs you out and closes the Java program.</li> </ul>
	<p>These icons show the Num Lock, Caps Lock, and Scroll Lock status of the remote computer.</p> <ul style="list-style-type: none"> <li>◆ When the lock state is <i>On</i>, the LED is bright green and the lock hasp is closed.</li> <li>◆ When the lock state is <i>Off</i>, the LED is dull green and the lock hasp is open.</li> </ul> <p>Click on the icon to toggle the status.</p> <p><b>Note:</b> These icons and your local keyboard icons are in sync. Clicking an icon causes the corresponding LED on your keyboard to change accordingly. Likewise, pressing a Lock key on your keyboard causes the icon's color to change accordingly.</p>



## Macros

The Macros icon provides access to three functions found in the Macros dialog box: Hotkeys, User Macros, and System Macros. Each of these functions is described in the following sections.

### Hotkeys

Various actions related to manipulating the remote server can be accomplished with hotkeys. The *Hotkey Setup* utility (accessed by clicking this icon), lets you configure which hotkeys perform the actions.

The actions are listed in the left panel; the hotkeys that invoke them are shown in the panel at the right. Use the checkbox to the left of an action's name to enable or disable its hotkey.

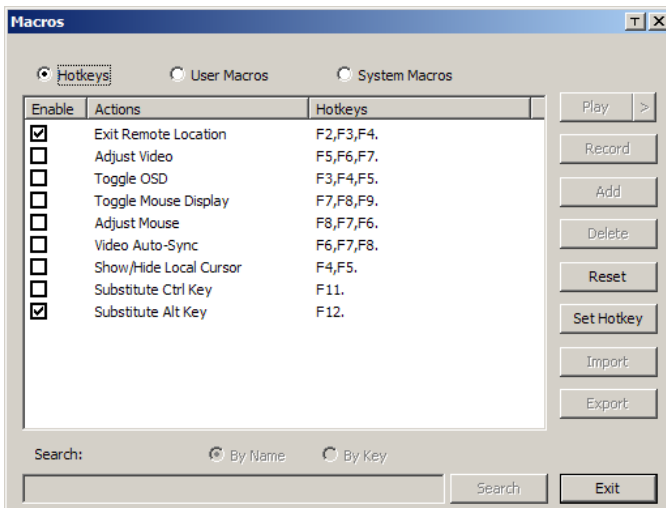

1. Highlight an *Action*, then click **Set Hotkey**.
2. Press your selected Function keys (one at a time). The key names appear in the *Hotkeys* field as you press them.
  - ◆ You can use the same function keys for more than one action, as long as the key sequence is not the same.
  - ◆ To cancel setting a hotkey value, click **Cancel**; to clear an action's Hotkeys field, click **Clear**.
3. When you have finished keying in your sequence, click **Save**.

To reset all the hotkeys to their default values, click **Reset**.

An explanation of the Hotkey actions is given in the table below:

Action	Explanation
Exit remote location	Breaks the connection to the KVM Over the NET™ switch and returns you to local client computer operation. This is equivalent to clicking the <i>Exit</i> icon on the Control Panel. The default keys are F2, F3, F4.
Adjust Video	Brings up the <i>Video Settings</i> dialog box. This is equivalent to clicking the <i>Video Settings</i> icon on the Control Panel. The default keys are F5, F6, F7.
Toggle OSD	Toggles the Control Panel Off and On. The default keys are F3, F4, F5.
Toggle mouse display	If you find the display of the two mouse pointers (local and remote) to be confusing or annoying, you can use this function to shrink the non-functioning pointer down to a barely noticeable tiny circle, which can be ignored. Since this function is a toggle, use the hotkeys again to bring the mouse display back to its original configuration. This is equivalent to selecting the <i>Dot</i> pointer type from the <i>Mouse Pointer</i> icon on the Control Panel. The default keys are F7, F8, F9. <b>Note:</b> The Java Control Panel does not have this feature.
Adjust mouse	This synchronizes the local and remote mouse movements. The default keys are F7, F8, F9.
Video Auto-sync	This combination performs an auto-sync operation. It is equivalent to clicking the <i>Video Autosync</i> icon on the Control Panel. The default keys are F6, F7, F8.
Show/Hide Local Cursor	Toggles the display of your local mouse pointer off and on. This is equivalent to selecting the <i>Null</i> pointer type from the <i>Mouse Pointer</i> icon on the Control Panel. The default keys are F4,F5.
Substitute Ctrl key	If your local client computer captures Ctrl key combinations, preventing them from being sent to the remote server, you can implement their effects on the remote server by specifying a function key to substitute for the Ctrl key. If you substitute the F11 key, for example, pressing [F11 + 5] would appear to the remote server as [Ctrl + 5]. The default key is F11.
Substitute Alt key	Although all other keyboard input is captured and sent to the KVM Over the NET™ switch, [Alt + Tab] and [Ctrl + Alt + Del] work on your local client computer. In order to implement their effects on the remote server, another key may be substituted for the Alt key. If you substitute the F12 key, for example, you would use [F12 + Tab] and [Ctrl + F12 + Del]. The default key is F11.

## User Macros

User Macros are used to perform specific actions on the remote server. To create the macro, do the following:

1. Select *User Macros*, then click **Add**.

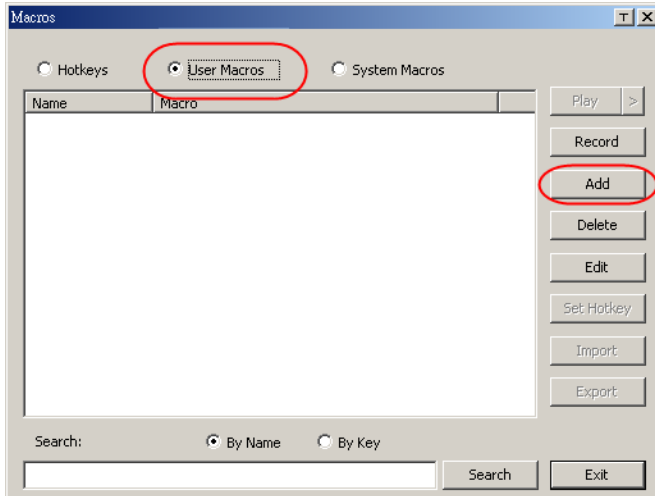

2. In the dialog box that comes up, replace the “New Macro” text with a name of your choice for the macro:

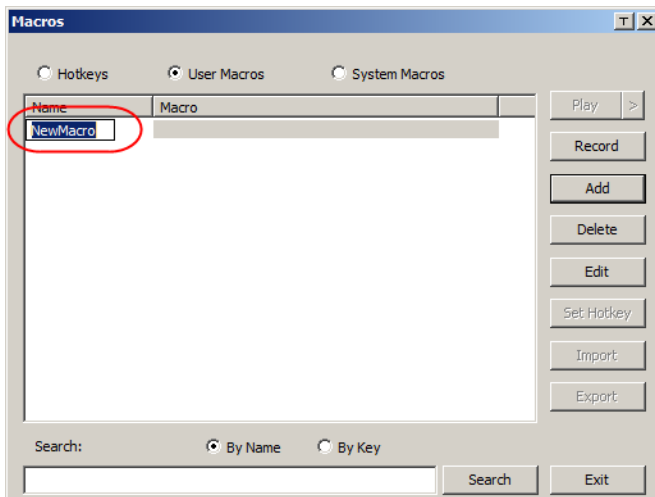

### 3. Click **Record**.

The dialog box disappears, and a small panel appears at the top left of the screen:

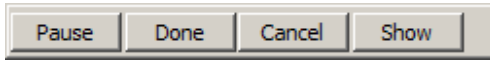

### 4. Press the keys for the macro.

- ◆ To pause macro recording, click **Pause**. To resume, click **Pause** again.
- ◆ Clicking **Show** brings up a dialog box that lists each keystroke that you make, together with the amount of time each one takes:

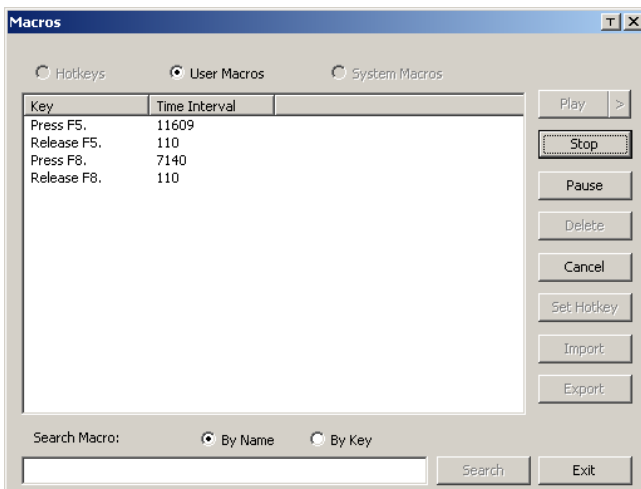

- ◆ Clicking **Cancel** cancels all keystrokes.
- ◆ When you have finished, click **Stop**. This is the equivalent of clicking *Done* in Step 5.

---

**Note:** 1. Case is not considered – typing **A** or **a** has the same effect.

2. When recording the macro the focus must be on the remote screen. It cannot be in the macro dialog box.
  3. Only the default keyboard characters may be used. Alternate characters cannot be used. For example, if the keyboard is Traditional Chinese and default character is **A** the alternate Chinese character obtained via keyboard switching is not recorded.
-

5. If you haven't brought up the Show dialog, click **Done** when you have finished recording your macro. You return to the Macros dialog box with your system macro key presses displayed in the Macro column:

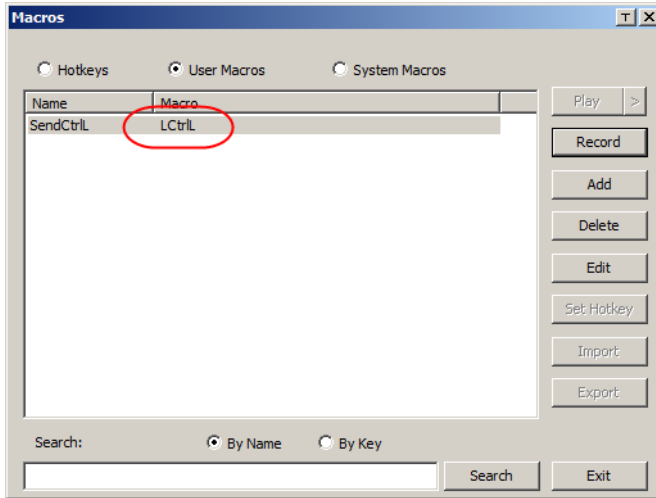

6. If you want to change any of the keystrokes, select the macro and click **Edit**. This brings up a dialog box similar to the one for Show. You can change the content of your keystrokes, change their order, etc.
7. Repeat the procedure for any other macros you wish to create.

After creating your macros, you can run them in any of three ways:

1. By using the hotkey (if one was assigned).
2. By opening the Macro List on the Control Panel and clicking the one you want (see page 54).
3. By opening this dialog box and clicking **Play**.

If you run the macro from this dialog box, you have the option of specifying how the macro runs.

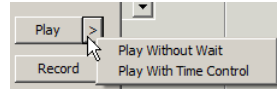

- ◆ If you choose *Play Without Wait*, the macro runs the keypresses one after another with no time delay between them.
- ◆ If you choose *Play With Time Control*, the macro waits for the amount of time between key presses that you took when you created it. Click on the arrow next to *Play* to make your choice.
- ◆ If you click *Play* without opening the list, the macro runs with the default choice. The default choice (*NoWait* or *TimeCtrl*), is shown in the *Playback* column.

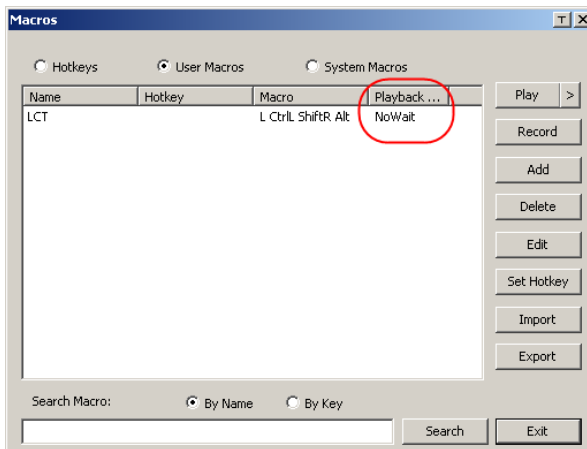

You can change the default choice by clicking on the current choice (*NoWait* in the screenshot above), and selecting the alternative choice.

**Note:** 1. Information about the Search function is given on page 61.

2. User Macros are stored on the Local Client computer of each user. Therefore there is no limitation on the of number of macros, the size of the macro names, or makeup of the hotkey combinations that invoke them



## ■ Search

Search, at the bottom of the dialog box, lets you filter the list of macros that appear in the large upper panel for you to play or edit. Click a radio button to choose whether you want to search by name or by key; key in a string for the search; then click **Search**. All instances that match your search string appear in the upper panel.

## System Macros

System Macros are used to create exit macros for when you close a session. For example, as an added measure of security, you could create a macro that sends the Winkey-L combination which would cause the remote server's log in page to come up the next time the device was accessed. To create the macro, do the following:

1. Select *System Macros*, then click **Add**.

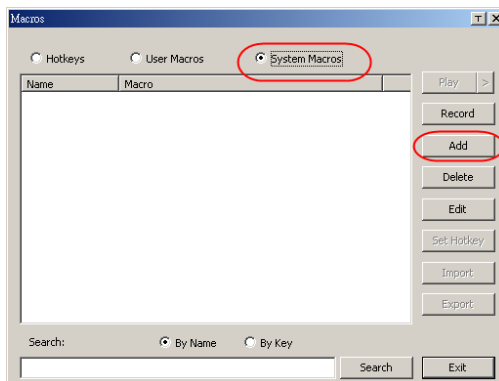

2. In the dialog box that comes up, replace the “New Macro” text with a name of your choice for the macro:

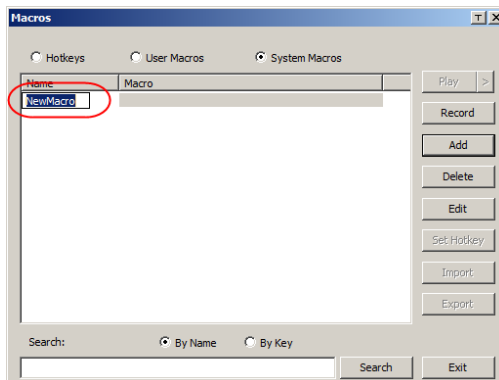

### 3. Click **Record**.

The dialog box disappears, and a small panel appears at the top left of the screen:

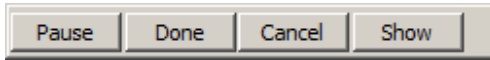

### 4. Press the keys for the macro.

- ◆ To pause macro recording, click **Pause**. To resume, click **Pause** again.
- ◆ Clicking **Show** brings up a dialog box that lists each keystroke that you make, together with the amount of time each one takes (see page 62).

---

**Note:** 1. Case is not considered – typing **A** or **a** has the same effect.

2. When recording the macro the focus must be on the remote screen. It cannot be in the macro dialog box.
  3. Only the default keyboard characters may be used. Alternate characters cannot be used. For example, if the keyboard is Traditional Chinese and default character is **A** the alternate Chinese character obtained via keyboard switching is not recorded.
- 

### 5. If you haven't brought up the Show dialog, click **Done** when you have finished recording your macro. You return to the Macros dialog box with your system macro key presses displayed in the Macro column:

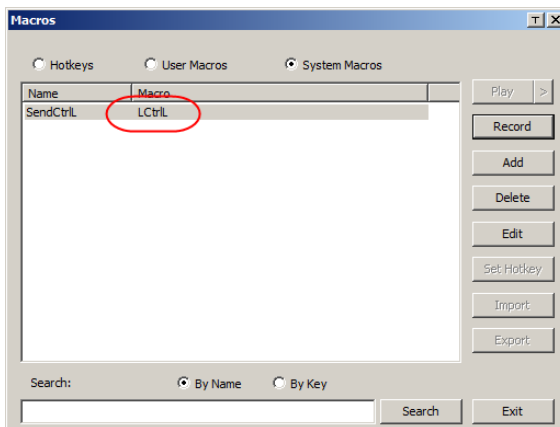

### 6. If you want to change any of the keystrokes, select the macro and click **Edit**. This brings up a dialog box similar to the one for Show. You can change the content of your keystrokes, change their order, etc.

7. Repeat the procedure for any other macros you wish to create.

Once the system macros have been created, they are available for use on a port-by-port basis. They get selected on a port's *Connection* page (see *Exit Macro*, page 92, for details).

---

**Note:** 1. Information about the Search function is given on page 61.

2. You can choose only one system macro per port.

3. Systems macros are stored on the switch, therefore macro names may not exceed 64 Bytes; hotkey combinations may not exceed 256 Bytes; each key usually takes 3–5 Bytes.

---



## Video Settings

Clicking the *Hammer* icon on the Control Panel brings up the *Video Settings* dialog box. The options in this dialog box allow you to adjust the placement and picture quality of the remote screen on your monitor:

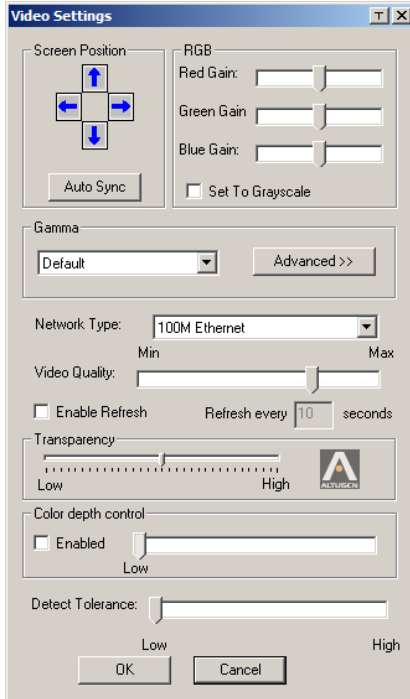

The meanings of the video adjustment options are given in the table below:

Options	Usage
Screen Position	Adjust the horizontal and vertical position of the remote server window by Clicking the Arrow buttons.
Auto-Sync	<p>Click Auto-Sync to have the vertical and horizontal offset values of the remote screen detected and automatically synchronized with the local screen.</p> <p><b>Note:</b></p> <ol style="list-style-type: none"> <li>1. If the local and remote mouse pointers are out of sync, in most cases, performing this function will bring them back into sync.</li> <li>2. This function works best with a bright screen.</li> <li>3. If you are not satisfied with the results, use the Screen Position arrows to position the remote display manually.</li> </ol>

Options	Usage
RGB	<p>Drag the slider bars to adjust the RGB (Red, Green, Blue) values. When an RGB value is increased, the RGB component of the image is correspondingly increased.</p> <p>If you enable <i>Set to Grayscale</i>, the remote video display is changed to grayscale.</p>
Gamma	<p>This section allows you to adjust the video display's gamma level. This function is discussed in detail in the next section, <i>Gamma Adjustment</i>.</p>
Network Type	<p>Select the type of internet connection that the local client computer uses. The switch will use that selection to automatically adjust the <i>Video Quality</i> and <i>Detect Tolerance</i> settings to optimize the quality of the video display.</p> <p>Since network conditions vary, if none of the pre-set choices seem to work well, you can select <i>Customize</i> and use the Video Quality and Detect Tolerance slider bars to adjust the settings to suit your conditions.</p>
Video Quality	<p>Drag the slider bar to adjust the overall Video Quality. The larger the value, the clearer the picture and the more video data goes through the network. Depending on the network bandwidth, a high value may adversely effect response time.</p>
Enable Refresh	<p>The KVM Over the NET™ switch can redraw the screen every 1 to 99 seconds, eliminating unwanted artifacts from the screen. Select <b>Enable Refresh</b> and enter a number from 1 through 99. The KVM Over the NET™ switch will redraw the screen at the interval you specify. This feature is disabled by default. Click to put a check mark in the box next to <i>Enable Refresh</i> to enable this feature.</p> <p><b>Note:</b></p> <ol style="list-style-type: none"> <li>1. The switch starts counting the time interval when mouse movement stops.</li> <li>2. Enabling this feature increases the volume of video data transmitted over the network. The lower the number specified, the more often the video data is transmitted. Setting too low a value may adversely affect overall operating responsiveness.</li> </ol>
Transparency	<p>Adjusts the transparency of the Control Panel and other Toolbars. Slide the bar until the display in the example window is to your liking.</p>
Color Depth Control	<p>This setting determines the richness of the video display by adjusting the amount of color information.</p>
Detect Tolerance	<p>This setting also relates to video quality. It governs detecting or ignoring pixel changes. A high setting can result in a lower quality display due to less data transfer. A lower setting will result in better video quality, but setting the threshold too low may allow too much data to be transferred, negatively impacting network performance.</p>

## Gamma Adjustment

If it is necessary to correct the gamma level for the remote video display, use the *Gamma* function of the Video Adjustment dialog box.

- Under *Basic* configuration, there are ten preset and four user-defined levels to choose from. Drop down the list box and choose the most suitable one.
- For greater control, clicking the *Advanced* button brings up the following dialog box:

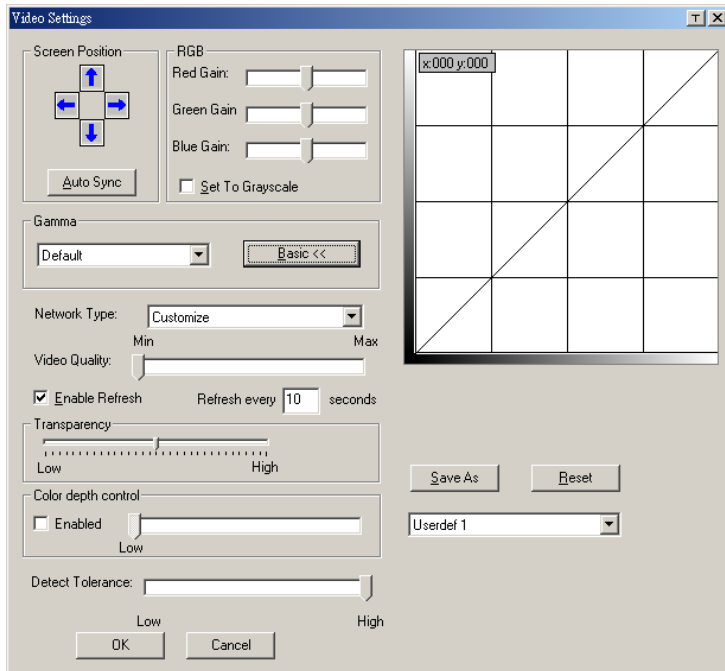

- Click and drag the diagonal line at as many points as you wish to achieve the display output you desire.
- Click **Save As** to save up to four user-defined configurations derived from this method. Saved configurations can be recalled from the list box at a future time.
- Click **Reset** to abandon any changes and return the gamma line to its original diagonal position.
- Click **OK** to save your changes and close the dialog box.
- Click **Cancel** to abandon your changes and close the dialog box.

---

**Note:** For best results, change the gamma while viewing a remote server.

---





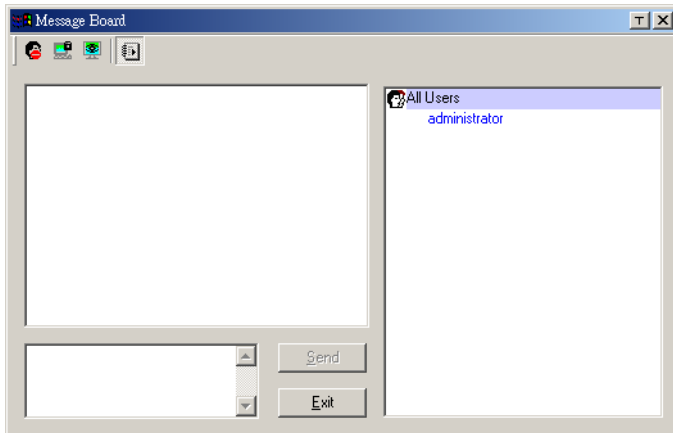

## The Message Board

The KVM Over the NET™ switch supports multiple user logins, which can possibly give rise to access conflicts. To alleviate this problem, a message board feature has been provided, allowing users to communicate with each other:



## Button Bar

The buttons on the Button Bar are toggles. Their actions are described in the table below:

Button	Action
	<p><b>Enable/Disable</b> Chat. When disabled, messages posted to the board are not displayed. The button is shadowed when Chat is disabled. The icon displays next to the user's name in the User List panel when the user has disabled Chat.</p>
	<p><b>Occupy/Release</b> Keyboard/Video/Mouse. When a port is set to <i>Occupy</i> mode (see <i>Access Mode</i>, page 87), you can use this button to occupy the KVM. When you Occupy the KVM, other users cannot see the video, and cannot input keyboard or mouse data. The button is shadowed when the KVM is occupied. The icon displays next to the user's name in the User List panel when the user has occupied the KVM.</p>
	<p><b>Occupy/Release</b> Keyboard/Mouse. When a port is set to <i>Occupy</i> mode (see <i>Access Mode</i>, page 87), you can use this button to occupy the KM. When you Occupy the KM, other users can see the video, but cannot input keyboard or mouse data. The button is shadowed when the KM is occupied. The icon displays next to the user's name in the User List panel when the user has occupied the KM.</p>
	<p><b>Show/Hide</b> User List. When you Hide the User List, the User List panel closes. The button is shadowed when the User List is open.</p>

## Message Display Panel

Messages that users post to the board - as well as system messages - display in this panel. If you disable Chat, however, messages that get posted to the board won't appear.

## Compose Panel

Key in the messages that you want to post to the board in this panel. Click **Send**, or press **[Enter]** to post the message to the board.



## User List Panel

The names of all the logged in users are listed in this panel.

- ◆ Your name appears in blue; other users' names appear in black.
- ◆ By default, messages are posted to all users. To post a message to one individual user, select the user's name before sending your message.
- ◆ If a user's name is selected, and you want to post a message to all users, select All Users before sending your message.
- ◆ If a user has disabled Chat, its icon displays before the user's name to indicate so.
- ◆ If a user has occupied the KVM or the KM, its icon displays before the user's name to indicate so.

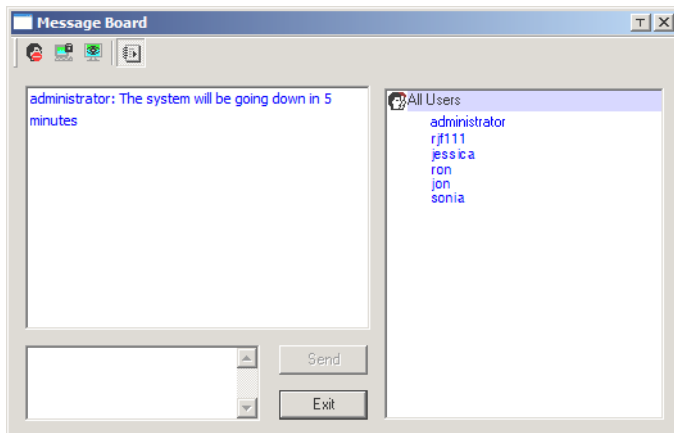



## Virtual Media

The *Virtual Media* feature allows a drive, folder, image file, or removable disk on a user's system to appear and act as if it were installed on the remote server.

---

**Note:** Virtual Media is only supported on remote servers connected to the KVM Over the NET™ switch with KA7175 or KA7176 adapter cables.

---

To implement this redirection feature, do the following:

1. Click this icon to bring up the *Virtual Media* dialog box:

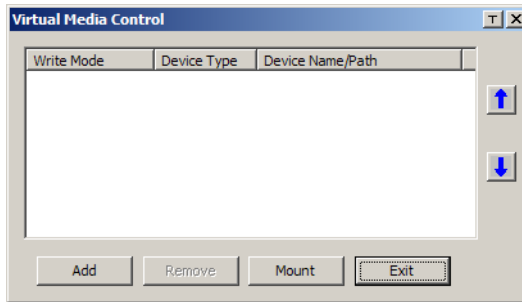



---

**Note:** The **T** button at the top right brings up a slider to adjust the transparency of the dialog box. After making your adjustment, click anywhere in the dialog box to dismiss the slider.

---

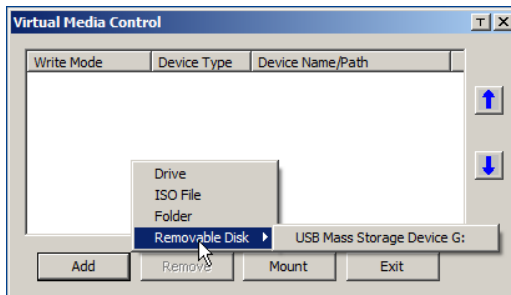
2. Click **Add**; then select the media source.



Depending on your selection, additional dialog boxes appear to enable you to select the drive, file, folder, or removable disk you desire. See *Virtual Media Support*, page 229 for details about mounting each of these media types.

- To add additional media sources, click **Add**, and select the source as many times as you require.

Up to three virtual media choices can be mounted. The top three in the list are the ones that are selected. To rearrange the selection order, highlight the device you want to move, then click the Up or Down Arrow button to promote or demote it in the list.

- Read* refers to the redirected device being able to send data to the remote server; *Write* refers to the redirected device being able to have data from the remote server written to it. The default is for Write to not be enabled (Read only). If you want the redirected device to be writable as well as readable, click to put a check in the *Enable Write* checkbox:

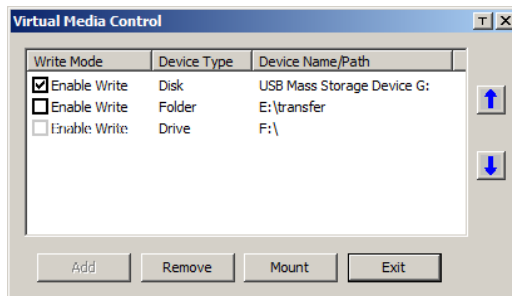



---

**Note:** 1. If a redirected device cannot be written to, it appears in gray in the list.

- See *Virtual Media Support*, page 229, for a list of supported virtual media types.
- 

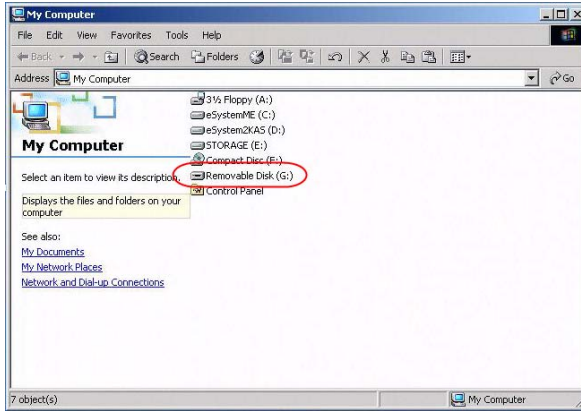
- To remove an entry from the list, select it and click **Remove**.
- After you have made your media source selections, click **Mount**. The dialog box closes. The virtual media devices that you have selected are redirected to the remote server, where they show up as drives, files and folders on the remote server's file system.





Once mounted, you can treat the virtual media as if they were really on the remote server – drag and drop files to/from them; open files on the remote server for editing and save them to the redirected media, etc.

Files that you save to the redirected media, will actually be saved on your local client computer's storage. Files that you drag from the redirected media will actually come from your local client computer's storage.

5. To end the redirection, bring up the *Control Panel* and click on the Virtual Media icon. All mounted devices are automatically unmounted.

## Virtual Media Icons

The Virtual Media icon on the Windows Client Control Panel changes, depending on the type of drive used, as shown in the table below:

Icon	Function
	The icon displays in gray to indicate that the virtual media function is disabled or not available
	The icon displays in blue to indicate that the virtual media function is available. Click the icon to bring up the virtual media dialog box.
	The icon displays in blue with a red X to indicate that a virtual media device has been mounted on the remote server. Click the icon to unmount all redirected devices.



## Zoom

The Zoom icon controls the zoom factor for the remote view window. Settings are as follows:

Setting	Description
100%	Sizes and displays the remote view window at 100%.
75%	Sizes and displays the remote view window at 75%.
50%	Sizes and displays the remote view window at 50%.
25%	Sizes and displays the remote view window at 25%.
1:1	Sizes and displays the remote view window at 100%. The difference between this setting and the 100% setting is that when the remote view window is resized its contents don't resize – they remain at the size they were. To see any objects that are outside of the viewing area move the mouse to the window edge, to have the screen scroll. <b>Note:</b> The 1:1 Zoom size is not available in the Java Applet Viewer or the Java Client AP.



## The On-Screen Keyboard

The KVM Over the NET™ switch supports an on-screen keyboard, available in multiple languages, with all the standard keys for each supported language. Click this icon to pop up the on-screen keyboard:

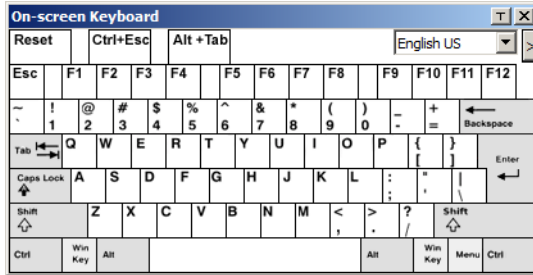

One of the major advantages of the on-screen keyboard is that if the keyboard languages of the remote and local systems aren't the same, you don't have to change the configuration settings for either system. The user just has to bring up the on-screen keyboard; select the language used by the server on the port he is accessing; and use the on-screen keyboard to communicate with it.

**Note:** You must use your mouse to click on the keys. You cannot use your actual keyboard.

To change languages, do the following:

1. Click the down arrow next to the currently selected language, to drop down the language list.

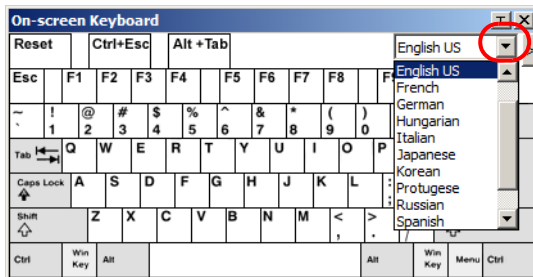

2. Select the new language from the list.

To display/hide the expanded keyboard keys, click the arrow to the right of the language list arrow.

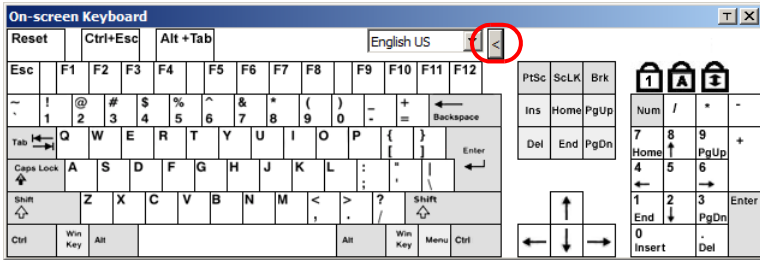

## Mouse Pointer Type

KVM Over the NET™ switches offer a number of mouse pointer options when working in the remote display. Click this icon to select from the available choices:

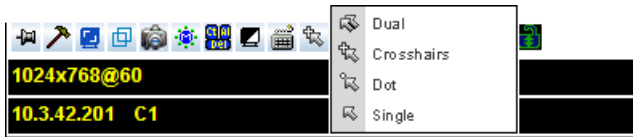

**Note:** 1. Before accessing a port, only Dual and Crosshairs are available. Once the port is accessed, all four pointers are available.

2. The icon on the Control Panel changes to match your choice.
3. Selecting the Dot pointer has the same effect as the *Toggle mouse display* hotkey function (see *Toggle mouse display*, page 56, for details).
4. The Dot pointer is not available with the Java Applet Viewer or the Java Client AP.



## **Mouse DynaSync Mode**

Synchronization of the local and remote mouse pointers is accomplished either automatically or manually.



### **Automatic Mouse Synchronization (DynaSync)**

*Mouse DynaSync* provides automatic locked-in synching of the remote and local mouse pointers – eliminating the need to constantly resync the two movements.

**Note:** This feature is only available for Windows and Mac systems (G4 and higher) whose adapter attribute OS setting is configured for Win or Mac (see *Port Properties*, page 86), which are connected to the switch with one of the following Adapter Cables: KA7170, KA7175, KA7176, or KA9170.

All other configurations must use manual mouse synchronization (described in the next section).

The icon on the toolbar indicates the synchronization mode status as follows:

Icon	Function
	This icon displays in gray to indicate that Mouse DynaSync is not available – you must use manual synching procedures. This is the default setting for all KVM Adapters other than the KA7170, KA7175, KA7176, and KA9170.
	The green check mark on this icon indicates that Mouse DynaSync is available and is <b>enabled</b> . This is the default setting when Mouse DynaSync is available. (See the Note, above.)
	The red X on this icon indicates that Mouse DynaSync is available but is <b>not enabled</b> .

When *Mouse DynaSync* is available, clicking the icon toggles its status between enabled and /disabled. If you choose to disable Mouse DynaSync mode, you must use the manual synching procedures described in the next section.



## Mac and Linux Considerations

For Mac systems, there is a second DynaSync setting to choose from when Mouse DynaSync is enabled. If the default synchronization result is not satisfactory, try the **Mac 2** setting. To select Mac 2, right click in the text area of the Control Panel and select *Mouse Sync Mode* → *Automatic for Mac 2*:

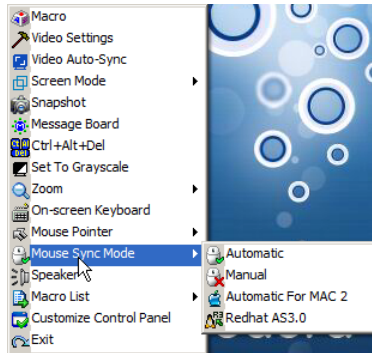

Linux doesn't support DynaSync Mode, but it has an additional setting on the Mouse Sync Mode menu (Redhat AS3.0). If you are using one of the USB Adapter Cables (see the Note on the previous page), and the default mouse synchronization is not satisfactory, you can try the Redhat AS3.0 setting. In either case, you must perform the manual mouse synchronization procedures described in the next section.

## Manual Mouse Synchronization

If the local mouse pointer goes out of sync with the remote system's mouse pointer there are a number of methods to bring them back into sync:

1. Perform a video and mouse auto sync by clicking the *Video Settings* icon on the Control Panel (see page 64).
2. Perform an *Auto Sync* with the Video Adjustment function (see *Video Settings*, page 64, for details).
3. Invoke the *Adjust Mouse* function with the *Adjust Mouse* hotkeys (see *Adjust mouse*, page 56, for details).
4. Move the pointer into all 4 corners of the screen (in any order).
5. Drag the Control Panel to a different position on the screen.
6. Set the mouse speed and acceleration for each problematic server attached to the switch. See *Additional Mouse Synchronization Procedures*, page 216, for instructions.

## Control Panel Configuration

Clicking the *Control Panel* icon brings up a dialog box that allows you to configure the items that appear on the Control Panel, as well as its graphical settings:

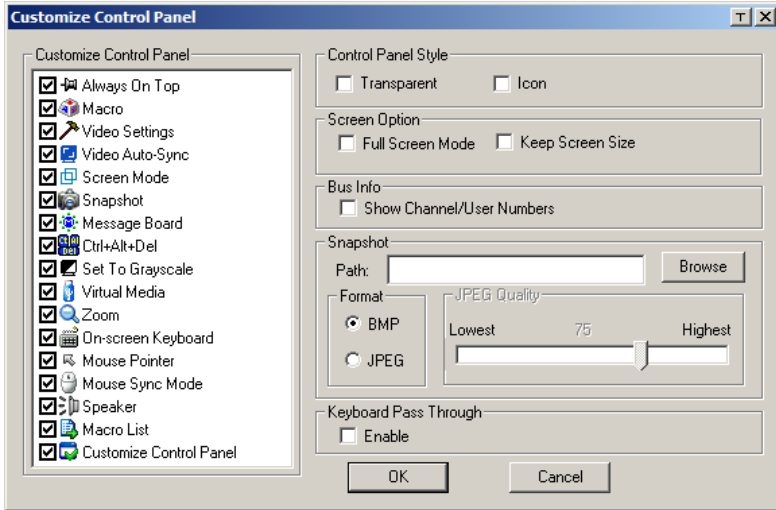

The dialog box is organized into six main sections as described in the table, below:

Item	Description
Customize Control Panel	Allows you to select which icons display in the Control Panel
Control Panel Style	<ul style="list-style-type: none"> <li>◆ Enabling <i>Transparent</i> makes the Control Panel semi-transparent, so that you can see through it to the display underneath.</li> <li>◆ Enabling <i>Icon</i> causes the Control Panel to display as an icon until you mouse over it. When you mouse over the icon, the full panel comes up.</li> </ul>

*(Continues on next page.)*

(Continued from previous page.)

Item	Description
Screen Options	<ul style="list-style-type: none"> <li>◆ If <i>Full Screen Mode</i> is enabled, the remote display fills the entire screen.</li> <li>◆ If <i>Full Screen Mode</i> is not enabled, the remote display appears as a window on the local desktop. If the remote screen is larger than what is able to fit in the window, move the mouse pointer to the screen border that is closest to the area you want to view and the screen will scroll.</li> <li>◆ If <i>Keep Screen Size</i> is enabled, the remote screen is not resized.               <ul style="list-style-type: none"> <li>◆ If the remote resolution is smaller than that of the local monitor, its display appears like a window centered on the screen.</li> <li>◆ If the remote resolution is larger than that of the local monitor, its display is centered on the screen. To access the areas that are off screen, move the mouse to the corner of the screen that is closest to the area you want to view and the screen will scroll.</li> </ul> </li> <li>◆ If <i>Keep Screen Size</i> is not enabled, the remote screen is resized to fit the local monitor's resolution.</li> </ul>
Bus Info	<p>If <i>Bus Info</i> is enabled, the number of the bus you are on, as well as the total number of users on the bus, displays on the bottom row center of the Control Panel as follows: Bus No./Total Users. (See the Control Panel diagram on page 51 for an example.)</p>
Snapshot	<p>These settings let the user configure the KN2124v / KN2140v / KN4124v / KN4140v / KN2132 / KN4116 / KN4132's screen capture parameters (see the <i>Snapshot</i> description under <i>The Control Panel</i>, page 51):</p> <ul style="list-style-type: none"> <li>◆ Path lets you select a directory that the captured screens automatically get saved to. Click <b>Browse</b>; navigate to the directory of your choice; then click <b>OK</b>. If you don't specify a directory here, the snapshot is saved to your desktop.</li> <li>◆ Click a radio button to choose whether you want the captured screen to be saved as a BMP or a JPEG (JPG) file.</li> <li>◆ If you choose JPEG, you can select the quality of the captured file with the slider bar. The higher the quality, the better looking the image, but the larger the file size.</li> </ul>
Keyboard Pass Through	<p>When this is enabled, the Alt-Tab key press is passed to the remote server and affect that server. If it is not enabled, Alt-Tab acts on your local client computer.</p>

## The Java Control Panel

The Java Applet Viewer and Java Client AP Control Panel is similar to the one used by the WinClient:

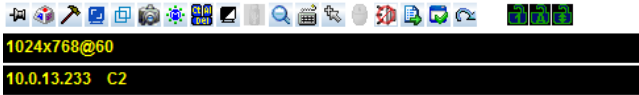

The major differences between them are:

- ◆ In the Macros dialog box, *Toggle Mouse Display* is not available.
- ◆ The *Dot* mouse pointer type is not available.
- ◆ The 1:1 Zoom feature is not available.
- ◆ The Message Board:
  - ◆ There is no *Show/Hide* button to show or hide the user list. This function is achieved by clicking the arrows at the top of the bar that separates the User List panel from the Main panel.
  - ◆ If another user sends a message to the message board and your message board is not open, instead of the message appearing in the text bar, a window showing the message pops up on your screen.
- ◆ In Virtual Media, only ISO and Folder are supported. See *Java Applet Viewer / Java Client AP*, page 229 for further details.
- ◆ The Control Panel *Lock LED* icons are not in sync with your keyboard. When you first connect, the LED display may not be accurate. To be sure, click on the LED icons to set them.
- ◆ In *Control Panel Configuration*, the following functions are not available: the *Transparent* control panel style; *Screen Options*; and *Keyboard Passthrough*. The BMP Snapshot format has been replaced by PNG.



# Chapter 6 Port Access

## Overview

When you log in to the switch the *Port Access* page comes up with the *Connections* page displayed.

## Web Browser Interface

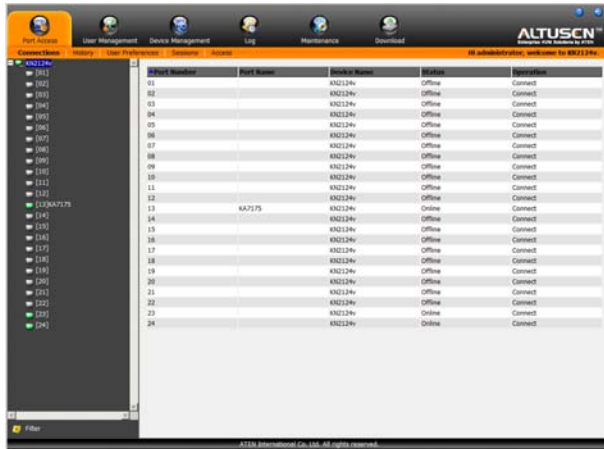

## GUI Interface

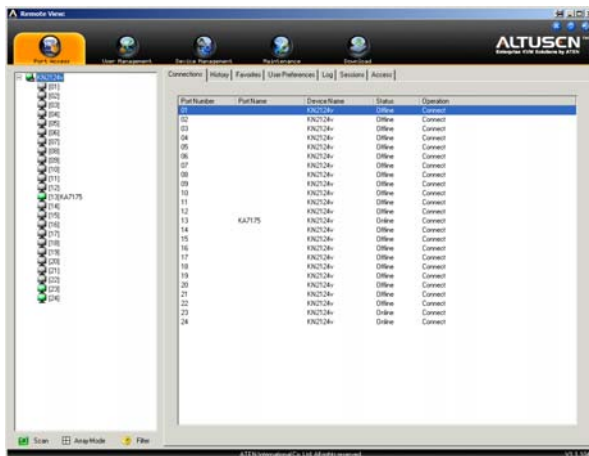

The page is organized into several main areas. All the ports that a user is permitted to access are listed in the Sidebar at the left of the page. At the bottom of the Sidebar, there are buttons for different port display functions.

The tabs at the top of the main panel open different pages for information and configuration options related to the ports. The main panel provides a detailed listing of each port, as well as a means of accessing the ports.

## The Port Selection Sidebar

All switches and their ports – including cascaded switches and their ports – are listed in a tree structure in the Sidebar at the left of the screen:

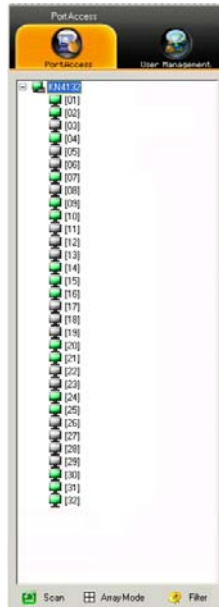

### The Port Selection Tree

- ◆ Users are only allowed to see the switches and ports that they have access permission for.
- ◆ Ports and child switches can be nested under their parent switches. Click the + in front of a switch to expand the tree and see the ports nested underneath it. Click the - to collapse the tree and hide the nested ports.
- ◆ A port's ID number is displayed in brackets next to the port icon. For convenience the ports can be named (see *Port Naming*, page 88, for details).
- ◆ Switches and ports that are on line have their monitor screen icons lit green; the monitor screens are gray for devices and ports that are offline.
- ◆ To access a port, double click its icon. Port operation details are discussed in Chapter 11, *Port Operation*.

## **Port Views**

In the Web Browser version, you can open as many port viewers as there are ports, but the number of ports that you see depends on the number of buses that the switch supports. For example, if the switch supports 4 buses, the 5th viewer displays the same port as the 1st viewer; the 6th viewer displays the same screen as the 2nd viewer, etc.

In the GUI version you can only access one port at a time. To see two different ports, you would have to log in two separate times.

## **Port Utilities**

The GUI version Port Access page provides a convenient method to manipulate the device tree. When you right click an item in the Sidebar, a list with various options pops up:

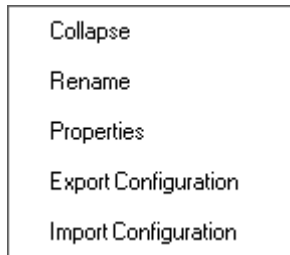

---

**Note:** The screenshot shows an example of just one of the pop-ups that can appear. The items that you see depend on whether you are logged in from a Local Console, or remotely; your user type; and whether you selected a switch or a port. The table below lists and explains all of the possibilities.

---



The meanings of the pop-up items are explained in the following table:

Item	User Type	Explanation
Expand/ Collapse	Administrators Users	<ul style="list-style-type: none"> <li>◆ If the device's ports are nested (not displayed), the dialog box entry is <i>Expand</i>. Click <b>Expand</b> to open the tree and display the ports.</li> <li>◆ If the device's ports are displayed, the dialog box entry is <i>Collapse</i>. Click <b>Collapse</b> to nest the ports.</li> </ul> <p><b>Note:</b> 1. This item only appears for switches or ports that have child devices connected to them.</p> <p>2. This has the same effect as clicking the + or - in the tree view.</p>
Rename	Administrators Users	For convenience – especially in large installations with many switches and ports – each switch and each port can be given a name. See <i>Port Naming</i> , page 88, for details.
Copy	Administrators Users	This item is only available for ports. After selecting Copy, you can Paste the port into the Favorites page. See <i>Adding a Favorite</i> , page 94, for details.
Properties	Administrators	<p>This item allows you to configure the properties for a switch or port.</p> <ul style="list-style-type: none"> <li>◆ For switches, clicking this item takes you to the Device Management page. See <i>Device Management</i>, page 121, for configuration details.</li> <li>◆ For ports, a dialog box opens allowing you to make configuration settings for that port. See <i>Port Properties</i>, page 86, for details.</li> </ul>
Export Configuration	Administrators	This item is only available through a remote login and is only available for switches. It allows you to save the configuration settings for the switch in an external file ( <i>SysConfig.cfg</i> ). Simply click <b>Export Config</b> ; browse to where you want to save the file; then click <b>Save</b> .
Import Configuration	Administrators	This item is only available through a remote login and is only available for switches. It imports previously saved configuration settings. Click <b>Import Config</b> . In the dialog box that comes up, browse to where the saved configuration file is located; select the setting components you wish to import; then click <b>Import</b> .
Mount	Administrators Users	This item is only available through a Local Console login. It appears when a USB device is plugged into the switch's USB port and allows you to mount the device and make it available to users logged into the installation.

## Port Properties

When you select **Properties** from the popup menu, a dialog box that allows you to make configuration settings for the selected port appears:

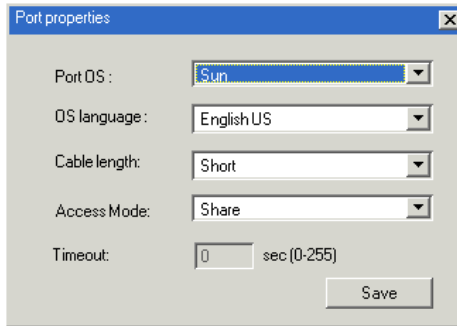

---

**Note:** This is a quick setting method that performs the same port configuration functions as the ones found under *Adapter Attributes* on the Device Management *Customization* page. See *Customization*, page 138, for details.

---

*(Continues on next page.)*

(Continued from previous page.)

An explanation of the configuration fields is given in the table, below:

Field	Explanation
Port OS	Specifies the operating system that the server on the connected port is using. Choices are Win, Mac, Sun, and Other. The default is Win.
OS Language	Specifies the OS language being used by the server on the connected port. Drop down the list to see the available choices. The default is English US.
Cable Length	Specifies the length of the Cat5e cable that is used to connect the server to the port. Choices are Short (less than 10 m), Medium (10–25 m), and Long (greater than 25 m). The default is Short. <b>Note:</b> Cable length can affect video quality. Generally speaking, shorter cables offer better quality. This setting is designed to compensate for longer or shorter cable lengths. You can experiment to find the setting that best suits your connection.
Access Mode	Defines how the port is to be accessed when multiple users have logged on, as follows: <b>Exclusive:</b> The first user to switch to the port has exclusive control over the port. No other users can view the port. The <i>Timeout</i> function does not apply to ports which have this setting. <b>Occupy:</b> The first user to switch to the port has control over the port. However, additional users may view the port's video display. If the user who controls the port is inactive for longer than the time set in the <i>Timeout</i> box, port control is transferred to the next user to move the mouse or strike the keyboard. <b>Share:</b> Users simultaneously share control over the port. Input from the users is placed in a queue and executed chronologically. Under these circumstances, users can take advantage of the <i>Message Board</i> , which allows a user to take control of the keyboard and mouse or keyboard, mouse, and video of a Share port (see <i>The Message Board</i> , page 67).
Timeout	This field sets a time threshold for users on ports whose Access Mode has been set to <i>Occupy</i> (see <i>Access Mode</i> – above, in this table). If there is no activity from the user occupying the port for the amount of time set here, the user is timed out and the port is released. The first user to send keyboard or mouse input after the port has been released gets to occupy the port. Input a value from 0 to 255 seconds. The default is 3 seconds. A setting of 0 causes the port to be released the instant there is no input.

After making your configuration choices, click **Save** to save your new settings and close the dialog box.

## Port Naming

For convenience – especially in large installations with many switches and ports – each switch and each port can be given a name. To assign, modify or delete a port name, do the following:

1. Click once on the port you want to edit; wait a second; then click again.

---

**Note:** 1. This is not a double-click. It involves two separate clicks. A double-click will switch you to the device attached to the port.

2. In the GUI version you can right click on the port you want to edit, then select **Rename** in the popup box that appears.
- 

– or –

Press **F2**

After a second or two, the port field changes to provide a text input box:



2. Key in a name for the port (or change/delete a previous one). The maximum number of characters allowed for a port name is 20. You can use any combination of letters, numbers, and symbols on the typewriter keys of keyboards with PC US English layout.

- When you have finished editing the port name, press **[Enter]** or click anywhere outside of the input box to complete the operation.

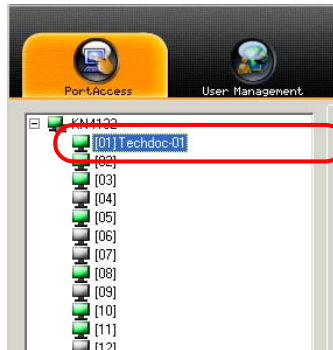

## **Scan**

*Scan* is found at the bottom of the GUI Sidebar. It automatically switches among all the ports that are visible in the Sidebar tree (see *Filter*, below), at regular intervals, so that their activity can be monitored automatically. See *Auto Scanning*, page 158 for details.

---

**Note:** This item doesn't appear at the bottom of the Sidebar in the Web Browser version. You must invoke it from the port's *Toolbar*. See *The Port Toolbar*, page 156, for details.

---

## **Array**

*Array* is found at the bottom of the GUI Sidebar. It represents another way of monitoring port activity. Under this function your screen is divided into a grid of panels, with each panel representing. Only ports that are visible in the Sidebar tree (see *Filter*, below), and that are on line are displayed – all other ports are blank. See *Panel Array Mode*, page 161, for details.

---

**Note:** This item doesn't appear at the bottom of the Sidebar in the Web Browser version. You must invoke it from the port's *Toolbar*. See *The Port Toolbar*, page 156, for details.

---

## Filter

*Filter* allows you to control the number and type of ports that display in the Sidebar Tree, as well as which ports get scanned when Auto Scan and Array Mode is invoked (see *Scan* and *Array*, above). When you click *Filter*, the bottom of the panel changes to look similar to the figure, below:

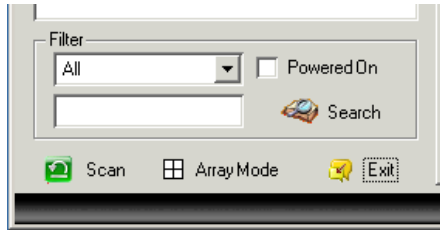

The meanings of the choices are explained in the table, below:

Choices	Explanation
All	This is the default view. With no other filter options selected, all of the ports that are accessible to the user are listed in the Sidebar tree.  If any <i>Favorites</i> have been specified (see page 94), you can drop down the list box and select Favorites instead of All. If you select Favorites, only the items you have selected as Favorites display in the tree.
Powered On	If you enable <i>Powered On</i> (by putting a check in the checkbox) only the ports that have their attached devices powered on display in the tree.
Search	If you key in a search string and click <b>Search</b> , only port names that match the search string display in the tree. Wildcards (? and *) are acceptable, so that more than one port can show up in the list. For example, if you key in <b>Web*</b> , both Web Server 1 and Web Server 2 show up in the list.
Exit	Clicking <b>Exit</b> closes the filter dialog.

## Connections

The Connections page displays port status information at the device level, and port connection configuration options at the port level.

### Device Level

When a KVM Over the NET™ switch is selected in the Sidebar tree, the Connections page displays a list of ports for the device that the user is authorized to access or view.

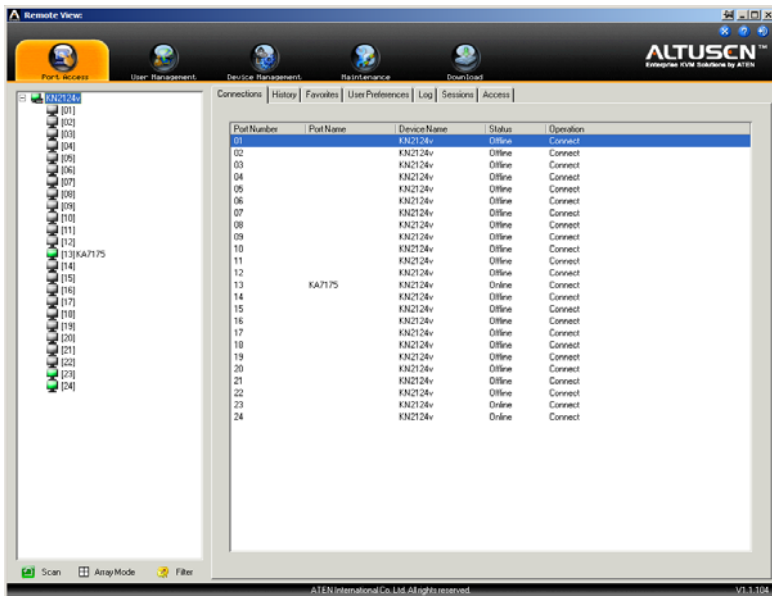

The following attributes are listed for each device:

- ◆ Port Number – the port's number on the switch.
- ◆ Port Name – if a name has been assigned to a port it displays here.
- ◆ Device Name – if a name has been assigned to a switch it displays here.
- ◆ Status – the current status of the switch – online, or offline.
- ◆ Operation – Connect means you can access the port by double clicking anywhere on its line entry.

**Note:** In the Web Browser version, the sort order of the information displayed can be changed by clicking the column headings.

## Port Level

When a port is selected in the Sidebar tree, the Connections page changes to display the port connection and configuration options:

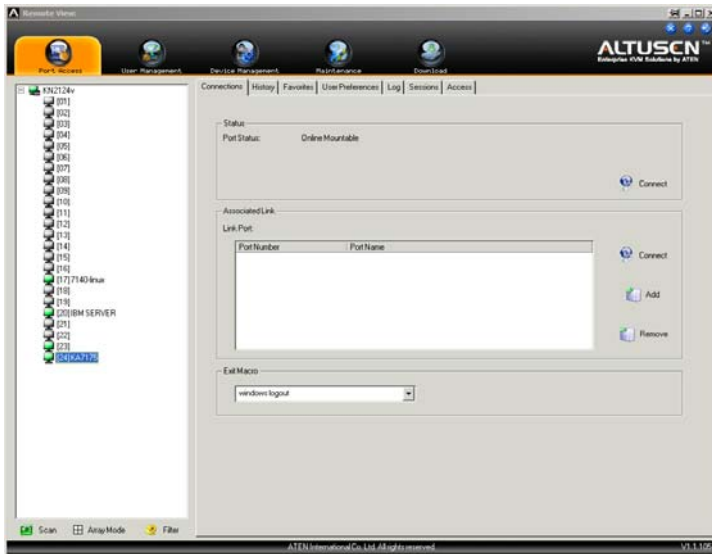

The screen is divided into three major panels, as described in the table below:

Panel	Description
Status	<p>The Status Panel displays the port's current status information, including whether the port is online or offline, and if the port is mountable.</p> <p>Click the <b>Connect</b> button to view the port display via the switch's built-in Win Viewer (when using Windows Internet Explorer), or Java Viewer (when using other web browsers).</p>
Associated Link	<p>The Associated Link Panel provides a method of associating other ports on the same switch to the selected port. This function is primarily intended to be used when connecting both KVM and serial ports (KA7140, KA9140) from a single server to the switch. Click <b>Add</b> to add a desired associated port. To remove an unwanted associated port, select it and click <b>Remove</b>. To connect to a port, select it, and click <b>Connect</b>.</p>
Exit Macro	<p>The Exit Macro Panel contains a dropdown listbox of <i>System</i> macros. You can select a macro from the list that will execute when exiting the port. See <i>System Macros</i>, page 61 for details on creating exit macros.</p> <p>The macro only executes after the last user accessing the port exits the port.</p>



## History

The History page provides a record of each time that a port was accessed.

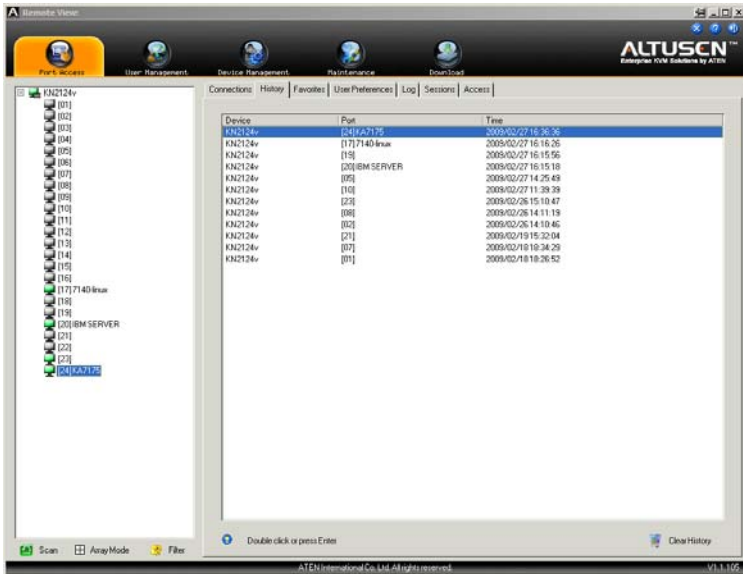

- ◆ If there are more entries than there is room on the screen, a scroll bar appears to let you scroll up and down to see the entire record.
- ◆ To clear the record and start over, click the *Clear History* button at the bottom right of the page.

**Note:** 1. In the Web Browser version, the sort order of the information displayed can be changed by clicking the column headings.

2. You can access a port by double clicking it.

## Favorites

The *Favorites* page is similar to a bookmarks feature. Ports that you frequently visit can be saved in a list here. Simply open this page and select the port – rather than hunting for it in the Sidebar tree. This feature is especially handy on large, crowded installations:

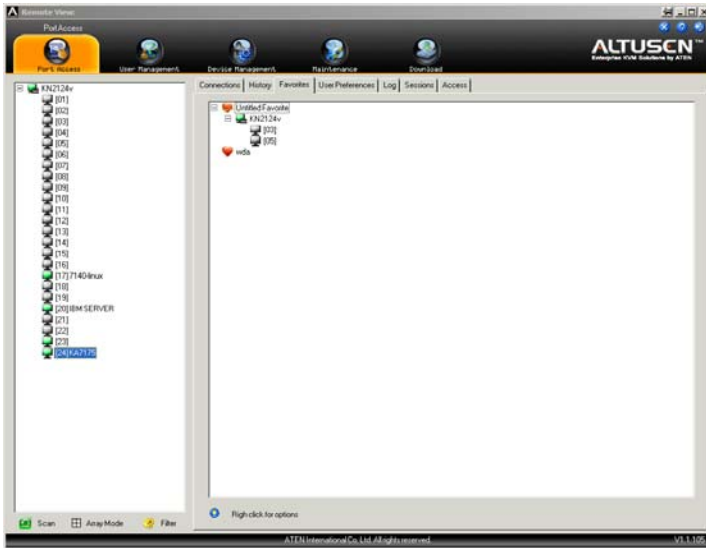

**Note:** This feature is only available in the GUI version.

### Adding a Favorite

To add a port to the favorites, do the following:

1. Right click in the main panel; click **Add Favorite**.

An *Untitled Favorite* entry is appears at the top of the panel.

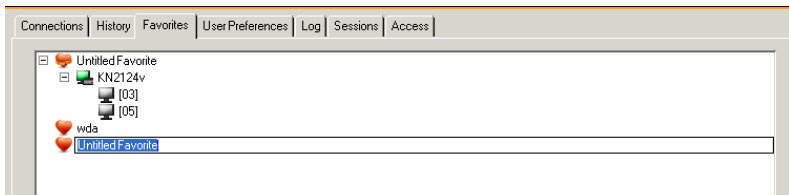

This will be a container to hold your port entries, so you will want to give it an appropriate name.

2. Click inside the text entry box to erase *Untitled Favorite* and key in an appropriate name.
3. To add a port:

Drag it from the Sidebar and drop it onto the container, or Right Click on it in the Sidebar; select **Copy**. Right click on the container; select **Paste**.

The switch that the port belongs to is added to the container; the selected port is appended under the switch.

---

**Note:** To add multiple ports at the same time, hold the Shift or Ctrl key down while you make your Sidebar selections then drag or copy the entire group to the Favorites panel.

---

4. Repeat step 3 for any other *Favorite* categories you wish to create

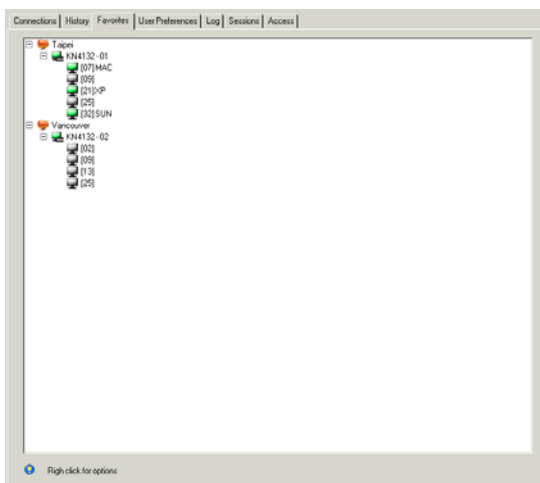

---

**Note:** Favorites can be selected for filtering in the Sidebar tree. See *Filter*, page 90, for details.

---

### Modifying a Favorite

- ◆ To modify a Favorite, or one of the items contained in it, right click on it, then select a choice from the popup menu that appears.
- ◆ To simply edit a Favorite's name, click on it once, wait a second, then click again. You can edit the name after the display changes to provide a text input box, This is the same procedure as the one described for port naming (see *Port Naming*, page 88).

## User Preferences

The *User Preferences* page allows users to set up their own, individual, working environments. The switch stores a separate configuration record for each user profile, and sets up the working configuration according to the *Username* that was keyed into the Login dialog box:

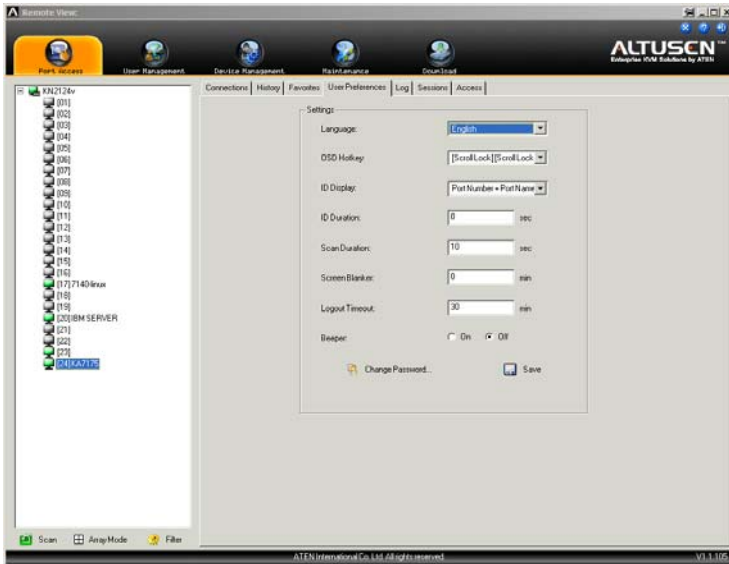

The page settings are explained in the following table:

Setting	Function
Language	Selects the language that the interface displays in.
OSD Hotkey	Selects which Hotkey controls the GUI function: [Scroll Lock] [Scroll Lock], or [Ctrl] [Ctrl]. Since the Ctrl key combination may conflict with programs running on the local client computers or servers, the default is the Scroll Lock combination.
ID Display	Selects how the Port ID is displayed: the Port Number alone (PORT NUMBER); the Port Name alone (PORT NAME); or the Port Number plus the Port Name (PORT NUMBER + PORT NAME). The default is PORT NUMBER + PORT NAME.

*(Continues on next page.)*

(Continued from previous page.)

Setting	Function
ID Duration	Determines how long a Port ID displays on the monitor after a port change has taken place. You can choose an amount from 1—255 seconds. The default is 3 Seconds. A setting of 0 (zero) means the Port ID is always on.
Scan Duration	Determines how long the focus dwells on each port as it cycles through the selected ports in Auto Scan Mode (see <i>Auto Scanning</i> , page 158). Key in a value from 1—255 seconds. The default is 5 seconds; a setting of 0 disables the Scan function.
Screen Blanker	If there is no input from the console for the amount of time set with this function, the screen is blanked. Key in a value from 1—30 minutes. A setting of 0 disables this function. The default is 0 (disabled). <b>Note:</b> Although this function can be set from either the local console or a remote login, it only affects the local console monitor.
Logout Timeout	If there is no user input for the amount of time set with this function, the user is automatically logged out. A login is necessary before the KVM Over the NET™ switch can be accessed again.
Beeper	When set to ON, the beeper sounds whenever a Port is changed; when activating the Auto Scan function (see <i>Auto Scanning</i> , page 158); or if only a single power line is connected (or only a single power switch is On) – see <i>Device Information</i> , page 122. The default is ON.
Viewer*	You can choose which viewer is used when accessing a server: <ul style="list-style-type: none"> <li>◆ <b>Auto Detect</b> will select the appropriate viewer based on the web browser used; WinClient for Windows Internet Explorer, Java Client for other web browsers (ex. Firefox).</li> <li>◆ <b>Java Client</b> will open the Java based viewer regardless of the web browser being used.</li> </ul>
Welcome Message*	You can choose to hide or show the welcome message displayed in the submenu bar. The default is disabled.
Save	Click <b>Save</b> to save any changes made to the User Preferences settings.
Changing a Password	To change a user's password, key in the old password and new password into the input boxes, then click <b>Change Password</b> to apply the change.

\* This item is only available with the Web Browser version.

## Log

The KVM Over the NET™ switch logs all the events that take place on it. The Log page displays the information in the log file:

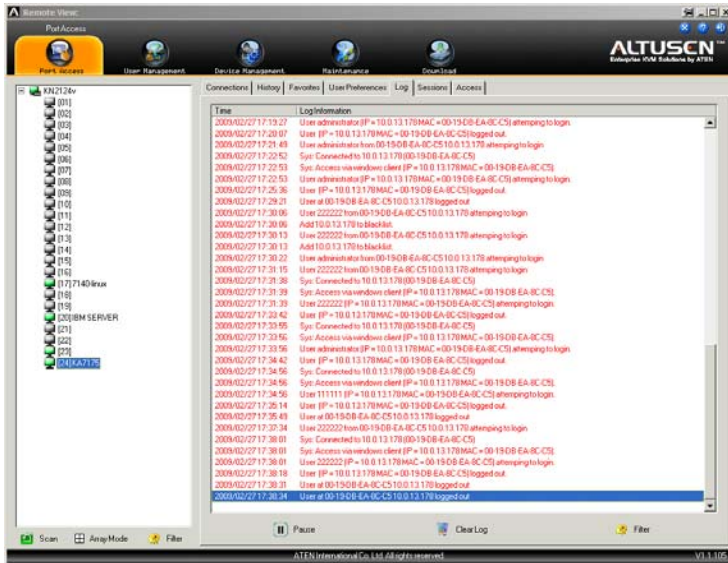

**Note:** 1. The screenshot displays an GUI version screen. In the Web Browser version, Log appears as a separate icon on the Icon Tab Bar.

2. The Log tab only appears for administrators and users who have been given permission to view the log file (see *Access*, page 101). It isn't available for other users.

- ♦ The log file tracks a maximum of 2048 events. When the limit is reached, the oldest events get discarded as new events come in.
- ♦ Clicking **Pause** stops the display of new events; the button changes to **Resume**. Click **Resume** to start displaying events again.
- ♦ To clear the log file, click the **Clear Log** icon.

## Filter

*Filter* allows you to search for particular events by date or by specific words or strings. When you access this function, the log filter dialog box displays at the bottom of the page:

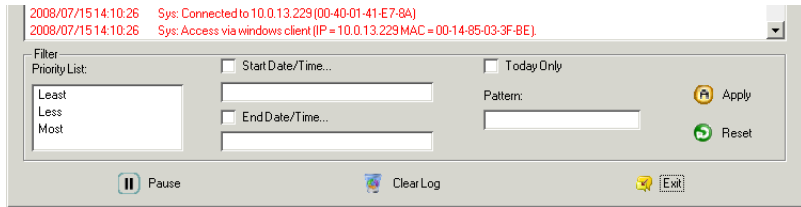

A description of the items is given in the table, below:

Item	Description
Priority	Sets the level for how detailed the filter results display should be.
Start Date/Time	Put a check in the checkbox to bring up a calendar. Set the date and time that you want the filtering to start from. All events from the Start date/time to the End date/time are displayed.
End Date/Time	Put a check in the checkbox to bring up a calendar. Set the date and time that you want the filtering to end at. All events from the Start date/time to the End date/time are displayed.
Today Only	Only the events for the current day are displayed.
Pattern	Key in the pattern that you are filtering for here. Wildcards (? and *) are supported. E.g., h*ds would match hands and hoods.
Apply	Starts the procedure; filters the events according to the criteria you specified; and returns the results.
Reset	Click this button to clear the entries in the dialog box and start with a clean slate.
Exit	Click this button to exit the log filter function.

## Sessions

The *Session* page lets the administrator see at a glance all the users currently logged into the KVM Over the NET™ switch, and provides information about each of their sessions.



- Note:**
1. The Session page only appears in Administrator sessions. It isn't available for ordinary users.
  2. The *Category* heading lists the type of user who has logged in: SA (Super Administrator); Admin (Administrator); Normal user (User).

The meanings of the headings at the top of the page are fairly straightforward. The *IP* heading refers to the IP address that the user has logged in from; the *Device* and *Port* headings show which device and port the user is currently accessing. The *Bus ID* refers to the bus that the user is currently on (Bus 0 refers to the Local Console's bus).

- Note:**
1. In the Web Browser version, the sort order of the information displayed can be changed by clicking the column headings.
  2. The Bus ID also displays on the control panel (see page 51).
  3. See *Users and Buses*, page 164 for information about users and buses.

This page also gives the administrator the option of forcing a user logout by selecting the user and clicking **End Session**.



## Access

Administrators use the *Access* page to set user and group access and configuration rights for switches and ports. The page is organized into three main areas: a large Main panel; a Status panel at the lower left, and a Properties panel at the lower right.

**Note:** The Access tab only appears in Administrator sessions. It isn't available for ordinary users.

### Device Level

If a switch is chosen in the Sidebar Tree, the Main panel looks similar to the one shown below:

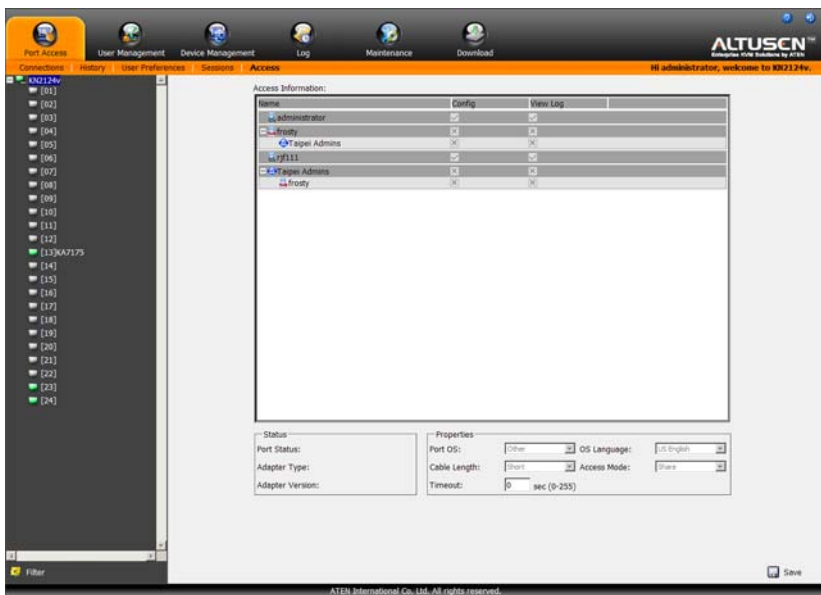

The main panel consists of three columns: *Name*, *Config*, and *View Log*:

- ◆ *Name* lists all the users and groups that have been created.
- ◆ *Config* indicates the users who have Configuration privileges. A check mark ( ✓ ) indicates that the user has permission to make changes to the switch configuration settings (see Chapter 8, *Device Management*); an X means that the user is denied permission to make configuration changes. Click the icon to toggle permission for Administrators and Users (Super Administrators always have configuration privileges).

- *View Log* indicates the users who have permission to view the log files. A check mark (✓) indicates that the user has permission to view the files; an X means that the user is denied permission to view them. Click the icon to toggle permission.
- The panels at the bottom of the page are inactive except for the Timeout field. This field sets a time threshold for users on ports whose Access Mode has been set to *Occupy*. See *Timeout*, page 87, for details.

## Port Level

If a port is chosen in the Sidebar Tree, the Main panel looks similar to the one shown below:

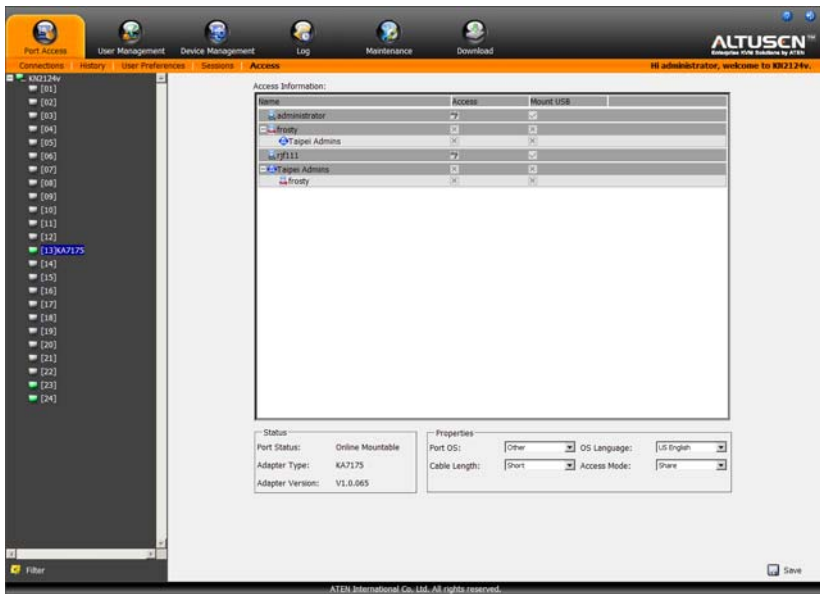

- *Name* lists all the users and groups that have been created.
- *Access* displays the access rights of the users and groups for each port, as shown in the table below.

	<b>Full Access:</b> The user can view the remote screen and can perform operations on the remote server from his keyboard and monitor.
	<b>View Only:</b> The user can only view the remote screen; he cannot perform any operations on it.
	<b>No Access:</b> No port access. The Port will not show up on the User's list on the Main Screen.

- ◆ *Mount USB* indicates users who have permission to mount Virtual Media devices on remote servers. A check mark (✓) indicates that a user has permission; an X means the user does not have permission.

---

**Note:** This entry does not appear for switches that do not support the USB Virtual Media function (KN2132, KN4116, KN4132).

---

### The Status Panel

The *Status* panel provides information about the online status of a selected port, and the KVM Adapter cable attached to it:

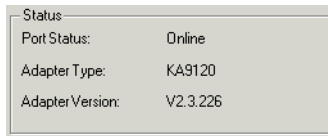

---

**Note:** This panel is inactive when a switch is selected in the Sidebar.

---

### The Properties Panel

For convenience, the *Properties* panel offers an additional input method to make configuration settings for the selected port.

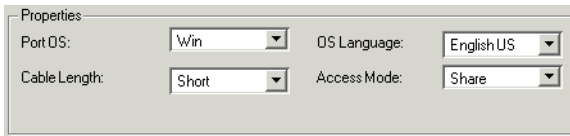

These port properties settings are the same as the ones that were discussed earlier in this chapter. Refer back to *Port Properties*, page 86 for setting details.

### Saving Changes

Click the **Save** button at the lower right corner of the page to save any changes made on the Access page.

This Page Intentionally Left Blank

# Chapter 7 User Management

## Overview

When you select the *User Management* tab the screen comes up with the *Users* page displayed:

## Web Browser Interface

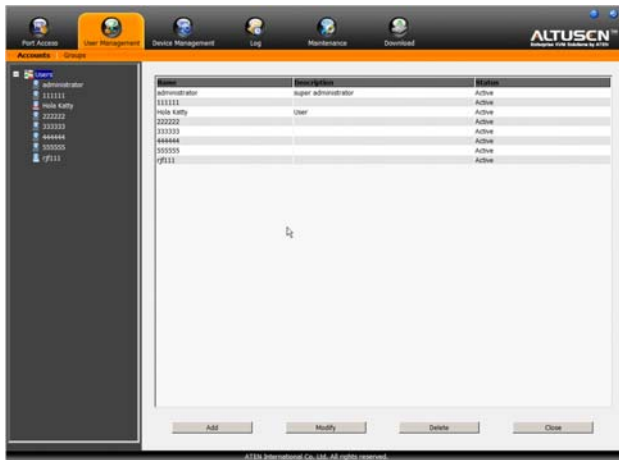

## GUI Interface



The page is organized into two main areas. All users and groups appear in the panel at the left of the page. The large panel at the right provides more detailed information at-a-glance for each.

- ◆ There is a pre-installed super administrator account. It can be used to set up the switch and to begin creating users and groups. The Username for this account is *administrator*; the password is *password*. For security purposes, we strongly recommend changing these to something unique.
- ◆ When using the GUI Interface, the section located below the Sidebar Users and Groups list provides a filter that allows you to manage the Sidebar list:

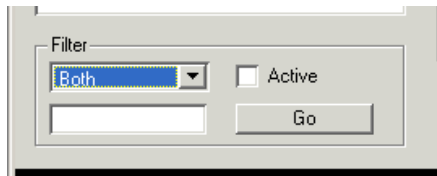

- ◆ Click the arrow at the right of the list box to select whether you want to view only Users, only, Groups, or both Users and Groups.
- ◆ Click to put a check in the *Active* checkbox to filter out any users whose accounts are not active.
- ◆ To only select Users or Groups that match a particular string, key it into the text box in front of the *Go* button, then click **Go**. Only Users or Groups that match the string will display. Wildcards (? and \*) are acceptable.
- ◆ The Web version has separate menu bar entries for Accounts (Users) and Groups.
- ◆ In the Web version, the sort order of the information displayed can be changed by clicking the column headings.
- ◆ The buttons below the main panel are used in managing users and groups, as shown in the sections that follow.

## Users

### Adding Users

To add a user, do the following:

1. Select *Users* in the Sidebar.
2. Click **Add** at the bottom of the main panel. The User notebook opens, with the *User* tab selected:

The screenshot shows a 'User Information' dialog box with the following sections:

- User Information:**
  - Username: [Text Field]
  - Password: [Text Field]
  - Confirm Password: [Text Field]
  - Description: [Text Field]
- Role:**
  - Super Administrator
  - Administrator
  - User
- Permissions:**
  - Windows Client
  - Java Client
  - View only
  - Power Management
  - Force to Grayscale
- Status:**
  - Disable account
  - Account never expires
  - Account expires on: [Text Field]
  - User must change password at next login
  - User cannot change password
  - Password never expires
  - Password expires after: [30] days

A 'Save' button is located at the bottom right of the dialog.

3. Enter the required information in the appropriate fields. A description of each of the fields is given in the table below:

Field	Description
Username	From 1 to 16 characters are allowed depending on the Account Policy settings. See <i>Account Policy</i> , page 136.
Password	From 0 to 16 characters are allowed depending on the Account Policy settings. See <i>Account Policy</i> , page 136.
Confirm Password	To be sure there is no mistake in the password, you are asked to enter it again. The two entries must match.
Description	Additional information about the user that you may wish to include.
Role	<p>There are three categories: Super Administrator, Administrator and User. There is no limitation on the number of accounts that can be created in each category.</p> <ul style="list-style-type: none"> <li>◆ The super administrator is responsible for the overall installation configuration and maintenance; user management; and device and port assignments.</li> <li>◆ Administrators have user management privileges. They can also access the ports and devices assigned to them by the super administrator.</li> <li>◆ Users can access the ports and devices assigned to them by the super administrator.  <b>Note:</b> By default the User account is inactive. The user will not be able to log in until you give him any of the available permissions (see below).</li> </ul>
Permissions	<p>Super administrators and administrators automatically have Windows Client, Java Client, and Power Management permissions. Permissions and restrictions for ordinary users are set individually by checking the appropriate boxes, as follows:</p> <ul style="list-style-type: none"> <li>◆ <i>Windows Client</i> allows a user to download the Windows Client software, and access the switch with it, in addition to (or instead of) the browser access method.</li> <li>◆ <i>Java Client</i> allows a user to download the Java Client software, and access the KVM Over the NET™ switch with it, in addition to (or instead of) the browser access method.</li> <li>◆ <i>View Only</i> limits users to only being able to view the display of connected devices. They cannot control port access, nor can they input any keyboard or mouse signals to the devices they view.</li> <li>◆ <i>Power Management</i> allows a User to connect to Power on the Net™ devices.</li> <li>◆ <i>Force to Grayscale</i> forces the user's view of the remote display to be in grayscale. This can speed up I/O transfer in low bandwidth situations.</li> </ul>

(Continues on next page.)



(Continued from previous page.)

Field	Description
Status	<p>Status allows you to control the user's account and access to the installation, as follows:</p> <ul style="list-style-type: none"> <li>◆ <i>Disable Account</i> lets you suspend a user's account without actually deleting it, so that it can be easily reinstated in the future.</li> <li>◆ If you don't want to limit the time scope of the account, select <i>Account never expires</i>; if you want to limit the amount of time that the account remains in effect, select <i>Account expires on</i>, and key in the expiration date.</li> <li>◆ To require a user to change his password at the next logon, select <i>User must change password at next logon</i>. This can be used by the administrator to give the user a temporary password to log in for the first time, and then let the user set the password of his choice for future logins.</li> <li>◆ To make a password permanent, so that the user cannot change it to something else, select <i>User cannot change password</i>.</li> <li>◆ For security purposes, administrators may want users to change their passwords from time to time. <ul style="list-style-type: none"> <li>◆ If not, select <i>Password never expires</i>. This allows users to keep their current passwords for as long as they like.</li> <li>◆ If so, select <i>Password expires after</i>, and key in the number of days allowed before the password expires. Once the time is up, a new password must be set.</li> </ul> </li> </ul>

4. At this point you can assign the new user to a group by selecting the *Groups* tab – the Groups page is discussed on page 114. You can also assign the user's port access rights by selecting the *Devices* tab – the Devices page is discussed on page 118.

---

**Note:** Optionally, you can skip this step now to add more users and create groups, and come back to it later.

---

5. When your selections have been made click **Save**.
6. When the *Operation Succeeded* message appears, click **OK**.

7. Click **Users** in the Sidebar to return to the main screen. The new user appears in the Sidebar list and in the main panel, as well.
  - ♦ The Sidebar *Users* list can expand and collapse. If the list is expanded, click the minus symbol ( – ) next to the *Users* icon to collapse it; if it is collapsed there is a plus symbol ( + ) next to the icon. Click the plus symbol to expand it.
  - ♦ The icon for super administrators has two black bands; the icon for administrators has one red band.
  - ♦ The large main panel shows the user’s name; the description that was given when the account was created; and whether the account is currently active or has been disabled.

## **Modifying User Accounts**

To modify a user account, do the following:

1. In the Sidebar *User* list, click the user’s name  
– or –

In the main panel, select the user’s name, then click **Modify**.

2. In the *User* page that comes up, make your changes, then click **Save**.

---

**Note:** The *User* page is discussed on page 107; the *Groups* page is discussed on page 114, the *Devices* page is discussed on page 118.

---

## **Deleting User Accounts**

To delete a user account do the following:

1. In the main panel, select the user’s name, then click **Delete**.
2. Click **OK**.

## Groups

---

Groups allow administrators to easily and efficiently manage users and devices. Since device access rights apply to anyone who is a member of the group, administrators need only set them once for the group, instead of having to set them for each user individually. Multiple groups can be defined to allow some users access to specific devices, while restricting other users from accessing them.

### Creating Groups

To create a group, do the following:

1. Select *Groups* in the Sidebar.
2. Click **Add** at the bottom of the main panel. The Group notebook opens, with the *Group* tab selected:

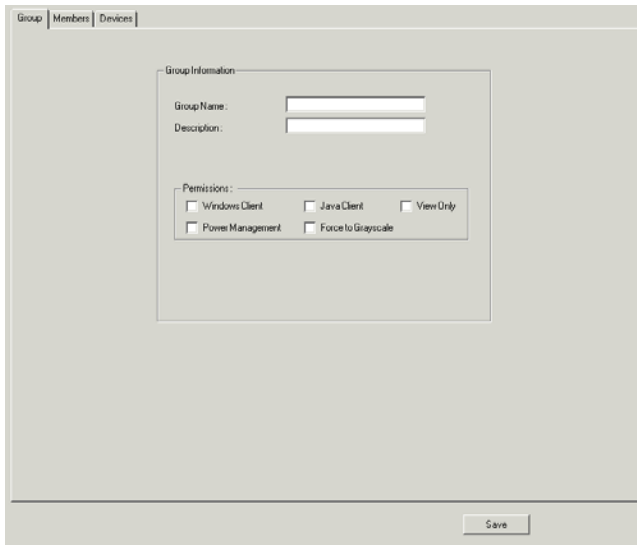

The screenshot shows a dialog box for creating a group. At the top, there are three tabs: "Group", "Members", and "Devices", with "Group" selected. The main area is titled "Group Information" and contains two text input fields: "Group Name:" and "Description:". Below these is a "Permissions:" section with four checkboxes: "Windows Client", "Java Client", "View Only", "Power Management", and "Force to Grayscale". A "Save" button is located at the bottom right of the dialog box.

*(Continues on next page.)*

(Continued from previous page.)

3. Enter the required information in the appropriate fields. A description of each of the fields is given in the table below:

Field	Description
Group Name	A maximum of 16 characters is allowed.
Description	Additional information about the user that you may wish to include. A maximum of 63 characters is allowed.
Permissions	Permissions and restrictions for groups are set by checking the appropriate boxes, as follows: <ul style="list-style-type: none"><li>◆ <i>Windows Client</i> allows group members to download the Windows Client software, and access the KVM Over the NET™ switch with it, in addition to (or instead of) the browser access method.</li><li>◆ <i>Java Client</i> allows group members to download the Java Client software, and access the KVM Over the NET™ switch with it, in addition to (or instead of) the browser access method.</li><li>◆ <i>Power Management</i> allows group members to connect to Power on the Net™ devices.</li><li>◆ <i>View Only</i> limits group members to only being able to view the display of connected devices. They cannot control port access, nor can they input any keyboard or mouse signals to the devices they view.</li><li>◆ <i>Force to Grayscale</i> forces the group members' view of the remote display to be in grayscale. This can speed up I/O transfer in low bandwidth situations.</li></ul> <p><b>Note:</b> If a user has permissions in addition to the ones assigned to the group, the user keeps those permissions in addition to the group ones.</p>

4. At this point you can assign users to the group by selecting the *Members* tab – the Members page is discussed on page 116. You can also assign the group's port access rights by selecting the *Devices* tab – the Devices page is discussed on page 118.

---

**Note:** Optionally, you can skip this step now to add more groups and assign users to them, and come back to it later.

---

5. When your selections have been made click **Save**.
6. When the *Operation Succeeded* message appears, click **OK**.

7. Click **Group** in the Sidebar to return to the main screen. The new group appears in the Sidebar Group list and in the main panel.
  - ◆ The Sidebar *Groups* list can expand and collapse. If the list is expanded, click the minus symbol ( – ) next to the *Users* icon to collapse it; if it is collapsed there is a plus symbol ( + ) next to the icon. Click the plus symbol to expand it.
  - ◆ The large main panel shows the group's name, and the description that was given when the group was created (the *Status* column is inactive).

## **Modifying Groups**

To modify a group, do the following:

1. In the Sidebar *Group* list, click the group's name  
– or –  
In the main panel, select the group's name, then click **Modify**.
2. In the *Group* notebook that comes up, make your changes, then click **Save**.

---

**Note:** The *Group* page is discussed on page 111; the *Members* page is discussed on page 116, The *Devices* page is discussed on page 118.

---

## **Deleting Groups**

To delete a group do the following:

1. In the main panel, select the group's name, then click **Delete**.
2. Click **OK**.

## Users and Groups

---

There are two ways to assign users to – and remove users from – groups: from the Users notebook; and from the Group notebook.

**Note:** Before you can assign users to groups, you must first create them. See *Adding Users*, page 107 for details.

---

### Assigning Users to a Group From the User's Notebook

To assign a user to a group from the User's notebook, do the following:

1. In the Sidebar *User* list, click the user's name

– or –

In the main panel, select the user's name, then click **Modify**.

2. In the *User* notebook that comes up, select the *Groups* tab. A screen, similar to the one below, appears:

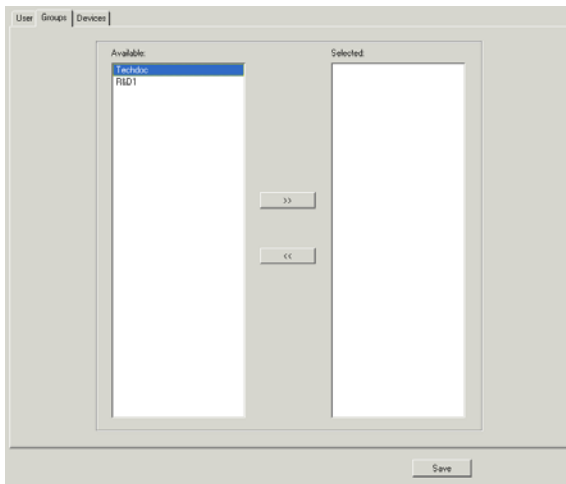

3. In the *Available* column, select the group that you want the user to be in.
4. Click the **Right Arrow** to put the group's name into the *Selected* column.
5. Repeat the above for any other groups that you want the user to be in.
6. Click **Save** when you are done.

## **Removing Users From a Group From the User's Notebook**

To remove a user from a group from the User's notebook, do the following:

1. In the Sidebar *User* list, click the user's name

– or –

In the main panel, select the user's name, then click **Modify**.

2. In the *User* notebook that comes up, select the *Groups* tab. A screen, similar to the one below, appears:

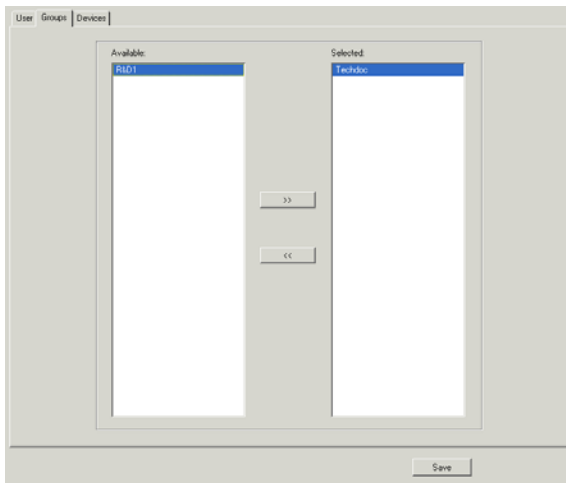

3. In the *Selected* column, select the group that you want to remove the user from.
4. Click the **Left Arrow** to remove the group's name from the *Selected* column. (It goes back into the *Available* column.)
5. Repeat the above for any other groups that you want to remove the user from.
6. Click **Save** when you are done.

## Assigning Users to a Group From the Group's Notebook

To assign a user to a group from the Group notebook, do the following:

1. In the Sidebar *Group* list, click the group's name  
– or –  
In the main panel, select the group's name, then click **Modify**.
2. In the *Group* notebook that comes up, select the *Members* tab. A screen, similar to the one below, appears:

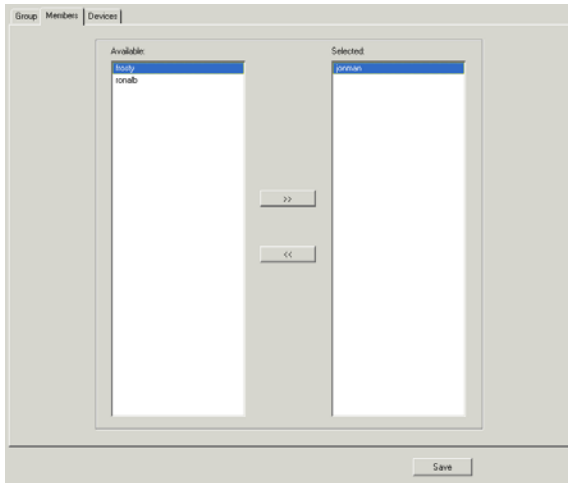

3. In the *Available* column, select the user that you want to be a member of the group.
4. Click the **Right Arrow** to put the user's name into the *Selected* column.
5. Repeat the above for any other users that you want to be members of the group.
6. Click **Save** when you are done.



## **Removing Users From a Group From the Group's Notebook**

To remove a user from a group from the Group's notebook, do the following:

1. In the Sidebar *Group* list, click the group's name

– or –

In the main panel, select the group's name, then click **Modify**.

2. In the *Group* notebook that comes up, select the *Members* tab. A screen, similar to the one below, appears:

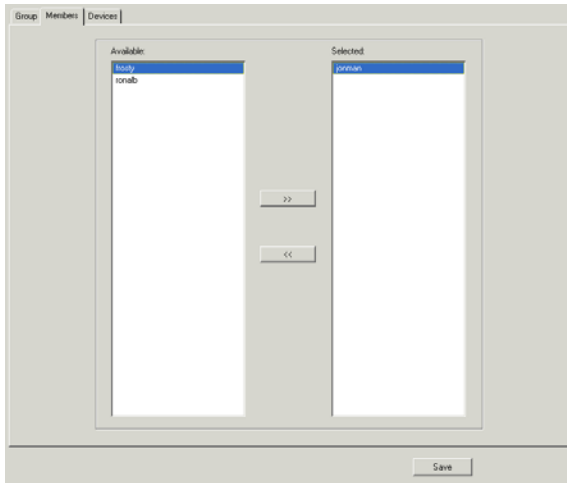

3. In the *Selected* column, select the user that you want to remove from the group.
4. Click the **Left Arrow** to remove the user's name from the *Selected* column. (It goes back into the *Available* column.)
5. Repeat the above for any other users that you want to remove from the group.
6. Click **Save** when you are done.

## Device Assignment

When a user logs in to the KVM Over the NET™ switch, the interface comes up with the Port Access page displayed. All the ports that the user is permitted to access are listed in the Sidebar at the left of the page. Access permissions for those ports and the devices connected to them are assigned on a port-by-port basis from the *User* or *Group* list on the Sidebar of the User Management page.

### Assigning Device Permissions From the User's Notebook

To assign a device permissions to a user User's notebook, do the following:

1. In the Sidebar *User* list, click the user's name

– or –

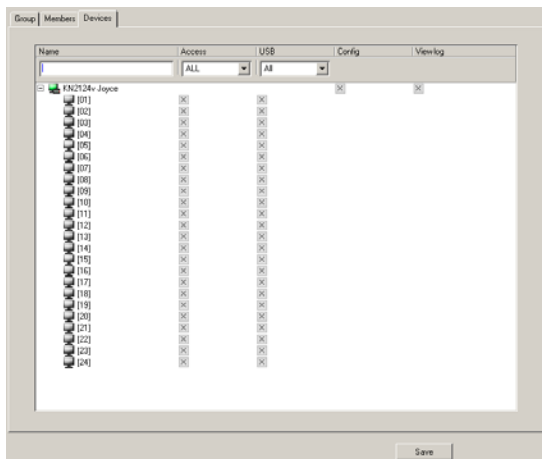

In the main panel, select the user's name, then click **Modify**.

2. In the *User* notebook that comes up, select the *Devices* tab. A screen, similar to the one below, appears:



- ◆ Ports are listed under *Names* in the left hand column.
- ◆ The *Access* column is where device access rights are set.
- ◆ The *USB* column is where USB Virtual Media device access rights are listed. This entry does not appear for switches that do not support the USB Virtual Media function (KN2132, KN4116, KN4132).
- ◆ *Config* enables/disables the user from making changes to the KVM Over the NET™ switch configuration settings.
- ◆ *View Log* permits/restricts viewing of the KVM Over the NET™ switch log file.

3. Under the *Access* or *USB* column, click the icon that corresponds to the port you want to configure to cycle through the choices, as shown below:

Icon	Meaning	Description
	Full Access	The user can view the remote screen and can perform operations on the remote server from his keyboard and monitor.
	View Only	The user can only view the remote screen; he cannot perform any operations on it.
	No Access	No access rights - the Port will not show up on the User's list on the Main Screen.

**Note:** You can use Shift-Click or Ctrl-Click to select a group of ports to configure. Clicking to cycle through the choices on any one of the selected ports causes all them to cycle in unison.

4. Under *Config*, click the icon to toggle the choices. A check mark (✓) indicates that the user has permission to make changes to the KVM Over the NET™ switch configuration settings (see Chapter 8, *Device Management*); an X means that the user is denied permission to make configuration changes.
5. Under *View Log*, click the icon to toggle the choices. A check mark (✓) indicates that the user has permission to view the KVM Over the NET™ switch's log files; an X means that the user is denied permission to view the files.
6. When you have finished making your choices, click **Save**.
7. In the confirmation popup that appears, click **OK**.

## Filters

There are three filters at the top of the page that allow you to expand or limit the scope of the ports that are displayed, as described in the following table:

Filter		Description
Name		To filter on the port name, key in the name, partial name, or partial name and wild card ( * ) then press <b>Enter</b> . Only the ports whose names correspond to what you have keyed in appear in the list.
Access	All	All ports appear in the list.
	Full Access	Only ports configured as Full Access ports appear in the list.
	View Only	Only ports configured as View Only ports appear in the list.
	No Access	Only ports configured as No Access ports appear in the list.
USB	All	All ports appear in the list.
	Permitted	Only ports configured as Permitted appear in the list.
	Restricted	Only ports configured as Restricted appear in the list.

## Assigning Device Permissions From the Groups' Notebook

To assign a device permissions to a Group of users, do the following:

- In the Sidebar *Groups* list, click the group's name  
– or –  
In the main panel, select the group's name, then click **Modify**.
- In the *Groups* notebook that comes up, select the *Devices* tab.
- The screen that comes up is the same one that appears in the User's notebook. Make your device assignments according to the information described under *Assigning Device Permissions From the User's Notebook*, page 118.

The only difference is that whatever settings you make apply to all members of the group instead of just one individual member.

# Chapter 8 Device Management

## Overview

The *Device Management* page allows super administrators to configure and control overall KVM Over the NET™ switch operations.

## Web Browser Interface



## GUI Interface



## Device Information

The *General* section of the Device Information page presents information about the selected device.

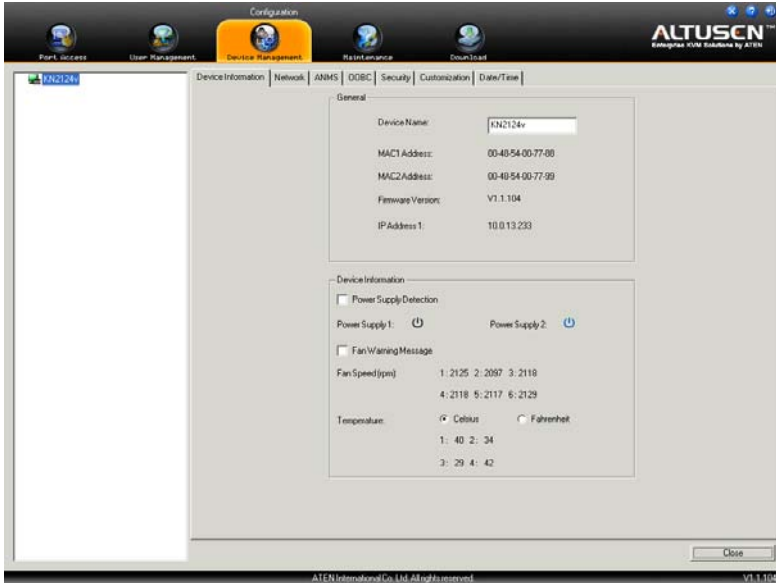

**Note:** The screenshot shows the GUI version. The Web version only displays the upper panel.

Each item of this section is described in the following table.

Item	Meaning
Device Name	This field lets you give the switch a unique name. This can be convenient when you need to differentiate among several devices in multi station installations. Simply delete the switch's number and key in the name of your choice.
MAC1 Address	The KVM Over the NET™ switch supports two network interfaces. This item displays the MAC address of the first interface.
MAC2 Address	The KVM Over the NET™ switch supports two network interfaces. This item displays the MAC address of the second interface.
Firmware Version	This item displays the current firmware version number. You can reference it to see if there are newer versions available on the Altusen website.

Item	Meaning
IP Address 1	This item displays the IP address of the first network interface.
IP Address 2	This item displays the IP address of the second network interface.

The lower panel of the GUI page presents information about the selected device, as described in the table, below:

Item	Description
Power Supply Detection	<p>The icons for Power Supply 1 and Power Supply 2 display in gray when there is no power to the power supply – they display in blue when power is present.</p> <p>When this function is enabled (there is a check in the checkbox), if there is only one source of power, the switch will beep constantly to warn you of the problem.</p> <p>If you are at the Local Console you will see a message asking you to confirm that your intention is to only have one power source. If your intention is to only have one source of power, there are two ways to stop the beeping: 1) You can disable power supply warnings by unchecking the checkbox. Do this if you want to disable this function on a permanent basis.</p> <p>Or, 2) you can confirm your intention in the dialog box. Do this if you only want to disable the warning temporarily. With this method, the warning function will be back in effect after the next system reset.</p> <p>The default for this function is enabled.</p>
Fan Warning Message	<p>Place a check in the checkbox to enable a fan warning message.</p> <p>If any fan stops spinning the system beeps to warn you of the problem. If you are at the Local Console a message appears informing you of the situation. You can select <i>Confirm</i> (to ignore the warning and stop the beeping) if you are sure there is no problem.</p> <p><b>Note:</b> The warning doesn't necessarily mean that the fan has failed, since the fan will stop spinning (as desired) when the temperature drops below its lower setting.</p> <p>The default for this function is enabled.</p>
Fan Speed	Fan speeds are indicated here. See <i>Fan Location and Speed Information</i> , page 224.
Temperature	Temperature readings from the switch's built-in sensors are indicated here and can be displayed in degrees celsius or fahrenheit. See <i>Temperature Sensor Location and Information</i> , page 225

## Network

The Network page is used to specify the KVM Over the NET™ switch network environment.

Service Ports:	
Program:	<input type="text" value="9000"/>
HTTP:	<input type="text" value="80"/>
HTTPS:	<input type="text" value="443"/>
<input checked="" type="checkbox"/> Redundant NIC	
<input type="text" value="1000M Network Adapter 1"/>	
IP Address:	
<input type="radio"/> Obtain IP address automatically [DHCP]	
<input checked="" type="radio"/> Set IP address manually [Fixed IP]	
IP Address:	<input type="text" value="10.0.13.233"/>
Subnet Mask:	<input type="text" value="255.255.255.0"/>
Default Gateway:	<input type="text" value="10.0.13.1"/>
DNS Server:	
<input type="radio"/> Obtain DNS server address automatically	
<input checked="" type="radio"/> Set DNS server address manually	
Preferred DNS server:	<input type="text" value="10.0.1.23"/>
Alternate DNS server:	<input type="text" value="0.0.0.0"/>
Network Transfer Rate:	<input type="text" value="99999"/> KBps



---

## Service Ports

As a security measure, if a firewall is being used, the Administrator can specify the port numbers that the firewall will allow. If a port other than the default is used, users must specify the port number as part of the IP address when they log in. If not, an invalid port number (or no port number) is specified, the KVM Over the NET™ switch will not be found. An explanation of the fields is given in the table below:

Field	Explanation
Program	This is the port number for connecting with the WinClient ActiveX Viewer, WinClient AP, Java Applet Viewer, Java Client AP, or via Virtual Media. The default is 9000.
HTTP	The port number for a browser login. The default is 80.
HTTPS	The port number for a secure browser login. The default is 443.

---

**Note:** 1. Valid entries for all of the Service Ports are from 1–65535.

2. The service ports cannot have the same value. You must set a different value for each one.
  3. If there is no firewall (on an Intranet, for example), it doesn't matter what these numbers are set to, since they have no effect.
-

## **NIC Settings**

### **Redundant NIC**

The KVM Over the NET™ switch is designed with two network interfaces. If *Redundant NIC* is enabled (the default), both interfaces make use of the IP address of Network Adapter 1.

Under this configuration, the second interface is usually inactive. If there is a network failure on the first interface, the switch automatically switches to the second interface.

- ◆ **Redundant NIC Enabled – Single IP Address for Both Interfaces**

To enable the Redundant NIC function, do the following:

1. Click to put a check in the *Redundant NIC* checkbox.
2. *Network Adapter 1* is selected in the network adapter listbox, and the listbox is disabled – you cannot configure Network Adapter 2.
3. Configure the IP and DNS server addresses for Network Adapter 1 (see the sections below).

- ◆ **Redundant NIC Not Enabled – Two IP Addresses**

If you choose not to enable the Redundant NIC function, the two NICs can be configured with separate interfaces. Users can log into the KVM Over the NET™ switch with either IP address. To set up the switch with this configuration, do the following:

1. If there is a check in the *Redundant NIC* checkbox, click to remove it.
2. In the network adapter listbox; select Network Adapter 1.
3. Configure the IP and DNS server addresses for Network Adapter 1 (see the sections below).
4. Drop down the network adapter listbox; select Network Adapter 2.
5. Configure the IP and DNS server addresses for Network Adapter 2.

## IP Address

The KVM Over the NET™ switch can either have its IP address assigned dynamically (DHCP), or it can be given a fixed IP address.

- ◆ For dynamic IP address assignment, select the *Obtain IP address automatically* radio button. (This is the default setting.)
- ◆ To specify a fixed IP address, select the *Set IP address manually* radio button and fill in the IP address with values appropriate for your network.

- 
- Note:** 1. If you choose *Obtain IP address automatically*, when the switch starts up it waits to get its IP address from the DHCP server. If it hasn't obtained the address after one minute, it automatically reverts to its factory default IP address (192.168.0.60.)
2. If the switch is on a network that uses DHCP to assign network addresses, and you need to ascertain its IP address, see *IP Address Determination*, page 208, for information./
- 

## DNS Server

- ◆ For automatic DNS Server address assignment, select the *Obtain DNS Server address automatically* radio button.
- ◆ To specify the DNS Server address manually, select the *Set DNS server address manually* radio button, and fill in the addresses for the Preferred and Alternate DNS servers with values appropriate for your network.

---

**Note:** Specifying at the preferred DNS Server address is optional.

---

## Network Transfer Rate

This setting allows you to tailor the size of the data transfer stream to match network traffic conditions by setting the rate at which the KVM Over the NET™ switch transfers data between the itself and the client computers. The range is from 4–99999 Kilobytes per second (KBps).

## Finishing Up

After making any network changes, be sure *Reset on exit* on the *Customization* page (see *Customization*, page 138) has been enabled (there is a check in the checkbox), before logging out. This allows network changes to take effect without having to power the switch off and on.

## ANMS

The Advanced Network Management Settings page is used to set up login authentication and authorization management from external sources. It is organized in a series of related panels, as described, below:

IP Installer <input checked="" type="radio"/> Enabled <input checked="" type="radio"/> View Only <input type="radio"/> Disabled	
<b>SMTP Settings</b> <input type="checkbox"/> Enable report from the following SMTP Server SMTP Server: <input type="text" value="0.0.0.0"/> <input type="checkbox"/> My server requires authentication Account Name: <input type="text"/> Password: <input type="text"/> From: <input type="text"/> To: <input type="text"/> <input type="checkbox"/> Report IP address <input type="checkbox"/> Report system reboot <input type="checkbox"/> Report user login <input type="checkbox"/> Report user logout	
<b>Log Server</b> <input type="checkbox"/> Enable MAC Address: <input type="text" value="000000000000"/> Service Port: <input type="text" value="9001"/>	
<b>SNMP Server</b> <input type="checkbox"/> Enable SNMP Agent Server IP: <input type="text" value="0.0.0.0"/> Service Port: <input type="text" value="162"/>	
<b>Syslog Server</b> <input type="checkbox"/> Enable Server IP: <input type="text" value="0.0.0.0"/> Service Port: <input type="text" value="514"/>	
<input type="checkbox"/> Disable Local Authentication	
<b>RADIUS Settings</b> <input type="checkbox"/> Enable Preferred RADIUS Server IP: <input type="text" value="0.0.0.0"/> Preferred RADIUS Service Port: <input type="text" value="0"/> Alternate RADIUS Server IP: <input type="text" value="0.0.0.0"/> Alternate RADIUS Service Port: <input type="text" value="0"/> Timeout: <input type="text" value="0"/> sec Retries: <input type="text" value="0"/> Shared Secret (at least 6 characters): <input type="text"/>	
<b>LDAP Settings</b> <input type="checkbox"/> Enable    Type: <input checked="" type="radio"/> LDAP <input checked="" type="radio"/> LDAPS LDAP Server: <input type="text" value="0.0.0.0"/> Port: <input type="text" value="0"/> Admin DN: <input type="text"/> Timeout: <input type="text" value="0"/> sec Admin Name: <input type="text"/> Password: <input type="text"/> Search DN: <input type="text"/>	
<b>CC Management</b> <input checked="" type="checkbox"/> Enable CC Server IP: <input type="text" value="0.0.0.0"/> CC Service Port: <input type="text" value="0"/>	

## **IP Installer**

The IP Installer is an external Windows-based utility for assigning IP addresses to the KVM Over the NET™ switch.

Click one of the radio buttons to select *Enable*, *View Only*, or *Disable* for the IP Installer utility. See *IP Installer*, page 208, for IP Installer details.

- 
- Note:** 1. If you select *View Only*, you will be able to see the KVM Over the NET™ switch in the IP Installer's Device List, but you will not be able to change the IP address.
2. For security, we strongly recommend that you set this to *View Only* or *Disable* after use.
- 

## **SMTP Settings**

To have the KVM Over the NET™ switch email reports from the SMTP server to you, do the following:

1. Enable the *Enable report from the following SMTP server*, and key in the IP address of your SMTP server.
2. If your server requires authentication, put a check in the *My server requires authentication* checkbox.
3. Key in the appropriate account information in the *Account Name*, *Password*, and *From* field.

- 
- Note:** 1. Only one email address is allowed in the *From* field, and it cannot exceed 64 Bytes.
2. 1 Byte = 1 English alphanumeric character.
- 

4. Key in the email address (addresses) of where you want the report of the DHCP address and event reports sent to in the *To* field.

---

**Note:** If you are sending the report to more than one email address, separate the addresses with a semicolon. The total cannot exceed 256 Bytes.

---

5. Select the report options you would like sent. Choices include: *Report IP address*, *Report system reboot*, *Report user login* and *Report user logout*.

## **Log Server**

Important transactions that occur on the KVM Over the NET™ switch, such as logins and internal status messages, are kept in an automatically generated log file. Specify the MAC address and a port number for the computer that the Log Server resides on in this panel. The valid port range is 1-65535. The default port number is 9001.

---

**Note:** The port number must different than the one used for the *Program* port (see *Program*, page 125).

---

Installation and operation of the Log Server is discussed in Chapter 12. The Log File is discussed on page 98.

## **SNMP Settings**

If you want to use SNMP to help with your installation management:

1. Check *Enable SNMP Agent*.
2. Key in the IP address and the port number of the computer to be notified of SNMP trap events. The valid port range is 1–65535.

---

**Note:** The following SNMP trap events are sent: system power On, login failure, and system reset.

---

## **Syslog Server**

To record all the events that take place on KVM Over the NET™ switches and write them to a Syslog server, do the following:

1. Check **Enable**.
2. Key in the IP address and the port number of the Syslog server. The valid port range is 1-65535.

## **Disable Local Authentication**

Selecting this option will disable login authentication locally on the KVM Over the NET™ switch. The switch can only be accessed using LDAP, LDAPS, MS Active Directory, RADIUS or CC Management authentication.

## **RADIUS Settings**

To allow authentication and authorization for the KVM Over the NET™ switch through a RADIUS server, do the following:

1. Check **Enable**.
2. Fill in the IP addresses and port numbers for the Preferred and Alternate RADIUS servers.
3. In the *Timeout* field, set the time in seconds that the KVM Over the NET™ switch waits for a RADIUS server reply before it times out.
4. In the *Retries* field, set the number of allowed RADIUS retries.
5. In the *Shared Secret* field, key in the character string that you want to use for authentication between the KVM Over the NET™ switch and the RADIUS Server.
6. On the RADIUS server, set the entry for each user as follows:

`su/xxxx`

Where *xxxx* represents the Username given to the user when the account was created on the KVM Over the NET™ switch. The user's access rights are the ones assigned for the KVM Over the NET™ switch, as well. (See *Adding Users*, page 107.)

## **LDAP / LDAPS Authentication and Authorization Settings**

To allow authentication and authorization for the KVM Over the NET™ switch via LDAP / LDAPS, refer to the information in the table, below:

<b>Item</b>	<b>Action</b>
Enable	Put a check in the <i>Enable</i> checkbox to allow LDAP / LDAPS authentication and authorization.
Type	Click a radio button to specify whether to use LDAP or LDAPS.
LDAP Server IP and Port	Fill in the IP address and port number for the LDAP or LDAPS server. For LDAP, the default port number is 389; for LDAPS, the default port number is 636.
Admin DN	Consult the LDAP / LDAPS administrator to ascertain the appropriate entry for this field. For example, the entry might look like this: <code>ou=kn4132,dc=aten,dc=com</code>
Admin Name	Key in the LDAP administrator's username.
Password	Key in the LDAP administrator's password.
Search DN	Set the distinguished name of the search base. This is the domain name where the search starts for user names.
Timeout	Set the time in seconds that the KVM Over the NET™ switch waits for an LDAP or LDAPS server reply before it times out.

---

**Note:** If *LDAP Settings* is enabled, the LDAP schema for MS Active Directory must be extended. See *LDAP Server Configuration*, page 173, for details.

---

## **CC Management Settings**

To allow authorization for the KVM Over the NET™ switch through a CC (Control Center) server, check *Enable* and fill in the CC Server's IP address and the port that it listens on in the appropriate fields.



## OoBC

In case the KVM Over the NET™ switch cannot be accessed with the usual LAN-based methods, it can be accessed via the switch's modem port. This page is used to enable support for PPP (modem) dial in operation.

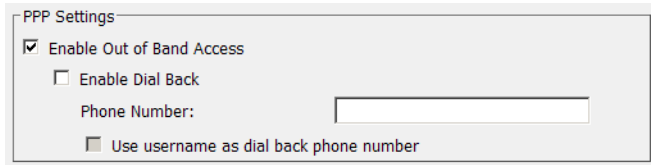

PPP Settings

Enable Out of Band Access

Enable Dial Back

Phone Number:

Use username as dial back phone number

An explanation of the items is given in the table below:

Item	Action
Enable Out of Band Access	Check this to enable dial-in out of band access to the KVM Over the NET™ switch.
Enable Dial Back	As an added security feature, check this to have the switch disconnect the original dial-in connection and dial back to the phone number specified below.
Phone Number	If <b>Enable Dial Back</b> is checked, this is the phone number the switch will use to dial back to initiate a PPP session with the user. This should be set to the same phone number that the user is dialing from.
Use username as dial back phone number	If <b>Enable Dial Back</b> is checked, and a phone number has been specified in the <b>Phone Number</b> field, and <i>Use username as dial back phone number</i> has been checked: <ul style="list-style-type: none"> <li>◆ Use the phone number of the modem that the switch is dialing back to for the dial-in Username.</li> <li>◆ Use the phone number specified in the <i>Phone Number</i> field for the dial in password.</li> </ul>

See *PPP Modem Operation*, page 212, for PPP setup and operation details.

## Security

The Security page controls access to the KVM Over the NET™ switch.

**Security**

IP Filter Enable       Include       Exclude

Login String:

MAC Filter Enable       Include       Exclude

**Account Policy**

Minimum Username Length:

Minimum Password Length:

Password Must Contain At Least

One Upper Case

One Lower Case

One Number

Disable Duplicate Login

**Encryption**

Keyboard/Mouse

DES     3DES     AES     RC4     Random

Video

DES     3DES     AES     RC4     Random

Virtual Media

DES     3DES     AES     RC4     Random

**Private Certificate**

Private Key :

Certificate :

## IP and MAC Filtering

If any filters have been configured, they appear in the IP Filter and/or MAC Filter list boxes.

IP and MAC Filters control access to the KVM Over the NET™ switch based on the IP and/or MAC addresses of the client computers attempting to connect. A maximum of 100 IP filters and 100 MAC filters are allowed.

To enable IP and/or MAC filtering, **Click** to put a check mark in the *IP Filter Enable* and/or *MAC Filter Enable* checkbox.

- ◆ If the include button is checked, all the addresses within the filter range are allowed access; all other addresses are denied access.
- ◆ If the exclude button is checked, all the addresses within the filter range are denied access; all other addresses are allowed access.

### Adding Filters

To add a filter, do the following:

1. After enabling IP and/or MAC filtering, click **Add**. A dialog box similar to the ones below appears:

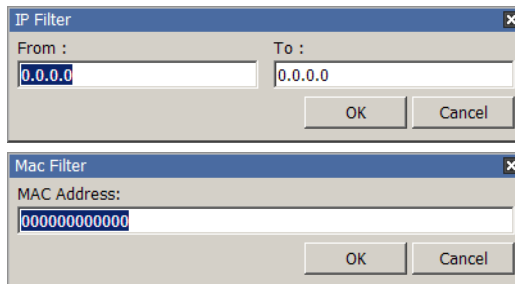

---

**Note:** Each IP filter can consist of a single address, or a range of addresses. To filter a single IP address, key in the same address in both the *From* and *To* fields. To filter a continuous range of IP addresses, key in the start of the range in the *From* field; key in the end of the range in the *To* field.

---

2. Specify the filter addresses, then click **OK**.

### Modifying Filters

To modify a filter, select it in the IP Filter and/or MAC Filter list boxes and click **Modify**. The Modify dialog box is similar to the Add dialog box. When it comes up, simply delete the old address(es) and replace it with the new one(s).

## Deleting Filters

To delete a filter, select it in the IP Filter and/or MAC Filter list boxes and click **Delete**.

## Login String

The *Login String* entry field lets the super administrator specify a login string (in addition to the IP address) that users must include when accessing the KVM Over the NET™ switch with a browser. For example:

192.168.0.126/abcdefg

- ◆ The following characters are allowed:  
0–9 a–z A–Z ~ ! @ \$ ^ & \* ( ) \_ + ' - = [ ] { } ; ' < > , . |
- ◆ The following characters are not allowed:
  - ◆ % " : / ? # \ [Space]
  - ◆ Compound characters (É Ç ñ ... etc.)

---

**Note:** 1. There must be a forward slash between the IP address and the string.  
2. If no login string is specified here, anyone will be able to access the KVM Over the NET™ switch login page using the IP address alone. This makes your installation less secure.

---

For security purposes, we recommend that you change this string occasionally.

## Account Policy

In the Account Policy section, system administrators can set policies governing usernames and passwords. Check a policy and enter the required information in the appropriate fields.

Item	Description
Minimum Username Length	Sets the minimum number of characters required for a username. Acceptable values are from 1–16.
Minimum Password Length	Sets the minimum number of characters required for a password. Acceptable values are from 0–16.
Password Must Contain At Least	Checking any of these items requires users to include at least one uppercase letter, one lowercase letter or one number in their password. <b>Note:</b> This policy does not affect existing user accounts. Only new user accounts created after this policy has been enabled, and users required to change their passwords are affected.
Disable Duplicate Login	Check this to prevent users from logging in with the same account at the same time.

---

## **Encryption**

These flexible encryption alternatives for keyboard/mouse, video, and virtual media data let you choose any combination of DES; 3DES; AES; RC4; or a Random cycle of any or all of them. Enabling encryption will affect system performance – no encryption offers the best performance; the greater the encryption the greater the adverse effect. If you enable encryption, the performance considerations (going from best to worst) are as follows:

- ◆ RC4 offers the least impact on performance; DES is next; the 3DES or AES
- ◆ The RC4 + DES combination offers the least impact of any combination

## **Private Certificate**

When logging in over a secure (SSL) connection, a signed certificate is used to verify that the user is logging in to the intended site. For enhanced security, the *Private Certificate* section allows you to use your own private encryption key and signed certificate, rather than the default ATEN certificate.

### **Generating a Self-Signed Certificate**

If you wish to create your own self-signed certificate, a free utility – openssl.exe – is available for download over the web. See *Self-Signed Private Certificates*, page 223 for details about using OpenSSL to generate your own private key and SSL certificate.

### **Obtaining a CA Signed SSL Server Certificate**

For the greatest security, we recommend using a third party certificate authority (CA) signed certificate. To obtain a third party signed certificate, go to a CA (Certificate Authority) website to apply for an SSL certificate. After the CA sends you the certificate, save it to a convenient location on your computer.

### **Importing the Private Certificate**

To import the private certificate, do the following:

1. Click **Browse** to the right of *Private Key*; browse to where your private encryption key file is located; and select it.
2. Click **Browse** to the right of *Certificate*; browse to where your certificate file is located; and select it.
3. Click **Upload** to complete the procedure.

---

**Note:** Both the private encryption key and the signed certificate must be imported at the same time.

---

## Customization

---

The *Customization* page is used to set *Login Failure*, *Working Mode*, and *Miscellaneous* parameters.

Login Failures	
Allowed:	<input type="text" value="5"/>
Timeout:	<input type="text" value="3"/> min
Working Mode	
<input checked="" type="checkbox"/> Enable ICMP	
<input checked="" type="checkbox"/> Enable Browser	
<input checked="" type="checkbox"/> Enable Multiuser Operation	
<input type="checkbox"/> Force All to Grayscale	
<input checked="" type="checkbox"/> Enable Device List	
<input checked="" type="checkbox"/> Enable Adapter ID	
Misc	
<input type="button" value="Clear Port Names"/>	<input type="button" value="Reset Default Values"/>
<input type="button" value="Adapter Attributes"/>	
<input type="checkbox"/> Reset on exit	

### Login Failures

- ◆ **Allowed** sets the number of consecutive failed login attempts that are permitted from a remote user.
- ◆ **Timeout** sets the amount of time a remote user must wait before attempting to login again after exceeding the number of allowed failures.

## **Working Mode**

- ◆ If *ICMP* is **enabled**, the KVM Over the NET™ switch can be pinged. If it is not enabled, the device cannot be pinged. The default is Enabled.
- ◆ To permit browser access to the KVM Over the NET™ switch, click to put a check mark in the *Enable Browser* checkbox. If browser access is not enabled, users must use either the WinClient AP or Java Client AP program to access the switch. The default is Enabled.
- ◆ Enabling *Multiuser operation* permits up to 32 users to log in at the same time to share the remote bus. If not enabled, only one user can log in at a time. The default is Enabled.
- ◆ If *Force all to grayscale* is enabled, the remote displays of all devices connected to the KVM Over the NET™ switch are changed to grayscale. This can speed up I/O transfer in low bandwidth situations.
- ◆ If *Enable Device List* is enabled, the switch appears in the Server List when using the WinClient AP (see *WinClient AP Login*, page 39). If this option is not enabled, the switch can still be connected to, but its name will not appear in the Server List.
- ◆ When the *Enable Adapter ID* function is enabled (the default) the switch stores adapter cable information for each of its ports, so that when you move a KVM Adapter Cable from one port to another, it remembers the adapter cable's port properties information at the new location (see *The Adapter ID Function*, page 28).

If this function is disabled, moving the adapter will mean having to key in its port properties information all over again at the new port (see *Port Properties*, page 86).

## Miscellaneous

The functions performed by the remaining elements at the bottom of the screen are described in the table, below:

Parameter	Explanation
Clear Port Names	This function removes the names that have been assigned to the ports settings (see <i>Port Naming</i> , page 88).
Reset Default Values	This function undoes all Customization page changes that have been made to the KVM Over the NET™ switch (except for the Port Names), as well as the Network Transfer Rate (on the Network page), and returns the parameters to the original factory default settings.
Adapter Attributes	Clicking this button brings up a dialog box that allows you to set attribute parameters for each of the KVM Adapter Modules connected to the KVM Over the NET™ switch's ports. See the next section for details.

## Adapter Attributes

The *Adapter Attribute Settings* dialog box looks similar to the figure below:

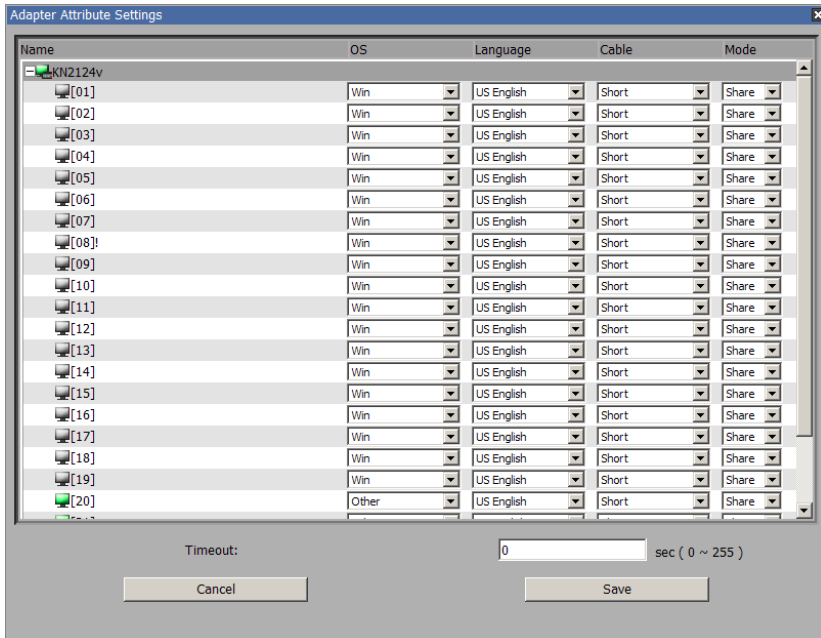



The attribute setting details are the same as the ones that were discussed in Chapter 6, *Port Access*. Refer back to *Port Properties*, page 86 for attribute details.

Select any of the available options from the dropdown listbox for any port.

---

**Note:** With the GUI version, you can use [**Shift**] **Click** or [**Ctrl**] **Click** to select several ports and set an attribute for all of them at the same time

---

After making your choices, click **Save** to save your settings and exit.

### **Reset on Exit**

Place a check here to have the KVM Over the NET™ switch reset itself and implement all the new settings when you log out. Following the reset, wait approximately 30 to 60 seconds before logging back in.

For network IP address settings the *Reset on exit* check box is automatically selected and the KVM switch will reset when you log out. Clearing the check mark before logging out will cause the new IP settings to be ignored and the original IP address settings will remain in effect.

---

**Note:** Even though the new IP information is ignored, it still remains in the field. The next time you access this page Reset on Exit will be enabled. The next time that the switch resets the IP settings that you thought you discarded will be saved. To avoid this problem, you should be sure that the IP settings that appear in the field are the ones you want to save.

---

## Date/Time

The Date/Time dialog page sets the KVM Over the NET™ switch time parameters:

Time Zone

(GMT-12:00) Eniwetok Kwajalein

Daylight Savings Time

Date

February < 2009 >

February 2009

Su	Mo	Tu	We	Th	Fr	Sa
1	2	3	4	5	6	7
8	9	10	11	12	13	14
15	16	17	18	19	20	21
22	23	24	25	26	27	28

Time

15 : 59 : 02

Network Time

Enable auto adjustment

Preferred time server

AU | ntp1.cs.mu.OZ.AU

Preferred custom server IP

Alternate time server

AU | ntp1.cs.mu.OZ.AU

Alternate custom server IP

Adjust time every  days

Set the parameters according to the information below.

### Time Zone

- ◆ To establish the time zone that the KVM Over the NET™ switch is located in, drop down the *Time Zone* list and choose the city that most closely corresponds to where it is at.
- ◆ If your country or region employs Daylight Saving Time (Summer Time), check the corresponding checkbox.

## Date

- ◆ Select the month from the dropdown listbox.
- ◆ Click < or > to move backward or forward by one year increments.
- ◆ In the calendar, click on the day.
- ◆ To set the time, use the 24 hour HH:MM:SS format.
- ◆ Click **Set** to save your settings.

## Network Time

To have the time automatically synchronized to a network time server, do the following:

1. Check the *Enable auto adjustment* checkbox.
2. Drop down the time server list to select your preferred time server  
– or –

Check the *Preferred custom server IP* checkbox, and key in the IP address of the time server of your choice.

3. If you want to configure an alternate time server, check the *Alternate time server* checkbox, and repeat step 2 for the alternate time server entries.
4. Key in your choice for the number of days between synchronization procedures.
5. If you want to synchronize immediately, click **Adjust Time Now**.

This Page Intentionally Left Blank

# Chapter 9 Maintenance

## Overview

The *Maintenance* function is used to upgrade the KVM Over the NET™ switch firmware, as well as the firmware of the KVM Adapter Cables.

## Web Browser Interface

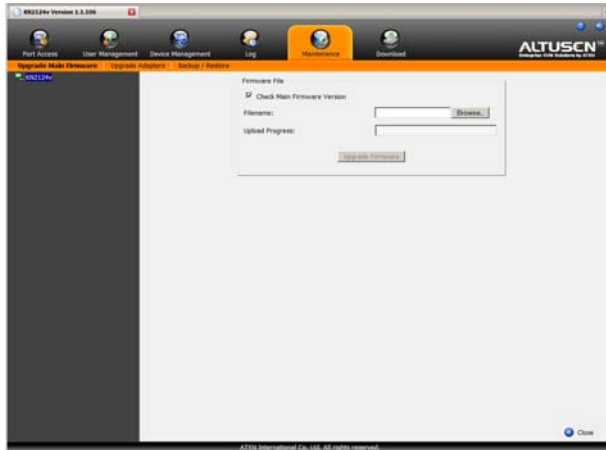

## GUI Interface

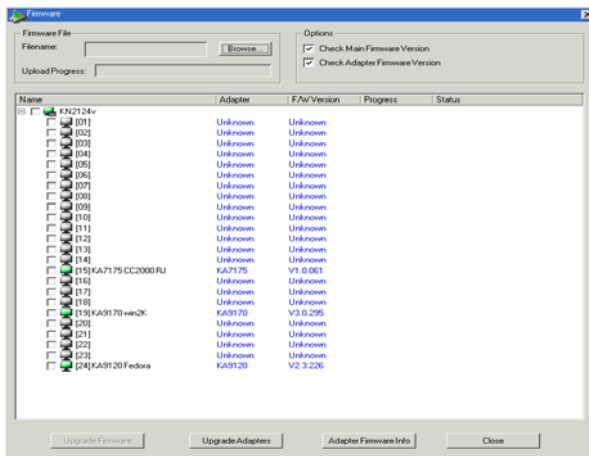

## Page Layout

---

The organization of the Web Browser and GUI pages are similar. The differences are as follows:

- ◆ The Web version has separate menu bar entries for upgrading the main firmware and Adapter firmware.
- ◆ The Web version has a menu bar entry for Backup and Restore.
- ◆ The GUI backup and restore function is contained in the Port Access page. *Export Configuration*, and *Import Configuration*, page 85.

The dialog box is organized into three main areas: *Firmware File*, *Options*, and a large main panel. These are described in the following sections.

### **Firmware File**

As new versions of the KVM Over the NET™ switch firmware become available, they are posted on our website and can be downloaded to a convenient location on your client computer. When performing an upgrade, use this section to navigate to where the download file is located.

### **Options**

If you enable *Check Main Firmware Version*, or *Check Adapter Firmware Version* when you perform an upgrade the current firmware level(s) are compared with that of the upgrade file. If the current version is higher than the upgrade version, a message appears, and gives you the option to *Continue* or *Cancel* the operation.

## The Main Panel

A description of the items shown in this panel are described in the table, below:

Item	Description
Name	A listing of the KVM Over the NET™ switch ports. The checkbox is for selecting ports whose KVM Adapter firmware you want to upgrade.
Adapter	Displays the type of KVM Adapter connected to the port.
F/W Version	Displays the firmware version of the KVM Adapter connected to the port.
Progress	Shows the progress of the firmware upgrade as it takes place.
Status	Shows the status of the upgrade after the process has completed.
Upgrade Firmware	Click this button to upgrade the switch's main firmware. see <i>Upgrading the Main Firmware</i> , page 148, for firmware upgrading details.
Upgrade Adapters	Click this button to upgrade the firmware of the selected adapters. See <i>Adapter Firmware Upgrade</i> , page 149, for details on upgrading adapters.
Adapter Firmware Info	Shows the versions of the KVM Adapter firmware contained in the main firmware file. If anything is newer than the version displayed in the <i>F/W Version</i> column, you may want to upgrade the adapter to the newer version. See <i>Adapter Firmware Upgrade</i> , page 149, for details.

## Upgrading the Main Firmware

---

The following procedure describes upgrading the main firmware. To perform the upgrades, do the following:

1. Go to our website and download the new firmware file to a convenient location on your client computer.
2. In the *Firmware File* section of the Maintenance dialog box, click **Browse**; navigate to where the firmware file is located and select it.
3. Click **Upgrade Firmware** to start the upgrade procedure.
  - ◆ If you enabled *Check Main Firmware Version* the current firmware level is compared with that of the upgrade file. If the current version is equal to or higher than the upgrade version, a popup message appears, to inform you of the situation and stops the upgrade procedure.
  - ◆ If you didn't enable *Check Main Firmware Version*, the upgrade file is installed without checking what its level is.
  - ◆ As the upgrade proceeds, progress information is shown in the *Progress* column.
  - ◆ When the procedure completes the status of the upgrade (Succeeded or Failed) is shown in the *Status* column.
  - ◆ Once the upgrade completes successfully, the switch resets itself.
4. Log in again, and check the firmware version to be sure it is the new one.

---

**Note:** To recover from a “failed upgrade” situation, see *Firmware Upgrade Recovery*, page 150.

---



---

## Adapter Firmware Upgrade

---

The following procedure describes upgrading the firmware of selected KVM Adapter Cables. To perform the upgrades, do the following:

1. Click the Adapter Firmware Info button to see the adapter firmware versions stored by the main firmware.
2. Compare the adapter firmware information with the version shown in the *F/W Version* column of the Main Panel to see if the stored version is newer than the version in the adapter. If the stored version is newer, you will probably want to perform the upgrade.
3. In the *Name* column of the Main Panel, check the ports whose Adapters you want to upgrade.
4. Click **Upgrade Adapters** to start the upgrade procedure.
  - ◆ If you enabled *Check Adapter Firmware Version*, the current firmware level(s) are compared with that of the upgrade file. If the current version is equal to, or higher than the upgrade version, a message appears in the adapters *Progress* column informing you that no upgrade is available and stops the upgrade procedure.
  - ◆ If you didn't enable *Check Adapter Firmware Version*, the upgrade files are installed without checking what their level is.
  - ◆ As the upgrade proceeds, progress information is shown in the *Progress* column.
  - ◆ When the procedure completes the new adapter firmware version displays.

- 
- Note:**
1. The switch may work with older adapter firmware versions, but for optimum compatibility we recommend upgrading your Adapter Cable firmware to that stored with the switch's Main firmware.
  2. You can perform the upgrade procedure anytime you add an Adapter to the installation to make sure it is working with the latest firmware version.
  3. To recover from a "failed upgrade" situation, see *Adapter Cable Firmware Upgrade Recovery*, page 150.
-

## Firmware Upgrade Recovery

---

Should the switch's main firmware upgrade procedure fail, and the switch becomes unusable, the following firmware upgrade recovery procedure will resolve the problem:

1. Power off the switch.
2. Press and hold the Reset Switch in (see *Reset Switch*, page 11 for details).
3. While holding the Reset Switch in, power the switch back on.

This causes the switch to use the original factory installed main firmware version. Once the switch is operational, you can try upgrading the main firmware again.

## Adapter Cable Firmware Upgrade Recovery

---

Should the adapter firmware upgrade procedure fail for one of the KVM Adapter Cables and the adapter becomes unusable, the following adapter firmware upgrade recovery procedure will resolve the problem:

1. Unplug the Adapter from the server it is connected to.
2. Slide its *Firmware Upgrade Recovery Switch* (located next to the Cat 5e connector) to the **RECOVER** position.
3. Plug the Adapter back into the server.
4. Repeat the Adapter upgrade procedure.
5. After the Adapter has been successfully upgraded, unplug the Adapter from the server it is connected to; slide the Firmware Upgrade Recovery Switch back to the **NORMAL** position; and plug the Adapter back in.

## Backup/Restore

When you select Backup/Restore on the Web version menu bar gives you the ability to back up the switch's configuration and user profile information:

opters | Backup / Restore

Backup

Password:

Backup

Restore

Filename:  Browse...

Password:

Options

<input type="checkbox"/> Device Information	<input type="checkbox"/> Network	<input type="checkbox"/> ANMS
<input type="checkbox"/> OOBC	<input type="checkbox"/> Security	<input type="checkbox"/> Customization
<input type="checkbox"/> Date&Time	<input type="checkbox"/> Account	
<input type="checkbox"/> Select All		

Restore

### Backup

To backup the device's settings do the following:

1. In the *Password* field, key in a password for the file.

---

**Note:** Make a note of the password, since you will need it to be able to restore the file.

---

2. Click **Backup**.
3. When the browser asks what you want to do with the file, select *Save to disk*; then save it in a convenient location.

## Restore

To restore a previous backup, do the following:

1. Click **Browse**; navigate to the file and select it.
2. In the *Password* field, key in the same password that you used to save the file.

---

**Note:** If you renamed the file, you can leave the new name. There is no need to return it to its original name.

---

3. Select as many of the options that are presented as you wish to restore.
4. Click **Restore**.

After the file is restored, a message appears to inform you that the procedure succeeded.

# Chapter 10

## Download

### Overview

---

*Download* is used to download stand-alone AP versions of the Windows Client, the Java Client, the Log Server, and Power Over the Net (PON) programs. When you select this tab, a list of available programs appears:

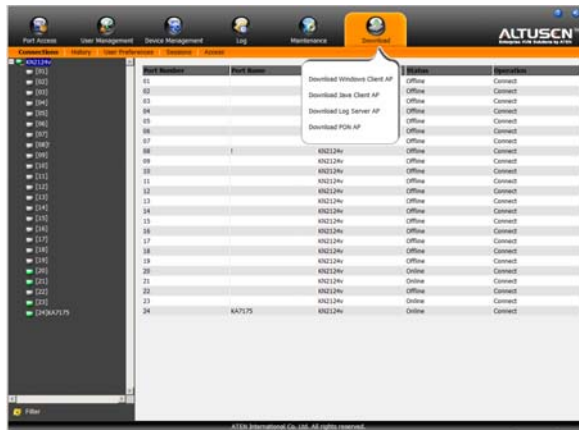

---

**Note:** The number and type of programs that appear will vary depending on your User Type.

---

Click the program you want to download; save it to a convenient location on your hard disk, and run it from there.

- ♦ WinClient AP and Java Client AP operation is the same as browser operation. Refer to Chapter 4, *Logging In*, for login details. Refer to Chapter 6, *Port Access* and Chapter 11, *Port Operation* for port operation details.
- ♦ The Log Server is discussed in Chapter 12.
- ♦ If you are authorized to access a Power Over the Net™ (PON) device connected to the switch, the PON program will allow you to access it.

---

**Note:** The PON program can only be used in the current session. If you log out, the program will stop. You must download and run it again the next time you log in.

---

This Page Intentionally Left Blank

# Chapter 11

## Port Operation

### Overview

---

After you have successfully logged in (see *Logging In*, page 37), the KVM Over the NET™ switch's Main Page appears with the Port Access tab selected:

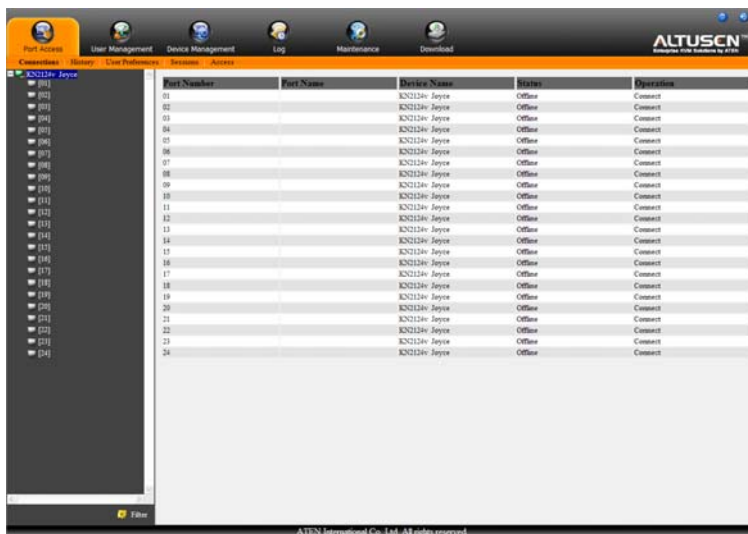

**Note:** 1. The WinClient and Java Client AP programs have a hidden Control Panel either at the upper or lower center of the screen that becomes visible when you mouse over it. The Web Browser version's Control Panel only appears after you switch to a port. The Control Panel is discussed on page 51.

2. See Chapter 6, *Port Access* for details about the Port Access page.

---

All the ports that a user is permitted to access are listed in the Sidebar at the left of the page. To access a device connected to one of the ports, double click its icon.

Once you switch to a port, its screen displays on your monitor, and your keyboard and mouse input affects the remote server:



## The Port Toolbar

The switch interface provides a toolbar to help you with port switching operations from within the captured port. To bring up the toolbar, tap the OSD Hotkey (Scroll Lock or Ctrl), twice. The toolbar appears at the upper left corner of the screen:



Depending on the settings that were selected for ID Display (see page 96), the Port Number and/or the Port Name display at the right of the toolbar. The meanings of the toolbar icons are given in a table on page 157.









**Note:** You can adjust the toolbar transparency (see *Video Settings*, page 64).

When the toolbar displays, mouse input is confined to the toolbar area and keyboard input has no effect on the server connected to the port. To carry out operations on the server, close the toolbar by clicking the **X** on it; or, recall the Port Access page and select the port again.



## The Toolbar Icons

The meanings of the toolbar icons are explained in the table below.

Icon	Purpose
	Click to skip to the first accessible port on the entire installation without having to recall the Port Access page.
	Click to skip to the first accessible port previous to the current one without having to recall the Port Access page.
	Click to begin Auto Scan Mode. The KVM Over the NET™ switch automatically switches among the ports that were selected for Auto Scanning with the Port Select and Filter functions (see <i>Filter</i> , page 90). This allows you to monitor their activity without having to switch among them manually.
	Click to skip from the current port to the next accessible one without having to recall the Port Access page.
	Click to skip from the current port to the last accessible port on the entire installation without having to recall the Port Access page.
	Click to recall the Port Access page.
	Click to close the toolbar.
	Click to invoke Panel Array Mode (see <i>Panel Array Mode</i> , page 161). <b>Note:</b> The Local Console does not have this function. See the entry below for the Local Console icon and function.
	This icon is only found on the Local Console. Clicking this button cycles you through the I/O module's compensation mode choices (Short, Medium, Long) depending on the length of cable used to connect a device to the switch. The length of the line in the icon changes to indicate which choice is selected.

## **Toolbar Hotkey Port Switching**

When the toolbar displays, you can use hotkeys to provide KVM focus to a port directly from the keyboard. The KVM Over the NET™ switch provides the following hotkey features:

- ◆ Auto Scanning
- ◆ Skip Mode Switching

The hotkeys are: **A** and **P** for Auto Scanning; and the **Arrow Keys** for Skip Mode.

- 
- Note:** 1. In order for hotkey operations to take place, the toolbar must be visible (see *The Port Toolbar*, page 156).
2. To use the keys designated as hotkeys (i.e. A, P, etc.) for normal, non-hotkey purposes, you must first close the toolbar.
3. For issues affecting multiple user operation in Auto Scan Mode, see *Multiuser Operation*, page 163.
- 

## **Auto Scanning**

The Scan function automatically switches among all the ports that are accessible to the currently logged on user at regular intervals, so that the user can monitor their activity automatically. Users can also limit the number of ports scanned with the Filter function of the Sidebar Tree. See *Scan*, page 89, and *Filter*, page 90, for further details.

## **Setting the Scan Interval:**

The amount of time Auto Scan dwells on each port is set with the *Scan Duration* setting (see *Scan Duration*, page 97).

## **Invoking Auto Scan**

To start Auto Scanning, with the toolbar showing, tap the **A** key. The Auto Scan function cycles through the ports in order - starting from the first port on the installation. An **S** appears in front of the Port ID Display to indicate that the port is being accessed under Auto Scan Mode.

## Pausing Auto Scan

While you are in Auto Scan Mode, you can pause the scanning in order to keep the focus on a particular server by pressing **P**. During the time that Auto Scanning is paused, the **S** in front of the Port ID blinks On and Off.

*Pausing* when you want to keep the focus on a particular server can be more convenient than exiting Auto Scan Mode because when you *Resume* scanning, you start from where you left off. If, on the other hand, you were to exit and then restart Auto Scan Mode, the scanning would start over from the very first server on the installation.

To *Resume* Auto Scanning after a pause, press any key except [Esc] or the [Spacebar]. Scanning continues from where it left off.

## Exiting Auto Scan

While Auto Scan Mode is in effect, ordinary keyboard functions are suspended. You must exit Auto Scan Mode in order to regain normal control of the keyboard. To exit Auto Scan Mode press [Esc] or the [Spacebar]. Auto Scanning stops when you exit Auto Scan Mode.

## Skip Mode

Skip Mode allows you to switch ports in order to monitor the servers manually. You can dwell on a particular port for as long or as little as you like - as opposed to Auto Scanning, which automatically switches after a fixed interval. The Skip Mode hotkeys are the four Arrow keys. Their operation is explained in the table below:

Arrow	Action
←	Skips from the current port to the first accessible port previous to it.
→	Skips from the current port to the first accessible port that comes after it.
↑	Skips from the current port to the very first accessible port on the installation.
↓	Skips from the current port to the very last accessible port on the installation.

## **Recalling the Port Access Page**

To dismiss the toolbar and bring back the Port Access page, do one of the following:

- ◆ Tap the OSD Hotkey once.
- ◆ From the toolbar, click the icon that recalls the Port Access page (see *The Toolbar Icons*, page 157).

The toolbar closes, and the Port Access Page appears.

## **OSD Hotkey Summary Table**

The following table presents a summary of the OSD Hotkey actions after you have accessed a port. See *OSD Hotkey*, page 96 to set the OSD Hotkey.

<b>To...</b>		<b>Do This...</b>
Open the Toolbar		Click the OSD Hotkey twice
Open the Port Access Page	The Toolbar is open	Click the OSD Hotkey once
	The Toolbar is not open	Click the OSD Hotkey three times

## Panel Array Mode



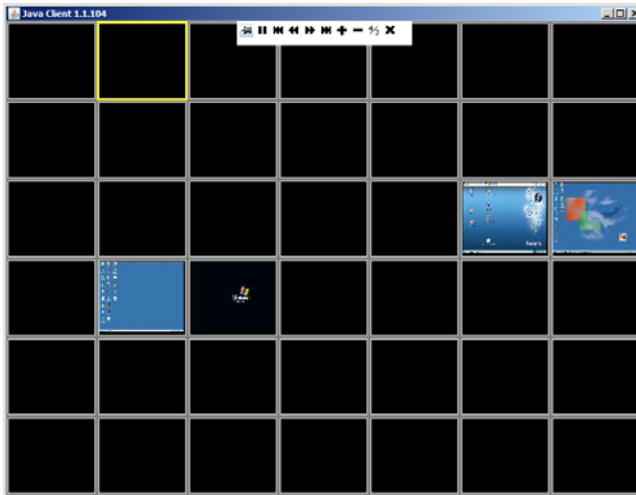







Clicking the toolbar's *Panel* icon invokes Panel Array Mode. Under this mode, the your screen divides into a grid of up to 42 panels:



- ◆ Each panel represents one of the switch's ports beginning with Port 1 at the upper left, and going from left to right; top to bottom.
- ◆ The number of panels in the array can be selected by clicking the **Show More Ports**, and **Show Fewer Ports** symbols on the panel array toolbar (see the following page).
- ◆ When the Array is first invoked, it scans through each of the ports that were selected for Auto Scanning with the Port Select and Filter functions (see *Filter*, page 90). The border of the panel that has the focus is highlighted.
- ◆ Only ports that are accessible to the user are displayed. For ports that are not accessible, the panel is blank.
- ◆ If the server connected to a port is on line, its screen displays in its panel, otherwise the panel is blank.
- ◆ Mousing over a panel displays information about the port (port name, online status, port access status, and resolution).
- ◆ You can access a server connected to a port by moving the mouse pointer over its panel and clicking. You switch to the server exactly as if you had selected it from the Port Access page.

## **Panel Array Toolbar**

The panel array toolbar, (hidden at the top center of the screen for the Java Applet Viewer and Java Client AP), provides shortcut navigation and control of the panel array. Mouse over the top center to bring up the toolbar. If you like, you can click and drag it anywhere on the screen. Mousing over an icon brings up a “tooltip” that provides a short description of the icon’s function. The icon functions are described in the table below:

	Click the pushpin to have the toolbar always be on top.
	Pause panel scanning, leaving the focus on the panel that currently has it.
	Move back four panels.
	Move to the previous panel.
	Move to the next panel.
	Move ahead four panels.
	Show More Ports: Increase the number of panels in the array.
	Show Fewer Ports: Decrease the number of panels in the array.
	Toggle 4/3 aspect ratio.
	Exit Panel Array mode.

---

**Note:** For issues affecting multiple user operation in Panel Array Mode, see *Multiuser Operation*, page 163.

---

## Multuser Operation

The KVM Over the NET™ switch supports multuser operation. When multiple users simultaneously access the switch from client computers, the rules of precedence that apply are shown in the following table:

Operation	Rule
General	Each bus is independent, for the method by which users are assigned to buses, see the next section, <i>Users and Buses</i> . Each user can open his own independent GUI Main Page.
Auto Scan Mode	<p>If a user has invoked Auto Scan Mode (see page 158), and then another user logs on and gets assigned to the same bus, at first the new user sees the GUI Main Page – but as soon as he accesses any port, he automatically enters Auto Scan Mode (since he is sharing the bus with the original user).</p> <p>Any user on the bus can halt Auto Scan Mode by recalling the GUI Main Page. When this occurs, Auto Scan Mode stops and all the other users on the bus are switched to the port that was being accessed when Auto Scan Mode stopped.</p>
Panel Array Mode	<ul style="list-style-type: none"> <li>◆ If a user has invoked Panel Array Mode (see page 161), and then another user logs on and gets assigned to the same bus, at first the new user sees the GUI Main Page – but as soon as he accesses any port, he automatically enters Panel Array Mode (since he is sharing the bus with the original user).</li> <li>◆ Panel Array Mode continues until the original user stops it. (Administrators can override Panel Array Mode, however.)</li> <li>◆ Only the user who starts Panel Array Mode can use the Skip Mode (see page 159), function.</li> <li>◆ Only the user who starts Panel Array Mode can switch ports. Other users automatically switch to the ports that the original user selects. However, if one of the other users does not have access rights to the port that the original users switches to, that user will not be able to view the port.</li> <li>◆ Individual users can increase or decrease the number of panels they wish to view in Panel Array Mode; however, the picture quality may decrease as the number of panels decreases.</li> </ul>

## **Users and Buses**

- ◆ The KN2132, KN2124v, and KN2140v only support two remote buses. The first, third, fifth, etc., users to log in are all on one bus; the second, fourth, sixth, etc., users to log in are all on the other bus.
- ◆ The KN4116, KN4132, KN4142v, and KN4140v support four remote buses. The first, fifth, ninth, etc. users are all on the first bus; the second, sixth, 10th, etc.; users are all on the second bus; the third, seventh, 11th, etc.; users are all on the third bus; the fourth, eighth, 12th, etc.; users are all on the fourth bus.
- ◆ The switches support independent bus switching. With independent bus switching, if a user switches to a port that is being utilized by someone on a different bus, only the user that switched ports goes to the new port and the new bus – the other users on the original bus remain on the original port and original bus.

---

**Note:** Independent bus switching does not work when Auto Scan Mode or Panel Array Mode is being used by one of the members of the bus.

---

- ◆ We recommend that the user who starts Panel Array Mode set it to display at least four panels. Otherwise, it is possible that the other users may only receive part of the picture.



# Chapter 12

## The Log Server

The Windows-based Log Server is an administrative utility that records all the events that take place on selected KVM Over the NET™ switch units and writes them to a searchable database. This chapter describes how to install and configure the Log Server.

### Installation

---

1. From the computer that you want to use as the Log Server, open your browser and log into the KVM Over the NET™ switch (see page 38).
2. Click the *Log Server* button at the left of the webpage to start the Log Server installation program.
3. If any security warning dialog boxes appear, ignore them and click **Run** or **Open**.

---

**Note:** If the browser cannot run the file, save it to disk, instead, and run the file from your disk.

---

The Log Server installation screen appears:

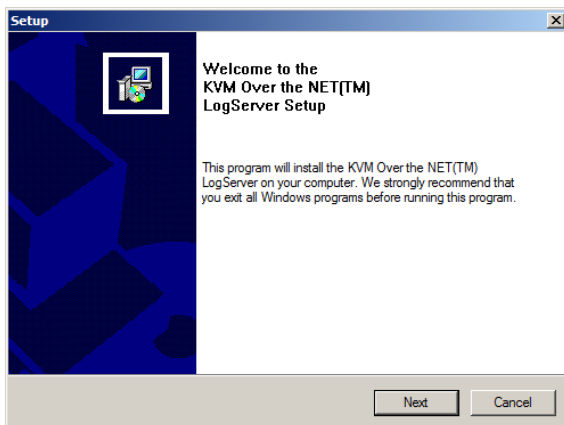

4. Click **Next**. Then follow the on-screen instructions to complete the installation and have the Log Server program icon placed on your desktop.

## Starting Up

---

To start the Log Server, either double click the program icon, or key in the full path to the program on the command line. The first time your run it, a screen similar to the one below appears:

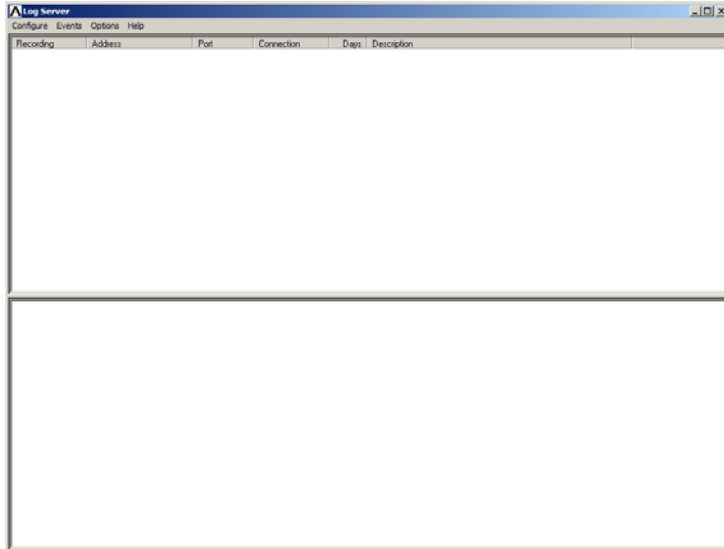

- 
- Note:**
1. The MAC address of the Log Server computer must be specified in the ANMS settings – see *Log Server*, page 130.
  2. The Log Server requires the Microsoft Jet OLEDB 4.0 driver. See *The Log Server program does not run.*, page 205 if the program doesn't start.
- 

The screen is divided into three components:

- ♦ A *Menu Bar* at the top
- ♦ A panel that will contain a list of KVM Over the NET™ units in the middle (see *The Log Server Main Screen*, page 171).
- ♦ A panel that will contain an *Events List* at the bottom

Each of the components is explained in the sections that follow.

---

## The Menu Bar

---

The Menu bar consists of four items:

- ◆ Configure
- ◆ Events
- ◆ Options
- ◆ Help

These are discussed in the sections that follow.

---

**Note:** If the Menu Bar appears to be disabled, click in the List window to enable it.

---

### Configure

The Configure menu contains three items: Add; Edit; and Delete. They are used to add new units to the List; edit the information for units already on the list; or delete units from the list.

- ◆ To add a unit to the list, click **Add**.
- ◆ To edit or delete a listed unit, first select the target in the List window, then open this menu and click **Edit** or **Delete**.

When you choose *Add* or *Edit*, a dialog box, similar to the one below, appears:

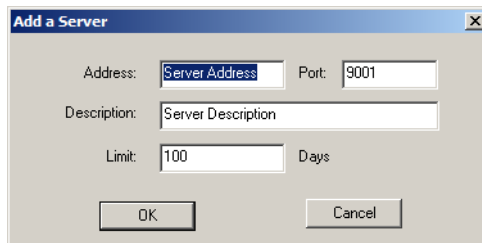

The screenshot shows a dialog box titled "Add a Server". It has a standard Windows-style title bar with a close button (X). The dialog contains the following fields and controls:

- Address:** A text input field containing "Server Address".
- Port:** A text input field containing "9001".
- Description:** A text input field containing "Server Description".
- Limit:** A text input field containing "100", followed by the text "Days".
- Buttons:** "OK" and "Cancel" buttons at the bottom.

A description of the fields is given in the table, below:

Field	Explanation
Address	This can either be the IP address of the unit or its DNS name (if the network administrator has assigned it a DNS name).
Port	The port number that was assigned to the Log Server (see <i>Date/Time</i> , page 142).
Description	This field is provided so that you can put in a descriptive reference for the unit to help identify it.
Limit	This specifies the number of days that an event should be kept in the Log Server's database. Events that exceed the amount of time specified here can be removed with the Maintenance function (see <i>Maintenance</i> ., page 169).

Fill in or modify the fields, then click **OK** to finish.

## Events

The Events Menu has two items: *Search* and *Maintenance*.

### Search:

*Search* allows you to search for events containing specific words or strings. When you access this function, a screen, similar to the one below, appears:

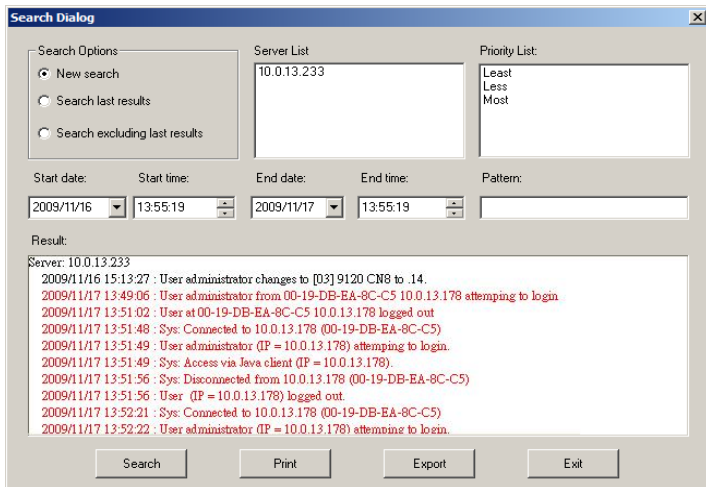

A description of the items is given in the table, below:

Item	Description
New search	This is one of three radio buttons that define the scope of the search. If it is selected, the search is performed on all the events in the database for the selected unit.
Search last results	This is a secondary search performed on the events that resulted from the previous search.
Search excluding last results	This is a secondary search performed on all the events in the database for the selected unit excluding the events that resulted from the previous search.
Server List	KVM Over the NET™ units are listed according to their IP address. Select the unit that you want to perform the search on from this list. You can select more than one unit for the search. If no units are selected, the search is performed on all of them.
Priority	Sets the level for how detailed the search results display should be. <i>Least</i> is the most general; <i>Most</i> is the most specific. Least results appear in black; Less results appear in blue; Most results appear in red.
Start Date	Select the date that you want the search to start from. The format follows the YYYY/MM/DD convention, as follows: 2009/11/04
Start Time	Select the time that you want the search to start from. The format follows the HH:MM:SS convention.
End Date	Select the date that you want the search to end at.
End Time	Select the time that you want the search to end at.
Pattern	Key in the pattern that you are searching for here. The multiple character wildcard (%) is supported. E.g., h%ds would match hands and hoods.
Results	Lists the events that contained matches for the search.
Search	Click this button to start the search.
Print	Click this button to print the search results.
Export	Click this button to save the search results to file.
Exit	Click this button to exit the Log Server.

### Maintenance:

This function allows the administrator to perform manual maintenance of the database, such as erasing specified records before their expiration time is up.

## **Options**

*Network Retry* allows you to set the number of seconds that the Log Server should wait before attempting to connect if its previous attempt to connect failed. When you click this item, a dialog box, similar to the one below, appears:

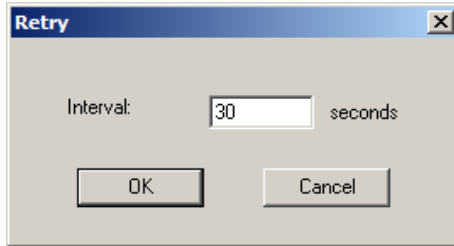

Key in the number of seconds, then click **OK** to finish.

## **Help**

From the Help menu, click Contents to access the online Windows Help file. The help file contains instructions about how to setup, operation and troubleshoot the Log Server.

# The Log Server Main Screen

## Overview

The Log Server Main Screen is divided into two main panels.

- ◆ The upper (List) panel lists all of the units that have been selected for the Log Server to track (see *Configure*, page 167).
- ◆ The lower (Event) panel displays the tick information for the currently selected unit. (If there are more than one unit, the selected unit is the one that is highlighted).
- ◆ To select a unit in the list, simply click on it.

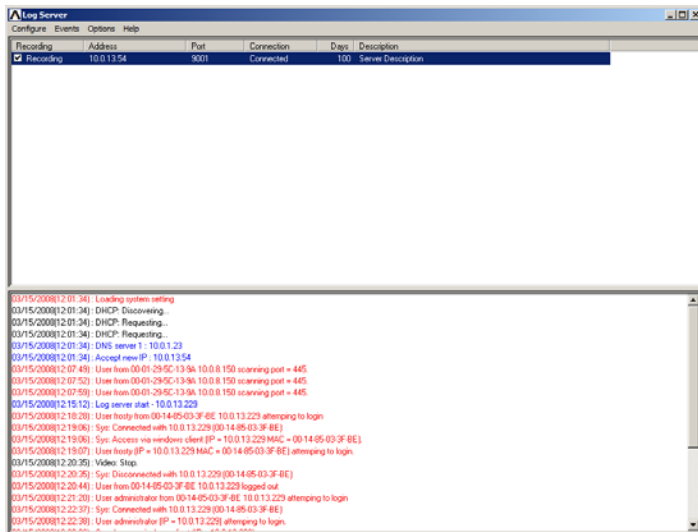

## The List Panel

The List panel contains six fields:

Field	Explanation
Recording	Determines whether the Log Server records the ticks for this unit, or not. If the Recording checkbox is checked, the field displays <i>Recording</i> , and the ticks are recorded. If the Recording checkbox is not checked, the field displays <i>Paused</i> , and the ticks are not recorded. <b>Note:</b> Even though a unit is not the currently selected one, if its Recording checkbox is checked, the Log Server will still record its ticks.
Address	This is the IP Address or DNS name that was given to the unit when it was added to the Log Server (see <i>Configure</i> , page 167).
Port	This is the Access Port number assigned to the unit (see <i>Configure</i> , page 167).
Connection	<ul style="list-style-type: none"><li>◆ If the Log Server is connected to the unit, this field displays <i>Connected</i>.</li><li>◆ If the Log Server is not connected, this field displays <i>Waiting</i>. This means that the Log Server's MAC address has not been set properly. It needs to be set on the <i>Device Management Date/Time</i> page (see page 142).</li></ul>
Days	This field displays the number of days that the unit's log events are to be kept in the Log Server's database before expiration (see <i>Configure</i> , page 167).
Description	This field displays the descriptive information given for the unit when it was added to the Log Server (see <i>Configure</i> , page 167).

## The Event Panel

The lower panel displays log events for the currently selected unit. Note that if there are more than one units, even though they aren't currently selected, if their *Recording* checkbox is checked, the Log Server records their log events and keeps them in its database.



# Chapter 13

## LDAP Server Configuration

### Introduction

---

The KVM Over the NET™ switch allows log in authentication and authorization through external programs. This chapter describes how to configure Active Directory for KVM Over the NET™ switch authentication and authorization.

To allow authentication and authorization via LDAP or LDAPS, the Active Directory's LDAP *Schema* must be extended so that an extended attribute name for the KVM Over the NET™ switch – ***iKVM4140-userProfile*** – is added as an optional attribute to the *person* class.

---

**Note:** *Authentication* refers to determining the authenticity of the person logging in; *authorization* refers to assigning permission to use the device's various functions.

---

In order to configure the LDAP server, you will have to complete the following procedures: 1) Install the Windows Server Support Tools; 2) Install the Active Directory Schema Snap-in; and 3) Extend and Update the Active Directory Schema.

The following section provides an example of configuring LDAP under Windows 2003 Server.

### Install the Windows 2003 Support Tools

---

To install the Windows 2003 Support Tools, do the following:

1. On your Windows Server CD, open the Support → Tools folder.
2. In the right panel of the dialog box that comes up, double click **SupTools.msi**.
3. Follow along with the Installation Wizard to complete the procedure.

## Install the Active Directory Schema Snap-in

---

To install the Active Directory Schema Snap-in, do the following:

1. Open a Command Prompt.
2. Key in: `regsvr32 schmmgmt.dll` to register schmmgmt.dll on your Active Directory computer.
3. Open the *Start* menu; click **Run**; key in: `mmc /a`; click **OK**.
4. On the *File* menu of the screen that appears, click **Add/Remove Snap-in**; then click **Add**.
5. Under *Available Standalone Snap-ins*, double click **Active Directory Schema**; click **Close**; click **OK**.
6. On the screen you are in, open the *File* menu and click **Save**.
7. For *Save in*, specify the `C:\Windows\system32` directory.
8. For *File name*, key in **schmmgmt.msc**.
9. Click **Save** to complete the procedure.

## Create a Start Menu Shortcut Entry

---

To create a shortcut entry on the Start Menu for the Active Directory Schema, do the following:

1. Right click Start; select: **Open all Users** → **Programs** → **Administrative Tools**.
2. On the *File* menu, select **New** → **Shortcut**
3. In the dialog box that comes up, browse to, or key in the path to schmmgmt.msc (`C:\Windows\system32\schmmgmt.msc`), then click **Next**.
4. In the dialog box that comes up, key in *Active Directory Schema* as the name for the shortcut, then click **Finish**.

## Extend and Update the Active Directory Schema

To extend and update the Active Directory Schema, you must do the following 3 procedures: 1) create a new attribute; 2) extend the object class with the new attribute; and 3) edit the active directory users with the extended schema.

### Creating a New Attribute

To create a new attribute do the following:

1. From the Start menu, open Administrative Tools → Active Directory Schema.
2. In the left panel of the screen that comes up, right-click **Attributes**:

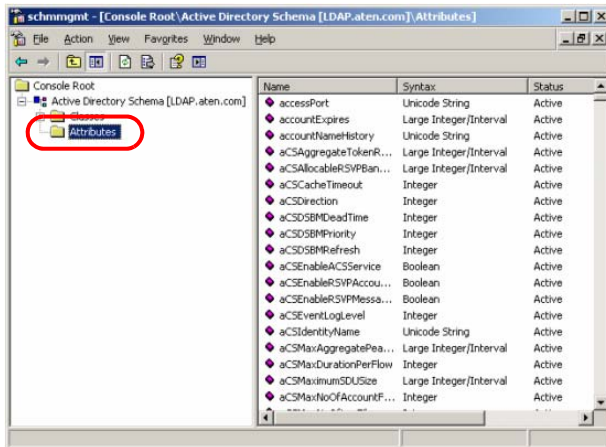

3. Select New → Attribute.
4. In the warning message that appears, click **Continue** to bring up the *Create New Attribute* dialog box.

(Continues on next page.)

(Continued from previous page.)

5. Fill in the dialog box to match the entries for *Description* and *Common Name* shown below, then click **OK** to complete the procedure.

---

**Note:** The Unique X500 Object ID uses periods, not commas.

---

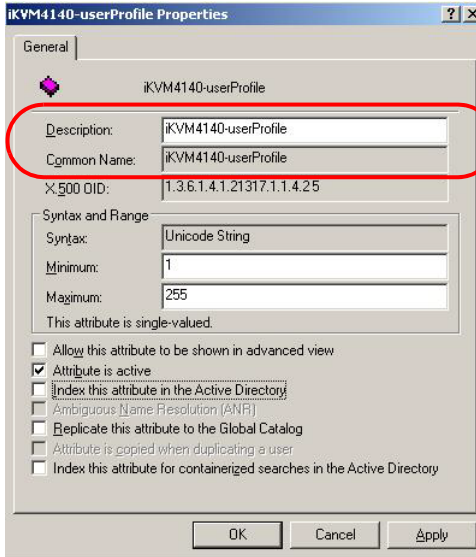

The screenshot shows the 'iKVM4140-userProfile Properties' dialog box, General tab. The 'Description' and 'Common Name' fields are circled in red. The 'X500 OID' field contains '1.3.6.1.4.1.21317.1.1.4.25'. The 'Syntax and Range' section shows 'Syntax' as 'Unicode String', 'Minimum' as '1', and 'Maximum' as '255'. The 'Attribute is active' checkbox is checked.

Field	Value
Description	iKVM4140-userProfile
Common Name	iKVM4140-userProfile
X500 OID	1.3.6.1.4.1.21317.1.1.4.25
Syntax	Unicode String
Minimum	1
Maximum	255

Allow this attribute to be shown in advanced view  
 Attribute is active  
 Index this attribute in the Active Directory  
 Ambiguous Name Resolution (ANR)  
 Replicate this attribute to the Global Catalog  
 Attribute is copied when duplicating a user  
 Index this attribute for containerized searches in the Active Directory

Buttons: OK, Cancel, Apply

## Extending the Object Class With the New Attribute

To extend the object class with the new attribute, do the following:

1. Open the Control Panel → Administrative Tools → Active Directory Schema.
2. In the left panel of the screen that comes up, select **Classes**.
3. In the right panel, right-click **person**:

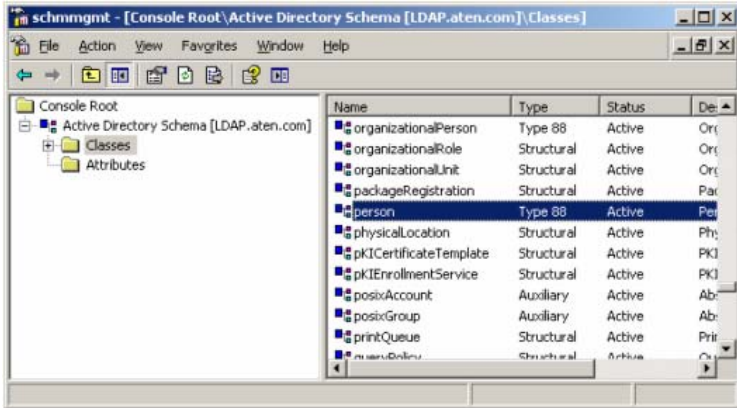

4. Select **Properties**; the *person Properties* dialog box comes up with the *General* page displayed. Click the *Attributes* tab.



5. On the *Attributes* page, click **Add**:

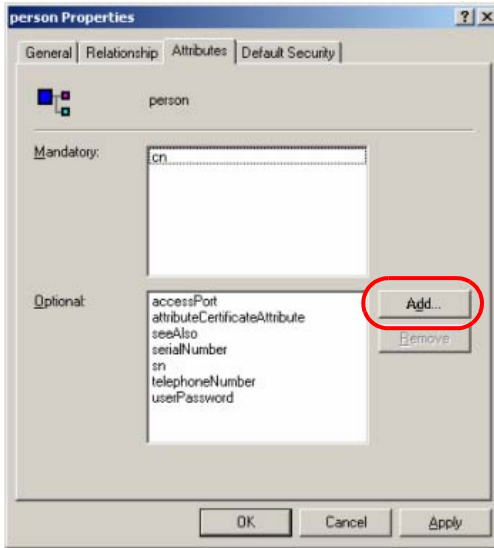

6. In the list that comes up, select **iKVM4140-userProfile**, then click **OK** to complete the procedure.

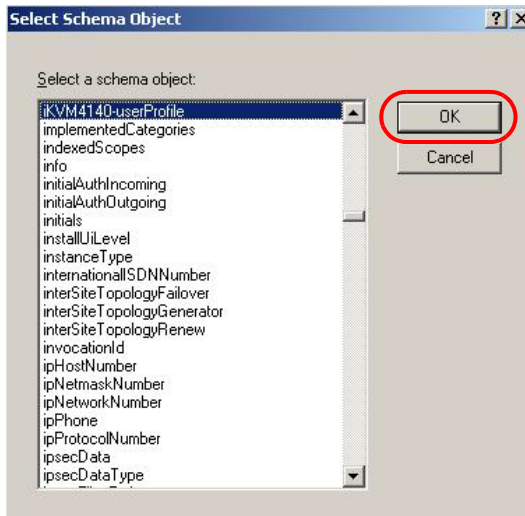

## Editing Active Directory Users

To edit Active Directory Users With the Extended Schema, do the following:

1. Run **ADSI Edit**. (Installed as part of the *Support Tools*.)
2. In the left panel, open **Domain**, and navigate to the **DC=aten,DC=com** **CN=Users** node.
3. In the right panel, locate the user you wish to edit. (Our example uses *jason*.)

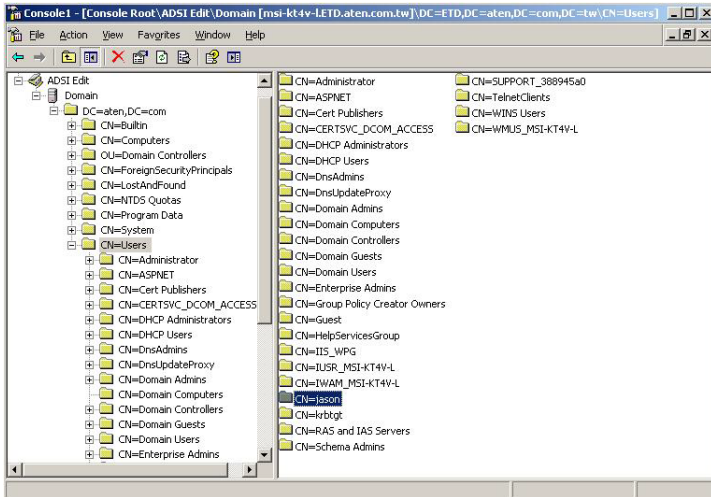

4. Right-click on the user's name and select **properties**.

*(Continues on next page.)*

(Continued from previous page.)

5. On the *Attribute Editor* page of the dialog box that appears, select **iKVM4140-userProfile** from the list.

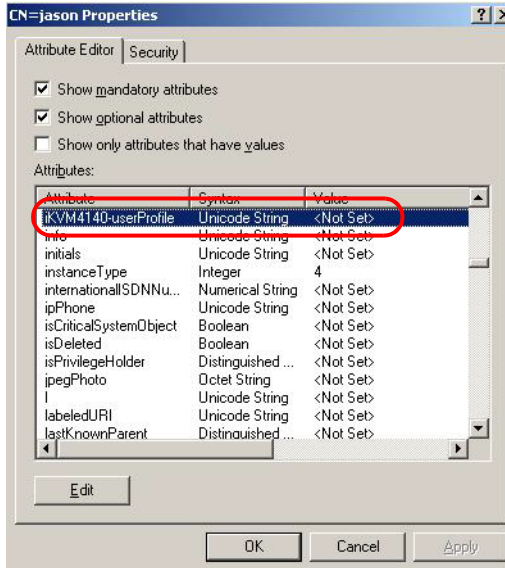

6. Click **Edit** to bring up the *String Attribute Editor*:

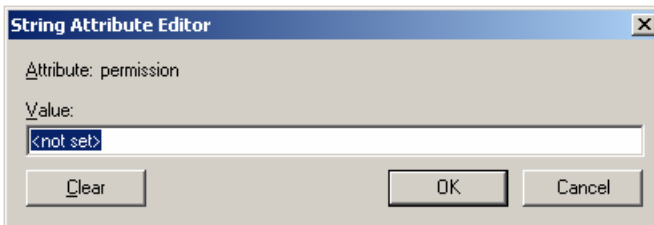

(Continues on next page.)



(Continued from previous page.)

7. Key in the KVM Over the NET™ switch permission attribute values. For example:



**Note:** Where *user* represents the Username of a KVM Over the NET™ switch user whose permissions reflect the permissions you want Jason to have (see *Users*, page 107).

8. Click **OK**. When you return to the *Attribute Editor* page, the *iKVM4140-userProfile* entry now reflects the new permissions:

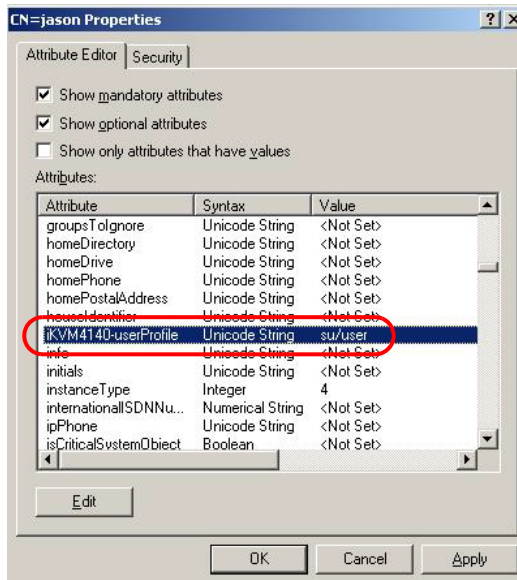

- a) Click **Apply** to save the change and complete the procedure. Jason now has the same permissions as *user*.
- b) Repeat the *Editing Active Directory Users* procedure for any other users you wish to add.

## OpenLDAP

OpenLDAP is an Open source LDAP server designed for Unix platforms. A Windows version can be downloaded from:

```
http://download.bergmans.us/openldap/openldap-2.2.29/  
openldap-2.2.29-db-4.3.29-openssl-0.9.8a-  
win32_Setup.exe.
```

### OpenLDAP Server Installation

After downloading the program, launch the installer, select your language, accept the license and choose the target installation directory. The default directory is: *c:\Program Files\OpenLDAP*.

When the *Select Components* dialog box appears, select *install BDB-tools* and *install OpenLDAP-slapd as NT service*, as shown in the diagram, below:

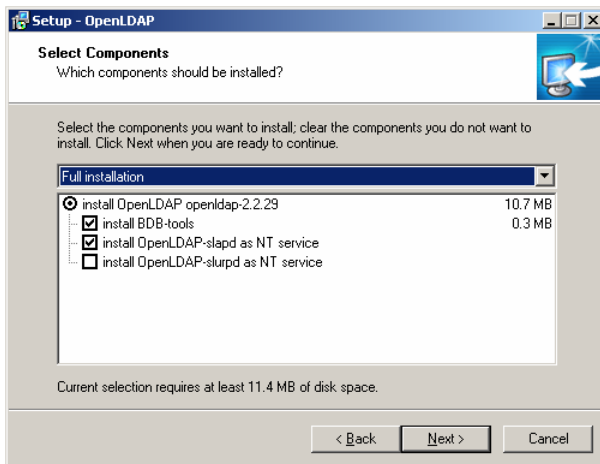

## **OpenLDAP Server Configuration**

The main OpenLDAP configuration file, *slapd.conf*, is found in the */OpenLdap* directory. It has to be customized before launching the server. This section provides a quick summary of the modifications to the configuration file in order for it to be used with the KVM Over the NET™ switch, for a complete explanation of OpenLDAP, refer to the official OpenLDAP documentation.

The modifications to the configuration file will do the following:

- ◆ Specify the Unicode data directory. The default is *./ucdata*.
- ◆ Choose the required LDAP schemas. The core schema is mandatory.
- ◆ Configure the path for the OpenLDAP *pid* and *args* start up files. The first contains the server pid, the second includes command line arguments.
- ◆ Choose the database type. The default is *bdb* (Berkeley DB).
- ◆ Specify the server suffix. All entries in the directory will have this suffix, which represents the root of the directory tree. For example, with suffix *dc=aten,dc=com*, the fully qualified name of all entries in the database will end with *dc=aten,dc=com*.
- ◆ Define the name of the administrator entry for the server (*rootdn*), along with its password (*rootpw*). This is the server's super user. The *rootdn* name must match the suffix defined above. (Since all entry names must end with the defined suffix, and the *rootdn* is an entry.)

An example configuration file is provided in the figure, below:

```
ucdata-path ./ucdata
include ./schema/core.schema

pidfile /run/slapd.pid
argsfile /run/slapd.args

database bdb
suffix "dc=aten,dc=com"
rootdn "cn=ldapadmin,dc=aten,dc=com"
rootpw password
directory /data
```

## **Starting the OpenLDAP Server**

To start the OpenLDAP Server, run **slapd** (the OpenLDAP Server executable file) from the command line. slapd supports a number of command line options, the most important option is the **d** switch that triggers debug information. For example, a command of:

```
slapd -d 256
```

would start OpenLDAP with a debug level of 256, as shown in the following screenshot:

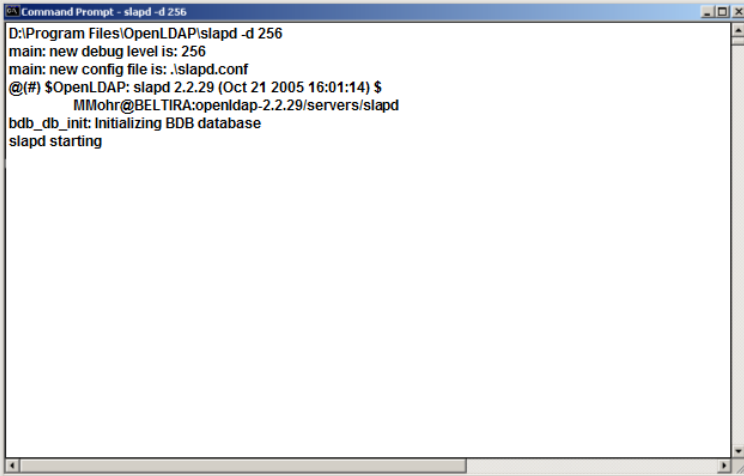

```
Command Prompt - slapd -d 256
D:\Program Files\OpenLDAP\slapd -d 256
main: new debug level is: 256
main: new config file is: .\slapd.conf
@(#) $OpenLDAP: slapd 2.2.29 (Oct 21 2005 16:01:14) $
MMohr@BELTIRA:openldap-2.2.29/servers/slapd
bdb_db_init: Initializing BDB database
slapd starting
```

---

**Note:** For details about slapd options and their meanings, refer to the OpenLDAP documentation.

---

## **Customizing the OpenLDAP Schema**

The schema that slapd uses may be extended to support additional syntaxes, matching rules, attribute types, and object classes.

In the case of the KVM Over the NET™ switch, the *User* class and the *permission* attribute are extended to define a new schema. The extended schema file used to authenticate and authorize users logging in to the KVM Over the NET™ switch is shown in the figure, below:

```
#####
##
##      Summary: Define the LDAP schema
##
#####
#
#  ATEN OID:={1.3.6.1.4.1.21317}
#

attributetype (1.3.6.1.4.1.21317.1.1.4.2.6
    NAME 'iKVM4140-userProfile'
    EQUALITY caseIgnoreMatch
    SUBSTR caseIgnoreSubstringsMatch
    SYNTAX 1.3.6.1.4.1.1466.115.121.1.15
    SINGLE-VALUE )

objectclass ( 1.3.6.1.4.1.21317.1.1.4.2
    NAME 'kn4140User'
    SUP organizationalPerson
    STRUCTURAL
    MAY (iKVM4140-userProfile $ userCertificate.))
```

## **LDAP DIT Design and LDIF File**

### **LDAP Data Structure**

An LDAP Directory stores information in a tree structure known as the Directory Information Tree (DIT). The nodes in the tree are directory entries, and each entry contains information in attribute-value form. An example of the LDAP directory tree for the KN2124v / KN2140v / KN4124v / KN4140v / KN2132 / KN4116 / KN4132 is shown in the figure, below:

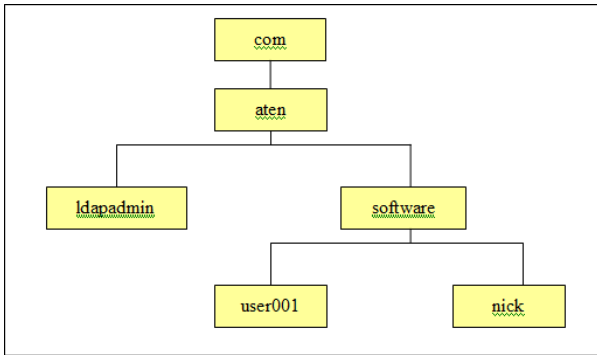

*(Continues on next page.)*

(Continued from previous page.)

## DIT Creation

The LDAP Data Interchange Format (LDIF) is used to represent LDAP entries in a simple text format (please refer to RFC 2849). The figure below illustrates an LDIF file that creates the DIT for the KN4140 directory tree. The name of the file is *init.ldif* and you create it in the /OpenLDAP directory, as follows:

```
dn: dc=aten,dc=com
objectclass: top
objectclass: dcObject
objectclass: organization
o: Aten Canada
dc: aten

dn: cn=ldapadmin,dc=aten,dc=com
objectclass: top
objectclass: person
objectclass: organizationalPerson
cn: ldapadmin
sn: ldapadmin
userPassword: password

dn: ou=software,dc=aten,dc=com
objectclass: top
objectclass: organizationalUnit
ou: software

dn: cn=user001,ou=software,dc=aten,dc=com
objectclass: top
objectclass: person
objectclass: organizationalPerson
objectclass: kn4140user
cn: user001
sn: user001
iKVM4140-userProfile: su/administrator
userPassword: password
```

## Using the New Schema

To use the new schema, do the following:

1. Save the new schema file (e.g., kn4140.schema) in the /OpenLDAP/schema/ directory.
2. Add the new schema to the *slapd.conf* file (in the /OpenLDAP directory), as shown in the figure, below:

```
ucdata-path /ucdata
include     /schema/core.schema
include     /schema/cosine.schema
include     /schema/inetorgperson.schema
include     /schema/openldap.schema
include     /schema/kn4140.schema

# Define global ACLs to disable default read access.
access to dn.children="ou=software,dc=aten,dc=com"
    by dn="cn=ldapadmin,dc=aten,dc=com" write
    by self read
    by anonymous auth
    by * none

pidfile     /run/slapd.pid
argsfile    /run/slapd.args
#####
# BDB database definitions
#####
database    bdb
suffix      "dc=aten,dc=com"
rootdn      "cn=ldapadmin,dc=aten,dc=com"
rootpw      password
directory  /data
# Indices to maintain
index       objectClass eq
```

3. Restart the LDAP server.
4. Write the LDIF file and create the database entries in *init.ldif* with the *ldapadd* command, as shown in the following example:

```
ldapadd -f init.ldif -x -D "cn=ldapadmin,dc=aten,dc=com"
-w password
```



## Safety Instructions

---

### General

- ◆ Read all of these instructions. Save them for future reference.
- ◆ Follow all warnings and instructions marked on the device.
- ◆ Do not place the device on any unstable surface (cart, stand, table, etc.). If the device falls, serious damage will result.
- ◆ Do not use the device near water.
- ◆ Do not place the device near, or over, radiators or heat registers.
- ◆ The device cabinet is provided with slots and openings to allow for adequate ventilation. To ensure reliable operation, and to protect against overheating, these openings must never be blocked or covered.
- ◆ The device should never be placed on a soft surface (bed, sofa, rug, etc.) as this will block its ventilation openings. Likewise, the device should not be placed in a built in enclosure unless adequate ventilation has been provided.
- ◆ Never spill liquid of any kind on the device.
- ◆ Unplug the device from the wall outlet before cleaning. Do not use liquid or aerosol cleaners. Use a damp cloth for cleaning.
- ◆ The device should be operated from the type of power source indicated on the marking label. If you are not sure of the type of power available, consult your dealer or local power company.
- ◆ To prevent damage to your installation it is important that all devices are properly grounded.
- ◆ The device is designed for IT power distribution systems with 230V phase-to-phase voltage.
- ◆ The device is equipped with a 3-wire grounding type plug. This is a safety feature. If you are unable to insert the plug into the outlet, contact your electrician to replace your obsolete outlet. Do not attempt to defeat the purpose of the grounding-type plug. Always follow your local/national wiring codes.
- ◆ Do not allow anything to rest on the power cord or cables. Route the power cord and cables so that they cannot be stepped on or tripped over.

- ◆ If an extension cord is used with this device make sure that the total of the ampere ratings of all products used on this cord does not exceed the extension cord ampere rating. Make sure that the total of all products plugged into the wall outlet does not exceed 15 amperes.
- ◆ To help protect your system from sudden, transient increases and decreases in electrical power, use a surge suppressor, line conditioner, or un-interruptible power supply (UPS).
- ◆ Position system cables and power cables carefully; Be sure that nothing rests on any cables.
- ◆ When connecting or disconnecting power to hot-pluggable power supplies, observe the following guidelines:
  - ◆ Install the power supply before connecting the power cable to the power supply.
  - ◆ Unplug the power cable before removing the power supply.
  - ◆ If the system has multiple sources of power, disconnect power from the system by unplugging all power cables from the power supplies.
- ◆ Never push objects of any kind into or through cabinet slots. They may touch dangerous voltage points or short out parts resulting in a risk of fire or electrical shock.
- ◆ Do not attempt to service the device yourself. Refer all servicing to qualified service personnel.
- ◆ If the following conditions occur, unplug the device from the wall outlet and bring it to qualified service personnel for repair.
  - ◆ The power cord or plug has become damaged or frayed.
  - ◆ Liquid has been spilled into the device.
  - ◆ The device has been exposed to rain or water.
  - ◆ The device has been dropped, or the cabinet has been damaged.
  - ◆ The device exhibits a distinct change in performance, indicating a need for service.
  - ◆ The device does not operate normally when the operating instructions are followed.
- ◆ Only adjust those controls that are covered in the operating instructions. Improper adjustment of other controls may result in damage that will require extensive work by a qualified technician to repair.
- ◆ Do not connect the RJ-11 connector marked “UPGRADE” to a public telecommunication network.

---

## **Rack Mounting**

- ◆ Before working on the rack, make sure that the stabilizers are secured to the rack, extended to the floor, and that the full weight of the rack rests on the floor. Install front and side stabilizers on a single rack or front stabilizers for joined multiple racks before working on the rack.
- ◆ Always load the rack from the bottom up, and load the heaviest item in the rack first.
- ◆ Make sure that the rack is level and stable before extending a device from the rack.
- ◆ Use caution when pressing the device rail release latches and sliding a device into or out of a rack; the slide rails can pinch your fingers.
- ◆ After a device is inserted into the rack, carefully extend the rail into a locking position, and then slide the device into the rack.
- ◆ Do not overload the AC supply branch circuit that provides power to the rack. The total rack load should not exceed 80 percent of the branch circuit rating.
- ◆ Make sure that all equipment used on the rack – including power strips and other electrical connectors – is properly grounded.
- ◆ Ensure that proper airflow is provided to devices in the rack.
- ◆ Ensure that the operating ambient temperature of the rack environment does not exceed the maximum ambient temperature specified for the equipment by the manufacturer
- ◆ Do not step on or stand on any device when servicing other devices in a rack.

## Technical Support

---

### International

- ◆ For online technical support – including troubleshooting, documentation, and software updates: **<http://support.aten.com>**
- ◆ For telephone support, see *Telephone Support*, page iii

### North America

Email Support		ATEN TECH	support@aten-usa.com
		ATEN NJ	sales@aten.com
Online Support	Technical Support	ATEN TECH	http://www.aten-usa.com/support
		ATEN NJ	http://support.aten.com
	Troubleshooting Documentation Software Updates	ATEN TECH	http://www.aten-usa.com
		ATEN NJ	http://www.aten.com
Telephone Support		ATEN TECH	1-888-999-ATEN
		ATEN NJ	1-732-356-1703

When you contact us, please have the following information ready beforehand:

- ◆ Product model number, serial number, and date of purchase.
- ◆ Your computer configuration, including operating system, revision level, expansion cards, and software.
- ◆ Any error messages displayed at the time the error occurred.
- ◆ The sequence of operations that led up to the error.
- ◆ Any other information you feel may be of help.

# Specifications

## KN2124v / KN4124v

Function		KN2124v	KN4124v
Computer Connections	Direct	24	
	Max	384 (via cascade)	
Port Selection		Pushbutton / GUI / Hotkey	
Connectors	Console Port	1 x SPHD-18 Female (Yellow)	
	KVM Port	24 x RJ-45 Female (Black)	
	Power	2 x 3-prong AC socket	
	LAN	2 x RJ-45 Female (Black)	
	PON	1 x RJ-45 Female (Black)	
	Modem	1 x RJ-45 Female (Black)	
	USB	3 x USB Type A Female (White)	
	Audio	2 x Audio Jack Female	
Switches	Reset	1 x Semi-recessed Pushbutton	
	Power	2 x Rocker Switch	
	Port Selection	2 x Pushbutton	
LEDs	On Line	24 (Green)	
	Selected	24 (Red)	
	Power	1 (Blue)	
	Link 10 / 100 / 1000 Mbps	2 (Red / Red + Green / Green)	
Emulation	Keyboard/Mouse	PS/2 / USB (PC, Mac, Sun) / Serial	
Video		1600x1200 @ 60Hz	
Scan Interval		1–255 Seconds	
I/P Rating		100–240V AC; 50–60 Hz; 1.0 A	
Power Consumption	Single Power	110V/36.4W 230V/37.2W	110V/43.7W 230V/44.6W
	Dual Power	110V/41.8W 230V/42.5W	110V/49.1W 230V/50W
Environment	Operating Temp.	0–50° C	
	Storage Temp.	-20–60° C	
	Humidity	0–80% RH Noncondensing	
Physical Properties	Housing	Metal	
	Weight	5.99 kg	6.04 kg
	Dimensions L x W x H	43.36 x 40.94 x 4.40 cm (19"1U)	

**KN2140v / KN4140v**

Function		KN2140v	KN4140v
Computer Connections	Direct	40	
	Max	640 (via cascade)	
Port Selection		Pushbutton / GUI / Hotkey	
Connectors	Console Port	1 x SPHD-18 Female (Yellow)	
	KVM Port	40 x RJ-45 Female (Black)	
	Power	2 x 3-prong AC socket	
	LAN	2 x RJ-45 Female (Black)	
	PON	1 x RJ-45 Female (Black)	
	Modem	1 x RJ-45 Female (Black)	
	USB	3 x USB Type A Female (White)	
	Audio	2 x Audio Jack Female	
Switches	Reset	1 x Semi-recessed Pushbutton	
	Power	2 x Rocker Switch	
	Port Selection	2 x Pushbutton	
LEDs	On Line	40 (Green)	
	Selected	40 (Red)	
	Power	1 (Blue)	
	Link 10 / 100 / 1000 Mbps	2 (Red / Red + Green / Green)	
Emulation	Keyboard/Mouse	PS/2 / USB (PC, Mac, Sun) / Serial	
Video		1600x1200 @ 60Hz	
Scan Interval		1–255 Seconds	
I/P Rating		100–240V AC; 50–60 Hz; 1.0 A	
Power Consumption	Single Power	110V/36.8W 230V/37.7W	110V/49W 230V/50W
	Dual Power	110V/42.2W 230V/43W	110V/54W 230V/56W
Environment	Operating Temp.	0–50° C	
	Storage Temp.	-20–60° C	
	Humidity	0–80% RH Noncondensing	
Physical Properties	Housing	Metal	
	Weight	6.08 kg	6.12 kg
	Dimensions L x W x H	43.36 x 40.94 x 4.40 cm (19"1U)	

**KN2116A / KN4116**

Function		KN2116A	KN4116	
Computer Connections	Direct	16		
	Max	256 (via cascade)		
Port Selection		Pushbutton / GUI / Hotkey		
Connectors	Console Port	Keyboard	1 x 6-pin Mini-DIN Female (Purple) 1 x USB Type A Female (White)	
		Video	1 x HDB-15 Female (Blue)	
		Mouse	1 x 6-pin Mini-DIN Female (Green) 1 x USB Type A Female (White)	
	KVM Port		16 x RJ-45 Female (Black)	
	Power		1 x 3-prong AC socket	
	LAN		2 x RJ-45 Female (Black)	
	PON		1 x RJ-45 Female (Black)	
	Modem		1 x RJ-45 Female (Black)	
	USB		3 x USB Type A Female (White)	
	Switches	Reset	1 x Semi-recessed Pushbutton	
Power		1 x Rocker Switch		
Port Selection		2 x Pushbutton		
LEDs	On Line	16 (Green)		
	Selected	16 (Red)		
	Power	1 (Blue)		
	Link 10 / 100 / 1000 Mbps	2 (Red / Red + Green / Green)		
Emulation	Keyboard/Mouse	PS/2 / USB (PC, Mac, Sun) / Serial		
Video		1600x1200 @ 60Hz		
Scan Interval		1–255 Seconds		
I/P Rating		100–240V AC; 50–60 Hz; 1.0 A		
Power Consumption		110V / 33W 230V / 33.8W	110V / 39.60W 230V / 40.00W	
Environment	Operating Temp.	0–50°C		
	Storage Temp.	-20–60°C		
	Humidity	0–80% RH, Noncondensing		
Physical Properties	Housing	Metal		
	Weight	5.46 kg	5.52 kg	
	Dimensions L x W x H	43.36 x 41.35 x 4.40 cm (19" 1U)		

**KN2132 / KN4132**

Function		KN2132	KN4132	
Computer Connections	Direct	32		
	Max	512		
Port Selection		Pushbutton / GUI / Hotkey		
Connectors	Console Port	Keyboard	1 x 6-pin Mini-DIN Female (Purple) 1 x USB Type A Female (White)	
		Video	1 x HDB-15 Female (Blue)	
		Mouse	1 x 6-pin Mini-DIN Female (Green) 1 x USB Type A Female (White)	
	KVM Port		32 x RJ-45 Female (Black)	
	Power		1 x 3-prong AC socket	
	LAN		2 x RJ-45 Female (Black)	
	PON		1 x RJ-45 Female (Black)	
	Modem		1 x RJ-45 Female (Black)	
	USB		3 x USB Type A Female (White)	
Switches	Reset		1 x Semi-recessed Pushbutton	
	Power		1 x Slide	
	Port Selection		2 x Pushbutton	
LEDs	On Line		32 (Green)	
	Selected		32 (Red)	
	Power		1 (Blue)	
	Link 10 / 100 / 1000 Mbps		2 (Red / Red + Green / Green)	
Emulation	Keyboard/Mouse		PS/2 / USB (PC, Mac, Sun) / Serial	
Video		1600x1200 @ 60Hz		
Scan Interval		1–255 secs		
I/P Rating		100–240VAC; 50–60Hz; 1.0A		
Power Consumption		110V / 33.40W 230V / 34.20W	110V / 45.80W 230V / 46.30W	
Environment	Operating Temp.		0–50° C	
	Storage Temp.		-20–60° C	
	Humidity		0–80% RH	
Physical Properties	Housing		Metal	
	Weight		5.59 kg	5.63 kg
	Dimensions L x W x H		43.36 x 41.35 x 4.40 cm (19" 1U)	



# Troubleshooting

## General Operation

Problem	Resolution
I am confused about which equipment the terms <i>Local</i> and <i>Remote</i> refer to.	See <i>Terminology</i> , page xv, for details.
Erratic Operation	<p>The switch needs to be started before any cascaded switches.</p> <ol style="list-style-type: none"> <li>1. Make sure to power it on before powering on the switch.</li> <li>2. If the cascaded switch was started before the switch, reset or restart the cascaded switch.</li> </ol> <p>Press and release the <i>Reset</i> switch (see <i>Reset Switch</i>, page 11).</p>
I have been given an account but I am unable to log in.	<ol style="list-style-type: none"> <li>1. Make sure that you have correctly specified your Username and Password.</li> <li>2. Make sure that the administrator has given you the necessary permission to access the switch.</li> <li>3. Ask your administrator to see if the switch is under CC management. If it is, he will have to resolve the situation either by disabling CC management on the switch (see page 128), or by deselecting it on the CC server (see the CC User Manual for details).</li> </ol>
I can't access the switch, even though I have specified the IP address and port number correctly.	If the switch is behind a router, the router's <i>Port Forwarding</i> (also referred to as <i>Virtual Server</i> ) feature must be configured. See <i>Port Forwarding</i> , page 210, for details.
When logging in from a browser, the following message appears: <i>404 Object Not Found</i> .	If a login string has been set, make sure to include the forward slash and correct login string when you specify the switch IP address. (See <i>Login String</i> , page 136.)
Sudden loss of network connection.	Close your switch connection. Wait approximately 30 seconds, and log in again.
No remote server video display on the client computer.	<p>Check that your KVM Adapter Cable's firmware version is the same as the version stored in the switch's Main firmware. See <i>Adapter Firmware Upgrade</i>, page 149, for details.</p> <p>Set the remote server resolution to 1280 x 1024 or less.</p>

Problem	Resolution
No remote server video display on the client computer, but mouse movements appear on the local console and mouse clicks have no effect	Press and release the left Alt key, then press and release the right Alt key
The display on the client computer is distorted and performing an Autosync doesn't resolve the problem.	Switch ports to a port with a different resolution, then switch back. If the above didn't resolve the problem, change the resolution and refresh rate for the system running on the port. Afterward, you can either run at the new resolution, or switch back to the original resolution.
The Lock Key LEDs on the Control Panel don't accurately reflect the actual locked status of my keyboard input.	When you first connect, the LED display may not accurately reflect the LEDs on your keyboard. To resolve the problem, click the LEDs on the Control Panel until they match your keyboard. Afterward, when you change them from the keyboard they will change on the Control Panel.
When I log in, the browser generates a <i>CA Root certificate is not trusted</i> , or a <i>Certificate Error</i> response.	The certificate's name is not found on Microsoft's list of Trusted Authorities. The certificate can be trusted. See <i>Trusted Certificates</i> , page 219, for details.
In multiuser operation I had exclusive (or occupy) rights on the port I was viewing. After I recalled the Port Access page and then came back to the port I was occupying, it had been taken over by another user. Why did this happen?	If you try to return to the port by selecting again in the tree, the switch acts as if you are accessing the port for the first time. If another user was waiting on the port, he takes precedence and gets the port. The correct way to return to the port is to click the <i>Close</i> icon at the top right of the Port Access page.
I can't access my PN9108 when I run the PON AP.	Since the PN9108 already has over IP functionality, there is no need for the KN2124v / KN2140v / KN4124v / KN4140v / KN2132 / KN4116 / KN4132 to provide it. Therefore, only PON devices that don't have their own over IP functionality (such as the PN0108) are supported.

## Mouse Problems

Problem	Resolution
Mouse and/or Keyboard not responding.	<p>Check that your KVM Adapter Cable's firmware version is the same as the version stored in the switch's Main firmware. See <i>Adapter Firmware Upgrade</i>, page 149, for details.</p> <p>Unplug the cable(s) from the console port(s), then plug it/them back in.</p>
Mouse movement extremely slow	There is too much data being transferred for your connection to keep up with. Lower the video quality (see <i>Video Settings</i> , page 64) so that less video data is transmitted.
There are two mouse pointers after the remote server is accessed.	You can select another pointer type. See <i>Mouse Pointer Type</i> , page 75, for details.
When the mouse pointer is in Single Pointer mode, I can't access the Control Panel.	Recall the Control Panel and immediately change the pointer to Dual mode.
Why is there a Dual Pointer mode?	When you are not in Mouse DynaSync Mode, you need the two pointers so that you know the remote server pointer is actually at the location you think it is at. Otherwise, you might perform a mouse operation and because of net lag the remote server pointer may not be at the location that your client computer pointer is at.
Mouse pointer confusion	If you find the display of two mouse pointers (local and remote) to be confusing or annoying, you can use the <i>Toggle Mouse Display</i> function to shrink the non-functioning pointer. See <i>Toggle mouse display</i> , page 56, and <i>Mouse Pointer Type</i> , page 75.
When I log in with my Windows system, the local and remote mouse pointers do not sync.	<ol style="list-style-type: none"> <li>1. Check the status of the <i>Mouse Sync Mode</i> setting (see <i>Mouse DynaSync Mode</i>, page 76). If it is set to <i>Automatic</i>, change the setting to <i>Manual</i> and refer to the information for <i>Manual Mouse Synchronization</i> on page 77.</li> <li>2. If you are in Manual mode, use the <i>AutoSync</i> feature (see <i>Video Settings</i>, page 64), to sync the local and remote monitors.</li> <li>3. If that doesn't resolve the problem, use the <i>Adjust Mouse</i> feature (see <i>Adjust mouse</i>, page 56) to bring the pointers back in step.</li> <li>4. If the above fails to resolve the problem, refer to <i>Additional Mouse Synchronization Procedures</i>, page 216, for further steps to take.</li> </ol>

Problem	Resolution
When I log in with my Mac system, the local and remote mouse pointers do not sync.	There are two automatic Mouse DynaSync settings: the default, and Mac2. If mouse synchronization is not satisfactory with the default, try the Mac 2 setting. See the Note on page 77 for details.
When I log in with my Sun system, the local and remote mouse pointers do not sync	Automatic Mouse DynaSync sync only supports USB mice on Windows and Mac (G4 or higher) systems. You must sync the pointers manually. See <i>Mouse DynaSync Mode</i> , page 76, and <i>Manual Mouse Synchronization</i> , page 77, for further details.  After doing the above, refer to <i>Sun / Linux</i> , page 217, under <i>Additional Mouse Synchronization Procedures</i> for further steps to take.
When I log in with my Linux system, the local and remote mouse pointers do not sync.	Automatic Mouse DynaSync sync only supports USB mice on Windows and Mac (G4 or higher) systems. You must sync the pointers manually. See <i>Mouse DynaSync Mode</i> , page 76, <i>Manual Mouse Synchronization</i> , page 77, and <i>Mac and Linux Considerations</i> , page 77, for further details.  After doing the above, refer to <i>Sun / Linux</i> , page 217, under <i>Additional Mouse Synchronization Procedures</i> for further steps to take.

## Virtual Media

Problem	Resolution
Virtual Media doesn't work.	The remote server's mainboard does not support USB. If there is a newer firmware and BIOS version for the remote server's mainboard – one that supports USB – get it from the manufacturer and upgrade the server's mainboard firmware and BIOS.
There is no Virtual Media icon on my Control Panel.	<ol style="list-style-type: none"> <li>1. Virtual Media only supports the KA7175 and KA7176 KVM Adapter Cables.</li> <li>2. You must be have Administrator privileges on your client computer. (This is a Windows limitation.)</li> </ol>
I can't boot my remote server from my Virtual Media drive.	Your remote server's BIOS doesn't support booting from a USB drive. Get the latest firmware and BIOS version for your mainboard from the manufacturer and upgrade your mainboard BIOS.
If I connect a USB floppy drive to a remote server, it can boot the remote server. But, if I map it to the remote server as a Virtual Media drive, it cannot boot the remote server.	USB floppy drives have two types of format: UFI and CBI. Both can be used for OS level virtual media functions, but currently only UFI is supported for BIOS level (such as boot) functions.
I cannot mount Folder as a Virtual Media device.	If the actual Folder is formatted with the FAT16 file system, it cannot be mounted if its size exceeds 2GB.

## Web Browser

Problem	Resolution
After upgrading the firmware, after logging in with my web browser, the switch appears to still be using the old firmware version.	<p>The switch is using the new firmware version but the browser is displaying a page that is stored in its cache. Simply log out and clear your browser's cache.</p> <ul style="list-style-type: none"> <li>◆ <b>IE:</b> Tools → Internet Options → Temporary Internet Files → Delete Files</li> <li>◆ <b>Firefox:</b> Tools → Clear Private Data</li> </ul>
Firefox only opens the Java Applet Viewer. It doesn't open the WinClient ActiveX Viewer.	The WinClient ActiveX Viewer requires ActiveX. Since Firefox doesn't support ActiveX only the Java Applet Viewer is available.

## The WinClient ActiveX Viewer and the WinClient AP

Problem	Resolution
My switch units don't show up in the <i>Server List</i> window when I start the WinClient AP program.	Only units whose Access Port settings for <i>Program</i> (see page 124) match the number specified for <i>Port</i> in the Server area of this dialog box appear in the Server List window. Make sure that your entry for Port matches the entry you have specified for Program on the Device Management <i>Network</i> page.
The WinClient ActiveX Viewer and the WinClient AP won't connect to the switch.	DirectX 8.0 or higher must be installed on your client computer.
After upgrading the firmware, the WinClient ActiveX Viewer or WinClient AP do not run.	<p>The old version of your .ocx file was not deleted. You must delete the old file. There are two methods to delete the file.</p> <ol style="list-style-type: none"> <li>1. For the ActiveX Viewer: Open IE → Tools → Manage Add-ons. Delete or disable all occurrences of WinClient.</li> <li>2. For the WinClient AP: Open Explorer and search for WinClient.ocx. Delete all occurrences.</li> </ol>
Part of the remote window is off my monitor.	<ol style="list-style-type: none"> <li>1. Perform an Auto Sync (see <i>WinClient Control Panel Functions</i>, page 53, for details).</li> <li>2. If <i>Keep Screen Size</i> is not enabled (see <i>Screen Options</i>, page 79), use the <i>AutoSync</i> feature (see <i>Video Settings</i>, page 64), to sync the local and remote monitors.</li> <li>3. If <i>Keep Screen Size</i> is enabled, you can scroll to the areas that are off screen.</li> </ol>
The remote screen is rotated 90 degrees.	Enable <i>Keep Screen Size</i> (see <i>Control Panel Configuration</i> , page 78).
I cannot run <i>Net Meeting</i> when the WinClient is running.	Enable <i>Keep Screen Size</i> (see <i>Control Panel Configuration</i> , page 78).
After logging in I can't open the WinClient ActiveX viewer.	<ol style="list-style-type: none"> <li>1. You don't have the authority to install the <i>WinClient Control</i> add-on on your client computer. Have the person with administrator privileges on your client computer run the program the first time to get it installed. It will open for you after that.</li> <li>2. Under Vista, you must also add the switch's URL address to the list of trusted sites: Tools → Internet Options → Security → Trusted Sites → Sites.</li> </ol>

Problem	Resolution
Under Vista, after I open the WinClient ActiveX viewer and try to mount a driver or removable disk, I get a "Driver not ready" message.	<p>This is a result of Vista's UAC (User Account Control). There are two methods to resolve this problem:</p> <ol style="list-style-type: none"> <li>1. If you are your client computer's administrator, open your browser by right clicking its icon and choosing <b>Run as...</b> then choose to run the browser with the administrator account.</li> <li>2. If you are not your client computer's administrator, you must ask your client computer's administrator to disable UAC.</li> </ol>

## The Java Applet and Java Client AP

Problem	Resolution
I can't connect to the switch.	<ol style="list-style-type: none"> <li>1. The latest Java version must be installed on your client computer.</li> <li>2. Check if you need to specify the Program port along with the IP address. See <i>Java Client AP Login</i>, page 42, for details.</li> <li>3. Close Java reopen it, and try again.</li> </ol>
I have installed the latest Java JRE, but I am having performance and stability problems.	There may be issues with the latest version because it is so new. Try using a Java version that is one or two versions earlier than the latest one.
After upgrading the firmware, after logging in with the Java Applet Viewer or the Java Client AP, the switch appears to still be using the old firmware version.	<p>Log out. Delete your Java temporary internet files as follows:</p> <ol style="list-style-type: none"> <li>1. Open Control Panel → Java.</li> <li>2. In the <i>Temporary Internet Files</i> section, click <b>Settings</b>.</li> <li>3. In the <i>Disk Space</i> section, click <b>Delete Files</b>.</li> <li>4. In the dialog box that comes up, click <b>OK</b>.</li> </ol>
The national language characters that I input do not appear.	<p>Change the keyboard language of your client computer to English-UK.</p> <p>Use the switch <i>On-Screen Keyboard</i> and set the on-screen keyboard to the same language that the other system is using. (See <i>The On-Screen Keyboard</i>, page 74.)</p>
Java performance deteriorates.	Exit the program and start again.
Pressing the Windows Menu key has no effect.	Java doesn't support the Windows Menu key.
When I try to <b>Add</b> a folder to be mounted as a virtual media drive, I can't select the folder. My only choice is <i>Desktop</i> .	In the folder selection entry field, enter the root directory of the folder you want to add. After that, the folders contained under the root directory will display. You can now navigate to the folder you want to select.

## Sun Systems

Problem	Resolution
Video display problems with HDB15 interface systems (e.g. Sun Blade 1000 servers).*	<p>The display resolution should be set to 1024 x 768 @ 60Hz:</p> <p><b>Under Text Mode:</b></p> <p>Go to OK mode and issue the following commands:</p> <pre>setenv output-device screen:r1024x768x60 reset-all</pre> <p><b>Under XWindow:</b></p> <ol style="list-style-type: none"> <li>1. Open a console and issue the following command: <pre>m64config -res 1024x768x60</pre> </li> <li>2. Log out</li> <li>3. Log in</li> </ol>
Video display problems with 13W3 interface systems (e.g. Sun Ultra servers).*	<p>The display resolution should be set to 1024 x 768 @ 60Hz:</p> <p><b>Under Text Mode:</b></p> <p>Go to OK mode and issue the following commands:</p> <pre>setenv output-device screen:r1024x768x60 reset-all</pre> <p><b>Under XWindow:</b></p> <ol style="list-style-type: none"> <li>1. Open a console and issue the following command: <pre>fbconfig -res 1024x768x60</pre> </li> <li>2. Log out</li> <li>3. Log in</li> </ol>
I have a KA9131 USB adapter. Will it work with the switch?	Yes. Although we recommend the KA9170 for new purchases, if you already have a KA9131 you can use it instead of the KA9170.

\* These solutions work for most common Sun VGA cards. If using them fails to resolve the problem, consult the Sun VGA card's manual.

## Mac Systems

Problem	Resolution
When I log in to the switch with my Safari browser, it hangs when I use the Snapshot feature.	<p>Force close Safari, then reopen it. Don't use the Snapshot feature in the future.</p> <p>To use the Snapshot feature with Safari, upgrade to Mac OS 10.4.11 and Safari 3.0.4.</p>



## Redhat Systems

Problem	Resolution
With Redhat 9.0 (2.4.20-8) installed as a server, the keyboard and mouse aren't working normally with the KA7175/KA7176 console modules.	Choose the AS3.0 setting for your mouse synchronization mode. See <i>Mac and Linux Considerations</i> , page 77, for details.
With Redhat 9.0 (2.4.20-8) installed as a desktop system, the keyboard and mouse aren't working normally with the KA7175/KA7176 console modules.	First, plug your keyboard and mouse into a USB 2.0 hub, then plug the hub into the Redhat 9.0 server.

## The Log Server

Problem	Resolution
The Log Server program does not run.	<p>The Log Server requires the Microsoft Jet OLEDB 4.0 driver in order to access the database.</p> <p>This driver is automatically installed with Windows ME, 2000 and XP.</p> <p>For Windows 98 or NT, you will have to go to the Microsoft download site:  <a href="http://www.microsoft.com">http://www.microsoft.com</a>  and do a search for <i>MDAC</i> to retrieve the driver file:</p> <p style="text-align: center;">MDAC 2.7 RTM Refresh (2.70.9001.0)</p> <p>Since this driver is used in Windows Office Suite, an alternate method of obtaining it is to install Windows Office Suite. Once the driver file or Suite has been installed, the Log Server will run.</p>

## Panel -Array Mode

Problem	Resolution
Low resolution video – the screens don't display clearly.	This sometimes occurs due to the screens being scaled to fit in the panels. Decrease the number of panels that are displayed.
When multiple remote users are logged in, some of them only receive a partial image.	The first user to invoke Panel Array Mode should set it to display at least four panels.
When I try to move forward or backward one port, the display sometimes moves forward two ports or remains on the original port.	<p>This occurs occasionally due to a net lag problem. The array automatically moves through the ports at a pre-selected time. By the time it gets your input it has already moved forward a port on its own - but that hasn't shown up on your display as yet.</p> <p>So, when it moves ahead or back due to your input it appears to have moved two ports (from its own movement plus your "forward one port" command), or remains on the original port (from its own forward movement plus your "back one port" command).</p>

**Q1:** When I open a viewer, the web page does not display or work correctly, and I receive an error message that is similar one of the following:

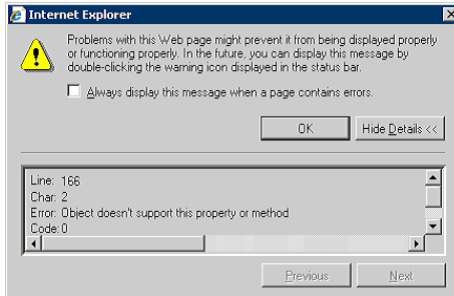

1. Reset the Internet Explorer security settings to enable Active Scripting, ActiveX controls, and Java applets

By default, Internet Explorer 6 and some versions of Internet Explorer 5.x use the High security level for the Restricted sites zone and Microsoft Windows Server 2003 uses the High security level for both the Restricted sites zone and the Internet zone. You may want to enable Active Scripting, ActiveX controls, and Java applets. To enable Active Scripting, ActiveX controls, and Java applets, follow these steps:

- a) Start Internet Explorer.
  - b) On the Tools menu, click Internet Options.
  - c) In the Internet Options dialog box, click Security.
  - d) Click Default Level.
  - e) Click OK.
2. Verify that Active Scripting, ActiveX, and Java are not blocked  
If some client computers work but others do not, verify that Internet Explorer or another program on your client computer such as an anti-virus program or a firewall are not configured to block scripts, ActiveX controls, or Java applets.
  3. Verify that your anti-virus program is not set to scan the Temporary Internet Files or Downloaded Program Files folders

- 
4. Delete all the temporary Internet-related files  
To remove all the temporary Internet-related files from your client computer, follow these steps:
    - a) Start Internet Explorer.
    - b) On the Tools menu, click Internet Options.
    - c) Click the General tab.
    - d) Under Temporary Internet files, click Settings.
    - e) Click Delete Files.
    - f) Click OK.
    - g) Click Delete Cookies.
    - h) Click OK.
    - i) Under History, click Clear History, and then click Yes.
    - j) Click OK.
  5. Make sure that you have the latest version of Microsoft DirectX installed  
For information about how to install the latest version of Microsoft DirectX, visit the following Microsoft Web site:  
<http://www.microsoft.com/windows/directx/default.aspx?url=/windows/directx/downloads/default.htm>
  6. Make sure that you have the latest version of the Java JRE installed.  
For information about how to install the latest version of the JRE visit the Java Web site: [www.java.com](http://www.java.com)

## IP Address Determination

If you are an administrator logging in for the first time, you need to access the switch in order to give it an IP address that users can connect to. There are three methods to choose from. In each case, your client computer must be on the same network segment as the switch. After you have connected and logged in you can give the switch its fixed network address. (See *Network*, page 124.)

### The Local Console

The easiest way to assign an IP address is from the local console. Refer to *First Time Setup*, page 31, for details on the procedure involved.

### IP Installer

For client computers running Windows, an IP address can be assigned with the *IP Installer* utility. The utility can be obtained from the *Download* area of our web site. Look under *Driver/SW*, and the model of your switch. After downloading the utility to your client computer, do the following:

1. Unzip the contents of *IPInstaller.zip* to a directory on your hard drive.
2. Go to the directory that you unzipped the IPInstaller program to and run *IPInstaller.exe*. A dialog box similar to the one below appears:

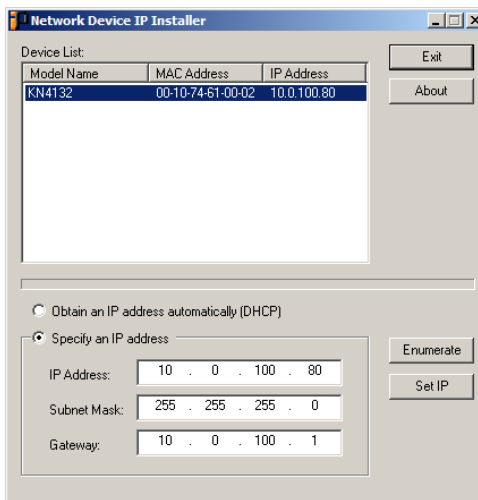

- 
3. Select the switch in the *Device List*.

---

**Note:** 1. If the list is empty, or your device doesn't appear, click **Enumerate** to refresh the Device List.

2. If there is more than one device in the list, use the MAC address to pick the one you want. The switch MAC address is located on its bottom panel.
- 

4. Select either *Obtain an IP address automatically (DHCP)*, or *Specify an IP address*. If you chose the latter, fill the IP Address, Subnet Mask, and Gateway fields with the information appropriate to your network.
5. Click **Set IP**.
6. After the IP address shows up in the Device List, click **Exit**. See *IP Installer*, page 129 for more information.

## **Browser**

1. Set your client computer's IP address to 192.168.0.XXX  
Where XXX represents any number or numbers except 60. (192.168.0.60 is the default address of the switch.)
2. Specify the switch's default IP address (192.168.0.60) in your browser, and you will be able to connect.
3. Assign a fixed IP address for the switch that is suitable for the network segment that it resides on.
4. After you log out, reset your client computer's IP address to its original value.

## Port Forwarding

---















For devices located behind a router, port forwarding allows the router to pass data coming in over a specific port to a specific device. By setting the port forwarding parameters, you tell the router which device to send the data coming in over a particular port to.

For example, if the switch connected to a particular router has an IP address of 192.168.1.180, you would log into your router's setup program and access the Port Forwarding (sometimes referred to as *Virtual Server*) configuration page. You would then specify 192.168.1.180 for the IP address and the port number you want opened for it (9000 for internet access, for example).

Since configuration setup can vary somewhat for each brand of router, refer to the router's User Manual for specific information on configuring port forwarding for it.

## Keyboard Emulation

The PC compatible (101/104 key) keyboard can emulate the functions of the Sun and Mac keyboards. The emulation mappings are listed in the table below.

PC Keyboard	Sun Keyboard	PC Keyboard	Mac Keyboard
[Ctrl] [T]	Stop	[Shift]	Shift
[Ctrl] [F2]	Again	[Ctrl]	Ctrl
[Ctrl] [F3]	Props		
[Ctrl] [F4]	Undo	[Ctrl] [1]	
[Ctrl] [F5]	Front	[Ctrl] [2]	
[Ctrl] [F6]	Copy	[Ctrl] [3]	
[Ctrl] [F7]	Open	[Ctrl] [4]	
[Ctrl] [F8]	Paste	[Alt]	Alt
[Ctrl] [F9]	Find	[Print Screen]	F13
[Ctrl] [F10]	Cut	[Scroll Lock]	F14
[Ctrl] [1]			=
[Ctrl] [2]		[Enter]	Return
[Ctrl] [3]		[Backspace]	Delete
[Ctrl] [4]		[Insert]	Help
[Ctrl] [H]	Help	[Ctrl] 	F15
	Compose		
			

**Note:** When using key combinations, press and release the first key (Ctrl), then press and release the activation key.

## PPP Modem Operation

### Basic Setup

In addition to the browser and AP methods, the switch can also be accessed through its RS-232 port using a PPP dial-in connection, as follows:

1. Set up your hardware configuration to match the diagram, below:

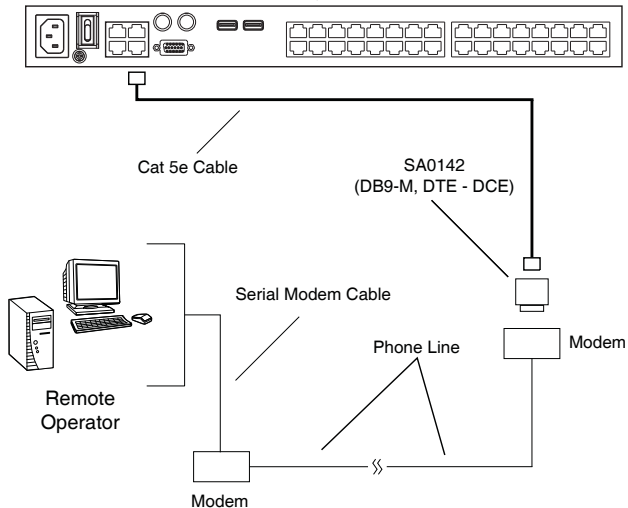

2. From your client computer, use your modem dial-in program to dial into the switch modem.

---

**Note:** 1. If you don't know the switch modem's serial parameters, get them from the switch administrator.

2. An example of setting up a modem dial-in program under Windows XP is provided on the next page.

3. Once the connection is established, open your browser, and specify **192.168.192.1** in the URL box.

---

**Note:** The default username and password are blank.

---

From here, operation is the same as if you had logged in from a browser or with the AP programs.



---

## **Connection Setup Example (Windows XP)**

To set up a dial-in connection to the switch under Windows XP, do the following:

1. From the *Start* menu, select Control Panel → Network Connections → Create a New Connection.
2. When the *Welcome to the New Connection Wizard* dialog box appears, click **Next** to move on.
3. In the *Network Connection Type* dialog box, select *Connect to the network at my workplace*, then click **Next**.
4. In the *Network Connection* dialog box, select *Dial-up connection*, then click **Next**.
5. In the *Connection Name* dialog box, key in a name for the connection (for example, TPE-KN4132-01), then click **Next**.
6. In the *Connection Availability* dialog box, you can select either *Anyone's use* or *My use only*, depending on your preferences, then click **Next**.

---

**Note:** If you are the only user on this client computer, this dialog box won't appear.

---

7. In the *Phone Number to dial* dialog box, key in the phone number of the modem connected to the switch (be sure to include country and area codes, if necessary), then click **Next**.
8. In the *Completing the New Connection Wizard* dialog box, check **Add a shortcut to this connection on my desktop**, then click **Finish**.

This completes the connection setup. Double click the desktop shortcut icon to make a PPP connection to the switch.

## KA7140 Configuration and Operation

The KA7140 Adapter Cable connects a serial device to the switch.

### Configuration

To configure the KA7140 to interact with the connected device, you need to set its serial parameters to match the parameters of the device, as follows:

1. In the Port Access page Sidebar, select the port that the KA7140 is connected to.
2. Select **Access** on the menu bar.

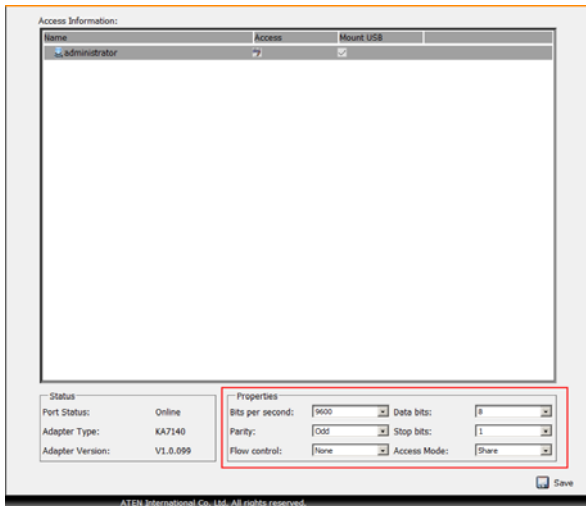

3. In the *Properties* section, drop down each of the lists to select the port property values that match the ones used by the connected serial console device. The port property settings that the KA7140 supports are given in the following table:

Setting	Meaning
Bits per second (Baud Rate)	This sets the port's data transfer speed. Choices are from 300—38400 (drop down the list to see them all). Set this to match the baud rate setting of the serial console device. Default is 9600 (which is a basic setting for many serial console devices).
Data Bits	This sets the number of bits used to transmit one character of data. Choices are: 7 and 8. Set this to match the data bit setting of the serial console device. Default is 8 (which is the default for the majority of serial console devices).

Setting	Meaning
Parity	This bit checks the integrity of the transmitted data. Choices are: None; Odd; Even. Set this to match the parity setting of the serial console device. Default is Odd.
Stop Bits	This indicates that a character has been transmitted. Set this to match the stop bit setting of the serial console device. Choices are: 1 and 2. Default is 1 (which is the default for the majority of serial console devices).
Flow Control	This allows you to choose how the data flow will be controlled. Choices are: None, Hardware, and XON/XOFF. Set this to match the flow control setting of the serial console device. Default is None. <b>Note:</b> <i>None</i> is only supported for baud rates of 9600 and lower. For baud rates greater than 9600, you must choose <i>Hardware</i> or <i>XON/XOFF</i> .
Access Mode	This allows you to set the serial console device's access mode. Choices are: Share, Occupy, and Exclusive. Default is Share. See <i>Access Mode</i> , page 87 for information regarding this function.

4. When you have finished making your selections, click **Save**.

## Operation

To operate the device connected to the port, in the Port Access page double click the port. After you switch to the port, issue the command that calls up the device.

## KA7140 Pin Assignments

Pin assignments for the KA7140 Adapter are given in the table, below:

Pin	Assignment
1	DCD
2	RXD
3	TXD
4	DTR
5	GND
6	DSR
7	RTS
8	CTS
9	N/A

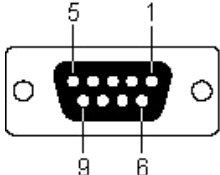

**DB9 Female**

## Additional Mouse Synchronization Procedures

If you use Manual Mouse Synchronization, you must perform the following operations on the servers that connect to the switch.

- Note:** 1. These procedures are to be performed on the servers attached to the switch's ports - not on the client computer you are using to access the switch.
2. In order for the local and remote mice to synchronize, you must use the generic mouse driver supplied with the Windows operating system. If you have a third party driver installed - such as one supplied by the mouse manufacturer - you must remove it.

### Windows:

1. Windows 2000:
  - a) Open the Mouse Properties dialog box (Control Panel → Mouse → Mouse Properties)
  - b) Click the *Motion* tab
  - c) Set the mouse speed to the middle position (6 units in from the left)
  - d) Set the mouse acceleration to *None*

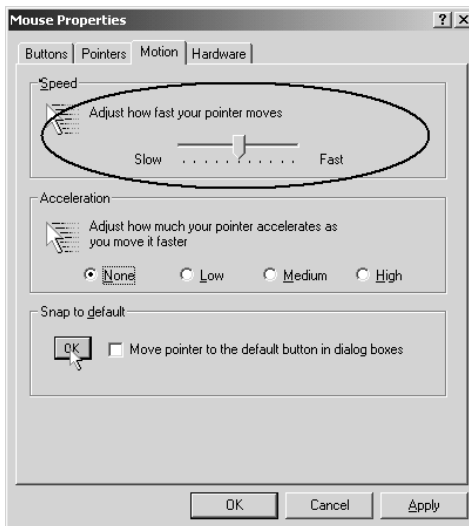

2. Windows XP / Windows Server 2003:
  - a) Open the Mouse Properties dialog box (Control Panel → Mouse)
  - b) Click the *Pointer Options* tab
  - c) Set the mouse speed to the middle position (6 units in from the left)
  - d) Disable *Enhance Pointer Precision*

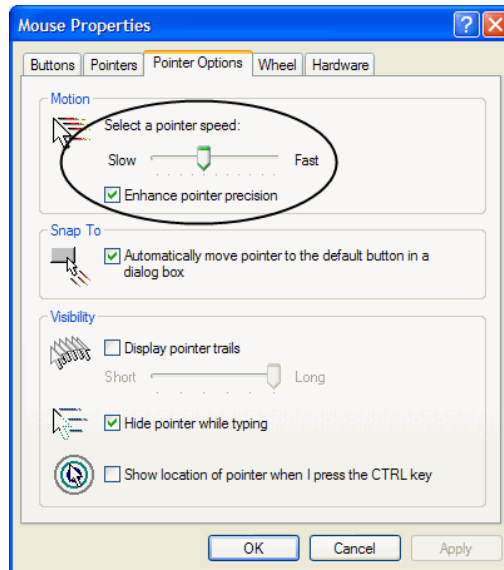

3. Windows ME:

Set the mouse speed to the middle position; disable mouse acceleration (click **Advanced** to get the dialog box for this).
4. Windows NT / Windows 98 / Windows 95:

Set the mouse speed to the slowest position.

## **Sun / Linux**

Open a terminal session and issue the following command:

```
Sun: xset m 1
```

```
Linux: xset m 0
```

or

```
xset m 1
```

(If one doesn't help, try the other.)

```
Linux using the Redhat AS3.0 mouse mode: xset m 1
```

## Additional Video Resolution Procedures

---

If you are running Windows, and wish to use the refresh rates indicated with an asterisk (\*) on page 8, do the following:

1. Open Control Panel → Display → Settings → Advanced → Monitor.
2. In the dialog box that comes up, make sure that the *Hide modes that this monitor cannot display* checkbox is unchecked.

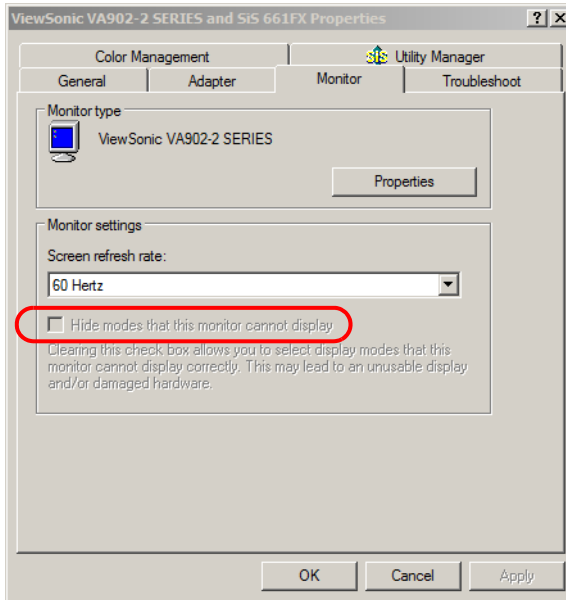

3. Click the arrow at the right of the *Screen refresh rate* listbox, and select the refresh rate you want from the list that appears.

---

**Note:** Make sure that your monitor supports the refresh rate you choose – if not, you may seriously damage your monitor.

---

---

## Trusted Certificates

---

### Overview

When you try to log in to the device from your browser, a Security Alert message appears to inform you that the device's certificate is not trusted, and asks if you want to proceed.



The certificate can be trusted, but the alert is triggered because the certificate's name is not found on Microsoft list of Trusted Authorities. You have two options: 1) you can ignore the warning and click **Yes** to go on; or 2) you can install the certificate and have it be recognized as trusted.

- ◆ If you are working on a client computer at another location, accept the certificate for just this session by clicking **Yes**.
- ◆ If you are working at your own client computer, install the certificate on your client computer (see below for details). After the certificate is installed, it will be recognized as trusted.

## Installing the Certificate

To install the certificate, do the following:

1. In the *Security Alert* dialog box, click **View Certificate**. The *Certificate Information* dialog box appears:

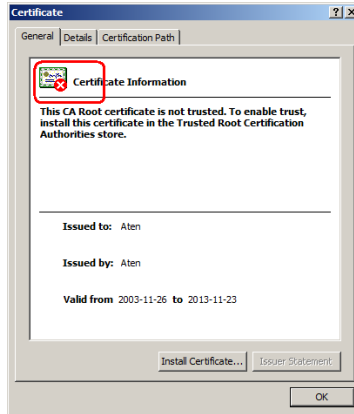

**Note:** There is a red and white X logo over the certificate to indicate that it is not trusted.

2. Click **Install Certificate**.
3. Follow the Installation Wizard to complete the installation. Unless you have a specific reason to choose otherwise, accept the default options.
4. When the Wizard presents a caution screen:

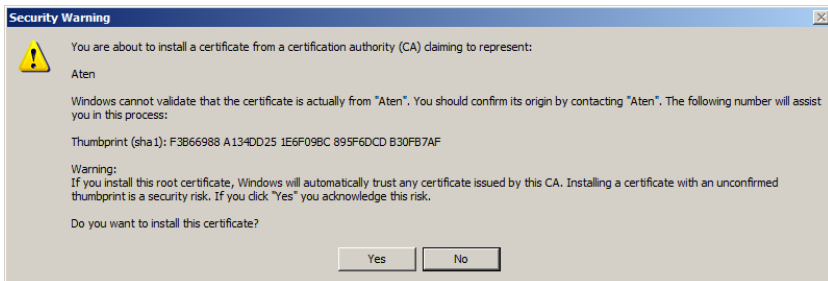

Click **Yes**.



- Next, click **Finish** to complete the installation; then click **OK** to close the dialog box.

## Certificate Trusted

The certificate is now trusted:



When you click *View Certificate*, you can see that the red and white **X** logo is no longer present – further indication that the certificate is trusted:

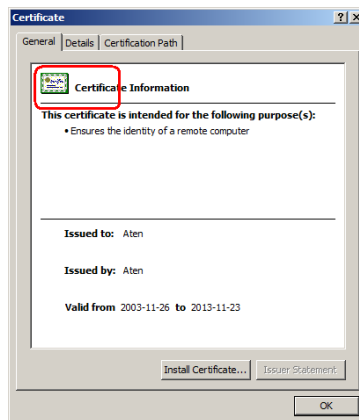

## Mismatch Considerations

If the site name or IP address used for generating the certificate no longer matches the current address of the switch a mismatch warning occurs:

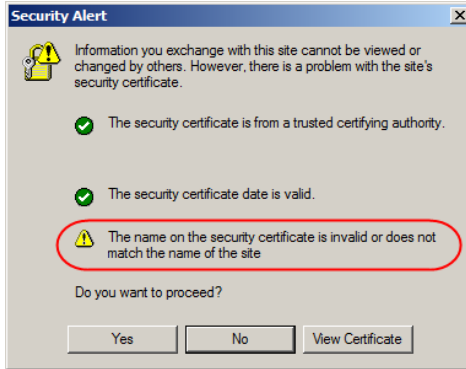

You can click **Yes** to go on, or you can disable mismatch checking.

To disable mismatch checking, do the following:

1. After the page you are logging in to comes up open the browser's Tools menu; Select *Internet Options* → *Advanced*.
2. Scroll to the bottom of the list and uncheck *Warn about trusted certificates*:

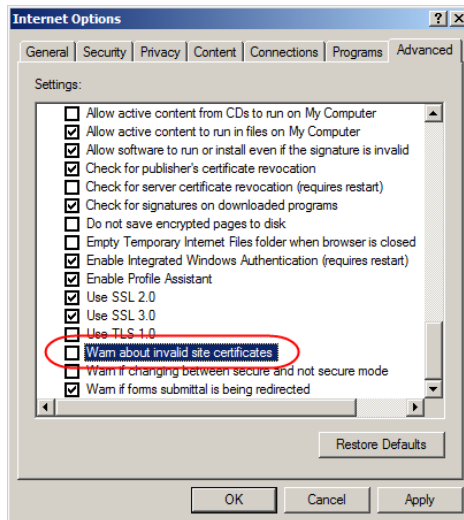

3. Click **OK**. The next time you run the browser the change will be in effect.

## Self-Signed Private Certificates

---

If you wish to create your own self-signed encryption key and certificate, a free utility – `openssl.exe` – is available for download over the web at [www.openssl.org](http://www.openssl.org). To create your private key and certificate do the following:

1. Go to the directory where you downloaded and extracted `openssl.exe` to.
2. Run `openssl.exe` with the following parameters:

```
openssl req -new -newkey rsa:1024 -days 3653 -nodes -x509
-keyout CA.key -out CA.cer -config openssl.cnf
```

---

**Note:** 1. The command should be entered all on one line (i.e., do not press [Enter] until all the parameters have been keyed in).

2. If there are spaces in the input, surround the entry in quotes (e.g., “ATEN International”).
- 

To avoid having to input information during key generation the following additional parameters can be used:

```
/C /ST /L /O /OU /CN /emailAddress.
```

### Examples

```
openssl req -new -newkey rsa:1024 -days 3653 -nodes -x509
-keyout CA.key -out CA.cer -config openssl.cnf -subj
/C=yourcountry/ST=yourstateorprovince/L=yourlocationor
city/O=yourorganization/OU=yourorganizationalunit/
CN=yourcommonname/emailAddress=name@yourcompany.com
```

```
openssl req -new -newkey rsa:1024 -days 3653 -nodes -x509
-keyout CA.key -out CA.cer -config openssl.cnf -subj
/C=CA/ST=BC/L=Richmond/O="ATEN International"/OU=ATEN
/CN=ATEN/emailAddress=eservice@aten.com.tw
```

### Importing the Files

After the `openssl.exe` program completes, two files – `CA.key` (the private key) and `CA.cer` (the self-signed SSL certificate) – are created in the directory that you ran the program from. These are the files that you upload in the *Private Certificate* panel of the Security page (see *Security*, page 134, and *Private Certificate*, page 137).

## Fan Location and Speed Information

---

### Fan Location

The switch has 6 fans that feed realtime fan speed information to the WinClient / Java Client Device Management page.

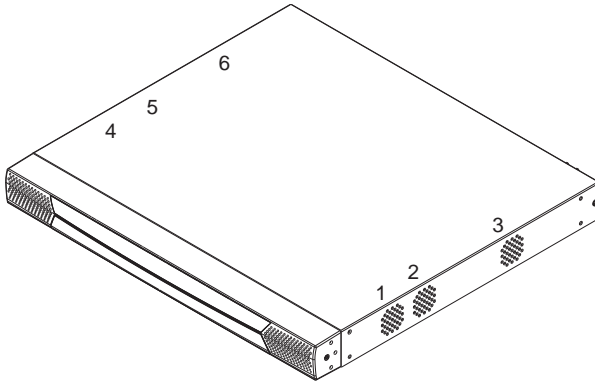

The fan locations in the above image are listed in the Device Information section under *Fan Speed*. See , page 144, for details.

### Fan Speed

The fan speed automatically adjusts according to temperature as follows:

- ◆ If any sensor senses that the temperature is greater than 32° C, all the fans are set to spin at half speed.
- ◆ If any sensor senses that the temperature is greater than 45° C, all the fans are set to spin at full speed.
- ◆ When all four sensors sense that the temperature is less than 40° C, all the fans return to half speed.
- ◆ When all four sensors sense that the temperature is less than 30° C, all the fans turn off.

---

## Temperature Sensor Location and Information

---

The switch has 4 temperature sensors on its mainboard that feed realtime temperature updates to the WinClient / Java Client Device Management page.

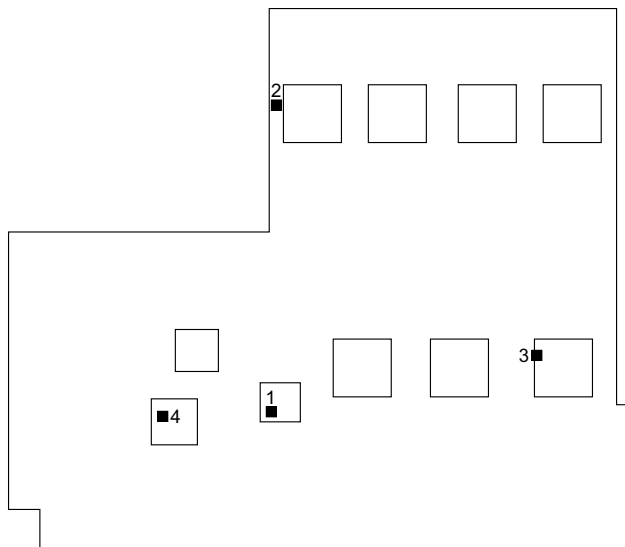

The sensors in the above image are described in the *Device Information* section under *Temperature*. See *Temperature*, page 123, for details.

---

**Note:** The temperature inside the case can be higher than the ambient (room) temperature (0–50° C). IC chips can tolerate temperatures of up to 105° C. If the temperature reading rises past 85° C or so, you should either make the ambient temperature cooler or, if necessary, shut the switch down until it cools off.

---

## Clear Login Information

---

If you are unable to perform an Administrator login (because the Username and Password information has become corrupted or you have forgotten it, for example) you can clear the login information with the following procedure.

---

**Note:** Performing this procedure also returns all settings to their defaults.

---

To clear the login information (and return all settings to their defaults), do the following:

1. Power off the switch and remove its housing.
2. Use a jumper cap to short the mainboard jumper labeled **J23**.

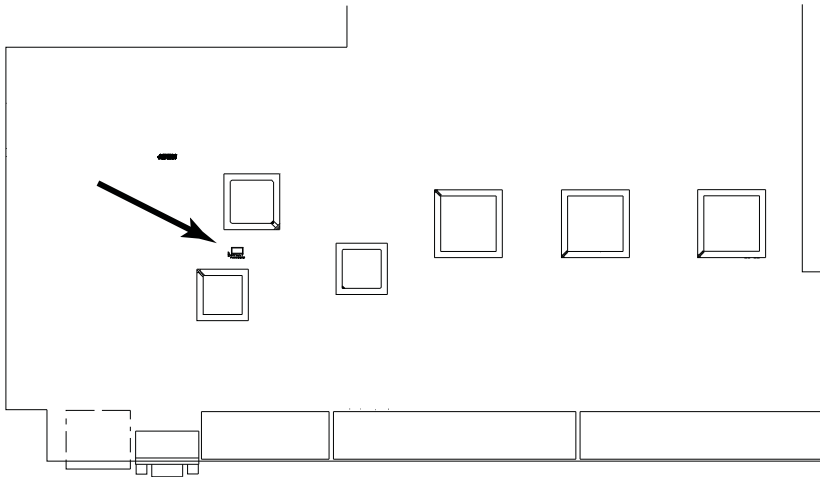

3. Power on the switch.
4. When the Link and 10/100Mbps LEDs flash, power off the switch.
5. Remove the jumper cap from J23.
6. Close the housing and start the switch.  
After powering on the unit, you can use the default Super Administrator Username and Password (see *First Time Setup*, page 31), to log in.

## Factory Default Settings









The default settings are as follows:

Setting	Default
Language	English
OSD Hotkey	[Scroll Lock] [Scroll Lock]
Port ID Display	Port Number + Name
Port ID Display Duration	3 Seconds
Scan/Skip Mode	All
Scan Duration	5 Seconds
Screen Blanker	0 Minutes (disabled)
Beeper	On
Viewer	Auto Detect
Welcome Message	Hide
Accessible Ports	<ul style="list-style-type: none"> <li>◆ Super Administrators – Full for all ports</li> <li>◆ All other users – None for all ports.</li> </ul>

## Serial Adapter Pin Assignments

**SA0142:** RJ45-F to DB9-M (Black Connector)

DTE to DCE

switch (RJ45)	Pins (8)	Modem/Device (DB9)
RTS	1 	7
DTR	2 	4
TXD	3 	3
CTS	4 	8
GND	5 	5
RXD	6 	2
DCD	7 	1
DSR	8 	6

9 NC not used

## Supported KVM Switches

---

The following is a list of fully supported KVM switches that can be used in a cascaded installation:

- ◆ KH88
- ◆ KH98
- ◆ KH1508
- ◆ KH1516
- ◆ CS9134
- ◆ CS9138

- 
- Note:** 1. Some of the KVM Over the NET™ switch's features may not be supported, depending on the functionality of the cascaded KVM switch. (For example, some switches do not support virtual media.)
2. The installation cannot be cascaded beyond the second level.
-



---

## Virtual Media Support

---

### **WinClient ActiveX Viewer / WinClient AP**

- ◆ IDE CDROM/DVD-ROM Drives – Read Only
- ◆ IDE Hard Drives – Read Only
- ◆ USB CDROM/DVD-ROM Drives – Read Only
- ◆ USB Hard Drives – Read/Write\*
- ◆ USB Flash Drives – Read/Write\*
- ◆ USB Floppy Drives – Read/Write

---

\* These drives can be mounted either as a Drive or as a Removable Disk (see *Virtual Media*, page 70). Removable disks allow the user to boot the remote server if the disk contains a bootable OS. In addition, if the disk contains more than one partition, the remote server can access all the partitions.

---

- ◆ ISO Files – Read Only
- ◆ Folders – Read/Write

### **Java Applet Viewer / Java Client AP**

- ◆ ISO Files – Read Only
- ◆ Folders – Read/Write

## Limited Warranty

---

ALTUSEN warrants this product against defects in material or workmanship for a period of one (1) year from the date of purchase. If this product proves to be defective, contact ALTUSEN's support department for repair or replacement of your unit. ALTUSEN will not issue a refund. Return requests can not be processed without the original proof of purchase.

When returning the product, you must ship the product in its original packaging or packaging that gives an equal degree of protection. Include your proof of purchase in the packaging and the RMA number clearly marked on the outside of the package.

This warranty becomes invalid if the factory-supplied serial number has been removed or altered on the product.

This warranty does not cover cosmetic damage or damage due to acts of God, accident, misuse, abuse, negligence or modification of any part of the product. This warranty does not cover damage due to improper operation or maintenance, connection to improper equipment, or attempted repair by anyone other than ALTUSEN. This warranty does not cover products sold AS IS or WITH FAULTS.

IN NO EVENT SHALL ALTUSEN'S LIABILITY EXCEED THE PRICE PAID FOR THE PRODUCT. FURTHER, ALTUSEN SHALL NOT BE RESPONSIBLE FOR DIRECT, INDIRECT, SPECIAL, INCIDENTAL OR CONSEQUENTIAL DAMAGES RESULTING FROM THE USE OF THE PRODUCT, ITS ACCOMPANYING SOFTWARE, OR ITS DOCUMENTATION. ALTUSEN SHALL NOT IN ANY WAY BE RESPONSIBLE FOR, WITHOUT LIMITATION, LOSS OF DATA, LOSS OF PROFITS, DOWNTIME, GOODWILL, DAMAGE OR REPLACEMENT OF EQUIPMENT OR PROPERTY, AND ANY EXPENSES FROM RECOVERY, PROGRAMMING, AND REPRODUCTION OF ANY PROGRAM OR DATA.

ALTUSEN makes no warranty or representation, expressed, implied, or statutory with respect to its products, contents or use of this documentation and all accompanying software, and specifically disclaims its quality, performance, merchantability, or fitness for any particular purpose.

ALTUSEN reserves the right to revise or update its product, software or documentation without obligation to notify any individual or entity of such revisions, or update.

For details about extended warranties, please contact one of our dedicated value added resellers.

## A

- Access, 101
- Access Ports, 125
- Adapter Attributes, 140
- Adapter cable
  - firmware upgrade recovery, 150
- Adapter Cables
  - upgrading, 149
- Adapter connection diagram, 25
- Adapter ID Function, 28
- Adding Users, 107
- Additional Video Resolution Procedures, 218
- Administration Page
  - Date/Time, 142
- ANMS, 128
- Array, 89
- Authentication
  - external, 128
- Auto Scanning, 158
  - Exiting, 159
  - Invoking, 158
  - Pausing, 159
  - Scan Interval, 158
- Auto scanning, 89

## B

- Backup/Restore, 151
- Beeps, 123

## C

- Cat5 cable length, 87
- CC Management, 132
- Clear Login Information, 226
- Clear Port Names, 140
- Components, 10

- Front View, 10
- Rear View, 12
- Control Panel, 48
  - Java Client AP, 80
  - WinClient, 51
- Creating Groups, 111
- Customization page, 138

## D

- Date/Time Settings, 142
  - Synchronize, 47
- Deleting groups, 113
- Deleting user accounts, 110
- Device Assignment, 118
- Device Management, 121
  - Customization, 138
  - General, 122
  - Network, 124
  - Security, 134
- Device Permissions
  - assigning, 118, 120
- DNS Server, 127
- DynaSync, 76

## E

- Event Panel, 172
- External authentication, 128

## F

- Factory Default Settings, 227
- Fan Location and Speed, 224
- Fan Warning Message, 123
- Favorites, 94
- Features
  - V-Series exclusive, 6
- Filter, 90, 99

## Filtering

- IP, 135
- MAC, 135

## Firmware

- upgrading, 145, 148

## Firmware Upgrade

- Adapters, 149

## Firmware upgrade recovery, 150

## Firmware, Upgrading, 47

## Front View, 10

## G

### General page, 122

### Groups

- assigning users, 114, 116
- creating, 111
- Deleting, 113
- Managing, 111
- Modifying, 113
- removing users, 115, 117

## H

### Hardware Setup, 15

### Hot Plugging, 28

## I

### Installation

- Single Station, 21
- Two Stage, 26

### Introduction, 1

### Invalid login, 37

### IP

- Address determination, 208

### IP Address, 127

### IP Filtering, 135

### IP Installer, 129, 208

## J

### Java Client AP

- GUI, 48
- Logging in, 42

## K

### KA7140 Pin Assignments, 215

### KA7140 Setup and Operation, 214

### Keyboard

- On-Screen, 74

### Keyboard Emulation, 211

- Mac, 211

### KVM Adapter Cables

- upgrading, 149

## L

### LDAP / LDAPS, 132

### LDAP Server Configuration, 173

### List Panel, 172

### Local Console

- GUI, 50
- Main Page, 50

### Log, 98

- filter, 99

### Log Server, 205

- Configure, 167
- Event Panel, 172
- Events, 168
- Installation, 165
- List Panel, 172
- Main Screen, 171
- Menu Bar, 167
- Options, 170
- Starting Up, 166

### Log server, 130, 165

### Logging in

- Browser, 38
- Java Client AP, 42
- Local console, 37

- WinClient AP, 39
- Login
  - Invalid login, 37
  - Login Failures, 138
  - Login String, 136
- M**
  - MAC Filtering, 135
  - Mac Keyboard Emulation, 211
  - Macros
    - Search, 61
  - Managing Groups, 111
  - Managing Users, 107
  - Message Board
    - Windows Client, 67
  - Modem operation, 212, 225
  - Modifying groups, 113
  - Modifying user accounts, 110
  - Module connection diagram, 25
  - Mouse
    - DynaSync Mode, 76
    - Synchronization, 76
  - Mouse pointer type, 75
  - Mouse Problems, 199
  - Mouse synchronization
    - Windows, 216
- N**
  - Network page, 124
  - Network Time, 143
  - Network Transfer Rate, 127
  - NIC Settings, 126
- O**
  - Online
    - Registration, iii
  - On-Screen Keyboard, 74
  - OOBC, 133
  - OpenLDAP
    - Server Configuration, 183
    - Server Installation, 182
    - Overview, 1
- P**
  - Panel array, 89
  - Panel Array Mode, 161, 205
  - Panel Array toolbar, 162
  - Port
    - Naming, 88
    - Properties, 86
  - Port Access, 81
    - Access, 101
    - filter log, 99
    - log page, 98
    - Sessions, 100
  - Port Access Page
    - Recalling, 160
  - Port Forwarding, 210
  - Port ID Numbering, 29
  - Port names
    - clearing, 140
  - Port Operation, 155
  - Port Selection, 29
    - Sidebar, 83
    - Tree, 83
  - Port Utilities, 84
  - Power Supply Detection, 123
  - Powering Off and Restarting, 28
  - PPP, 212, 225
  - Private Certificates, 223
- R**
  - Rack Mounting
    - Front, 17
    - Rear, 19
  - RADIUS
    - settings, 131
  - Rear View, 12

- Redhat, 205
- Redundant NIC, 126
- refresh screen, 65
- Requirements
  - Operating Systems, 9
  - OS Support, 9
- RoHS, ii

## S

- Safety Instructions
  - General, 189
  - Rack Mounting, 191
- Scan, 89
- screen, refresh, 65
- Search
  - Macros, 61
- Security
  - Login string, 136
- Security page, 134
- Self-signed certificates, 223
- Serial Adapter pin assignments, 227
- Sessions, 100
- Single Station Installation, 21
- SJ/T 11364-2006, ii
- Skip Mode, 159
- Stacking, 16
- Sun Keyboard Emulation, 211
- Supported KVM Switches, 228
- Synchronization
  - mouse, 76
- System Requirements, 7
  - KVM Adapter Cables, 8

## T

- Technical Support, 192
- Telephone support, iii
- Time settings, 142

- Toolbar
  - Hotkey port switching, 158
  - Icons, 157
- Troubleshooting
  - General Operation, 197
  - Java Applet, 203
  - Log Server, 205
  - Mac Systems, 204
  - Mouse problems, 199
  - Panel Array Mode, 205
  - Redhat, 205
  - Sun Systems, 204
  - Virtual Media, 201
  - Web Browser, 201
  - WinClient ActiveX Viewer, 202
  - WinClient AP, 202
- Trusted Certificates, 219
- Two IP Addresses, 126
- Two Stage Installation, 26

## U

- User Interface, 45
  - GUI, 48
  - Local Console, 50
  - Tab bar, 47
  - Web Browser Main Page, 45
- User interface
  - Page components, 46
- User Management, 105
- User Notice, iii
- Users
  - Adding, 107
  - assigning to groups, 114, 116
  - Deleting, 110
  - Managing, 107
  - Modifying, 110
  - removing from groups, 115, 117
- Users and Groups, 114

**V**

- Video requirements, 8
- Video Resolution
  - additional procedures, 218
- Video Settings, 64
- Virtual Media
  - Troubleshooting, 201
  - WinClient, 70
- Virtual Media Support, 229

**W**

- Warning beeps, 123

- Web Browser Main Page, 45
- WinClient AP
  - GUI, 48
  - Logging in, 39
- Windows AP
  - Connection Screen, 40
  - File Menu, 41
- Windows Client
  - Auto Scanning, 158
  - Message Board, 67
- Working Mode, 139

## Free Manuals Download Website

<http://myh66.com>

<http://usermanuals.us>

<http://www.somanuals.com>

<http://www.4manuals.cc>

<http://www.manual-lib.com>

<http://www.404manual.com>

<http://www.luxmanual.com>

<http://aubethermostatmanual.com>

Golf course search by state

<http://golfingnear.com>

Email search by domain

<http://emailbydomain.com>

Auto manuals search

<http://auto.somanuals.com>

TV manuals search

<http://tv.somanuals.com>