

4-port USB DVI-D KVMP™ Control Center
CM1164
User Manual



www.aten.com

FCC Information

This is an FCC Class A product. In a domestic environment this product may cause radio interference in which case the user may be required to take adequate measures.

This equipment has been tested and found to comply with the limits for a Class A digital device, pursuant to Part 15 of the FCC Rules. These limits are designed to provide reasonable protection against harmful interference when the equipment is operated in a commercial environment. This equipment generates, uses and can radiate radio frequency energy and, if not installed and used in accordance with the instruction manual, may cause harmful interference to radio communications. Operation of this equipment in a residential area is likely to cause harmful interference in which case the user will be required to correct the interference at his own expense.

RoHS

This product is RoHS compliant.

SJ/T 11364-2006

The following contains information that relates to China.

部件名称	有毒有害物质或元素					
	铅	汞	镉	六价铬	多溴联苯	多溴二苯醚
电器部件	●	○	○	○	○	○
机构部件	○	○	○	○	○	○

- : 表示该有毒有害物质在该部件所有均质材料中的含量均在SJ/T 11363-2006规定的限量要求之下。
- : 表示符合欧盟的豁免条款, 但该有毒有害物质至少在该部件的某一均质材料中的含量超出SJ/T 11363-2006的限量要求。
- ×: 表示该有毒有害物质至少在该部件的某一均质材料中的含量超出SJ/T 11363-2006的限量要求。



User Information

Online Registration

Be sure to register your product at our online support center:

International	http://eservice.aten.com
---------------	---

Telephone Support

For telephone support, call this number:

International	886-2-8692-6959
China	86-10-5255-0110
Japan	81-3-5615-5811
Korea	82-2-467-6789
North America	1-888-999-ATEN ext 4988
United Kingdom	44-8-4481-58923

User Notice

All information, documentation, and specifications contained in this manual are subject to change without prior notification by the manufacturer. The manufacturer makes no representations or warranties, either expressed or implied, with respect to the contents hereof and specifically disclaims any warranties as to merchantability or fitness for any particular purpose. Any of the manufacturer's software described in this manual is sold or licensed *as is*. Should the programs prove defective following their purchase, the buyer (and not the manufacturer, its distributor, or its dealer), assumes the entire cost of all necessary servicing, repair and any incidental or consequential damages resulting from any defect in the software.

The manufacturer of this system is not responsible for any radio and/or TV interference caused by unauthorized modifications to this device. It is the responsibility of the user to correct such interference.

The manufacturer is not responsible for any damage incurred in the operation of this system if the correct operational voltage setting was not selected prior to operation. **PLEASE VERIFY THAT THE VOLTAGE SETTING IS CORRECT BEFORE USE.**

Package Contents

The CM1164 package consists of:

- ◆ 1 CM1164 4-port USB DVI-D KVMPTM Control Center
- ◆ 4 Custom KVM Cable Sets (Single Link DVI-D x 1; USB 2.0 x 1; 2.1 audio x 2; length – 1.8m)
- ◆ 1 IEC320 Power Cord
- ◆ 1 IR Remote Control
- ◆ 1 User Instructions*

Check to make sure that all the components are present and that nothing got damaged in shipping. If you encounter a problem, contact your dealer.

Read this manual thoroughly and follow the installation and operation procedures carefully to prevent any damage to the unit, and/or any of the devices connected to it.

* Features may have been added to the CM1164 since this manual was printed. Please visit our website to download the most up-to-date version.

© Copyright 2010–2012 ATEN® International Co., Ltd.
F/W Version: v1.0.097
Manual Date: 2012-08-16

ATEN and the ATEN logo are registered trademarks of ATEN International Co., Ltd. All rights reserved.
All other brand names and trademarks are the registered property of their respective owners.

Contents

FCC Information	ii
User Information	iii
Online Registration	iii
Telephone Support	iii
User Notice	iii
Package Contents	iv
About this Manual	viii
Conventions	ix
Product Information	ix
1. Introduction	
Overview	1
Features	3
Requirements	4
Console	4
Computers	4
Cables	4
Operating Systems	5
On-Screen Display (OSD) Languages	5
Components	6
Front View	6
Rear View	7
IR Remote Control	8
2. Hardware Setup	
Rack Mounting	9
Grounding	11
Single Station Installation	11
Single Station Installation Diagram	12
Daisy Chaining	13
3. Basic Operation	
Overview	15
Port ID Numbering	15
LED Display	16
Manual Switching	17
Display Modes	18
Quad View	19
Picture in Picture	19
Channel ID	21
Quad View	21
PiP Dual	21
PiP Quad	22
FN Keys	23
Hot Plugging	23

Hardware Cursor Mode	24
Channel Editor	24
Powering Off and Restarting.	26
KVM Reset	26

4. Keyboard Port Operation

Activate the OSD	27
Activate the OSD in Hardware Cursor Mode	27
Invoking HSM	28
Auto Scanning	30
List Current KVM Settings.	31
USB Reset	31
Video DynaSync	31
Channel Editor	32

5. OSD Operation

Overview.	33
OSD Operation and Menu	34
Port Selection	36
Mode Selection	36
Display Modes.	37
Quad	37
Picture in Picture (Dual / Triple / Quad).	37
Disable Channel	38
Quadview Resolution	38
DCC	39
Setting	40
System	40
Hardware Cursor Mode	40
OSD Hotkey	41
Hotkey Selection Mode	41
Video DynaSync	41
Activate Beeper	41
OSD Language	42
Keyboard Language	42
Auto Scan	43
Security	43
Login Timeout	44
KVM Status	44
DCC Control	44
Computer	45
Keyboard Emulation	45
Mouse Emulation.	45
Power On Detection	46
Set OS.	46
USB Reset.	46
Configuration.	47

Fn Key	47
Restore Default Values	48
Firmware Upgrade	48
Help	48

6. Firmware Upgrade

Before you Begin	49
Starting the Upgrade	50
Upgrade Succeeded	52
Upgrade Failed	52

Appendix

Safety Instructions	53
Technical Support	55
International	55
North America	55
Specifications	56
Troubleshooting	57
Mac Keyboard Emulation	59
Sun Keyboard Emulation	60
Factory Default Hotkeys and Settings	61
Limited Warranty	61

About this Manual

This User Manual is provided to help you get the most from your system. It covers all aspects of installation, configuration and operation. An overview of the information found in the manual is provided below.

Chapter 1, Introduction, introduces you to the CM1164 system. Its purpose, features and benefits are presented, and its front and back panel components are described.

Chapter 2, Hardware Setup, describes how to set up your installation. Diagrams showing the necessary steps are provided.

Chapter 3, Basic Operation, explains the fundamental concepts involved in operating the CM1164.

Chapter 4, Keyboard Port Operation, details all of the concepts and procedures involved in the Hotkey operation of your CM1164 installation.

Chapter 5, OSD Operation, provides a complete description of the CM1164's On-Screen Display (OSD), and how to work with it.

Chapter 6, Firmware Upgrade, explains how to upgrade the CM1164's firmware with the latest available versions.

An Appendix, provides specifications and other technical information regarding the CM1164.

Conventions

This manual uses the following conventions:

- | | |
|---|--|
| Monospaced | Indicates text that you should key in. |
| [] | Indicates keys you should press. For example, [Enter] means to press the Enter key. If keys need to be chorded, they appear together in the same bracket with a plus sign between them: [Ctrl+Alt]. |
| 1. | Numbered lists represent procedures with sequential steps. |
| ◆ | Bullet lists provide information, but do not involve sequential steps. |
| → | Indicates selecting the option (on a menu or dialog box, for example), that comes next. For example, Start → Run means to open the <i>Start</i> menu, and then select <i>Run</i> . |
|  | Indicates critical information. |

Product Information

For information about all ATEN products and how they can help you connect without limits, visit ATEN on the Web or contact an ATEN Authorized Reseller. Visit ATEN on the Web for a list of locations and telephone numbers:

International	http://www.aten.com
North America	http://www.aten-usa.com

This Page Intentionally Left Blank

Chapter 1

Introduction

Overview

To improve operational efficiency in control rooms, there needs to be a fast and convenient way to view and manage more computers simultaneously, permitting faster response times from a single location. In addition, the solution must save space and eliminate the need for extra keyboards, mice, and monitors.

The CM1164 4-port USB DVI-D KVM Control Center charts a revolutionary new direction in KVM switch functionality by combining a 4-port DVI-D switch with a 2-port USB hub, and providing the following Display Modes: Quad View mode, which simultaneously displays four digital computers/video sources on a single screen; as well as Picture in Picture mode (Dual, Triple or Quad) and Full Screen mode; see *Display Modes*, page 18. There are many ways to control and switch between computers/video sources – simply select which source you want to view on the console display by these convenient access methods: via the front panel pushbuttons, using an IR remote control, through the On-Screen Display (OSD) or through hotkey combinations entered from the console keyboard.

The CM1164 allows users to access 4 computers/devices from a single console, consisting of a USB keyboard, USB mouse and DVI-D monitor. As USB hub, it permits each computer to access connected peripherals on a one-computer-at-a-time basis. The CM1164's independent switching feature allows the KVM focus to be one computer while the USB peripheral focus is on another. There is no need to purchase a separate USB hub, as well as separate stand-alone peripheral sharers.

The CM1164 further improves on previous designs with DVI-D connectors, and the transfer of keyboard and mouse data to the computers via a fast, reliable USB connection. As with the USB peripherals, the audio focus can be independent of the KVM focus.

A Daisy Chain Control (DCC) port allows a user to connect and control up to four CM1164 units via a single console. This enables the use of only one keyboard/mouse over several computers or another CM1164. This is convenient for growing networks that need to monitor and manage more computers – daisy chain up to four units and switch between up to 16 computers/video sources.

Setup is fast and easy; simply plug cables into their appropriate ports. There is no software to configure, no installation routines, and no incompatibility problems. Since the CM1164 intercepts keyboard input directly, it will work on Microsoft Windows, Linux, Sun and Mac platforms.

In addition, the firmware upgrade by USB interface simplifies the process and ensures your CM1164 is up-to-date.

With its unique design and innovative features, the CM1164 4-port USB DVI-D KVMP™ Control Center provides both style and functionality for a wide range of practical applications, including control rooms, monitoring systems and traffic control centers, as well as process control centers, server rooms, medical industries, broadcasting, production and automation, aircraft and vehicles. In combination with projectors, it is also used in presentations and conference rooms. Allowing you to switch seamlessly between four DVI-enabled PCs, and share USB peripherals and high-definition audio from a dual-display console, the CM1164 is ideal for multimedia applications, and offers the ultimate in space-saving, streamlined KVM technology.

Features

- ◆ One console independently and simultaneously controls four DVI-D computers, and two additional USB devices
- ◆ 2-port USB 2.0 hub built in; fully compliant with USB 2.0 specification
- ◆ Multi-view console controls up to 4 video sources on one screen with Display Modes including Quad View mode, Picture in Picture mode (Dual, Triple or Quad), and Full Screen mode
- ◆ Function control via OSD menu – Display Mode, port selection, DCC, etc.
- ◆ DCC (Daisy Chain Control) port enables users to connect up to four CM1164 units, and use one console keyboard/mouse to manage computers or another CM1164
- ◆ Hardware Cursor – control the OSD menu using the console mouse
- ◆ Channel Editor – easily manipulate channel display settings, including the size and position of channel windows, and switching their port numbers
- ◆ Computer selection via front panel push buttons, hotkeys, IR Remote Control and OSD (with mouse* function enabled)
- ◆ Console mouse port emulation/bypass feature that supports most mouse drivers and multifunction mice
- ◆ Console keyboard emulation/bypass feature that support most multimedia keyboards
- ◆ Independent switching of USB peripheral port, audio function, and KVM switch focus
- ◆ Superior video quality – up to 1920 x 1200 resolution
- ◆ Video DynaSync™ – exclusive ATEN technology that eliminates boot-up display problems and optimizes resolution when switching between ports
- ◆ Firmware upgradeable via a computer's USB port
- ◆ Power on detection – if one of the computers is powered off, the CM1164 automatically switches to the next powered-on computer
- ◆ Auto Scan Mode
- ◆ Full bass response provides a rich experience for 2.1 channel audio
- ◆ Multiplatform support – Windows, Linux, Sun and Mac
- ◆ Multilingual keyboard mapping – supports English, Japanese and French keyboards
- ◆ Sun/Mac keyboard support and emulation**

* For 3-key USB wheel mouse only

** PC keyboard combinations emulate Sun/Mac keyboards

** Sun/Mac keyboards only work with their own computers

Requirements

Console

- ◆ A DVI-D Single Link display capable of the highest possible resolution
- ◆ A USB mouse
- ◆ A USB keyboard
- ◆ Microphone and speakers (optional)

Computers

The following must be available on each computer:

- ◆ A DVI port

Note: The quality of the display is affected by the quality of the display card. We recommend you purchase a high quality product.

- ◆ USB Type A port
- ◆ Audio ports (optional)

Cables

- ◆ Custom KVM cable (Single Link DVI-D, 2.1 channel audio, USB 2.0)
- ◆ IEC320 Power Cord
- ◆ RJ-45 cable(s) for Daisy Chain Control

Operating Systems

Supported operating systems are shown in the tables, below:

OS		Version
Windows		2000 and higher
Linux	RedHat	6.0 and higher
	SuSE	8.2 and higher
UNIX	FreeBSD	3.51 and higher
	Sun	Solaris 8 and higher
Novell	Netware	6.0 and higher
Mac		OS 9 and higher

On-Screen Display (OSD) Languages

The CM1164's GUI is in English by default. Other languages supported are: French, German, Japanese and Traditional Chinese.

Components

Front View

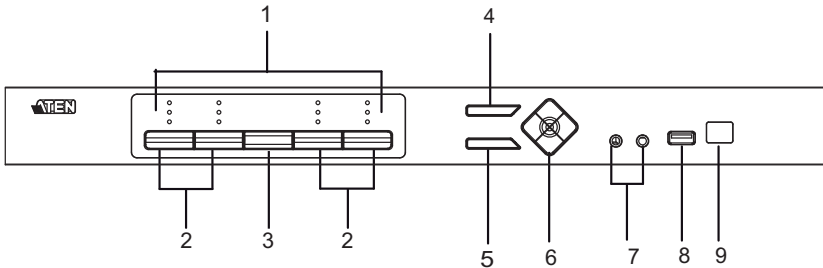

No.	Component	Description
1	LED Status Panel	This panel contains LED icons that light to indicate mode and port status. The Mode and Port Selection Pushbuttons each have three corresponding LED icons that represent audio , KVM , and USB Link status. See <i>LED Display</i> , page 16, for full details.
2	Port Selection Pushbuttons	<ul style="list-style-type: none"> ◆ Press the Port Selection Pushbuttons to manually switch ports. See <i>LED Display</i>, page 16, for full details. ◆ Press and hold Port Selection Pushbuttons 1 and 2 simultaneously for <i>2 seconds</i> to start Auto Scan Mode. See <i>Auto Scanning</i>, page 30, for full details. ◆ Press and hold Port Selection Pushbuttons 3 and 4 simultaneously for <i>2 seconds</i> to execute a KVM reset. See <i>KVM Reset</i>, page 26 for full details.
3	Mode Selection Pushbutton	This pushbutton allows you to cycle through the three modes of focus – KVM, audio, and USB Link.
4	OSD (Esc) button	Press this to invoke the on-screen display (OSD) menu. When the OSD menu is enabled, press the OSD button to go back to the previous menu/submenu.
5	Select button	Press this to select an option in the OSD menu.
6	Direction / Function buttons	Use these buttons to switch between Function modes (Fn1 to Fn4), and to cycle through the OSD menu/selection. See <i>IR Remote Control</i> , page 8 for details.
7	Console Audio Ports	Your speakers and microphone plug in here.
8	USB 2.0 Peripheral Port	USB 2.0 peripherals (printers, scanners, etc.) plug into this port.
9	IR Receiver	This receives signals from the IR remote control.

Rear View

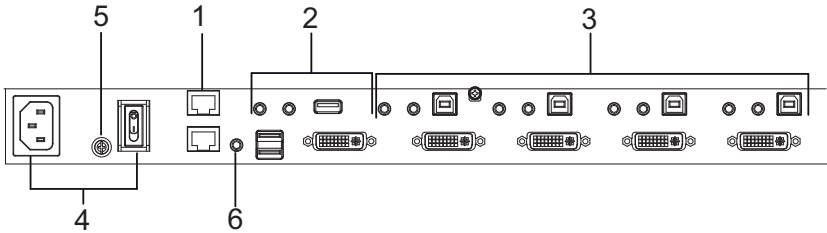

No.	Component	Description
1	Daisy Chain Control In / Out ports	Use these ports to connect to another CM1164's DCC port to pass keyboard and mouse signals. You can daisy chain up to four CM1164 units.
2	Console Port Section	The cables from your USB keyboard, USB mouse, DVI console display, a USB peripheral, microphone and speakers plug into this section.
3	DVI KVM Port Section	The cables that link the CM1164 to your DVI-D Single Link computers plug in here. Each DVI KVM port is comprised of a microphone jack, speaker jack, USB type B socket, and a DVI Single Link connector. You can initiate a firmware upgrade from the computer connected to these ports.
4	Power Socket / Power Switch	Plug in the power cord to the power socket and use the switch to power on the CM1164.
5	Grounding Terminal	The grounding wire (used to ground the unit) attaches here.
6	IR Receiver (Extension)	This receives signals from the IR remote control through an IR extension, which can be purchased separately.

IR Remote Control

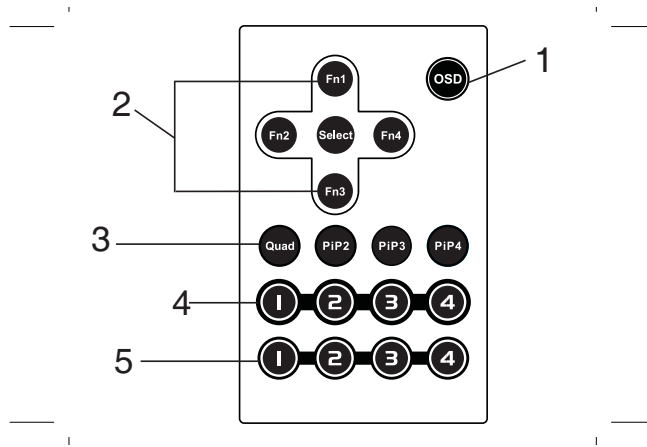

No.	Component	Description
1	OSD button	Press this to turn on/turn off the OSD menu. When the OSD menu is enabled, press the OSD button to go back to the previous menu/submenu.
2	Fn1 / Fn2 / Fn3 / Fn4 Buttons and Select Button	Use these buttons to switch between Function modes (Fn1 to Fn4), and to cycle through the OSD menu/selection. See <i>FN Keys</i> , page 23 for details on how to store function mode settings, which you can invoke for later use. The Fn1~Fn4 buttons are positioned to correspond to the up / down / left / right direction. <ul style="list-style-type: none"> ◆ When cycling through the menu options, press the Select button to go the submenu. ◆ If you want to change or adjust a selection/value, press the Select button then the Fn1 (up) / Fn2 (left) / Fn3 (down) / Fn4 (right) buttons to go through all the selections/values. Press the Select button again to confirm a selection.
3	Display Mode buttons	Select the Display Mode you want to view. See <i>Display Modes</i> , page 18.
4	Port Selection Buttons 1~4	Press these buttons to switch ports (1~4).
5	Station Selection Buttons	If the CM1164 is daisy chained to one or several units (up to 4), press the button corresponding to the CM1164 device that you want to configure or operate.

Chapter 2

Hardware Setup



1. Important safety information regarding the placement of this device is provided on page 53. Please review it before proceeding.
2. Make sure that the power to all devices connected to the installation is turned off. You must unplug the power cords of any computers that have the Keyboard Power On function.

Rack Mounting

For convenience and flexibility, the CM1164 can be mounted on system racks. To rack mount a unit do the following:

1. Remove the screws attached to the unit as shown in the diagram below:

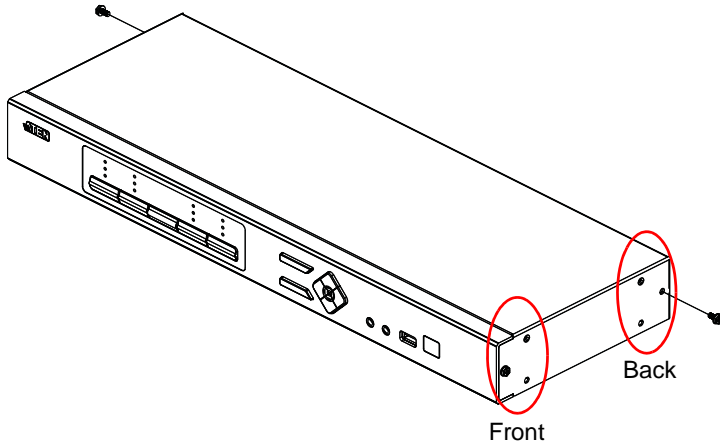

Note: You can remove the screws on the front side panels or the back side panels. The succeeding diagrams show the rack mounting steps for the back panel.

- Using the screws provided in the Mounting Kit (not included with this package), screw the mounting bracket into the side of the unit as show in the diagram below:

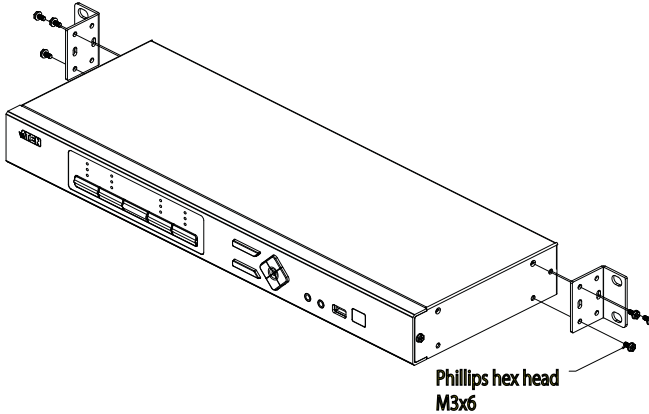

Note: The Mounting Kit is not included in the package. Please contact your dealer for more details.

- Screw the bracket into any convenient location on the rack.

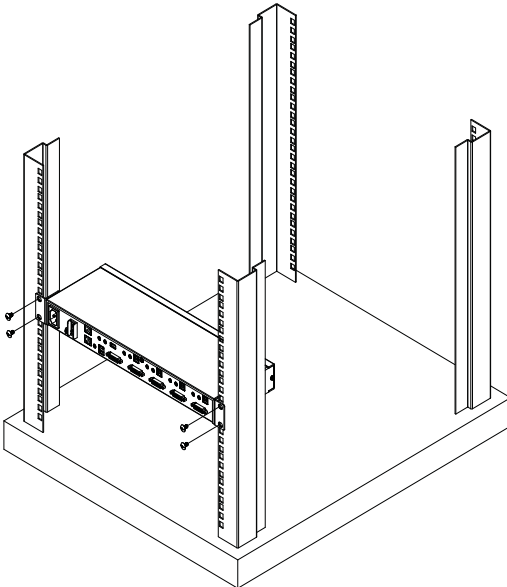

Note: These screws are not provided. We recommend that you use M5 x 12 Phillips Type I cross, recessed type screws.

Grounding

To prevent damage to your installation it is important that all devices are properly grounded.

1. Use a grounding wire to ground the CM1164 by connecting one end of the wire to the grounding terminal, and the other end of the wire to a suitable grounded object.
2. Make sure that the computer(s)/device(s) that the CM1164 connects to are properly grounded.

Note: The grounding wire is not included in the package. Please contact your dealer for the appropriate cable.

Single Station Installation

To set up your CM1164 installation, refer to the installation diagram on page 12 (the numbers in the diagrams correspond to the steps below), and do the following:

1. Plug your USB keyboard and USB mouse into the USB Console Ports located on the unit's rear panel.
2. Plug your DVI display into the Console DVI Single Link Port located on the unit's rear panel.
3. If you are using an IP phone headset or separate microphone and speakers, plug them into the analog audio ports on the unit's front panel. These audio ports have priority over those on the rear panel.
4. If you are using separate speakers and microphone, plug them into the console analog audio ports on the unit's rear panel.
5. Using the custom DVI KVM cable set, plug the DVI-D Single Link cable connector and the accompanying USB and audio connectors their corresponding sockets on the rear of the switch.
6. At the other end of the cable, plug the DVI and USB cables into their respective ports on the computer(s) that is(are) the source of DVI content.
7. Plug your USB peripherals into the type A sockets (one easy-access port is located on the front for portable devices; the second is located on the rear).
8. Plug the power cord into the CM1164 power jack, then plug the other end of the power cord into an AC power source.

9. Power on the displays and the computers/devices.

Note: The recommended power-on sequence is Port 1–Port 2–Port 3–Port 4.

Single Station Installation Diagram

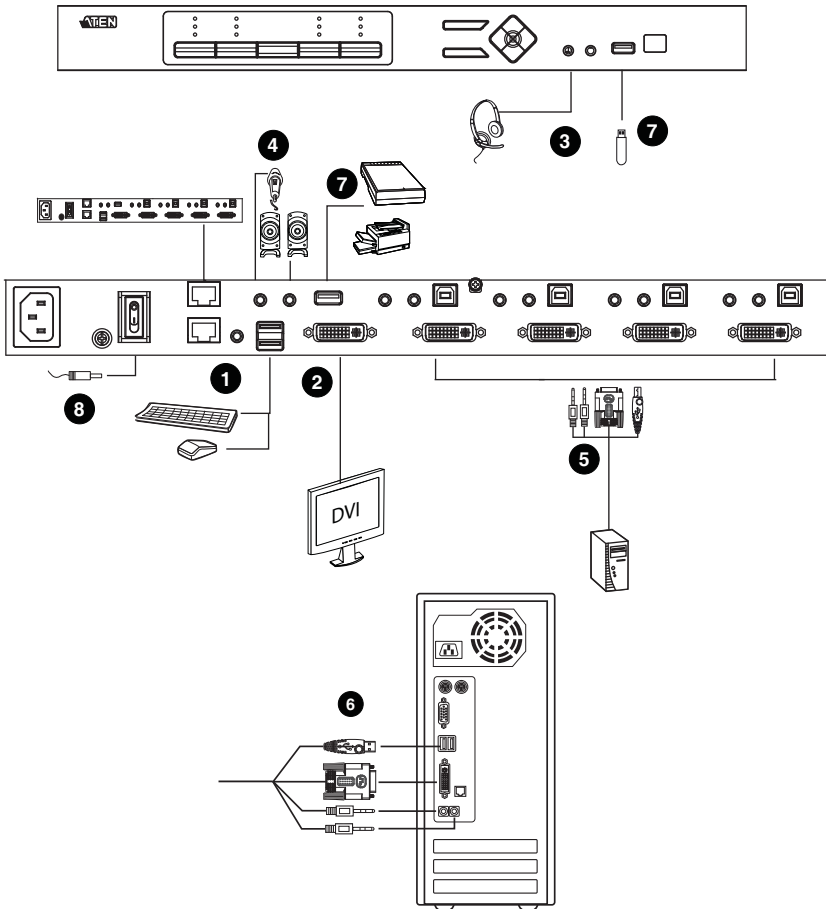

Daisy Chaining

To display even more computers/video source devices, up to 3 additional CM1164 units can be daisy chained from the original CM1164. As many as 16 computers/video source devices can be controlled from a single console in a complete installation.

To set up a daisy chained installation, make sure that power to all the devices you will be connecting up has been turned off. Do the following:

1. Use an RJ-45 cable to connect the *DCC Out* port of the parent CM1164 unit to the *DCC In* port of the child CM1164 unit (first station out to second station in, second station out to third station in, etc.).

Note: 1. You cannot use the chain in port of the First Station, since it is the highest level parent.

2. Daisy chain cable sets require a separate purchase. See your dealer for details.
-

2. Cable up the computer and the switch according to the information provided under *Single Station Installation*, page 11.
3. Repeat the above for any other switches you want to add to the chain (up to three).
4. Power up the installation: plug in the power cord for the first station, then power on each station on the installation in turn (second station, then third station, etc.). After all the stations are up, power on the computers/video source devices.

Daisy Chain Installation Diagram

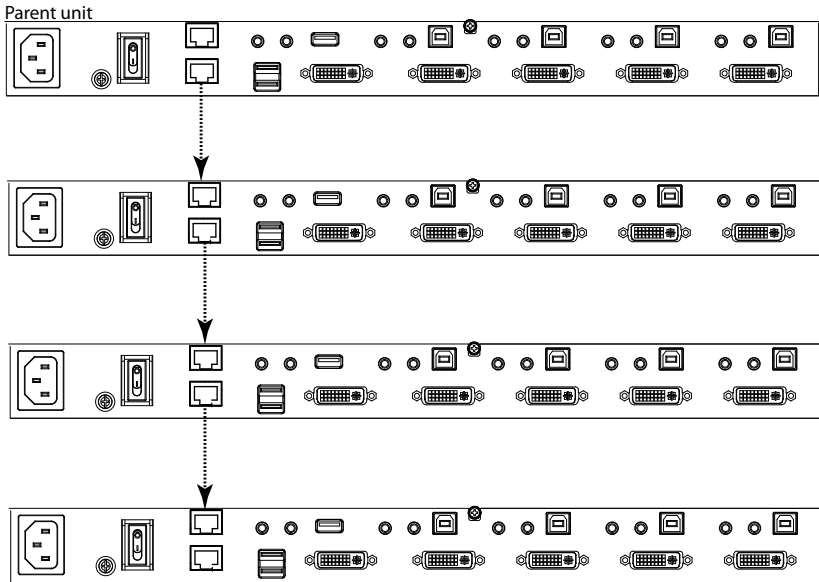

Chapter 3

Basic Operation

Overview

There are various convenient methods to access the computers: manual, hotkey, IR remote control, and the On-Screen Display (OSD). Manual operation involves pressing the Mode and port selection pushbuttons located on the unit's front panel. This is discussed in this chapter, as well as the LED Displays, Display Modes, and so on.

Hotkey operation, which involves entering combinations from the keyboard, is discussed in Chapter 4. Port switching via remote control and the OSD are discussed in Chapter 5.

Port ID Numbering

Each KVM port on the CM1164 switch is assigned a port number (1, 2, 3, and 4). The port numbers are marked on the rear panel of the switch.

The Port ID of a computer is derived from the KVM port number to which it is connected. For example, a computer connected to KVM port 2 has a Port ID of 2.

Note: The Port ID is also used to specify which computer gets the KVM, USB peripheral, and audio focus with the Hotkey port selection method (see *Auto Scanning*, page 30 for details).

The Port ID may or may not correspond to the Channel ID. The Channel ID refers to the frame position on the display device, depending on the Display Mode. See *Display Modes*, page 18 and *Channel ID*, page 21 for more details.

LED Display

The Mode and Port Selection Pushbuttons on the CM1164's front panel each have three corresponding LED icons that represent **audio**, **KVM**, and **USB Link**. These light green or orange, depending on status, as shown in the table, below:

LED		Indication
Mode	KVM	Lights BRIGHT ORANGE to indicate KVM is selected.
	Audio	Lights BRIGHT GREEN to indicate Audio is selected.
	USB Link	Lights BRIGHT GREEN to indicate USB is selected.
Port	KVM	<ul style="list-style-type: none"> ◆ OFF to indicate port is not selected. ◆ Lights BRIGHT ORANGE to indicate that the computer attached its corresponding port has the KVM focus. ◆ Flashes to indicate that the computer attached to its corresponding port is being accessed in Auto Scan Mode. ◆ All flash ORANGE to indicate that Firmware Upgrade mode has been invoked. ◆ The corresponding port LED of the USB keyboard/mouse flashes when Keyboard Bypass is enabled. ◆ Dims to a faint ORANGE to indicate that the computer is powered on but does not have the KVM focus.
	Audio	<ul style="list-style-type: none"> ◆ Lights BRIGHT GREEN to indicate that the computer attached to its corresponding port has the Audio focus. ◆ Daisy Chain Control: Flashes GREEN to indicate that the computer attached to the corresponding port has the KVM focus.
	USB	<ul style="list-style-type: none"> ◆ Lights BRIGHT GREEN to indicate that the computer attached to its corresponding port has access to the USB peripherals. ◆ Daisy Chain Control: Flashes GREEN to indicate that the computer attached to the corresponding port has access to the USB peripherals.
Pushbuttons	OSD	Lights BRIGHT BLUE to indicate OSD operation from the front panel.
	Select	Lights BRIGHT BLUE to indicate OSD operation from the front panel.
	Fn	Lights BRIGHT BLUE to indicate OSD operation from the front panel.

Note: The Port Selection KVM icon is the port number (1, 2, 3, and 4).

Manual Switching

The Mode selection pushbutton and the pushbuttons that correspond to each port have three icons – **KVM**, **audio**, and **USB Link**. The icons on the Mode pushbutton light up when the Mode pushbutton is pressed to indicate cycling through the corresponding KVM, audio, and USB modes.

The icons on the port selection pushbuttons light up to indicate the current status of the computer that corresponds to that port. For example, if the audio icon is lit up above the port 3 selection pushbutton, this indicates that the computer attached to port 3 currently has the audio focus.

- ◆ To bring complete focus (**audio**, **KVM**, and **USB**) to a computer, *either*, a) press the port selection pushbutton that corresponds to that computer; *or* b) press the Mode pushbutton **once** (the Mode pushbutton's three icons light up) and then press the port selection pushbutton that corresponds to that computer. All three port icons light up.
- ◆ To bring only the **KVM** focus to a computer, press the Mode pushbutton **twice** (the Mode pushbutton's KVM icon lights up), and then press the port selection pushbutton that corresponds to that computer. The port's KVM icon (the port number) lights up.
- ◆ To bring only the **audio** focus to a computer, press the Mode pushbutton **three times** (the Mode pushbutton's audio icon lights up), and then press the port selection pushbutton that corresponds to that computer. The port's audio icon lights up.
- ◆ To bring only the **USB** focus to a computer, press the Mode pushbutton **four times** (the Mode pushbutton's USB icon lights up), and then press the port selection pushbutton that corresponds to that computer. The port's USB icon lights up. Press and hold port selection pushbuttons 1 and 2 simultaneously **for 2 seconds** to start Auto Scan Mode. See *Auto Scanning*, page 30 for details.

Note: Press and release either port selection pushbutton to stop Auto Scan Mode. The KVM focus goes to the computer attached to the corresponding port of the pushbutton you pressed.

- ◆ Press and hold port selection pushbuttons 3 and 4 simultaneously **for 2 seconds** to execute a KVM reset. See *KVM Reset*, page 26 for details.

Display Modes

The CM1164 enables users to use various Display Modes so that the screen can show more than one computer/video source at one time. This feature is useful when requiring information from multiple computers/video sources conveniently.

When switching between ports, either via the front panel pushbuttons, remote control, and so on, the display is shown in *Full Screen* by default. This mode enables users to view the computer/video source with the KVM focus in maximum resolution, with the picture occupying the whole screen.



Note: The number shown on the top left corner of the each display is the Port ID. See page 15 for details.

Change the Display Mode using the IR remote control. See *IR Remote Control*, page 8 for details. Simply click the button of the Display Mode you want to use:

- ◆ The **Quad** button refers to *Quad View* (see page 19).
- ◆ The **PiP2** button refers to *Picture in Picture Dual Mode* (see page 19).
- ◆ The **PiP3** button refers to *Picture in Picture Triple Mode* (see page 20).
- ◆ The **PiP4** button refer to *Picture in Picture Quad Mode* (see page 20).

If you switch between ports, the Display Mode reverts back to *Full Screen*.

The four Display Modes available are as follows.

Quad View

Quad View displays all four computers/video sources on the display.

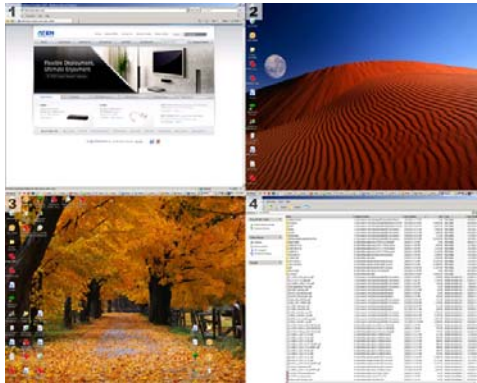

By default, the resolution for Quad View uses the resolution of the source device assigned to Port 1. However, you can configure the resolution and choose a better fit via the OSD. Refer to *Quadview Resolution*, page 38 for details.

Picture in Picture

The Picture in Picture (PiP) mode shows one computer/video source occupying the whole screen, while one or several screens are displayed to the right of the screen (the size depending on the stored settings).

- **Dual** - shows two computers/video sources, with only half of the actual display visible, as illustrated below.



Note: There is an option to view the two screens in full, but in smaller resolutions that fit into the display. See *Picture in Picture (Dual / Triple / Quad)*, page 37 for details on how to use the Picture by Picture feature.

- **Triple** - shows three computers/video sources, as shown below.



Note: There is an option to view Channel 1 in full so that the other channels do not cover the right side of the screen, but it is shown in a smaller resolution that allow all the channels to fit into the display. See *Picture in Picture (Dual / Triple / Quad)*, page 37 for details on how to use the Picture by Picture feature so that the channels do not overlap. This also applies to *PiP Quad Mode*.

- **Quad** - shows four computers/video sources at one time, but unlike in *Quad View*, one display takes up the whole screen, while the other three displays are occupying only the right side of the screen, as shown below:



The screen size of the each display depends on the resolution of the computer/video source connected to the port. Additionally, you can use the OSD menu to customize the display screen size. See *Picture in Picture (Dual / Triple / Quad)*, page 37 for more details.

Channel ID

Depending on the Display Mode selected, the screen may be divided into two, three or four sections to show the corresponding computer(s)/video source(s) connected to the KVM ports. Each section has a designated Channel ID and this assignment remains the same for all Display Modes.

Note that the Channel ID is not visible, and that the number shown on screen refers to the Port ID. The following diagrams illustrate the Channel ID positions for each Display Mode.

Quad View

The Channel IDs are ordered in a clockwise direction, with letter A starting at the top left panel.

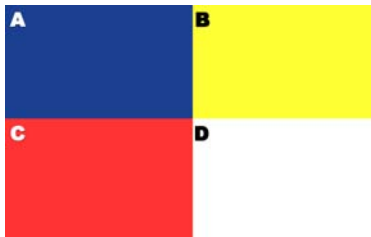

PiP Dual

The Channel IDs are ordered from left to right, with letter A starting at the left panel.

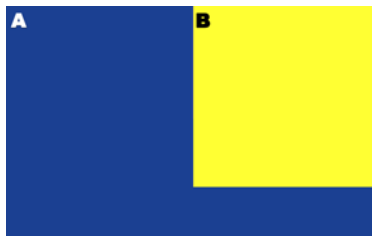

PiP Triple

The Channel IDs are ordered in a clockwise direction, with letter A starting at the left panel, and letter B following at the top right panel.

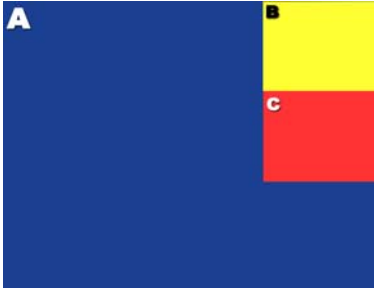

PiP Quad

Like the previous Display Mode, the Channel IDs are ordered in a clockwise direction, with letter A starting at the left panel, and letter B following at the top right panel.



Note: There is an option to view Channel A in full so that the other channels do not cover the right side of the screen, but it is shown in a smaller resolution that allow all the channels to fit into the display. See *Picture in Picture (Dual / Triple / Quad)*, page 37 for details on how to use the Picture by Picture feature so that the channels do not overlap. This also applies to *PiP Quad Mode*.

For all Display Modes, when the source device's resolution does not fit the set resolution for the channel, a black space fills the gap, as shown below.

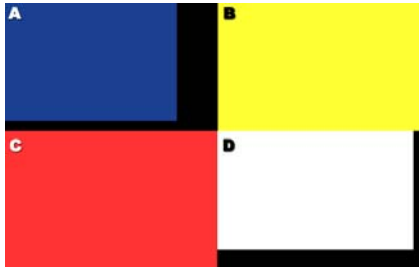

In the example above, the video source devices connected to Channel A and Channel D are smaller than the resolution configured for the Display Mode. For Quad View, the resolution can be set via the OSD (see *Quadview Resolution*, page 38) to get the best fit.

FN Keys

After assigning the KVM, audio and USB focus to one or more ports and selecting the Display Mode, you can save this configuration into a function key via the On-Screen Display (OSD). With Function Control, you can easily toggle between different display configurations, saving you the time and effort of manually setting them each time.

See *Fn Key*, page 47 for details on how to use the OSD menu to save a function key.

You can store up to four function keys and use them readily through the following methods:

- ◆ **Front panel pushbuttons.** Use the Function (**Fn1~Fn4**) pushbuttons located on the CM1164's front panel.
- ◆ **IR remote control.** Use the Function (**Fn1~Fn4**) buttons. See *IR Remote Control*, page 8.
- ◆ **OSD menu.** Use the *Fn Key* page and select the configuration you want to use.

Hot Plugging

The CM1164 supports USB hot plugging – components can be removed and added back into the installation by unplugging their cables from the USB hub ports without the need to shut the unit down.

Hardware Cursor Mode

The CM1164 supports Hardware Cursor Mode, which can be enabled via OSD (see *Hardware Cursor Mode*, page 40). With this feature, you can use the mouse while the OSD is invoked and navigate the OSD menus and select menu options as if you were working with a web browser. Normally, the mouse stops working when the OSD is displayed and users can only use the keyboard. The Hardware Cursor Mode presents a convenient way of configuring the CM1164 OSD and customizing the device, such as switching video sources or display, quickly and efficiently.

Note: The Hardware Cursor Mode is disabled by default.

Channel Editor

The Channel Editor enables you to use the mouse and change the screen position of a channel, simply by dragging the display channel window(s) across the screen; you can also click on the port number to toggle between up to 3 display sizes. In addition, you can easily edit the port number assigned to a display channel without going to the OSD Port screen and manually changing the numbers.

Note: Some of the Channel Editor functions only works with Picture in Picture (PiP) mode, such as changing the display channel screen position and window size.

- ◆ Click and hold the port number to highlight the display channel window, then drag it across the screen to a new position.



- ◆ Click the port number to highlight the display channel window and click again to go through the window sizes available. Set it according to preference.

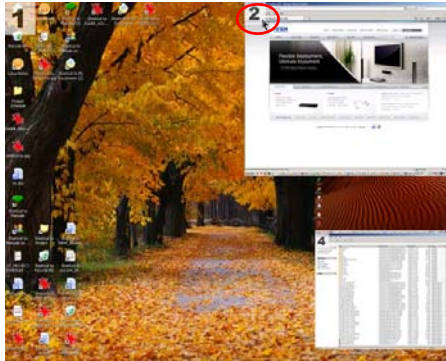

- ◆ Highlight the port number of a display channel's port number that you want to change. Then click the target port number – the two display channels will then switch port numbers.

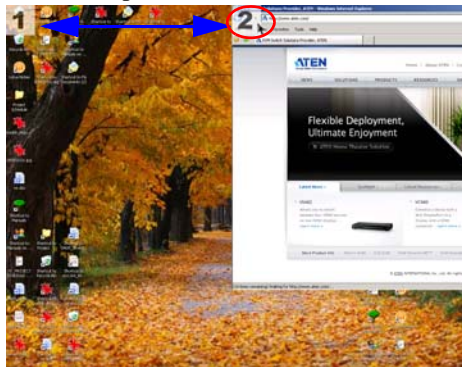

Note: The mouse icon should change in color (either black or white) if the Channel Editor is enabled. You can set this via the OSD – *Hardware Cursor Type*, page 41.

See *Channel Editor*, page 32 for hotkeys related to the Channel Editor.

Powering Off and Restarting

If it becomes necessary to power off the unit, before starting it back up you must do the following:

1. Shut down all the computers that are attached to the switch.
2. Unplug the switch's power adapter cable.
3. Wait 10 seconds, then plug the switch's power adapter cable back in.
4. After the switch is up, Power On the computers.

KVM Reset

To reset your complete KVM installation to the factory default settings, use the OSD menu. See *Restore Default Values*, page 48.

Chapter 4

Keyboard Port Operation

The CM1164 provides an extensive, easy-to-use hotkey function that makes it convenient to control and configure your KVM installation from the keyboard.

Activate the OSD

To activate the OSD using your keyboard, tap the **Scroll Lock** key twice:

[Scroll Lock] [Scroll Lock]

You can close the OSD by pressing the Esc key or the space bar.

Note: The hotkey for activating the OSD can be change to the Ctrl key.
See *Hardware Cursor Type*, page 41 for details.

Activate the OSD in Hardware Cursor Mode

The following additional hotkeys apply when the Hardware Cursor Mode is enabled. See *Hardware Cursor Mode*, page 24 and page 40, for more information on this feature.

1. [Scroll Lock] [Scroll Lock] then mouse right-click to open the OSD.
2. Click Esc to close the OSD.
3. Click Esc again to exit Hardware Cursor Mode and go back to normal PC operation.

Note: When Hardware Cursor Mode is disabled, pressing [Scroll Lock] twice opens the OSD.

Invoking HSM

Hotkeys provide independent switching of the KVM, USB hub and audio focus. You can give one computer the KVM console focus, another the USB hub focus, and the other two the audio focus. All operations begin with invoking Hotkey Setting Mode (HSM).

To invoke HSM do the following:

1. Press and hold down [**Num Lock**].
2. Press and release [-].
3. Release [**Num Lock**].

Note: The hotkey for invoking HSM can be change to another combination. See *Hotkey Selection Mode*, page 41 for details.

When HSM is active, the Caps Lock, and Scroll Lock LEDs flash in succession to indicate that HSM is in effect. They stop flashing and revert to normal status when you exit HSM.

Ordinary keyboard and mouse functions are suspended – only Hotkey compliant keystrokes and mouse clicks (described in the sections that follow), can be input.

At the conclusion of some hotkey operations, you automatically exit hotkey mode. With some operations, you must exit manually. To exit HSM manually, press the Esc key, or the spacebar.

The following table describes the actions that each combination performs on the CM1164 bar. You have to invoke HSM first then enter the key combinations, and this applies to each hotkey command you want to perform.

Hotkey	Action
[A]	Starts Auto Scan. See <i>Auto Scanning</i> , page 30 for more information.
[Enter]	Switch to the next computer/source device (1 to 2, 2 to 3, 3 to 4, and 4 to 1.)
[Port ID] [Enter]	Switch to the computer/source device that corresponds to the Port ID entered.
[Port ID] [K] [Enter]	Brings only the KVM focus from the port that currently has it to the computer/source device that corresponds to the Port ID entered. The USB and audio focus remain where they are.

Hotkey	Action
[Port ID] [U] [Enter]	Brings only the USB hub focus from the port that currently has it to the computer/source device that corresponds to the Port ID entered. The KVM and audio focus remain where they are.
[Port ID] [S] [Enter]	Brings only the audio focus from the port that currently has it to the computer/source device that corresponds to the Port ID entered. The KVM and USB hub focus remain where they are.
[Station ID] [Port ID] [K] [Enter]	Brings only the KVM focus to the computer/source device that corresponds to the Port ID entered, on the CM1164 that corresponds to the Station ID entered when several units are daisy chained.
[D]	See <i>Video DynaSync</i> , page 31.
[F4]	Lists the KVM's current settings. See <i>List Current KVM Settings</i> , page 31.
[F5]	See <i>USB Reset</i> , page 31.

Auto Scanning

The CM1164's Auto Scan feature automatically cycles the KVM focus through the computer ports at regular intervals. This allows you to monitor the computer activity without having to take the trouble of switching from port to port manually. Although the video focus switches from port to port, the keyboard, mouse, and USB focus do not switch. They stay at the port they were on when Auto Scanning started. See the table below for details.

Hotkey	Action
[Num Lock] [-] [A] [Enter]	Invokes Auto Scan. The KVM focus cycles from port to port at 5 second intervals . This is the Default setting.
[Num Lock] [-] [A] [n] [Enter]	The KVM focus cycles from port to port at n second intervals. Note: The n stands for the number of seconds that the CM1164 should dwell on a port before moving on to the next. Replace the n with a number between 1 and 99 when entering this hotkey combination.

When you use the port switching hotkey or HSM, the mouse cursor must be in the current computer display.

While Auto Scan Mode is in effect, ordinary keyboard and mouse functions are suspended – only Auto Scan Mode compliant keystrokes and mouse clicks can be input. You must exit Auto Scan Mode in order to regain normal control of the console.

List Current KVM Settings

To see a listing of the current switch settings, do the following:

1. Open a text editor or word processor and place the cursor in the page window.
2. Invoke HSM (see page 28).
3. Press and release [**F4**] to display the settings.

USB Reset

If the USB loses focus and needs to be reset, do the following:

1. Invoke HSM (see page 28).
2. Press and release [**F5**]

Video DynaSync

Video DynaSync is ATEN's exclusive technology that eliminates boot-up display problems and optimizes resolution when switching between ports. To invoke Video DynaSync, do the following:

1. Invoke HSM (see page 28)
2. Press [**D**]

Note: When the monitor is disconnected and reconnected, the CM1164 executes Video DynaSync one more time.

Channel Editor

When Hardware Cursor Mode is enabled (via OSD, see *Hardware Cursor Mode*, page 40), the Channel Editor feature allows users to use the mouse to directly manipulate the display size and screen position of a channel, as well as change the port number assigned to it.

See *Channel Editor*, page 24 for more information on this feature.

In summary for each operation below, press [Scroll] twice, and use the mouse to:

- ◆ click and hold the port number to highlight a display channel, then drag it across the screen to a new position
- ◆ click the port number to highlight the display channel, and click again to resize according to preference
- ◆ highlight the port number of a display channel's port number that you want to change, then click the port number to which you want it changed (the two display channels will switch port numbers)

Note: Wait for the Caps Lock and Scroll Lock LEDs to flash, and the mouse icon to change when performing the operations above.

Furthermore, you can store these settings into a function key. See *FN Keys*, page 23. When the Hardware Cursor Mode is enabled, roll the mouse wheel to cycle through the Fn Keys.

Chapter 5

OSD Operation

Overview

The On-Screen Display (OSD) is a menu driven method to handle computer control and switching operations. There are three ways to display the OSD:

- ◆ Press the OSD front panel pushbutton
- ◆ Press the OSD button on the IR remote control
- ◆ Tap [Scroll Lock] twice on the console keyboard

The OSD incorporates a four level (administrator / power user / user / guest) password system. Before the OSD Main Screen displays, a login dialog box appears that asks for a password. You must provide a valid password in order to access the OSD Main Screen.



The default passwords are as follows:

- ◆ **Administrator** - 111111
- ◆ **Power User** - 222222
- ◆ **User** - 333333
- ◆ **Guest** - 000000

These passwords can be changed in the *Security* page (see page 43), except for the **Guest** account. When Security is enabled, the **Guest** account will be disabled automatically to secure the CM1164.

OSD Operation and Menu



There are three ways to cycle through the OSD menu, go to submenus, change/adjust the options and make a selection, as follows:







- ♦ **Front panel pushbuttons.** Use the Function (**Fn1~Fn4**), **Select** and **OSD** pushbuttons located on the CM1164's front panel. The **Fn1~Fn4** buttons are positioned to correspond to the up / down / left / right directions. See *Front View*, page 6.

You can configure the KVM focus using the front panel pushbuttons, and save them using the *Fn Key* page (see page 47) for later use. See *Manual Switching*, page 17 for instructions on how to switch KVM, audio and USB focus between ports. See *FN Keys*, page 23 for information on how the Fn buttons/menu options work. See page 47 for details on storing and restoring function settings using the OSD.

- ♦ **IR remote control.** See *IR Remote Control*, page 8.
- ♦ **Console mouse.** If the Hardware Cursor (see page 40) is enabled, use the mouse to navigate the OSD menu. See *Hardware Cursor Mode*, page 40.

The OSD menu options are shown in the table below. The highlighted texts indicate the CM1164's default setting.

Menu Page	Sub-Menu Page(s)	
Login Page		
Port Selection 	Select which computer/video source device is displayed by selecting the port to which it is connected.	
Mode 	Quad	See <i>Quad</i> , page 37.
	PiP Dual	See <i>Picture in Picture (Dual / Triple / Quad)</i> , page 37.
	PiP Triple	
	PiP Quad	
	Disable Channel	Port 1-4
	Quadview Resolution	See <i>Quadview Resolution</i> , page 38.
DCC 	Select which video source in the DCC installation is shown on the display.	

Menu Page	Sub-Menu Page(s)			
Setting 	System 	Hardware Cursor Mode	Enable / Disable Hardware Cursor Type	
		OSD Hotkey	Scroll Lock / Ctrl	
		Hotkey Selection Mode	[Num Lock] + [-] / [Ctrl] + [F12]	
		Video DynaSync	Enable / Reload / Default KVM EDID	
		Activate Beeper	Enable / Disable	
		Port ID Display	Port / Duration	
		OSD Language	English / German / French / Japanese / Traditional Chinese	
		Keyboard Language	French / English / Japanese	
		Auto Scan	Scan Duration / Scan Mode	
		Security	Enable	
			User Password	Password
			Power User Password	Password
			Admin User Password	Password
	Login Timeout	1 to 99 minutes		
	KVM Status	Read only information		
	DCC Control	Enable / Clone		
	Computer 	Keyboard Emulation	Enable / Disable	
		Mouse Emulation	Enable / Mouse Switching Function	
		Power On Detection	Enable / Disable	
		Set OS	Auto-Detect / MAC / Sun / SPC	
		USB Reset	Enable / Disable	
	Configuration 	Fn Key	Edit	
			Selection	
Restore Default Values		Enable / Disable		
Firmware Upgrade	Enable / Disable			
Help 	Hotkey List	Read only information		
	Info	Read only information		
Close 	Click this to close the active page.			
Exit OSD 	Click this to log out of the OSD menu.			

Port Selection

Click the *Port Selection* icon to select which computer/video source device is shown on the display screen or has the audio, KVM, and USB focus.

Select the corresponding port number of the computer/video source and click save. See *Port ID Numbering*, page 15 for more details on port numbers.

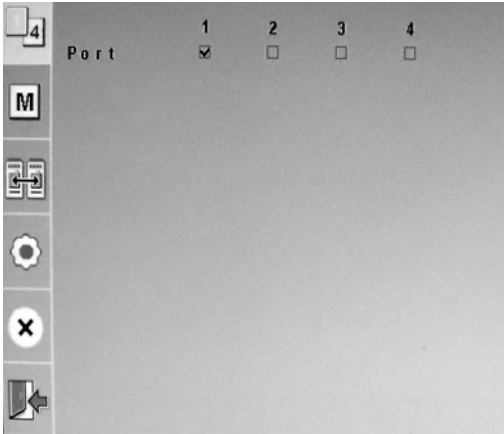

Mode Selection

Click the *Mode* icon to select the Display Mode. See *Display Modes*, page 18 for more information.

Use this page to select the Display Mode you want to use, or disable the use of channels (see *Disable Channel*, page 38.)

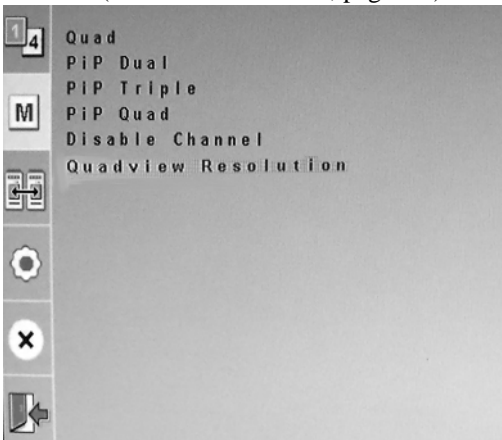

Display Modes

Click the Display Mode you want to use to go to a page where you can configure which computer(s)/source device(s) correspond to each channel, and which channels are shown in the display screen. See *Channel ID*, page 21 for information on how channels work.

Quad

Quad Mode lets you show all four computers/video sources on the display at one time. Check the port number that corresponds to each channel and click save.

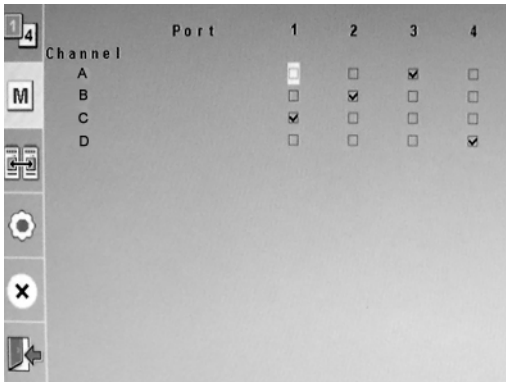

Picture in Picture (Dual / Triple / Quad)

The *Picture in Picture (PiP) Mode* lets you show two (*Dual*), three (*Triple*) or four (*Quad*) computers/video sources on the display at one time.

The *PiP Quad Mode* is shown below.

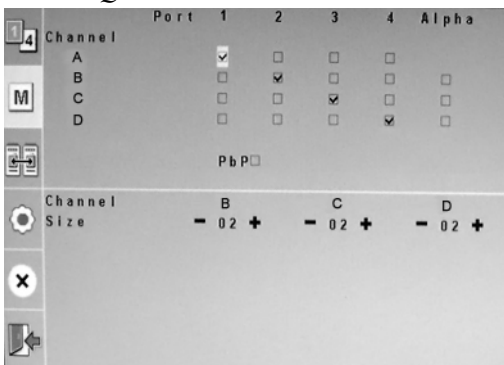

(Continues on next page.)

(Continued from previous page.)

To configure the *PiP* (*Dual / Triple / Quad*) screens, do the following steps:

1. Check the port number that corresponds to each channel.
2. **Alpha.** Checking this option affects the amount of transparency for the port's display, enabling you to see through it.
3. **PbP.** In *Picture in Picture* mode, Channel 1 takes up the whole screen while the rest of the channels are placed on the right side of the display, partially blocking Channel 1.

In order to view Channel 1 in full, check **PbP** (Picture by Picture). This shows Channel 1 in full, although in a smaller resolution that allows all the channels to fit into the display.

4. **Channel Size.** Use the minus (-) and plus (+) signs to select a channel's screen size. You can choose a value from 1 to 3 (maximum size).

Disable Channel

Check the port number that you do not want to show on screen. The corresponding channel of that port number is hidden from view.

Quadview Resolution

In *Quad* Mode, the maximum video resolution used by default is the resolution of the source device assigned to Channel A. The sizes of all the channels are resized to fit this resolution, which may cause poor video quality if the resolution is smaller than that of the source device.

To change the maximum video resolution, use this screen to select the video resolution that best fits the display. Options are as follows:

- ◆ 1280 x 720
- ◆ 1280 x 960
- ◆ 1280 x 1024
- ◆ 1360 x 768
- ◆ 1440 x 900
- ◆ 1600 x 1200
- ◆ 1680 x 1050
- ◆ 1920 x 1200
- ◆ 1920 x 1080

After choosing the desired resolution, the size of each of the four channels adjusts accordingly. For example, selecting 1600 x 1200 as the video resolution results in display windows measuring 800 x 600.

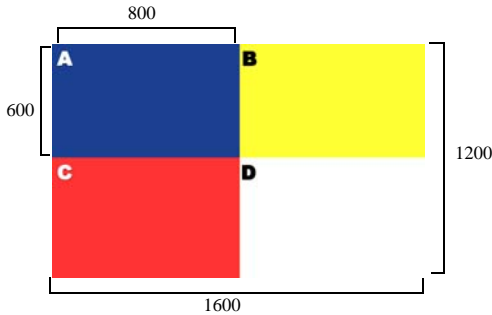

When a source device's resolution does not match the channel's video resolution, it is adjusted to fit accordingly and black space may fill the gaps.

DCC

Up to four CM1164 units can be daisy chained in one installation and users can switch between up to 16 computers/video sources. See *Daisy Chaining*, page 13 for more information.

Use the Daisy Chain Control (DCC) screen to select which video source in the installation is shown on the display. Do this by checking the station and port number to which the video source is connected.

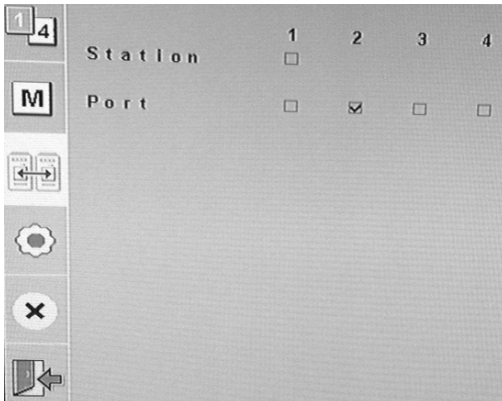

Note: Only the stations in the set up are reflected in this screen – i.e., if there are only two units in the chain, stations 3 and 4 are grayed out.

Setting

The *Setting* menu can be used to configure the CM1164, and is further divided into three pages: *System*, *Computer* and *Configuration*. There is also a *Help* submenu.

System

Use the *System* page to configure settings related to operating the OSD, optimizing the video display and securing the device.

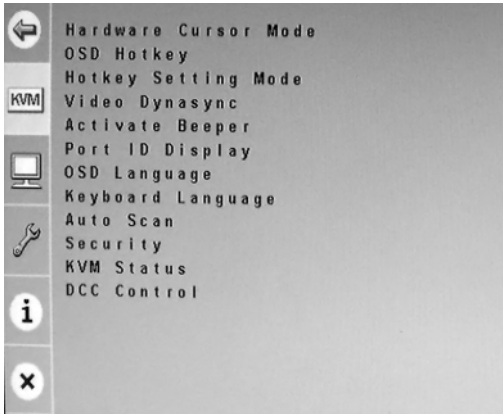

Hardware Cursor Mode

Normally, the console mouse stops functioning when the OSD is invoked. With the Hardware Cursor feature enabled, the mouse is able to work when the OSD is displayed, making it easier to navigate the menus and select menu options.

In addition, the Hardware Cursor Mode offers a flexible way to manipulate the display size and placement of a channel shown on screen, as well as change the port number assigned to it.

To take advantage of the Hardware Cursor Mode, check **Enable** and click save. For details on how to use the mouse to change the screen size/position and port number assignment, see *Channel Editor*, page 32.

Hardware Cursor Type

To distinguish between the Hardware Cursor Mode and normal PC mode, you can select the mouse pointer for when the Hardware Cursor Mode is enabled. Use this screen to choose which mouse pointer type you want to use when enabling the Hardware Cursor Mode and click Save.

OSD Hotkey

If using the *Scroll Lock* key conflicts with other programs running on the computer, the *Ctrl* key can be used to call the OSD menu. Check which hotkey you want to use and click save.

Hotkey Selection Mode

You can switch between two hotkey combinations to enable HSM: choose between [*Num Lock*] key + *minus [-]*, or [*Ctrl*] key + [*F12*], and click save.

Video DynaSync

Extended Display Identification Information (EDID) is a data format that contains a display's basic information and is used to communicate with the video source/system. The Video DynaSync feature allows devices to store a console monitor's EDID so that boot-up display problems are eliminated.

- ◆ In the *Video Dynasync* page, check **Enable** to use this feature.
- ◆ If you want the CM1164 to check and store the EDID of a console monitor at each startup, check **Reload**.
- ◆ Check **Default KVM EDID** to have the CM1164 implement the EDID of all connected displays and use the best resolution for all displays.

Click save to apply the settings immediately.

Activate Beeper

Check **Enable** to have the CM1164 make a beeping sound to indicate and confirm changes in the configuration.

Port ID Display

You can assign a different Port ID instead of using the default Port IDs (1 to 4) of each physical port. This is useful in scenarios where there are more than 4 computers/source devices, such as when daisy chaining two or more CM1164s. See *Port ID Numbering*, page 15 for more details.

- ◆ **Port.** Use the minus (-) and plus (+) signs to select a Port ID for a port. You can assign a number from 1 to 99.
- ◆ **Duration.** Use the minus (-) and plus (+) signs to set how long (in seconds) the Port ID is displayed on screen before fading out. You can assign a number for 1 to 99.

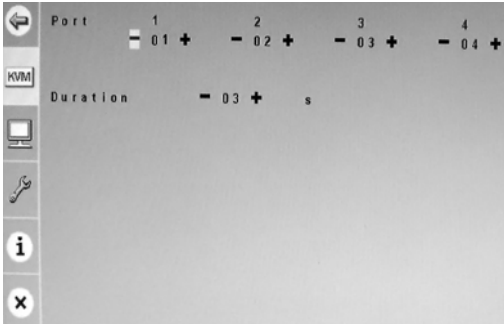

OSD Language

Select the language in which the OSD is shown. Available languages include: English, German, French, Japanese and Traditional Chinese.

Keyboard Language

Select the language in which your console keyboard is set. The choices include: English, French and Japanese.

Auto Scan

The Auto Scan feature enables the KVM focus to cycle from port to port at certain time intervals. This gives users a quick way of viewing all the computers/video sources connected to the ports.

- ◆ **Scan Duration.** Select how many seconds a port has KVM focus before the focus switches to the next port. Use the minus (-) and plus (+) signs to assign a number from 1 to 99.
- ◆ **Scan Mode.** Set whether all ports are included in the scan (check **All**) or only powered on computers/source devices (check **Powered On**).

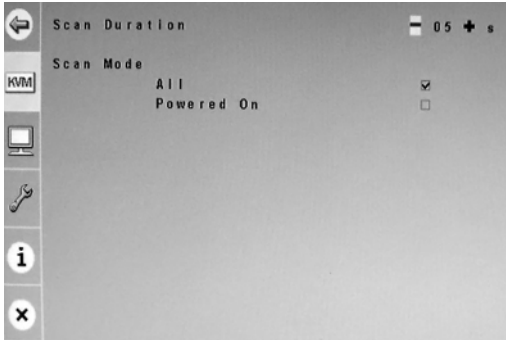

Security

You can change the passwords of the Administrator, Power User and User accounts for accessing the CM1164 OSD screens. To do this, check **Enable** and click on the account you want to edit. Enter the new password (6 digits, numeric characters 0 to 9) and click save.

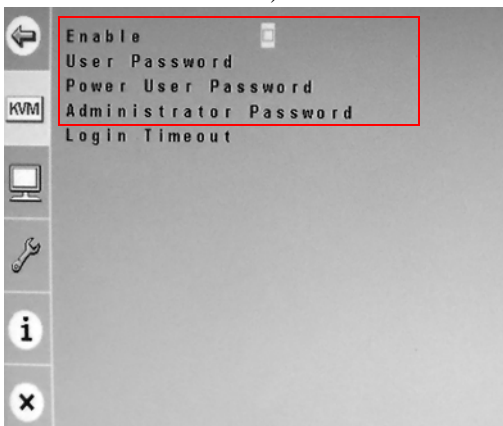

When Security is enabled, the Guest account will be disabled automatically.

Login Timeout

When the CM1164 is not in use, set how long the CM1164 waits (in minutes) before it automatically logs out. Use the minus (-) and plus (+) signs to assign a number from 1 to 99.

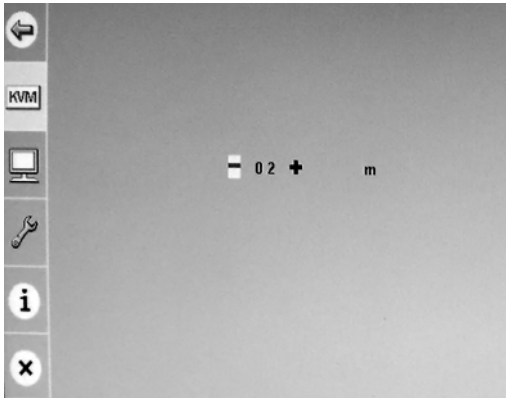

KVM Status

This read-only page shows useful information about the CM1164, including: the operating systems of computers connected to the ports; whether or not keyboard and mouse emulation, mouse port switching, and Power On Detection features are enabled; as well as the keyboard layout.

DCC Control

When CM1164 units are daisy chained, check **Clone** to duplicate the settings of the primary CM1164 unit and deploy the same ones to the succeeding CM1164 units in the daisy chain.

See *Daisy Chaining*, page 13 for more information.

Computer

Use the *Computer* page to configure settings related to the hardware components of the CM1164 installation.

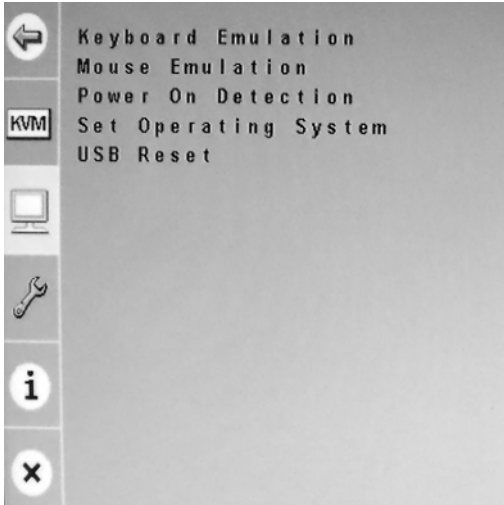

Keyboard Emulation

Check **Enable** to have the CM1164 support keyboard emulation for error-free booting and hotkey functionality. Click save.

Note: 1. PC keyboard combinations emulate Sun/Mac keyboards.

2. Sun/Mac keyboards only work with their own computers.

Mouse Emulation

Check **Enable** to have the CM1164 support mouse emulation for error-free booting.

Check **Mouse Switching Function** to enable the mouse wheel to switch between ports or FN key settings (see *F_n Key*, page 47). When mouse switching function is enabled, you simply click the mouse wheel twice to switch to the next port. Additionally, turn the mouse wheel to switch to the next FN key setting.

Note: This feature applies to 3-key USB wheel mice only.

Click save to apply the changes to the CM1164 immediately.

Power On Detection

The CM1164 has a Power On Detection feature, which means that if the computer that has KVM focus is powered off, the CM1164 automatically switches to the next powered-on computer.

Check **Enable** and click save to use this feature.

Set OS

This page lets you set the Operating System (OS) of the computer(s) attached to the port(s) to minimize compatibility issues. Check either **MAC**, **SUN** or **SPC** if the computer connected to the port runs on this particular OS. Check **Auto-Detect** to have the CM1164 automatically detect the OS of the computer.

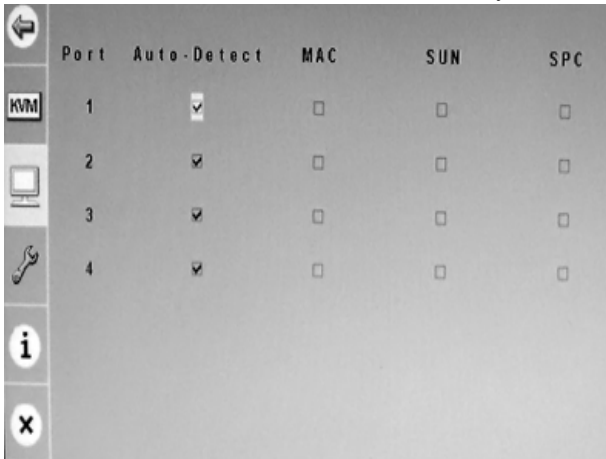

Port	Auto-Detect	MAC	SUN	SPC
1	<input checked="" type="checkbox"/>	<input type="checkbox"/>	<input type="checkbox"/>	<input type="checkbox"/>
2	<input checked="" type="checkbox"/>	<input type="checkbox"/>	<input type="checkbox"/>	<input type="checkbox"/>
3	<input checked="" type="checkbox"/>	<input type="checkbox"/>	<input type="checkbox"/>	<input type="checkbox"/>
4	<input checked="" type="checkbox"/>	<input type="checkbox"/>	<input type="checkbox"/>	<input type="checkbox"/>

USB Reset

Check **Enable** to reset the USB port(s) and have the CM1164 initialize the USB device(s) connected to port(s).

Configuration

Use the *Configuration* page to configure settings related to the CM1164's firmware.

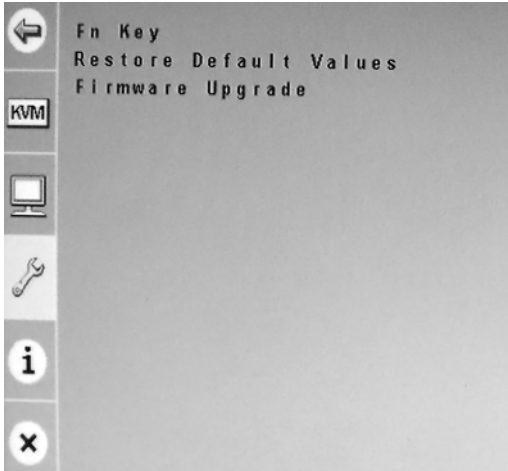

Fn Key

Use the *Fn Key* page to store display settings, and select which stored settings to display.

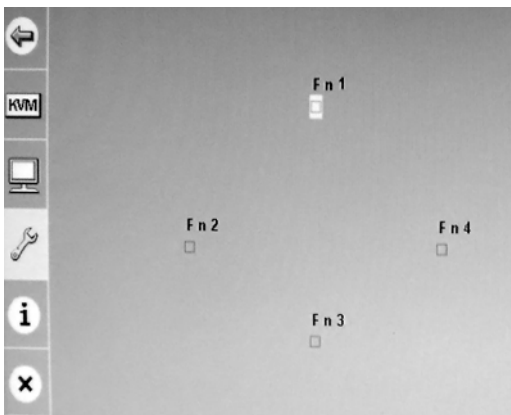

- ◆ **Edit** - This page lets you save a display configuration to a function key (Fn1~Fn4). The display configuration comprised of the ports which have the KVM, audio and USB focus, as well as the Display Mode.

Follow these steps to save a display configuration:

1. Configure which ports have the KVM, audio and USB focus. Refer to *Manual Switching*, page 17 for the steps.
 2. Select the Display Mode you want to use. See *Display Modes*, page 18 for more information.
 3. Invoke the OSD menu, and go to the *Fn Key – Edit* page. Check the function key to which you want to assign the configuration and click save.
- ♦ **Selection** - This page lets you select the function key you want the CM1164 display device to show.
Check the function key (**Fn1** to **Fn4**) that you want the CM1164 to display and click save. The configuration is displayed immediately.

Restore Default Values

Check **Enable** to restore the default factory settings of the CM1164 and click save. The default factory settings are applied on the next startup.

Firmware Upgrade

Check **Enable** to allow a firmware upgrade to the CM1164. Refer to *Firmware Upgrade*, page 49 for instructions on how to upgrade the firmware.

Help

The *Help* page shows additional details related to the CM1164, as follows:

- ♦ **Hotkey List** - this page shows a list of hotkey commands available
- ♦ **Info** - this page shows the current firmware version and copyright information

Chapter 6

Firmware Upgrade

The Windows-based Firmware Upgrade Utility (FWUpgrade.exe) provides a smooth, automated process for upgrading the CM1164's firmware. New firmware upgrade packages are posted on our Website as new firmware revisions become available. Check the web site regularly to find the latest packages and information relating to them:

<http://www.aten.com>

Before you Begin

To prepare for the Firmware Upgrade, do the following:

1. Using a computer connected to the CM1164 unit (via the DVI KVM Port Section, see *Rear View*, page 7), go to our Internet support site and choose the model name of your device (CM1164) to get a list of available Firmware Upgrade Packages.
2. Choose the Firmware Upgrade Package you want to install (usually the most recent), and download it to your computer.
3. Enable Firmware Upgrade through the OSD (see *Firmware Upgrade*, page 48). All the LEDs flash orange to indicate that Firmware Upgrade Mode is in effect.

Starting the Upgrade

1. Run the downloaded AP/Firmware Upgrade Package file – either by double clicking the file icon, or by opening a command line and entering the full path to it. If applicable, follow the on-screen instructions to input customer information. The *Firmware Upgrade Utility* Welcome screen appears:

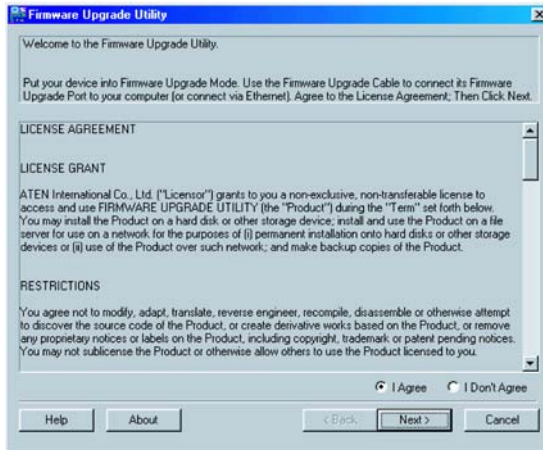

2. Read the License Agreement (enable the *I Agree* radio button), and click **Next**.

(Continues on next page.)

(Continued from previous page.)

- The Firmware Upgrade Utility main screen appears. The Utility inspects your installation. All the devices capable of being upgraded by the package are listed in the *Device List* panel.

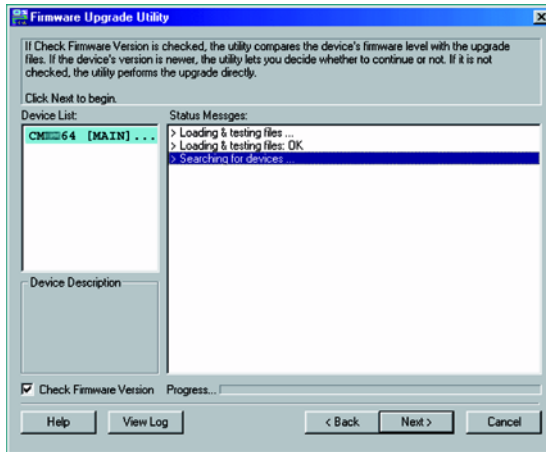

- As you select a device in the list, its description appears in the Device Description panel. After you have made your device selection, Click **Next** to perform the upgrade.

If you enabled *Check Firmware Version*, the Utility compares the device's firmware level with that of the upgrade files. If the device's version is higher than the upgrade version, a dialog box gives you the option to **Continue** or **Cancel**:

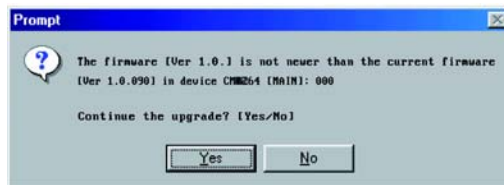

If you did not enable *Check Firmware Version*, the Utility installs the upgrade files without checking whether they are a higher level, or not.

As the Upgrade proceeds status messages appear in the Status Messages panel, and the progress toward completion is shown on the *Progress* bar.

Upgrade Succeeded

After the upgrade has completed, a screen appears to inform you that the procedure was successful:

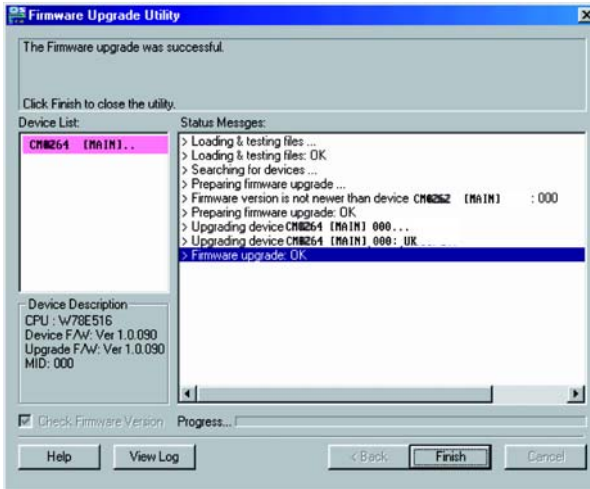

Click **Finish** to close the Firmware Upgrade Utility.

After a successful completion, the CM1164 exits Firmware Upgrade Mode, and resets itself.

Upgrade Failed

If the *Upgrade Succeeded* screen does not appear, it means that the upgrade failed to complete successfully, in which case you should do the following:

1. Power off the CM1164 by removing the power cord.
2. Invoke Firmware Upgrade Mode by holding down the front panel *Mode Selection* pushbutton (see *Components*, page 6) and power on the CM1164. The KVM LEDs flash orange together.
3. Do the firmware upgrade procedure again.

Safety Instructions

- ◆ Read all of these instructions. Save them for future reference.
- ◆ Follow all warnings and instructions marked on the device.
- ◆ Do not place the device on any unstable surface (cart, stand, table, etc.). If the device falls, serious damage will result.
- ◆ Do not use the device near water.
- ◆ Do not place the device near, or over, radiators or heat registers.
- ◆ The device cabinet is provided with slots and openings to allow for adequate ventilation. To ensure reliable operation, and to protect against overheating, these openings must never be blocked or covered.
- ◆ The device should never be placed on a soft surface (bed, sofa, rug, etc.) as this will block its ventilation openings. Likewise, the device should not be placed in a built in enclosure unless adequate ventilation has been provided.
- ◆ Never spill liquid of any kind on the device.
- ◆ Unplug the device from the wall outlet before cleaning. Do not use liquid or aerosol cleaners. Use a damp cloth for cleaning.
- ◆ The device should be operated from the type of power source indicated on the marking label. If you are not sure of the type of power available, consult your dealer or local power company.
- ◆ The device is designed for IT power distribution systems with 230V phase-to-phase voltage.
- ◆ To prevent damage to your installation, it is important that all devices are properly grounded.
- ◆ The device is equipped with a 3-wire grounding type plug. This is a safety feature. If you are unable to insert the plug into the outlet, contact your electrician to replace your obsolete outlet. Do not attempt to defeat the purpose of the grounding-type plug. Always follow your local/national wiring codes.
- ◆ Do not allow anything to rest on the power cord or cables. Route the power cord and cables so that they cannot be stepped on or tripped over.

- ◆ If an extension cord is used with this device make sure that the total of the ampere ratings of all products used on this cord does not exceed the extension cord ampere rating. Make sure that the total of all products plugged into the wall outlet does not exceed 15 amperes.
- ◆ To help protect your system from sudden, transient increases and decreases in electrical power, use a surge suppressor, line conditioner, or un-interruptible power supply (UPS).
- ◆ Position system cables and power cables carefully; Be sure that nothing rests on any cables.
- ◆ Never push objects of any kind into or through cabinet slots. They may touch dangerous voltage points or short out parts resulting in a risk of fire or electrical shock.
- ◆ Do not attempt to service the device yourself. Refer all servicing to qualified service personnel.
- ◆ If the following conditions occur, unplug the device from the wall outlet and bring it to qualified service personnel for repair.
 - ◆ The power cord or plug has become damaged or frayed.
 - ◆ Liquid has been spilled into the device.
 - ◆ The device has been exposed to rain or water.
 - ◆ The device has been dropped, or the cabinet has been damaged.
 - ◆ The device exhibits a distinct change in performance, indicating a need for service.
 - ◆ The device does not operate normally when the operating instructions are followed.
- ◆ Only adjust those controls that are covered in the operating instructions. Improper adjustment of other controls may result in damage that will require extensive work by a qualified technician to repair.

Technical Support

International

- ◆ For online technical support – including troubleshooting, documentation, and software updates: **<http://eservice.aten.com>**
- ◆ For telephone support, *Telephone Support*, page iii.

North America

Email Support		support@aten-usa.com
Online Technical Support	Troubleshooting Documentation Software Updates	http://www.aten-usa.com/support
Telephone Support		1-888-999-ATEN ext 4988

When you contact us, please have the following information ready beforehand:

- ◆ Product model number, serial number, and date of purchase.
- ◆ Your computer configuration, including operating system, revision level, expansion cards, and software.
- ◆ Any error messages displayed at the time the error occurred.
- ◆ The sequence of operations that led up to the error.
- ◆ Any other information you feel may be of help.

Specifications

Function		CM1164	
Computer Connections		4	
Port Selection		Front Panel Pushbuttons; Hotkeys; IR Remote Control; On-Screen Display (OSD)	
Connectors	Console Ports	KB	1 x USB Type A Female (Black; rear panel)
		Video	1 x Single Link DVI-D Female (White)
		Mouse	1 x USB Type A Female (Black; rear panel)
		Speaker	2 x Mini Stereo Jack Female (Green; 1 x front panel, 1 x rear panel)
		Mic.	2 x Mini Stereo Jack Female (Pink; 1 x front, 1 x rear)
		DC Control	2 x RJ-45
	Computer Ports	KB/ Mouse	4 x USB Type B Female (White)
		Video	4 x Single Link DVI-D Female (White)
		Speaker	4 x Mini Stereo Jack Female (Green)
		Mic.	4 x Mini Stereo Jack Female (Pink)
	Power		1 x IEC320 Jack
	USB 2.0 Hub		2 x USB Type A Female (White; 1 x front panel; 1 x rear panel)
	Switches	Selected	11 pushbuttons
	LEDs	KVM	4 (Orange)
Audio		4 (Green)	
USB		4 (Green)	
Emulation	Keyboard / Mouse	USB	
Video		1920 x 1200 @ 60 Hz (DVI-D)	
Scan Interval		1–99 secs. (Default: 5 secs)	
Power Consumption		100V 6.7 W 240V 13.6 W	
Environment	Operating Temp.	0–50°C	
	Storage Temp.	-20–60°C	
	Humidity	0–80% RH, Non-condensing	
Physical Properties	Housing	Metal	
	Weight	2.5 kg	
	Dimensions (L x W x H)	43.24 x 15.41 x 4.40 cm	

Troubleshooting

Operation problems can be due to a variety of causes. The first step in solving them is to make sure that all cables are securely attached and seated completely in their sockets. In addition, updating the product's firmware may solve problems that have been discovered and resolved since the prior version was released. If your product is not running the latest firmware version, we strongly recommend that you upgrade. See Chapter 6, **Firmware Upgrade**, for details.

Symptom	Possible Cause	Action
Mouse and/or Keyboard not responding.	Improper mouse and/or keyboard reset.	Unplug the cable(s) from the console port(s), then plug it/them back in.
	KVM switch needs to be reset.	Power off all devices on the installation (see safety note, page 9); power off the KVM switch; wait five seconds; then power up
USB devices not responding.	USB ports need to reset.	Unplug the device's USB cable from the USB port on the switch's rear panel, then plug it back in.
	PC or OS does not support USB 2.0.	The CM1164 has a built-in USB 2.0 hub, so does not support PCs or OS that do not support USB 2.0.
Device not recognized (Windows).	Windows timing problem.	Unplug the KVM cable from the computer's USB port; go into Windows' <i>System Settings</i> and remove the <i>Unknown Device</i> entry; plug the KVM cable back in. Windows now recognizes the device.
Cannot switch ports by pressing [Scroll Lock] twice	Keyboard is incompatible with Scroll Lock invocation.	Press Ctrl key instead.
Monitor does not display after KVM cable set is hot plugged.	Some DVI graphics cards are incompatible with cable set hot plugging.	Power off all devices on the installation (see safety note, page 9); power off the CM1164; confirm all KVM cables are properly connected; power on the CM1164; power on the computers









(Continues on next page.)

(Continued from previous page.)

Symptom	Possible Cause	Action
When switching ports, the monitor does not display.	Monitor is new or this is the first time installation.	Switch ports again and wait two or more seconds for the PC's EDID to pass to the monitor.
	The PC's EDID has not passed through to the monitor when switching ports	Use the [d] hotkey to invoke Video DynaSync one more time or switch to another PC to reconnect the CM1164. See <i>highlight the port number of a display channel's port number that you want to change, then click the port number to which you want it changed (the two display channels will switch port numbers)</i> , page 32.
The GUI connection window stalls / does not connect	The CM1164 needs to be reset.	Perform a KVM reset or reinstall the latest CM1164 software on all your computers.

Mac Keyboard Emulation







The PC compatible (101/104 key) keyboard can emulate the functions of the Mac keyboard. The emulation mappings are listed in the table below.

PC Keyboard	Mac Keyboard
[Shift]	Shift
[Ctrl]	Ctrl
	
[Ctrl] [1]	
[Ctrl] [2]	
[Ctrl] [3]	
[Ctrl] [4]	
[Alt]	Alt
[Print Screen]	F13
[Scroll Lock]	F14
	=
[Enter]	Return
[Backspace]	Delete
[Insert]	Help
[Ctrl] 	F15

Note: When using key combinations, press and release the first key (Ctrl), then press and release the activation key.

Sun Keyboard Emulation

The PC compatible (101/104 key) keyboard can emulate the functions of the Sun keyboard when the Control key [Ctrl] is used in conjunction with other keys. The corresponding functions are shown in the table below.

PC Keyboard	Sun Keyboard
[Ctrl] [T]	Stop
[Ctrl] [F2]	Again
[Ctrl] [F3]	Props
[Ctrl] [F4]	Undo
[Ctrl] [F5]	Front
[Ctrl] [F6]	Copy
[Ctrl] [F7]	Open
[Ctrl] [F8]	Paste
[Ctrl] [F9]	Find
[Ctrl] [F10]	Cut
[Ctrl] [1]	
[Ctrl] [2]	
[Ctrl] [3]	
[Ctrl] [4]	
[Ctrl] [H]	Help
	Compose
	

Note: When using key combinations, press and release the first key (Ctrl), then press and release the activation key.

Factory Default Hotkeys and Settings

Setting	Hotkey	Default
Port Switching (Default / Alternate)	[T]	[Scroll Lock] [Scroll Lock]
Invoking HSM	[H]	[Number Lock] [-]
Auto Scan Interval	[Scroll Lock] [Scroll Lock] [A] [Enter]	5 seconds
Keyboard Operating Platform	[F10]	PC Compatible
Mouse Emulation	[M]	Enabled
Keyboard Emulation	[N]	Enabled
Mouse Wheel Support	[W]	Disabled
Buzzer	[B]	Enabled
Keyboard Language	[F6] [nn] [Enter] Note: nn is the language number	English

Limited Warranty

IN NO EVENT SHALL THE DIRECT VENDOR'S LIABILITY EXCEED THE PRICE PAID FOR THE PRODUCT FROM DIRECT, INDIRECT, SPECIAL, INCIDENTAL, OR CONSEQUENTIAL DAMAGES RESULTING FROM THE USE OF THE PRODUCT, DISK, OR ITS DOCUMENTATION.

The direct vendor makes no warranty or representation, expressed, implied, or statutory with respect to the contents or use of this documentation, and especially disclaims its quality, performance, merchantability, or fitness for any particular purpose.

The direct vendor also reserves the right to revise or update the device or documentation without obligation to notify any individual or entity of such revisions, or update. For further inquiries, please contact your direct vendor.

Free Manuals Download Website

<http://myh66.com>

<http://usermanuals.us>

<http://www.somanuals.com>

<http://www.4manuals.cc>

<http://www.manual-lib.com>

<http://www.404manual.com>

<http://www.luxmanual.com>

<http://aubethermostatmanual.com>

Golf course search by state

<http://golfingnear.com>

Email search by domain

<http://emailbydomain.com>

Auto manuals search

<http://auto.somanuals.com>

TV manuals search

<http://tv.somanuals.com>