



**eco PDU PE Series
PE5216 / PE6216 / PE5324 / PE5324kJA / PE6324 /
PE6324JA2
Power Distribution Unit
User Manual**

www.aten.com

FCC, CE Information

Warning: This is a class A product. In a domestic environment this product may cause radio interference in which case the user may be required to take adequate measures.

FEDERAL COMMUNICATIONS COMMISSION INTERFERENCE STATEMENT: This equipment has been tested and found to comply with the limits for a Class A digital device, pursuant to Part 15 of the FCC Rules. These limits are designed to provide reasonable protection against harmful interference when the equipment is operated in a commercial environment. This equipment generates, uses, and can radiate radio frequency energy and, if not installed and used in accordance with the instruction manual, may cause harmful interference to radio communications. Operation of this equipment in a residential area is likely to cause harmful interference in which case the user will be required to correct the interference at his own expense.

FCC Caution: Any changes or modifications not expressly approved by the party responsible for compliance could void the user's authority to operate this equipment.

RoHS

This product is RoHS compliant.

SJ/T 11364-2006

The following contains information that relates to China.

部件名称	有毒有害物质或元素					
	铅	汞	镉	六价铬	多溴联苯	多溴二苯醚
电器部件	●	○	○	○	○	○
机构部件	○	○	○	○	○	○

- : 表示该有毒有害物质在该部件所有均质材料中的含量均在SJ/T 11363-2006规定的限量要求之下。
- : 表示符合欧盟的豁免条款, 但该有毒有害物质至少在该部件的某一均质材料中的含量超出SJ/T 11363-2006的限量要求。
- ×: 表示该有毒有害物质至少在该部件的某一均质材料中的含量超出SJ/T 11363-2006的限量要求。



User Information

Online Registration

Be sure to register your product at our online support center:

International	http://eservice.aten.com
---------------	---

Telephone Support

For telephone support, call this number:

International	886-2-8692-6959
China	86-10-5255-0110
Japan	81-3-5615-5811
Korea	82-2-467-6789
North America	1-888-999-ATEN ext 4988
United Kingdom	44-8-4481-58923

User Notice

All information, documentation, and specifications contained in this manual are subject to change without prior notification by the manufacturer. The manufacturer makes no representations or warranties, either expressed or implied, with respect to the contents hereof and specifically disclaims any warranties as to merchantability or fitness for any particular purpose. Any of the manufacturer's software described in this manual is sold or licensed *as is*. Should the programs prove defective following their purchase, the buyer (and not the manufacturer, its distributor, or its dealer), assumes the entire cost of all necessary servicing, repair and any incidental or consequential damages resulting from any defect in the software.

The manufacturer of this system is not responsible for any radio and/or TV interference caused by unauthorized modifications to this device. It is the responsibility of the user to correct such interference.

The manufacturer is not responsible for any damage incurred in the operation of this system if the correct operational voltage setting was not selected prior to operation. PLEASE VERIFY THAT THE VOLTAGE SETTING IS CORRECT BEFORE USE.

PE Device Safety Notice



- ◆ Set the maximum permissible breaker protection in the building circuitry to the current rating specified on the rating plate. Observe all national regulations and safety codes as well as deviations for breakers.
- ◆ Only connect the PE Device to a grounded power outlet or a grounded system!
- ◆ Make sure that the total current input of the connected systems does not exceed the current rating specified on the rating plate of the PE Device.
- ◆ There is a risk of explosion if the battery is replaced with an incorrect type. Dispose of used batteries according to the relevant instructions.

Package Contents

The eco PDU PE Series package consists of:

- 1 PE5216 / PE6216 / PE5324 / PE5324kJA / PE6324 / PE6324JA2 Power Distribution Unit
- 1 Power Cord (16-port models only)
- 1 Mounting Kit
- 1 User Instructions*
- 1 CD-ROM

Check to make sure that all of the components are present and in good order. If anything is missing, or was damaged in shipping, contact your dealer.

Read this manual thoroughly and follow the installation and operation procedures carefully to prevent any damage to the switch or to any other devices on the eco PDU installation.

* Features may have been added to the eco PDU since this manual was published. Please visit our website to download the most up-to-date version.

Copyright © 2014 ATEN® International Co., Ltd.

Manual Date: 2014-03-24

NRGence and the NRGence logo are registered trademarks of ATEN International Co., Ltd. All rights reserved. All other brand names and trademarks are the registered property of their respective owners.

Contents

FCC, CE Information	ii
SJ/T 11364-2006.....	ii
User Information	iii
Online Registration	iii
Telephone Support	iii
User Notice	iii
PE Device Safety Notice	iii
Package Contents	iv
About This Manual	viii
Conventions	viii
Product Information	ix

Chapter 1.

Introduction

Overview	1
Comparison Chart	3
Features	4
Power Distribution	4
Remote Access	4
Operation	4
Management	5
Security	5
eco Sensors Energy Management Software*	5
Requirements	6
Optional Accessories	7
Sensors	7
Cable Holders	7
Components	8
PE5216A / PE6216A Front View	8
PE5216B / PE5216G / PE6216B / PE6216G Front View	10
PE5324B / PE5324G / PE6324B / PE6324G Front View	12
PE5324kJA Front View	14
PE6324JA2 Front View	16
Readout Section	18

Chapter 2.

Hardware Setup

Before You Begin	19
Rack Mounting	19
PDU Placement	20
Installation	21
Securing the Cables	23
Securing the Sensors	24

Chapter 3.**Basic Operation and
First Time Setup**

Operation Methods	25
Browser	25
eco Sensors	25
SNMP	25
First Time Setup	26
Network Configuration	27
Changing the Administrator Login	28
Moving On	28

Chapter 4.**Browser Operation**

Logging In	29
The eco PDU Main Page	30
Page Components	31
Outlet Access	32
Connections	32
Configuration	35
User Management	37
Administrator Information	37
User Information	38
Log	39
The System Log Event List	39
Device Management	40
Device Configuration	40
Date/Time	46
Security	48
Login Failures	48
Working Mode	48
Account Policy	49
Login String / IP Filter / Mac Filter	50
Authentication & Authorization	53
Private Certificate	55
Maintenance	56
Firmware File	56
Backup/Restore	58

Appendix

Safety Instructions	59
General	59
Rack Mounting	61
The eco PDU's Main Power Cord	61
Securing the Power Cables	61
Technical Support	62

International	62
North America	62
IP Address Determination	63
Specifications	65
PE5216A / PE6216A	65
PE5216B / PE6216B / PE5324B / PE6324B	66
PE5216G / PE6216G / PE5324G / PE6324G	67
PE5324kJA	68
PE6324JA2	69
Administrator Login Failure	70
Limited Warranty	71

About This Manual

This User Manual is provided to help you get the most from your eco PDU system. It covers all aspects of installation, configuration and operation. An overview of the information found in the manual is provided below.

Chapter 1, *Introduction*, introduces you to the eco PDU system. Its purpose, features and benefits are presented, and its front and back panel components are described.

Chapter 2, *Hardware Setup*, provides step-by-step instructions for setting up your installation.

Chapter 3, *Basic Operation and First Time Setup*, explains the procedures that the Administrator employs to set up the eco PDU network environment, and change the default username and password.

Chapter 4, *Browser Operation*, describes how to log in to the eco PDU with an internet browser, and explains the layout and components of the eco PDU's user interface.

An Appendix, provides specifications and other technical information regarding the eco PDU.

Conventions

This manual uses the following conventions:

Monospaced	Indicates text that you should key in.
[]	Indicates keys you should press. For example, [Enter] means to press the Enter key. If keys need to be chorded, they appear together in the same bracket with a plus sign between them: [Ctrl+Alt].
1.	Numbered lists represent procedures with sequential steps.
◆	Bullet lists provide information, but do not involve sequential steps.
→	Indicates selecting the option (on a menu or dialog box, for example), that comes next. For example, Start → Run means to open the <i>Start</i> menu, and then select <i>Run</i> .
	Indicates critical information.

Product Information

For information about all NRGence products and how they can help you save money in the data center, visit NRGence on the Web or contact an ATEN Authorized Reseller. Visit ATEN on the Web for a list of locations and telephone numbers

- ◆ International – <http://www.aten.com>
- ◆ North America – <http://www.aten-usa.com>

This Page Intentionally Left Blank

Chapter 1

Introduction

Overview

As part of its NRGence line, ATEN has developed a new generation of green energy power distribution units (PDUs) to effectively increase the efficiency of data center power usage. The NRGence PE5216 / PE6216 / PE5324 / PE5324kJA / PE6324 / PE6324JA2 eco PDUs are intelligent PDUs that contain 16 or 24 AC outlets and are available in various IEC or NEMA socket configurations.

They provide secure, centralized, intelligent, power management (power on, off, cycle) of data center IT equipment (servers, storage systems, KVM switches, network devices, serial data devices, etc.), as well as the ability to monitor the center's health environment via sensors*. The basic characteristics of each model are shown in the table on page 3.

NRGence eco PDUs offer remote power control combined with real-time power measurement - allowing you to control and monitor the power status of devices attached to the PDUs, either at the PDU device or outlet level, from practically any location via a TCP/IP connection.

The power status of each outlet can be set individually, allowing users to switch each device On/Off. The eco PDU also offers comprehensive power analysis reports which can separate departments and locations, providing precise measurements of current, voltage, power and watt-hour in a real-time display.

Installation and operation is fast and easy: plugging cables into their appropriate ports and user-friendly browser-based configuration and management is all that is entailed. Since the eco PDU firmware is upgradeable over the Net, you can stay current with the latest functionality improvements simply by downloading updates from our website as they become available.

NRGence eco PDU supports any 3rd party V1, V2, V3 SNMP Manager Software and NRGence eco Sensors (eco PDU Manager Software). eco Sensors provides you with an easy method for managing multiple devices, offering an intuitive and user-friendly Graphical User Interface that allows you to configure a PDU device and monitor power status of the equipment connected to it.

(Continues on next page.)

(Continued from previous page.)

With its advanced security features and ease of operation, the eco PDU is the most convenient, most reliable, and most cost effective way to remotely manage power access for multiple computer installations and allocate power resources in the most efficient way possible.

-
- Note:** 1. Sensors are optional accessories. A sensor-enabled installation is required to generate a more complete energy-efficient data and chart. Higher sensor installation density is helpful to generate more accurate data. See *Optional Accessories*, page 7, for further information.
2. eco PDUs are primarily designed for access via Intranet; extra network security protection is suggested for Internet access usage.
-

Comparison Chart

Model	Inlet / Cord	Outlets		Metering Level	Outlet Switching	Amps		
						Per Port	Total	
PE5216A	IEC 320 C20	16	14 x NEMA 5-15R	PDU	No	12A / 16A	16A (UL), 20A (Max.)	
PE6216A			2 x NEMA 5-20R		Yes			
PE5216B			14 x IEC 320 C13		No			
PE6216B		2 x IEC 320 C19	Yes					
PE5216G			No		10A / 15A	15A (TUV-CB), 16A (Max)		
PE6216G			Yes					
PE5324B	NEMA L6-30P	24	21 x IEC 320 C13	Bank	No	12A	24A (UL), 30A (Max)	
PE6324B			3 x IEC 320 C19		Yes			
PE5324G	IEC 60309				No	10A / 15A		30A (TUV-CB), 32A (Max)
PE6324G					Yes			
PE5324kJA	NEMA L5-30P	24	24 x NEMA 5-15R Twist Lock	Bank	No	14A	30A	
PE6324JA2	NEMA L5-30P	24	24 x NEMA 5-15R	Bank	Yes	12A	24A (UL), 30A (Max)	

Note: For the complete specifications of individual models, please reference *Specifications*, page 65.

Features

Power Distribution

- ◆ Space saving 0U rack mount design with rear mounting
- ◆ IEC or NEMA outlet models
- ◆ 3 digit 7-segment front panel LED shows Current / IP Address for PDU / Bank
- ◆ Remote users can monitor PDU / Bank status via web pages on their browsers
- ◆ Safe shutdown support
- ◆ Separate power for the unit's own power and its power outlets. The user interface is still accessible even when an overload condition trips the devices' circuit breaker

Remote Access

- ◆ Remote power control via TCP/IP and a built in 10/100 Ethernet port
- ◆ Network Protocols: TCP/IP, UDP, HTTP, HTTPS, SSL, SMTP, DHCP, NTP, DNS, auto sense, Ping
- ◆ eco PDU Power Management software – eco Sensors
- ◆ Supports SNMP Manager V1, V2 & V3

Operation

- ◆ Local and Remote power outlet control (On, Off, Power Cycle) by individual outlets (PE6 models)
- ◆ Supports multiple power control methods – Wake on LAN, System after AC Back, Kill the Power
- ◆ Power-on sequencing – users can set the power on sequence and delay time for each port to allow equipment to be turned on in the proper order
- ◆ Easy setup and operation via a browser-based user interface
- ◆ Multibrowser support (IE, Mozilla, Firefox, Chrome, Safari, Opera, Netscape)
- ◆ RTC support to keep the timer running during times of no power.
- ◆ Up to 8 user accounts and 1 administrator account.

Management

- ◆ Power status measurement at the PDU/Bank level
- ◆ LED indicators for current and IP address at the PDU device and/or Bank levels.
- ◆ Real-time aggregate current, voltage, and power and power dissipation displayed in a browser-based UI for monitoring at the PDU level (PE5216 / PE6216) and at the bank level (PE5324 / PE5324kJA / PE6324 / PE6324JA2)
- ◆ Environment monitoring – supports external temperature / humidity / differential pressure sensors for rack environment monitoring
- ◆ Current and voltage threshold setting
- ◆ Naming support for outlets
- ◆ User outlet access assignment on an outlet-by-outlet basis.
- ◆ Event logging and syslog support
- ◆ Upgradeable firmware
- ◆ Multilanguage support: English, Traditional Chinese, Simplified Chinese, Japanese, German, Italian, Spanish, French, Russian, Korean, Portuguese.

Security

- ◆ Two-level password security
- ◆ Strong security features include strong password protection and advanced encryption technologies – 128 bit SSL
- ◆ Remote authentication support: RADIUS

eco Sensors Energy Management Software*

- ◆ Automatic discovery of all PE devices within the same intranet
- ◆ Remote real-time power measurement and monitoring
- ◆ Real-time environment sensor monitoring
- ◆ Plotting/monitoring of all PE devices
- ◆ Exceed threshold alert through SMTP and System log
- ◆ Power Analysis report

Note: eco Sensors is designed to work with NRGence PDUs, and is bundled with all PE series packages.

Requirements

- ◆ Browsers accessing the eco PDU unit must support SSL 128 bit encryption.
- ◆ For cold booting of attached computers, the computer's BIOS must support *Wake on LAN* or *System after AC Back*.
- ◆ For Safe Shutdown:
 - ◆ The computer must be running Windows (Windows 2000 or higher) or Linux.
 - ◆ The *Safe Shutdown* program (available by download from our website or on the software CD included), must be installed and running on the computer.

Optional Accessories

Sensors

Sensors are optional accessories. You can use the eco PDU unit without sensors. However, if you want to have complete energy management of an instrumented data center with the use of the eco PDU, you would need to use eco Sensors software and install 4 sensors for each of the racks to generate a complete energy-efficient data and chart. Higher sensor installation density is helpful to generate more accurate data. 16/24-port models have 2 sensor ports. In this case, Sensor 1 needs to be installed at the intake of the rack and sensor 2 needs to be placed at the exhaust of IT equipment of the rack. A sensor-enabled installation is required to generate a more complete energy-efficient data and chart. Higher sensor installation density is helpful to generate more accurate data. Available sensors are show in the table, below:

Sensor	Part Number
Temperature	EA1140
Temperature / Humidity	EA1240
Differential Pressure / Temperature	EA1340

Sensor Management

Sensors can be managed via the eco PDU's built-in graphical user interface (GUI) or with the NRGence eco Sensors software that can be downloaded from the ATEN website. The download link can be found on the software CD provided with the eco PDU package.

Cable Holders

Cable holders are optional accessories. For added safety, use ATEN Lok-U-Plug cable holders to secure the cables from your attached devices in place on the eco PDU unit. Use only the ATEN Lok-U-Plug cable holders that have been specifically designed to work with the eco PDU. Using any other kind of cable securing device could be highly dangerous.

Part Number	Description
2X-EA07	Lok-U-Plug Cable Holder (10 pcs)
2X-EA08	Lok-U-Plug Installation Tool (4 pcs)

Components

PE5216A / PE6216A Front View

PE5216A

PE6216A

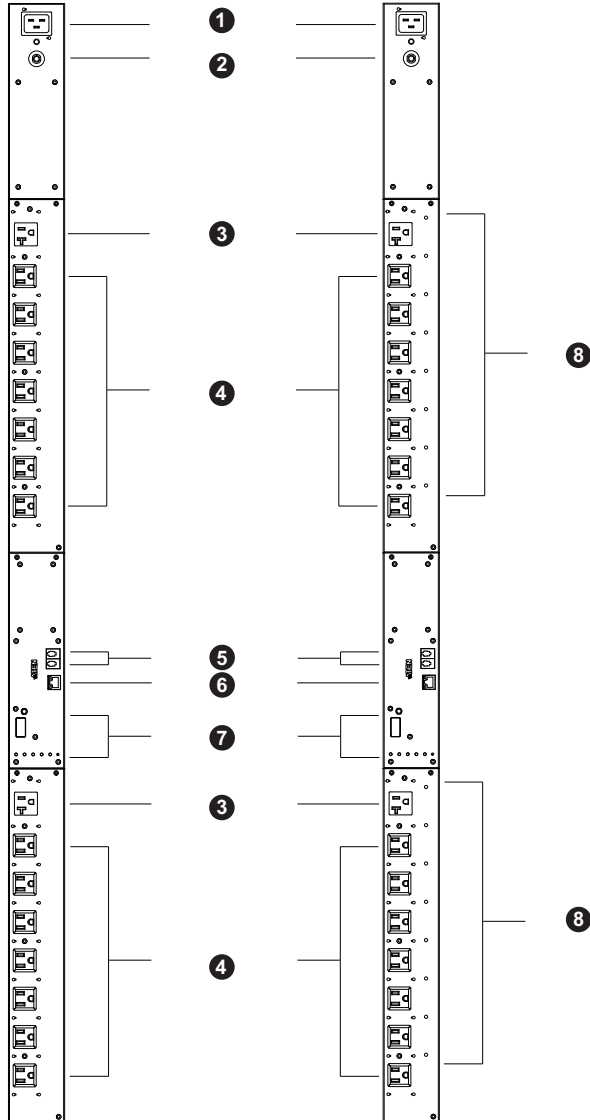

No.	Item	Description
1	Power Inlet	The power cord that connects the unit to an AC power source plugs into this IEC 320 C20 socket.
2	Circuit Breaker Pushbutton	As a safety measure, if there is an overcurrent situation regarding the device's power, the circuit breakers will trip. Press the button to recover normal operation.
3	Power Outlets*	2 x NEMA 5-20R
4		14 x NEMA 5-15R
5	Sensor Ports	External sensors plug into these two RJ-11 ports.
6	LAN Port and LEDs	<p>The cable that connects the eco PDU to the LAN plugs in here. The Link and LAN LEDs are built into the LAN port:</p> <p>Link: Lights GREEN to indicate that a connection via the eco PDU's RJ-45 Ethernet port has been established. Flashes to indicate data is being transmitted.</p> <p>LAN: Lights ORANGE to indicate 10 Mbps data transmission speed. The LED lights GREEN to indicate 100 Mbps data transmission speed.</p>
7	Readout Section, LEDs and Reset Switch	Details of this section are provided on page 18.
8	Outlet Status LEDs	[PE6216A only] These LEDs indicate outlet status. Lights ORANGE for powered on. Off for powered off.

Note: Holes for ATEN Lok-U-Plug cable holders are located around the outlets. See *Securing the Cables*, page 23, for further information.

PE5216B / PE5216G / PE6216B / PE6216G Front View

PE5216B / G

PE6216B / G

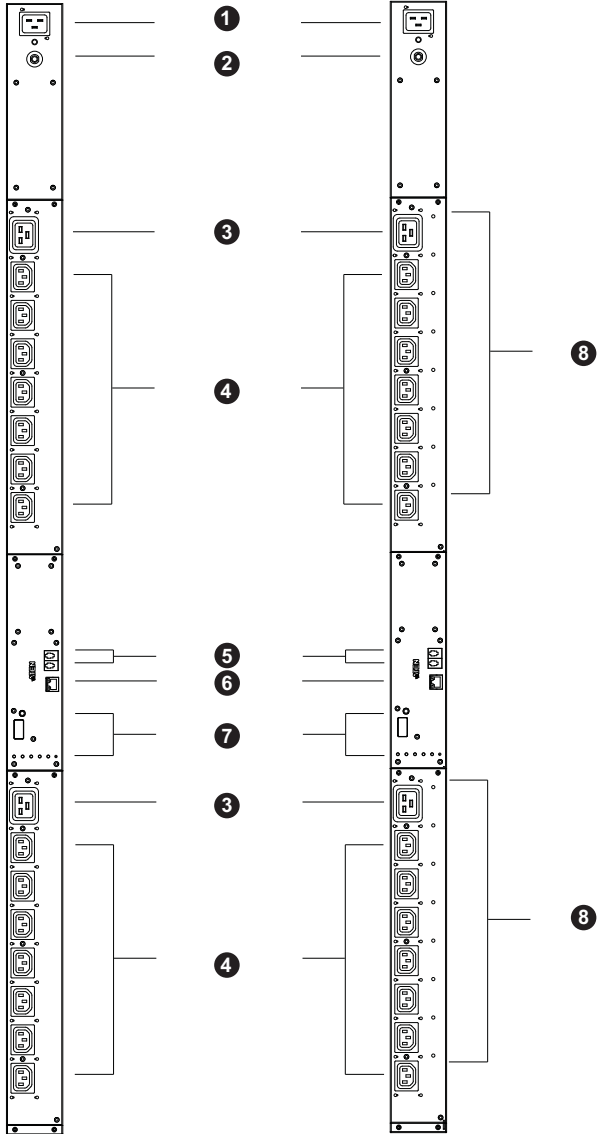

No.	Item	Description
1	Power Socket	The power cord that connects the unit to an AC power source plugs into this IEC 320 C20 socket.
2	Circuit Breaker Pushbutton	As a safety measure, if there is an overcurrent situation regarding the device's power, the circuit breakers will trip. Press the button to recover normal operation.
3	Power Sockets*	2 x IEC 320 C13
4		14 x IEC 320 C19
5	Sensor Ports	External sensors plug into these two RJ-11 ports.
6	LAN Port and LEDs	The cable that connects the eco PDU to the LAN plugs in here. The Link and LAN LEDs are built into the LAN port: Link: Lights GREEN to indicate that a connection via the eco PDU's RJ-45 Ethernet port has been established. Flashes to indicate data is being transmitted. LAN: Lights ORANGE to indicate 10 Mbps data transmission speed. The LED lights GREEN to indicate 100 Mbps data transmission speed.
7	Readout Section, LEDs and Reset Switch	Details of this section are provided on page 18.
8	Outlet Status LEDs	[PE6216 models only] These LEDs indicate outlet status. Lights ORANGE for powered on. Off for powered off.

Note: Holes for ATEN Lok-U-Plug cable holders are located around the sockets. See *Securing the Cables*, page 23, for further information.

PE5324B / PE5324G / PE6324B / PE6324G Front View

PE5324B / G

PE6324B / G

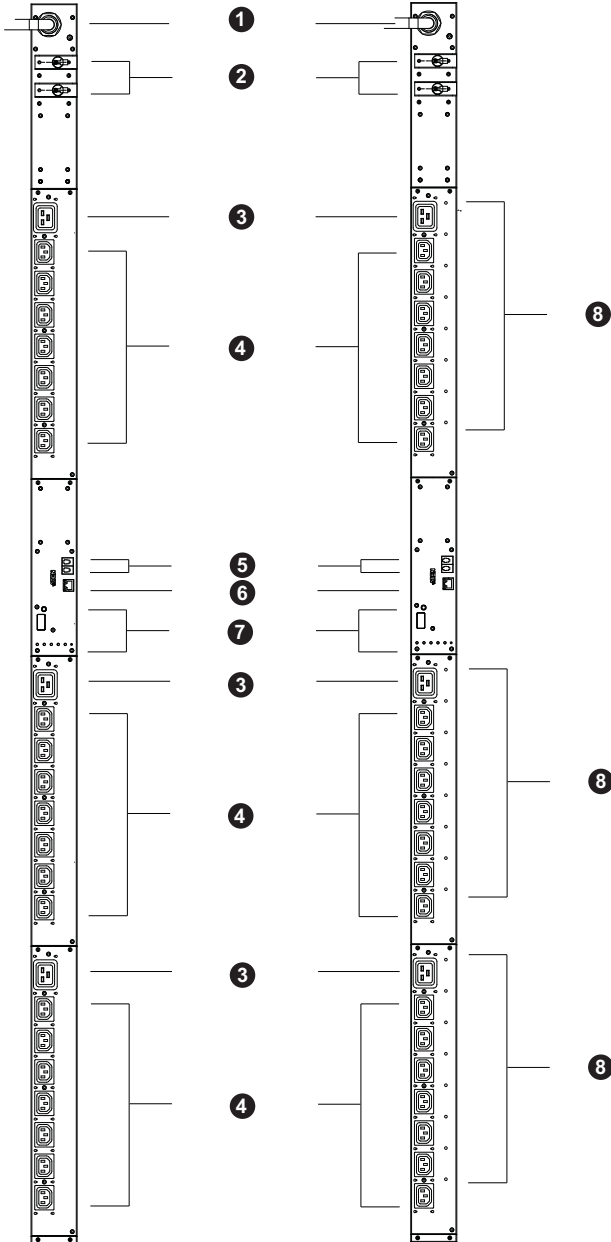

No.	Item	Description
1	Power Cord	Plug the power cord into your AC source.
2	Circuit Breakers (Bank 1 and Bank 2)	As a safety measure, if there is an overcurrent situation regarding the device's power, the circuit breakers will trip. Press the button to recover normal operation.
3, 4	Power Sockets*	3 x IEC 320 C19 21 x IEC 320 C13
5	Sensor Ports	External sensors plug into these two RJ-11 ports.
6	LAN Port and LEDs	The cable that connects the eco PDU to the LAN plugs in here. The Link and LAN LEDs are built into the LAN port: Link: Lights GREEN to indicate that a connection via the eco PDU's RJ-45 Ethernet port has been established. Flashes to indicate data is being transmitted. LAN: Lights ORANGE to indicate 10 Mbps data transmission speed. The LED lights GREEN to indicate 100 Mbps data transmission speed.
7	Readout Section, LEDs and Reset Switch	Details of this section are provided on page 18.
8	Outlet Status LEDs	[PE6324 only] These LEDs indicate outlet status. Lights ORANGE for powered on. Off for powered off.

Note: Holes for ATEN Lok-U-Plug cable holders are located around the sockets. See *Securing the Cables*, page 23, for further information.

PE5324kJA Front View

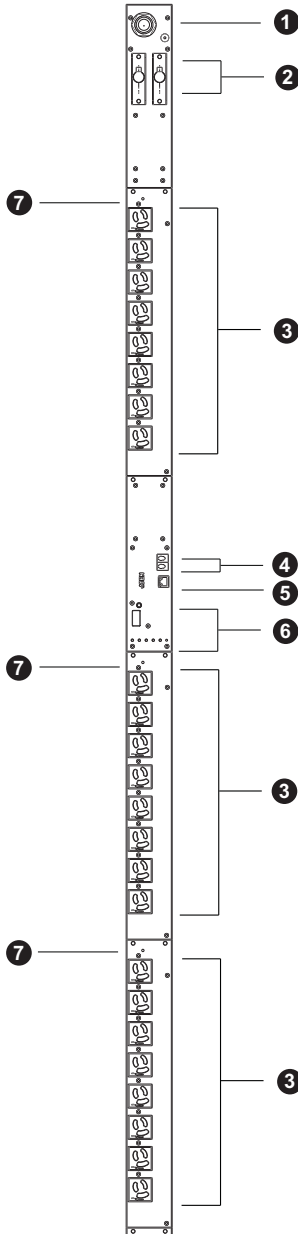

No.	Item	Description
1	Power Cord	Plug the power cord into your AC source.
2	Circuit Breakers (Bank 1 and Bank 2)	As a safety measure, if there is an overcurrent situation regarding the device's power, the circuit breakers will trip. Press the button to recover normal operation.
3	Power Sockets*	24 in total (24 x NEMA 5-15R Twist Lock) Bank 1–1: 8 x NEMA 5-15R Twist Lock Bank 1–2: 8 x NEMA 5-15R Twist Lock Bank 2: 8 x NEMA 5-15R Twist Lock
4	Sensor Ports	External sensors plug into these two RJ-11 ports.
5	LAN Port and LEDs	The cable that connects the eco PDU to the LAN plugs in here. The Link and LAN LEDs are built into the LAN port: Link: Lights GREEN to indicate that a connection via the eco PDU's RJ-45 Ethernet port has been established. Flashes to indicate data is being transmitted. LAN: Lights ORANGE to indicate 10 Mbps data transmission speed. The LED lights GREEN to indicate 100 Mbps data transmission speed.
6	Readout Section, LEDs and Reset Switch	Details of this section are provided on page 18.
7	Output Power Indicator	This LED lights steady to indicate output power for the related bank.

Note: Holes for ATEN Lok-U-Plug cable holders are located around the sockets. See *Securing the Cables*, page 23, for further information.

PE6324JA2 Front View

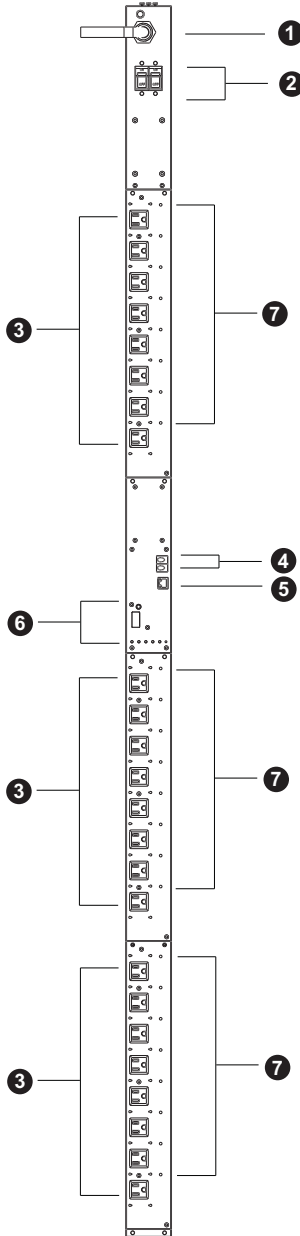

No.	Item	Description
1	Power Cord	Plug the power cord into your AC source.
2	Circuit Breakers (Bank 1 and Bank 2)	2 x 16A Slim Breakers. As a safety measure, if there is an overcurrent situation regarding the device's power, the circuit breakers will trip. Press the button to recover normal operation.
3	Power Sockets*	24 in total (24 x NEMA 5-15R) Bank 1-1: 8 x NEMA 5-15R Bank 1-2: 8 x NEMA 5-15R Bank 2: 8 x NEMA 5-15R
4	Sensor Ports	External sensors plug into these two RJ-11 ports.
5	LAN Port and LEDs	The cable that connects the eco PDU to the LAN plugs in here. The Link and LAN LEDs are built into the LAN port: Link: Lights GREEN to indicate that a connection via the eco PDU's RJ-45 Ethernet port has been established. Flashes to indicate data is being transmitted. LAN: Lights ORANGE to indicate 10 Mbps data transmission speed. The LED lights GREEN to indicate 100 Mbps data transmission speed.
6	Readout Section, LEDs and Reset Switch	Details of this section are provided on page 18.
7	Output Status LEDs	These LEDs indicate outlet status. Lights ORANGE for powered on. Off for powered off.

Note: Holes for ATEN Lok-U-Plug cable holders are located around the sockets. See *Securing the Cables*, page 23, for further information.

Readout Section

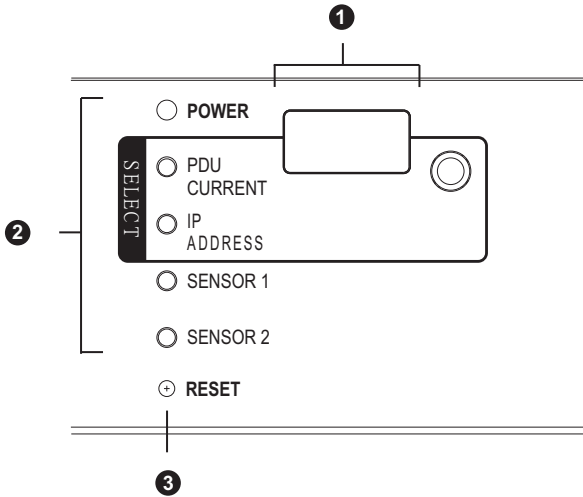

No.	Item	Description
1	Readout Section	<ul style="list-style-type: none"> ◆ The selection (PDU Current / IP Address) appears in the first part of the display window. ◆ PDU Current / IP Address appear in the second part of the display window ◆ The LEDs above the items indicate which one the readout relates to. ◆ Press the button next to the first display window to cycle the selection between the items.
2	LEDs	These LEDs indicate status for Power, PDU Current, IP address and Sensors
3	Reset Switch	<p>This switch is recessed and must be pushed with a thin object, such as the end of a paper clip.</p> <ul style="list-style-type: none"> ◆ Press and release to reboot the device. ◆ Press and hold for more that three seconds to reset the eco PDU to its factory default settings

Chapter 2

Hardware Setup

Before You Begin



1. Important safety information regarding the placement of this device is provided on page 59. Please review it before proceeding.
2. Make sure that power to all the devices you will be connecting have been turned off. You must unplug the power cords of any computers that have the Keyboard Power On function.

Rack Mounting

The eco PDU can be mounted in a 0U configuration on the side of a rack. To rack mount the device, use the rack mounting brackets that came with your device. The brackets can be mounted either near the top and bottom of the back panel, or the top and bottom ends of the device, as shown in the diagram below:

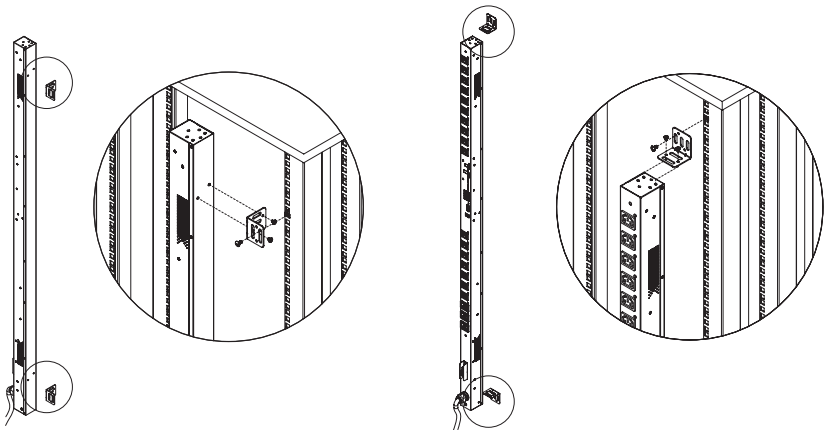

Note: The eco PDU model shown in the diagram is for rack mounting reference only.

PDU Placement

For safety reasons the eco PDU should not be installed with the power sockets facing directly up or down, and thus should only be installed with the power sockets facing out from a vertical position as shown below:

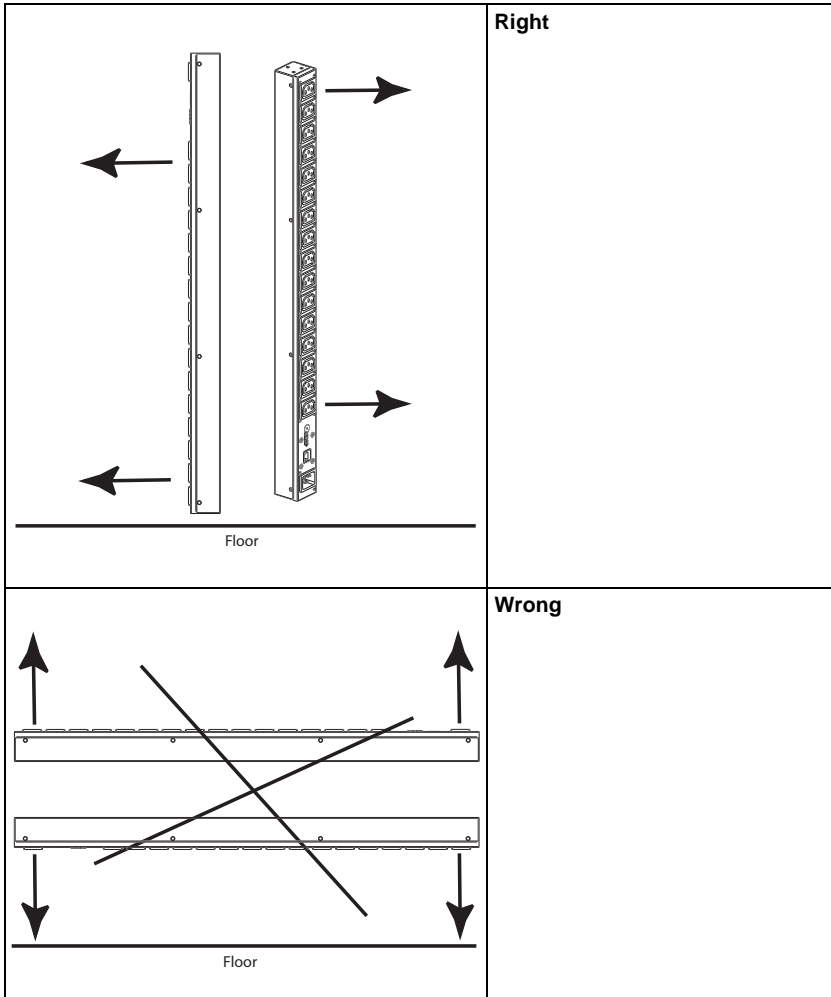

Installation

To set up your eco PDU installation, refer to the installation diagram on the next page (the numbers in the diagram correspond to the numbered steps), and do the following:

1. For each device you want to connect, use its power cable to connect from the device's AC socket to any available outlet on the eco PDU. Use ATEN Lok-U-Plug cable holders to secure them.

Note: See *Securing the Cables*, page 23, for details.

2. Plug the cable that connects the eco PDU to the LAN into the eco PDU's LAN port.
3. If you are using sensors in your eco PDU installation, connect them to the sensor ports on the unit's front panel.

Note: Sensors are optional. Please see *Optional Accessories*, page 7, and the detailed sensor installation diagrams later in this chapter for further information.

4. Connect the eco PDU's power cord to an AC power source.

Note: We strongly advise that you do not plug the eco PDU into a multi socket extension cord, since it may not receive enough amperage to operate correctly.

Once you have finished these installation steps, you can turn on the eco PDU and the connected devices.

Note: We strongly recommend using cable ties and cable bars to safely and securely route the cables attached to the front of the unit.

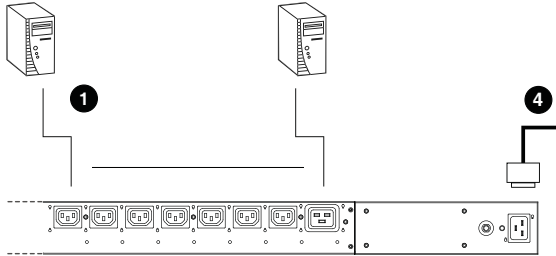
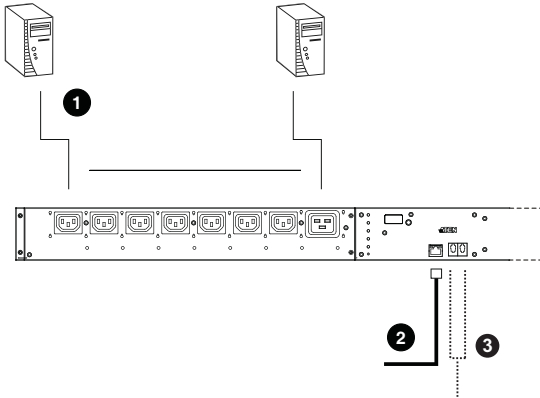

Securing the Cables

For added safety, use ATEN Lok-U-Plug cable holders to secure the cables from your attached devices in place on the eco PDU unit. Secure the cable holders using the specially designed holes around the individual power outlets, as shown below:

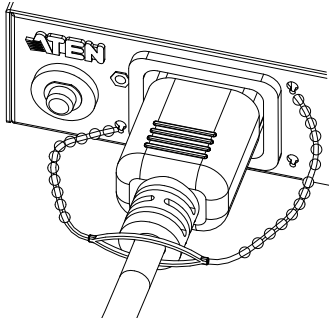

Note: 1. Cable holders are an optional accessory. See *Cable Holders*, page 7.

2. Use only the ATEN Lok-U-Plug cable holders that have been specifically designed to work with the eco PDU. Using any other kind of cable securing device could be highly dangerous.
-

Securing the Sensors

Connect the sensors to the eco PDU's front panel sensor ports and secure them using sensor mounts, tie wraps, and adhesive cable tie holders. If you use a tie wrap to secure the sensor, tighten the tie wrap over the recessed channel on the sensor, as shown in the following diagram:

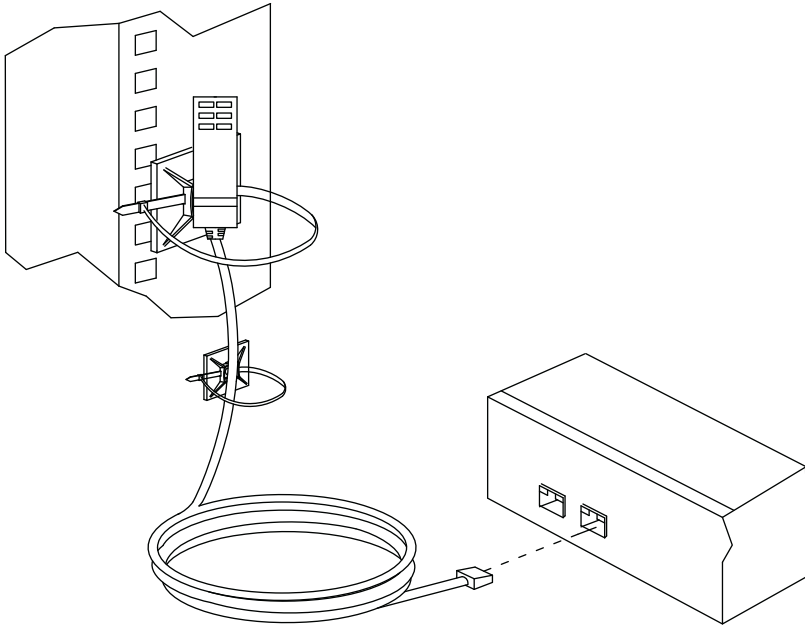

-
- Note:**
1. The sensors shown in the above diagram are for reference purposes only. The sensors for the eco PDU may look slightly different.
 2. Depending on the model and type of sensor, sensor mounts, tie wraps, and adhesive cable tie holders may or may not be provided in the package.
-

Chapter 3

Basic Operation and First Time Setup

Operation Methods

NRGence eco PDU models provide three methods to access and manage your installation: Browser, eco Sensors (eco PDU Management Software), and SNMP.

Note: The following sections of this chapter contain information concerning Browser operation. For eco Sensors operation, please reference the separate eco Sensors User Manual. The eco Sensors software and User Manual can be downloaded from the ATEN website.

Browser

NRGence s can be accessed and controlled via any supported Internet browser from any platform. See *First Time Setup*, page 26, and the following sections in this chapter, for full details.

eco Sensors

All eco PDUs support eco Sensors (eco PDU Manager Software). NRGence eco Sensors provides you with an easy method for managing multiple devices, offering an intuitive and user-friendly Graphical User Interface that allows you to configure a PDU device and monitor power status of the equipment connected to it. NRGence eco Sensors can be downloaded from the ATEN website, along with a separate eco Sensors User Manual.

SNMP

NRGence eco PDUs support any 3rd party V1, V2, V3 SNMP Manager Software. SNMP Management Information Database (MIB) files for the eco PDU device can be found on the software CD provided with the eco PDU package.

First Time Setup

Once the eco PDU installation has been cabled up, the next task the Administrator needs to perform involve configuring the network parameters, changing the default Super Administrator login settings, and adding users.

The easiest way to accomplish this is to log in over the Net with a browser.

- Note:**
1. Since this is the first time you are logging in, use the default Username: *administrator*; and the default Password: *password*. For security purposes we recommend changing them to something unique (see *Changing the Administrator Login*, page 28).
 2. For remote methods of getting logged in to the network, see *IP Address Determination*, page 63.

After you successfully log in, the eco PDU Outlet Access/Connections page appears:

The screenshot displays the web interface for the NRCgence PE6216G PDU. The interface includes a navigation menu with options like 'Outlet Access', 'Add Management', 'Log', 'Device Management', and 'Settings'. The main content area is titled 'Connections | Configuration' and shows a 'Hi administrator, welcome to the PE6216G' message. The 'PDU Status' section contains a table with the following data:

PDU Name	Measurement	Min Threshold	Max Threshold	PDU Status	
PE6216G	Aggregate current	0.04 A			
	Voltage	128.37 V			
	Power	0.0000 W			
	Aggregate power dissipation	0.0000 KWH			
	Breaker	ON			
	Power factor	0.00			
	Voltage frequency	59.00 HZ			
	Sensor 1	Temperature	N/A		
		Humidity	N/A		
		Pressure	N/A		
Sensor 2	Temperature	N/A			
	Humidity	N/A			
	Pressure	N/A			

Below the PDU Status table, there are 'ON' and 'OFF' buttons, and a 'Reset' button. The 'Outlet Status' section contains a table with the following data:

Outlet	Outlet Name	Outlet Status
[01]		ON OFF Reboot
[02]		ON OFF Reboot
[03]		ON OFF Reboot

At the bottom of the interface, there is a copyright notice: © Copyright 2012 ATR® International Co., Ltd.

Note: Operation details are discussed in *Outlet Access*, page 32, in the next chapter. For further setup information, continue with this chapter

Network Configuration

To set up the network, do the following:

1. Click the **Device Management** tab.
2. The interface displays the **Device Configuration** page. A screen similar to the one below appears:

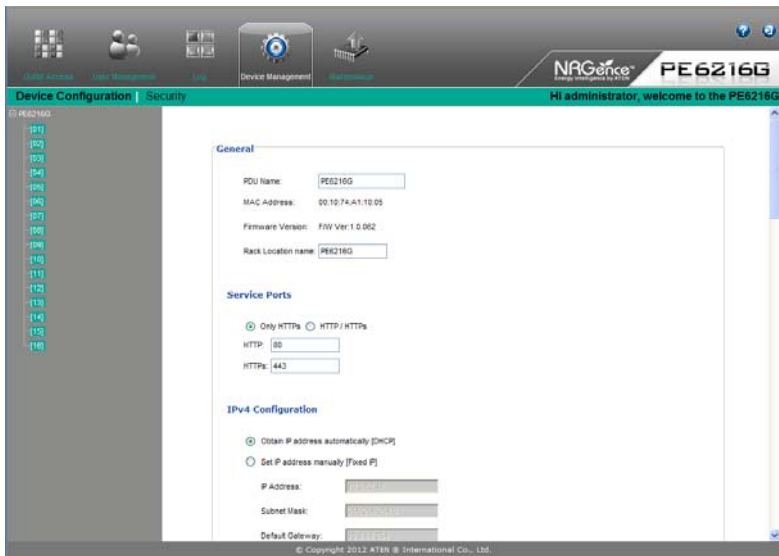

3. Fill in the fields according to the information provided under *Device Configuration*, page 40.

Changing the Administrator Login

To change the default Administrator username and password, do the following:

1. Click the **User Management** tab.

The User Management page has a detailed list of users – with more information about them – in the large central panel:

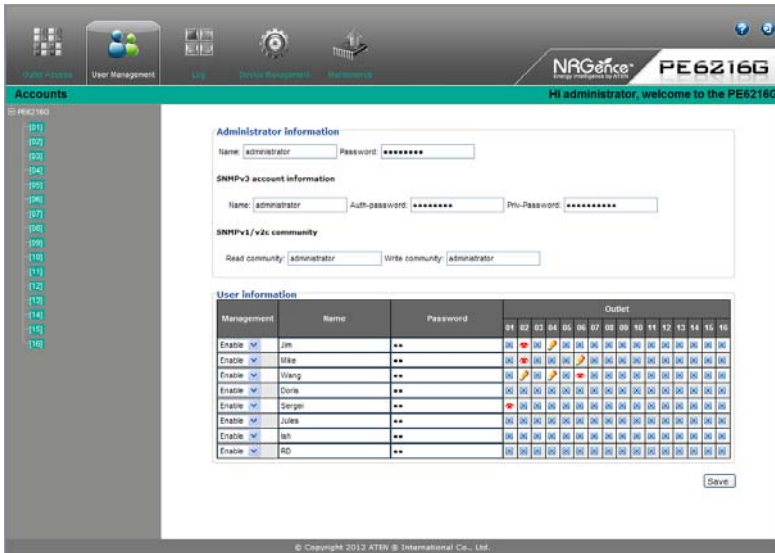

2. In the **Administrator Information** section, reset the name and password fields to something unique, then click **Save** (at the bottom of the page.)

Note: If you forget the Administrator's name or password, short the mainboard jumper to restore the default Administrator account. See *Administrator Login Failure*, page 70 in the Appendix for full details.

Moving On

After setting up the network and changing the default Administrator username and password, you can proceed to other administration activities – including adding users. This is covered in the next chapter.

Chapter 4

Browser Operation

Logging In

The eco PDU can be accessed via a supported Internet browser from any platform.

Note: Browsers must support SSL 128 bit encryption.

To access the eco PDU do the following:

1. Open your browser and specify the IP address of the eco PDU you want to access in the browser's URL location bar.

Note: You can get the IP address from the eco PDU administrator, or see *IP Address Determination*, page 63, for information about setting it up yourself.

2. If a Security Alert dialog box appears, accept the certificate – it can be trusted. The Login page appears:

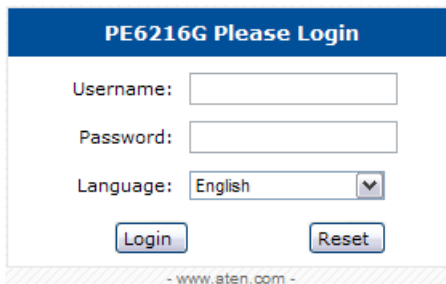

PE6216G Please Login

Username:

Password:

Language: ▼

- www.sten.com -

3. Provide a valid Username and Password (set by the eco PDU administrator), and select your language. (Options are: English [default]; Traditional Chinese; Simplified Chinese; Japanese; German; Italian; Spanish; French, Russian, Korean, Portuguese).
4. Then Click **Login** to bring up the browser Main Page.

The eco PDU Main Page

After you have successfully logged in, the eco PDU Main Page comes up with the Outlet Access *Connections* page displayed:

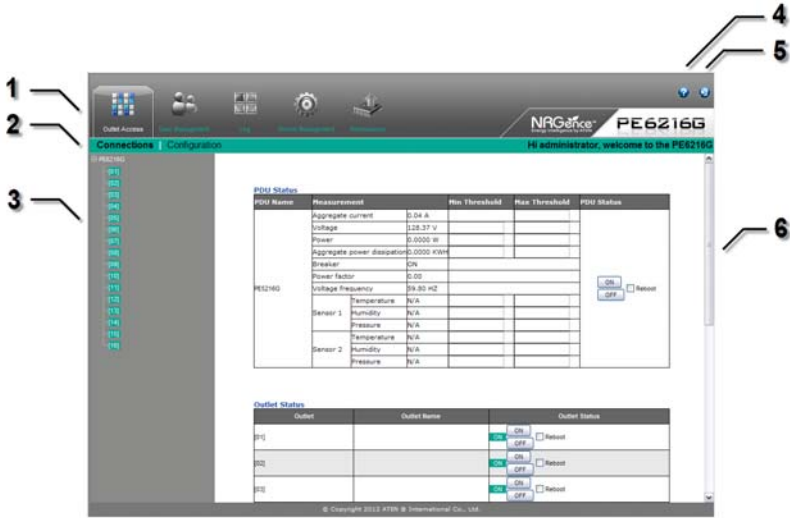

Note: The screen depicts an Administrator's page. Depending on a user's type and permissions, and your PE model, not all of these elements appear.

Page Components

The web page screen components are described in the table, below:

No.	Item	Description
1	Tab Bar	The tab bar contains the eco PDU's main operation categories. The items that appear in the tab bar are determined by the user's type, and the authorization options that were selected when the user's account was created.
2	Menu Bar	The menu bar contains operational sub-categories that pertain to the item selected in the tab bar. The items that appear in the menu bar are determined by the user's type, and the authorization options that were selected when the user's account was created.
3	Sidebar	The Sidebar provides a tree view listing of outlets that relate to the various tab bar and menu bar selections.
4	Help	Connects to on-line help at the ATEN website for the device's configuration and operation.
5	Logout	Click this button to log out of your eco PDU session.
6	Interactive Display Panel	This is your main work area. The screens that appear reflect your menu choices and Sidebar node selection.

Outlet Access

Connections

When you log in to the eco PDU, the interface opens with its default selection of the *Outlet Access* tab; and the *Connections* menu. The contents of the **PDU Status** and **Outlet Status** sections are displayed in the main panel.

The screenshot displays the NRGence PE6216G PDU web interface. The top navigation bar includes 'Outlet Access', 'Alert Management', 'Log', 'Device Management', and 'Networks'. The main content area is titled 'Connections | Configuration' and shows a 'Hi administrator, welcome to the PE6216G' message. On the left, a sidebar lists outlets [01] through [16]. The main panel is divided into two sections: 'PDU Status' and 'Outlet Status'.

PDU Status

PDU Name	Measurement	Min Threshold	Max Threshold	PDU Status	
PE6216G	Aggregate current	0.04 A		<input checked="" type="checkbox"/> ON <input type="checkbox"/> Reboot <input type="checkbox"/> OFF	
	Voltage	128.37 V			
	Power	0.0000 W			
	Aggregate power dissipation	0.0000 KW			
	Breaker	ON			
	Power factor	0.00			
	Voltage frequency	59.80 HZ			
	Sensor 1	Temperature	N/A		
		Humidity	N/A		
		Pressure	N/A		
Sensor 2	Temperature	N/A			
	Humidity	N/A			
	Pressure	N/A			

Outlet Status

Outlet	Outlet Name	Outlet Status
[01]		<input checked="" type="checkbox"/> ON <input type="checkbox"/> Reboot <input type="checkbox"/> OFF
[02]		<input checked="" type="checkbox"/> ON <input type="checkbox"/> Reboot <input type="checkbox"/> OFF
[03]		<input checked="" type="checkbox"/> ON <input type="checkbox"/> Reboot <input type="checkbox"/> OFF

© Copyright 2012 ATN @ International Co., Ltd.

Note: Only enabled eco PDU models will display the Outlet Status submenu section. Other models provide only PDU Status monitoring. See *Comparison Chart*, page 3, for which models support PDU and Outlet Status or PDU Status only monitoring.

PDU Status

All eco PDU models support PDU device level monitoring. The **PDU Status** section allows you to set up a power management configuration for the PDU device as a whole:

PDU Status

PDU Name	Measurement		Min Threshold	Max Threshold	PDU Status	
PES216G	Aggregate current	0.04 A			<input type="radio"/> ON <input type="radio"/> OFF <input type="checkbox"/> Reboot	
	Voltage	128.93 V				
	Power	0.0000 W				
	Aggregate power dissipation	0.0000 KWH				
	Breaker	ON				
	Power factor	0.00				
	Voltage frequency	59.82 HZ				
	Sensor 1	Temperature	N/A			
		Humidity	N/A			
		Pressure	N/A			
Sensor 2	Temperature	N/A				
	Humidity	N/A				
	Pressure	N/A				

■ PDU Threshold Settings

These fields are used to set the maximum, minimum, and fluctuation threshold settings for Aggregate Current, Voltage, Power, and Aggregate Power Dissipation. If a range falls below the minimum setting, or exceeds the maximum setting an alarm is triggered.

- ◆ **Breaker** status (ON / OFF) displays here.
- ◆ **Power Factor** displays a ratio between real and virtual power, providing a power performance value based on external power sources (i.e. not related to the eco PDU device).
- ◆ **Voltage Frequency** is displayed here in Hz.
- ◆ **On / Off / Reboot**

You can manually turn the device On and Off from this page by clicking the radio buttons. To Reboot the device, enable the Reboot checkbox and click on Save (located at the bottom of the page).

- ◆ **Sensor 1 / Sensor 2**

If you have sensors installed in your installation, use these fields to set the maximum, minimum, and fluctuation threshold settings for Temperature, Humidity, and Pressure.

Note: Sensors are optional accessories. Check with your dealer for information about NRGence eco Sensors software.

Outlet Status

If your eco PDU models supports outlet level power management, manual On/Off/Reboot switching can be performed on this page.

Outlet Status

Outlet	Outlet Name	Outlet Status
[01]		<input checked="" type="radio"/> ON <input type="radio"/> OFF <input type="checkbox"/> Reboot
[02]		<input type="radio"/> ON <input checked="" type="radio"/> OFF <input type="checkbox"/> Reboot
[03]		<input checked="" type="radio"/> ON <input type="radio"/> OFF <input type="checkbox"/> Reboot
[04]		<input checked="" type="radio"/> ON <input type="radio"/> OFF <input type="checkbox"/> Reboot
[05]		<input checked="" type="radio"/> ON <input type="radio"/> OFF <input type="checkbox"/> Reboot
[06]		<input checked="" type="radio"/> ON <input type="radio"/> OFF <input type="checkbox"/> Reboot
[07]		<input checked="" type="radio"/> ON <input type="radio"/> OFF <input type="checkbox"/> Reboot

■ On / Off / Reboot

You can manually turn the outlet On and Off from this page by clicking the radio buttons. To Reboot the outlet, enable the Reboot checkbox and click on Save (located at the bottom of the page).

Sidebar

When an outlet is manually powered off, its number also appears grayed-out in the side bar, as below:

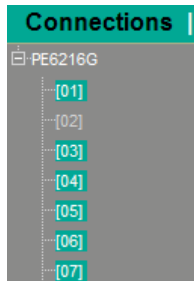

Configuration

The *Configuration* page is used to configure the settings of the eco PDU at the individual power outlet level:

Outlet Configuration

Outlet	Outlet Name	Confirmation Required	Delay Time (sec)		Remote Turn ON Method
			Power ON	Power OFF	
[01]	<input type="text"/>	<input type="checkbox"/>	<input type="text" value="0"/>	<input type="text" value="15"/>	Method: <input type="text" value="Kill the Power"/> MAC Address: <input type="text" value="000000000000"/>
[02]	<input type="text"/>	<input type="checkbox"/>	<input type="text" value="0"/>	<input type="text" value="15"/>	Method: <input type="text" value="Kill the Power"/> MAC Address: <input type="text" value="000000000000"/>
[03]	<input type="text"/>	<input type="checkbox"/>	<input type="text" value="0"/>	<input type="text" value="15"/>	Method: <input type="text" value="Kill the Power"/> MAC Address: <input type="text" value="000000000000"/>
[04]	<input type="text"/>	<input type="checkbox"/>	<input type="text" value="0"/>	<input type="text" value="15"/>	Method: <input type="text" value="Kill the Power"/> MAC Address: <input type="text" value="000000000000"/>
[05]	<input type="text"/>	<input type="checkbox"/>	<input type="text" value="0"/>	<input type="text" value="15"/>	Method: <input type="text" value="Kill the Power"/> MAC Address: <input type="text" value="000000000000"/>
[06]	<input type="text"/>	<input type="checkbox"/>	<input type="text" value="0"/>	<input type="text" value="15"/>	Method: <input type="text" value="Kill the Power"/> MAC Address: <input type="text" value="000000000000"/>
[07]	<input type="text"/>	<input type="checkbox"/>	<input type="text" value="0"/>	<input type="text" value="15"/>	Method: <input type="text" value="Kill the Power"/> MAC Address: <input type="text" value="000000000000"/>
[08]	<input type="text"/>	<input type="checkbox"/>	<input type="text" value="0"/>	<input type="text" value="15"/>	Method: <input type="text" value="Kill the Power"/> MAC Address: <input type="text" value="000000000000"/>
[09]	<input type="text"/>	<input type="checkbox"/>	<input type="text" value="0"/>	<input type="text" value="15"/>	Method: <input type="text" value="Kill the Power"/> MAC Address: <input type="text" value="000000000000"/>

This page lets you set up the power management configuration for the selected outlet. The meanings of the field headings are given in the following table

Heading	Meaning
Outlet Name	Each outlet can be given a distinctive name. The maximum number of characters is 15.
Confirmation Required	If this option is enabled (there is a check in the checkbox), a dialog box comes up asking you to confirm a power operation before it is performed. If it is disabled (there is no check in the checkbox), the operation is performed without confirmation.

(Continues on next page.)

(Continued from previous page.)

Power ON Delay	<p>Sets the amount of time the eco PDU waits after the Power Button is clicked (see <i>Outlet Status</i>, page 34), before it turns on the power to the outlet.</p> <p>Note: The default delay time is 0 seconds; the maximum is 999 seconds. When a series of outlets are scheduled to be powered up, they turn on in sequence with a default delay of 10 milliseconds between each outlet.</p>
Power OFF Delay	<p>Sets the amount of time the eco PDU waits after the Power Button is clicked (see <i>Outlet Status</i>, page 34), before it turns off the power to the outlet.</p> <p>For the <i>System after AC Back</i> option (see below), after the delay time expires, the eco PDU waits another fifteen seconds, then shuts the computer down.</p> <p>The default delay time is 15 seconds. The maximum delay time is 999 seconds.</p>
Remote Turn ON Method	<p>Use the drop-down menu to select one of the choices, below:</p> <p>Wake on LAN: This is a Safe Shutdown and Restart option. If this is selected, when an Outlet is turned Off, the eco PDU first sends a message to the computer telling it to prepare for a shutdown; it then waits for the amount time set in the <i>Power Off Delay</i> field to give the OS time to close down before the computer is powered down to standby mode.</p> <p>Likewise, when the Outlet is turned On, the eco PDU waits for the amount time set in the <i>Power On Delay</i> field, then sends an Ethernet message to the computer connected to the Outlet telling the computer to turn itself On.</p> <p>Note: For Safe Shutdown and Restart, the computer must be running Windows (98 or higher), or Linux, and the <i>Safe Shutdown</i> program (available by download from our website), must be installed and running on the computer.</p> <p>System after AC Back: This is a Safe Shutdown and Restart option. If this is selected, when an Outlet is turned Off, the eco PDU first sends a message to the computer telling it to prepare for a shutdown; it then waits for the amount time set in the <i>Power Off Delay</i> field to give the OS time to close down before the computer is powered down.</p> <p>When the Outlet is turned On, the eco PDU waits for the amount time set in the <i>Power On Delay</i> field, then sends power to the server. When the server receives the power, it turns itself on.</p> <p>Note: For Safe Shutdown and Reboot, the computer must be running Windows (98 or higher), or Linux, and the <i>Safe Shutdown</i> program (available by download from our website), must be installed and running on the computer.</p> <p>Kill the Power: If this option is selected, the eco PFDU waits for the amount time set in the <i>Power Off Delay</i> field, and then turns the Outlet's power Off. Turning the power off performs a cold (non-safe) shutdown.</p>
MAC Address	<p>In order to use either of the Safe Shutdown and Restart methods the MAC address of the computer connected to the outlet must be filled in here.</p>

When you have finished making your configuration settings, click **Save**.

User Management

When you select the *User Management* tab the screen comes up with *Administrator Information* and *User Information* displayed in the main panel. The eco PDU supports one Administrator account and up to eight User accounts.

- Note:**
1. Each account can support 2 login sessions
 2. The eco PDU supports a total of 3 concurrent login sessions.

Administrator information

Name: Password:

SNMPv3 account information

Name: Auth-password: Priv-Password:

SNMPv1/v2c community

Read community: Write community:

User information

Management	Name	Password	Outlet															
			01	02	03	04	05	06	07	08	09	10	11	12	13	14	15	16
Enable ▾	Jim	••	⊗	⊗	⊗	⊗	⊗	⊗	⊗	⊗	⊗	⊗	⊗	⊗	⊗	⊗	⊗	
Enable ▾	Mike	••	⊗	⊗	⊗	⊗	⊗	⊗	⊗	⊗	⊗	⊗	⊗	⊗	⊗	⊗	⊗	
Enable ▾	Wang	••	⊗	⊗	⊗	⊗	⊗	⊗	⊗	⊗	⊗	⊗	⊗	⊗	⊗	⊗	⊗	
Disable ▾	Boris	••	⊗	⊗	⊗	⊗	⊗	⊗	⊗	⊗	⊗	⊗	⊗	⊗	⊗	⊗	⊗	
Enable ▾	Sergei	••	⊗	⊗	⊗	⊗	⊗	⊗	⊗	⊗	⊗	⊗	⊗	⊗	⊗	⊗	⊗	
Enable ▾	Jules	••	⊗	⊗	⊗	⊗	⊗	⊗	⊗	⊗	⊗	⊗	⊗	⊗	⊗	⊗	⊗	
Enable ▾	Ish	••	⊗	⊗	⊗	⊗	⊗	⊗	⊗	⊗	⊗	⊗	⊗	⊗	⊗	⊗	⊗	
Enable ▾	RD	••	⊗	⊗	⊗	⊗	⊗	⊗	⊗	⊗	⊗	⊗	⊗	⊗	⊗	⊗	⊗	

Administrator Information

This section is used to set the Administrator name and password. Only Administrators can view this section. For details, see *Changing the Administrator Login*, page 28.



User Information

To add a user, do the following:

1. Select the user type in the Management drop-down menu.
2. Key in a name and password in the Name and Password fields.
3. Set the outlet-by-outlet permissions of the user in the Outlet field.
4. Set the Management field to *Enable*.
5. Click *Save* to save your settings.

Note: Values must be entered in both the Name and Password fields in order to enable an account.

The various options are explained in more detail in the following table:

Field	Description	
Management	The Management field allows you to Enable or Disable a user's account: <ul style="list-style-type: none"> ◆ Enable – stores the user account (see <i>User Information</i>, page 38) ◆ Disable – disables the user account 	
Name	From 1 to 16 characters are allowed depending on the Account Policy settings. See <i>Account Policy</i> , page 49.	
Password	From 1 to 16 characters are allowed depending on the Account Policy settings. See <i>Account Policy</i> , page 49.	
Outlet	This field allows you to set the outlet-by-outlet permissions of the user. Click on the user/port icon to cycle through the three permissions options, as follows:	
		User has complete access to this outlet.
		User has read-only access to this outlet.
		User has no access to this outlet.
Save	Click this button to save your operation or changes	

Log

The eco PDU keeps a record of transactions that take place on its installation, and stores up to 128 events at one time. The *System Log* page provides a powerful array of filters and functions that allow you to view and export the log file data, as well as be informed by email of specified events as they occur.

The System Log Event List

- ◆ Clicking on a device in the Sidebar displays its log events in the main panel's log event list.
- ◆ Clicking the **Refresh** button brings the log list up to date with the latest events.
- ◆ The entry box to the right of the Refresh button lets you set the number of events to display per page. Simply key in the number of your choice.
- ◆ The top right of the main panel shows the total number of pages in the log file, and what page you are currently viewing.
- ◆ The buttons on the bottom row function as follows:
 - ◆ **Clear** – click to erase the contents of the log event list
 - ◆ **First Page** – click to go to the first page of the log event list
 - ◆ **Previous Page** – click to move to the previous page of the log event list
 - ◆ **Next Page** – click to move to the next page of the log event list
 - ◆ **Last Page** – click to move to the last page of the log event list
 - ◆ **Export Log** – click to save the contents of the log event list to file.

Device Management

The *Device Management* page allows administrators and users with device management permission to configure and control overall eco PDU operations.

Device Configuration

This page presents information about the selected device, as described in the following sections:

General

General

PDU Name:

MAC Address: 00:10:74:A1:10:05

Firmware Version: FW Ver:1.0.060

Rack Location name:

Item	Meaning
PDU Name	This field lets you give the device a unique name. Simply delete whatever is in the text box and key in the name of your choice. Click Save (located at the bottom of the page) to save the new name.
MAC Address	This item displays the eco PDU's MAC address.
Firmware Version	This item displays the current firmware version number. You can reference it to see if there are newer versions available on the ATEN website.
Rack Location Name	This field lets you give the rack location a unique name for easy reference.

Service Ports

As a security measure, if a firewall is being used, the Administrator can specify the port numbers that the firewall will allow. If a port other than the default is used, users must specify the port number as part of the IP address when they log in. If an invalid port number (or no port number) is specified, the eco PDU will not be found.

Select whether to allow only secure browser logins, as show below:

Service Ports

Only HTTPSs
 HTTP / HTTPSs

HTTP:

HTTPS:

An explanation of the fields is given in the table below:

Field	Explanation
HTTP	The port number for a browser login. The default is 80.
HTTPS	The port number for a secure browser login. The default is 443.

- Note:**
- Valid entries for all of the Service Ports are from 1–65535.
 - The service ports cannot have the same value. You must set a different value for each one.
 - If there is no firewall (on an Intranet, for example), it doesn't matter what these numbers are set to, since they have no effect.

IPv4 Configuration

The PDU's IPv4 IP and DNS addresses (the traditional method of specifying IP addresses) can either be assigned dynamically (DHCP), or a fixed IP address can be specified.

The screenshot shows the IPv4 Configuration interface. It has a title 'IPv4 Configuration' and two main sections. The first section is for IP address assignment, with 'Obtain IP address automatically [DHCP]' selected. Below it are three input fields: 'IP Address' (10.3.41.60), 'Subnet Mask' (255.255.255.0), and 'Default Gateway' (10.3.41.254). The second section is for DNS server address assignment, with 'Obtain DNS server address automatically' selected. Below it are two input fields: 'Preferred DNS Server' (10.0.1.6) and 'Alternate DNS Server' (0.0.0.0).

- ♦ For dynamic IP address assignment, select the *Obtain IP address automatically* radio button. (This is the default setting.)
- ♦ To specify a fixed IP address, select the *Set IP address manually* radio button and fill in the IP address with values appropriate for your network.
- ♦ For automatic DNS Server address assignment, select the *Obtain DNS Server address automatically* radio button.
- ♦ To specify the DNS Server address manually, select the *Set DNS server address manually* radio button, and fill in the addresses for the Preferred and Alternate DNS servers with values appropriate for your network.

Note: 1. If you choose *Obtain IP address automatically*, when the device starts up it waits to get its IP address from the DHCP server. If it hasn't obtained the address after one minute, it automatically reverts to its factory default IP address (192.168.0.60.)

2. If the device is on a network that uses DHCP to assign network addresses, and you need to ascertain its IP address, see *IP Address Determination*, page 63, for information.

3. Specifying the Alternate DNS Server address is optional.

Event Notification

The Event Notification section is divided into three sections: SMTP Settings; SNMP Trap Receivers; and Syslog Server. Each section is described below.

◆ SMTP Settings

The screenshot shows a web interface for configuring SMTP settings. At the top, it says "Event Notification" in blue. Below that is the "SMTP Server" section. There are two main options: "Enable report from the following SMTP Server" (unchecked) and "My server requires authentication" (unchecked). Under the first option, there is a text input field for "SMTP Server". Under the second option, there are four text input fields: "Account Name", "Password", "From", and "To".

To have the eco PDU device email reports from the SMTP server to you, do the following:

1. Enable the *Enable report from the following SMTP server*, and key in the IP address of your SMTP server.
2. If your server requires authentication, put a check in the *My server requires authentication* checkbox.
3. Key in the appropriate account information in the *Account Name*, *Password*, and *From* fields.

Note: Only one email address is allowed in the *From* fields, and it cannot exceed 64 characters.)

4. Key in the email address (addresses) of where you want the event reports sent to in the *To* field.

Note: If you are sending the report to more than one email address, separate the addresses with a semicolon or comma, depending on the specified mail server. The total cannot exceed 256 characters.

◆ SNMP Trap Receivers

SNMP Trap Receiver

Enable SNMP Trap SNMPv3 SNMPv2c SNMPv1

Receiver IP 1:

Service Port 1:

Community 1:

User name 1:

Auth-password 1:

Priv-Password 1:

Receiver IP 2:

Service Port 2:

Community 2:

User name 2:

Auth-password 2:

Priv-Password 2:

Up to four SNMP management stations can be specified. If you want to use SNMP trap notifications, do the following:

1. Check *Enable SNMP Trap*.
2. Select which version of SNMP you want to use.
3. Key in the IP address(es) and the service port number(s) of the computer(s) to be notified of SNMP trap events. The valid port range is 1–65535. The default port number is 162.

Note: Make sure that the port number you specify here matches the port number used by the SNMP receiver computer.

4. Key in the community value(s) if required for the SNMP version.
5. Key in the auth/privacy password(s) that correspond to each of the stations.

Syslog Server

Syslog Server

Enable Syslog Server

Server IP :

Service Port :

To record all the events that take place on eco PDU devices and write them to the eco PDU Syslog server, do the following:

1. Check **Enable Syslog Server**.
2. Key in the IP address and the port number of the Syslog server. The valid port range is 1-65535. The default port number is 514.

Date/Time

The Date/Time dialog page sets the eco PDU time parameters:

Date Time

Time Zone

(GMT-12:00) Eniwetok Kwajalein

Daylight Savings Time

Manual Input

Date : 2000-03-09 (YYYY-MM-DD)

Time : 19:24:16 (HH:MM:SS)

Sync with PC

Network Time

Enable auto adjustment

AU | ntp1.cs.mu.OZ.AU

Preferred custom server IP : 0.0.0.0

Alternate time server :

AU | ntp1.cs.mu.OZ.AU

Alternate custom server IP : 0.0.0.0

Adjust time every 1 days

Adjust Time Now

Set the parameters according to the information described below.

Time Zone

- ♦ To establish the time zone that the eco PDU is located in, drop down the *Time Zone* list and choose the city that most closely corresponds to where it is at.
- ♦ If your country or region employs Daylight Saving Time (Summer Time), check the corresponding checkbox.

Manual Input

Use this section to specify the eco PDU's date and time manually.

- ◆ Click the calendar icon and click the calendar entry for the date.
- ◆ Key the time into the Time field, using the HH:MM:SS (hours, minutes, seconds) format.

Note: This section is only enabled when *auto adjustment* (in the *Network Time* section) is disabled (the checkbox is unchecked).

As an alternative to specifying the date and time by entering them into the date and time fields, you can click to put a check in the *Sync with PC* checkbox, in which case the eco PDU will take its date and time settings from the locally connected PC.

Network Time

To have the time automatically synchronized to a network time server, do the following:

1. Check the *Enable auto adjustment* checkbox.
2. Drop down the time server list to select your preferred time server
– or –

Check the *Preferred custom server IP* checkbox, and key in the IP address of the time server of your choice.

3. If you want to configure an alternate time server, check the *Alternate time server* checkbox, and repeat step 2 for the alternate time server entries.
4. Key in your choice for the number of days between synchronization procedures.

Finishing Up

When you have finished making your settings on this page, click **Save**.

After you have saved your changes, if you want to synchronize immediately, click **Adjust Time Now**.

Security

The Security page controls access to the eco PDU device.

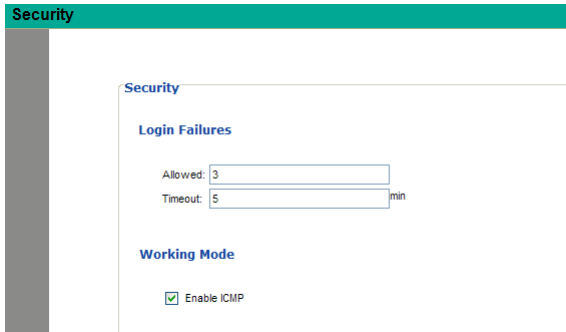

The screenshot shows a web interface for the Security page. At the top, there is a teal header bar with the word "Security" in white. Below this, on the left, is a vertical grey sidebar. The main content area is white and contains the following elements:

- A teal header bar with the word "Security" in white.
- A section titled "Login Failures" in blue text.
 - A label "Allowed:" followed by a text input field containing the number "3".
 - A label "Timeout:" followed by a text input field containing the number "5" and a "min" label to its right.
- A section titled "Working Mode" in blue text.
 - A checked checkbox followed by the text "Enable ICMP".

Login Failures

- ◆ **Allowed** sets the number of consecutive failed login attempts that are permitted from a remote user.
- ◆ **Timeout** sets the amount of time a remote user must wait before attempting to login again after exceeding the number of allowed failures.

Working Mode

- ◆ If *ICMP* is **enabled**, the eco PDU device can be pinged. If it is not enabled, the device cannot be pinged. The default is Enabled.

When you have finished making your settings on this page, click **Save**.

Account Policy

The Account Policy section governs policies in regard to usernames and passwords.

Account Policy

Minimum Username Length :

Minimum Password Length :

Password Must Contain At Least :

One Upper Case

One Lower Case

One Number

Disable Duplicate Login

Check a policy and enter the required information in the appropriate fields.

Item	Description
Minimum Username Length	Sets the minimum number of characters required for a username. Acceptable values are from 1–16.
Minimum Password Length	Sets the minimum number of characters required for a password. Acceptable values are from 1–16.
Password Must Contain At Least	Checking any of these items requires users to include at least one of the specified items in their password. Note: This policy does not affect existing user accounts. Only new user accounts created after this policy has been enabled, and users required to change their passwords are affected.
Disable Duplicate Login	Check this to prevent users from logging in with the same account at the same time.

Login String / IP Filter / Mac Filter

Login String/IP Filter

Login String :

IP Filter Enable Include Exclude

MAC Filter Enable Include Exclude

■ Login String

The *Login String* entry field is used to specify a login string (in addition to the IP address) that users must include when accessing the eco PDU device with a browser. For example:

192.168.0.126/abcdefg

- ◆ The following characters are allowed:
0–9 a–z A–Z ~ ! @ \$ * () _ ' ,
- ◆ The following characters are not allowed:
& ^ { } ' ' < > | " % " " : / ? # \ [Space] + - = [] ;

Compound characters (É Ç ñ ... etc.)

-
- Note:**
1. There must be a forward slash between the IP address and the string.
 2. If no login string is specified here, anyone will be able to access the eco PDU device login page using the IP address alone. This makes your installation less secure.
-

For security purposes, we recommend that you change this string occasionally.

■ IP Filter / MAC Filter

If any filters have been configured, they appear in the IP Filter and/or MAC Filter list boxes.

IP and MAC Filters control access to the eco PDU based on the IP and/or MAC addresses of the client computers attempting to connect. A maximum of 5 IP filters and 5 MAC filters are allowed.

To enable IP and/or MAC filtering, click to put a check mark in the *IP Filter Enable* and/or *MAC Filter Enable* checkbox.

- ◆ If the include button is checked, all the addresses within the filter range are allowed access; all other addresses are denied access.
- ◆ If the exclude button is checked, all the addresses within the filter range are denied access; all other addresses are allowed access.

Adding Filters

To add an IP filter, do the following:

1. Click **Add**. A dialog box similar to the one below appears:

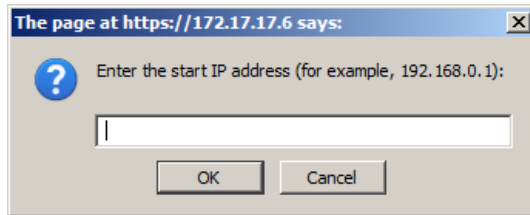

2. Specify the filter address in the dialog box (for example, 192.168.0.200), then click **OK**.

A second dialog box, similar to the one below, appears:

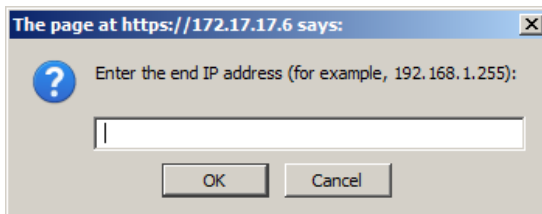

3. To filter a single IP address, key in the same address as the start IP. To filter a continuous range of addresses, key in the end number of the range (for example, 192.168.0.225).
4. After filling in the address, click **OK**.

Repeat these steps for any additional IP addresses you want to filter.

To add a MAC filter, do the following:

1. Click **Add**. A dialog box similar to the one below appears:

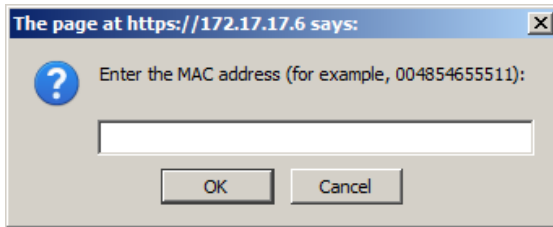

2. Specify the MAC address in the dialog box (for example, 001074670000), then click **OK**.

Repeat these steps for any additional MAC addresses you want to filter.

IP Filter / MAC Filter Conflict

If there is a conflict between an IP filter and a MAC filter – for example, where a computer’s IP address is allowed by the IP filter but its MAC address is excluded by the MAC filter – then that computer’s access is blocked.

In other words, if either filter blocks a computer, then the computer is blocked, no matter what the other filter is set to.

Modifying Filters

To modify a filter, select it in the IP Filter or MAC Filter list box and click **Modify**. The Modify dialog box is similar to the Add dialog box. When it comes up, simply delete the old address(es) and replace it with the new one(s).

Deleting Filters

To delete a filter, select it in the IP Filter or MAC Filter list box and click **Delete**.

Authentication & Authorization

The Authentication & Authorization page is used to set up login authentication and authorization management from external sources.

Authentication & Authorization

Disable Local Authentication

RADIUS Settings

Enable RADIUS

Preferred RADIUS Server IP :	<input type="text" value="0.0.0.0"/>
Preferred RADIUS Service Port :	<input type="text" value="0"/>
Alternate RADIUS Server IP :	<input type="text" value="0.0.0.0"/>
Alternate RADIUS Server Port :	<input type="text" value="0"/>
Timeout :	<input type="text" value="0"/> sec
Retries :	<input type="text" value="0"/>
Shared Secret (at least 6 characters) :	<input type="text"/>

Disable Local Authentication

Selecting this option will disable login authentication locally on the eco PDU. The device can only be accessed using RADIUS authentication.

RADIUS Settings

To allow authentication and authorization for the eco PDU device through a RADIUS server, do the following:

1. Check **Enable**.
2. Fill in the IP addresses and service port numbers for the Preferred and Alternate RADIUS servers. The default port number for the Preferred server is 1812; the default port number for the Alternate server is 1645.

Note: Make sure that the port numbers you specify here match the port numbers used by the RADIUS servers.

3. In the *Timeout* field, set the time in seconds that the eco PDU device waits for a RADIUS server reply before it times out.
4. In the *Retries* field, set the number of allowed retries for attempting to connect to the RADIUS server.
5. In the *Shared Secret* field, key in the character string that you want to use for authentication between the eco PDU device and the RADIUS Server.
6. On the RADIUS server, set the entry for each user as follows:

`su/xxxx`

Where *xxxx* represents the Username given to the user when the account was created on the eco PDU device. The user's access rights are the ones assigned for the eco PDU device, as well. (See *User Information*, page 38.)

Note: `su/user` supports view ports only; `su/administrator` supports all eco PDU functions.

Private Certificate

When logging in over a secure (SSL) connection, a signed certificate is used to verify that the user is logging in to the intended site. For enhanced security, the *Private Certificate* section allows you to use your own private encryption key and signed certificate, rather than the default ATEN certificate.

There are two methods for establishing your private certificate: generating a self-signed certificate; and importing a third-party certificate authority (CA) signed certificate.

Generating a Self-Signed Certificate

If you wish to create your own self-signed certificate, a free utility – openssl.exe – is available for download over the web.

Obtaining a CA Signed SSL Server Certificate

For the greatest security, we recommend using a third party certificate authority (CA) signed certificate. To obtain a third party signed certificate, go to a CA (Certificate Authority) website to apply for an SSL certificate. After the CA sends you the certificate and private encryption key, save them to a convenient location on your computer.

Importing the Private Certificate

To import the private certificate, do the following:

1. Click **Browse** to the right of *Private Key*; browse to where your private encryption key file is located; and select it.
2. Click **Browse** to the right of *Certificate*; browse to where your certificate file is located; and select it.
3. Click **Upload** to complete the procedure.

Note: 1. Clicking **Restore Default** returns the device to using the default ATEN certificate.

2. Both the private encryption key and the signed certificate must be imported at the same time.
-

When you have finished making your settings on this page, click **Save**.

Maintenance

The *Maintenance* function is used to upgrade the eco PDU's firmware, and to backup and restore the device's configuration settings.

Firmware File

When you click the **Maintenance** tab, the display opens with the *Firmware Upgrade* menu page, which looks similar to the one below:

Firmware File

Check Main Firmware Version

Energy Box Name	F/W Version
[PE6216G]	FW Ver:1.0.062

Filename:

Backup

Password:

Restore

Filename:

Password:

A description of the items shown in this panel are given in the table, below:

Item	Description
Check Main Firmware Version	If you enable <i>Check Main Firmware Version</i> , the eco PDU's current firmware level is compared with that of the upgrade file. If the current version is equal to or higher than the upgrade version, a popup message appears, to inform you of the situation and stops the upgrade procedure.
Name	Lists all of the eco PDU devices. Click to put a check in the checkbox of the device's whose firmware you want to upgrade.
F/W Version	Displays the eco PDU's current firmware version.
Filename	As new versions of the firmware become available, they are posted on our website and can be downloaded to a convenient location on your computer. Click the <i>Browse</i> button to select the downloaded upgrade file.
Upgrade	Click this button to upgrade the firmware of the selected devices.

■ Upgrading the Firmware

To upgrade the firmware refer to the screenshot on the preceding page, and do the following:

1. Go to our website and download the new firmware file to a convenient location on your computer.
2. Click the *Browse* button; navigate to where the firmware file is located and select it.
3. Click **Upgrade** to start the upgrade procedure.
 - ◆ If you enabled *Check Main Firmware Version* the current firmware level is compared with that of the upgrade file. If the current version is equal to or higher than the upgrade version, a popup message appears, to inform you of the situation and stops the upgrade procedure.
 - ◆ If you didn't enable *Check Main Firmware Version*, the upgrade file is installed without checking what its level is.
 - ◆ Once the upgrade completes successfully, the switch resets itself.
4. Log in again, and check the firmware version to be sure it is the new one.

■ Firmware Upgrade Recovery

Should the eco PDU's firmware upgrade procedure fail, and the device becomes unusable, the following firmware upgrade recovery procedure will resolve the problem:

1. Power off the device.
2. Press and hold the Reset Switch in (see page 8).
3. While holding the Reset Switch in, power the switch back on.

This causes the switch to use the original factory installed main firmware version. Once the switch is operational, you can try upgrading the main firmware again.

Backup/Restore

Selecting *Backup/Restore* on the menu bar gives you the ability to back up the switch's configuration and user profile information:

Backup

To backup the device's settings do the following:

1. In the *Password* field, key in a password for the file.

Note: Entering a password is optional. If you do enter a password, make a note of it, since you will need it to be able to restore the file.

2. Click **Save**.
3. When the browser asks what you want to do with the file, select *Save to disk*; then save it in a convenient location.

Restore

To restore a previous backup, do the following:

1. Click **Browse**; navigate to the file and select it.

Note: If you renamed the file, you can leave the new name. There is no need to return it to its original name.

2. In the *Password* field, key in the same password that you used to save the file.

Note: If you did not set a password when you created the backup file, you can omit this step.

3. Select as many of the options that are presented as you wish to restore.
4. Click **Restore**.

After the file is restored, a message appears to inform you that the procedure succeeded.

Safety Instructions

General

- ◆ This product is for indoor use only.
- ◆ Read all of these instructions. Save them for future reference.
- ◆ Follow all warnings and instructions marked on the device.
- ◆ Do not place the device on any unstable surface (cart, stand, table, etc.). If the device falls, serious damage will result.
- ◆ Do not use the device near water.
- ◆ Do not place the device near, or over, radiators or heat registers.
- ◆ The device cabinet is provided with slots and openings to allow for adequate ventilation. To ensure reliable operation, and to protect against overheating, these openings must never be blocked or covered.
- ◆ The device should never be placed on a soft surface (bed, sofa, rug, etc.) as this will block its ventilation openings. Likewise, the device should not be placed in a built in enclosure unless adequate ventilation has been provided.
- ◆ Never spill liquid of any kind on the device.
- ◆ Unplug the device from the wall outlet before cleaning. Do not use liquid or aerosol cleaners. Use a damp cloth for cleaning.
- ◆ The device should be operated from the type of power source indicated on the marking label. If you are not sure of the type of power available, consult your dealer or local power company.
- ◆ To prevent damage to your installation it is important that all devices are properly grounded.
- ◆ The device is equipped with a 3-wire grounding type plug. This is a safety feature. If you are unable to insert the plug into the outlet, contact your electrician to replace your obsolete outlet. Do not attempt to defeat the purpose of the grounding-type plug. Always follow your local/national wiring codes.
- ◆ The equipment should be installed near the wall socket outlet and the disconnect device (appliance coupler) should be readily accessible.
- ◆ Do not allow anything to rest on the power cord or cables. Route the power cord and cables so that they cannot be stepped on or tripped over.

- ◆ To help protect your system from sudden, transient increases and decreases in electrical power, use a surge suppressor, line conditioner, or uninterruptible power supply (UPS).
- ◆ Position system cables and power cables carefully; Be sure that nothing rests on any cables.
- ◆ When connecting or disconnecting power to hot pluggable power supplies, observe the following guidelines:
 - ◆ Install the power supply before connecting the power cable to the power supply.
 - ◆ Unplug the power cable before removing the power supply.
 - ◆ If the system has multiple sources of power, disconnect power from the system by unplugging all power cables from the power supplies.
- ◆ Never push objects of any kind into or through cabinet slots. They may touch dangerous voltage points or short out parts resulting in a risk of fire or electrical shock.
- ◆ Do not attempt to service the device yourself. Refer all servicing to qualified service personnel.
- ◆ If the following conditions occur, unplug the device from the wall outlet and bring it to qualified service personnel for repair.
 - ◆ The power cord or plug has become damaged or frayed.
 - ◆ Liquid has been spilled into the device.
 - ◆ The device has been exposed to rain or water.
 - ◆ The device has been dropped, or the cabinet has been damaged.
 - ◆ The device exhibits a distinct change in performance, indicating a need for service.
 - ◆ The device does not operate normally when the operating instructions are followed.
- ◆ Only adjust those controls that are covered in the operating instructions. Improper adjustment of other controls may result in damage that will require extensive work by a qualified technician to repair.
- ◆ Do not connect the RJ-11 connector marked “Sensor” to a public telecommunication network.

Rack Mounting

- ◆ Before working on the rack, make sure that the stabilizers are secured to the rack, extended to the floor, and that the full weight of the rack rests on the floor. Install front and side stabilizers on a single rack or front stabilizers for joined multiple racks before working on the rack.
- ◆ Always load the rack from the bottom up, and load the heaviest item in the rack first.
- ◆ Make sure that the rack is level and stable before extending a device from the rack.
- ◆ Use caution when pressing the device rail release latches and sliding a device into or out of a rack; the slide rails can pinch your fingers.
- ◆ After a device is inserted into the rack, carefully extend the rail into a locking position, and then slide the device into the rack.
- ◆ Do not overload the AC supply branch circuit that provides power to the rack. The total rack load should not exceed 80 percent of the branch circuit rating.
- ◆ Make sure that all equipment used on the rack – including power strips and other electrical connectors – is properly grounded.
- ◆ Ensure that proper airflow is provided to devices in the rack.
- ◆ Ensure that the operating ambient temperature of the rack environment does not exceed the maximum ambient temperature specified for the equipment by the manufacturer
- ◆ Do not step on or stand on any device when servicing other devices in a rack.

The eco PDU's Main Power Cord

Use the power cord supplied with this package. If it becomes necessary to replace the cord supplied with this package, be sure to use a cord of at least the same standard as the one provided.



Securing the Power Cables

To secure the cables in the eco PDU's power outlets, use only the ATEN Lock-Your-Plug cable holders that have been specifically designed to work with the eco PDU. Using any other kind of cable securing device could be highly dangerous. Please contact your ATEN dealer for information about ATEN Lock-Your-Plugs.

Technical Support

International

- ◆ For online technical support – including troubleshooting, documentation, and software updates: **<http://eservice.aten.com>**
- ◆ For telephone support, see *Telephone Support*, page iii

North America

Email Support		support@aten-usa.com
Online Technical Support	Troubleshooting Documentation Software Updates	http://www.aten-usa.com/support
Telephone Support		1-888-999-ATEN ext 4988

When you contact us, please have the following information ready beforehand:

- ◆ Product model number, serial number, and date of purchase.
- ◆ Your computer configuration, including operating system, revision level, expansion cards, and software.
- ◆ Any error messages displayed at the time the error occurred.
- ◆ The sequence of operations that led up to the error.
- ◆ Any other information you feel may be of help.

IP Address Determination

If you are an administrator logging in for the first time, you need to access the eco PDU in order to give it an IP address that users can connect to. There are two methods to choose from. In each case, your client computer must be on the same network segment as the eco PDU. After you have connected and logged in you can give the device its fixed network address. (See *Device Management*, page 40.)

Method 1:

For computers running Windows, an IP address can be determined and/or assigned with the IP Installer utility. The utility can be obtained from the *Download* area of our web site or from the software CD. Look under *Driver/SW*, and the model of your device. After downloading the utility to your computer, do the following:

1. Unzip the contents of *IPInstaller.zip* to a directory on your hard drive.
2. Go to the directory that you unzipped the IPInstaller program to and run *IPInstaller.exe*. A dialog box similar to the one below appears:

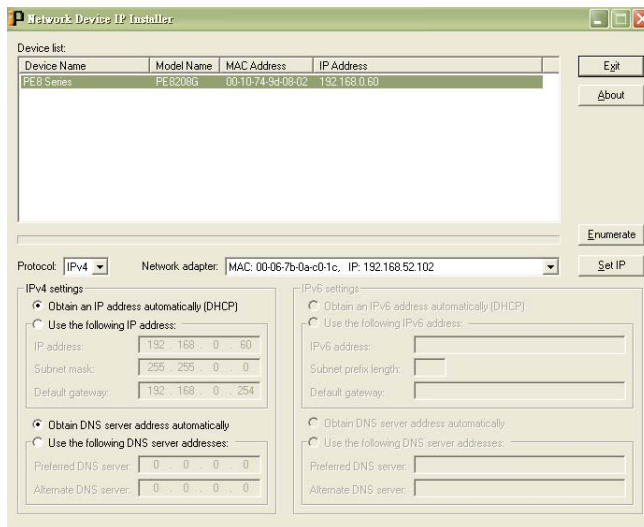

(Continues on next page.)

(Continued from previous page.)

3. Select the device in the *Device List*.

Note: 1. If the list is empty, or your device doesn't appear, click **Enumerate** to refresh the Device List.

2. If there is more than one device in the list, use the MAC address to pick the one you want. The eco PDU's MAC address is located on its bottom panel.
-

4. Select either *Obtain an IP address automatically (DHCP)*, or *Specify an IP address*. If you chose the latter, fill the IP Address, Subnet Mask, and Gateway fields with the information appropriate to your network.
5. Click **Set IP**.
6. After the IP address shows up in the Device List, click **Exit** to end the program.

Method 2:

1. Set your computer's IP address to 192.168.0.XXX
Where XXX represents any number or numbers except 60. (192.168.0.60) is the default address of the eco PDU.)
2. Specify the device's default IP address (192.168.0.60) in your browser, and you will be able to connect.
3. Assign a fixed IP address for the device (see *IPv4 Configuration*, page 42), that is suitable for the network segment that it resides on.
4. After you log out, reset your computer's IP address to its original value.
5. Once you have logged in, go to Network Settings to set up the permanent IP environment (see *IPv4 Configuration*, page 42).

Method 3:

ALTUSEN eco Sensors allows you to determine/assign an IP address in order to configure a PDU device and monitor power status of the equipment connected to it. ALTUSEN eco Sensors can be obtained from the Download area of the ATEN web site.

Specifications

PE5216A / PE6216A

Function		PE5216A	PE6216A	
Power Outlets	Direct	16		
Connectors	Power Inlet	1 x IEC 320 C20		
	Power Outlets	NEMA	14 x NEMA 5-15R; 2 x NEMA 5-20R	
		IEC	NA	
	Sensor	2 x RJ-11		
LAN	1 x RJ-45 Female (Silver) + LEDs (Orange/Green)			
LEDs	Outlet Status	NA	16 (Orange)	
	PDU Current / IP	2 (Green)		
	Current / IP Address	3-digit 7-segment (Orange)		
	Power	1 (Blue)		
	LAN	10/100M	1 (Orange / Green)	
		Link	1 (Green)	
Sensor	2 (Green)			
Switches	Reset	1 x Semi-recessed Pushbutton		
	Power	1 x Non-fuse Breaker		
Button	1 x Pushbutton			
I/P Rating	100–120V~; 50–60Hz; 16A (UL), 20A (Max.)			
Power Capacity	2.4kW			
O/P Rating	Per Port	NEMA 5-15R	100–120V~; 50–60Hz; 12A (UL), 15A (Max.)	
		NEMA 5-20R	100–120V~; 50–60Hz; 16A (UL), 20A (Max.)	
	Total	100–120V~; 50–60Hz; 16A (UL), 20A (Max.)		
Environment	Operating Temperature	0–50°C		
	Storage Temperature	-20–60°C		
	Humidity	0–80% RH Non-condensing		
Physical Properties	Housing	Metal		
	Weight	3.5 kg	3.7 kg	
	Dimensions (L x W x H)	132.48 x 6.60 x 4.40 cm		

PE5216B / PE6216B / PE5324B / PE6324B

Function		PE5216B	PE6216B	PE5324B	PE6324B	
Power Outlets	Direct	16		24		
Connectors	Power Inlet / Cord	1 x IEC 320 C20 (inlet)		1 x NEMA L6-30P (cord)		
	Power Outlets	NEMA	NA			
		IEC	14 x IEC 320 C13 2 x IEC 320 C19		21 x IEC 320 C13 3 x IEC 320 C19	
	Sensor	2 x RJ-11				
LAN	1 x RJ-45 Female (Silver) + LEDs (Orange/Green)					
LEDs	Outlet Status	NA	16 (Orange)	NA	24 (Orange)	
	PDU Current / IP	2 (Green)				
	Current / IP Address	3-digit 7-segment (Orange)				
	Power	1 (Blue)				
	LAN	10/100M	1 (Orange / Green)			
		Link	1 (Green)			
	Sensor	2 (Green)				
Switches	Reset	1 x Semi-recessed Pushbutton				
	Power	1 x Non-fuse Breaker		2 x UL 489 Breaker		
Button	1 x Pushbutton					
I/P Rating	100–240V~; 50–60Hz; 16A (UL), 20A (Max.)		100–240V~; 50–60Hz; 24A (UL), 30A (Max.)			
Power Capacity	4.2kW			6.2kW		
O/P Rating	Per Port	IEC 320 C13	100–240V~; 50–60Hz; 12A (UL), 15A (Max.)		100–240V~; 50–60Hz; 12A (UL), 15A (Max.)	
		IEC 320 C19	100–240V~; 50–60Hz; 16A (UL), 20A (Max.)		100–240V~; 50–60Hz; 12A (UL), 15A (Max.)	
	Total	100–240V~; 50–60Hz; 16A (UL), 20A (Max.)		100–240V~; 50–60Hz; 24A (UL), 30A (Max.)		
Environment	Operating Temperature	0–50°C				
	Storage Temperature	-20–60°C				
	Humidity	0–80% RH Non-condensing				
Physical Properties	Housing	Metal				
	Weight	3.5 kg	3.7 kg	6.0 kg	6.3 kg	
	Dimensions (L x W x H)	132.48 x 6.60 x 4.40 cm		177.50 x 6.60 x 4.40 cm		

PE5216G / PE6216G / PE5324G / PE6324G

Function		PE5216G	PE6216G	PE5324G	PE6324G	
Power Outlets	Direct	16		24		
Connectors	Power Inlet / Cord	1 x IEC 320 C20 (inlet)		1 x IEC 60309 (cord)		
	Power Outlets	NEMA	NA			
		IEC	14 x IEC 320 C13 2 x IEC 320 C19		21 x IEC 320 C13 3 x IEC 320 C19	
	Sensor	2 x RJ-11				
LAN	1 x RJ-45 Female (Silver) + LEDs (Orange/Green)					
LEDs	Outlet Status	NA	16 (Orange)	NA	24 (Orange)	
	Bank Current / IP	2 (Green)				
	Current / IP Address	3-digit 7-segment (Orange)				
	Power	1 (Blue)				
	LAN	10/100M	1 (Orange / Green)			
		Link	1 (Green)			
	Sensor	2 (Green)				
Switches	Reset	1 x Semi-recessed Pushbutton				
	Power	1 x Non-fuse Breaker		2 x UL 489 Breaker		
Button	1 x Pushbutton					
I/P Rating			100–240V~; 50–60Hz; 16A (Max.)	100–240V~; 50–60Hz; 32A (Max.)		
Power Capacity			3.7kW	7.4kW		
O/P Rating	Per Port	IEC 320 C13	100–240V~; 50–60Hz; 10A		100–240V~; 50–60Hz; 10A	
		IEC 320 C19	100–240V~; 50–60Hz; 15A		100–240V~; 50–60Hz; 15A	
	Total	100–240V~; 50–60Hz; 15A (Max.)		100–240V~; 50–60Hz; 30A (Max.)		
Environment	Operating Temperature	0–40°C				
	Storage Temperature	-20–60°C				
	Humidity	0–80% RH Non-condensing				
Physical Properties	Housing	Metal				
	Weight	3.5 kg	3.7 kg	6.0 kg	6.3 kg	
	Dimensions (L x W x H)	132.48 x 6.60 x 4.40 cm		177.50 x 6.60 x 4.40 cm		

PE5324kJA

Function			PE5324kJA
Power Outlets	Direct		24
Connectors	Power Cord		1 x NEMA L5-30P
	Power Outlets	NEMA	Total: 24 x NEMA 5-15R Twist Lock Bank 1-1: 8 x NEMA 5-15R Twist Lock Bank 1-2: 8 x NEMA 5-15R Twist Lock Bank 2: 8 x NEMA 5-15R Twist Lock
		IEC	NA
	Sensor		2 x RJ-11
	LAN		1 x RJ-45 Female (Silver) + LEDs (Orange/Green)
LEDs	Outlet Status		NA
	PDU Current / IP		2 (Green)
	Current / IP Address		3-digit 7-segment (Orange)
	Power		1 (Blue)
	LAN	10/100M	1 (Orange / Green)
		Link	1 (Green)
	Sensor		2 (Green)
Outlet Power Indicator		3 (Red)	
Switches	Reset		1 x Semi-recessed Pushbutton
	Power		2 x UL489 Breaker
Button			1 x Pushbutton
I/P Rating			100–120V~; 50–60Hz; 30A (Max.)
Power Capacity			3kw (Max)
O/P Rating	Per Port	NEMA 5-15R	100–120V~; 50–60Hz; 14A (PSE), 15A (Max.)
	Total		100–120V~; 50–60Hz; 30A (Max), 28A (PSE)
Environment	Operating Temperature		0–50°C
	Storage Temperature		-20–60°C
	Humidity		0–80% RH Non-condensing
Physical Properties	Housing		Metal
	Weight		6.50 kg
	Dimensions (L x W x H)		177.50 x 6.60 x 4.40 cm

PE6324JA2

Function			PE6324JA2
Power Outlets	Direct		24
Connectors	Power Cord		1 x NEMA L5-30P
	Power Outlets	NEMA	Total: 24 x NEMA 5-15R Bank 1-1: 8 x NEMA 5-15R Bank 1-2: 8 x NEMA 5-15R Bank 2: 8 x NEMA 5-15R
	Sensor		2 x RJ-11
	LAN		1 x RJ-45 Female (Silver) + LEDs (Orange/Green)
LEDs	Outlet Status		24 (Orange)
	PDU Current / IP		2 (Green)
	Current / IP Address		3-digit 7-segment (Orange)
	Power		1 (Blue)
	LAN	10/100M	1 (Orange / Green)
		Link	1 (Green)
Sensor		2 (Green)	
Switches	Reset		1 x Semi-recessed Pushbutton
	Power		2 x 16A Slim Breakers
Button			1 x Pushbutton
I/P Rating			100–120V~; 50–60Hz; 24A (UL) 30A (Max)
Power Capacity			3.6kw VA (Max) 2.9kw VA (UL de-rated)
O/P Rating	Per Port	NEMA 5-15R	100–120V~; 50–60Hz; 15A (Max); 12A (UL de-rated)
	Total		100–120V~; 50–60Hz; 24A (UL); 30A (Max)
Environment	Operating Temperature		0–50°C
	Storage Temperature		-20–60°C
	Humidity		0–80% RH Non-condensing
Physical Properties	Housing		Metal
	Weight		TBD
	Dimensions (L x W x H)		177.50 x 6.60 x 4.40 cm

Administrator Login Failure

If you are unable to perform an Administrator login (because the Username and Password information has become corrupted, or you have forgotten it, for example), you can clear the login information with the following procedure:

1. Power off the eco PDU and remove its housing.
2. Short the jumper labeled J3 (PIN10 and PIN9).

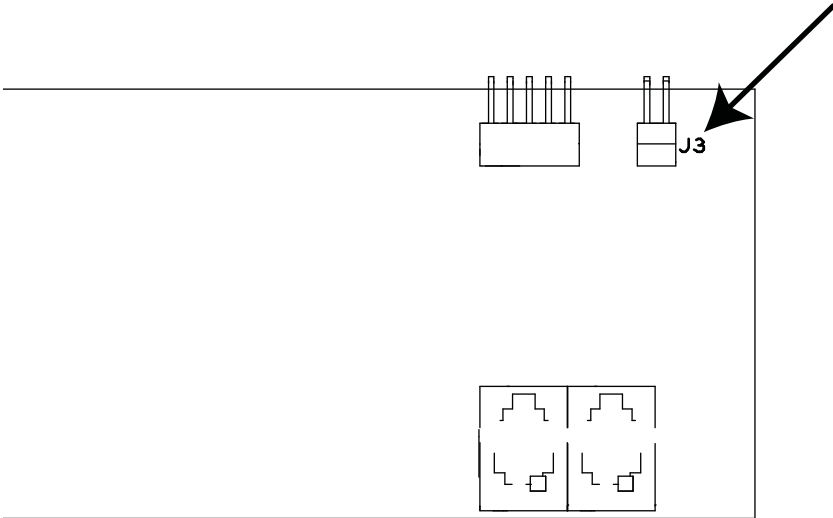

3. Power on the eco PDU.
4. After the beep indicates successfully powered on, power off the switch.
5. Remove the jumper cap from J3.
6. Close the housing and start the eco PDU.
After you start, you can use the default Username and Password to log in.

Limited Warranty

ATEN warrants this product against defects in material or workmanship for a period of one (1) year from the date of purchase. If this product proves to be defective, contact ATEN's support department for repair or replacement of your unit. ATEN will not issue a refund. Return requests can not be processed without the original proof of purchase.

When returning the product, you must ship the product in its original packaging or packaging that gives an equal degree of protection. Include your proof of purchase in the packaging and the RMA number clearly marked on the outside of the package.

This warranty becomes invalid if the factory-supplied serial number has been removed or altered on the product.

This warranty does not cover cosmetic damage or damage due to acts of God, accident, misuse, abuse, negligence or modification of any part of the product. This warranty does not cover damage due to improper operation or maintenance, connection to improper equipment, or attempted repair by anyone other than ATEN. This warranty does not cover products sold AS IS or WITH FAULTS.

IN NO EVENT SHALL ATEN'S LIABILITY EXCEED THE PRICE PAID FOR THE PRODUCT. FURTHER, ATEN SHALL NOT BE RESPONSIBLE FOR DIRECT, INDIRECT, SPECIAL, INCIDENTAL OR CONSEQUENTIAL DAMAGES RESULTING FROM THE USE OF THE PRODUCT, ITS ACCOMPANYING SOFTWARE, OR ITS DOCUMENTATION. ATEN SHALL NOT IN ANY WAY BE RESPONSIBLE FOR, WITHOUT LIMITATION, LOSS OF DATA, LOSS OF PROFITS, DOWNTIME, GOODWILL, DAMAGE OR REPLACEMENT OF EQUIPMENT OR PROPERTY, AND ANY EXPENSES FROM RECOVERY, PROGRAMMING, AND REPRODUCTION OF ANY PROGRAM OR DATA.

ATEN makes no warranty or representation, expressed, implied, or statutory with respect to its products, contents or use of this documentation and all accompanying software, and specifically disclaims its quality, performance, merchantability, or fitness for any particular purpose.

ATEN reserves the right to revise or update its product, software or documentation without obligation to notify any individual or entity of such revisions, or update.

For details about extended warranties, please contact one of our dedicated value added resellers.

This Page Intentionally Left Blank

Free Manuals Download Website

<http://myh66.com>

<http://usermanuals.us>

<http://www.somanuals.com>

<http://www.4manuals.cc>

<http://www.manual-lib.com>

<http://www.404manual.com>

<http://www.luxmanual.com>

<http://aubethermostatmanual.com>

Golf course search by state

<http://golfingnear.com>

Email search by domain

<http://emailbydomain.com>

Auto manuals search

<http://auto.somanuals.com>

TV manuals search

<http://tv.somanuals.com>