



Portable DVD Player



PD5

User Manual

**Playable Disk Format:
DVD/CD/CD-R/CD-RW**

come *play* with us
www.apexdigitalinc.com



Table of Contents

FCC and Safety Information.....	4
Important Safety Instructions.....	5
Precautions.....	6

Quick Guide

Getting to Know Your Portable DVD Player.....	7
Unpacking.....	7
Front View Diagram.....	7
Left Side Diagram.....	8
Front Side Diagram.....	8
Right Side Diagram.....	8
Remote Control Diagram.....	9
Battery Installation for the Remote Control.....	9
Remote Control Operation Range.....	10
Quick Operation Guide	11
Quick Operation.....	11
Using the Battery Pack	14
CHARGING THE BATTERY PACK	14

Chapter 1. DVD

1-1 DVD Playback	15
Basic Playback.....	15
Stopping Playback and Returning to The Menu Screen (If a Menu Is Available on The Disc).....	15
Stopping Playback.....	16
Rapid Advance (Rapid Reverse).....	16
Slow Playback.....	16
Skipping Ahead or Back to Chapters.....	16
Still Picture(PAUSE).....	16
A-B Repeat Viewing.....	17
Playing in a favorite order.....	17
1-2 Convenient functions	18
Displaying the Information of the Scene.....	18
Changing Audio Soundtrack Language.....	18
Clearing/Displaying Subtitles(A).....	18
Changing Subtitle Language(B).....	18
Activating AFF (Active Full Screen function).....	19
Viewing From Another Angle.....	19
To Mute the DVD Player.....	20
Using a DVD Menu.....	20
Using the Menu Function.....	20
Selecting Scenes by Title/Chapter Number.....	21
Selecting Scenes by Time.....	21

Table of Contents-continued

Chapter 2. Audio CD

2-1 Audio CD Playback.....	22
Basic Playback.....	22
Stopping Playback.....	22
Rapid Advance (Rapid Reverse).....	22
Skipping Ahead or Back to Tracks.....	23
Pause Playback.....	23
2-2 Display [Audio CDs].....	23
Clearing/Displaying the Information of the Playing Track.....	23

Chapter 3. Setup

3-1 Language Setup.....	24
Language Setting.....	24
3-2 VIDEO Setup.....	25
TV Aspect Ratio Settings.....	25
Adjusting the Brightness and Sharpness.....	26
3-3 AUDIO Setup.....	27
Digital Out Setting.....	27
3-4 Custom Setup.....	28
Parental Control Setting [DVD].....	28
Password Setting [DVD].....	29
Default Setting.....	30

Chapter 4. For Your Reference

4-1 Troubleshooting.....	31
4-2 Disc Handling and Maintenance.....	32
4-3 Definition of Terms.....	33
4-4 Specifications.....	33

FCC and Safety Information

CAUTION:

This unit employs a laser. Due to possible eye injury, only qualified service personnel should remove the cover or attempt to service this device. Use of controls or adjustments or performance of procedures other than those specified herein may result in hazardous radiation exposure.

NOTE:

This equipment has been tested and found to comply with the limits for a Class B digital device pursuant to part 15 of the FCC Rules. These limits are designed to provide reasonable protection against harmful interference in a residential installation. This equipment generates, uses and can radiate radio frequency energy and, if not installed and used in accordance with the instructions, may cause harmful interference to radio communications. However, there is no guarantee that interference will not occur in a particular installation. If this equipment does cause harmful interference to radio or television reception, which can be determined by turning the equipment off and on, the user is encouraged to try to correct the interference by one or more of the following measures:

- Reorient or relocate the receiving antenna.
- Increase the separation between the equipment and receiver.
- Connect the equipment into an outlet on a circuit different from that to which the receiver is connected.
- Consult the dealer or an experienced technician for help.

This product incorporates copyright protection technology that is protected by method claims of certain U.S. patents and other intellectual property rights owned by Macrovision Corporation and other rights owners. Use of this copyright protection technology must be authorized by Macrovision Corporation, and is intended for home and other limited viewing uses only unless otherwise authorized by Macrovision Corporation. Reverse engineering or disassembly is prohibited.

Since it is usual for DVD movies to be released at different times in different regions of the world, all players have region codes and discs can have an optional region code. If you load a disc of a different region code to your player, you will see the region code notice on the screen. This player displays region 1 discs only.



Never make or change connections with the power switched on.

CAUTION VISIBLE AND INVISIBLE LASER RADIATION WHEN OPEN AVOID EXPOSURE TO BEAM
(WARNING LOCATION: INSIDE ON LASER COVERSIELD)

**CLASS 1
LASER PRODUCT**

Important Safety Instructions

1. Read these instructions.
2. Keep these instructions.
3. Heed all warnings.
4. Follow all instructions.
5. Do not use this apparatus near water.
6. Clean only with a damp cloth.
7. Do not block any of the ventilation openings. Install in accordance with the manufacturer's instructions.
8. Do not install near any heat sources such as radiators, heat registers, stoves, or other apparatus (including amplifiers) that produce heat.
9. Do not defeat the safety purpose of the polarized-type plug. A polarized plug has two blades with one wider than the other. The wide blade is provided for your safety. When the provided plug does not fit into your outlet, consult an electrician for replacement of the obsolete outlet.
10. Protect the power cord from being walked on or pinched particularly at plug, convenience receptacles, and the point where they exit from the apparatus.
11. Only use attachments/accessories specified by the manufacturer.
12. Use only with a cart, stand, tripod, bracket, or table specified by the manufacturer or sold with the apparatus. When a cart is used, use caution when moving the cart/apparatus combination to avoid injury from tip-over.
13. Unplug this apparatus during lightning storms or when unused for long periods of time.
14. Refer all servicing to qualified service personnel. Servicing is required when the apparatus has been damaged in any way; such as when the power-supply cord or plug is damaged, liquid has been spilled or objects have fallen into the apparatus, the apparatus has been exposed to rain or moisture, does not operate normally, or has been dropped.



Outdoor use or wet location applications:

An apparatus that does not comply with the requirements in Appendix A# (Outdoor Use and Wet Location Apparatus) shall be marked or the instruction manual packed with the word **WARNING** and the following or equivalent: To reduce the risk of fire or electric shock, do not expose this apparatus to rain or moisture.

A Class II APPARATUS shall be permanently marked with the words **DOUBLE INSULATION** or Double insulated and When servicing use only identical replacement parts.

WARNING: To reduce the risk of fire or electric shock, do not expose this apparatus to rain or moisture. The apparatus shall not be exposed to dripping or splashing and no objects filled with liquids, such as vases, shall be placed on the apparatus.

Precautions

Please read these precautions before operating this unit.

■ Power cord protection

To avoid any malfunctions of the unit, and to protect against electric shock, fire or personal injury, please observe the following.

- Hold the plug firmly when connecting or disconnecting the AC power cord.
- Keep the AC power cord away from heating appliances.
- Never put any heavy object on the AC power cord.
- Do not attempt to repair or reconstruct the AC power cord in any way.

■ Placement

Avoid placing the unit in areas of:

- direct sunlight or heating radiators, or closed automobiles
- high temperature (over 35°C) or high humidity (over 90%)
- much dust as the internal parts may be seriously damaged.

■ Non-use periods

When the unit is not being used, turn it off. When left unused for a long period of time, the unit should be unplugged from the household AC outlet.

■ No fingers or other objects inside

- Touching internal parts of this unit is dangerous, and may cause serious damage to the unit. Do not attempt to disassemble the unit.
- Do not put any foreign object on the disc tray.

■ Keep away from water/magnet

- Keep the unit away from flower vases, tubs, sinks, etc. If liquids are spilled into the unit, serious damage could occur.
- Never bring a magnet or magnetized object near the unit.

■ Stacking

- Place the unit in a horizontal position, and do not place anything heavy on it.

■ Condensation

Moisture may form on the lens in the following conditions:

- immediately after a heater has been turned on
- in a steamy or very humid room
- when the unit is suddenly moved from a cold environment to a warm one

If moisture forms inside this unit, it may not operate properly. In this case, turn on the power and wait about one hour for the moisture to evaporate.

Getting to Know Your Portable DVD Player

Quick Guide will instruct you to install your Portable DVD Player in a quick and easy way. Please carefully follow the instructions to set up your Portable DVD Player.

Unpacking

First inventory the contents of your Portable DVD player package.

Portable DVD Player	1	Ni-MH Battery Pack	1
Audio Cable (white, red)	1	External Power Adapter	1
Video / Coaxial Cable	1	Cigarette Lighter Adapter	1
Remote Control	1	User Manual	1

NOTE: You may purchase additional accessories for this and other Apex products by visiting our “Accessory Store” at www.apexdigitalinc.com. Keep the packaging materials, you may need them to transport your player in the future.

Warning: Changes or modifications made to this equipment, without expressly written consent by us or parties authorized by us will void all manufacturer warranties.

Front View Diagram

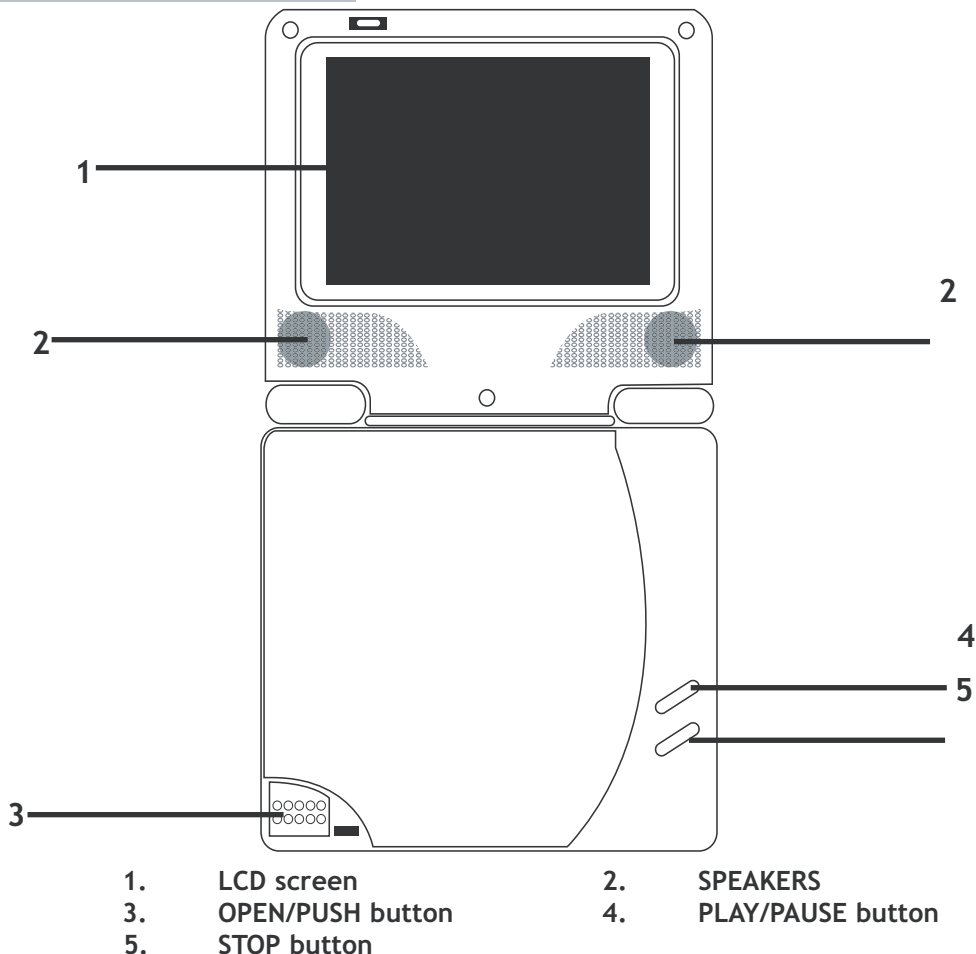

Getting to Know Your Portable DVD Player-continued

Left Side Diagram

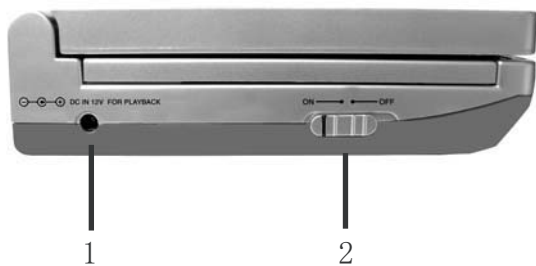

1. DC IN jack for PLAYBACK ONLY
2. POWER ON/OFF button

Front Side Diagram



1. Remote Sensor

Right Side Diagram



1. Volume Adjustment
2. Headphone jack
3. Audio Output jack
4. Video/Coaxial output jack

Getting to Know Your Portable DVD Player-continued

Remote Control Diagram

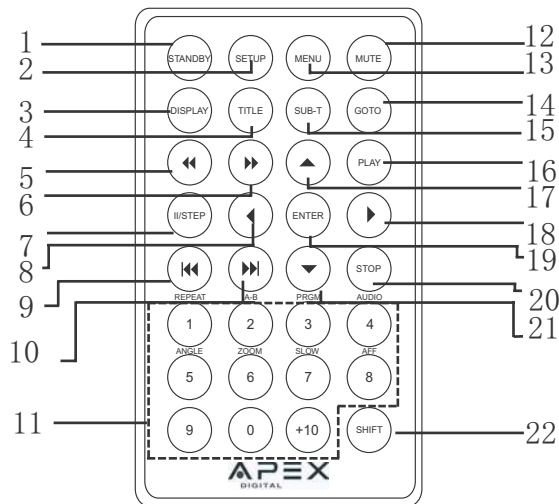

- | | |
|-----------------------|------------------------|
| 1. STANDBY button | 2. SETUP button |
| 3. DISPLAY button | 4. TITLE button |
| 5. FAST REVIEW button | 6. FAST FORWARD button |
| 7. PAUSE/STEP button | 8. LEFT button |
| 9. PREVIOUS button | 10. NEXT button |
| 11. NUMBERS buttons | 12. MUTE button |
| 13. MENU button | 14. GOTO button |
| 15. SUB-T button | 16. PLAY button |
| 17. UP button | 18. RIGHT button |
| 19. ENTER button | 20. STOP button |
| 21. DOWN button | 22. SHIFT button |

Battery Installation for the Remote Control

Insert the battery and match the (+) and (-) on battery to the marks inside the battery compartment.

First-time use:

Remember to remove the insulating Mylar Tape from the battery compartment.

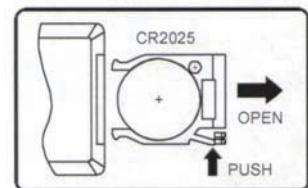

Service life of battery

1. The battery normally lasts for about one year although this depends on how often and for what operations the remote control is used.
2. If the remote control unit fails to work even when it is operated near the player, replace the battery.
3. Use a 3V lithium battery, CR2025 available from a local retailer.

Getting to Know Your Portable DVD Player-continued

Remote Control Operation Range

Point the remote control unit no more than about 12 feet from the remote control sensor and within about 30° of the front of the unit.

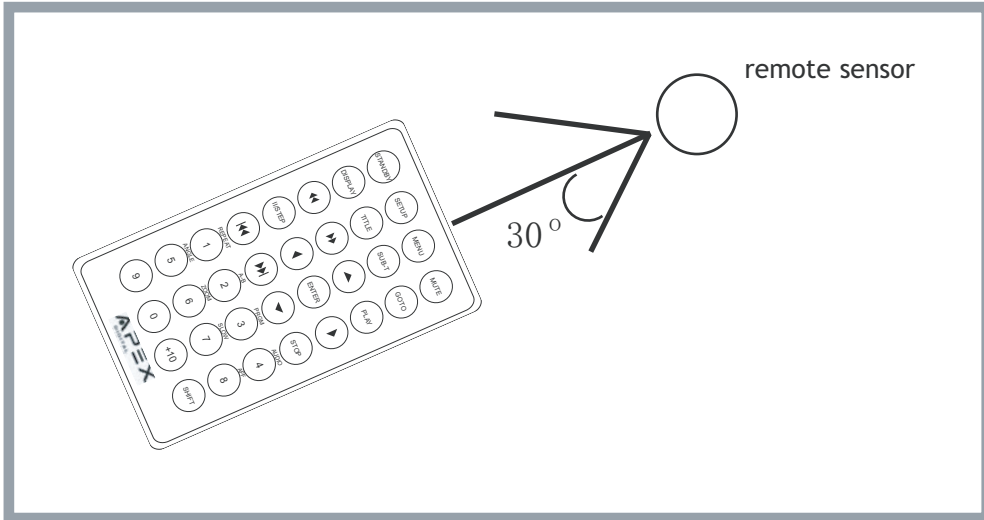

The operating distance may vary according to the brightness in the room.

Note:

1. Do not point bright lights at the remote control signal sensor.
2. Do not place objects between the remote control unit and the remote control signal sensor.
3. Do not use this remote control unit while simultaneously operating the remote control unit of any other equipment.

Quick Operation Guide

Quick Operation

STEP 1. Connect it to Power (A)

Please connect the applied AC adaptor to the DC IN jack on the Left side of this Portable DVD Player.



Quick Operation Guide-continued

STEP 2.

Connect it with headphones or connect it to external equipment. (B)

If you want to enjoy higher listening and viewing quality, you can connect this Portable DVD player to external equipment, such as a TV or an amplifier.

Note:

1. Before connecting, make sure to turn off the power of this Portable DVD Player and external equipment.

(B)



(White) (Red)

1 2

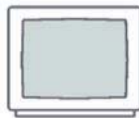

(Yellow) (Orange)

3 4



Note: Make sure the external equipment supports the audio/video input feature.

Back/front panel of external equipment

- 1 (White) Left audio output of TV or amplifier
- 2 (Red) Right audio input of TV or amplifier
- 3 (Yellow) Video input on TV
- 4 (Orange) Coaxial digital audio input of digital amplifier

To playback, select your input source (VIDEO 1, AUX, ETC) based on your connections.

Quick Operation Guide-continued

STEP 3. Slide POWER button to turn on the Portable DVD Player. (C)



STEP 4. Press  <OPEN/PUSH> to open the disc cover. (D)

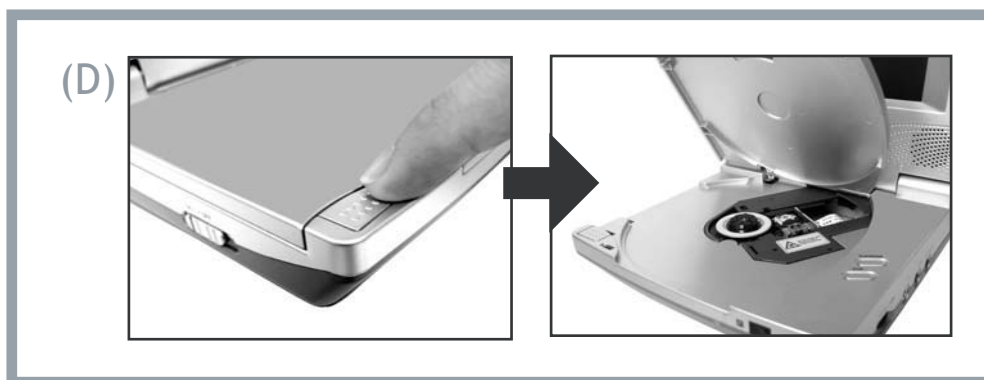

STEP 5. Gently hold the edge of the disc, then place and press down firmly near center spindle with printed side up.

Note: Make sure the printed side of the disc is facing up.

STEP 6. Close the disc cover.

STEP 7. Press  <PLAY> to play the disc.

Using the Battery Pack

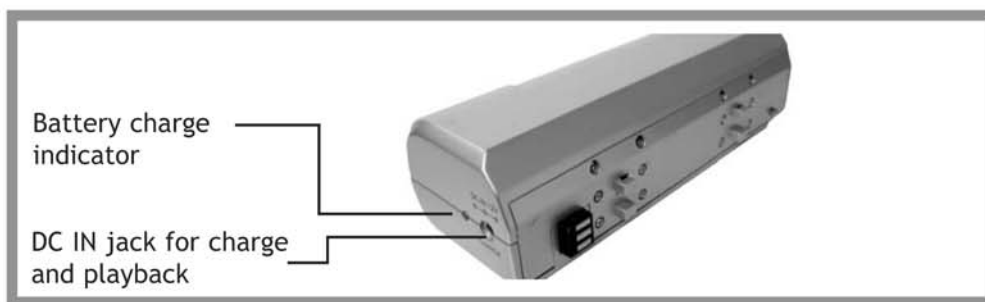

Before using the battery pack, make sure to charge it first.

You should charge it at least 12 hours before first used.

You could choose to charge the battery pack directly or charge it while the battery pack is attached to the Portable DVD player.

PD5BAT

It takes about 4-5 hours to recharge the battery, then the red indicator will turn green and flash. A fully charged battery can power the unit for over 2 hours. Power consumption depends on the operations of the player such as brightness of the screen, volume level, environment, temperature, and how many times you use PAUSE, STOP, FF and REW.

You may purchase additional batteries and other APEX accessory items by visiting our accessory Store online at www.apexdigitalinc.com.

Note: If you do not use the battery for a long time, please charge it before storing and recharge it every 3 months. This will prolong the battery life.

CHARGING THE BATTERY PACK

STEP 1. Connect the AC adapter to the DC IN jack on the left side of the battery pack and a household power outlet. (As shown in figure A)



STEP 2. The battery charge indicator will turn red and start charging.

STEP 3. When the battery pack is fully charged, the battery charge indicator will turn green and flash.

1-1 DVD Playback

Preparation

Connect the portable DVD player with the AC adaptor and/or battery pack, and playback through headphones, speakers, or home theater system.

To connect to home theater or stereo system:

- Turn on the TV set, and select “Video” as the TV input.
- Turn on the home theater/stereo system and select the input source which you connected to the portable DVD player.

Basic Playback

- 1 Slide POWER ON/OFF switch to POWER ON.**
- 2 Press <OPEN/PUSH> button to open the disc cover.**
- 3 Place Disc in the tray with the printed side up.**

Hold the disc without touching the playable surface, position it with the printed title side facing up, align it with the guides, and press the disc firmly onto the center spindle.

4 Close the disc cover.

- Close the disc cover, the portable DVD player will start playback automatically.
- If the disc contains one or more titles, a menu screen will appear on the screen.

<< NOTE: Proceed with steps 5 and 6 when a menu is available on the disc >>

5 Press << / > / < / > to choose the preferred selection.

6 Press <ENTER> or <PLAY>.

The player will start playback of the selected item.

Stopping Playback and Returning to The Menu Screen (If a Menu Screen Is Available on The Disc)

Press <MENU>.

The portable DVD player stops playback, and then displays the menu screen.

After operation

When the portable DVD player is not in use, remove the disc and slide **POWER ON/OFF** switch to turn off the player. Then close the display panel.

<< NOTE >>

- The disc continues to spin while the menu is displayed even after the player has finished playing a particular disc. When no further selections are to be played, be sure to press the  <STOP> button to clear the menu screen.
- If the disc is placed in upside down (and it is a single sided disc), the player's display will appear “BAD DISC”.

For your reference:

- When  appears while a button is being operated, it means that the corresponding operation is prohibited by the player.

1-1 DVD Playback-continued

Stopping Playback

Press  <STOP> to stop.

Rapid Advance (Rapid Reverse)

Press  <REW> or  <FF> during playback.

- Normal playback is resumed when you press  <PLAY>.
- The speed of advance ( x2,  x4,  x8,  x20, play) or reverse ( x2,  x4,  x8,  x20, play) changes for each press of the  <FF> or  <REW> button.

Slow Playback

Press  <SHIFT> and “7” several times to slow playback



To return to normal playback

Press  <PLAY>.

Skipping Ahead or Back to Chapters

You can skip a specific chapter or track during playback.

Skipping Ahead

Press  <NEXT> during playback.

Skips a chapter each time you press the button.

Skipping Back

Press  <PREVIOUS> during playback.

Skips a chapter each time you press the button.

Still Picture (PAUSE/STEP)

Press  <PAUSE/STEP> once during playback.

The screen image is paused.

Press  <PAUSE/STEP> button several times, the screen image will playback frame by frame.

To return to normal playback

Press  <PLAY>.

1-1 DVD Playback-continued

Repeat Viewing

Press  <SHIFT> and then “1” during playback.

Each time you  <SHIFT>, press the “1” button, the disc will repeat a chapter or title.

Press once: Repeat. OFF (Repeat state displayed)

Press twice: Repeat. CHAPTER (Repeat chapter)

Press three times: Repeat. TITLE (Repeat title)

Press four times: Repeat. off (Repeat cancelled)

To return to normal playback press the  <SHIFT> key, then press “1”.

Press  <SHIFT> then “1” (Repeat) several times until “Off” appears on the screen.

<< NOTE >>

- Repeat playback works only with discs for which the elapsed playing time appears on the player’s display during playback.
- Repeat playback may not work correctly with some DVDs.

A-B Repeat Viewing

This DVD player allows you to playback a specific segment repeatedly.

Press  <SHIFT> and then “2” during playback to select the start point of the specific segment.

Press  <SHIFT> and then “2” twice during playback to select the end point of the specific segment.

To return to normal playback, press the  <SHIFT> key and then “2” a third time to cancel A-B repeat.

Playing in a favorite Order

Press  <SHIFT> and then “3”.

Program menu displays on the screen

Program Input	Title/Chapter
1 ___ 4 ___ 7 ___ 10 ___	
2 ___ 5 ___ 8 ___ 11 ___	
3 ___ 6 ___ 9 ___ 12 ___	
Play Program	Clear All

Use the number button(s) and  <Down>  <LEFT> or  <RIGHT> to select the Title/Chapter number in order.

Use the  <DOWN> button to select Play Program, then press  <ENTER> to start.

1-2 Convenient functions

Displaying the information of the Scene

Displaying the Information of the Scene

Press  <DISPLAY> during playback.

Press  <DISPLAY> to display the title number, chapter number, and other information on screen.

Press  <DISPLAY> until the information on screen disappears.

Changing Audio Soundtrack Language

1 Press  <SHIFT> and “4” during playback.

2 Press “4” until the preferred language is selected.

For your reference:

- If the preferred language is not selected even after pressing the button several times, it may indicate that language is not available on the disc.
- You can also change the audio language during initial setup to a different language, if available. (This functions only on discs with multiple languages.)
- When you turn on or remove the disc, the portable DVD player will playback the language which is selected at the initial setting. If you select a language which is not recorded on the disc, the portable DVD player will playback a prior language programmed on the disc.

Activating AFF (Active Full Screen Function)

AFF (Active Full Screen Function) allows you to fill the TV screen viewing area when playing a widescreen formatted DVD. Press AFF on your remote control to eliminate (1:85 aspect ratio) or reduce the black bars on the top and bottom of the screen.

Press <SHIFT> and then “8” to activate AFF(Active Full Screen Function)

Before
AFF



After
AFF



Zooming a Picture

This DVD player allows you to zoom into a picture as well as shift the zoom point.

Press  <SHIFT> and then “6” several times during normal playback or slow-motion.

The player magnifies in the center of the picture.



If you press  <UP>  <DOWN>  <RIGHT> buttons during playback, the zoom point shifts.

To cancel the zoom function, press  <SHIFT> and “6” until zoom off.

1-2 Convenient functions-continued

Clearing/Displaying/Changing Subtitle Language

If a disc provides subtitles, you can choose to hide or display them. (This operation works only with discs that provide subtitles.)

Press  **<SUBTITLE>** during playback to display subtitles or hide them. When you press **<SUBTITLE>** twice, the first subtitle recorded on the disc will display. The rest of the subtitles recorded will display in sequence as you press the button continually.

● You may switch to another language with this key, or you can turn off the subtitle by pressing this key until “SUBTITLE OFF” appears on the screen.

You can change the subtitle language, if available.

1 Press  **<SUBTITLE>** during playback

When no subtitles are recorded “” will display instead of the language number.

2 Press  **<SUBTITLE>** until the preferred language is selected.

<< NOTE: In some cases, the subtitle language may not change immediately to the selected one.>>

For your reference:

- You can change the subtitle language with the initial settings, if available.
- When the preferred subtitle language is not selected even after pressing the button several times, it may indicate that the language is not available on the disc.
- When you turn on or remove the disc, the portable DVD player will playback the subtitle language selected during initial setup. If you select a subtitle language which is not recorded on the disc, the portable DVD player will playback a prior subtitle language programmed on the disc.

Viewing From Another Angle

Some special featured DVD discs may contain scenes which have been shot simultaneously from a number of different angles. For these discs, the same scenes can be viewed from different angles using the **<ANGLE>** button. (The recorded angles vary depending on the disc programming.)

1 Press **<ANGLE>** during playback.

2 Press **<ANGLE>** until the preferred viewing angle is selected.

Press **<ANGLE>** button to change the viewing angle.

<< NOTE >>



- ANGLE will only function on discs where different angles have been recorded.
- The viewing angles are shown on the player’s display and you can select one from them for viewing.

1-2 Convenient functions-continued

To Mute the DVD Player

In some cases, you may need to mute the portable DVD player temporarily. The portable DVD player provides a MUTE function for your selections.

Press  **<MUTE> button during playback.**

- When “” appears on the screen, the portable DVD player is muted. To resume the sound, press the button until “” disappears from the screen.

Using a DVD Menu

Some DVD discs have unique menu structures called DVD menus. For example, DVDs programmed with complex contents provide guide menus, and those recorded with various languages provide menus for audio and subtitle language. Although the DVD menu's contents and operation vary from disc to disc, the following explains basic operation when this feature is used.

1 Press  **<TITLE> in stop mode.**

The DVD menu available on the disc now appears.

2 Press **<◀ / ▶ / ▲ / ▼>** **to select the preferred item.**

3 Press  **<ENTER>.**

You now enter to the selected item.

To enter another menu screen

Repeat steps 2 and 3.

To return to the previous menu screen

Press  **<TITLE>.**

Using the MENU Function

1 Press  **<ENTER>.**

2 Press  **<MENU>.**

A DVD chapter menu with brief broadcast of each paragraph now appears. You may see the introduction of each chapter and then decide with which chapter to start first.





3 Press **<◀ / ▶ / ▲ / ▼>** **or number button(s) to select the preferred item.**

<< Note: The menu details vary depending on discs recorded. **>>**

1-2 Convenient functions-continued



Selecting Scenes by Title/Chapter Number

Allows you to locate specific titles/chapters of scenes to playback.

- 1 Press  <GOTO> during playback.
- 2 Press , <DOWN> button, , <LEFT> button and , <RIGHT> button to move the cursor to title or chapter
- 3 Press the number buttons to specify the preferred title or chapter.
- 4 Press  <ENTER>.

The portable DVD player will start playback from selected title/chapter numbers.

Selecting Scenes by Time

- 1 Press  <GOTO> during playback.
 - 2 Press the number buttons to specify the scene time desired.
- Example: To locate “01 hr. 50 min. 00 sec.”, press “1”, “5”, “0”, “0” and “0”.
- 3 Press  <ENTER>.

The portable DVD player will start playback from the specified position.

<< NOTE >>

- These operations work only with discs for which the elapsed playing time appears on the portable DVD player’s display during playback.
- For some discs, playback may start from a different place, even when the steps above have been performed correctly.

For your reference:

- When “” appears while you are pressing a button, it may indicate that the corresponding operation is prohibited by the portable DVD player.

2-1 Audio CD Playback

Preparation

Connect the portable DVD player with the AC adaptor and/or battery pack, and playback through headphones, speakers, or home theater system.

To connect to home theater or stereo system:

- Turn on home theater/stereo system and select the input source which you connected to the portable DVD player.

Basic Playback

- 1 Slide POWER ON/OFF to switch on.**
- 2 Press <OPEN/PUSH> button to open the disc cover.**
- 3 Place disc in the tray with the printed side up.**

Hold the disc without touching the playable surface, position it with the printed title side facing up, align it with the guides, and press the disc firmly onto the center spindle.











- 4 Close the disc cover. CD will automatically play.**

Stopping Playback

Press  **<STOP>** to stop.

Rapid Advance (Rapid Reverse)

Press  **<REW>** or  **<FF>** during playback.

- Normal playback is resumed when you press  **<PLAY>**.
- The speed of advance (, , , , play) or reverse (, , , , play) changes for each press of the  **<FF>** or  **<REW>** button.

2-1 Audio CD Playback-continued

Skipping Ahead or Back to Tracks

Skipping Ahead

Press  **<NEXT>** during playback.

A track is skipped each time you press the button.

Skipping Back

Press  **<PREVIOUS>** during playback.

The player skips a track each time the button is pressed.

Pause Playback

Press  **<PAUSE>** once during playback.

The player will pause playback.

To return to normal playback

Press  **<PLAY>**.

2-2 DISPLAY [Audio CDs]

Clearing/Displaying the Information on the CD

Press  **<DISPLAY>** during playback.

Press  **<DISPLAY>** to display the elapsed time, track number and other information on the screen.

3-1 Language Setup

Language Setting

Allows you to set various languages for the on screen display (OSD).

You can select a preferred subtitle language among various languages that have been recorded on DVD discs.

You can select a preferred soundtrack language among various languages that have been recorded on DVD discs.

You can select a preferred DVD Menu language among various languages that have been recorded on discs for the disc menu messages display.

1 Press  **<SETUP>** then press  **<ENTER>**.

2 Press  **<DOWN>** button to select “preferred item”, and then press  **<ENTER>**.

3 Press  **<UP>** button/  **<DOWN>** direction button to select the preferred

language.

4 Press  **<ENTER>**.

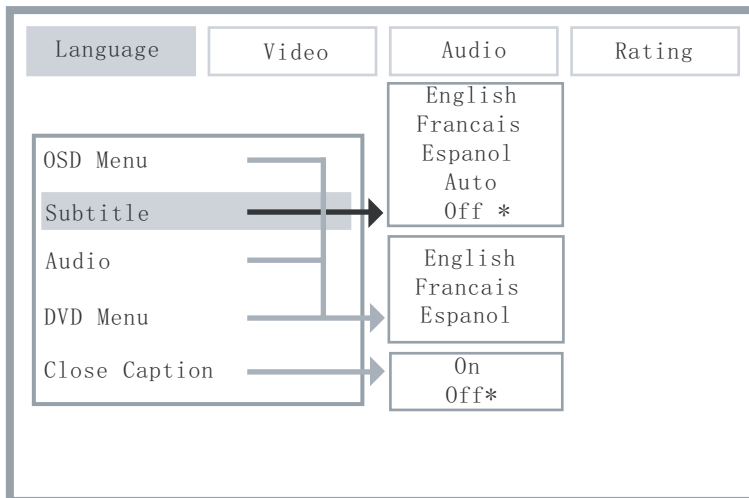

To finish the setup operation

Press  **<SETUP>** to exit.









For your reference:

- If the language selected is not recorded on the disc, the portable DVD player will playback the top-priority language of the disc. You can also switch Close Caption ON, if the Close Caption is recorded on the disc and your TV supports the Close Caption function. When you use the Close Caption you should switch the subtitle off.

3-2 Video Setup

TV Aspect Ratio Settings

Depending on your TV screen size, you can select your preference for optimal viewing of conventional (4:3) Pan & Scan. (4:3 LB) Letter Box movies or (16:9) Widescreen .

- 1 Press  **<SETUP>**
- 2 Press  **<RIGHT>** direction button to select “Video”, and then press  **<ENTER>**.
- 3 Press  **<DOWN>** button to select TV Shape, and then press  **<ENTER>**.
- 4 Press  **<UP>** button /  **<DOWN>** button to select the preferred TV display.
- 5 Press  **<ENTER>**. (see notes below)

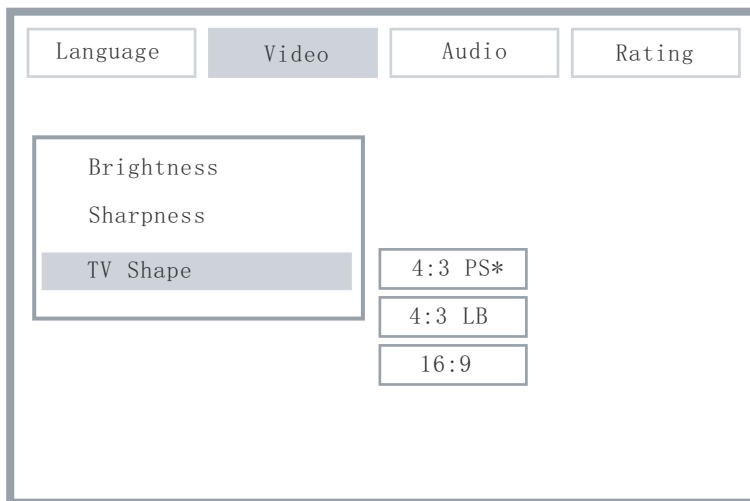

To finish the setup operation

Press  **<SETUP>** to exit SETUP MENU screen.

4:3 Pan Scan

Select **4:3 PS** for a conventional size TV set. Video material formatted in the pan & scan style is played. Portions of the program material maybe cut off on the left and right edges.

4:3 Letter Box

Select **4:3 LB** for a conventional size TV set. Black bands appear at top and bottom of screen (letter-box style). But allow for the true aspect ratio of the widescreen programming.

- Video material not formatted in the pan & scan style is played in the letter-box style.

16:9 Wide







Select **16:9** for a wide-screen TV set. Played in “FULL” size.

- Setting the wide-screen TV to “FULL” mode is also necessary.
- Each screen shows an example when the video material for a widescreen is played.

3-2 Video Setup-continued

Adjusting the Brightness and Sharpness

You can also adjust the Brightness and the Sharpness.

- 1 Press  **<SETUP>**
- 2 Press  **<RIGHT>** direction button to select "VIDEO", and then press  **<ENTER>**.
- 3 Press  **<UP>** button/ **<DOWN>** button to select the **Brightness or Sharpness**.
- 4 Press  **<RIGHT>** direction button or  **<LEFT>** direction button to select the preferred **Brightness or Sharpness**.

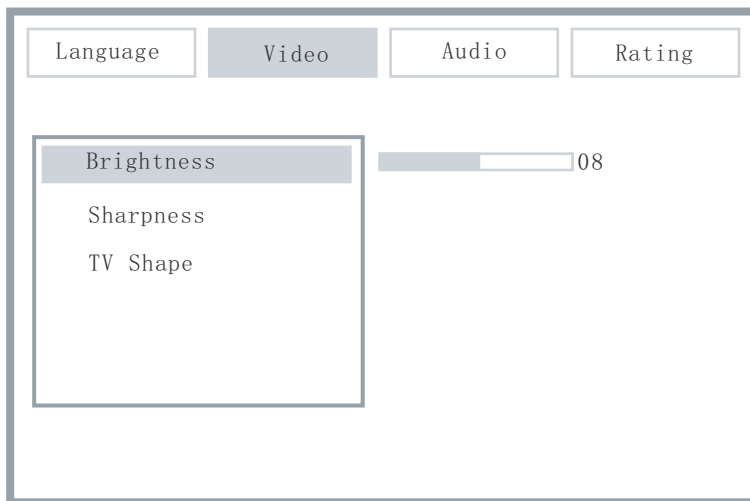

To finish the setup operation

Press  **<SETUP>** to exit SETUP MENU screen.

3-3 Audio Setup

Digital Out Setting

The portable DVD player provides two options, "PCM" and "RAW" for the digital out setting.

For your reference:

- If you have a Dolby Digital 5.1, you must set the audio output to RAW. If you have a 2-channel Dolby Digital amplifier, you must set the audio output to PCM

1 Press  <SETUP>.

2 Press  <RIGHT> direction button to select "AUDIO", and then press

 <ENTER>.

3 Press  <UP> button/  <DOWN> button to select your "Digital Out"

preference and then press  <ENTER>.

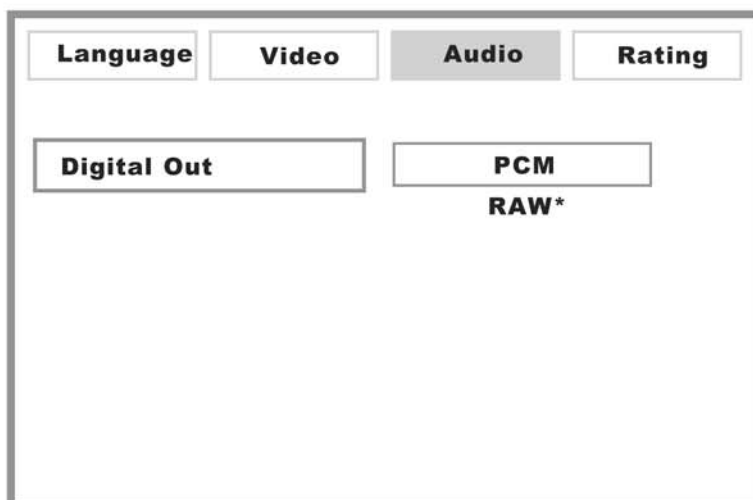









To finish the setup operation

Press  <SETUP> to exit.

3-4 Custom Setup

Parental Control Setting [DVD]

A built-in viewer rating setting enables you to lockout video programming that you do not want children to view. For example, if you set it to PG-13, then this portable DVD player will not play the videos rated R, NC-17 or Adult unless the correct password is entered.

- 1 Press  <SETUP>.
- 2 Press  <RIGHT> direction button to select “Rating”, then press  <ENTER>.
- 3 Press  <DOWN> button to select “RATING” and then press  <ENTER>.
- 4 Press  <ENTER> until preferred rating is highlighted.
- 5 Press  <UP> button to select Password and enter a 4-digit password, then press  <ENTER>.

NOTE: If you had locked the rating, you will need to enter your password to unlock the rating before you can change it.
Over-riding password is “3308”.

- 6 Press  <SETUP> to exit.

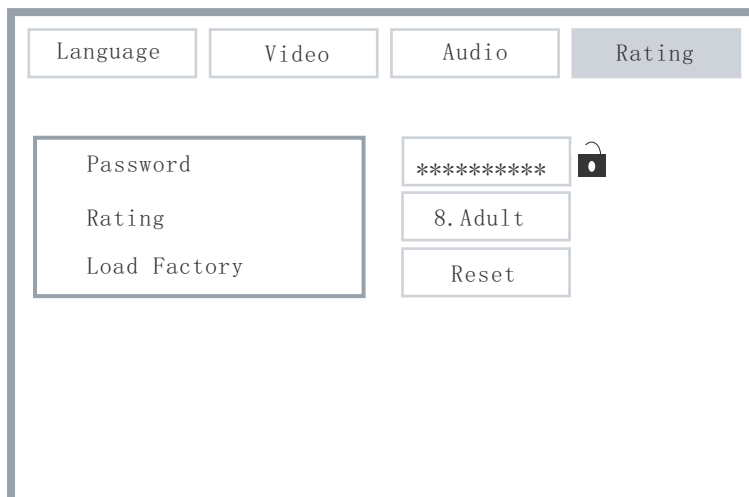

For your reference:

- You can use the parental control lock ONLY with DVD discs featured with the parental lock function.
- Some discs may not be encoded with specific rating level information though its disc jacket says that it is for “adults”. For those discs, RATINGS lock will not function.

3-2 Custom Setup-continued

Password Setting [DVD]

You can change the password to the portable DVD player by selections.

1 Press  **<SETUP>**.

2 Press  **<RIGHT> direction button to select "Rating", and then press  **<ENTER>**.**

3 Enter your old password and then press  **<ENTER>** to unlock the old password if you have locked it before.

4 Enter your new password and then press  **<ENTER>**.

NOTE: Over-ride password is "3308".

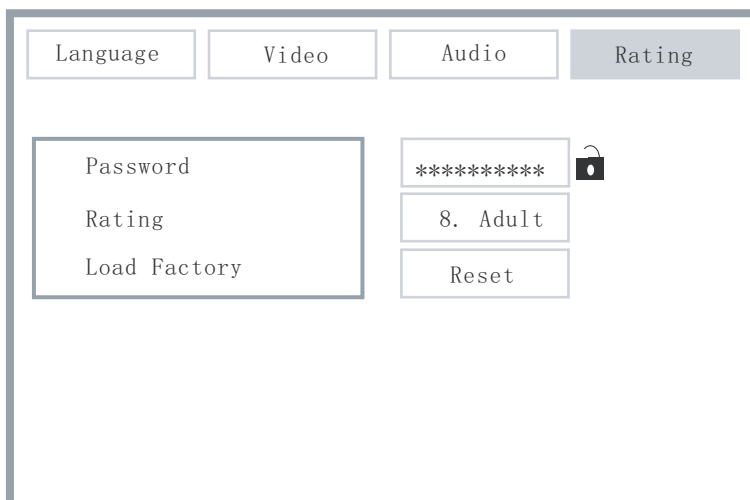

To finish the setup operation

Press  **<SETUP>** to exit SETUP MENU screen.

3-4 Custom Setup

Load Factory Setting

You may reset the DVD player in CUSTOM SETUP to the original settings original default settings.

1 Press  <SETUP>.

2 Press  <RIGHT> direction button to select "Rating", and then
press  <ENTER>.

3 Press  <UP> button /  <DOWN> button to select "Load Factory" and then
press  <ENTER>.

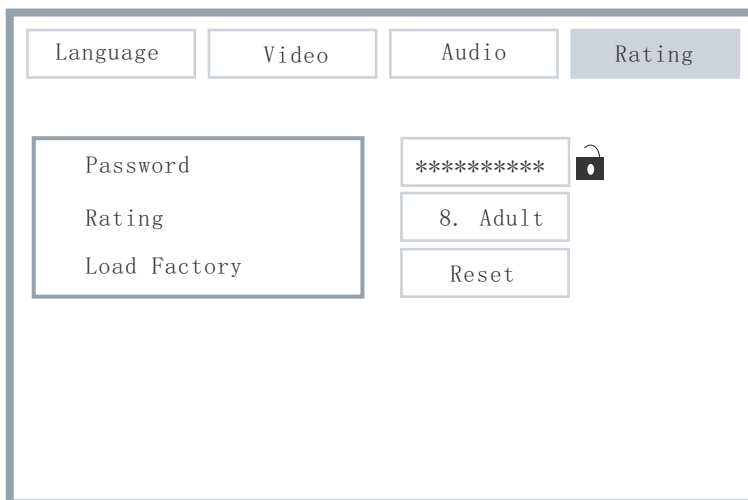

4-1 Troubleshooting Guide

Before requesting service for this portable DVD player, check the chart below for a possible cause of the problem you are experiencing. Some simple checkups or a minor adjustment on your part may eliminate the problem and restore proper operation.

We encourage you to visit our website at www.apexdigitalinc.com and review the customer support and FAQ's page for updates to this list. You may register to validate your warranty at our website and order accessories for your product.

SYMPTOM (COMMON)	REMEDY
No power.	<ul style="list-style-type: none"> Insert the power plug securely into the power outlet. Check if the ON/OFF button on the right of the player is set to on. Check if no power at the AC outlet by plugging in another appliance for a test. Recharge the battery.
The player does not start playback when PLAY is pressed.	<ul style="list-style-type: none"> Condensation has formed: wait about 1 to 2 hours to allow the player to dry out. This player cannot play discs other than DVDs and audio CDs. Check if the disc is defective by trying another disc. Check the region (local) code. Disc may have been placed in the tray upside down.
The player starts playback but stops immediately.	<ul style="list-style-type: none"> The disc may be dirty and may require cleaning. Ensure that the disc is installed with the label side up.
No picture.	<ul style="list-style-type: none"> Ensure that the equipment is connected properly. Ensure that the input setting for the TV is "Video". Check if external equipment is on. Select the same channel and source on the TV as on the player. Check if the LCD is on.
No sound.	<ul style="list-style-type: none"> Ensure that the equipment is connected properly and firmly into jacks. If using a HiFi amplifier, try another sound source. Check the Audio Output Setting menu to make sure that Analog Output is selected. Check the Volume Adjustment.
Distorted sound.	<ul style="list-style-type: none"> Ensure that the input settings for the TV and stereo system are proper. No sound is heard during still picture (pause).
No audio at Digital Output.	<ul style="list-style-type: none"> Check the digital connections. Check if the audio format of the selected audio language matches your receiver capabilities.
Distorted picture.	<ul style="list-style-type: none"> Check the disc for fingerprints and clean it with a soft cloth, wiping it from center to edge. Sometimes a small amount of picture distortion may appear. This is not a malfunction. This is normal occurrence.
Picture is distorted during rapid advance or rapid reverse.	
No rapid advance (or rapid reverse) playback.	<ul style="list-style-type: none"> Some discs may have sections which prohibit rapid advance (or rapid reverse).
No 4:3 (16:9) picture.	<ul style="list-style-type: none"> Choose the correct setup "TV DISPLAY" item which matches the TV set used.
No subtitles.	<ul style="list-style-type: none"> Subtitles appear only with discs that contain them. Subtitles are hidden from the TV screen. (Refer to page 18 for directions)
No operations perform with the remote control.	<ul style="list-style-type: none"> Check the batteries are installed with the correct polarity (+ and -). The batteries are depleted: replace them with new ones. Point the remote control unit at the remote control signal sensor and operate. Operate the remote control unit at a distance but no more than 6 meters from the remote control signal sensor. Remove the obstacles between the remote control unit and remote control signal
No key operation (by the DVD player power and/or the remote control) is effective.	<ul style="list-style-type: none"> Turn the unit off and then back to on. Alternatively, turn off the unit, disconnect the AC cord and then re-connect it. (The player may not be operating properly due to lightning, static electricity or some other external factor.)
PLAY does not start playback even when title is selected.	<ul style="list-style-type: none"> This may be a result of the parental lock function that has been set. Confirm the parental setting in the setup menu.
Audio soundtrack and/or subtitle language is not the one selected at the initial settings.	<ul style="list-style-type: none"> If the audio soundtrack and/or subtitle language does not exist on the disc, the language selected at the initial settings will not be seen/heard.
Alternative audio soundtrack (or subtitle) languages cannot be selected.	<ul style="list-style-type: none"> An alternative language can not be selected may result of no more than one language available. This function depends on software availability. Even if a disc has a number of angles recorded, these angles may be recorded for specific scenes only.
Angle cannot change.	
I forgot my password for parental control.	<ul style="list-style-type: none"> Enter overriding password: 3308
The battery charge indicator does not turn on when connected to power supply.	<ul style="list-style-type: none"> Reset the battery pack by disconnect the power supply for 30 seconds. Connect the power supply to the battery and wait for 10 minutes while attaching the DVD player.

4-2 Disc Handling and Maintenance

Handling Precautions

- Hold the disc by the edges to avoid fingerprints. (A)
Fingerprints, dirt and scratches can cause skipping and distortion.
- Do not write on the label side with a ball-point pen or other writing utensils.
- Do not use record cleaning sprays, benzene, thinner, static electricity prevention liquids or any other solvent.
- Be careful not to drop or bend the disc.
- Do not install more than 1 disc on the disc tray.
- Do not try to close the disc cover on an improperly installed DVD.
- Be sure to store the disc in its exclusive case when not in use.

If the surface is soiled (B)

Wipe gently with a soft, damp (water only) cloth.

When wiping discs, always move the cloth from the center hole toward the outer edge.

(If you wipe the discs using a circular motion, circular scratches are likely to occur, which will cause noise.)

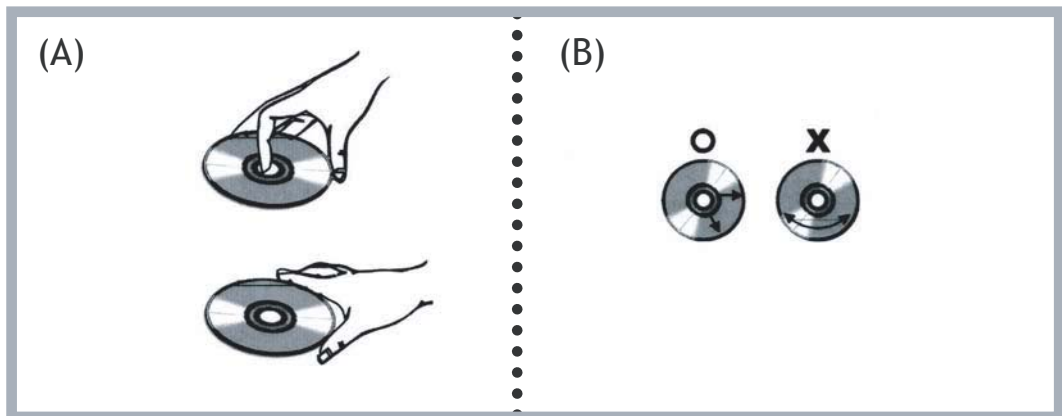

If the disc is brought from a cold to a warm environment, moisture may form on the disc.

Wipe this moisture off with a soft, dry, lint-free cloth before using the disc.

Improper disc storage

You can damage discs if you store them in the following places:

- Areas exposed to direct sunlight
- Humid or dusty areas
- Areas directly exposed to a heat outlet or heating appliance

Maintenance

- Be sure to turn the unit off and disconnect the AC power cord.
- Wipe this unit with a dry soft cloth. If the surfaces are extremely dirty, wipe clean with a cloth which has been dipped in a weak soap-and-water solution and wrung out thoroughly, and then wipe again with a dry cloth.
- Never use alcohol, benzene, thinner, cleaning fluid or other chemicals. And do not use compressed air to remove dust.

4-3 Definition of Terms

Angle

Recorded onto certain special edition DVD discs are scenes that have been simultaneously shot from a number of different angles (the same scene is shot from the front, from the left side, from the right side, etc.). With such discs, the ANGLE button can be used to view the scene from different angles.

Chapter Number

These numbers are recorded on DVD discs. A title is subdivided into many sections, each of which is numbered, and specific parts of video presentations can be searched quickly using these numbers.

DVD

Refers to a high-density optical disc on which high-quality pictures and sound have been recorded by means of digital signals. Incorporating a new video compression technology (MPEG II) and high-density recording technology, DVD enables aesthetically pleasing full-motion video to be recorded over long periods of time (for instance, a whole movie can be recorded).

DVD has a structure consisting of two 0.6 mm thin discs which are adhered to each other. Since the thinner the disc, the higher the density at which the information can be recorded, a DVD disc has a greater capacity than a single 1.2 mm thick disc. Since the two thin discs are adhered to each other, there is the potential to achieve double-sided play sometime in the future for even longer duration play.

Subtitles

These are the printed lines appearing at the bottom of the screen which translate or transcribe the dialogue. They are recorded on DVD discs.

Time Digit

This indicates the play time which has elapsed from the start of a disc or a title. It can be used to find a specific scene quickly. (It may not work with some discs.)

Title Number

These numbers are recorded on DVD discs. When a disc contains two or more movies, these movies are numbered as title 1, title 2, etc.

Track Number

These numbers are assigned to the tracks which are recorded on audio CDs. They enable specific tracks to be located quickly.

4-4 Specifications

Portable DVD Video Player

Power Supply	~120V-240V. 60Hz
Power Consumption	9W
Mass	4.18 lbs.
External Dimensions	5.98x1.57x5.51 inches (W/H/D)
Laser	Semiconductor Laser, wavelength 650nm

Outputs

Video Output	1.0V(p-p), 75ohms, negative sync
Audio Output (digital output)	0.5V(p-p), 75ohms
Audio Output (analog audio)	2.0V(rms), 10Komhs



PORTABLE DVD PLAYERS 90 DAYS LABOR/ONE YEAR REPLACEMENT OF PARTS

WHO IS COVERED?

Proof of purchase is required to receive warranty service such as the original sales receipt showing original date of purchase from an authorized APEX Digital, Inc. dealer in N. America. Keep your original box and packaging in case your unit needs to be shipped to us. You will need to prepay shipping and APEX will pay the cost of shipping the unit back to you. You are required to email or call Customer Support for proper instructions to ship unit for repair. A return authorization number is required prior to acceptance by Apex. Register your product online at www.apexdigitalinc.com.

WHAT IS COVERED

Warranty repair from the original date of purchase: One (1) year replacement of parts; 90 day limited labor warranty coverage. ***If you don't have proof of purchase, your unit will be considered out-of-warranty & will be charged at a flat labor rate.***

WHAT IS EXCLUDED?

Your warranty does not cover:

- Labor charges for installation or setup of the product, adjustment of customer controls on the product, and installation or repair of antenna systems outside of the product.
- Product repair and/or part replacement because of misuse, accident, unauthorized repair or other cause not within the control of Apex Digital, Inc.
- A product that requires modification or adaptation to enable it to operate in any country other than the country for which it was designed, manufactured, approved and/or authorized, or repair of products damaged by these modifications.
- Incidental or consequential damages resulting from the product. (Some states do not allow the incidental or consequential damages, so the above exclusion may not apply to you. This includes, but is not limited to, pre-recorded material, whether copyrighted or not.)
- Shipment and service to a NON-AUTHORIZED repair facility.

BEFORE REQUESTING SERVICE:

In the event after following all of the operating instructions including the **Troubleshooting Guide** and reviewing updated FAQ's on the Customer Support & FAQ page of our website, www.apexdigitalinc.com, should you find that service is still necessary, email or call Customer Support for an RA number.

ORDERING ACCESSORIES:

You may purchase parts and accessories by visiting www.apexdigitalinc.com under Accessories or email/call for pricing and availability of your request.

WHERE IS SERVICE AVAILABLE?

If you previously registered your product(s) online at www.apexdigitalinc.com go to MY ACCOUNT and email your request. Otherwise, go to PRODUCT REGISTRATION, enter your information and submit to set up your account. Then email your request. You may also call us at (866) 427-3946 Monday-Friday, 7am-6pm (California).

This warranty gives you specific legal rights. You may have other rights which vary from state/province to state/province.

Manufactured under license from Dolby Laboratories.
Dolby and the double-D symbol are trademarks of Dolby
Laboratories. Confidential Unpublished Works.
©1992-1997 Dolby Laboratories.
All rights reserved.

This product incorporates copyright protection technology that is
protected by method claims of certain U.S. patents and other
intellectual property rights owned by Macrovision Corporation and
other rights owners. Use of this copyright protection technology
must be authorized by Macrovision Corporation, and is intended for
home and other limited viewing uses only unless otherwise
authorized by Macrovision Corporation. Reverse engineering or
disassembly is prohibited.

Free Manuals Download Website

<http://myh66.com>

<http://usermanuals.us>

<http://www.somanuals.com>

<http://www.4manuals.cc>

<http://www.manual-lib.com>

<http://www.404manual.com>

<http://www.luxmanual.com>

<http://aubethermostatmanual.com>

Golf course search by state

<http://golfingnear.com>

Email search by domain

<http://emailbydomain.com>

Auto manuals search

<http://auto.somanuals.com>

TV manuals search

<http://tv.somanuals.com>