

MicroTech II[®] Unit Ventilator Controls for AAF[®]-HermanNelson[®] Classroom Unit Ventilators



DX Cooling Only- Software Model UV05

Used with AAF-HermanNelson Classroom Unit Ventilator
Model AVV - Floor Mounted
Model AHV - Ceiling Mounted
Model AZV, AZU - Floor Mounted Self Contained Air Conditioner

IMPORTANT

*Before unit commissioning, please read this publication in its entirety.
Develop a thorough understanding before starting the commissioning procedure.
This manual is to be used by the commissioner as a guide. Each installation is unique, only general topics are covered.
The order in which topics are covered may not be those required for the actual commissioning.*

Introduction	3
Acronyms/Abbreviations	5
Getting Started	7
Using the Keypad/Display	7
Display Format	7
Keypad Functions	7
Using the Keypad/Display	9
Menu Reference	9
Description of Operation	12
State Programming	12
UVC Unit Modes	13
OFF Mode (State 9)	14
Night Purge Mode (State 8)	15
Fan Only Mode (State A)	15
Emergency Heat Mode (Super State)	16
Auto Mode	17
Cool Mode (Super State)	18
Special Purpose Unit Modes	21
Unit Mode Priority	23
Occupancy Modes	24
Occupied Mode	24
Unoccupied Mode	24
Standby Mode	24
Bypass Mode	25
Additional Occupancy Features	25
Networked Occupancy Sensor Capability	25
Unit-Mounted Time-Clock	25
Unit-Mounted Tenant Override Switch	25
Remote Wall-Mounted Sensor Tenant Override Switch	25
Remote Wall-Mounted Sensor Status LED	25
Space Temperature Set Points	26
Networked Set Point Capability	26
Networked Set Point Offset Capability	26
Networked Set Point Shift Capability	26
Networked Space Temperature Sensor Capability	26
Remote Wall-Mounted Sensor with +/-3°F Adjustment (optional)	27
Remote Wall-Mounted Sensor with 55°F to 85°F Adjustment (optional)	27
Effective Set Point Calculations	27
Proportional Integral (PI) Control Loops	29
Discharge Air Temperature Control	29
PI Control Parameters	30
Proportional Band	30
Integral Time	31
Indoor Air Fan Operation	31
Auto Mode	31
Occupied, Standby, and Bypass Operation	31
Unoccupied Operation	32

Cycle Fan	32
Off Delay	32
Outdoor Air Damper Operation	32
Minimum Position	32
Economizer Operation	32
Networked Space Humidity Sensor Capability	34
Networked Outdoor Humidity Sensor Capability	34
CO ₂ Demand Controlled Ventilation (optional)	34
Networked Space CO ₂ Sensor Capability	34
ASHRAE Cycle II	35
Compressor Operation	35
Compressor Envelope	35
Compressor Cooling Lockout	35
Compressor Minimum On and Off Timers	36
Compressor Start Delay	36
Outdoor Air Fan Operation	36
Floating-Point Actuator Auto-Zero, Overdrive and Sync	36
External Binary Inputs	37
External Binary Input 1	37
External Binary Input 2	37
External Binary Input 3	37
External Binary Outputs	38
External Binary Output 1	38
External Binary Output 2	38
External Binary Output 3	38
UVC Input and Output Table	40
Diagnostics and Service	41
Alarm and Fault Monitoring	41
Space Temp Sensor Failure (F0)	42
DX Pressure Fault (F1)	42
Compressor Envelope Fault (F2)	42
Discharge Air DX Cooling Low Limit Indication (F3)	42
Condensate Overflow Indication (optional) (F4)	43
Space Coil DX Temp Sensor Failure (F5)	43
Outdoor Temp Sensor Failure (F6)	43
Discharge Air Temp Sensor Failure (F7)	43
Outdoor Coil DX Temp Sensor Failure (F8)	43
Space Humidity Sensor Failure (optional) (FR)	44
Outdoor Humidity Sensor Failure (optional) (Fb)	44
Space CO ₂ Sensor Failure (optional) (FC)	44
Change Filter Indication (FF)	44
EPROM Memory Indicator (EE)	44
Configuration Display (-)	44
Troubleshooting Temperature Sensors	44
Troubleshooting Humidity Sensors	45
Troubleshooting Carbon Dioxide (CO ₂) Sensors	46
UVC Configuration Parameters	47

Introduction

This manual provides information on the MicroTech II® control system used in the AAF®-HermanNelson® Unit Ventilator product line. It describes the MicroTech II components, input/output configurations, field wiring options and requirements, and service procedures.

For installation and general information on the MicroTech II Unit Ventilator Controller, refer to IM 747, MicroTech II Unit Ventilator Controller.

For installation, commissioning instructions, and general information on a particular unit ventilator model, refer to the appropriate manual (Table 1), as well as accompanying software operating instruction manual (Table 4), and possible accessory manuals that may pertain to the unit (Table 3).

For installation and maintenance instructions on a plug-in communications card, refer to the appropriate protocol-specific installation and maintenance manual (Table 2). For a description of supported network variables for each protocol, refer to Protocol Data Packet bulletin ED 15065.

Table 1: Model-specific unit ventilator installation literature

Description	Manual #	AEQ	AER	AHB	AHF	AHR	AHV	AVB	AVF	AVH	AVR	AVS	AVV	AZB	AZR	AZS	AZU	AZQ	AZV	ARQ	ERQ	
Air Source Heat Pump	IM 502	X																				
DDC Control Components	AED-Q-MTII-811	X																				
Self-Contained	IM 503													X	X	X	X	X	X			
Self-Contained DDC Control Components	AZS Q V U R MII 810														X	X	X	X	X			
Vertical Split-system	IM 817-1							X			X	X	X									
Horizontal Split-system	IM 830			X	X	X	X	X			X	X	X									
Ceiling Vent	AH IM 830			X	X	X	X															

Table 2: Protocol-specific communication card installation literature and protocol data

Description	Manual #
Unit Ventilator Unit Controller LonWorks® Communications Module	IM 729
Unit Ventilator Unit Controller JCI N2 Open® Communications Module	IM 730
Unit Ventilator Unit Controller BACnet® Communications Module	IM 731
Protocol Data Packet	ED-15065

Table 3: Accessory-specific installation literature

Description	Manual #
MTII Unit Ventilator Controls Installation	IM 747
Room Temperature Sensors Installation	IM 629-1
ATS Service Cable Installation for Unit Ventilators	IM 762-0

Table 4: Software program literature

Description	Manual #
Air Source Heat Pump with Electric Heat (Software Model 00)	OM 748
Water Source Heat Pump with Electric Heat (Software Model 02)	OM 749
Water Source Heat Pump without Electric Heat (Software Model 03)	
DX Cooling with Electric Heat (Software Model 04)	OM 750
DX Cooling Only (Software Model 05)	OM 751
Electric Heat Only (Software Model 06)	OM 752
DX Cooling with Hydronic Heat - Valve Control (Software Model 07)	OM 753
DX Cooling with Hydronic Heat - F&BP Damper Control (Software Model 08)	
2-Pipe Hydronic Heat Only - Valve Control (Software Model 09)	OM 754
2-Pipe Hydronic Heat Only - F&BP Damper Control (Software Model 10)	
2-Pipe Chilled Water Cooling and Hot Water Heat - Valve Control (Software Model 11)	OM 755
2-Pipe Chilled Water Cooling and Hot Water Heat - F&BP Damper Control (Software Model 12)	
4-Pipe Chilled Water Cooling and Hydronic Heat - Valve Control (Software Model 13)	OM 756
4-Pipe Chilled Water Cooling and Hydronic Heat - F&BP Damper Control (Software Model 14)	
2-Pipe Chilled Water Cooling Only - Valve Control (Software Model 15)	OM 757
2-Pipe Chilled Water Cooling Only - F&BP Damper Control (Software Model 16)	
2-Pipe Chilled Water Cooling with Electric Heat - Valve Control (Software Model 17)	OM 758
2-Pipe Chilled Water Cooling with Electric Heat - F&BP Damper Control (Software Model 18)	

NOTICE

This equipment generates, uses, and can radiate radio frequency energy and, if not installed and used in accordance with this instruction manual, may cause interference to radio communications. It has been tested and found to comply with the limits for a Class A digital device, pursuant to part 15 of the FCC rules. These limits are designed to provide reasonable protection against detrimental interference when the equipment is operated in a commercial environment. Operation of this equipment in a residential area is likely to cause detrimental interference in which case users are required to correct the interference at their own expense. **McQuay International disclaims any liability resulting from any interference or for the correction thereof.**

⚠ WARNING

Electric shock hazard. Can cause personal injury or equipment damage.

This equipment must be properly grounded. Connections and service to the MicroTech II control panel must be performed only by personnel that are knowledgeable in the operation of the equipment being controlled.

⚠ CAUTION

Extreme temperature can damage system components.

The MicroTech II controller is designed to operate in ambient temperatures from -20°F to 125°F. It can be stored in ambient temperatures from -40°F to 140°F. It is designed to be stored and operated in relative humidity up to 95% (non-condensing).

⚠ CAUTION

Static sensitive components. A static discharge while handling electronic circuit boards can damage components.

Discharge any static electrical charge by touching the bare metal inside the main control panel before performing any service work. Never unplug any cables, circuit board terminal blocks, relay modules, or power plugs while power is applied to the panel.

Acronyms/Abbreviations

The following table list acronyms and abbreviations that may or may not be used within this manual. Other abbreviations for keypad displays and parameters can be found in Table 8 on page 14 and Table 26 on page 47.

Table 5: Acronyms and abbreviations

Description	Acronym/ Abr.
Air Fan	AF
Auxiliary Heat End Differential	AHED
Auxiliary Heat Start Differential	AHSD
American Standard Code for Information Interchange	ASCII
American Society of Heating, Refrigerating, and Air Conditioning Engineers, Inc	ASHRAE
Compressorized Cooling Lockout	CCLO
Space CO ₂ Setpoint	CO ₂ S
Chilled Water	CW
Chilled Water Valve Position	CWVP
Discharge Air	DA
Discharge Air High Limit	DAHL
Discharge Air Temperature	DAT
Discharge Air Temperature Setpoint	DATS
Demand Controlled Ventilation	DCV
DX Cooling Discharge Air Low Limit	DXLL
Economizer Compare Differential	ECD
Economizer IA/OA Enthalpy Differential	EED
Economizer OA Enthalpy Setpoint	EES
Emergency Heat Setpoint	EHS
Exhaust Interlock OAD Min Position Setpoint	EOAD
Outdoor Air Temperature Setpoint	EOAT
End-of-Cycle	EOC
EOC OAT Low Setpoint	EOCS
Outdoor Air Humidity Output	EORH
Space Humidity Setpoint	ERH
Economizer IA/OA Temp Differential	ETD
Economizer OA Temp Setpoint	ETS
Source (water in) Temperature	EWIT
Face and Bypass Damper Position	FBDP
Federal Communications Commission	FCC
Face and Bypass	F & BP
Heating, Ventilating, Air Conditioning Refrigeration	HVACR
Heating EOC Valve Setpoint	HEOC
Hot Water	HW
Indoor Air	IA
Indoor Air Fan	IAF
Indoor Air Temperature	IAT
Light Emitting Diode	LED
Local User Interface	LUI
Mixed Air Low Limit	MALL
Mechanical Cooling Low Limit Setpoint	MCLL
National Electric Code	NEC
Outside Air	OA
Outside Air Dampers	OAD
Energize Exhaust Fan OAD Setpoint	OADE
OAD Min Position High-Speed Setpoint	OADH
OAD Min Position Low-Speed Setpoint	OADL
OAD Min Position Med-Speed Setpoint	OADM
Outdoor Air Damper Position	OADP
OAD Lockout Setpoint	OALS
OAD Max Position Setpoint	OAMX
Outside Air Temperature	OAT

Description	Acronym/ Abr.
Occupied Cooling Setpoint	OCS
Occupied Heating Setpoint	OHS
Occupancy Override Input	OOI
Occupancy Sensor Input	OSI
Proportional Integral	PI
Parts Per Million	PPM
Positive Temperature Coefficient	PTC
Relative Humidity	RH
Space Humidity Setpoint	RHS
Read Only	RO
Read Write	RW
Standby Cooling Setpoint	SCS
Standby Heating Setpoint	SHS
Thermal Expansion Valve	TXV
Unoccupied Cooling Setpoint	UCS
Unoccupied Heating Setpoint	UHS
Unit Ventilator	UV
Unit Ventilator Controller	UVC
UVC (Heat/Cool) Mode Output	UVCM
UVC State Output	UVCS
Wet Heat Valve Position	VALP
Ventilation Cooling Low Limit Setpoint	VCLL
Ventilation Cooling Lockout	VCLO
Ventilation Cooling Setpoint	VCS
Wet Heat	WH
Source (water in) Temperature Differential	WITD

Getting Started

The MicroTech II Unit Vent Controller (UVC) is a self-contained device that is capable of complete, stand-alone operation. Information in the controller can be displayed and modified by using the keypad/display (local user interface). The following sections describe how to use the keypad/display.

Note – Many UVC parameters are accessible both through the keypad/display and the network interface. The shared keypad/display and the network interface variables have a “last-change-wins” relationship.

Using the Keypad/Display

The keypad/display shown in Figure 1 is provided with all MicroTech II Applied Unit Ventilator unit controllers. With the keypad/display, operating conditions, system alarms, and control parameters can be monitored. Set points and other parameters also can be modified.

Figure 1: Keypad/display

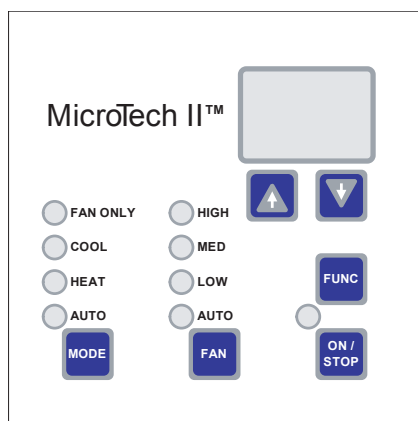

Display Format

The keypad/display’s 2-digit, 7-segment display normally shows the effective heating or cooling temperature set point (Effective Set Point Output). The display also is used to view and modify UVC parameters as explained in the following sections.

Note – When the UVC is in the OFF mode, the effective heating set point appears in the display. All other LEDs are switched off.

Keypad Functions

Security Levels

The keypad/display provides a 4-level password security feature that can be used to restrict access. The available security levels are shown in Table 6.

Note – All unit ventilator controllers ship with the lowest security (level 0) enabled. To change security levels, see Figure 2. Once a security level is changed, the keypad/display remains at that security level until the next time it is changed.

Why can’t I use the MODE or FAN key or adjust Set Point Offset?

Most likely this is due to the security feature being used. If the security feature is set higher than level 0, then some keypad/display functionality is locked out. To ensure this is not the problem, enter the level 0 password then try to use the keypad/display again.

Table 6: Keypad/display security levels

Level	Display	What is restricted?	Password
0	U0	Default level (access all)	10
1	U1	Does not allow set point offset changes; also locks out keypad/display menu access.	21
2	U2	Does not allow set point offset changes nor MODE key changes; also locks out keypad/display menu access.	32
3	U3	Does not allow set point offset changes nor MODE and FAN key changes; also locks out keypad/display menu access.	43

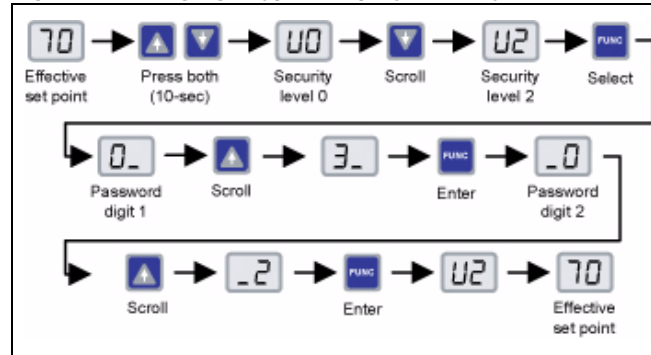
Figure 2: Changing keypad/display security levels

ON/STOP Key and LED

Use the ON/STOP key to toggle the UVC between OFF mode and running (Application Mode Input). The ON/STOP LED is off when the UVC is in the OFF mode.

- Note** – When the UVC is in the OFF mode, the effective heating set point appears in the display. All other LEDs are switched off.
- The UVC archives each change to the keypad/display FAN and MODE keys. When the ON/STOP key is used to bring the unit out of OFF mode, the UVC implements the last active fan and unit modes.
 - Each time the UVC power cycles, the UVC is in the auto fan and auto unit modes when power is returned.

WARNING

Off mode is a “stop” state for the unit ventilator. It is not a “power off” state. Power may still be provided to the unit.

FAN Key

Use the FAN key to toggle through each of the fan speeds (Fan Speed Command Input): Auto, Low, Medium, and High.

MODE Key

Use the MODE key to toggle through the keypad/display accessible unit modes (Heat/Cool Mode Input): Auto, Heat, Cool, and Fan Only.

Arrow Keys

Use the arrow keys to scroll between parameters and to adjust parameters.

FUNC Key

Use the Func key to view the actual space temperature or to confirm selection and changes to user-adjustable parameters.

Using the Keypad/Display

Viewing Actual Indoor Air Temperature (IAT)

Normally, the effective set point temperature appears on the keypad/display. You also can use the keypad/display to view the indoor air temperature (IAT). See Figure 3.

Note – When the actual indoor air temperature (Effective Space Temp Output) equals the effective set point temperature (Effective Set Point Output), you there is no change to the keypad/display when you view space temperature.

Figure 3: Viewing indoor air temperature

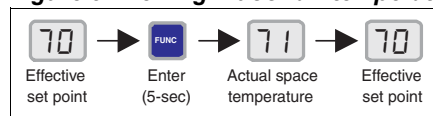

Changing Set Points

The keypad/display can be used to make a $\pm 5^{\circ}\text{F}$ ($\pm 3^{\circ}\text{C}$) offset adjustment to the effective temperature set point. See Figure 4. Also see “Space Temperature Set Points” on page 26 to learn more about temperature set points.

Figure 4: Adjusting the set point offset

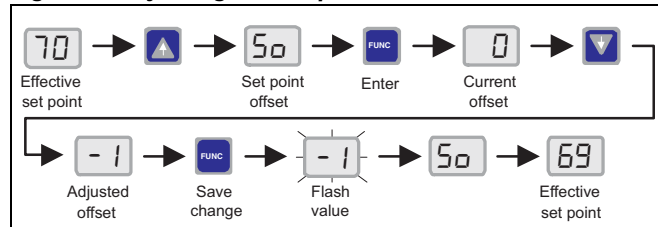

Note – The set point offset clears whenever UVC power is cycled. When you change the set point offset after a power cycle, or for the very first time, this cleared value shows as the highest allowed value ($5^{\circ}\text{F}/3^{\circ}\text{C}$) but is not an actual offset value.

- When using the $\pm 3^{\circ}\text{F}$ ($\pm 1.7^{\circ}\text{C}$) remote wall sensor, any set point offset adjustment made at the keypad/display causes the UVC to override and ignore the remote wall sensor set point adjustment knob. To use the remote wall sensor set point adjustment knob after you changed the set point offset on the keypad/display, clear the keypad/display set point offset by cycling UVC power.
- When using the 55°F to 85°F remote wall sensor, the UVC ignores any LUI set point offset adjustments.

Menu Reference

The keypad/display menu eases troubleshooting and simplifies UVC configuration. The user can access the most common parameters and system status values without a PC or network interface.

The keypad/display menu is accessed via an unmarked, *hidden* key. This hidden key is located approximately behind the letter “h” in the MicroTech II logo on the keypad/display face.

The keypad/display menu consists of two levels. The first level is the keypad/display Menu Item List containing alphanumeric characters representing each parameter. The second level is where the parameter’s value is viewed and adjusted if the parameter is adjustable. After 15-seconds, an inactivity timer automatically causes the display to back out of the menu levels, returning to the effective set point display.

Figure 5: Changing a keypad/display menu item

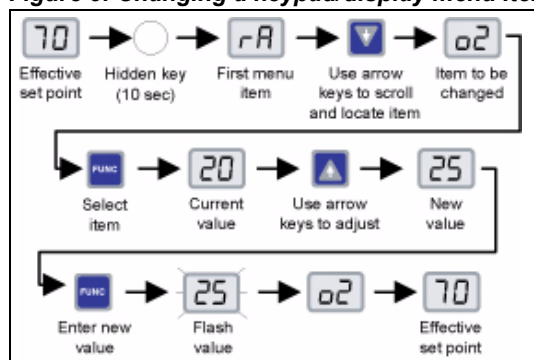

Table 7: Keypad/display menu item list

Display	Keypad menu item list	Abr.	Description	RO RW ¹	05	Default
rA	Reset Alarm Input		Enter 1 to clear alarms (clears all inactive alarms, except filter alarm). To enable the alarm again, enter 0.	RW	x	r/r ²
Hc	UVC (Heat/Cool) Mode Output	UVCM	Display current UVC mode. 1 = Heat, 3 = Cool, 4 = Night Purge, 6 = Off, 8 = Emerg. Heat, 9 = Fan Only	RO	x	
St	UVC State Output	UVCS	Display current UVC state. 1 = EconMech, 2 = Mech, 3 = Econ, 4 = DA Heat, 5 = Heat, 6 = ActiveDehum, 7 = Full Heat, 8 = Night Purge, 9 = Off, 10 = Fan Only, 11 = Heat Mode Cant Heat, 12 = CantCool, 13 = Emerg Heat Mode Cant Heat, 14 = Heat Mode Low Limit, 15 = Cool Mode Low Limit	RO	x	
d0	Discharge Air Temp Set point Output	DATS	Display current DA temperature set point.	RO	x	
d1	Discharge Air Temp Output	DAT	Display current DA temperature.	RO	x	
d2	Ventilation Cooling Low Limit set point	VCLL	Adjust economizer cooling DA temperature low limit.	RW	x	54°F (12°C)
d3	Mechanical Cooling Low Limit set point	MCLL	Adjust mechanical cooling DA temperature low limit.	RW	x	45°F (7°C)
SL	Slave Type Configuration		Set slave type: 0 = Independent (slave uses own sensors), 1 = Dependent (slave follows master). This feature requires a network over which the master and slave UVCs can communicate.	RW	x	0
Eo	Effective Occupancy Output		Display current occupancy.	RO	x	
oC	Occupancy Override Input		Set occupancy: 0 = occupied, 1 = unoccupied, 2 = bypass, 3 = standby. Adjusting this variable is intended only for troubleshooting. Once you are done, cycle unit power to clear this variable and return the UVC to normal operation.	RW	x	r/r ²
Co	Occupied Cooling set point	OCS	Adjust occupied cooling set point.	RW	x	73.4°F (23°C)
CS	Standby Cooling Set point	SCS	Adjust standby cooling set point.	RW	x	77°F (25°C)
CU	Unoccupied Cooling Set point	UCS	Adjust unoccupied cooling set point.	RW	x	82.4°F (28°C)
Ho	Occupied Heating Set point	OHS	Adjust occupied heating set point.	RW	x	69.8°F (21°C)
HS	Standby Heating Set point	SHS	Adjust standby heating set point.	RW	x	66.2°F (19°C)
HU	Unoccupied Heating Set point	UHS	Adjust unoccupied heating set point.	RW	x	60.8°F (16°C)
r5	Wall Sensor Type		Set wall sensor type: 0 = +/-3F, 1 = 55°F to 85°F.	RW	x	0
o1	Outside Air Damper Position Output	OADP	Display OA damper position.	RO	x	
o2	OAD Min Position High-Speed Set point	OADH	Adjust OA damper minimum position with IAF at high speed. (This variable is factory set to 5% open when the unit is ordered with optional CO ₂ DCV.)	RW	x	20%
o3	OAD Min Position Med-Speed Set point	OADM	Adjust OA damper minimum position with IAF at medium speed. (This variable is not used when the optional CO ₂ DCV is enabled. Only OADH is active as the OA damper minimum regardless of fan speed.)	RW	x	25%
o4	OAD Min Position Low-Speed Set point	OADL	Adjust OA damper minimum position with IAF at low speed. (This variable is not used when the optional CO ₂ DCV is enabled. Only OADH is active as the OA damper minimum regardless of fan speed.)	RW	x	30%

Display	Keypad menu item list	Abr.	Description	RO RW ¹	05	Default
05	Exhaust Interlock OAD Min Position set point	EOAD	Adjust OA damper position above which the exhaust fan output will be energized. There is a fixed -5% differential associated with this set point.	RW	x	99%
06	Energize Exhaust Fan OAD Set point	OADE	Adjust OA damper minimum position when the exhaust interlock input is energized.	RW	x	12%
07	OAD Max Position Set point	OAMX	Adjust OA damper maximum position.	RW	x	99%
08	OAD Lockout Enable		Set OA damper lockout feature status: 0 = disable, 1 = enable. (This variable is factory set to 1 when the unit is ordered as a recirc unit with no OAD.)	RW	x	0
09	OAD Lockout Set point	OALS	Adjust OA temperature below which the OA damper closes if the OA damper lockout is enabled. (This variable is factory set to -99°C when the unit is ordered as a recirc unit with no OAD.)	RW	x	35.6°F (2°C)
E1	Economizer Enable		Set economizer status: 0 = disable, 1 = enable.	RW	x	1
E2	Economizer OA Temp Set point	ETS	Adjust economizer OA temperature set point. DO NOT lower this set point below CCLO or you risk creating a deadband where no cooling occurs.	RW	x	68°F (20°C)
E3	Economizer IA/OA Temp Differential	ETD	Adjust economizer IA/OA temperature differential.	RW	x	1.8°F (1°C)
E5	Economizer OA Enthalpy Set point	EES	Adjust economizer OA enthalpy set point.	RW	x	25 Btu/lb (58 kJ/kg)
E6	Economizer IA/OA Enthalpy Differential	EED	Adjust economizer IA/OA enthalpy differential.	RW	x	1.3 Btu/lb (3 kJ/kg)
r1	Space Humidity Output	ERH	Display room humidity (optional). 00 = No sensor connected.	RO	x	
r3	Outdoor Air Humidity Output	EORH	Display OA humidity (optional). 00 = No sensor connected.	RO	x	
0t	Outdoor Air Temp Output	EOAT	Display OA temperature.	RO	x	
H1	Emergency Heat Enable		Set emergency heat status: 0 = disable, 1 = enable.	RW	x	1
H2	Emergency Heat Set point	EHS	Adjust emergency heat set point.	RW	x	53.6°F (12°C)
H3	Emergency Heat Shutdown Configuration		Set emergency heat operation during shutdown, 0 = no emergency heat during shutdown: 1 = allow emergency heat during shutdown.	RW	x	0
A1	Auxiliary Heat Start Differential	AHSD	Adjust auxiliary heat start differential.	RW	x	1.8°F (1°C)
A2	Auxiliary Heat End Differential	AHED	Adjust auxiliary heat stop differential.	RW	x	1.8°F (1°C)
A3	Auxiliary Heat Configuration		Set auxiliary heat type: 0 = N.O. device, 1 = N.C. device.	RW	x	0
b3	External BI-3 Configuration		Set the function external binary Input 3: 0 = ventilation lockout, 1 = exhaust interlock.	RW	x	0
b6	External BO-3 Configuration		Set the function of external binary output 3: 0 = exhaust fan on/off signal, 1 = auxiliary heat.	RW	x	0
CF	Fan Cycling Configuration		Set space fan cycles (switches off) during occupied, bypass, and standby mode: 2 = continuous, 3 = cycling.	RW	x	2
CE	Filter Alarm Enable		Set filter alarm status: 0 = disable, 1 = enable.	RW	x	0
Cr	Reset Filter Alarm Input		Enter 1 to clear filter alarm.	RW	x	r ^r 2
C1	Compressor Enable		Set compressor status: 0 = disable, 1 = enable.	RW	x	1
C2	Compressor Cooling Lockout Set point	CCLO	Adjust compressor cooling lockout set point. When the OA temperature falls below this set point, compressor cooling is not allowed. DO NOT make this setting lower than the factory default. There is a fixed +3.6°F (2°C) differential associated with this set point.	RW	x	63.5°F (17.5°C)
C3	Compressor Heating Lockout Set point	CHLO	Adjust compressor heating lockout set point. When the OA temperature falls below this set point, compressor heating is not allowed and only electric heat will be used.	RW	x	25°F (-4°C)
C6	Compressor Start Delay		Adjust compressor start delay. Where several units (inductive loads) are connected to the same electrical supply, make this set point unique for every UVC to prevent multiple compressors from energizing at the same time after a power failure or occupancy change.	RW	x	0 sec
SP	Space Temp Sensor Offset		Adjust this setting to bias the UVC measured space temperature.	RW	x	0
Un	Keypad/display Temperature Units		Set keypad/display temperature units in English or SI. This set point also effects which unit types displayed over Metasys N2 and BACnet MS/TP networks using the appropriate optional communications modules.	RW	x	F

1. RW = read and write capable, RO = read only.

2. If a menu value is greater than 2-digits (higher than 99), then r^r will be displayed on the keypad/display.

Description of Operation

State Programming

The MicroTech II UVC takes advantage of “state” machine programming to define and control unit ventilator operation. “State” defines specific states or modes of operation for each process within the unit ventilator (e.g., heating, cooling, etc.) and contain the specific logic for each state. This eliminates some of the most common problems associated with control sequences such as the possibility of simultaneous heating and cooling, rapid cycling, etc.

State machine programming, and the unique nature of state diagrams, can be easily used to describe operation. It can simplify sequence verification during unit commissioning, as well as simplify troubleshooting. With the unique combination of state machine programming and the keypad/display’s ability to allow a technician to easily determine the active UVC state, troubleshooting the UVC can be very simple.

The state diagrams presented in the following sections consist of several “elements” including super states, states, conditional jumps (also called transitions) and transition points. Super states are used as a means to group two or more related states into a single control function such as cooling, or heating, etc. States are where all the actual work takes place, within each state the UVC enables PI-loops and other logic sequences required to control unit ventilator operation within that particular state, while other functions and PI-loops not needed during that state may be disabled. Conditional jumps, or transitions, are the logic paths used by the UVC to determine which state should be made active, these are the “questions” the UVC continually considers. The transition point is simply a point through which a number of conditional jumps meet. Think of it as a point where a number of questions must be considered from which the UVC then determines which path is followed and which state is then made active.

The UVC states and super states are used to define the “normal” unit modes, such as Off, Night Purge, Fan Only, Emergency Heat, Auto, Cool, and Heat. The UVC also supports several “special purpose” unit modes such as Purge, Pressurize, De-pressurize, and Shutdown, which can be forced via a network connection and override typical UVC operation.

Note – Not all states or modes are available for all UV configurations, and some states (such as Active Dehum) are optional.

- In the state descriptions below the terms, saturated high and saturated low, indicate that the heating or cooling function being described has reached 100% or 0%, respectively.

Figure 6: Complete UVC—state diagram

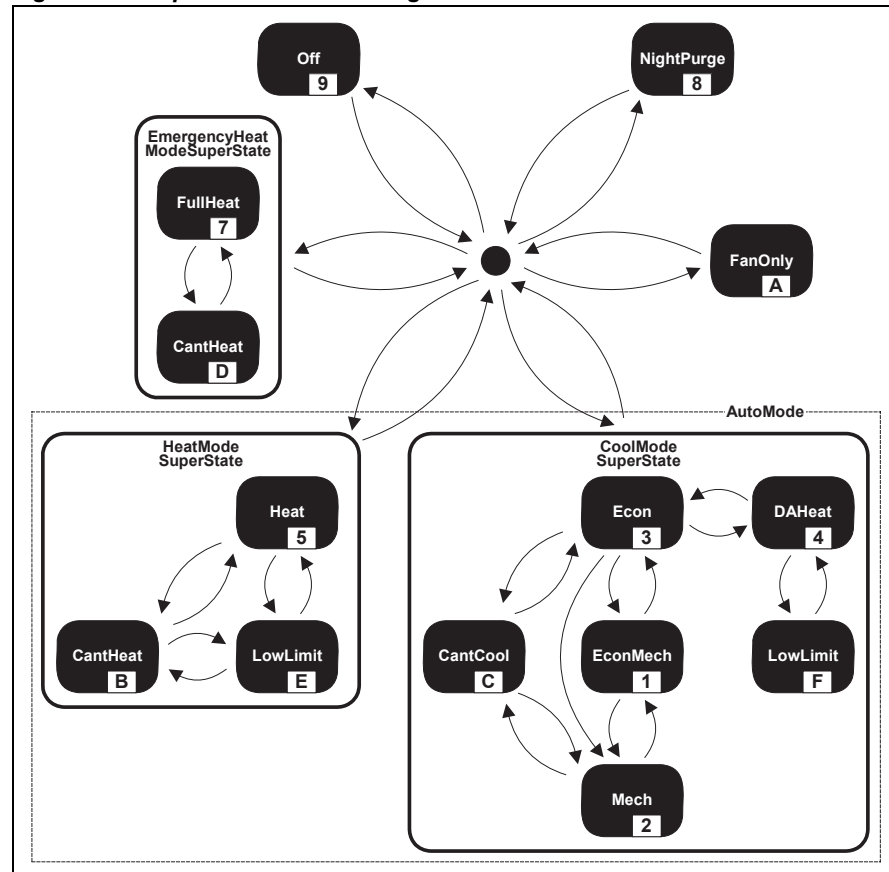

UVC Unit Modes

The UVC provides several “normal” modes of unit operation. These include: Off, Night Purge, Fan Only, Cool, Emergency Heat, Auto, Heat, and Cool.

Normal UVC modes can contain a single state or several states depending upon the functionality required for each particular mode. Each UVC state is assigned a number, which can be very helpful when trying to understand which state is currently active within the UVC. To view the current UVC state number, use the keypad/display.

Table 8: UVC state names and numbers

Normal UVC modes	State names	State numbers			
		Decimal	ASCII	Hex	
OFF	OFF	9	9	57	
Night purge	Night Purge	8	8	56	
Fan only	Fan Only	10	A	65	
Emergency heat	Full Heat	7	7	55	
	Cant Heat	13	D	68	
Auto	Heat	Heat	5	5	53
		Cant Heat	11	B	66
		Low Limit	14	E	69
	Cool	EconMech	1	1	49
		Mech	2	2	50
		Econ	3	3	51
		DA Heat	4	4	52
		Cant Cool	12	C	67
		Low Limit	15	F	70

WARNING

Off mode is a “stop” state for the unit ventilator. It is not a “power off” state. Power may still be provided to the unit.

OFF Mode (State 9)

Off mode is provided so that the UVC can be forced into a powered OFF condition. OFF mode is a “stop” state for the unit ventilator; it is not a power off state. OFF mode consists of a single UVC state: OFF [9].

When OFF mode becomes active, the UVC stops all normal heating, cooling, and ventilation (OA damper is closed), and fan operation ends. The UVC continues to monitor space conditions, indicate faults, and provide network communications (if connected to a network) in the OFF mode while power is maintained to the unit.

While in OFF mode, the UVC does not maintain DA temperatures. If the space temperature drops below EHS while in the OFF mode, the UVC is forced into the Emergency Heat mode (see “Emergency Heat Mode (Super State)” on page 16).

The space lighting output continues to operate based upon the current occupancy mode.

Note – Special purpose unit modes such as Purge, Pressurize, and De-pressurize can force the UVC to perform “special” functions during which the display appears to be in the OFF mode.

Figure 7: Off state diagram

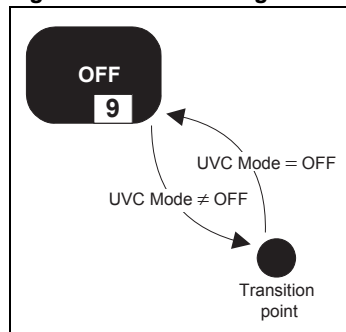

Night Purge Mode (State 8)

Night Purge mode is provided as a means to more easily and quickly ventilate a space. Night purge can be useful in helping to remove odor build up at the end of each day, or after cleaning, painting, or other odor generating operations occur within the space. Night Purge mode consists of a single UVC state: Night Purge [8].

Night Purge is a full ventilation with exhaust mode, during which room comfort is likely to be compromised. Therefore, McQuay strongly recommends using Night Purge only when the space is unoccupied.

When Night Purge mode becomes active, the UVC stops all normal heating and cooling. Since any new energy used to treat the incoming air would be wasted in the purge process. In the Night Purge mode, the space fan is set to high speed, the OA damper is set to 100% open, and the Exhaust Fan binary output (see “External Binary Outputs” on page 38) is set to ON. If the UVC is not set to another mode within 1 hour (fixed), the UVC automatically switches to the Fan Only mode (see “Fan Only Mode (State A)” on page 15).

While in Purge mode, the UVC does not maintain DA temperatures. If the space temperature drops below the EHS, the UVC is forced into the Emergency Heat mode (see “Emergency Heat Mode (Super State)” on page 16).

Figure 8: Night purge state diagram

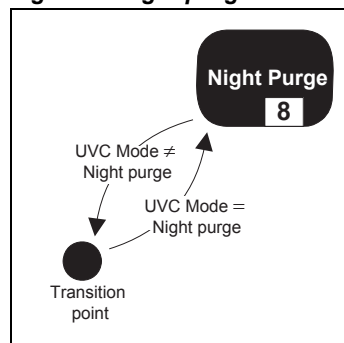

Fan Only Mode (State A)

The Fan Only mode is provided so that the UVC can be forced into a Fan Only operation via a keypad/display or a network connection. Fan Only mode consists of a single UVC state: Fan Only [A].

When Fan Only mode becomes active, the UVC stops all normal heating and cooling.

While in Fan Only mode, the UVC does not maintain DA temperatures. If the space temperature drops below the EHS, the UVC is forced into the Emergency Heat mode (see “Emergency Heat Mode (Super State)”).

Figure 9: Fan only state diagram

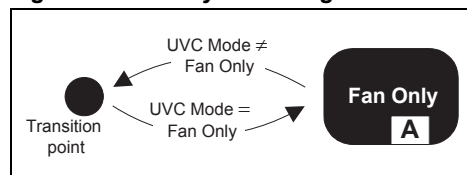

Emergency Heat Mode (Super State)

The Emergency Heat mode is provided for situations where the UVC is in a mode that does not normally allow heating, such as OFF, Cool, Night Purge, or Fan Only. If Emergency Heat mode is enabled, the UVC can automatically force itself into the Emergency Heat mode from OFF, Cool, Night Purge, Fan Only, Purge, Pressurize, De-pressurize, and Shutdown. Emergency Heat mode consists of UVC states: Full Heat [7] and Cant Heat [D].

Software model 05 does not have the primary or secondary heating devices. The UVC uses auxiliary heat (if field provided and field connected) when emergency heat is required.

When the Emergency Heat mode becomes active, the UVC automatically determines which state to make active, Full Heat [7], or Cant Heat [D], based on the transitions for each of those states.

Figure 10: Emergency heat state diagram

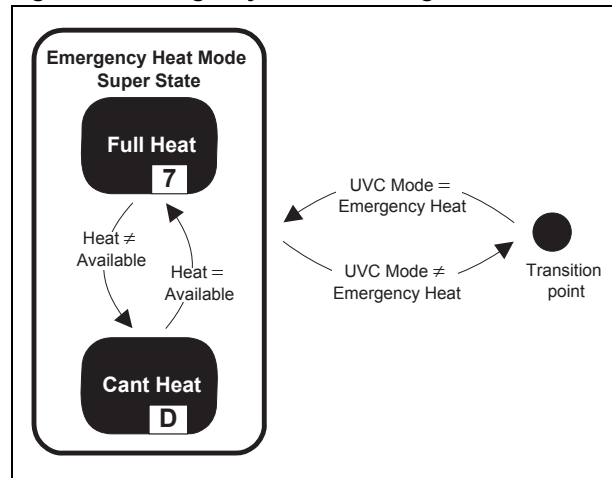

Full Heat State (State 7)

The Full Heat [7] state is the “normal” state that the UVC goes into when Emergency Heat mode is active. It is activated when the space temperature is lower than the EHS.

When Emergency Heat mode becomes active, the UVC goes into 100% heating until the space temperature raises to the EHS plus a fixed differential (5.4°F/3°C). In the Emergency Heat mode, the space fan is set to high speed, and the OA damper operates normally.

If the UVC automatically forces itself into the Emergency Heat mode from another mode (e.g., Cool, Fan Only, etc.), then the UVC returns to the appropriate unit mode once the space temperature rises to the EHS plus a fixed differential (5.4°F/3°C).

The UVC monitors the DAT to ensure it does not exceed DAHL. If the DAT does exceed DAHL, then heating is set to 0% for a minimum of 2-minutes (fixed) and until the DAT drops 36°F (20°C) fixed differential below DAHL.

Cant Heat State (State D)

The Cant Heat [D] state is a “non-normal” state that the UVC can go into when Emergency Heat mode is active. An IAT or DAT sensor fault during Emergency Heat mode causes the UVC to make this state active.

When the Cant Heat state becomes active, the space fan remains at high speed as set during the Full Heat state.

The UVC will remain in the Cant Heat state until heat becomes available.

Auto Mode

Auto mode is provided so that the UVC can be set to automatically determine if heating or cooling is required. Auto mode is the default power-up UVC mode. Auto mode is made up of the Heat and Cool modes. When the UVC is set to auto mode, the UVC automatically determines which mode (Heat or Cool) to use.

Heat Mode (Super State)

When in Heat mode, the UVC will use auxiliary heat (if field provided and field connected to the unit) as needed to maintain the effective heating setpoint (see “Space Temperature Set Points” on page 26). The keypad/display or a network connection can be used to force the unit into the Heat mode. Additionally, the UVC when set to Auto mode can automatically force the unit into the Heat mode as needed. When the UVC is in Auto mode, it is “normal” for the UVC to “idle” in Heat mode when there is no need to switch to another mode.

The Heat mode super state consists of UVC states: Heat [5], Low Limit [E], and Cant Heat [B].

When the Heat mode super state becomes active, the UVC automatically determines which of the Heat Mode states to make active based upon the transitions for each state.

Figure 11: Heat mode super state diagram

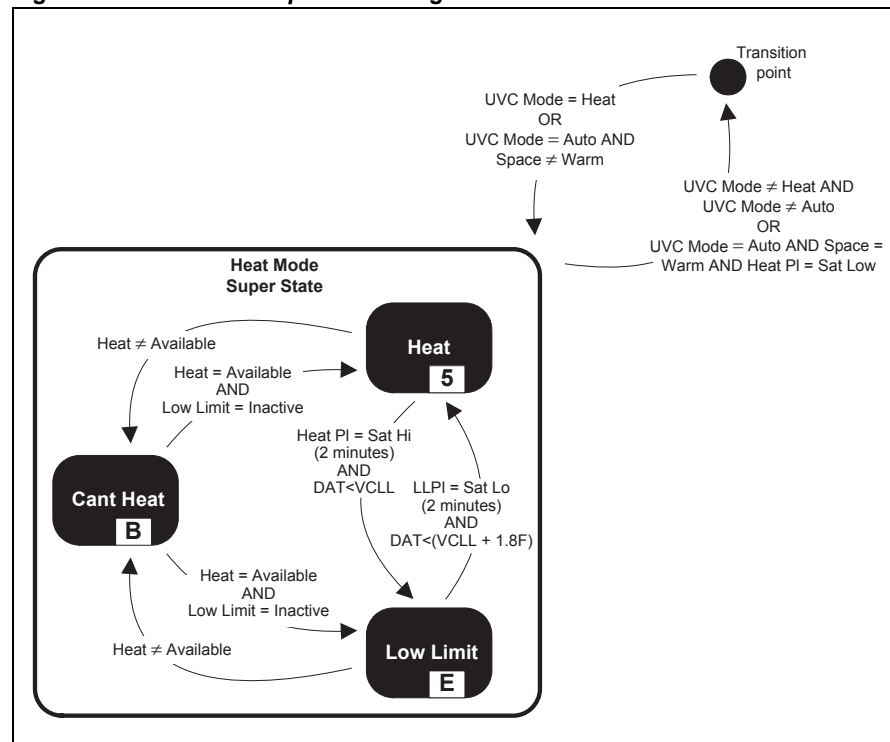

Heat State (State 5)

The Heat state is the “normal” state during Heat mode. When the Heat state becomes active, the UVC will (within State) continually calculate the DATS (“Discharge Air Temperature Control” on page 29) required to maintain the effective heat setpoint (see “Space Temperature Set Points” on page 26). The calculated DATS will not be allowed to go above DAHL. The UVC will use auxiliary heat (if field provided and field connected to the unit) as needed to maintain the current DATS. The auxiliary heat binary output will be used as needed. The Heat Timer (3-minutes fixed) will begin counting. The CO₂ demand controlled ventilation function will be active, if the unit is equipped for CO₂ control (see “CO₂ Demand Controlled Ventilation (optional)” on page 34), and the OA damper will be adjusted as needed to maintain the CO₂ setpoint. The UVC will remain in this state until one of the transition out conditions become true, or until one of the super state transition out conditions becomes true.

Note – The OAD is considered to be in “alarm” when the OAD is forced below the active minimum position in the Low Limit state. This is not an actual unit “alarm” or “fault” condition, but only a condition used for the purpose of transition arguments.

Low Limit State (State E)

The Low Limit state is a “non-normal” state the UVC can go into while Heat mode is active when the unit reaches 100% heating and still cannot meet the current DATS (see “Discharge Air Temperature Control” on page 29) required to maintain the effective heating set point (see “Space Temperature Set Points” on page 26). This is likely to occur only if the OA temperature is very cold, the OA damper minimum position is set too high, the unit ventilator is oversized for the application, or if the electric heating has failed, or is set incorrectly.

When the Low Limit state becomes active, the Low Limit PI-loop can override the OA damper position (see “Outdoor Air Damper Operation” on page 32) and adjust the OA damper toward closed as necessary to maintain the current DATS (see “Discharge Air Temperature Control” on page 29).

Cant Heat State (State B)

The Cant Heat state is a “non-normal” state the UVC can go to when Heat mode is active. An IAT or DAT sensor fault during the Heat mode causes the UVC to make this state active.

When the Cant Heat state becomes active, no heating or ventilation takes place. The OA damper goes to the minimum position unless it is forced closed by other functions such as freezestat (T6) or morning warm-up.

Cool Mode (Super State)

When in Cool mode the UVC uses primary cooling (economizer) and secondary cooling (mechanical, DX) as needed to maintain the effective cooling set point (see “Space Temperature Set Points” on page 26). The keypad/display or network connection can be used to force the unit into the Cool mode. When the UVC is in Auto mode, it is “normal” for the UVC to “idle” in Cool mode when there is no need to switch to another mode. The Cool mode super state consists of the following UVC states: Econ Mech [1], Mech [2], Econ [3], DA Heat [4], Low Limit [F], and Cant Cool [C].

When the Cool mode super state becomes active, the UVC will automatically determine which UVC state to make active based upon the transitions for each state.

If the space temperature drops below EHS, and the Emergency Heat function is enabled, the UVC will be forced into the Emergency Heat mode (see “Emergency Heat Mode (Super State)” on page 16).

Figure 12: Cool mode super state diagram

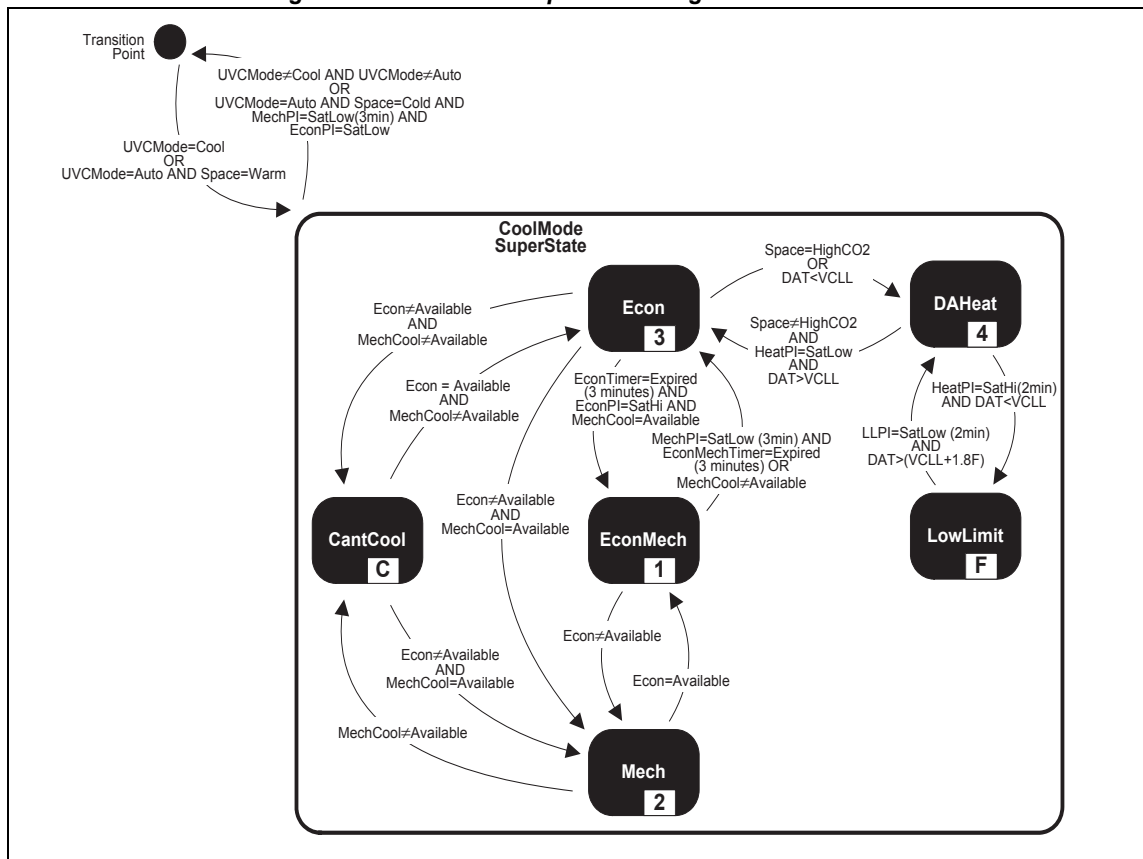

Econ State (State 3)

The Econ state is a “normal” state during Cool mode. The Econ state typically is active in the Cool mode when primary cooling (economizer) is available and adequate to meet the cooling requirements.

When the Econ state becomes active, the UVC uses economizer cooling (see “Economizer Operation” on page 32) as needed to maintain the effective cooling set point (see “Space Temperature Set Points” on page 26). If cooling is not required while in the Econ state, the UVC can “idle” in the Econ state until cooling is required or until there is a call to switch to another mode or state.

The UVC monitors the DAT to ensure it does not fall below VCLL.

The CO₂ demand controlled ventilation function (optional) will be active (see “CO₂ Demand Controlled Ventilation (optional)” on page 34) and the OA damper is adjusted as needed to maintain the CO₂ set point.

Figure 13: Econ state operation (occupied mode and auto fan)

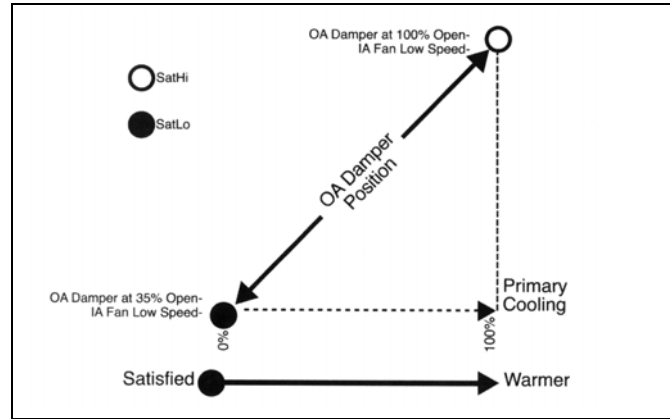

Econ Mech State (State 1)

The Econ Mech state is a “normal” state during Cool mode. The Econ Mech state typically is active in the Cool mode when primary cooling (economizer) alone is not adequate to meet the cooling requirements and both primary cooling and secondary cooling (compressor) are available.

When the Econ Mech state becomes active, the OA damper is set to 100% open, and the UVC uses the units mechanical cooling capabilities as needed to maintain the effective cooling set point (see “Space Temperature Set Points” on page 26).

The UVC monitors the DAT to ensure it does not fall below MCLL.

Figure 14: Econ mech state operation (occupied mode and auto fan)

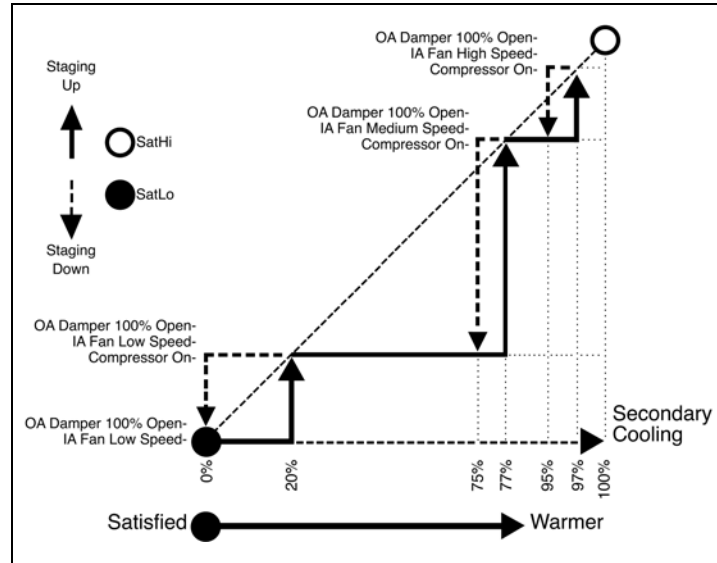

Mech State (State 2)

The Mech state is a “normal” state during Cool mode. The Mech state typically is active in the Cool mode when primary cooling (economizer) is not available and secondary cooling (compressor) is available.

When the Mech state becomes active, the UVC uses the unit’s mechanical cooling capabilities as needed to maintain the effective cooling set point (see “Space Temperature Set Points” on page 26). If cooling is not required while in the Mech state, the UVC can “idle” in the Mech state until cooling is required or until there is a call to switch to another mode or state. The UVC monitors the DAT to ensure it does not fall below MCLL.

The CO₂ demand controlled ventilation function (optional) is active (see “CO₂ Demand Controlled Ventilation (optional)” on page 34), and the OA damper is adjusted as needed to maintain the CO₂ set point.

Figure 15: Mech state operation (occupied mode and auto fan)

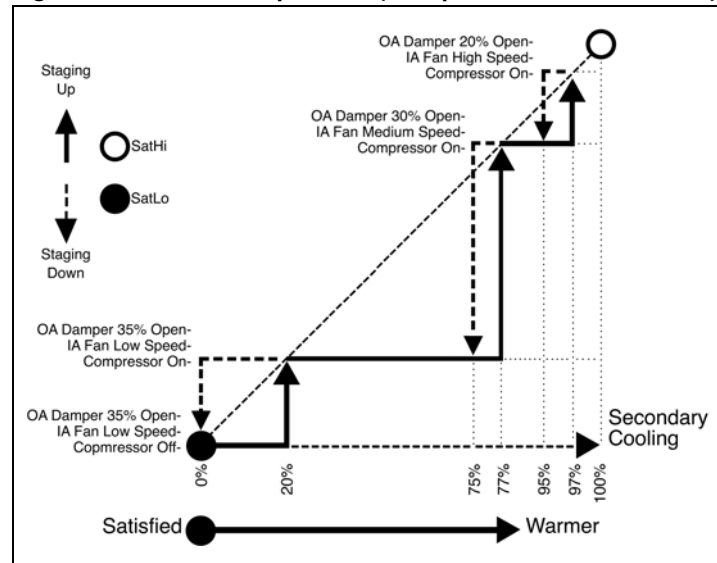

Discharge Air (DA) Heat State (State 4)

The DA Heat state is a “normal” state during Cool mode. The DA Heat state typically is active when reheat is required to maintain DATS while maintaining the required OA damper position. The DA Heat state can also be made active if the optional CO₂ DCV feature is provided and CO₂ levels are high, requiring the OA damper to open beyond what is required for economizer cooling.

When DA Heat state is active, the UVC uses the units heating capability as needed to maintain VCLL. The CO₂ demand controlled ventilation function (optional) is active (see “CO₂ Demand Controlled Ventilation (optional)” on page 34), and the OA damper is adjusted as needed to maintain the CO₂ set point.

Low Limit State (State F)

The Low Limit state is a “non-normal” state during Cool mode. The Low Limit state typically follows the DA Heat state when the UVC reaches 100% heat and still cannot maintain VCLL.

When the Low Limit state becomes active, the Low Limit PI-loop overrides the OAD minimum position (see “Outdoor Air Damper Operation” on page 32) and adjusts the OAD toward closed as necessary to maintain the DAT set point (see “Discharge Air Temperature Control” on page 29).

Cant Cool State (State C)

The Cant Cool state is a “non-normal” state during Cool mode. The Cant Cool state typically becomes active when both primary (economizer) and secondary (compressor) cooling are not available (or they are disabled) or when an IAT, DAT or OAT sensor failure occurs.

When the Cant Cool state becomes active, no cooling is available.

Special Purpose Unit Modes

There are some additional UVC modes that are considered special purpose unit modes. These special purpose modes include Pressurize, Depressurize, Purge, Shutdown, and Energy Hold Off. These modes force the UVC to perform very specific and limited functions. Use these with caution and only for short periods as needed.

In each of these special purpose UVC modes, if the space temperature drops below EHS and the Emergency Heat function is enabled, the UVC is forced into the Emergency Heat mode (see “Emergency Heat Mode (Super State)” on page 16) and then return once the Emergency Heat function is satisfied.

Table 9: Actions during special purpose unit modes

Action	Indoor air fan (IAF)	Outdoor air damper (OAD)	Exhaust fan output
Pressurize	High	100% Open	Off
Depressurize	Off	Closed	On
Purge	High	100% Open	On
Shutdown	Off	Closed	Off
Energy hold off	Off	Closed	Off

Pressurize Mode

When in Pressurize mode, the UVC uses the IAF, OAD, and exhaust output as needed to pressurize the space. The UVC stops all normal heating and cooling but does allow emergency heat if required. The pressurize mode can only be accessed via a network connection.

Depressurize Mode

When in Depressurize mode the UVC will use the IAF, OAD, and exhaust output as needed to depressurize the space. The UVC stops all normal heating and cooling but does allow emergency heat if required. The de-pressurize mode can only be accessed via a network connection or with ServiceTools for MicroTech II Applied Terminal Unit Controllers (ATS).

Purge Mode

When in Purge mode, the UVC uses the IAF, OAD, and exhaust output as needed to purge the space. The UVC stops all normal heating and cooling but does allow emergency heat if required. The purge mode can only be accessed via a network connection or with ServiceTools for MicroTech II Applied Terminal Unit Controllers (ATS).

Shutdown Mode

Shutdown mode is the equivalent of the Off mode, but is an Off mode forced by a network connection. When in Shutdown mode, the UVC stops all normal heating, cooling, ventilation (OA damper is closed), and fan operation. By default emergency heat is not be used during the shutdown mode, however, the UVC can be configured (Emergency Heat Shutdown Configuration) to allow emergency heat operation during shutdown mode. The shutdown mode can be accessed via a network connection, a binary input to the UVC, or with ServiceTools for MicroTech II Applied Terminal Unit Controllers (ATS).

WARNING

Shutdown mode and energy hold off mode are a “stop” state for the unit ventilator. It is not a “power off” state.

Energy Hold Off Mode

The UVC supports an energy hold off state, which when active forces the UVC to stop all normal heating, cooling and ventilation. Typically used by a network connection to force the UVC to cease heating, cooling and ventilation when conditions exist where heating, cooling and ventilation are not required or desired. Energy hold off mode is very similar to shutdown mode except that energy hold off always allows emergency heat if required. The energy hold off mode can only be accessed via a network connection or with ServiceTools for MicroTech II Applied Terminal Unit Controllers (ATS).

Unit Mode Priority

The UVC uses the network variables and binary inputs listed in Table 10 and Table 11 to determine the current unit mode. Special purpose UVC unit modes have higher priority than the normal UVC unit modes as shown in the tables.

Each table lists the highest priority items on the left to the lower priority items to the right. The right-most columns indicate unit operation as a result of the left-most columns. The term “Don’t care” in these tables implies that another network variable or binary input to the left has a higher priority.

Table 10: Special purpose UVC unit mode priority

Emergency override input ¹	Remote shutdown binary input	Energy hold off input ¹	Priority result		
			Energy hold off output ²	Unit mode output ²	Actual UVC action
Normal ³	De-energized ⁴	Normal	Normal	See the normal UVC mode priority (Table 11)	
		Energy hold off	Energy hold off	Off	Off
	Energized ⁵	Don't care	Energy hold off	Off	Off
Pressurize	Don't care	Don't care	Don't care	Off	Pressurize
De-pressurize	Don't care	Don't care	Don't care	Off	De-pressurize
Purge	Don't care	Don't care	Don't care	Off	Purge
Shutdown	Don't care	Don't care	Don't care	Off	Off

1. Network input.
2. Network output.
3. Normal indicates the UVC power-up condition.
4. De-energized indicates that the contacts connected to this binary input are open.
5. Energized indicates that the contacts connected to this binary input are closed.

Table 11: Normal UVC mode priority

Application override input ¹	Unit mode override input ¹	Priority result
		Unit mode output ²
Normal (Auto) ³	Normal (Auto) ³	Heat
		Cool
		Emergency heat
	Heat	Heat
	Cool	Cool
	Night purge	Night purge
	Off	Off
	Emergency heat	Emergency heat
Heat	Don't care	Heat
Cool	Don't care	Cool
Night purge	Don't care	Night purge
Off	Don't care	Off
Emergency heat	Don't care	Emergency heat
Fan only	Don't care	Fan only

1. Network input.
2. Network output.
3. Normal (Auto) is the normal UVC power-up state.

Occupancy Modes

The UVC is provided with four occupancy modes: Occupied, Standby, Unoccupied, and Bypass. The occupancy mode affects which heating and cooling temperature set points are used, affects IAF operation, and affects OAD operation. The Manual Adjust Occupancy and Networked Occupancy Sensor network variables, along with the Unoccupied and Tenant Override binary inputs, are used to determine the Effective Occupancy. The term “Don’t care” in Table 12 implies that another network variable or binary input to the left has a higher priority.

Note – The Occupancy Override Input is provided as a way for a network connection to manually force the UVC into a particular occupancy mode. The Occupancy Override Input can override the tenant override feature. For example, if the network uses the Occupancy Override Input to force the unit into unoccupied mode, then the tenant override switch does not operate as expected. Therefore, McQuay strongly recommends using the Occupancy Sensor Input to control occupancy modes over a network and only using the Occupancy Override Input if there is reason to ensure tenant override does not occur.

Table 12: Occupancy mode priority

Occupancy Override input	Occupancy sensor input ¹	Unoccupied binary input	Priority result	
			Effective occupancy output ²	
Occupied	Don't care	Don't care	Occupied	
Unoccupied	Don't care	Don't care	Unoccupied	
Bypass	Occupied	Don't care	Occupied	
	Unoccupied	Don't care	Bypass	
	Null (default)	Null (default)	Contacts open (Occupied)	Occupied
Contacts Closed (Unoccupied)			Bypass	
Standby	Don't care	Don't care	Standby	
Null (default) ³	Occupied	Don't care	Occupied	
	Unoccupied	Don't care	Unoccupied ⁴	
	Null (default)	Null (default)	Contacts open (Occupied)	Occupied
			Contacts closed (Unoccupied)	Unoccupied ⁴

1. Network input.

2. Network output.

3. Typical operation is defined in this row of the table.

4. The tenant override switch (unit or wall sensor mounted) can be used here to force the UVC into bypass.

Occupied Mode

The occupied mode is the normal day time mode of UVC operation. During occupied mode the UVC uses the occupied heating and cooling set points, the OAD operates normally, and by default the IAF remains on.

Unoccupied Mode

The unoccupied occupancy mode is the normal night time mode of UVC operation. During unoccupied mode the UVC uses the unoccupied heating and cooling set points, the OAD remains closed, and the IAF cycles as needed for heating or cooling. The IAF remains off when there is no need for heating or cooling.

Standby Mode

The standby mode is a special purpose daytime mode of UVC operation. During standby mode the UVC uses the standby heating and cooling set points, the OAD remains closed, and by default the IAF remains on.

Bypass Mode

The bypass mode (also called Tenant Override) is the equivalent of a temporary occupied mode. Once the bypass mode is initiated, it remains in effect for a set period of time (120 minutes, default). During the bypass mode, the UVC uses the occupied heating and cooling set points, the OAD operates normally, and by default the IAF remains on.

Additional Occupancy Features

Networked Occupancy Sensor Capability

A networked occupancy sensor can be interfaced with the Occupancy Sensor Input variable to select occupancy modes. When the Occupancy Sensor Input variable is used, it automatically overrides any hard-wired unoccupied binary input signal.

Unit-Mounted Time-Clock

An optional unit-mounted factory-installed electronic 24-hour/7-day time clock can be provided on stand-alone unit ventilator configurations. It is factory wired to the UVC unoccupied binary input and can be set to automatically place the unit into occupied and unoccupied modes based upon its user configured schedule.

Unit-Mounted Tenant Override Switch

A tenant override switch is factory installed in all floor mounted units and is located near the LUI on the unit. This switch provides a momentary contact closure that can be used by room occupants to temporarily force the UVC into the bypass occupancy mode from unoccupied mode.

Note – The Occupancy Override Input can override the tenant override feature. For example, if the network uses the Occupancy Override Input to force the unit into unoccupied mode, then the unit-mounted tenant override switch does not operate as expected. Therefore, McQuay strongly recommends using the Occupancy Sensor Input to control occupancy modes over a network and only using the Occupancy Override Input if there is reason to ensure tenant override does not occur.

Remote Wall-Mounted Sensor Tenant Override Switch

The optional remote wall-mounted sensors include a tenant override switch. This switch provides a momentary contact closure that can be used by room occupants to temporarily force the UVC into the bypass occupancy mode from unoccupied mode.

Note – The Occupancy Override Input can override the tenant override feature. For example, if the network uses the Occupancy Override Input to force the unit into unoccupied mode, then the wall sensor tenant override switch does not operate as expected. Therefore, McQuay strongly recommends using the Occupancy Sensor Input to control occupancy modes over a network and only using the Occupancy Override Input if there is reason to ensure tenant override does not occur.

Remote Wall-Mounted Sensor Status LED

The optional remote wall-mounted sensors each include a UVC status LED. This status LED aids diagnostics by indicating the UVC occupancy mode and fault condition.

Table 13: Remote wall-mounted sensor status LED

Indication	LED operation
Occupied	On continually
Unoccupied	On 1 second/off 9 seconds
Bypass	On continually
Standby	On 9 seconds/off 1 second
Fault	On 5 seconds/off 5 seconds

Space Temperature Set Points

The UVC uses the six occupancy-based temperature set points as the basis to determine the Effective Set point Output. The effective set point is calculated based on the unit mode, the occupancy mode, and the values of several network variables. The effective set point then is used as the temperature set point that the UVC maintains.

Table 14: Default occupancy-based temperature set points

Temperature set point	Abbreviation	Defaults
Unoccupied cool	UCS	82.4°F (28.0°C)
Standby cool	SCS	77.0°F (25.0°C)
Occupied cool	OCS	73.4°F (23.0°C)
Occupied heat	OHS	69.8°F (21.0°C)
Standby heat	SHS	66.2°F (19.0°C)
Unoccupied heat	UHS	60.8°F (16.0°C)

Networked Set Point Capability

The Space Temp Setpoint Input variable is used to allow the temperature set points for the occupied and standby modes to be changed via the network; the unoccupied set points are not affected by this variable.

Networked Set Point Offset Capability

The Networked Set Point Offset Input variable is used to shift the effective occupied and standby temperature set points by adding the value of the Setpoint Offset Input variable to the current set points; the unoccupied points are not affected by this variable. This variable is typically set bound to a supervisory network controller or to a networked wall module having a relative set point knob.

Use the keypad/display to make adjustments to the value of the Setpoint Offset Input variable. See “Changing Set Points” on page 9.

Note – The keypad/display and the network both affect the Set Point Offset Input variable. Keep in mind that changes to this variable are last-one-wins.

Networked Set Point Shift Capability

The Set Point Shift Input variable is used to shift the effective heat/cool set points. It typically is bound to a networked supervisory controller or system that provides functions such as outdoor air temperature compensation. All occupied, standby, and unoccupied set points are shifted upward (+) or downward (–) by the corresponding value of the Set Point Shift Input variable.

Note – The Set Point Shift Input capability is not available through the BACnet® interface.

Networked Space Temperature Sensor Capability

A networked space temperature sensor can be interfaced with the Space Temp Input variable. When the Space Temp Input variable is used (valid value), it automatically overrides the hard-wired space temperature sensor.

Remote Wall-Mounted Sensor with $\pm 3^{\circ}\text{F}$ Adjustment (optional)

When the optional remote wall-mounted sensor with $\pm 3^{\circ}\text{F}$ adjustment dial is used, the UVC effectively writes the value of the set point adjustment dial to the Set Point Offset Input variable.

- Note** – If a network connection is used to adjust the Set Point Offset Input variable, you must not use the optional remote wall-mounted sensor with $\pm 3^{\circ}\text{F}$ adjustment.
- If the keypad/display is used by room occupants to adjust the Set Point Offset, do not use the optional remote wall-mounted sensor with $\pm 3^{\circ}\text{F}$ adjustment. If you have the optional remote wall-mounted sensor with $\pm 3^{\circ}\text{F}$ adjustment and an occupant uses the keypad to make Set Point Offset adjustments, this overrides any $\pm 3^{\circ}\text{F}$ adjustment on the optional remote wall-mounted sensor since the keypad/display has higher priority. If you find that changes to the $\pm 3^{\circ}\text{F}$ adjustment on the remote wall-mounted sensor have no effect, it is likely that an occupant used the keypad/display to make a Set Point Offset change. Cycle unit power to clear this situation and restore the ability to change the Set Point Offset from the $\pm 3^{\circ}\text{F}$ adjustment on the remote wall-mounted sensor.

Remote Wall-Mounted Sensor with 55°F to 85°F Adjustment (optional)

When the optional remote wall-mounted sensor with 55°F to 85°F adjustment dial is used, the UVC will effectively write the value of the set point dial to the Space Temp Set Point Input variable.

- Note** – If a network connection is using the Space Temp Set Point Input variable, do not use the optional remote wall-mounted sensor with 55°F to 85°F adjustment.
- If it is intended that the LUI will be used by room occupants to adjust the Setpoint Offset, then you must not use the optional remote wall-mounted sensor with 55°F to 85°F adjustment. When using the optional remote wall-mounted sensor with 55°F to 85°F adjustment, the UVC will ignore any Setpoint Offset changes made at the LUI.

Effective Set Point Calculations

The UVC calculates the effective set point (Effective Set Point Output) based on several factors. These factors include the six occupancy set points for heating and cooling (Occupancy Temperature Set Point), occupancy mode, the value of the network variables Space Temp Set Point Input, Set Point Offset Input, and the Set Point Shift Input as well as the optional wall-mounted sensor's set point adjustment knob. As always, network inputs have priority over hardwired connections.

The UVC determines if heating or cooling is required based on the current unit mode (Heat/Cool Mode Output) and then calculates the required set point for heating or cooling. After calculating, the Effective Set Point Output network variable is set equal to the calculated set point. The Effective Set Point Output is the temperature set point that the UVC maintains, which normally appears on the keypad/display.

Figure 16: Effective set point calculations

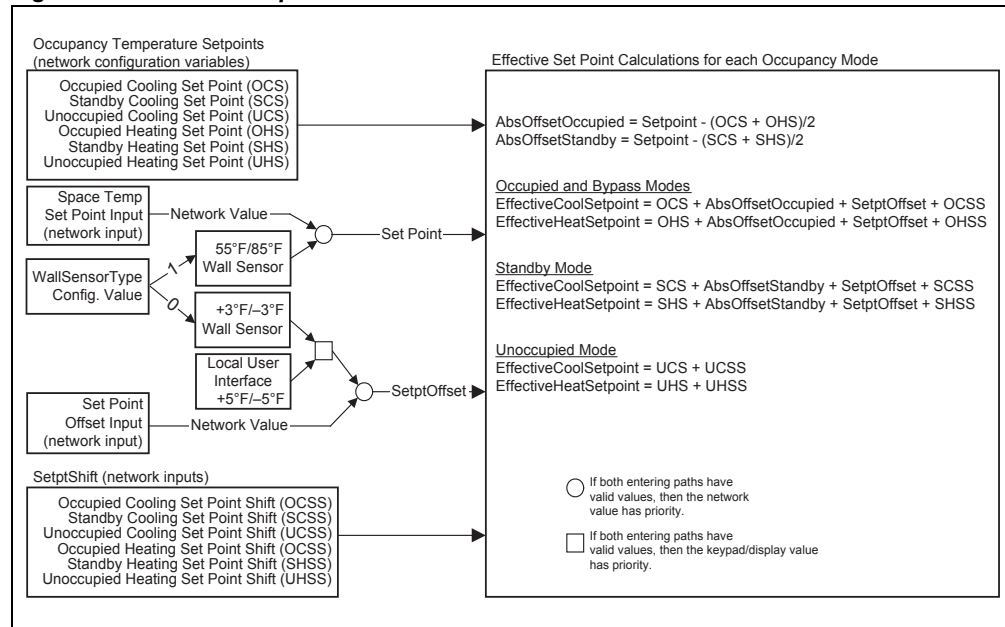

Table 15: Set point calculation examples

Example A	Given
	OccupancyMode = Occupied or BypassHeat/CoolMode = Heat SpaceTempSetpoint = (not used) SetpointOffset = (not used) = 0.0°F SetpointShift = (not used) = 0.0°F OHS = 69.8°F
	Effective set point calculations EffectiveSetpoint = OHS + SetpointOffset + SetpointShift = 69.8 + 0.0 + 0.0 = 69.8°F
Example B	Given
	OccupancyMode = Occupied or BypassHeat/CoolMode = Heat SpaceTempSetpoint = 71.0°F SetpointOffset = -1.0°F (occupant adjustment on remote wall sensor, or LUI) SetpointShift = (not used) = 0.0°F OCS = 73.4°F, OHS = 69.8°F
	Effective set point calculations AbsoluteOffset = (OCS - OHS) / 2 = (73.4°F - 69.8°F) / 2 = 1.8°F EffectiveSetpoint = SpaceTempSetpoint - AbsoluteOffset + SetpointOffset + SetpointShift = 71.0 - 1.0 - 1.0 + 0.0 = 68.2°F

Proportional Integral (PI) Control Loops

The MicroTech II UVC uses PI-loop control for heating, cooling and ventilation processes within the unit ventilator. Numerous PI algorithms can be used depending upon the unit ventilator configuration. The UVC uses “single” and “cascading” PI loops where needed.

Table 16: PI loop list

	PI loops	PI loop type	Set point	Feedback (controlled variable)	Output
PI-1	Space Temperature	Cascading	Effective Heating or Cooling Temperature Setpoint	Space Temperature	Calculated Discharge Air Temperature Setpoint Output
PI-2	Primary Cooling (Economizer)		Calculated Discharge Air Temperature Setpoint Output	Discharge Air Temperature	Position the OA Damper
PI-3	Secondary Cooling		Calculated Discharge Air Temperature Setpoint Output	Discharge Air Temperature	Operate the Compressor
PI-4	Primary Heating		Calculated Discharge Air Temperature Setpoint Output	Discharge Air Temperature	Position the Wet Heat Valve or F&BP Damper
PI-5	CO ₂ (optional)	Single	Effective CO ₂ Setpoint	Space CO ₂	Position the OA Damper
PI-6	Low Limit	Single	Calculated Discharge Air Temperature Setpoint	Discharge Air Temperature	Position the OA Damper

Figure 17: PI loop graphic for CO₂

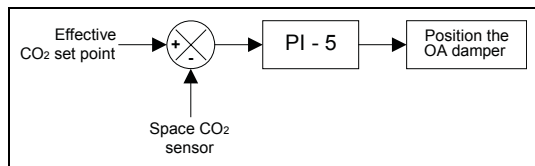

Discharge Air Temperature Control

The UVC uses two “cascading” PI loops to aid in providing very stable space temperature control. The Space Temperature PI-loop is used to calculate the Discharge Air Temperature Setpoint Output required to meet the Effective Temperature Setpoint Output. A second PI-loop (Primary Cooling, Secondary Cooling, or Primary Heating) is then activated to control the heating or cooling device required to achieve the calculated Discharge Air Temperature Setpoint Output.

Figure 18: Cascading PI loop graphic 1 (primary heat)

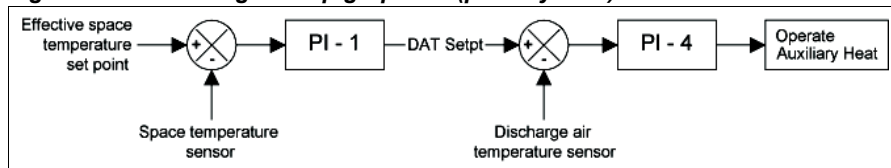
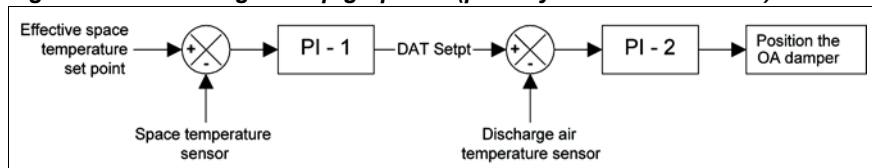

Figure 19: Cascading PI loop graphic 2 (primary cool—economizer)



PI Control Parameters

Associated with each PI loop is a set of two adjustable parameters: Proportional Band and Integral Time. When the unit ventilator is properly sized for the space, the factory settings for these parameters provides the best and most robust control action (see Figure 20).

If field problems arise, first ensure these parameters are set back to the factory default settings. If adjustment is required, only make small adjustments to one parameter at a time. After each adjustment, allow enough time for the system to stabilize before making further adjustments. If you do not have the means to graph the space performance, record the actual measured value and set point for several minutes and then plot the results using a spreadsheet to determine the correct action to change the PI parameter.

CAUTION

Adjusting PI parameters can cause erratic unit operation, and potentially damage the equipment.

PI control parameters should only be adjusted by trained personnel having a complete understanding of how these parameters affect system operation. Generally these parameters do not need to be adjusted from the factory default settings.

Figure 20: Optimized PI loop control

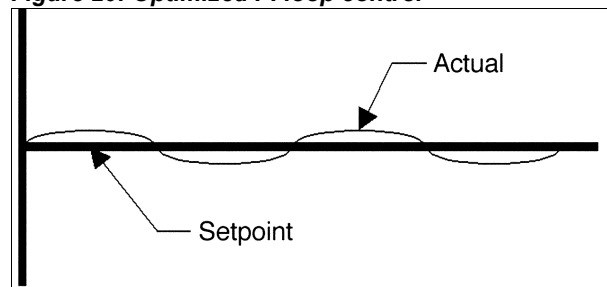

Proportional Band

The proportional band, or proportional action, causes the controlled output to change in proportion to the magnitude of the difference between the sensor value and set point.

A proportional band setting that is too small (see Figure 21) causes control oscillations that go fully above and below the set point.

Figure 21: Proportional bands

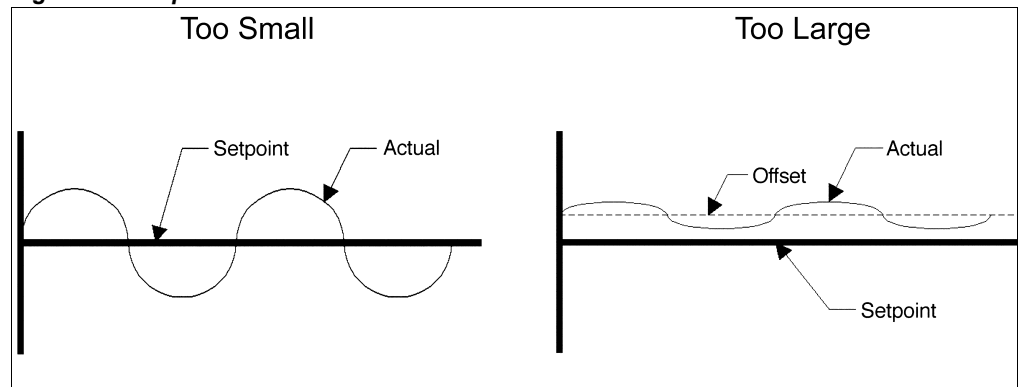

A proportional band setting that is too large (see Figure 21) causes an offset between the actual measured oscillation center and the set point. A small offset is not necessarily a problem since most systems have a small “natural” offset and the integral function automatically works to eliminate or reduce this effect.

In general, it is best to start with a relatively large proportional band setting (the factory default setting is best) and adjust to smaller values.

If you want the system to respond strongly to small changes in the space, adjust the proportional band to a higher setting.

If you want the system to react weakly to small changes in the space, adjust the proportional band to a higher setting.

Integral Time

The integral time, or integral action, causes the controlled output to change in proportion to time difference between the sensor value and set point. The difference over time between the actual value and set point forms an “area under the curve” (see Figure 22). The integral action works to reduce this “area under the curve” and to eliminate any natural system offset.

Figure 22: Integral time

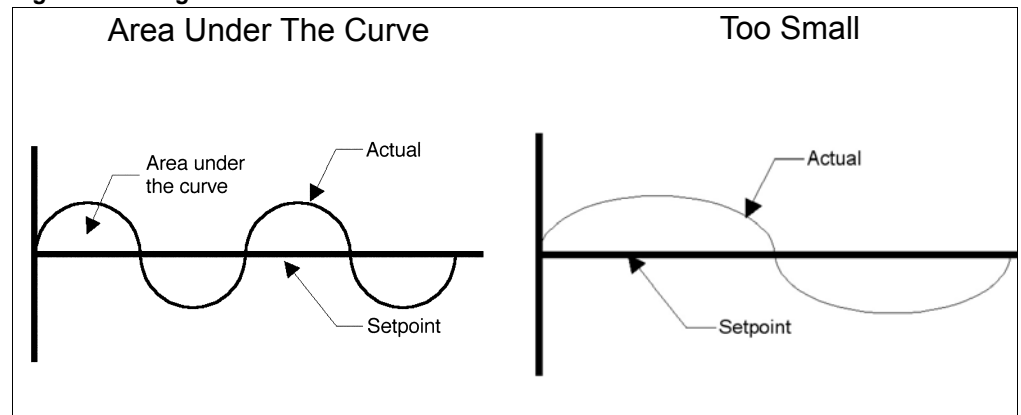

The smaller the integral time, the faster the output ramps up or down with small changes in the space. The smaller the integral time, the quicker the system reacts to small changes in the space. If the Integral Time is set too small, long oscillations occur (see Figure 22).

In general, it is best to start with a relatively large integral time setting (the factory default setting is best) and adjust to smaller values. If you want the system respond strongly to small changes in the space, lower the integral time. If you want the system to react weakly to small changes in the space, adjust the integral time to a higher setting.

Indoor Air Fan Operation

The UVC supports a three-speed indoor air (IA) fan; low, medium, and high. The UVC calculates the effective fan speed and operation based on the unit mode, the occupancy mode, and the values of several network variables.

Auto Mode

The UVC is provided with a user selectable auto fan mode feature. When in auto fan mode, the UVC uses the space temperature PI loop to automatically adjust the fan speed as needed to maintain space temperature. This ensures that the UVC maintains the lowest and quietest fan speeds whenever possible. When in auto fan mode, a maximum of six fan speed changes per hour is allowed (by default). This prevents frequent automatic fan speed changes from disturbing room occupants.

Occupied, Standby, and Bypass Operation

During occupied standby and bypass modes, the IA fan, by default, remains On.

Unoccupied Operation

During unoccupied mode, the IA fan typically remains off and cycles with calls for heating and cooling.

Cycle Fan

The UVC is provided with a Fan Cycling Configuration variable that can be used to force the IA fan to cycle with calls for heating and cooling during the occupied, standby, and bypass occupancy modes. When the fan is off, the OA damper is closed. McQuay recommends using this feature only when it is acceptable that normal ventilation is not required.

When the IA fan is set to cycle, the UVC is configured to continue fan operation for a time period after heating or cooling is complete.

Off Delay

When the UVC is placed into off mode or shutdown mode, the UVC is configured to continue fan operation for a short time period and then shutdown.

Outdoor Air Damper Operation

The UVC is configured for an OA damper operated by a floating-point actuator. The OA damper actuator contains a spring that ensures the OA damper is closed upon loss of power. The floating-point actuator is driven by the UVC using two binary (Triac) outputs. The OA damper typically is open to the current minimum position during the occupied and bypass occupancy modes and closed during the unoccupied and standby occupancy modes.

A Triac output is best tested under load using a 24 V relay for verification. To verify:

- 1 Put a relay across the Triac outputs.
- 2 Cycle the power.
- 3 Verify the relay's closed contacts during calibration.

Minimum Position

The UVC is configured to maintain three OA damper minimum positions based on the operation of the IAF fan. This allows each unit to be field configured to provide the amount of fresh air required to the space at each of the three IA fan speeds.

Table 17: Default OA damper minimum positions

IAF speed	Without CO ₂	With CO ₂
High	20%	5%
Medium	25%	5%
Low	30%	5%

Note – If the CO₂ Demand Controlled Ventilation (DCV) option is used, the UVC only uses the IA fan high speed OA damper minimum position regardless of fan speed. The DCV function adjusts the OA damper above this minimum as needed to maintain CO₂ set point.

Economizer Operation

The economizer function is used by the UVC to determine if the OA is adequate for economizer (primary) cooling. When both the economizer and mechanical cooling are available, the economizer is used as primary cooling and the UVC adds mechanical cooling only if the economizer is not adequate to meet the current cooling load (e.g., the OA damper reaches 100% and cooling is still required).

The UVC supports three economizer functions:

- Basic (default)—Temperature Comparison Economizer

- Expanded (optional)—Temperature Comparison with OA Enthalpy Setpoint Economizer (Strategy 1)
- Leading Edge (optional)—Temperature Comparison with Enthalpy Comparison Economizer (Strategy 2)

Temperature Comparison Economizer (default)

If the default Basic economizer function is selected, the unit ventilator is provided from the factory without the optional IA and OA humidity sensors. In this case, the UVC is factory set for Economizer Strategy 1—the UVC automatically detects that no OA humidity sensor is present and adjusts to use the Temperature Comparison Economizer function.

Temperature Comparison with OA Enthalpy Setpoint Economizer (optional)

If the optional Expanded economizer function is selected, the unit ventilator is provided from the factory with the optional OA humidity sensor, which is used along with the OA temperature sensor to calculate OA enthalpy. In this case, the UVC is factory set for Economizer Strategy 1 and uses the Temperature Comparison with OA Enthalpy Setpoint Economizer function.

Note – Temperature Comparison with OA Enthalpy Setpoint Economizer requires an optional OA humidity sensor.

Temperature Comparison with Enthalpy Comparison Economizer (optional)

If the optional Leading Edge economizer function is selected, the unit ventilator is provided from the factory with both the IA humidity and OA humidity sensors, which are used along with the IA temperature and OA temperature sensors to calculate IA enthalpy and OA enthalpy. In this case, the UVC is factory set for Economizer Strategy 2 and uses the Temperature Comparison with Enthalpy Comparison Economizer function.

Note – Temperature Comparison with Enthalpy Comparison requires both an optional OA humidity sensor and an optional IA humidity sensor.

Table 18: Economizer enable/disable tests defined

Tests	Economizer enable/disable tests	Enable test	Disable test
A	OA temp set point	EffectiveOATemp < (EconOATempSetpt – EconTempDiff)	EffectiveOATemp >= EconOATempSetpt
B	IA/OA differential temp	EffectiveOATemp < (EffectiveSpaceTemp – 3.6°F – EconTempDiff)	EffectiveOATemp >= (EffectiveSpaceTemp – 3.6°F)
C	OA enthalpy set point	EffectiveOAEnthalpy < (EconOAEnthalpySetpt – EconEnthalpyDiff)	EffectiveOAEnthalpy >= EconOAEnthalpySetpt
D	IA/OA differential enthalpy	EffectiveOAEnthalpy < (EffectiveSpaceEnthalpy – EconEnthalpyDiff)	EffectiveOAEnthalpy >= EffectiveSpaceEnthalpy

Table 19: How economizer enable/disable tests are selected

Economizer strategy	Space temp sensor	OA temp sensor	Space humidity sensor	OA humidity sensor	Economizer enable/disable tests
All	Unreliable	Don't care	Don't care	Don't care	OA damper closed
	Don't care	Unreliable	Don't care	Don't care	OA damper closed
Basic	Reliable	Reliable	Don't care	Unreliable	Test B
	Reliable	Reliable	Don't care	Reliable	Test C
Expanded	Reliable	Reliable	Don't care	Reliable	Test C and Either Test B or Test A
Leading Edge	Reliable	Reliable	Reliable	Reliable	Test D and Test B
	Reliable	Reliable	Unreliable	Reliable	Test B
	Reliable	Reliable	Reliable	Unreliable	Test B
	Reliable	Reliable	Unreliable	Unreliable	Test B

Note: The hard-wired sensor and the equivalent input must both be unreliable for the value to be considered unreliable.

Networked Space Humidity Sensor Capability

A networked space humidity sensor can be network interfaced with the Space Humidity Input variable. When the Space Humidity Input variable is used (valid value), it automatically overrides the hard-wired space humidity sensor (if present).

Networked Outdoor Humidity Sensor Capability

A networked outdoor humidity sensor can be network interfaced with the Outdoor Humidity Input variable. When the Outdoor Humidity Input variable is used (valid value), it automatically overrides the hard-wired outdoor humidity sensor (if present).

CO₂ Demand Controlled Ventilation (optional)

Ventilation equipment typically uses fixed damper positions to determine the amount of OA for proper ventilation within the space. Most commonly, the fixed position of the OA damper is based on the maximum number of occupants the space is designed to accommodate. However, this fixed OA damper operation ignores the fact that most spaces during the day have varying occupancy levels and may only rarely reach maximum design occupancy levels. This type of fixed damper control for ventilation is energy wasteful since you are treating OA not actually needed for ventilation during low occupancy levels.

People produce CO₂ when they breath; the CO₂ level within the space has a direct relationship with the number of people within that space.

The UVC can optionally be factory configured to provide CO₂-based Demand Controlled Ventilation (DCV). The CO₂ DCV function is useful in saving the energy typically wasted in treating OA not actually needed for ventilation within a space during occupancy levels below maximum design. The CO₂ DCV function uses a PI-loop control to adjust the OA damper above the minimum position as needed to maintain the Space CO₂ Setpoint (1200 PPM default).

The minimum damper position used with CO₂ DCV typically can be set at ~20% of the minimum position that would be used without CO₂ DCV. For example, if the minimum OA damper position typically is 20% then when using CO₂ DCV, you could set the new minimum OA damper position as low as 4% (e.g., $20\% \times 0.20 = 4\%$). This new, smaller minimum OA damper position then should provide enough ventilation to keep odors in check within the space for most applications.

- Note** – The CO₂ DCV function can increase the OA damper position past that required by the economizer and vice versa.
- If odors within the space become a problem, increase the OA damper minimum position as needed to eliminate these odors. It may be necessary with new construction or after renovation to raise the minimum position for some time period to help reduce odor build-up due to the out-gassing of new construction material and then return the minimum OA damper position at a later date.
 - If the CO₂ Demand Controlled Ventilation (DCV) option is used, the UVC only uses the IA fan high speed OA damper minimum position regardless of fan speed. The DCV function adjusts the OA damper above this minimum as needed. In this case, the IA fan high speed OA damper minimum position is factory set at 5%.

Networked Space CO₂ Sensor Capability

A networked space CO₂ sensor can be network interfaced with the Space CO₂ Input variable. When the Space CO₂ Input variable is used (valid value), it automatically overrides the hard-wired space CO₂ sensor (if present).

ASHRAE Cycle II

The UVC supports ASHRAE Cycle II operation. The basis of ASHRAE Cycle II is to maintain the required minimum amount of ventilation whenever possible, which can be increased during normal operation for economizer cooling or CO₂ DCV control or reduced to prevent excessively cold discharge air temperatures.

A discharge air temperature sensor is installed in all unit ventilators. If necessary, the ASHRAE II control algorithm overrides room control and modifies the heating, ventilating, and cooling functions (as available) to prevent the discharge air temperature from falling below the VCLL set point.

Compressor Operation

The UVC is configured to operate the compressor as secondary (mechanical) cooling when the economizer is available. When the economizer is not available and the compressor is available, the UVC uses the compressor when cooling is required.

Compressor Envelope

The compressor envelope protects the compressor from adverse operating conditions that can cause damage and or shortened compressor life by ending compressor operation if coil temperatures exceed the defined operating envelope.

For self-contained units, the UVC is configured to monitor both the inside air/refrigerant and outside air/refrigerant coil temperatures to prevent compressor operation under adverse conditions.

For split-system units, the UVC is configured at the factory to only monitor the inside air/refrigerant coil as part of the compressor envelope function.

Figure 23: Compressor envelope in self-contained units

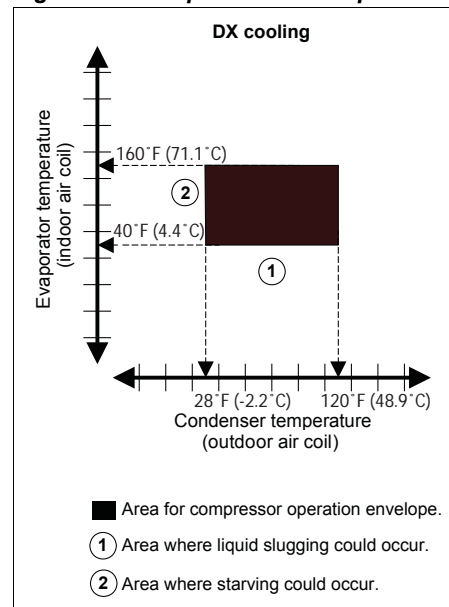

Compressor Cooling Lockout

The UVC is configured to lockout compressor cooling when the OA temperature falls below the Compressor Cooling Lockout set point (63.5°F/17.5°C). Below this point, only economizer cooling is available.

Compressor Minimum On and Off Timers

The UVC is provided with minimum On (3-minute default) and minimum Off (5-minute default) timers to prevent adverse compressor cycling.

Compressor Start Delay

The UVC is provided with a Compressor Start Delay configuration variable, which is intended to be adjusted as part of the start-up procedure for each unit. This variable is used to delay compressor operation each time the compressor is required.

Note – To prevent strain on a building's electrical supply system from multiple unit compressors all starting at the same time after a power failure or after an unoccupied-to-occupied changeover, McQuay strongly recommends configuring each unit or groups of units at start-up with different start delays.

Outdoor Air Fan Operation

The UVC is configured with a fan on delay that delays OA fan operation for a time period (10 seconds, default) after the compressor starts. The OA fan stops with the compressor.

Floating-Point Actuator Auto-Zero, Overdrive and Sync

The UVC at power-up auto-zeros all floating-point actuators (OA damper) before going into normal operation to ensure proper positioning. During auto-zero, the unit remains off. The actuators all open approximately 30% and then are driven full closed. The overdrive feature then is used to continue forcing the actuators closed for one full stroke period. Once the zeroing process is complete, normal unit operation begins.

The UVC is configured such that whenever a floating-point actuator is commanded to go to 0% or 100%, the UVC overdrives the actuator one full stroke period past the 0% or 100% position to ensure proper positioning.

Additionally, the UVC is configured to sync all floating-point actuators once every six hours of operation. To do this, the UVC forces the actuator to the closest rail position (0% or 100%), uses the overdrive feature, and then returns to the required position. For example, if the actuator is at 20% when the six-hour limit is reached, the UVC then forces the actuator to 0%, overdrive for one full stroke and then returns to the 20% position.

External Binary Inputs

The UVC is provided with three binary inputs that provide the functions described below.

Figure 24: Binary inputs

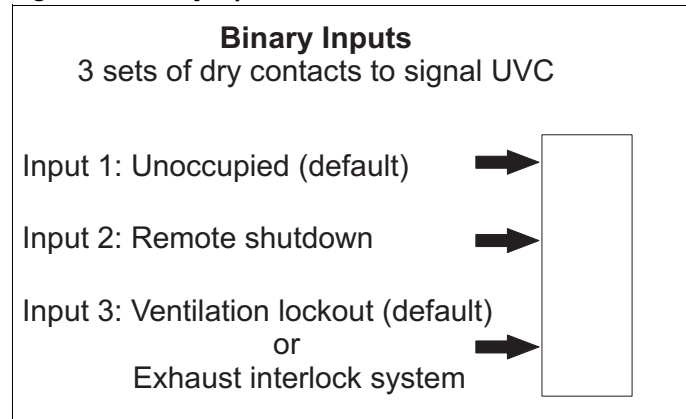

These inputs each allow a single set of dry contacts to be used as a signal to the UVC. Multiple units can be connected to a single set of dry contacts. For wiring examples, see MicroTech II Unit Ventilator Controller IM 747.

Note – Not all of the functions listed can be used at the same time. The UVC is provided with configuration parameters that can be adjusted to select which function is used for these inputs where multiple functions are indicated below.

External Binary Input 1

This input can be configured as an unoccupied (default) or dew point/humidity signal.

Unoccupied Input Signal

This input allows a single set of dry contacts to be used to signal the UVC to go into unoccupied or occupied mode. When the contacts close, the UVC goes into unoccupied mode. When the contacts open, the UVC goes into occupied mode. Additional variables can effect occupancy mode and override this binary input. See “Occupancy Modes” on page 24.

External Binary Input 2

This input can only be used for remote shutdown.

Remote Shutdown Input Signal

This input allows a single set of dry contacts to be used to signal the UVC to go into shutdown mode. When the contacts close (shutdown), the UVC goes into shutdown mode. When the contacts open, the UVC returns to normal operation. See “Special Purpose Unit Modes” on page 21.

External Binary Input 3

This input can be configured as a ventilation lockout (default) or exhaust interlock signal.

Ventilation Lockout Input Signal

This input allows a single set of dry contacts to be used to signal the UVC to close the OA damper. When the contacts close (ventilation lockout signal), the UVC closes the OA damper. When the contacts open, the UVC returns to normal OA damper operation.

Exhaust Interlock Input Signal

This input allows a single set of dry contacts to be used to signal the UVC that an exhaust fan within the space is energized. The UVC repositions the OA damper to a user adjustable minimum position (Exhaust Interlock OA Damper Min Position Setpoint). When the contacts close (exhaust fan on signal), the UVC uses the value defined by the Exhaust Interlock OA Damper Min Position Setpoint as the new minimum OA damper position regardless of IA fan speed. When the contacts open, the UVC returns to normal OA damper operation.

External Binary Outputs

The UVC is provided with three binary outputs that provide the functions described below.

Figure 25: Binary outputs

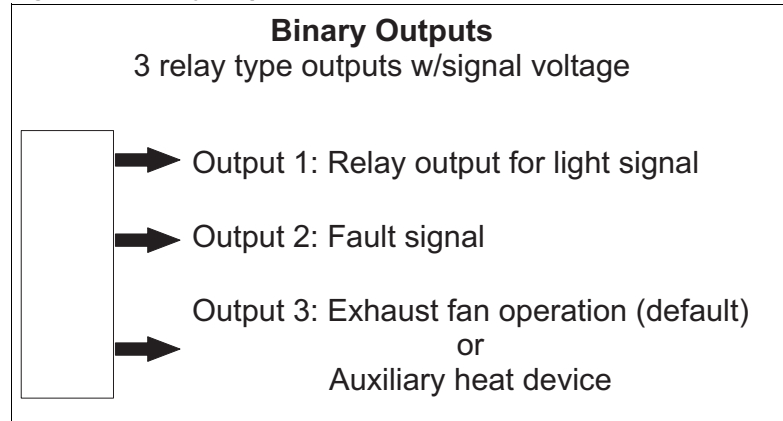

These outputs are relay type outputs that are intended to be used with signal level voltages (24 VAC maximum) only. For wiring examples, see MicroTech II Unit Ventilator Controller IM 747.

Note – Not all of the functions listed can be used at the same time. The UVC is provided with configuration parameters that can be adjusted to select which function will be used for these outputs when multiple functions are indicated below.

External Binary Output 1

This output can only be used as a signal for space lights.

Lights On/Off Signal

This relay output provides one set of Normally Open dry contacts that can be used to signal the operation of the space lights. When the UVC is in occupied, standby, or bypass occupancy modes, the relay output signals the lights ON (contacts closed). When the UVC is in unoccupied occupancy mode, the relay output signals the lights OFF (contacts open).

External Binary Output 2

This output can only be used as a fault signal.

Fault Signal

This relay output provides Normally Open, Normally Closed, and Common connections that can be used to signal a fault condition. When a fault exists, the UVC energizes this relay output. When the fault or faults are cleared, the UVC de-energizes this relay output.

External Binary Output 3

This output can only be used to signal exhaust fan operation (default) or operate an auxiliary heat device.

Exhaust Fan ON/OFF Signal

This relay output provides one set of Normally Open dry contacts that can be used to signal the operation of an exhaust fan. When the OA damper opens more than the Energize Exhaust Fan OA Damper set point, then the relay output signals the exhaust fan ON (contacts closed). When the OA damper closes below this set point, the relay output signals the exhaust fan OFF (contacts open).

Auxiliary Heat Signal

This relay output provides one set of Normally Open dry contacts that can be used to operate an auxiliary heat device. The UVC by default is configured to operate a Normally Open auxiliary heat device (de-energize when heat is required), such as a wet heat valve actuator with a spring setup to open upon power failure. However, the Auxiliary Heat Configuration variable can be used to set the UVC to use a Normally Closed auxiliary heat device (energize when heat is required), such as electric heat.

Table 20: Auxiliary heat start/stop calculation

Start/Stop	Calculation
Auxiliary heat starts when:	Primary Heat PI-Loop = saturated high (100%) for more than two minutes AND $\text{EffectiveSpaceTemp} \leq \text{EffectiveSetpoint} - \text{AuxiliaryHeatStartDifferential}$
Auxiliary heat stops when:	$\text{EffectiveSpaceTemp} \geq (\text{EffectiveSetpoint} - \text{AuxiliaryHeatStartDifferential}) + \text{AuxiliaryHeatStopDifferential}$

UVC Input and Output Table

All UVC input and output connections and their corresponding unit ventilator usage are shown in the following table.

Table 21: Inputs and outputs, software model 05—DX cooling only

I/O	Description
BO-1	Inside Fan High
BO-2	Inside Fan Medium
BO-3	Electric Heat 1
BO-4	Electric Heat 2
BO-5	Electric Heat 3
BO-6	External Output Option 2: Fault Indication ¹
BO-7	
BO-8	
BO-9	Compressor ²
BI-1	Condensate Overflow
BI-2	
BI-3	
BI-4	External Input Option 3: Ventilation Lockout (default) or Exhaust Interlock ³
BI-5	External Input Option 2: Remote Shutdown ³
BI-6	External Input Option 1: Unoccupied (default)
BI-7	
BI-8	
BI-9	
BI-10	
BI-11	
BI-12	DX Press Switch (NC) ⁴
AI-1	IA Temp. Sensor + T.O.
AI-2	Remote Setpt. Adjust. Pot.
AI-3	OA Coil DX Temp Sensor ⁵
AI-4	OA Temp Sensor
AI-5	IA Coil DX Temp Sensor
AI-6	DA Temp Sensor
Expansion board	
xBO-1	External Output Option 1: Lights On/Off ¹
xBO-2	External Output Option 3: Exhaust Fan On/Off (default) or Auxiliary Heat ¹
xBO-3	OA Damper Open
xBO-4	OA Damper Close
xBO-5	
xBO-6	
xBO-7	Outdoor Fan ⁵
xBO-8	Inside Fan Low
xAI-1	IA Humidity Sensor ⁶
xAI-2	OA Humidity Sensor ⁶
xAI-3	Indoor CO ₂ Sensor ⁶
xAI-4	

1. Field selectable external output options (all possible options are shown).
2. This is the condensing unit on/off signal on split-systems.
3. Field selectable external input options (all possible options are shown).
4. DX pressures switch not installed on split-systems; this input is then wired for constant no-fault condition.
5. Not installed or wired on split-systems.
6. Optional.

Diagnostics and Service

The most important aspect of troubleshooting unit ventilator controls is to isolate the source of the problem into one of two categories:

- 1 The problem resides within the UVC.
- 2 The problem is external to the UVC. Under most circumstances the problem is external to the UVC.

Alarm and Fault Monitoring

The UVC is programmed to monitor the unit for specific alarm conditions. If an alarm condition exists, a fault occurs. When a fault exists, the following occurs:

- The UVC indicates the fault condition by displaying the fault code on the keypad/display.
- The remote wall-mounted sensor (optional) LED flashes a pattern indicating that a fault condition exists.
- The fault signal binary output energizes.
- The fault performs the appropriate control actions as described for each fault.

Manual reset faults can be reset in one of three ways:

- By cycling the unit power.
- Via the keypad/display menu.
- Via the network interface.

Table 22: Alarm and fault code summary

Priority	Fault description	Reset	Keypad/ display fault codes
1	Space Temp Sensor Failure	Auto	F0
2	DX Pressure Fault	2-Auto in 7 days, then Manual	F1
3	Compressor Envelope Fault	2-Auto in 7 days, then Manual*	F2
4	Discharge Air DX Cooling Low Limit Indication	Auto	F3
5	Condensate Overflow Indication	Auto	F4
6	Space Coil DX Temp Sensor Failure	Auto	F5
7	Outdoor Temp Sensor Failure	Auto	F6
8	Discharge Air Temp Sensor Failure	Auto	F7
9	Water Coil DX Temp Sensor Failure	Auto	F8
10	Water-out Temp Sensor Failure	Auto	F9
11	Space Humidity Sensor Failure	Auto	FA
12	Outdoor Humidity Sensor Failure	Auto	Fb
13	Space CO ₂ Sensor Failure	Auto	Fc
14	Not used		Fd
15	Not used		FE
16	Change Filter Indication	Manual	FF
17	EPROM Memory Indicator	Replace controller board	EE
18	Configuration Display	Download file	--
* Rev 1_27 has auto reset			

Space Temp Sensor Failure (F0)

The Space Temp Sensor Failure fault occurs when the UVC detects open or short conditions from the sensor.

Effect:

- Space fan de-energizes (unless in emergency heat mode).
- Compressor immediately de-energizes.
- Outdoor fan (if present) de-energizes.
- Outside air damper is forced closed.
- Electric heat stages are de-energized.
- Fault is indicated.

DX Pressure Fault (F1)

The DX Pressure Fault occurs when the UVC detects a switch open condition from the refrigerant pressure switch.

Effect:

- Compressor immediately de-energizes.
- Outdoor fan (if present) de-energizes.
- Fault is indicated.

Compressor Envelope Fault (F2)

The UVC monitors refrigerant temperatures. The Compressor Envelope Fault occurs when the UVC detects compressor operation that exceeded the allowed operating parameters.

Effect:

- Compressor immediately de-energizes.
- Outdoor fan (if present) de-energizes.
- Fault is indicated.

Cause:

- Poor air or water flow through the refrigerant coils. Check fans for proper rpm. Check air filters.
- If the unit has a three-phase scroll compressor, check for proper electrical phasing.
- Refrigerant circuit component failure or improper adjustment. Check refrigerant pressures and TXV adjustment.
- Coil sensors may have lost proper contact with the refrigerant coil. Check coil sensors.

Discharge Air DX Cooling Low Limit Indication (F3)

The Discharge Air DX Cooling Low Limit Indication fault occurs when the UVC detects a low discharge air temperature (DAT < MCLL) during compressor cooling.

Effect:

- Compressor immediately de-energizes.
- Outdoor fan (if present) de-energizes.
- Fault is indicated (on earlier software versions).

Condensate Overflow Indication (optional) (F4)

The Condensate Overflow Indication fault will occur when the UVC detects high condensate levels within the units indoor coil drain pan.

Effect:

- Compressor is immediately de-energized if in cooling.
- Outdoor fan (if present) is de-energized.
- Fault is indicated.

Space Coil DX Temp Sensor Failure (F5)

The Space Coil DX Temp Sensor Failure fault occurs when the UVC detects open or short conditions from the sensor.

Effect:

- Compressor immediately de-energizes.
- Outdoor fan (if present) de-energizes.
- Fault is indicated.

Outdoor Temp Sensor Failure (F6)

The Outdoor Temp Sensor Failure fault occurs when the UVC detects open or short conditions from the sensor.

Effect:

- Outside air damper is forced closed.
- Compressor immediately de-energizes.
- Fault is indicated.

Discharge Air Temp Sensor Failure (F7)

The Discharge Air Temp Sensor Failure fault occurs when the UVC detects open or short conditions from the sensor. Emergency heat mode is available during this fault condition.

Effect:

- Space fan is immediately de-energized (unless in emergency heat mode).
- Outside air damper is forced closed.
- Electric heat stages are de-energized.
- Compressor immediately de-energizes.
- Outdoor fan (if present) immediately de-energizes.
- Fault is indicated.

Outdoor Coil DX Temp Sensor Failure (F8)

The Outdoor Coil DX Temp Sensor Failure fault occurs when the UVC detects open or short conditions from the sensor.

Effect:

- Compressor immediately de-energizes.
- Outdoor fan (if present) de-energizes.
- Fault is indicated.

Space Humidity Sensor Failure (optional) (FR)

The Space Humidity Sensor Failure fault occurs when the UVC detects open or short conditions from the sensor.

Effect:

- IA/OA Enthalpy comparison economizer (if used) is disabled.
- Dehumidification function (optional) is disabled.
- Fault is indicated.

Outdoor Humidity Sensor Failure (optional) (Fb)

The Outdoor Humidity Sensor Failure fault occurs when the UVC detects open or short conditions from the sensor.

Effect:

- IA/OA Enthalpy comparison or OA Enthalpy economizer (if used) is disabled.
- Fault is indicated.

Space CO₂ Sensor Failure (optional) (FL)

The Space CO₂ Sensor Failure fault occurs when the UVC detects open or short conditions from the sensor.

Effect:

- CO₂ Demand Controlled Ventilation function is disabled.
- Fault is indicated.

Change Filter Indication (FF)

The Change Filter Indication fault occurs when the UVC calculates that the total fan run time has exceeded the allowed number of hours since the last filter change.

Effect:

- Fault is indicated.

EPRoM Memory Indicator (EE)

The EPROM Memory Indicator occurs when an unusual electrical event has scrambled the EPROM memory within the controller board. In the event that this happens, the controller board must be replaced.

Configuration Display (--)

The Configuration Display occurs when the display file “*.cfg” is incorrect or has not been downloaded with the appropriate file from service tools.

Troubleshooting Temperature Sensors

The UVC is configured to use passive positive temperature coefficient (PTC) sensor whose resistance increases with increasing temperature. The element has a reference resistance of 1035 ohms at 77°F (25°C). Each element is calibrated according to the tables shown.

Use the following procedure to troubleshoot a suspect sensor.

- 1 Disconnect both sensor leads from the UVC.
- 2 Using some other calibrated temperature sensing device, take a temperature reading at the sensor location.

- 3 Use the temperature reading from Step 2 to determine the expected sensor resistance from Table 23.
- 4 Using a calibrated ohmmeter, measure the actual resistance across the two sensor leads.
- 5 Compare the expected resistance to the actual resistance.
- 6 If the actual resistance value deviates substantially (more than 10%) from the expected resistance, replace the sensor.

Table 23: Temperature versus resistance

°F (°C)	Resistance in ohms	°F (°C)	Resistance in ohms
-40 (-40)	613	113 (45)	1195
-31 (-35)	640	122 (50)	1237
-22 (-30)	668	131 (55)	1279
-13 (-25)	697	140 (60)	1323
-4 (-20)	727	149 (65)	1368
5 (-15)	758	158 (70)	1413
14 (-10)	789	167 (75)	1459
23 (-5)	822	176 (80)	1506
32 (0)	855	185 (85)	1554
41 (5)	889	194 (90)	1602
50 (10)	924	203 (95)	1652
59 (15)	960	212 (100)	1702
68 (20)	997	221 (105)	1753
77 (25)	1035	230 (110)	1804
86 (30)	1074	239 (115)	1856
95 (35)	1113	248 (120)	1908
104 (40)	1153		

Troubleshooting Humidity Sensors

The UVC is configured to use a 0–100% RH, 0–5 VDC, capacitive humidity sensor. Each sensor is calibrated according to the table shown.

CAUTION

The humidity sensor is not protected against reversed polarity. Check carefully when connecting the device or damage can result.

Use the following procedure to troubleshoot a suspect sensor:

- 1 Disconnect the sensors output voltage lead from the UVC analog input.
- 2 Using some other calibrated humidity sensing device, take a humidity reading at the sensor location.
- 3 Use the humidity reading from Step 2 determine the expected sensor voltage from Table 24.
- 4 Using a calibrated multi-meter, measure the actual voltage across the yellow and white sensor leads.
Wire color definitions:
White = ground
Yellow = output VDC
Blue = supply VDC
- 5 Compare the expected voltage to the actual voltage.
- 6 If the actual voltage value deviates substantially (more than 10%) from the expected voltage, replace the sensor.

Table 24: Humidity versus voltage.

RH (%)	VDC (mV)	RH (%)	VDC (mV)
10	1330	55	2480
15	1475	60	2600
20	1610	65	2730
25	1740	70	2860
30	1870	75	2980
35	1995	80	3115
40	2120	85	3250
45	2235	90	3390
50	2360	95	3530

Troubleshooting Carbon Dioxide (CO₂) Sensors

The UVC is configured to use a 0–2000 PPM, 0–10 VDC, single beam absorption infrared gas sensor. Each sensor is calibrated according to the table shown.

Use the following procedure to troubleshoot a suspect sensor.

- 1 Disconnect the sensors output voltage lead from the UVC analog input (xAI-3).
- 2 Using some other calibrated CO₂ sensing device, take a CO₂ reading at the sensor location.
- 3 Use the CO₂ reading from Step 2 to determine the expected sensor voltage from Table 25.
- 4 Using a calibrated multi-meter, measure the actual voltage across the lead removed from xAI-3 and ground.
- 5 Compare the expected voltage to the actual voltage.
- 6 If the actual voltage value deviates substantially (more than 10%) from the expected voltage, replace the sensor.

In the unlikely event that the CO₂ sensor requires calibration, consult the factory for information on obtaining calibration equipment and instructions.

Table 25: CO₂ versus voltage table

CO ₂ (PPM)	VDC (V)	CO ₂ (PPM)	VDC (V)
300	1.5	1200	6.0
400	2.0	1300	6.5
500	2.5	1400	7.0
600	3.0	1500	7.5
700	3.5	1600	8.0
800	4.0	1700	8.5
900	4.5	1800	9.0
1000	5.0	1900	9.5

UVC Configuration Parameters

The UVC is been provided with a number of configuration variables as listed in the following table. These configuration variables are stored in UVC non-volatile memory. For a description of supported network variables for each protocol, refer to Protocol Data Packet bulletin ED 15065.

Table 26: UVC configuration parameters (OM 751)

Configuration Parameter Name	Abr.	Notes	Default	LUI Menu Item ¹
Occupied Cooling Setpoint	OCS		73°F (23°C)	C0
Standby Cooling Setpoint	SCS		77°F (25°C)	C5
Unoccupied Cooling Setpoint	UCS		82°F (28°C)	CU
Occupied Heating Setpoint	OHS		70°F (21°C)	H0
Standby Heating Setpoint	SHS		66°F (19°C)	H5
Unoccupied Heating Setpoint	UHS		61°F (16°C)	HU
Local Bypass Time		Tenant override	120 min	
Space CO ₂ Setpoint ²	CO ₂ S		1200 PPM	
Space Humidity Setpoint ²	RHS	used with both active (reheat) and passive dehumidification sequences	60% Rh	
Emergency Heat Enable		0 = disable, 1 = enable (uses auxiliary heat where primary heat is not applicable)	1	H1
Emergency Heat Setpoint	EHS		54°F (12°C)	H2
Emergency Heat Shutdown Configuration		0 = no emergency heat during shutdown, 1 = emergency heat available during shutdown	0	H3
Wall Sensor Type ²		0 = +/- 3°F, 1 = 55°F to 85°F	0	r5
Slave Type Configuration ²		0 = independent slave, 1 = dependent slave	0	SL
OAD Min Position High-Speed Setpoint	OADH	(this variable will be factory set to 5% open when the unit is ordered with optional CO ₂ DCV)	20% open	o2
OAD Min Position Med-Speed Setpoint	OADM	(this variable is ignored when the unit is ordered with optional CO ₂ DCV)	25% open	o3
OAD Min Position Low-Speed Setpoint	OADL	(this variable is ignored when the unit is ordered with optional CO ₂ DCV)	30% open	o4
Exhaust Interlock OAD Min Position Setpoint	EOAD	OA damper minimum position when the exhaust interlock input is energized	99% open	o5
Energize Exhaust Fan OAD Setpoint	OADE	defines position above which exhaust fan output will be energized	12% open	o6
OAD Max Position Setpoint	OAMX		99% open	o7
OAD Lockout Enable		0 = disable, 1 = enable (this variable will be factory set to 1 when the unit is ordered as a recirc unit with no OAD)	0	o8
OAD Lockout Setpoint	OALS	OA temperature below which the OA damper will remain closed (this variable will be factory set to -99°C when the unit is ordered as a recirc unit with no OAD)	36°F (2°C)	o9
Economizer Enable		0 = disable, 1 = enable	1	E1
Economizer OA Temp Setpoint	ETS		68°F (20°C)	E2
Economizer IA/OA Temp Differential	ETD		2°F (1°C)	E3
Economizer OA Enthalpy Setpoint	EES		25 btu/lb (58 kJ/kg)	E5
Economizer IA/OA Enthalpy Differential	EED		1.3 btu/lb (3 kJ/kg)	E6
External BI-3 Configuration		0 = Ventilation Lockout, 1 = Exhaust Interlock	0	b3
External BO-3 Configuration		0 = Exhaust Fan On/Off, 1 = Auxiliary Heat	0	b6
Filter Alarm Enable		0 = disable, 1 = enable	0	CE
Filter Change Hours Setpoint		fan run hours between filter change alarms	700 hrs	

UVC Configuration Parameters

Configuration Parameter Name	Abr.	Notes	Default	LUI Menu Item ¹
Primary Cool Proportional Band			18°F (10°C)	
Primary Cool Integral Time			180 sec	
Secondary Cool Proportional Band			18°F (10°C)	
Secondary Cool Integral Time			600 sec	
Discharge Air Temp Proportional Band			4°F (2.22°C)	
Discharge Air Temp Integral Time			300 sec	
CO ₂ Proportional Band ²			100 PPM	
CO ₂ Integral Time ²			600 sec	
Ventilation Cooling Low Limit Setpoint	VCLL	discharge air low limit during ventilation or economizer cooling	54°F (12°C)	d2
Mechanical Cooling Low Limit Setpoint	MCLL	discharge air low limit during mechanical (compressor) cooling	45°F (7°C)	d3
Discharge Air High Limit	DAHL		140°F (60°C)	
Space Fan Off Delay			30 sec	
Fan Cycling Configuration		space fan operation during occupied, standby and bypass occupancy modes: 2 = continuous, 3 = cycle	2	[F
Space Fan Speed Changes Per Hour		example: 6/60min = 10min (maximum of 1 fan speed change every 10min when fan in auto)	6	
Space Fan Run Time Reset		reset total run time: 1 = reset (you must return the variable back to 0 after reset)	0	
Compressor Run Time Reset		reset total run time: 1 = reset (you must return the variable back to 0 after reset)	0	
Compressor Enable		0 = disable, 1 = enable	1	[I
Compressor Minimum On Time			180 sec	
Compressor Minimum Off Time			300 sec	
Compressor Cooling Lockout Setpoint	CCLLO	OA temperature below which compressor cooling is not allowed	63.5°F (17.5°C)	
Compressor Envelope Cool Max In			120°F (48.89°C)	
Compressor Envelope Cool Min In			28°F (-2.22°C)	
Compressor Envelope Cool Max Out			160°F (71.11°C)	
Compressor Envelope Cool Min Out			40°F (4.44°C)	
Compressor Envelope Cool Max Ratio			0.00	
Compressor Envelope Cool Max Offset			88°F (48.89°C)	
Compressor Envelope Cool Min Ratio			0.0	
Compressor Envelope Cool Min Offset			-4°F (-2.22°C)	
Auxiliary Heat Start Differential	AHSD	degrees above auxiliary heat start point where auxiliary heat ends	2°F (1°C)	A1
Auxiliary Heat End Differential	AHED	degrees above auxiliary heat start point where auxiliary heat ends	2°F (1°C)	A2
Auxiliary Heat Configuration		0 = normally open heat device (hot water valve, etc.), 1 = normally closed heat device (electric heat, etc.)	0	A3
Space Humidity Sensor Enable ²		0 = disable, 1 = enable (this variable will be factory set to 1 when the unit is ordered with optional humidity sensor)	0	
Outdoor Humidity Sensor Enable ²		0 = disable, 1 = enable (this variable will be factory set to 1 when the unit is ordered with optional humidity sensor)	0	

Configuration Parameter Name	Abr.	Notes	Default	LUI Menu Item ¹
OAD Stroke Time			90 sec	
Split-System OA/DX Coil Temp		used on split-system units only to partially disable the compressor envelope by setting the outside DX coil temperature to a fixed valid value, enter 122°F (50°C) on split-systems, use 327.67 for self-contained units (327.67 = invalid)	327.76	
Application Name and Version Label				
Compressor Start Delay		adjust the compressor delay used to prevent multiple compressor units from starting simultaneously (each unit or group of units should have a different delay setting)	0 sec	Ⓞ
Outdoor Fan Delay			10 sec	

1. Indicates parameters accessible through the keypad/display.
2. Requires optional equipment.

McQuay Training and Development

Now that you have made an investment in modern, efficient McQuay equipment, its care should be a high priority. For training information on all McQuay HVAC products, please visit us at www.mcquay.com and click on training, or call 540-248-9646 and ask for the Training Department.

Warranty

All McQuay equipment is sold pursuant to its standard terms and conditions of sale, including Limited Product Warranty. Consult your local McQuay Representative for warranty details. Refer to Form 933-43285Y. To find your local McQuay Representative, go to www.mcquay.com.

This document contains the most current product information as of this printing. For the most up-to-date product information, please go to www.mcquay.com.



Free Manuals Download Website

<http://myh66.com>

<http://usermanuals.us>

<http://www.somanuals.com>

<http://www.4manuals.cc>

<http://www.manual-lib.com>

<http://www.404manual.com>

<http://www.luxmanual.com>

<http://aubethermostatmanual.com>

Golf course search by state

<http://golfingnear.com>

Email search by domain

<http://emailbydomain.com>

Auto manuals search

<http://auto.somanuals.com>

TV manuals search

<http://tv.somanuals.com>