

# AMERICAN AUDIO

## CK 800Mp3

Featuring:



## User Guide and Reference Manual

**AMERICAN AUDIO**  
4295 Charter Street  
Los Angeles Ca. 90058  
[www.AmericanAudio.us](http://www.AmericanAudio.us)

# CONTENTS

IMPORTANT INFORMATION.....	3
SAFETY REGULATIONS.....	4
ELECTRICAL PRECAUTIONS.....	5
SAFETY INSTRUCTIONS.....	5
VOLTAGE SELECTOR.....	5
UNPACKING.....	6
CUSTOMER SUPPORT.....	6
FEATURES.....	7
SET-UP INSTALLATION.....	8
FUNCTIONS AND CONTROLS	
CD PLAYER.....	9
MIXER.....	12
FRONT & REAR PANEL.....	14
LCD DISPLAY.....	16
BASIC OPERATIONS	
LOADING EJECTING DISC.....	17
TRACK SELECTION.....	17
STARTING PLAYBACK.....	18
PAUSING PLAYBACK.....	18
FRAME SEARCH.....	18
SETTING A CUE POINT.....	19
CREATING A SEAMLESS LOOP.....	20
CHANGING TIME DISPLAY.....	21
PITCH ADJUSTMENTS	
PITCH SLIDER.....	22
PITCH BENDING.....	23
RELAY (FLIP-FLOP™).....	25
TYPICAL MIXER SET-UP.....	26
CROSSFADER REPLACEMENT.....	28
WARRANTY.....	29
SPECIFICATIONS.....	30

## FOR BEST CD-R DISC PLAYBACK RESULTS IN THIS CD PLAYER PLEASE FOLLOW THESE GUIDELINES:

1. High quality CD-R Audio discs (should conform to the standards of the Orange Book 2).
2. Use a high quality bit rate when recording discs. (At least 160kbps)
3. Record discs in the slowest speed possible. (i.e. 2x or 4x speed)

## IMPORTANT INFORMATION

### IMPORTANT SAFETY ITEMS FOR U.S.A. & CANADA MODEL ONLY

#### NOTE:

This CD player uses a semiconductor laser. It is recommended for use in a room at the following temperature: 41°F - 95°F / 5°C - 35°C

#### WARNING:

TO PREVENT FIRE OR SHOCK HAZARD,  
DO NOT EXPOSE THIS CD PLAYER TO  
WATER OR MOISTURE

#### CAUTION:

1. Handle the power supply cord carefully. Do not damage or deform; it may cause electric shock or malfunction when used. Hold plug attachment when removing from wall outlet. Do not pull on the cord.
2. To avoid electric shock, do not open the top cover when the unit is plugged in. If problems occur with the unit, call your local American Audio® dealer.
3. Do not place metal objects or spill liquid inside the CD player. Electric shock or malfunction may occur.



**CAUTION**  
**Do not open -**  
**Risk of electric shock**



CAUTION: TO REDUCE THE RISK OF ELECTRIC SHOCK, DO NOT REMOVE THE COVER RACK. THERE ARE NO USER SERVICEABLE PARTS INSIDE REFER SERVICE TO YOUR AUTHORIZED American Audio DEALER.



The lightning flash with an arrow triangular symbol is intended to alert the user to the presence of non insulated "dangerous voltage" within the products enclosure, and may be of sufficient magnitude to constitute a risk of electric shock.



The exclamation point triangular symbol is intended to alert the user to the presence of important operating and maintenance (servicing) instructions in the user manual accompanying the CD player.

#### CAUTION

TO PREVENT ELECTRIC SHOCK DO NOT USE THIS (POLARIZED) PLUG WITH AN EXTENSION CORD, RECEPTACLE OR OTHER OUTLET UNLESS THE BLADES CAN BE CAREFULLY INSERTED TO PREVENT BLADE EXPOSURE

#### CAUTION:

USE OF CONTROLS OR ADJUSTMENTS OTHER THAN THOSE SPECIFIED HEREIN MAY RESULT IN HAZARDOUS RADIATION EXPOSURE

THE COMPACT DISC PLAYER SHOULD NOT BE ADJUSTED OR REPAIRED BY ANYONE EXCEPT PROPERLY QUALIFIED SERVICE PERSONNEL.

#### NOTE:

This unit may cause interference to radio and television reception.

Please carefully read and understand the instructions in this manual thoroughly before attempting to operate this unit. These instructions contain important safety information regarding the use and maintenance of this unit. Take special care to follow all warning symbols and labels both on the unit and printed in this manual. Also, Please keep this manual with the unit, for future reference.

**CAUTION:** TO PREVENT ELECTRIC SHOCK DO NOT USE THIS (POLARIZED) PLUG WITH AN EXTENSION CORD, RECEPTACLE, OR OTHER TYPE OF ELECTRICAL OUTLET UNLESS THE WIDE BLADES CAN BE CAREFULLY INSERTED INTO A MATCHING WIDE SLOT.

**ATTENTION:** POUR PREVENIR LES CHOCS ELECTRIQUES NE PAS UTILISER CETTE FICHE POLARISEE AVEC UN PROLONGATEUR, UNE PRISE DE COURANT OU UNE AUTRE SORTIE DE COURANT, SAUF SI LES LAMES PEUVENT ETRE INSEREES A FOND SANS EN LAISSER AUCUNE PARTIE A DECOUVERT.

# ELECTRICAL SAFETY PRECAUTIONS

## ELECTRICAL PRECAUTIONS



The lightning flash with arrowhead symbol, within an equilateral triangle, is intended to alert the user to the presence of uninsulated "dangerous voltage" within the product's enclosure that may be of sufficient magnitude to constitute a risk of electric shock to persons.



**CAUTION: TO REDUCE THE RISK OF ELECTRIC SHOCK, DO NOT REMOVE THE COVER (OR BACK). THERE ARE NO USER SERVICEABLE PARTS INSIDE. REFER SERVICE TO YOUR AUTHORIZED AMERICAN AUDIO® SERVICE TECHNICIAN.**



The exclamation point within an equilateral triangle is intended to alert the user to the presence of important operating and maintenance (servicing) instructions in the literature accompanying the appliance.

## IMPORTANT SAFETY INSTRUCTIONS

**READ INSTRUCTIONS** — All the safety and operating instructions should be read before the product is operated.

**RETAIN INSTRUCTIONS** — The safety and operating instructions should be retained for future reference.

**HEED WARNINGS** — All warnings on the product and in the operating instructions should be adhered to.

**FOLLOW INSTRUCTIONS** — All operating and use instructions should be followed.

**CLEANING** — The product should be cleaned only with a polishing cloth or a soft dry cloth. Never clean with furniture wax, benzene, insecticides or other volatile liquids since they may corrode the cabinet.

**ATTACHMENTS** — Do not use attachments not recommended by the product manufacturer as they may cause hazards.

**WATER AND MOISTURE** — Do not use this product near water — for example, near a bathtub, wash bowl, kitchen sink, or laundry tub; in a wet basement; or near a swimming pool; and the like.

**ACCESSORIES** — Do not place this product on an unstable cart, stand, tripod, bracket, or table. The product may fall, causing serious injury to a child or adult, and serious damage to the product. Use only with a cart, stand, tripod, bracket, or table recommended by the manufacturer, or sold with the product. Any mounting of the product should follow the manufacturer's instructions, and should use a mounting accessory recommended by the manufacturer.

**CART** — A product and cart combination should be moved with care. Quick stops, excessive force, and uneven surfaces may cause the product and cart combination to overturn.



**VENTILATION** — Slots and openings in the cabinet are provided for ventilation and to ensure reliable operation of the product and to protect it from overheating, and these openings must not be blocked or covered. The openings should never be blocked by placing the product on a bed, sofa, rug, or other similar surface. This product should not be placed in a built-in installation such as a bookcase or rack unless proper ventilation is provided or the manufacturer's instructions have been adhered to.

**POWER SOURCES** — This product should be operated only from the type of power source indicated on the marking label. If you are not sure of the type of power supply to your home, consult your product dealer or local power company.

**LOCATION** — The appliance should be installed in a stable location.

**NONUSE PERIODS** — The power cord of the appliance should be unplugged from the outlet when left unused for a long period of time.

### GROUNDING OR POLARIZATION

- If this product is equipped with a polarized alternating current line plug (a plug having one blade wider than the other), it will fit into the outlet only one way. This is a safety feature. If you are unable to insert the plug fully into the outlet, try reversing the plug. If the plug should still fail to fit, contact your electrician to replace your obsolete outlet. Do not defeat the safety purpose of the polarized plug.

- If this product is equipped with a three-wire grounding type plug, a plug having a third (grounding) pin, it will only fit into a grounding type power outlet. This is a safety feature. If you are unable to insert the plug into the outlet, contact your electrician to replace your obsolete outlet. Do not defeat the safety purpose of the grounding type plug.

**POWER-CORD PROTECTION** - Power-supply cords should be routed so that they are not likely to be walked on or pinched by items placed upon or against them, paying particular attention to cords at plugs, convenience receptacles, and the point where they exit from the product.

**OUTDOOR ANTENNA GROUNDING** — If an outside antenna or cable system is connected to the product, be sure the antenna or cable system is grounded so as to provide some protection against voltage surges and built-up static charges. Article 810 of the National Electrical Code, ANSI/NFPA 70, provides information with regard to proper grounding of the mast and supporting structure, grounding of the lead-in wire to an antenna discharge unit, size of grounding conductors, location of antenna-discharge unit, connection to grounding electrodes, and requirements for the grounding electrode. See Figure A.

**LIGHTNING** — For added protection for this product during a lightning storm, or when it is left unattended and unused for long periods of time, unplug it from the wall outlet and disconnect the antenna or cable system. This will prevent damage to the product due to lightning and power-line surges.

**POWER LINES** — An outside antenna system should not be located in the vicinity of overhead power lines or other electric light or power circuits, or where it can fall into such power lines or circuits. When installing an outside antenna system, extreme care should be taken to keep from touching such power lines or circuits as contact with them might be fatal.

**OVERLOADING** — Do not overload wall outlets, extension cords, or integral convenience receptacles as this can result in a risk of fire or electric shock.

**OBJECT AND LIQUID ENTRY** - Never push objects of any kind into this product through openings as they may touch dangerous voltage points or short-out parts that could result in a fire or electric shock. Never spill liquid of any kind on the product.

**SERVICING** — Do not attempt to service this product yourself as opening or removing covers may expose you to dangerous voltage or other hazards. Refer all servicing to qualified service personnel.

**DAMAGE REQUIRING SERVICE** - Unplug this product from the wall outlet and refer servicing to qualified service personnel under the following conditions:

- When the power-supply cord or plug is damaged.
- If liquid has been spilled, or objects have fallen into the product.
- If the product has been exposed to rain or water.
- If the product does not operate normally by following the operating instructions. Adjust only those controls that are covered by the operating instructions as an improper adjustment of other controls may result in damage and will often require extensive work by a qualified technician to restore the product to its normal operation.
- If the product has been dropped or damaged in any way.
- When the product exhibits a distinct change in performance — this indicates a need for service.

**REPLACEMENT PARTS** — When replacement parts are required, be sure the service technician has used replacement parts specified by the manufacturer or have the same characteristics as the original part. Unauthorized substitutions may result in fire, electric shock, or other hazards.

**SAFETY CHECK** - Upon completion of any service or repairs to this product, ask the service technician to perform safety checks to determine that the product is in proper operating condition.

**WALL OR CEILING MOUNTING** — The product should not be mounted to a wall or ceiling.

**HEAT** — The product should be situated away from heat sources such as radiators, heat registers, stoves, or other products (including amplifiers) that produce heat.

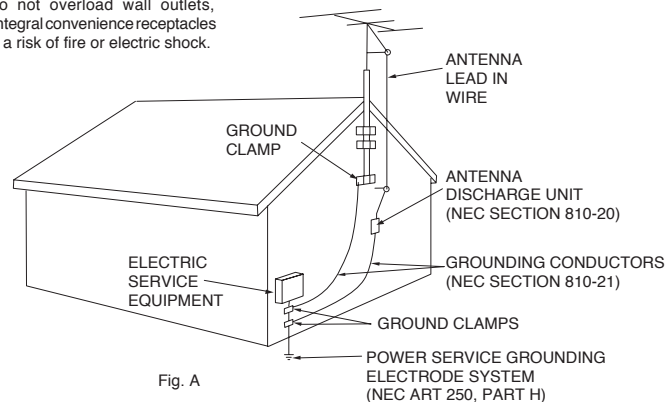

Fig. A

NEC — NATIONAL ELECTRICAL CODE

# SAFETY INSTRUCTIONS

1. Read Instructions - All the safety and operating instructions should be read before you operate the system. The safety and operating instructions should be saved for future reference.
2. Heed Warnings - All warnings on the system and in the operating instructions should be adhered to.
3. Water and Moisture - The player should not be used near water - for example, near a bath tub, kitchen sink, laundry tub, in a wet basement or near a swimming pool, etc.
4. Ventilation - The system should be situated so that its location or position does not interfere with its proper ventilation. For example, the system should not be situated on a bed, sofa, rug, or similar surface that may block the ventilation openings; or, placed in a built-in installation, such as a bookcase or cabinet that may impede the flow of air through the ventilation openings.
5. Heat - The system should be situated away from heat sources such as radiators, heat registers, stoves, or other appliances (including amplifiers) that produce heat.
6. Power Sources - The system should be connected to a power supply only of the type described in the operating instructions or as marked on the system.
7. Servicing - The user should not attempt to service the system beyond that described in the operating instructions. All other servicing should be referred to qualified service personnel. The system should be serviced by qualified service personnel when:
  - A. The power-supply cord or the plug has been damaged.
  - B. Objects have fallen, or liquid has been spilled into the system.
  - C. The system has been exposed to rain or water.
  - D. The system does not appear to operate normally or exhibits a marked change in performance.

## Line Voltage Selection

- The desired voltage may be set with the VOLTAGE SELECTOR switch on the rear panel (using a flat head screw driver).
- Do not force the VOLTAGE SELECTOR switch as this may cause damage
- If the VOLTAGE SELECTOR switch does not move smoothly, please contact a qualified service technician.

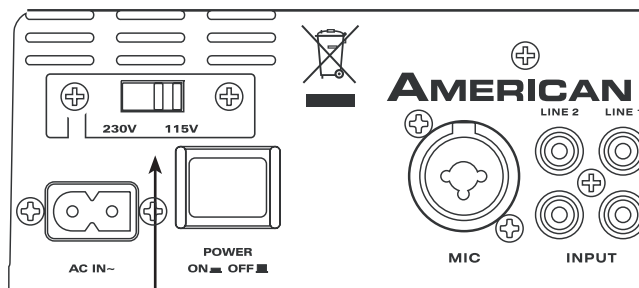

VOLTAGE SELECTOR switch

The serial and model number for this unit is located on the rear panel. Please write down the numbers here and retain for future reference.

Model No. \_\_\_\_\_

Serial No. \_\_\_\_\_

### Purchase Notes:

Date of Purchase \_\_\_\_\_

Dealer Name \_\_\_\_\_

Dealer Address \_\_\_\_\_

\_\_\_\_\_

Dealer Phone \_\_\_\_\_

## UNPACKING

Every CK 800Mp3 System has been thoroughly tested and has been shipped in perfect operating condition. Carefully check the shipping carton for damage that may have occurred during shipping. If the carton appears to be damaged, carefully inspect your system for any damage and be sure all equipment necessary to operate the system has arrived intact. In the event damage has been found or parts are missing, please contact our toll free customer support number for further instructions. Please do not return the system to your dealer without first contacting customer support.

## INTRODUCTION

### **Introduction:**

Congratulations and thank you for purchasing the American Audio® CK 800Mp3 System. This system is a representation of American Audio's continuing commitment to produce the best and highest quality audio products possible at an affordable price. Please read and understand this manual completely before attempting to operate your new system. This booklet contains important information concerning the proper and safe operation of your new system.

### **Customer Support:**

American Audio® provides a toll free customer support line, to provide set up help and answer any question should you encounter problems during your initial set up or operation. You may also visit us on the web at [www.AmericanAudio.us](http://www.AmericanAudio.us) for any comments or suggestions. Service Hours are Monday through Friday 8:00 a.m. to 4:30 p.m. Pacific Standard Time.

Voice: (800) 322-6337  
Fax: (323) 582-2941  
E-mail: [support@americanaudio.us](mailto:support@americanaudio.us)

To purchase parts online visit <http://parts.americandj.com>

**Caution!** There are no user serviceable parts inside this audio system. Do not attempt any repairs yourself, without being instructed to do so by an authorized American Audio service technician. Doing so will void your manufactures warranty. In the unlikely event your audio system may require service, please contact American Audio® customer support.

**Do not discard the packing carton in the trash. Please recycle when ever possible.**

## SET-UP PRECAUTIONS

Please be sure to make any connections before plugging the system in to an electrical outlet. All fader and volume controls should be set to zero or minimum position, before the system is switched on. If the system has been exposed to drastic temperature fluctuation (e.g. after transportation), do not switch on the system immediately. The arising condensation of water might damage your device. Leave the device switched off until it has reached room temperature.

### **Operating Determinations:**

- When installing this system, please make sure that the device is not exposed or will not be exposed to extreme heat, moisture or dust!
- Do not operate the system in extremely hot (more than 30°/86°F) or extremely cold (less than 5°C/40°F) surroundings.
- Keep the unit out of direct sunlight and away from heaters.
- Operate the system only after becoming familiar with its' functions. Do not permit operation by persons not qualified for operating the unit. Most damages are the result of unprofessional operation.

## MAIN FEATURES

- Plays Mp3, CD, and CD-R Discs
- Sleep Mode (c)
- 1/75th second frame search
- Pitch display
- Large bright LCD display can be viewed from wide angles.
- Digital Anti-Shock
- RELAY (Flip-Flop Playback) (b)
- Cue Mixing
- Seamless Loop (uninterrupted loop playback)
- 3 Band EQ per channel
- Front Access Combo Mic Jack
- Extremely clean signal to noise ratio
- Adjustable Pitch Percentages: +/-4%, +/-8%, and +/-16%
- Instant Start within 10ms (sound is produced immediately when the PLAY button is pressed)
- Auto cue
- Selectable Single or Continuous Play
- Real time cue (“Cue on the Fly”)
- Digital RCA coaxial output
- Fader “Q” Start Control (a)
- Jog Wheel Pitch Bend +/-100%
- Aux Input
- High output to headphones
- 2 Line Level Inputs
- Independent Gains Per Channel
- Record Out

- 
- (a) **FADER “Q” START CONTROL:** Set up your CK 800Mp3 as described in the set-up section of this manual. After set up is completed load your players. By moving the mixer’s crossfader from left to right you can start and pause each players playback functions. For Example, when using the CK 800Mp3 player, if your mixer’s crossfader is all the way to the left (player one is playing, player two is in cue or pause mode), and you move the fader at least 20% to the right, player two (2) will begin to play. When the crossfader is to the right, and you move it 20% to the left, player one (1) will begin to play. You can create great effects similar to scratching with this feature. After storing cue points on each side of the CD player, different songs may quickly be recalled by moving the mixer crossfader back and forth. New cue points can be easily selected on the CK 800Mp3 player (see setting cue points page 19). “Q” Start control is easy to use and mastering this feature will help you create amazing effects with your music.
- (b) **RELAY (FLIP-FLOP):** Connect your CK 800Mp3 player as described in the set-up section of this manual. This feature will start the next player once one (1) player has ended. For example, if player one (1) is playing a disc and it ends, player two (2) will instantly begin to play. You may set RELAY to play track to track or disc to disc. For more information on this feature, see RELAY (FLIP-FLOP™) on page 25.
- (c) **SLEEP MODE:** The CK 800Mp3's laser and pick-up assembly will power down after 15 minutes of inactivity (when in pause or cue mode). This will lengthen the life of your motor drive and laser. To initialize the player, just press the cue or play buttons.

## SET-UP

FOR BEST CD-R DISC PLAYBACK RESULTS IN THIS CD PLAYER PLEASE FOLLOW THESE GUIDELINES:

1. High quality CD-R Audio discs (should conform to the standards of the Orange Book 2).
2. Use a high quality bit rate when recording discs. (At least 160kbps)
3. Record discs in the slowest speed possible. (i.e. 2x or 4x speed)

### 1. Checking the Contents

Be sure your CK 800Mp3 was shipped with the following:

- 1) CK 800Mp3 Professional CD player/mixer.
- 2) Operating instructions (this booklet).
- 3) Warranty card.

### CAUTION:

- *To avoid severe damage to the unit, be sure the power is off when making connections to the unit.*

### CAUTION:

- The CK 800Mp3 will work normally when the unit is mounted with the front panel within 15 degrees of the vertical plane. If the unit is tilted excessively, discs may not be loaded or unloaded properly. (**Figure 1**)

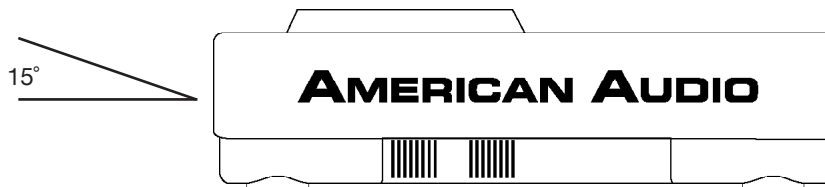

Figure 1

### CAUTION:

- The LCD is designed to be clearly visible within the angles shown in **Figure 2**. Mount the unit so that the visual angle is within this range.

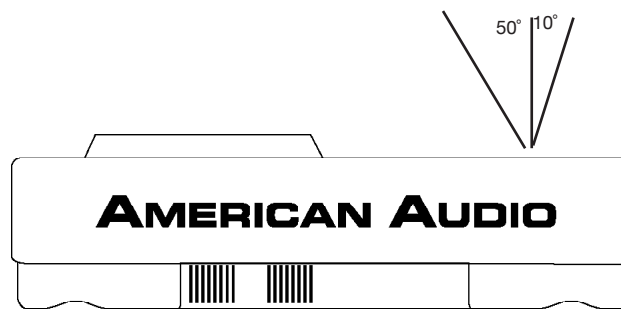
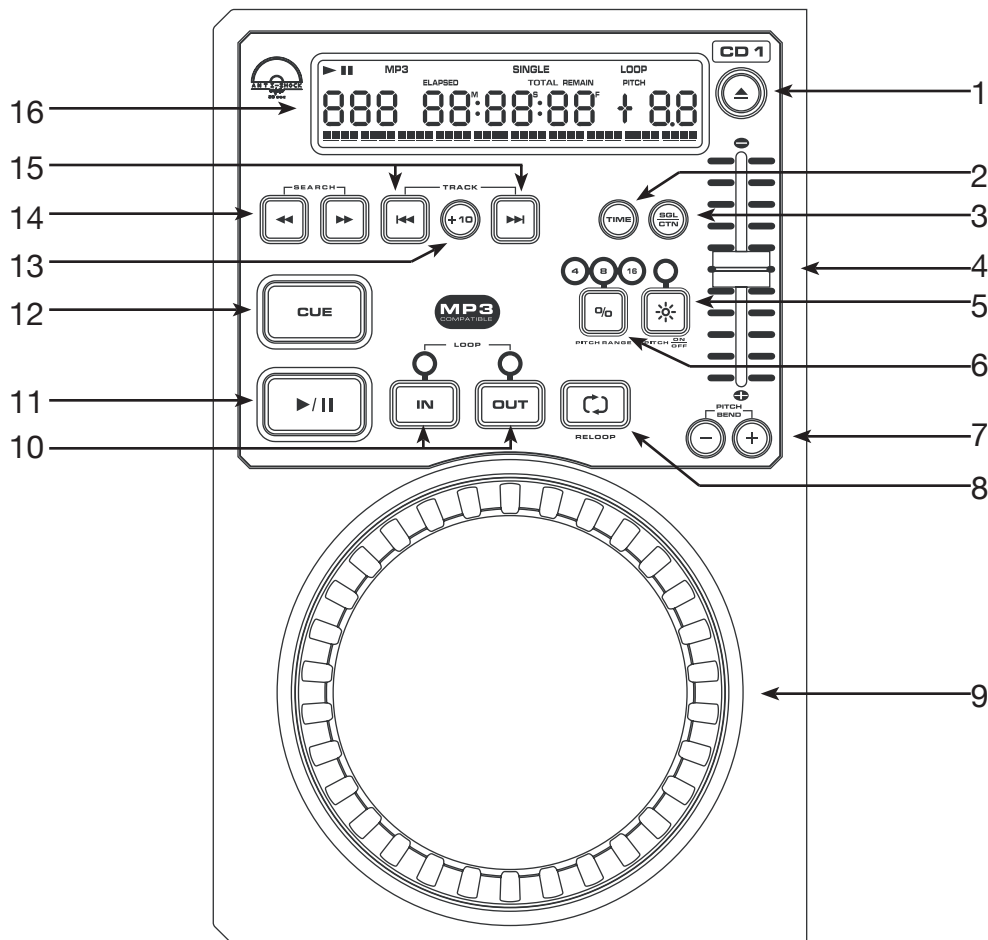

Figure 2



Figure 3



**A. TOP UNIT CONTROLS (FIGURE 3)**

**1. EJECT FUNCTION** - Pressing this will eject the CD. The eject function will only when the unit is in pause or cue mode, this is to prevent accidentally ejecting the disc when in play mode.

**2. TIME BUTTON** - The TIME button will switch the time value described in the *TIME METER* between ELAPSED PLAYING TIME, TRACK REMAINING TIME, and TOTAL REMAINING TIME (this is for CDs only).

**3. SGL/CTN** - This function allows you to choose between single track play or continuous track play (all tracks in order). This function also operates in RELAY (FLIP-FLOP) mode, when RELAY is activated.

**4. PITCH SLIDER** - This slider is used to adjust the playback pitch percentage. The slider is a

set adjustment and will remain set until the pitch slider is moved or the pitch function has been turned off. This adjustment can be made with or without a disc in the drive. The pitch adjustment will remain even if a disc has been removed and will reflect on any other disc loaded into the player. That is to say, if you set a +2% pitch on one disc, remove that disc and insert another, that disc too will have a +2% pitch. The amount of pitch being applied will be displayed in the LCD (16).

**5. PITCH ON/OFF BUTTON** - This button is used to switch the pitch function on and off. When the button LED is lit the *PITCH SLIDER* (4) is active. When the button LED is not lit, the *PITCH SLIDER* (4) is not active. The pitch percentage

can be changed between 4%, 8%, and 16%. 4% pitch percentage can be changed between 4%, will allow the least amount of pitch manipulation and 16% will allow the most amount of pitch manipulation.

**6. PITCH PERCENTAGE SELECTOR** - Press this button to select pitch range percentages of 4%, 8%, and 16%. See adjusting the *PITCH SLIDER'S RANGE* on page 22.

**7. (+) PITCH BEND BUTTON** - The (+) pitch bend function creates a momentary "BUMP" in the CD's BPM's (Beats per minute) while it is playing. This will allow you to match the beats between two playing CD's or any other music source. Remember, this is a momentary function. When you remove your finger from this button, the BPM's will automatically return to *PITCH SLIDERS (4)* selected pitch. Holding down this button will give a maximum of +16% pitch.

**(-) PITCH BEND BUTTON** - The (-) pitch bend function creates a momentary "Slow Down" in the CD's BPM's (Beats per minute) while it is playing. This will allow you to match the beats between two playing CD's or other playing music source. Remember, this is a momentary function. When you remove your finger from the pitch button, the BPM's will automatically return to *PITCH SLIDERS (4)* pitch value. Holding down this button will give a maximum of -16% pitch. Use this function to slow to another playing music source. Be sure to notice that this function is a momentary pitch adjustment, for a more precise adjustment use the *PITCH SLIDER (4)* to match the BPM's with another playing music source.

**8. RELOOP BUTTON** - If a SEAMLESS LOOP has been made (see setting a SEAMLESS LOOP on page 20), but the CD Player is not actively in SEAMLESS LOOP mode (a loop is not playing), pressing the RELOOP BUTTON will instantly reactivate the SEAMLESS LOOP mode. To exit the loop, press the *OUT BUTTON (10)*. LOOP will appear in the *LCD DISPLAY (16)* when the RELOOP function is available.

**9. JOG WHEEL/EFFECTS PLATTER** - This wheel has two functions;

- A. The jog wheel will act as a frame search control when the CD is in pause or cue mode, allowing you to set a cue point.
- B. The wheel also works as a pitch bend during Playback. Turning the wheel clockwise will increase the pitch percentage up to 100%, and turning the wheel in the counter-clockwise direction will decrease the pitch percentage down to -100%. The pitch bend will be determined on how long you turn the jog wheel continuously.

**10. OUT BUTTON** - This button is used to set the ending point of a loop. A loop is started by pressing the *IN BUTTON*, and pressing the *OUT BUTTON* to set the loop ending point. The loop will continue to play until the *OUT BUTTON* is pressed once again.

**SEAMLESS LOOP IN BUTTON** - "CUE ON THE FLY" - This function allows you to set a CUE POINT (see CUE POINT page 19) without music interruption ("on the fly"). This button also sets the starting point of a seamless loop (see SEAMLESS LOOP).

**11. PLAY/PAUSE BUTTON** - Each press of the PLAY/PAUSE BUTTON causes the operation to change from play to pause or from pause to play. While in play mode the blue play LED will glow, and while in pause mode the blue play LED will flash.

**12. CUE** - Pressing the CUE button during playback immediately pauses playback and returns the track to the last set cue point (see setting a CUE POINT, page 19). The red CUE LED will glow when the unit is in cue mode The LED will also flash every time a new CUE POINT is set. The CUE button can be held down to momentarily play the CD. When you release the CUE button it instantly returns to the CUE POINT.

**13. +10 TRACK SKIP** - This button allows you to skip ahead by 10 tracks. Example: if you are at Track #1, pressing this button will skip you to Track #11, press the button again, it will skip to Track #21. If there are not that many tracks, it will go back to Track #1.

**14. SEARCH BUTTONS -**

 This search button allows you to quickly scan backwards through a track.

 This search button allows you to quickly scan forwards through a track.

**15. TRACK BUTTONS -**

 This button is used to select a track. Tapping this button will forward skip to the next track, holding down this button will rapidly forward skip through the tracks.

 This button is used to select a track. Tapping this button will back skip on track, holding down this button will rapidly back skip through the tracks.

**16. LCD DISPLAY** - This high quality LCD display indicates all the various functions, as they are occurring. This display is viewable at several comfortable angles (see page 8). The display ICONS will be explained on page 16.

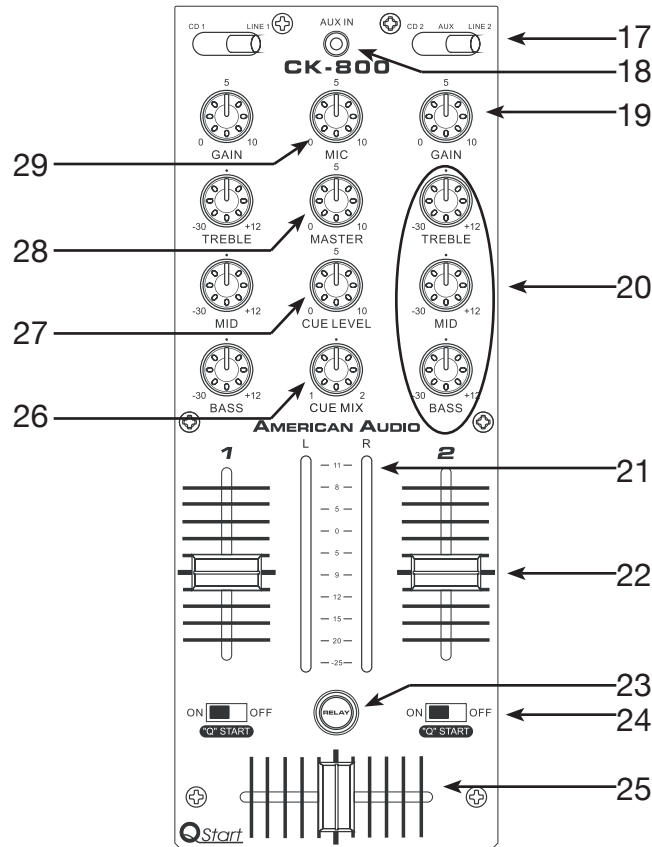

**17. SOURCE SELECTOR SWITCH** - These switches are used to select the input source assigned to each channel. Each channel may only be assigned one input source at a time.

**18. AUX INPUT** - This Aux input is for the use of a Mp3 player. Input volume will be controlled by the channel two fader

**19. CHANNEL GAIN CONTROL** - This adjustment is used to adjust an audio source signal input gain for a channel. Never use the gain control to adjust output volume. Setting the gain level properly will ensure a clean output signal. To properly set the gain level controls:

1. Be sure the *MASTER VOLUME CONTROL* (28) is set to level 4.
2. Set the *CHANNEL FADER* (22) to level 8.
3. Begin playback on an audio source connected to the channel you are adjusting.
4. Use the Gain Control (19) to adjust an average output volume of +4 dB.

5. Repeat this step for all channels

**20. CHANNEL EQUALIZER** - All of the channels include a three-band signal EQ. These controls are used to increase or decrease the LOW's, MID's, and HI's of the output signal.

**CHANNEL TREBLE CONTROL** - This knob is used to adjust the treble levels of a channel allowing for a maximum treble gain of +12dB or maximum decrease of -30dB. Turning the knob in a counter-clockwise direction will decrease the amount of treble applied to a channel signal, turning the knob in a clockwise direction will increase the amount of treble applied to a channel signal.

**CHANNEL MIDRANGE CONTROL** - This knob is used to adjust the midrange levels of a channel allowing for a maximum midrange gain of +12dB or maximum decrease of -30dB. Turning the knob in a counter-clockwise direction will decrease the amount of midrange applied to a channel signal, turning the knob in a clockwise direction will increase the amount of midrange

applied to a channel signal.

**CHANNEL BASS CONTROL** - This knob is used to adjust the low frequency levels of a channel allowing for a maximum bass gain of +12dB or maximum signal decrease of -30dB. Turning the knob in a counter-clockwise direction will decrease the amount of bass applied to a channel signal, turning the knob in a clockwise direction will increase the amount of bass applied to a channel signal.

#### 21. MASTER VOLUME LEVEL INDICATORS -

The dual MASTER LEVEL LED indicators are used to detail the master output level. The meters will detail the output level of both the left and right channels.

**22. CHANNEL FADER** - These faders are used to control the output signal of any source assigned to its particular channel.

**23. RELAY BUTTON** - This button activates the FLIP-FLOP™ function.

**24. Q-START ON/OFF SWITCH** - With this function you can use the crossfader to start and stop the CD play. The ON/OFF “Q” START switch activates the fader “Q” start feature. When the fader “Q” start feature is activated sliding the *CROSS-FADER (25)* from left to right will play or cue the CD player connected.

Example: Be sure the Fader “Q” Start feature is activated on both channels.

Slide the crossfader to the channel one position (full left) and begin playback on CD drive one. Slide the crossfader to the channel position (far right). This will immediately trigger the play function on CD drive two and return CD drive one to cue mode. To return to normal fader operation turn the Fader “Q” Start ON/OFF SWITCH to the OFF position.

**25. REPLACEABLE CROSSFADER** - This fader is used to blend the output signals of channels one and two together. When the fader is in the full left position (channel 1), the output signal of channel one will be controlled by the master volume level. The same fundamentals will apply for channel two. Sliding the fader from one position to

another will vary the output signals of channels one and two respectively. When the crossfader is set in the center position, the output signals of both the channels one and channels two will be even.

**26. CUE MIX** - This knob is used send a channels incoming signal to the headphones. Turn the knob counter-clockwise to monitor Channel 1, and clockwise to monitor Channel 2. The cue level is adjusted by the *CUE LEVEL VOLUME KNOB (27)*. Be sure the cue level is set to minimum before putting a pair of headphones on.

**27. CUE LEVEL VOLUME KNOB** - This knob is used to adjust the headphone volume output level. Turn the knob in a clockwise direction to increase the headphone volume.

**28. MASTER VOLUME CONTROL** - This rotary knob is used to control the master output level (volume). To avoid distorted output try to maintain an average output signal level +4 dB. Be sure this volume control is always set to zero before turning the unit on.

**29. MICROPHONE VOLUME** - This knob is used to regulate the microphone output volume. Turning the knob in a clockwise direction will increase the volume level.

Figure 4

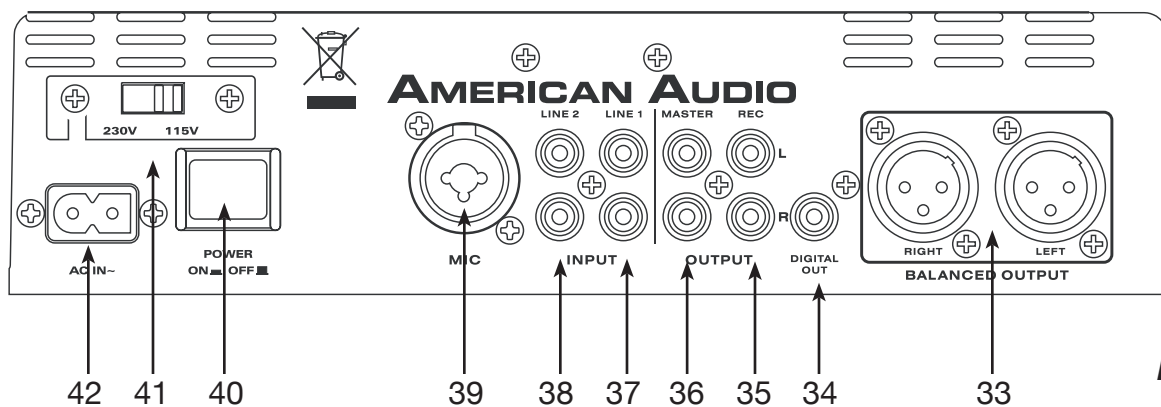
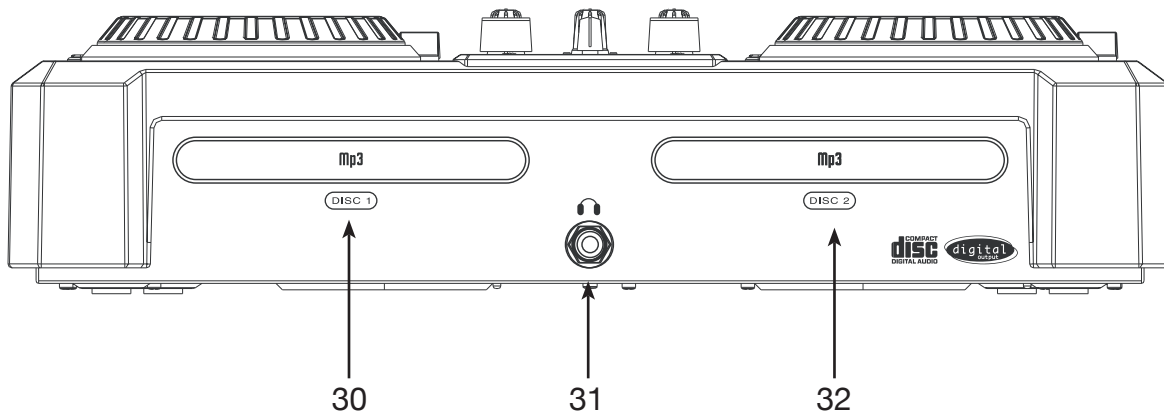

Figure 5

## B. FRONT PANEL (FIGURE 4)

**30. TRANSPORT TRAY 1** - This tray is used to load and unload a compact disc. The tray is opened and closed by pressing the OPEN/CLOSE BUTTON (1). Never attempt to force the transport tray open or closed when the power is turned off.

**31. HEADPHONE JACK** - This jack is used to connect your headphones to the mixer allowing you to monitor the cue source. Use headphones only rated at 8 ohms to 32 ohms. Most DJ headphones are rated at 16 ohm, these are highly recommended. Always be sure the *CUE LEVEL VOLUME* (27) is set to minimum before you put the headphones on.

**32. TRANSPORT TRAY 2** - This tray is used to load and unload a compact disc. The tray is opened and closed by pressing the OPEN/CLOSE BUTTON. Never attempt to force the transport tray open or closed when the power is turned off.

## C. REAR PANEL (FIGURE 5)

**33. BALANCED XLR MASTER OUTPUTS JACKS** - The Master Output includes a pair of XLR Balanced jacks as well as a pair of *RCA UNBALANCED JACKS* (38). The 3-pin XLR jacks send a high current balanced output signal. These jacks should be used when you will be driving an amp or other audio equipment with a balanced input, or whenever you will be running a signal line greater than 15 feet. Always, use these jacks whenever possible.

**34. DIGITAL OUT** - Use this connection to create near perfect copies of your disc to a Mini disc, CD-R, or any other digital recording device.

**35. REC OUT** - This is a low current unbalanced output source designed for various tape and CD recorders. The Record Out (REC OUT) level is dictated by the *CHANNEL FADER LEVEL* (22), it is not influenced by the *MASTER VOLUME CONTROL* (28).

**36. RCA MASTER OUTPUTS** - The RCA jacks send a low current unbalanced output signal. These jacks should only be used for shorter cable runs to signal processors or looping to another mixer. For cable runs greater than 15 feet use the *XLR BALANCED JACKS (33)*.

**37. LINE 1 INPUT JACKS** - *DO NOT CONNECT TURNTABLES TO THESE JACKS!* CD players, Tape Decks and other line level instruments may be connected to these jacks. The red colored RCA jack represents the right channel input and the white represents the left channel input. Input volume will be controlled by channel one fader. The channel *SOURCE SELECTOR SWITCH (17)* must be in the "Line 1" position, to monitor any source connected to these jacks.

**38. LINE 2 INPUT JACKS** - *DO NOT CONNECT TURNTABLES TO THESE JACKS!* CD players, Tape Decks and other line level instruments may be connected to these jacks. The red colored RCA jack represents the right channel input and the white represents the left channel input. Input volume will be controlled by channel two fader. The channel *SOURCE SELECTOR SWITCH (17)* must be in the "Line 2" position, to monitor any source connected to these jacks.

**39. MICROPHONE** - This combo jack will accept a standard 1/4 plug or XLR 3-pin balanced male plug. The volume output level for this microphone will be controlled by its own respective *MIC KNOB (29)*. **Note: We recommend that you use a 500-600ohm microphone for the best sound quality.**

**40. POWER BUTTON** - This button is used to turn your unit's power on and off.

**41. VOLTAGE SELECTOR** - Because power supplies vary from location to location we have incorporated a selectable voltage switch. This switch can select a voltage input of 115v~60Hz or 230v~50/60Hz. Always disconnect the power plug before changing the voltage.

***Dual Voltage models only***

**42. POWER CONNECTOR** - This connection is used to connect your main power. Be sure that your local power matches the unit's required power. ***NEVER REMOVE THE GROUND PRONG FROM THE POWER CABLE, DOING SO MAY RESULT IN IMPROPER OPERATION.***

Figure 6

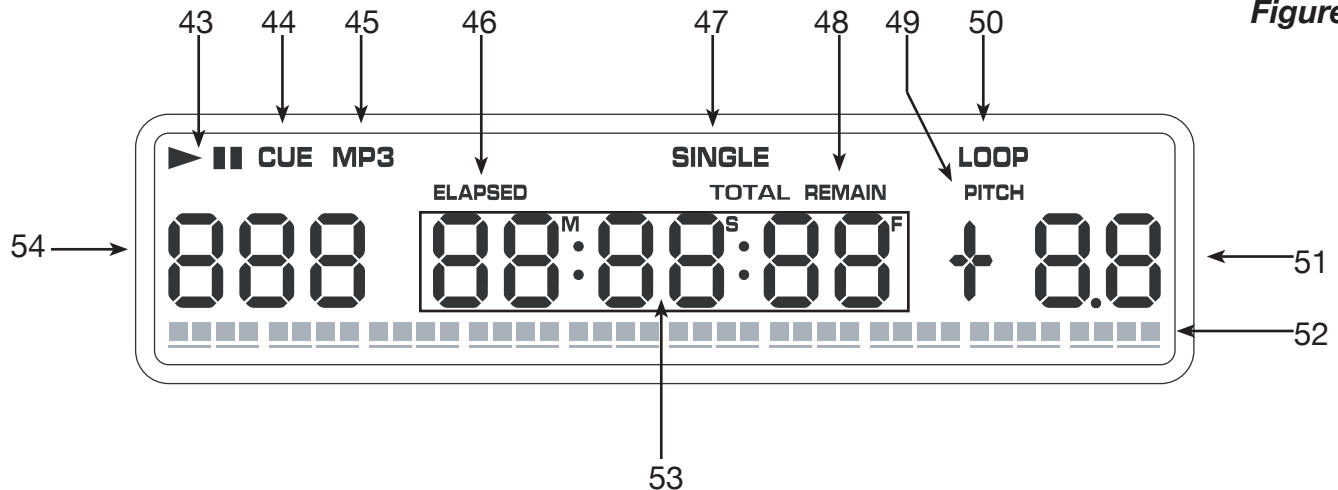

#### D. LCD DISPLAY PANEL (FIGURE 6)

**43. PLAY/PAUSE INDICATOR** - Either the play or pause indicator will glow depending which mode you are in.

**44. CUE INDICATOR** - This indicator will glow when the unit is in CUE or mode and will flash every time a new CUE POINT is set.

**45. MP3 INDICATOR** - This will indicate that a Mp3 disc is loaded in the drive.

**46. ELAPSED INDICATOR** - This indicator is in direct reference to the *TIME METER* (53). When the ELAPSED indicator is displayed in the *LCD* (16), the time defined will refer to a single track's elapsed time. The time mode is changed by the tapping on the *TIME BUTTON* (2).

**47. SINGLE INDICATOR** - This indicates that the CD drive is in single play mode, the track will play once and return to CUE mode. If the single indicator is not on the unit is in continuous mode. In continuous mode the drive will play all the remaining tracks on the disc.

**48. TOTAL REMAIN INDICATOR** - When "REMAIN" is indicated in the *LCD DISPLAY* (16) the *TIME DISPLAY* (53) in the *LCD* will define the current track's remaining time. When "TOTAL REMAIN" is indicated in the *LCD DISPLAY* (16) the *TIME DISPLAY* (53) in the *LCD* will define the total disc remaining time (for CD only).

**49. PITCH INDICATOR** - This icon will glow when the pitch function is activated.

**50. LOOP** - This icon will glow when you are in loop mode.

**51. PITCH METER** - This meter will display the pitch percentage applied by the *PITCH SLIDER* (4).

**52. TIME BAR INDICATOR** - This bar gives a visual approximation of a track's or disc's remaining time. This bar will begin to flash when a CD is ending.

**53. TIME DISPLAY** - These indicators detail the Minutes, Seconds, and Frames. The meter will display either the elapsed or remaining time of a track.

**54. TRACK INDICATOR** - This indicator details the current track. The number displayed in the track indicator is a direct reference to the track in play, pause, or cue mode.



# BASIC OPERATIONS

## 1. LOADING/EJECTING DISCS

The CK 800Mp3 can only play 3 inch and regular 5 inch CDs. When loading a CD into the player always hold the disc by it edge). Load the disc label side up and never touch the signal surface (the glossy side). To remove a disc from the player press the *EJECT BUTTON* (1), see Figure 7.

### CAUTION:

- **NEVER** attempt to load any other objects besides 3" and 5" CDs.
- **NEVER** attempt to load more than one disc at a time. Doing so may result in sever damage to your unit.
- **DO NOT** force the transport tray open or close when the power is off, this may damage the drive system.

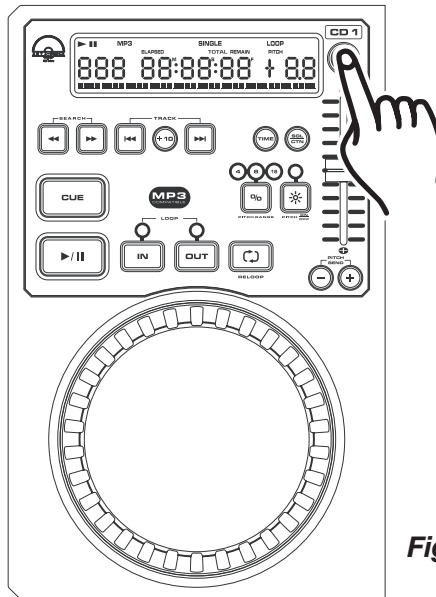
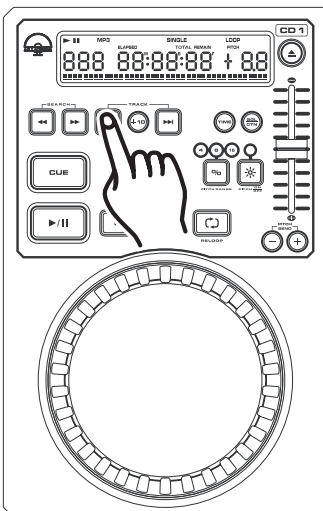

Figure 7

**Figure 7:** Press the Eject button to load and remove a disc. **Remember:** When loading a disc always hold the disc by it edges and load the disc label side up.

## 2. SELECTING TRACKS

Select a desired track by using the *TRACK BUTTONS* (15). Tapping the *TRACK BUTTONS* (15) once will select either the next higher or lower track. You may hold down the *TRACK BUTTONS* (15) to change tracks continuously at a faster speed. If you are using the *TRACK BUTTONS* (15) to select a new track during playback (a track is already in play mode) the new track you selected will immediately begin playback as soon as the search operation is completed.



**Figure 8:** Tapping the reverse track button will jump back to the previous track.

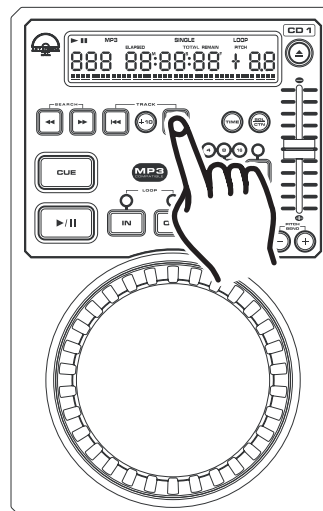

**Figure 9:** Tapping the forward track button will skip forward to the next track.

## BASIC OPERATIONS (CONT.)

### 3. STARTING PLAYBACK - *Figure 10*

Load an audio CD as describe on page 17 (*LOADING/EJECTING DISCS*). Pressing the *PLAY/PAUSE BUTTON (11)* with an audio CD loaded will immediately start playback. The *PLAY (43)* indicator will glow as soon as playback begins. The point at which playback starts (cue point) will automatically be stored in the memory as the cue point. The unit will return to this cue point (the point at which playback started) when the *CUE BUTTON (12)* is pressed.

### 4. PAUSING - *Figure 10*

This function pauses playback at the exact same point the *PLAY/PAUSE BUTTON (11)* was pressed. Pressing the *PLAY/PAUSE BUTTON (11)* will switch between play and pause modes. When the unit is in pause mode the *PAUSE INDICATOR (43)* will show in the *LCD DISPLAY (16)*. The blue *PLAY/PAUSE BUTTON (11)* LED will also begin to flash repeatedly.

### 5. AUTO CUE

This function will automatically set a cue point to the first audio source when a CD is loaded. The first set cue point will always be the beginning of track 1. If a new track is selected before the *PLAY BUTTON (11)* is pressed, a new *CUE POINT* will be set to reflect the new starting point.

### 6. STOPPING PLAYBACK - *Figures 10 & 11*

Stopping playback will not stop the drive mechanism, but merely pause or cue the track, this functions allows the unit to begin play instantly. The drive mechanism will only stop if a disc is ejected or the unit has gone in to sleep mode. There are two ways to stop (pause) playback:

- 1) Press the *PLAY/PAUSE BUTTON (11)* during playback. This will pause playback at the exact same point the *PLAY/PAUSE BUTTON (11)* was pressed.
- 2) Press the *CUE BUTTON (12)* during playback. This will pause playback and return the track to the last set cue point.

### 7. FRAME SEARCH

This feature allows you to scroll through a track frame by frame, allowing you to find and set a starting cue or loop point. To use the scroll function you must first be in Pause Mode (see section 4) or Cue Mode (see section 8). Once you are in Pause or Cue mode, turn the *JOG WHEEL (9)* to scroll through the track (*Figure 12*). Turning the wheel in a clockwise direction will advance the frame search and turning the wheel in a counter-clockwise direction rewinds the frame search. When you use the *JOG WHEEL (9)* the monitor (headphone level) function allows you to hear what you are scrolling through. Once you reach your desired starting point you can set a cue (starting) point by pressing the *PLAY/PAUSE BUTTON (11)* as in *Figure 10*. Pressing the *CUE BUTTON (12)* as in *Figure 11* will now return you to the point you just set.

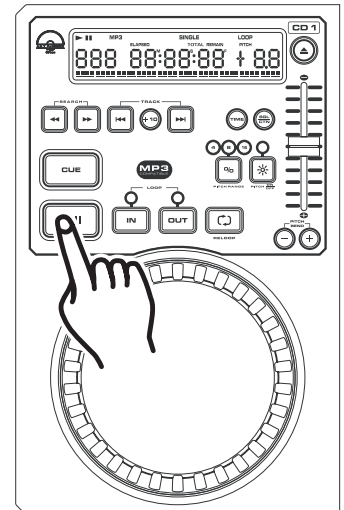

*Figure 10*

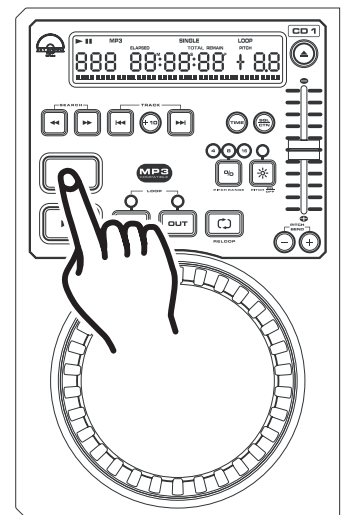

*Figure 11*

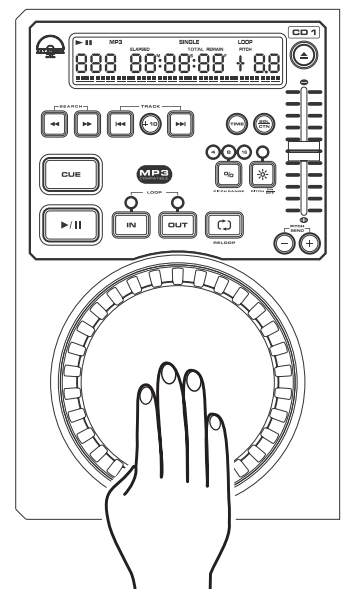
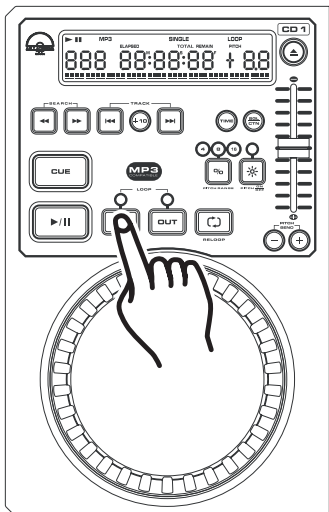

*Figure 12*

## BASIC OPERATIONS (CONT.)

### 8. SETTING A CUE POINT

A cue point is the exact point playback will begin when the *PLAY/PAUSE* button (11) is pressed. You may set your cue points anywhere on a disc or in a track. There are three (3) ways to set and create a CUE point as detailed in figures 13 and 14.



- 1) You may press the *IN BUTTON* (10) on the fly (while the disc is playing). This will set a CUE Point without music interruption. Pressing the *CUE BUTTON* (12) will now return you to the same point that you pressed the *IN BUTTON* (10).

**Figure 13**

- 2) You may also use the *JOG WHEEL* (9) to set a cue point. While a disc is in PAUSE or CUE mode, use the *JOG WHEEL* (9) to scroll through a track and find your desired starting point. Once you have found your desired CUE point press the *PLAY BUTTON* (11) to set your cue point. Pressing the *CUE BUTTON* (12) will now return you to this exact point.

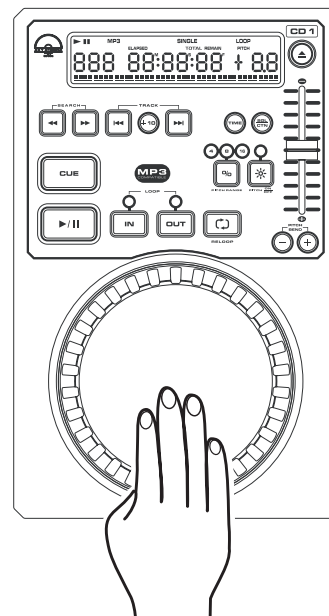

**Figure 14**

- 3) You may also use the *SEARCH BUTTONS* to set a cue point. While a disc is in PAUSE or CUE mode, use the *SEARCH BUTTONS* to scan through a track to find your desired starting point. Once you have found your desired position press the *PLAY BUTTON* to set your cue point. Pressing the *CUE BUTTON* will now return you to this exact point.

## BASIC OPERATIONS (CONT.)

### 9. CREATING AND PLAYING A SEAMLESS LOOP

A seamless loop is a sound loop that plays continuously without sound interruption. You can use this loop to create dramatic effect in your mixing. This loop has no time limit and you could actually loop the entire length of disc. You create a seamless loop between two continuous points of a disc.

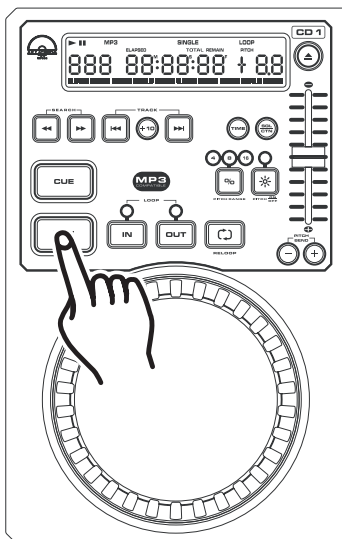

1) Press *PLAY/PAUSE BUTTON (11)* to activate playback mode.

**Figure 15**

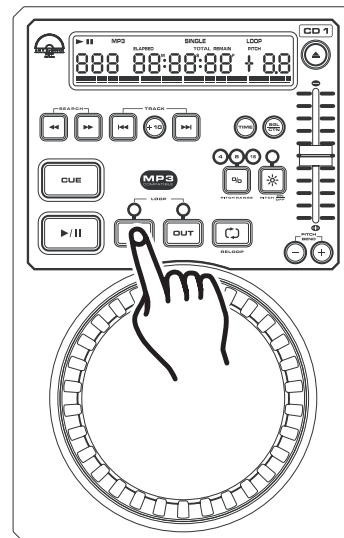

2) Press the *IN BUTTON (10)*. This will set the starting point of the SEAMLESS LOOP. The *IN BUTTON (10)* LED will light.

**Figure 16**

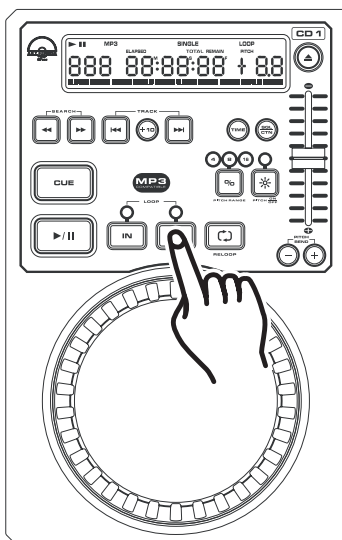

3) Press the *OUT BUTTON (10)* to set the ending point for your LOOP (Figure 17). The *IN BUTTON (10)* and *OUT BUTTON (10)* LEDs will immediately begin to flash rapidly, indicating the SEAMLESS LOOP mode has been activated.

**LCD LOOP INDICATORS** - During a loop, the *LOOP INDICATOR (50)* will turn on in the *LCD DISPLAY (16)* indicating a loop is active.

**Figure 17**

**EXITING A LOOP** - To exit a SEAMLESS LOOP, press the *OUT BUTTON (10)*. The *IN BUTTON (10)* and *OUT BUTTON (10)* LEDs will remain lit. Music playback will resume normal play. The *IN BUTTON (10)* and *OUT BUTTON (10)* LEDs will remain lit to remind you that a loop is in memory.

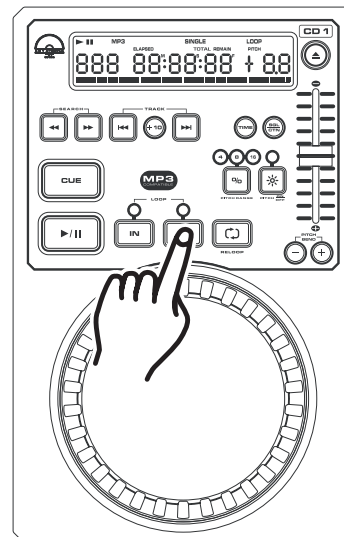

**Figure 18**

## BASIC OPERATIONS (CONT.)

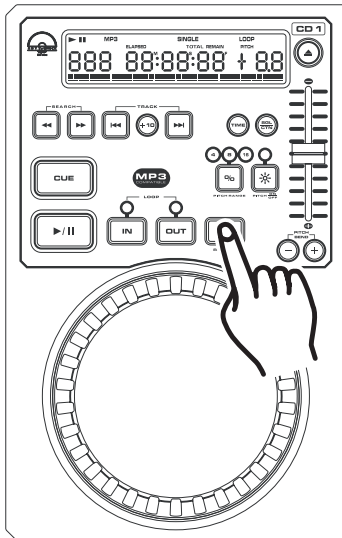

**REPLAY LOOP** - The *RELOOP* (8) function allows you to return to your stored loop at any time. The *IN BUTTON* (10) and *OUT BUTTON* (10) LEDs will indicate a loop is stored in memory, and may be played at any time. To replay the loop, press the *RELOOP BUTTON* (8). The *IN BUTTON* (10) and *OUT BUTTON* (10) LEDs will again begin to flash indicating SEAMLESS LOOP mode has been activated and your loop will immediately begin to play.

Figure 19

### 10. CHANGING THE TIME DISPLAY (53)/TIME BAR (52):

DURING NORMAL PLAYBACK, pressing the *TIME BUTTON* (2), will change the time display information (53) in the *LCD* (16). The following is a break down of the time settings and their definitions:

- 1) *REMAIN* (48) - This details the time in the *LCD* (16) as the current tracks' remaining running time.
- 2) *ELAPSED* (46) - This details the time in the *LCD* (16) as the current tracks' elapsed running time.
- 3) *TOTAL REMAIN* (48) - This details the time in the *LCD* (16) as the current CD total remaining running time (this is for CDs only).

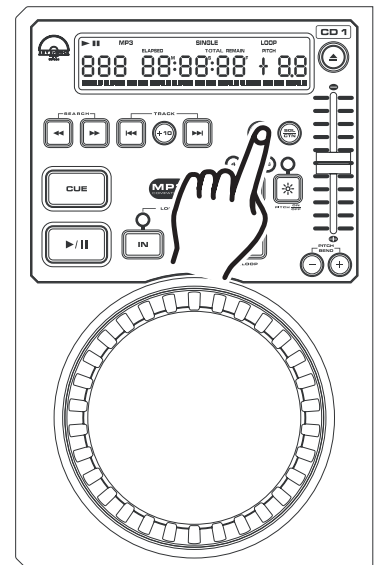

Figure 20

**TIME BAR INDICATOR** - Details the time defined in the *TIME METER* (52) as a visual bar icon. As with the *TIME METER* (52) this bar is also dependent on the selected time function [*REMAIN* (48) OR *ELAPSED* (46)]. This bar will begin to flash when a track is ending regardless of which time function you are in. Use the flashing bar as a visual reminder that a track is ending.

# PITCH ADJUSTMENTS

## PITCH ADJUSTMENTS:

You can activate the *PITCH SLIDER* (4) by pressing the *PITCH ON/OFF BUTTON* (5). When the button LED is lit, the *PITCH SLIDER* is active and the pitch can be adjusted. When the button LED is not lit *PITCH SLIDER* is not active. The different pitch adjustments allow a track's or a loop's playback speed to be manipulated. This speed manipulation is commonly used to beat match between two or more music sources such as a turntable or another CD player. The playback speed may be increased or decreased by a factor of +/-16. The next section details the different pitch manipulation schemes.

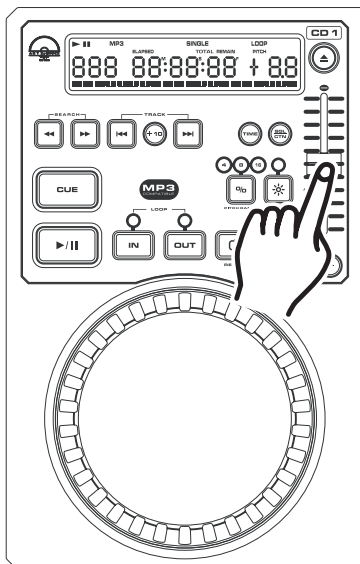

### 1. PITCH SLIDER (4):

This function will increase or decrease the tracks playback speed or "PITCH." The maximum pitch percentage manipulation in this function is +/-100%. The *PITCH SLIDER* (4) is used to decrease or increase the playback pitch. If the slider is moved up (towards the top of the unit) the pitch will decrease, if the slider is moved down (towards the bottom of the unit) the pitch will increase. The *PITCH SLIDER* adjustment can be changed to range from +/-4%, +/-8%, or +/-16% (See changing "PITCH SLIDER PERCENTAGE RANGE" on the next page). This pitch adjustments will effect normal playback and loops only when the *PITCH ON/OFF BUTTON* (5) is turned on.

Figure 21

**Activating the PITCH SLIDER (4):** To activate the *PITCH SLIDER* you must turn on the pitch adjustment function. Press the *ON/OFF BUTTON* (5) located at the top right of the unit. The *ON/OFF BUTTON* (5) LED will glow when the function is activated. If the pitch function is not activated the *PITCH SLIDER* will not function.

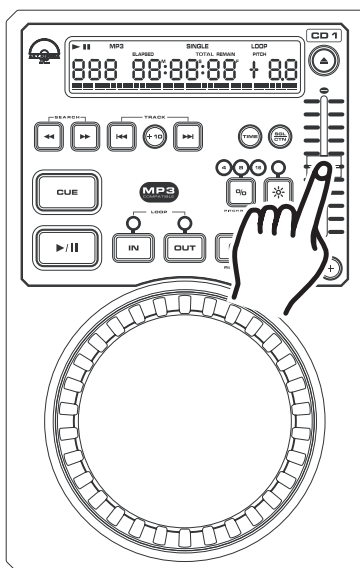

Figure 22

**Using the PITCH SLIDER (4):** Be sure the pitch function has been activated as described above. To use the *PITCH SLIDER* slide the slider up and down. Down will increase the pitch and up will decrease the pitch.

Figure 23

## PITCH ADJUSTMENTS

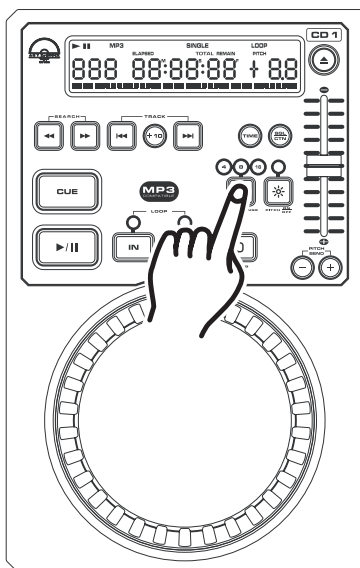
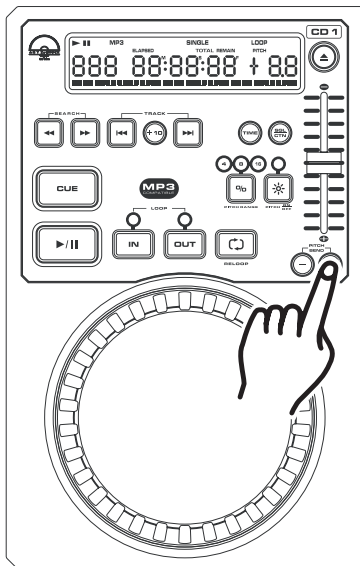

Figure 24

**Adjusting the PITCH SLIDER'S RANGE (6):** You may change the PITCH SLIDER'S (5) operating range at any time. To change the operating range be sure the pitch function is turned on, see figure 33. The pitch percentage can be changed between +/-4%, +/-8%, and +/-16%. 4% will allow the least amount of pitch manipulation and 16% will allow the most amount of pitch manipulation. To adjust the different ranges, press the PITCH ON/OFF BUTTON (5) and tap on the PITCH RANGE BUTTON (6) until your desired value is reached, see figure 24.

### 2. PITCH BENDING:

Unlike the PITCH SLIDER (4) adjustment this function will momentarily increase or decrease a tracks speed during playback. There are two ways to operate this function with the (-) & (+) PITCH BEND BUTTONS (7) or with the JOG WHEEL (9). The maximum pitch bend percentage allowed is +/- 16%. The pitch bend function will work in conjunction with the PITCH SLIDER (4) pitch setting. For example, if the PITCH SLIDER (4) is set to a 2% pitch gain the pitch bending process will begin at 2% and will continue to the maximum of +/- 16%.



Holding down or tapping on the (+) PITCH BEND BUTTON (7) will provide a speed bump in the playback pitch.

Figure 26

Holding down or tapping on the (-) PITCH BEND BUTTON (7) will provide a slow down in the playback pitch.

Figure 25

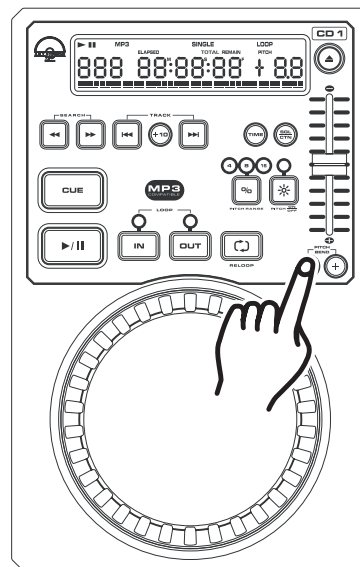

### PITCH BEND BUTTONS (7):

The (+) PITCH BEND BUTTON (7) will increase track playback speed and the (-) PITCH BEND BUTTON (7) will decrease track playback speed. The extent to which the speed changes is proportionate to the amount of time the button is pressed. For example, if the (+) PITCH BEND BUTTON (7) is held down continuously as in figure 26, the disc speed will increase and will continue to increase until it reaches a maximum of 16% speed gain. When you release the (+) PITCH BEND BUTTON (7) the disc speed will automatically return to its previous set speed.

## PITCH ADJUSTMENTS

### 3. JOG WHEEL (9):

The *JOG WHEEL* will temporarily bend the pitch if a track is in playback mode. Rotating the wheel in a clockwise direction will increase your track pitch and rotating the wheel in a counter-clockwise direction will slow your track pitch. The speed you rotate the *JOG WHEEL* will determine pitch bend percentage (%). For example, if the *JOG WHEEL* is continuously turned in a counter-clockwise direction the playback speed will steadily decrease and will continue to decrease until playback reaches a maximum of -100% and playback stops entirely. When you stop turning the *JOG WHEEL* the disc speed will automatically return to its previous set speed.

**Figure 27**

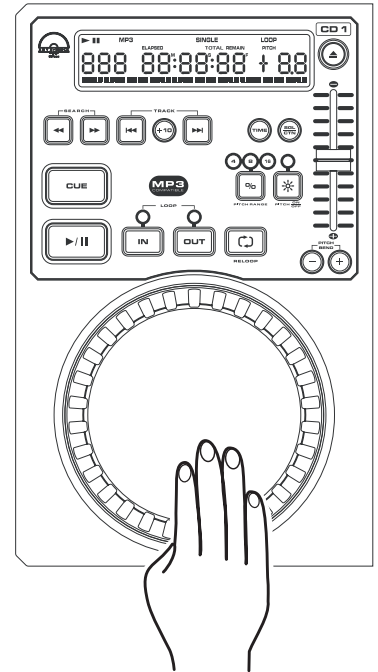



## RELAY (FLIP-FLOP™)

### RELAY (FLIP-FLOP™)

This feature is a kind of “auto pilot”. When you are using the CK 800Mp3 system, you can have one player begin playback when the other ends. You can “Flip-Flop™” single tracks, the entire disc, or a combination of the two.

#### **To FLIP-FLOP™ single tracks:**

- 1) Set the mixer's crossfader to the center position, and press the *RELAY BUTTON (23)*. Also, set both
- 2) Set the two players to playback in single mode, *SINGLE (47)* should be indicated in the *LCD (16)*.
- 3) Load your two players with audio discs.
- 4) After they have both cued, press the *PLAY/PAUSE BUTTON (11)* on one player to begin playback.
- 5) After the first player's single track has ended the second player's track will immediately begin playback.
- 6) FLIP-FLOP™ will continue until you stop it or power is interrupted.

#### **To Flip-Flop entire CDs:**

Be sure your players are both in continuous play mode, make sure *SINGLE MODE (47)* does not appear in the *LCDS (16)* of both players. Follow all directions for single track FLIP-FLOP™ above. When one player's disc ends the other player will immediately begin playback.

**Note:** You may combine FLIP-FLOP™ single and continuously playback modes by selecting either single or continuous playback on your units.

# MIXER SET-UP

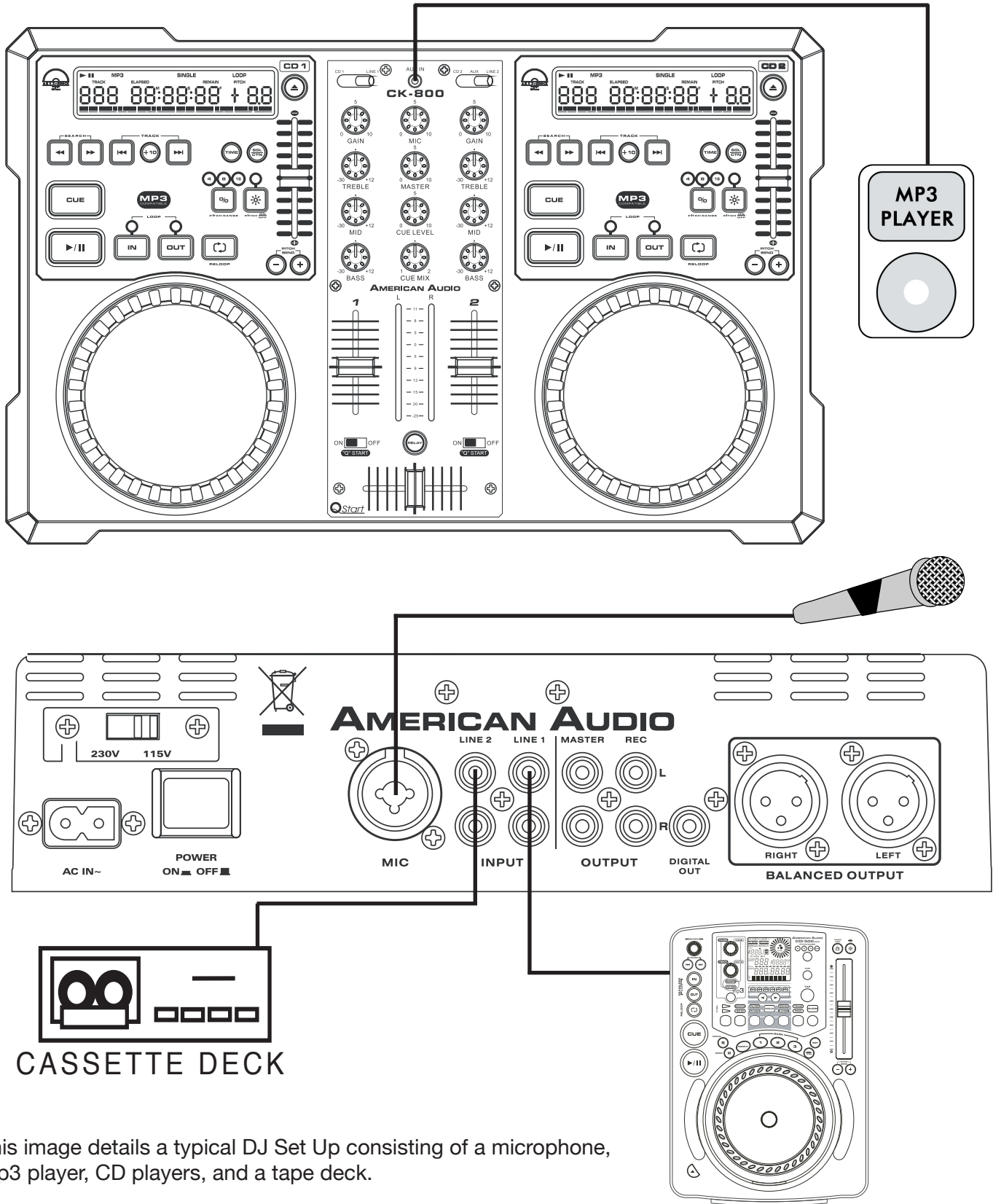

This image details a typical DJ Set Up consisting of a microphone, Mp3 player, CD players, and a tape deck.

**Note: Turntables cannot be connected to the CK 800Mp3.**

# MIXER SET-UP

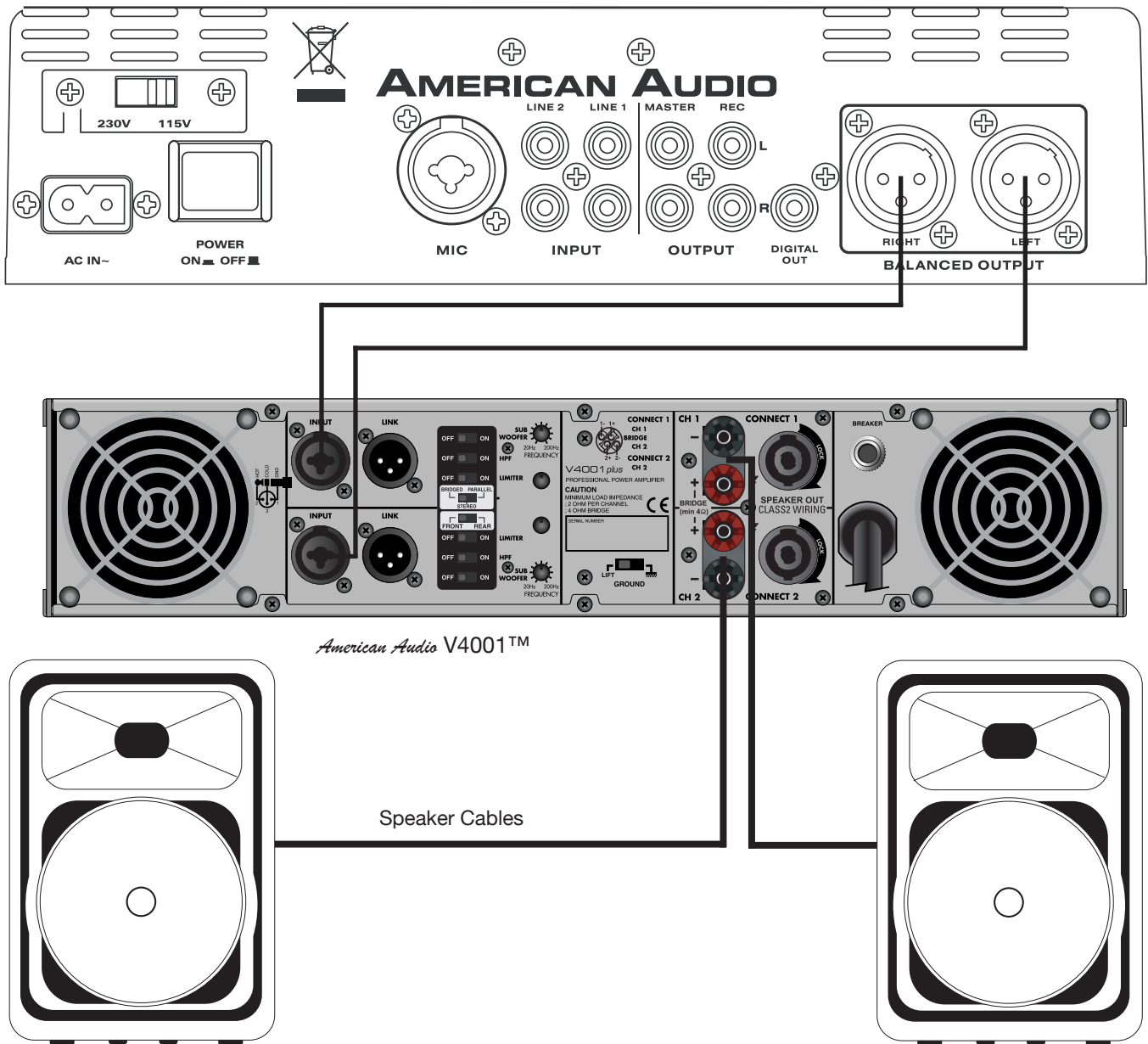

## Typical Balanced Output Set-up

This image details a typical stereo output layout. Note the use of the Balanced XLR Jacks on both the mixer and the amplifier. Always use the balanced output jacks whenever possible. The balanced output jacks should always be used for cable runs in excess of 15 feet.

Using the balanced jacks will ensure a clean signal through out the entire audio system.

## CROSSFADER REPLACEMENT

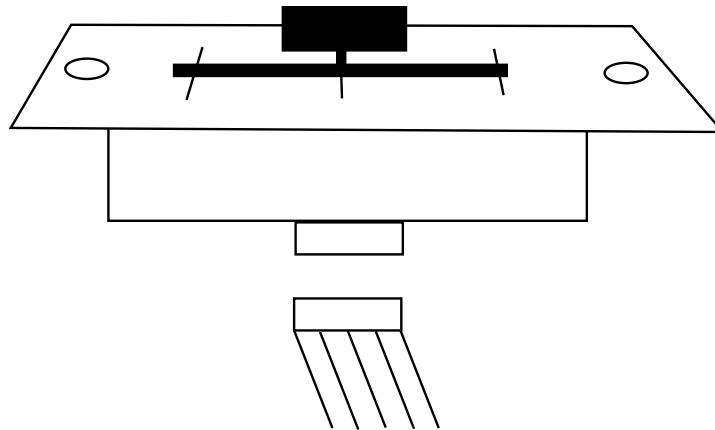

The crossfader is “Hot Swapable” which means it may be replaced at any time, even when power is applied. Only replace with American Audio Part Feather Fader Plus. Replacing with any other model fader may seriously damage your mixer.

### Replacing the Crossfader:

1. Disconnect the systems main power supply
2. Using a Phillips screw driver, unscrew the six stainless steel retainer screws that hold the mixer face plate in place.
3. Gently remove the channel fader knobs and crossfader knob. Lift the mixer face plate from its to access the crossfader. Carefully pull the crossfader up from its seated position.
4. After removing the crossfader, disconnect the ribbon cable that attaches the crossfader to the PC board. Grasp the crossfader by its base and pull the ribbon cable by its connector not the actual cables. The connector is designed to only fit one way, so don't worry about the connectors orientation.
5. Connect the new crossfader to the ribbon cable and replace in reverse order.

## WARRANTY

**WARRANTY INFORMATION:** The CK 800MP3 carries a ONE year (365 days) limited warranty. This warranty covers parts and labor. Please fill out the enclosed warranty card to validate your purchase and warranty. All returned service items whether under warranty or not, must be freight pre-paid and accompany a return authorization (R.A.) number. If the unit is under warranty, you must provide a copy of your proof of purchase invoice. Please contact American Audio® customer support at (800) 322-6337 for a R.A. number. All package not displaying a R.A. number on the outside of the package will be returned to the shipper.

### **1-YEAR LIMITED WARRANTY**

A. American Audio® hereby warrants, to the original purchaser, American Audio® products to be free of manufacturing defects in material and workmanship for a period of 1 Year (365 days) from the date of purchase. This warranty shall be valid only if the product is purchased within the United States of America, including possessions and territories. It is the owner's responsibility to establish the date and place of purchase by acceptable evidence, at the time service is sought.

B. For warranty service, send the product only to the American Audio® factory. All shipping charges must be pre-paid. If the requested repairs or service (including parts replacement) are within the terms of this warranty, American Audio® will pay return shipping charges only to a designated point within the United States. If the entire instrument is sent, it must be shipped in its original package. No accessories should be shipped with the product. If any accessories are shipped with the product, American Audio® shall have no liability whatsoever for loss of or damage to any such accessories, nor for the safe return thereof.

C. This warranty is void if the serial number has been altered or removed; if the product is modified in any manner which American Audio® concludes, after inspection, affects the reliability of the product; if the product has been repaired or serviced by anyone other than the American Audio® factory unless prior written authorization was issued to purchaser by American Audio®; if the product is damaged because not properly maintained as set forth in the instruction manual.

D. This is not a service contract, and this warranty does not include maintenance, cleaning or periodic check-up. During the period specified above, American Audio® will replace defective parts at its expense, and will absorb all expenses for warranty service and repair labor by reason of defects in material or workmanship. The sole responsibility of American Audio® under this warranty shall be limited to the repair of the product, or replacement thereof, including parts, at the sole discretion of American Audio®. All products covered by this warranty were manufactured after January 1, 1990, and bear identifying marks to that effect.

E. American Audio® reserves the right to make changes in design and/or improvements upon its products without any obligation to include these changes in any products theretofore manufactured.

F. No warranty, whether expressed or implied, is given or made with respect to any accessory supplied with products described above. Except to the extent prohibited by applicable law, all implied warranties made by American Audio® in connection with this product, including warranties of merchantability or fitness, are limited in duration to the warranty period set forth above. And no warranties, whether expressed or implied, including warranties of merchantability or fitness, shall apply to this product after said period has expired. The consumer's and or Dealer's sole remedy shall be such repair or replacement as is expressly provided above; and under no circumstances shall American Audio® be liable for any loss or damage, direct or consequential, arising out of the use of, or inability to use, this product.

G. This warranty is the only written warranty applicable to American Audio® Products and supersedes all prior warranties and written descriptions of warranty terms and conditions heretofore published.

## SPECIFICATIONS

<b>GENERAL</b>	<b>Model: American Audio CK 800Mp3 - Professional DUAL CD Player/Mixer</b>
Type:	Tray loading, digital compact disc audio player.
Disc type:	Standard size compact discs only (5 in/12 cm and 3in/8cm) Applicable File Extensions for Mp3s: mp3, MP3, mP3, and Mp3
Pitch Range:	Within +/- 4%, +/- 8%, and +/- 16%
Pitch Accuracy:	+/-0.15%
Dimensions:	450mm (W) x 285mm (D) x 110mm (H)
Installation:	Place on flat surface or mount in flat case
Weight:	13.4 Lbs. / 6.1 Kgs
Power supply:	AC 115/230V, 50/60Hz AC 100V, 50/60Hz (Japan) AC 110V, 60Hz (Colombia) AC 120V, 60Hz (U.S.A. and Canada) AC 127V, 60Hz (Mexico) AC 220V, 50Hz (Chile and Argentina) AC 220V, 60Hz (Philippines and Korea) AC 230V, 50Hz (Europe, New Zealand, South Africa, and Singapore) AC 240V, 50Hz (Australia and U.K.)
Power consumption:	36W
Environmental conditions:	Operational temperature: 5 to 35°C (41 to 95°F) Operational humidity: 25 to 85% RH (no condensation) Storage temperature: -10 to 60°C (14 to 140°F)
Accessories:	Instruction Booklet AC Power Cord

### MIXER SECTION

***Input/Output Impedance & Sensitivity (Level/Impedance): (Master set to 0dBV output, Load=100K OHM, maximum gain, EQ Flat)***

#### **Input Impedance & Reference Level:**

<b>LINE:</b>	20K OHM /-14dBV (200mV)
<b>AUX:</b>	10K OHM /-20dBV (100mV)
<b>MIC:</b>	10K OHM /-54dBV (2mV)

#### **Output Impedance & Sensitivity:**

<b>REC:</b>	2.2K OHM /-10dBV (316mV) +/-2dB
<b>MASTER:</b>	520 OHM /0dBV (1V) +/-2dB
<b>MASTER XLR:</b>	600 OHM /4dBm (1.23V) +/-2dB
<b>PHONES:</b>	33 OHM /0dBV (1V) +/-2dB
<b>D. OUTPUT (load=75 ohm):</b>	-16dBfs +/-2dB, 0.5 +/-0.1V p-p

#### ***Maximum Input (1KHz, Master Output THD=10%, EQ flat, Maximum Gain)***

<b>LINE:</b>	More than +3dBV (1.4V)
<b>AUX:</b>	More than -3dBV (0.7V)
<b>MIC:</b>	More than -37dBV (14mV)

#### ***Maximum Output (THD=10%, Maximum Gain, EQ at center position)***

<b>MASTER:</b>	MORE THAN +17dBV (7V)
<b>REC:</b>	MORE THAN +7dBV (2.2V)
<b>PHONES:</b>	MORE THAN +3dBV (1.4V at Load=32 OHM)

#### ***Frequency Response (Master=0dBV output, Maximum Gain, EQ Flat)***

<b>LINE, AUX, MIC:</b>	20-20KHz +/-2dB
------------------------	-----------------

#### ***THD+N - Total Harmonic Distortion: (MASTER = 0dBV OUTPUT, w/ 20KHz LPF):***

<b>LINE/AUX:</b>	LESS THAN 0.05% 20 - 20KHz
<b>MIC:</b>	LESS THAN 0.1% @ 1KHz (A-Weighted)

#### **Cross Talk:**

## SPECIFICATIONS

<b>LINE, AUX:</b>	More than 65dB @1Khz between L and R
<b>Channel Equalizer:</b>	
<b>BASS:</b>	+12 +/-2dB at 70Hz, BELOW -29dB at 70Hz
<b>MID:</b>	+12 +/-2dB at 1KHz, BELOW -26dB at 1KHz
<b>TREBLE:</b>	+12 +/-2dB at 13KHz, -14 +/-3dB at 13KHz
<b>Fader Maximum Attenuation:</b>	
<b>Channel Fader:</b>	More than 75dB at 1KHz
<b>Crossfader:</b>	More than 70dB at 1KHz

### CD PLAYER SECTION

#### AUDIO CHARACTERISTICS (TEST DISC: TCD-782, LOAD=47Kohm, Input Gain at Center)

Output level	0dBV (1V) +/-2dB (TCD-782 TRK16, Max. Input Gain)
T.H.D. + NOISE	Less than 0.03% (TCD-782 TRK2; W/ 20KHz LPF)
Frequency response	20Hz-20KHz, +/-2dB
S/N ratio	More than 85dB (W/ 20KHz LPF, A-Weighted)
Channel separation	More than 65dB @ 1KHz (W/ 20KHz LPF, A-Weighted)
De-emphasis response	-20dB +/-2dB (TCD-782 TRK14)

#### SEARCHING TIME (TEST DISC: TCD-792)

Short access time	Less than 4sec to next track
Long access time	Less than 6sec from Track 1 ->Track 20

#### PLAYABILITY

Interruption	More than 800um (TCD-725)
Black dot	More than 600um (TCD-725)
Finger prints	More than 65um (TCD-725)
Eccentricity	More than 140um (TCD-712)
Vertical deviation	More than 500um (TCD-731R)

#### PICK-UP

System	Object lens drive system optical pick-up
Object lens drive system	2 dimensional parallel drive
Tracking detection	3 spot beam detection
Optical source	Semiconductor laser
Wave length	780nm

**NOTES:** Specifications and improvements in the design of this unit and this manual are subject to change without any prior written notice.



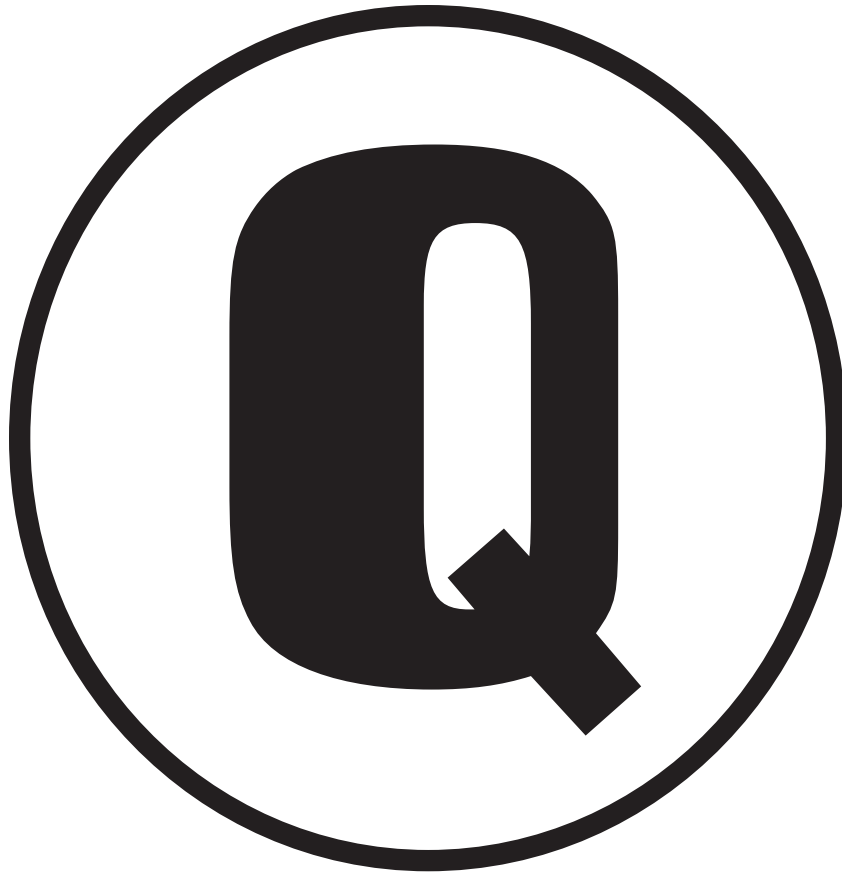

©American Audio® World Headquarters:  
4295 Charter Street Los Angeles, CA 90058 USA  
Tel: 323-582-3322 Fax: 323-582-3311  
Web: [www.AmericanAudio.us](http://www.AmericanAudio.us) E-mail: [info@americanaudio.us](mailto:info@americanaudio.us)



## Free Manuals Download Website

<http://myh66.com>

<http://usermanuals.us>

<http://www.somanuals.com>

<http://www.4manuals.cc>

<http://www.manual-lib.com>

<http://www.404manual.com>

<http://www.luxmanual.com>

<http://aubethermostatmanual.com>

Golf course search by state

<http://golfingnear.com>

Email search by domain

<http://emailbydomain.com>

Auto manuals search

<http://auto.somanuals.com>

TV manuals search

<http://tv.somanuals.com>