

American Audio[®]

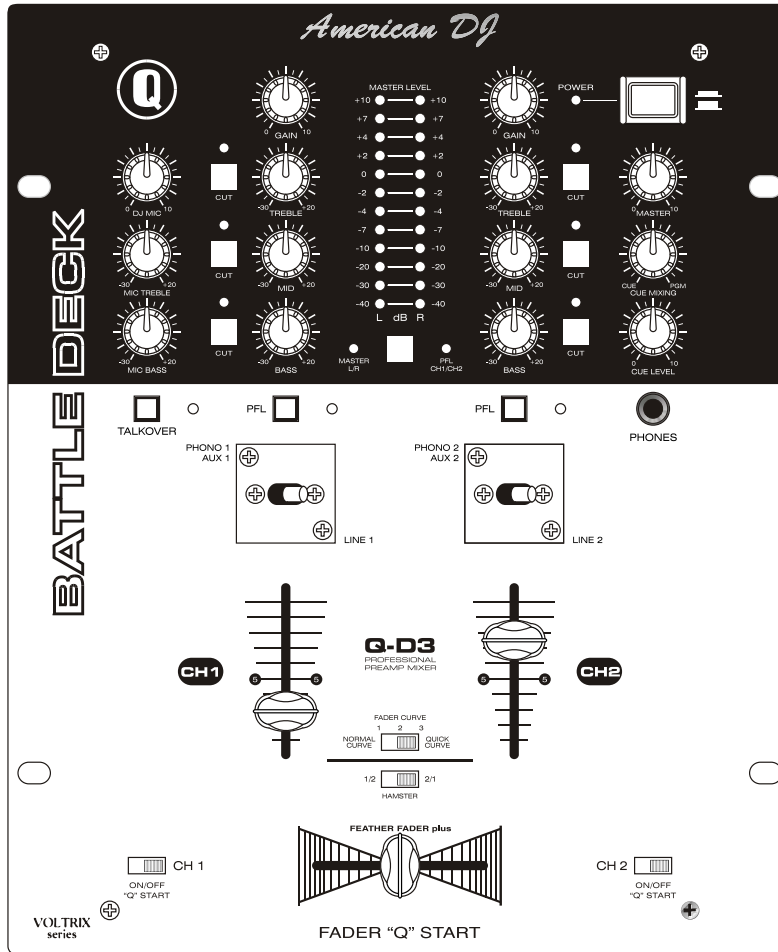

Q-D3[™] "Battle Deck" Professional Preamp Mixer

American Audio
4295 Charter Street
Los Angeles Ca. 90058
www.americandj.com

Every Q-D3™ has been thoroughly tested and has been shipped in perfect operating condition. Carefully check the shipping carton for damage that may have occurred during shipping. If the carton appears to be damaged, carefully inspect your mixer for any damage and be sure all equipment necessary to operate the mixer has arrived intact. In case damage has been found or parts are missing, please contact our toll free customer support number for further instructions, please do not return the mixer to your dealer.

Introduction:

Congratulations and thank you for purchasing the American Audio® Q-D3™ mixer. This mixer is a representation of American Audio's continuing commitment to produce the best and highest quality audio products possible at an affordable price. The Q-D3™ comes with a 2 year limited warranty! Please read and understand this manual completely before attempting to operate your new mixer. This booklet contains important information concerning the proper and safe operation of your new mixer.

Customer Support:

American Audio® provides a toll free customer support line, to provide set up help and to answer any question should you encounter problems during your initial set up or operation. You may also visit us on the web at www.americandj.com for any comments or suggestions. Service Hours are Monday through Friday 9:00 a.m. to 5:30 p.m. Pacific Standard Time.

Voice: (800) 322-6337
 Fax: (323) 582-2610
 E-mail: support@americandj.com

Caution! There are no user serviceable parts inside this mixer. Do not attempt any repairs yourself, doing so will void your manufactures warranty. In the unlikely event your mixer may require service, please contact American Audio® customer support.

Do not discard the packing carton in the trash. Please recycle when ever possible.

Please make any connections before you plug the mixer in. Be sure the Power switch is in the OFF position before connecting other devices to the mixer. All fader and volume controls should be set to 0 or minimum position, before the device is switched on. If the device has been exposed to drastic temperature fluctuation (e.g. after transportation), do not switch on the mixer immediately. The arising condensation of water might damage your device. Leave the device switched off until it has reached room temperature.

Operating Determinations:

- When installing this mixer, please make sure that the device is not exposed to extreme heat, moisture or dust!
- There should not be any cables lying around. Doing so endangers you as well as others.
- Do not operate the mixer in extremely hot (more than 30° / 100°F) or extremely cold (less than 5°C/ 40°F) surroundings.
- Keep the unit out of direct sunlight and away from heaters.
- Operate the mixer only after becoming familiar with its functions. Do not permit operation by persons not qualified for operating the mixer. Most damages are the result of unprofessional operation!

- Do not spill water or other liquids into or on to your mixer.
- For adult use only - Keep out of the reach of children.
- Be sure that the local power outlet match that of the required voltage of the unit.
- Disconnect from main power before making any type of connection.
- Do not attempt any service. There are no user serviceable parts inside.
- Never plug this mixer in to a dimmer pack
- Always be sure to mount this mixer in an area that will allow proper ventilation.
- Do not attempt to operate this mixer, if it becomes damaged in any way.
- Never operate this mixer when it's covers are removed
- To reduce the risk of electrical shock or fire, do not expose this mixer rain or moisture
- This mixer is intended for indoor use only, use of this product outdoors voids all warranties.
- During long periods of non-use, disconnect the mixer's main power.
- Always mount this mixer in safe and stable matter.
- Power Cord Protection - Power supply cords should be routed so that they are not likely to be walked on or pinched by items placed upon or against them, paying particular attention to cords at plugs, convenience receptacles, and the point where they exit from the mixer.
- Cleaning -The mixer should be cleaned only as recommended by the manufacturer.
- Heat -The mixer should be situated away from heat sources such as radiators, heat registers, stoves, or other mixers (including amplifiers) that produce heat.
- Be sure to save the packing carton in case you may ever have to return the mixer for service.
- Read all documentation before attempting to operate your new mixer. Please save all your documentation for future reference.
- Do not spill water or other liquids in to or on to your mixer.
- Do not attempt to operate this mixer if the power cord has been frayed or broken. Please route your power cord out of the way of foot traffic .
- Always have the front gain controls set to their lowest level during initial power-up to prevent speaker damage.
- The mixer should be serviced by qualified service personnel when:
 - A. Objects have fallen, or liquid has been spilled into the mixer.
 - B. The mixer has been exposed to rain or water.
 - C. The mixer does not appear to operate normally or exhibits a marked change in performance.

- VCA Fader for Q-Start Control
- Adjustable Crossfader Curve - for crabbing
- Selectable Voltage 115v~230v
- 2 Phono/2 Aux, 2 Line Inputs
- Fader "Q" Start on both channels
- Q-Start Compatible (for use with compatible American Audio CD Players)
- -30dB Rotary Kills for Treble, Bass and Mids on both channels
- Separate gain control for each channel
- High output to headphones
- Replacable/Adjustable Transformer Switches
- Soft-touch rubber knobs for better control
- Extremely clean signal to noise ratio
- Light Control Signal Output Jack
- Talk Over Button - Reduces channel output gain by 15dB +/- 2 dB
- Dual Function Stereo LED Level Indicator - Indicated Master and PFL (Pre Fader Level) Signal Levels
- Split Cue Monitoring
- Cue Mixing
- 100% Push Button Kills
- Push Button Kills

American DJ would like to thank for your purchase of this great product. For those of you that are impatient to read the entire user manual we have compiled these quick start instructions. We hope that you will at least read through these instructions to familiarize yourself with the basic understanding of the unit. The Q-D3 is part of American DJ's continuing evolution in audio technology. This unit has been built and designed with the typical DJ in mind, by DJ's. We have attempted to provide you with the most reliable product on the market by using only components made from quality products.

MASTER LEVEL - Use this level control to set your volume output. Try never to send an output of more than +4dB to your system. Signal at levels higher than this will start to distort and may cause damage to your system and speakers. Remember that a distorted signal from you mixer will only be multiplied throughout your system.

CHANNEL TRIM LEVEL - The channel trim levels are not to be used as volume controls, never use the channel trim to set the output volume. These controls are used to aid in distortion control. Use these control to preset your signal level before the crossfader. With your channel faders in the maximum position, use the channel trim level to set an average output level of about +4dB on you master level meter.

HEADPHONES - To avoid sever hearing damage, always be sure the headphone level is set to minimum before plugging them in. Never put the headphone on without making sure the headphone level is turned down.

MAIN MIC - The main mic connector uses a 1/4" jack unbalanced connector. The DJ mic has an independent volume control. When feedback occurs when using the mic, try lowering the "low" level this may reduce the feedback. Always leave the mic level to it's minimum level when not in use.

PHONO/AUX SWITCH (29) - This switch is used to change the selected input from phono level to line level and vice versa. Channels 1 and 2 may be switched PHONO/AUX or LINE. The selectors for AUX1/PHONO1 and AUX2/PHONO2 are on the rear panel (24).

Q-START FEATURE - This function works in conjunction with a compatible American DJ "Q"Start CD player. When used with a compatible CD player, you can use the crossfader to start and stop the CD Player with the slide of the fader. The ON/OFF "Q"START switch activates this FADER "Q"START feature.

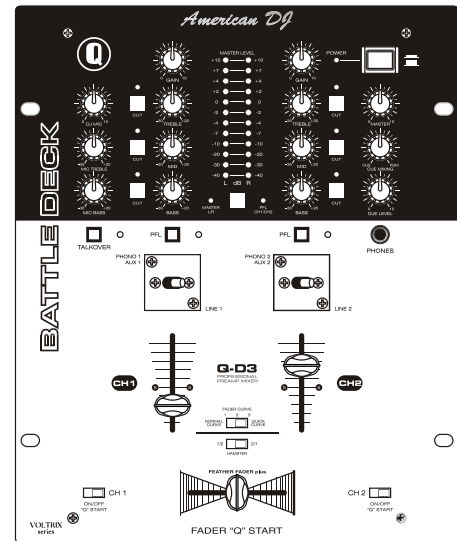

Top Panel

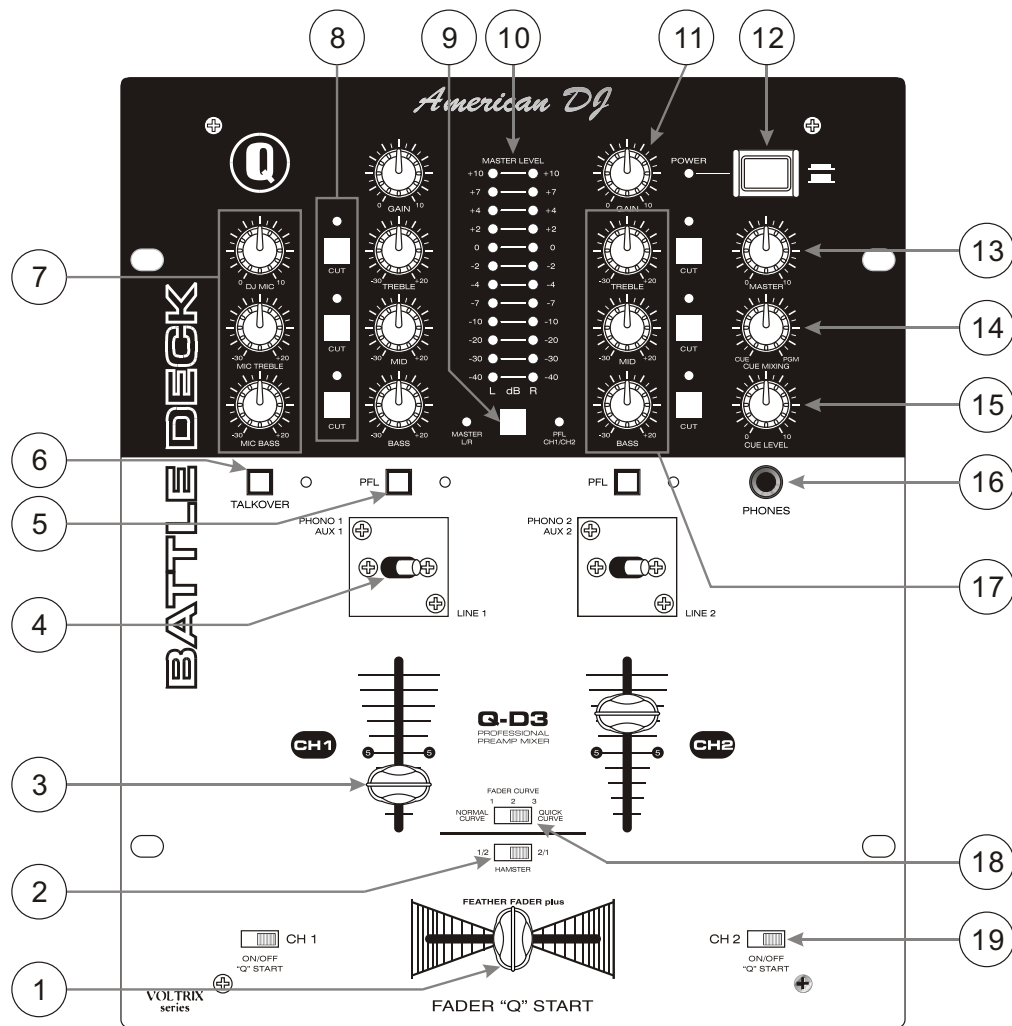

1. FEATHER FADER PLUS CROSSFADER - This fader is used to blend the output signals of channels one and two together. When the fader is in the full left position (channel 1), the output signal of channel one will be controlled by the master volume level. The same fundamentals will apply for channel two. Sliding the fader from one position to another will vary the output signals of channels one and two respectively. When the crossfader is set in the center position, the output signals of both the channels one and channels two will be even.

2. HAMSTER SWITCH - This switch changes the polarity of the Crossfader (for crabbing). Channel 1 will be activated by the right side of the crossfader (mixing from right to left), and Channel 2 will be activated by the left side of the crossfader (mixing from left to right).

3. CHANNEL FADER - These faders are used to control the output signal of any source assigned to its particular channel.

4. CHANNEL TRANSFORMER SWITCH (REPLACEABLE AND ADJUSTABLE) - These switches are used to select the input source assigned to each channel. Each channel may only be assigned one input source at a time. The *TRANSFORMER SWITCH* may be used in an up/down or left/right pattern. To adjust the transformer orientation please follow the instructions on page 12.

5. PFL BUTTONS - These buttons are used to activate a channels "CUE" mode. A red LED next to the PFL button will glow when a channels cue mode is activated. Cue mode will send a channels incoming signal to the headphones. The cue level is adjusted by the *Cue Level Adjustment Knob (15)*. Be sure the cue level is set to minimum before putting a pair of headphones on. Be sure the *Cue Mixing Knob (14)* is turned to the "CUE" position to hear the selected channel source.

6. TALKOVER BUTTON - When engaged this function will decrease all signal levels, except the microphone level, by 15dB. A red LED next to the *Talkover Button* will glow when the talkover function is engaged. In the OFF position all signals will remain at their normal levels.

7. MICROPHONE CONTROLS - These controls are used to adjust the microphone volume output level, treble level, and bass levels. Turn the knobs in a clockwise direction to increase the selected value.

8. CHANNEL CUT BUTTONS - These buttons are used to cut out the Treble, Mid or Bass frequencies of the incoming audio signal. When these buttons are depressed the selected frequency level is cut by 100%. When a Cut Button is engaged a red LED located directly above the specific button will begin to glow, indicating the cut function has been activated. Depressing the Cut Button will disengage the cut function.

9. dB METER MODE SELECTOR - This push button switch is used to change the operating mode of the dB LED meter. When the switch is in the Master L/R (up) position, the dB meter will indicate the master output levels. When the switch is in the PFL CH1/CH2 (down) position the dB meter will use the left side of the meter to indicate channel one's prefader level and use the right side of the meter to indicate channel two's prefader level.

10. LEVEL INDICATORS - The dual LED's indicators are used to indicate either the master output level or the PFL level's of channels one and two. The level indicators will directly reflect the operating mode of the *dB Selector Switch (9)*.

11. CHANNEL GAIN CONTROL - This adjustment is used to adjust an audio source signal input gain for a channel. Never use the gain control to adjust output volume. Setting the gain level properly will ensure a clean output signal. To properly set the gain level controls:

1. Be sure the *Master Volume Control (13)* is set to minimum (zero output).
2. Set the *Channel Fader (3)* to level 7.
3. Begin play on an audio source connected to the channel you are adjusting.
4. Be sure the *LED Level Indicator Function Switch (9)* is set to the PFL CH1/CH2 position.
5. Turn the *PFL (5)* function on, for the channel you are adjusting.
6. Use the *Gain Control (11)* to achieve an average output level of +4 dB.

12. MAIN POWER SWITCH - This is the main power ON/OFF button. A yellow LED above the power switch will glow to indicating power is ON. Before main power is applied, be sure you have made all connections to the mixer. Also be sure your amplifier(s) is tuned off. Remember to avoid damaging pops, mixer on first and turned off last.

13. MASTER VOLUME CONTROL - This rotary knob is used to control the master output level (volume). To avoid distorted output try to maintain an average output signal level +4 dB. Be sure this volume control is always set to zero before turning the unit on.

14. CUE MIXING CONTROLLER - This knob selects the channel for monitoring. The monitor signal comes from the Prefader. This means it will not be affected by the channel faders. You can monitor each channel individually. Connect your headphones to the HEADPHONES jack. Turn the CUE MIXING CONTROL to CUE and select the desired channels with the PFL switches. When you turn the CUE MIXING CONTROL to PGM (PFL switches without function), you can cue the output signal of the mixer. If the CUE MIXING CONTROL is set to the center position, you can cue both the channel signal you selected and the output signal. With the CUE LEVEL control, you can adjust the phones volume without changing the output signal.

15. CUE LEVEL VOLUME CONTROL - This knob is used to adjust the headphone volume output level. Turn the knob in a clockwise direction to increase the headphone volume.

16. HEADPHONE JACK - This jack is used to connect your headphones to the mixer allowing you to monitor the cue source. Use headphones only rated at 8 ohms to 32 ohms. Most DJ headphones are rated at 16 ohm, these are highly recommended. Always be sure the CUE LEVEL VOLUME (12) is set to minimum before you put the headphones on.

17. CHANNEL EQUALIZER (“ROTARY KILLS” - BASS/MID/TREBLE CONTROL) - Both of the channels include a three-band signal output EQ. These controls are used to increase or decrease the LOW's, MID's, and HI's of the output signal. The Q-D3 features “Rotary Kills” with a -30dB to +20dB gain control. Turning the knob counter-clockwise will decrease a particular frequency applied to an output signal, turning a knob clockwise will increase a particular frequency applied to an output signal.

18. FADER CURVE SWITCH - This switch is used to change the way the crossfader will operate. The crossfader can operate in three different modes, NORMAL CURVE and two types of QUICK CURVE (Quick Curve usually used for crabbing).

19. Q-START ON/OFF SWITCH - This function works in conjunction with a compatible American DJ “Q” Start CD player. When used with a compatible CD player, you can use the crossfader to start and stop the CD play. The ON/OFF “Q” START (8) switch activates the fader “Q” start feature. When the fader “Q” start feature is activated sliding the CROSSFADER (14) from left to right will play or cue any CD player connected to the controller jacks (16) on the rear of the unit.

For example, connect a compatible dual CD player connect to mixer channels one and two (refer to your CD player manual for proper set-up). Be sure the Fader “Q” Start feature is activated on both channels. Slide the crossfader to the channel one position (full left) and begin playback on CD drive one. Slide the crossfader to the channel position (far right). This will immediately trigger the play function on CD drive two and return CD drive one to cue mode. To return to normal fader operation turn the Fader “Q” Start ON/OFF SWITCH (8) to the OFF position.

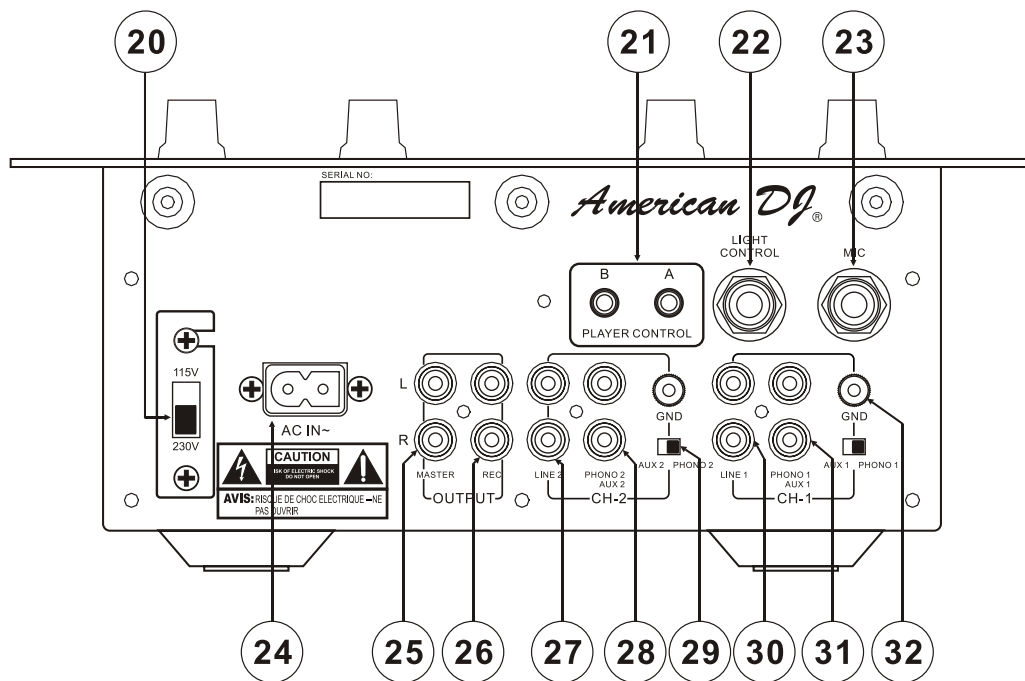

20. AC VOLTAGE SELECTOR - This switch is used to adjust the operating voltage. Operating voltage can be toggled between 115V/50Hz or 230V/60Hz. Always be sure the selector is set to the proper voltage for your area before attempting to operate the unit.

21. PLAYER CONTROL - These jacks are used to control the “Q-Start” function between the mixer and a compatible American Audio CD Player. Input mini plugs from CD player controller into these jacks, input CD 1 into jack A and CD 2 into jack B.

22. LIGHT CONTROL - This jack provides a preset mono audio signal output. There is no way to adjust this level, however this level will directly reflect the output level of the *Channel Faders* (3). This buffered audio output should only be used for light controllers that can accept an external audio input. Great for Touch Panels and Chase Controllers. Buffered audio output for light controllers that can use external input.

23. DJ MICROPHONE CONNECTOR - This jack is used to connect a microphone to the mixer. Connect your microphone via 1/4 inch (6.3mm) jack. The signal volume will be controlled by the *DJ Mic Knob* (7). The bass and treble levels can also be adjusted by the built-in microphone EQ (7).

24. AC CONNECTION - This connector is used to supply main power to the unit via the included detachable power cord. Use only the supplied, polarized AC power cord. This cord is designed to fit in one direction only. Do not attempt to force a cord in if it does not fit, be sure the cord is being inserted properly.

25. RCA MASTER OUTPUTS - The Master Output includes a pair of RCA Unbalanced Jacks. The RCA jacks send a low current unbalanced output signal.

26. REC OUT - This is a low current unbalanced output source designed for various tape and CD recorders. The Record Out (REC OUT) level is dictated by the *Channel Fader Level (3)*, it is not influenced by the *Master Volume Control (13)*.

27. CHANNEL 2: LINE 2 RCA INPUT JACKS - These Jacks are used for line level inputs. Connect CD players or Tape Decks to LINE inputs. Line level musical instruments with stereo outputs such as Rhythm Machines or Samplers should also be connected to LINE inputs. Turntables should only be connected to "Phono" inputs. The red colored RCA jack represents the right channel input and the white represents the left channel input.

28. CHANNEL 2: PHONO 2 INPUT/AUX 2 JACKS - The type of input must directly reflect the selected mode of the *Line Level Selector Switch (29)*. Connect turntables equipped with MM pickup cartridge to PHONO inputs (All DJ turntable use MM pick-up cartridges). CD players or Tape Decks and other line level instruments may be connected to these jacks as long as the *Line Level Selector Switch (29)* is in the "AUX 2" position. The red colored RCA jack represents the right channel input and the white represents the left channel input.

29. LINE LEVEL SELECTOR SWITCH - This switch is used to change the mode of PHONO INPUT JACKS (28 and 31). When connecting turntable to these jacks be sure the switch is in the PHONO position, and when using line level input devices be sure this switch is in the AUX position. Always be sure main power is shut off before change the position of the Line Level Selector Switch.

30. CHANNEL 1: LINE 1 RCA INPUT JACKS - These Jacks are used for line level inputs. Connect CD players or Tape Decks to LINE inputs. Line level musical instruments with stereo outputs such as Rhythm Machines or Samplers should also be connected to LINE inputs. Turntables should only be connected to "Phono" inputs. The red colored RCA jack represents the right channel input and the white represents the left channel input.

31. CHANNEL 1: PHONO 1 INPUT/AUX 1 JACKS - The type of input must directly reflect the selected mode of the *Line Level Selector Switch (29)*. Connect turntables equipped with MM pickup cartridge to PHONO inputs (All DJ turntable use MM pick-up cartridges). CD players or Tape Decks and other line level instruments may be connected to these jacks as long as the *Line Level Selector Switch (29)* is in the "AUX 1" position. The red colored RCA jack represents the right channel input and the white represents the left channel input.

32. GND (GROUND TERMINAL) - Connect each of your turntables ground leads to either of the two ground terminal. This will reduce the humming and popping noises associated with magnetic phono cartridges.

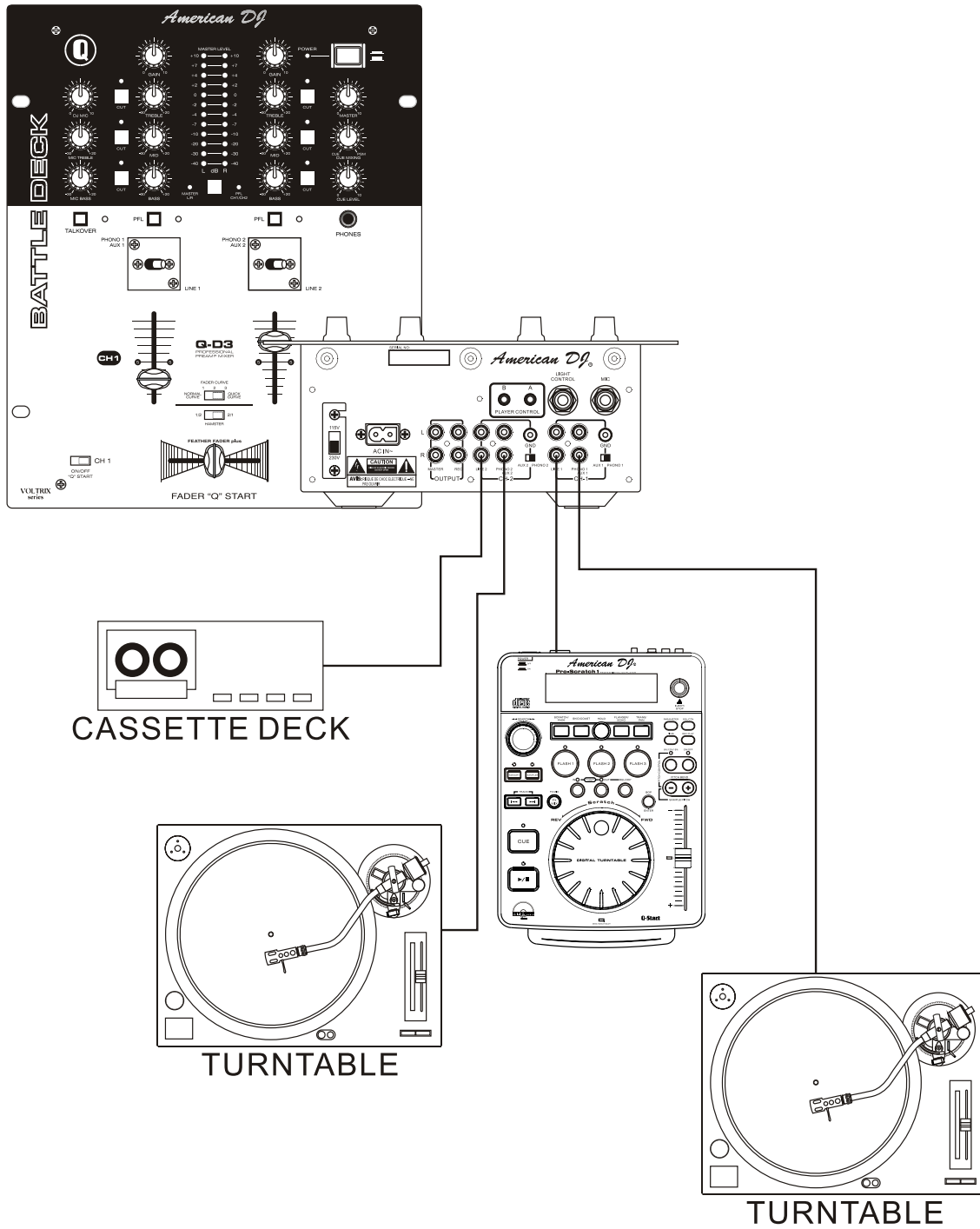

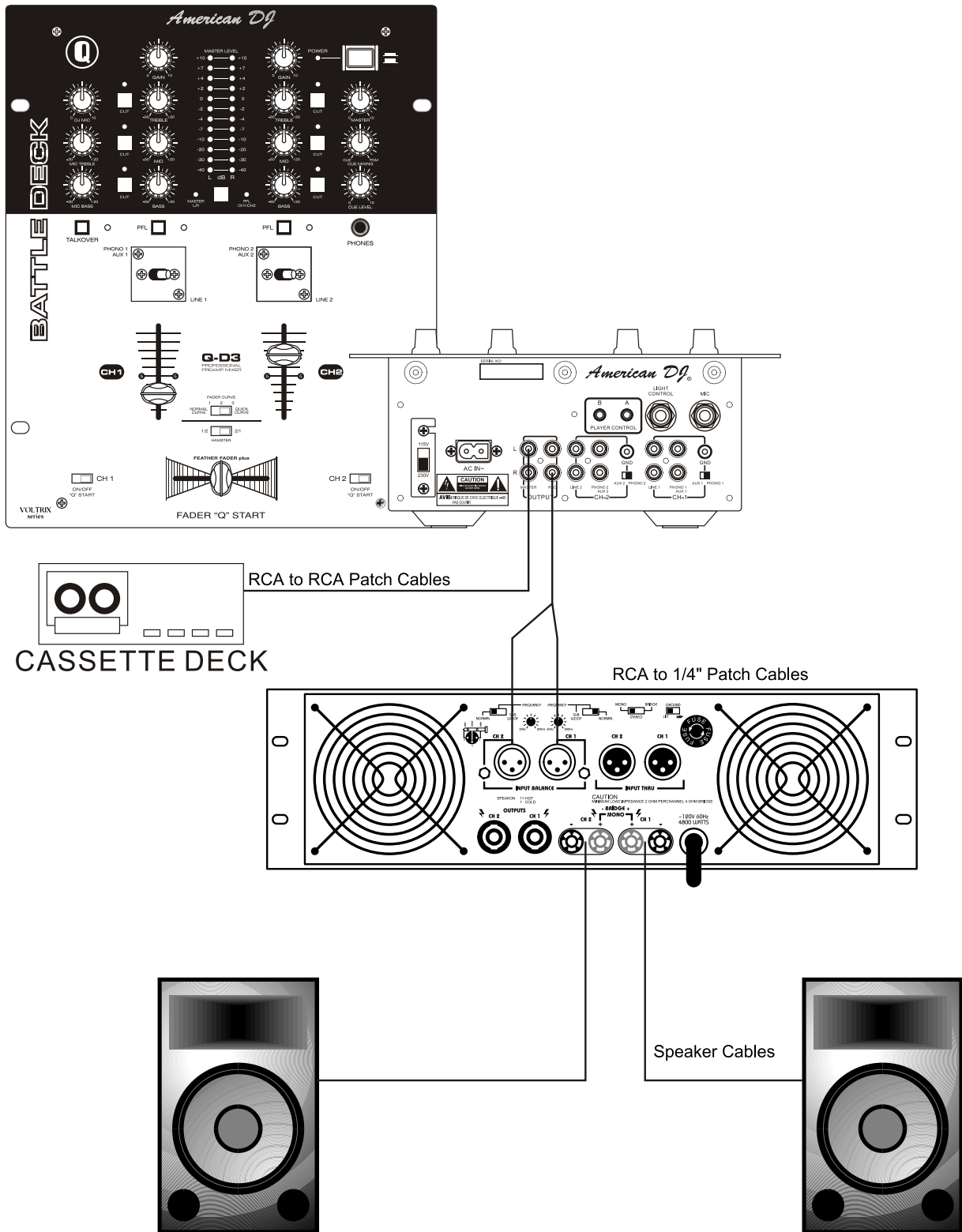

Due to fog residue, smoke, and dust, cleaning the mixer should be carried out periodically to optimize light output.

1. Use normal glass cleaner and a soft cloth to wipe down the outside casing.
2. Use a cleaner specially designed for electronics to spray in and around the knobs and switch. This will reduce small particle built up that can effect the proper operation of the mixer.
3. Clean should be carried out every 30-60 days.
4. Always be sure to dry all parts completely before plugging the mixer in.

Cleaning frequency depends on the environment in which the mixer operates (i.e. smoke, fog residue, dust, dew).

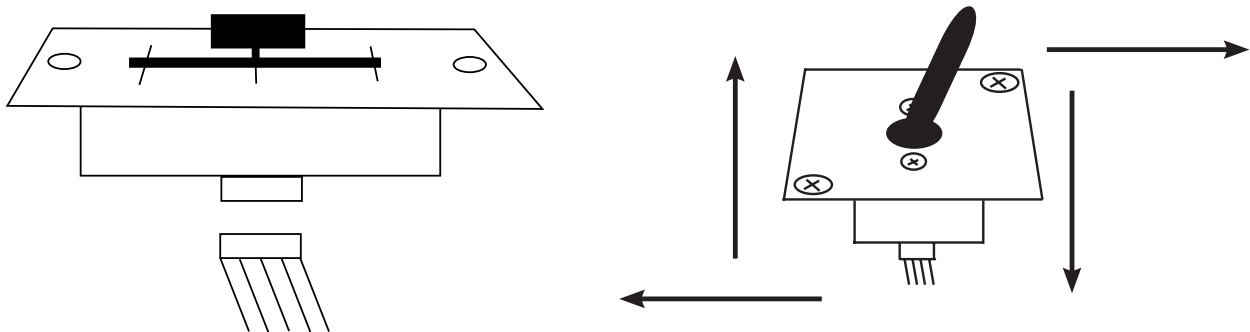

The crossfader is "Hot Swappable" which means it may be replaced at any time, even when power is applied. Only replace with American Audio Part Feather Fader Plus. Replacing with any other model fader may seriously damage your mixer.

Replacing the Crossfader:

1. Using a number two Phillips screw driver, unscrew the each of the stainless steel retaining screws that hold the crossfader in place.
2. Gently remove the crossfader from its seated position. You may need to wiggle the crossfader slightly to unseat it.
3. After removing the crossfader, disconnect the ribbon cable that attaches the crossfader to the PC board. Grasp the crossfader by its base and pull the ribbon cable by its connector not the actual cables. The connector is designed to fit one way, so don't worry about the connectors orientation.
4. Connect the new crossfader to the ribbon cable.
5. Reassemble in reverse order.

Changing/Replacing the Transformer Switch:

1. Disconnect the mixer's main power supply.
2. Using a number two Phillips screw driver, unscrew each of the larger retainer screws that hold the transformer switch in place.
3. To replace: disconnect the ribbon cable that attaches the switch to the PC board. Grasp the crossfader by its base and pull the ribbon cable by its connector not the actual cable. The connector is designed to fit one way, so don't worry about the connectors orientation.
3. To augment transformer orientation: Pull the switch out and turn to the desired position.
4. Reassemble in reverse order.

The Q-D3™ carries a two year limited warranty. We recommend you fill out the enclosed warranty card to validate your purchase. All returned service items whether under warranty or not, must be freight pre-paid and accompany a R.A.(return authorization) number. If the mixer is under warranty, you must provide a proof of purchase invoice. You may obtain a R.A. number by contacting our customer support team on out toll free number.

2-YEAR LIMITED WARRANTY

A. American Audio® hereby warrants, to the original purchaser, American Audio® products to be free of manufacturing defects in material and workmanship for a period of 2 Year (730 days) from the date of purchase. This warranty shall be valid only if the product is purchased within the United States of America, including possessions and territories. It is the owner's responsibility to establish the date and place of purchase by acceptable evidence, at the time service is sought.

B. For warranty service, send the product only to the American Audio® factory. All shipping charges must be pre-paid. If the requested repairs or service (including parts replacement) are within the terms of this warranty, American Audio® will pay return shipping charges only to a designated point within the United States. If the entire instrument is sent, it must be shipped in its original package. No accessories should be shipped with the product. If any accessories are shipped with the product, American Audio® shall have no liability whatsoever for loss of or damage to any such accessories, nor for the safe return thereof.

C. This warranty is void if the serial number has been altered or removed; if the product is modified in any manner which American Audio® concludes, after inspection, affects the reliability of the product; if the product has been repaired or serviced by anyone other than the American Audio® factory unless prior written authorization was issued to purchaser by American Audio®; if the product is damaged because not properly maintained as set forth in the instruction manual.

D. This is not a service contract, and this warranty does not include maintenance, cleaning or periodic check-up. During the period specified above, American Audio® will replace defective parts at its expense, and will absorb all expenses for warranty service and repair labor by reason of defects in material or workmanship. The sole responsibility of American Audio® under this warranty shall be limited to the repair of the product, or replacement thereof, including parts, at the sole discretion of American Audio®. All products covered by this warranty were manufactured after January 1, 1990, and bear identifying marks to that effect.

E. American Audio® reserves the right to make changes in design and/or improvements upon its products without any obligation to include these changes in any products theretofore manufactured.

F. No warranty, whether expressed or implied, is given or made with respect to any accessory supplied with products described above. Except to the extent prohibited by applicable law, all implied warranties made by American Audio® in connection with this product, including warranties of merchantability or fitness, are limited in duration to the warranty period set forth above. And no warranties, whether expressed or implied, including warranties of merchantability or fitness, shall apply to this product after said period has expired. The consumer's and or Dealer's sole remedy shall be such repair or replacement as is expressly provided above; and under no circumstances shall American Audio® be liable for any loss or damage, direct or consequential, arising out of the use of, or inability to use, this product.

G. This warranty is the only written warranty applicable to American Audio® Products and supersedes all prior warranties and written descriptions of warranty terms and conditions heretofore published.

Model: Q-D3/Battle Deck, 2 Channel Mixer

POWER SUPPLY:	AC 115/230V, 50/60Hz Selectable
DIMENSIONS:	12.5"W x 10.25"D x 4"H /254 x 308 x 102.5 mm
WEIGHT:	5.5Lbs./2.8Kgs
CROSSFADER:	Feather Fader Plus - VCA detecting fader start control - Low grounding impedance crossfader
POWER CONSUMPTION:	5W typical, 7W w/ full headphone output
HEADPHONE IMPEDANCE:	16 Ohms
ENVIRONMENTAL CONDITION:	Operating Temperature: 5 to 35 deg. C; Humidity: 25 to 85% RH (non-condensing); Storage Temperature: -20 to 60 deg. C

Input Sensitivity (Level/Impedance): LOAD=47K OHM

LINE:	14dBV (200mV)12K Ohm +/-2dB
PHONO:	-48dBV (4mV)47K Ohms +/-3dB
MICROPHONE:	-49 dBV (3.6mV) /3K Ohms +/-3 dB
AUX:	-14 dBV (200mV)/47K Ohms +/-2dB

Output Sensitivity (Level/Impedance): Note: 0dBV=1Vrms

MASTER OUT (RCA):	0dBV (1V)/610 Ohms +/-2dB
REC OUT (RCA):	-10dBV (316mV)/2.2K Ohms +/-2dB
PHONES (LOAD=32 OHMS):	-8dBV (0.4V)/33 Oms +/-2dB

Maximum Output (Load = 47K, THD = 5%)

MASTER (RCA):	MORE THAN 18dBV (8V)
REC:	MORE THAN 18dBV (8V)
PHONES (Load=32 ohms):	MORE THAN 6dBV (2V)

CHANNEL BALANCE: Within 3dB

Frequency Response:

LINE:	20Hz - 20KHz, ±1dB
PHONO:	20Hz - 20KHz, ±1.5dB (RIAA)
AUX:	20Hz - 20KHz, ±1dB
MICROPHONE:	20Hz - 20KHz, +1,-3dB

Output Noise (IEC-A WEIGHTED):

LINE/AUX:	LESS THAN -70dBV
PHONO:	LESS THAN -65dBV
MIC:	LESS THAN -55dBV

THD - Total Harmonic Distortion (1Khz, 0dBV Output):

MASTER OUTPUT (LOAD = 47K OHMS):	Less than 0.2%
PHONO: (LOAD = 32 OHMS):	Less than 0.5%

CROSS TALK: < 40dB @ 1Khz between left and right channels

Channel Equalizer:

BASS:	+12 ±1dB,-22 ±2 dB at 70KHz
MID:	+12 ±1dB,-17 ±2 dB at 1KHz
TREBLE:	+13 ±1dB,-27 ±2 dB at 13KHz

Microphone Equalizer:

BASS:	+12 ±1dB,-12 ±1 dB at 100KHz
TREBLE:	+12 ±1dB,-12 ±1 dB at 10KHz



©American Audio Supply
American Audio World Headquarters:
4295 Charter Street
Los Angeles, CA 90058 USA
Tel: 323-582-2650 Fax: 323-582-2610
Web: www.americandj.com E-mail: info@americandj.com

Free Manuals Download Website

<http://myh66.com>

<http://usermanuals.us>

<http://www.somanuals.com>

<http://www.4manuals.cc>

<http://www.manual-lib.com>

<http://www.404manual.com>

<http://www.luxmanual.com>

<http://aubethermostatmanual.com>

Golf course search by state

<http://golfingnear.com>

Email search by domain

<http://emailbydomain.com>

Auto manuals search

<http://auto.somanuals.com>

TV manuals search

<http://tv.somanuals.com>