

**ALESIS**

**DG8**<sup>TM</sup>  
DIGITAL GRAND PIANO

**REFERENCE  
MANUAL**

Spring 1999



## **Your shipping carton should contain the following items:**

1. DG8 piano
2. Sustain pedal
3. Music stand
4. AC power cable
5. Warranty Registration card
6. Reference Manual
7. QuickStart Guide

If anything is missing, please contact your dealer or Alesis immediately.

Optional accessories available from your Alesis reseller:

Alesis GS-1 Digital Piano stand w/3-pedal assembly for sustain, sostenuto and soft pedal functions

Alesis QCard™ sound-expansion card library

NOTE: Completing and returning the Warranty Registration card is important.

## **ALESIS CONTACT INFORMATION**

Alesis Corporation  
1633 26<sup>th</sup> Street  
Santa Monica, CA 90404  
USA

Telephone: 800-5-ALESIS (800-525-3747)

E-Mail: [alecorp@alesis1.usa.com](mailto:alecorp@alesis1.usa.com)

Website: <http://www.alesis.com>

DG8™ Reference Manual  
Revision 1.0  
by David M. Bertovic

© Copyright 1999, Alesis Corporation. All rights reserved. Reproduction in whole or in part is prohibited. "DG8", "QS8.1", "QSR", "NanoSynth", "DMPro", "QCard" and "SoundBridge" are trademarks of Alesis Studio Electronics, Inc.

# CONTENTS

<b>Alesis Contact Information .....</b>	<b>4</b>
<b>Important Safety Instructions .....</b>	<b>7</b>
Instructions de Sécurité Importantes (French) .....	9
Beim Benutzen dieses Produktes beachten Sie bitte die folgenden Sicherheitshinweise: (German).....	11
Instructions to the User.....	12
CE Declaration of Conformity.....	13
<b>Introduction .....</b>	<b>15</b>
Typographic Conventions.....	16
<b>Getting Started .....</b>	<b>17</b>
What You'll Need .....	17
Using the DG8 with Other Equipment .....	17
Unpack It .....	17
Set It Up .....	17
Attaching the Music Stand.....	18
Setting up the DG8 in a Home .....	19
Hook It Up .....	19
Power .....	19
Sustain Pedal.....	19
The DG8 as a Stand-alone Instrument .....	19
The DG8 in a Music System.....	20
Turn It On and Play It.....	23
How the Sounds are Organized.....	23
How the Sounds are Selected .....	25
Using the Controls.....	27
<b>Playing the DG8 .....</b>	<b>31</b>
Overview .....	31
How the Sounds are Organized.....	31
Using the Display and Sound Selection Buttons .....	33
Selecting Internal Sounds.....	35
Using the External Card Sounds.....	40
DG8 Sound Chart.....	43
Front Panel Controls .....	44
Tune.....	44
Transpose .....	44
Effects.....	45
Graphic EQ.....	45
MIDI Functions .....	46
Pedals .....	48
Background.....	48
Sustain.....	48
Sostenuto .....	49
Soft Pedal.....	49
Pedal Connections .....	49
Audio Inputs and Outputs.....	51
Initializing the DG8 .....	52
Factory Defaults .....	52
Power-Up Resetting .....	52

<b>MIDI Functions .....</b>	<b>53</b>
MIDI Basics .....	53
MIDI Hardware.....	54
MIDI Messages.....	54
Channel Messages: Voice Messages.....	54
Channel Messages: Mode Messages .....	57
MIDI and the DG8.....	58
Channel Messages .....	58
<b>Glossary.....</b>	<b>61</b>
DG8 Terms .....	61
MIDI Terms.....	62
<b>Troubleshooting.....</b>	<b>63</b>
Cleaning and Maintenance .....	65
<b>Specifications.....</b>	<b>67</b>
MIDI Implementation Chart.....	67
Specifications .....	68
<b>Warranty .....</b>	<b>69</b>
<b>Index .....</b>	<b>71</b>

# IMPORTANT SAFETY INSTRUCTIONS

## SAFETY SYMBOLS USED IN THIS PRODUCT



This symbol alerts the user that there are important operating and maintenance instructions in the literature accompanying this unit.



This symbol warns the user of uninsulated voltage within the unit that can cause dangerous electric shocks.

## PLEASE FOLLOW THESE PRECAUTIONS WHEN USING THIS PRODUCT:



1. *Read these instructions.*

2. Keep these instructions.
3. Heed all warnings.
4. Follow all instructions.
5. Do not use this apparatus near water.
6. Clean only with a damp cloth. Do not spray any liquid cleaner onto the faceplate, as this may damage the front panel controls or cause a dangerous condition.
7. Install in accordance with the manufacturer's instructions.
8. Do not install near any heat sources such as radiators, heat registers, stoves, or other apparatus (including amplifiers) that produce heat.
9. Do not defeat the safety purpose of the polarized plug on the AC power adapter. A polarized plug has two blades with one wider than the other. The wide blade is provided for your safety. When the provided plug does not fit into your outlet, consult an electrician for replacement of the obsolete outlet.
10. Protect the power cord from being walked on or pinched, particularly at plugs, convenience receptacles, and the point where they exit from the apparatus.
11. Use only attachments or accessories specified by the manufacturer.





12. Do not place this product on an unstable cart, stand, or table. The product may fall, causing serious personal injury and serious damage to the product. Use only with cart, stand, or table recommended by the manufacturer or sold with the product. The combination of the product and stand should be moved carefully. Quick movements, excessive force on uneven surfaces may overturn the combination which may damage the product and stand combination. Follow the manufacturers instructions when installing the product and use mounting accessories recommended by the manufacturer.

13. Unplug this apparatus during lightning storms or when unused for long periods of time.



14. Refer all servicing to qualified service personnel. Servicing is required when the apparatus has been damaged in any way, such as when the power-supply cord or plug is damaged, liquid has been spilled or objects have fallen into the apparatus, the apparatus has been exposed to rain or moisture, does not operate normally, or has been dropped.

15. This unit produces heat when operated normally. Operate in a well-ventilated area.

16. This product, in combination with an amplifier and headphones or speakers, may be capable of producing sound levels that could cause permanent hearing loss. Do not operate for a long period of time at a high volume level or at a level that is uncomfortable. If you experience any hearing loss or ringing in the ears, you should consult an audiologist.

## **INSTRUCTIONS DE SÉCURITÉ IMPORTANTES (FRENCH)**

### **SYMBOLES UTILISÉS DANS CE PRODUIT**



Ce symbole alerte l'utilisateur qu'il existe des instructions de fonctionnement et de maintenance dans la documentation jointe avec ce produit.



Ce symbole avertit l'utilisateur de la présence d'une tension non isolée à l'intérieur de l'appareil pouvant engendrer des chocs électriques.

### **VEUILLEZ SUIVRE CES PRÉCAUTIONS LORS DE L'UTILISATION DE L'APPAREIL:**

1. Lisez ces instructions.
2. Gardez ces instructions.
3. Tenez compte de tous les avertissements.
4. Suivez toutes les instructions.
5. N'utilisez pas cet appareil à proximité de l'eau.
6. Ne nettoyez qu'avec un chiffon humide. Ne pas vaporiser de liquide nettoyant sur l'appareil, cela pourrait abîmer les contrôles de la face avant ou engendrer des conditions dangereuses.
7. Installez selon les recommandations du constructeur.
8. Ne pas installer à proximité de sources de chaleur comme radiateurs, cuisinière ou autre appareils (don't les amplificateurs) produisant de la chaleur.
9. Ne pas enlever la prise de terre du cordon secteur. Une prise murale avec terre deux broches et une troisième reliée à la terre. Cette dernière est présente pour votre sécurité. Si le cordon secteur ne rentre pas dans la prise de courant, demandez à un électricien qualifié de remplacer la prise.
10. Evitez de marcher sur le cordon secteur ou de le pincer, en particulier au niveau de la prise, et aux endroits où il sort de l'appareil.
11. N'utilisez que des accessoires spécifiés par le constructeur.
12. N'utilisez qu'avec un stand, ou table conçus pour l'utilisation d'audio professionnel ou instruments de musique. Dans toute installation, veillez de ne rien endommager à cause de câbles qui tirent sur des appareils et leur support.
13. Débranchez l'appareil lors d'un orage ou lorsqu'il n'est pas utilisé pendant longtemps.



## **Important Safety Instructions**

---

14. Faites réparer par un personnel qualifié. Une réparation est nécessaire lorsque l'appareil a été endommagé de quelque sorte que ce soit, par exemple lorsque le cordon secteur ou la prise sont endommagés, si du liquide a coulé ou des objets se sont introduits dans l'appareil, si celui-ci a été exposé à la pluie ou à l'humidité, ne fonctionne pas normalement ou est tombé.
15. Cet appareil produit de la chaleur en fonctionnement normal.
16. Ce produit, utilisé avec un amplificateur et un casque ou des enceintes, est capable de produire des niveaux sonores pouvant engendrer une perte permanente de l'ouïe. Ne l'utilisez pas pendant longtemps à un niveau sonore élevé ou à un niveau non confortable. Si vous remarquez une perte de l'ouïe ou un bourdonnement dans les oreilles, consultez un spécialiste.

## **BEIM BENUTZEN DIESES PRODUKTES BEACHTEN SIE BITTE DIE FOLGENDEN SICHERHEITSHINWEISE: (GERMAN)**

1. Lesen Sie die Hinweise.
2. Halten Sie sich an die Anleitung.
3. Beachten Sie alle Warnungen.
4. Beachten Sie alle Hinweise.
5. Bringen Sie das Gerät nie mit Wasser in Berührung.
6. Verwenden Sie zur Reinigung nur ein weiches Tuch. Sprühen Sie keine flüssiger Reiniger auf die Oberfläche, dies könnte zur Beschädigung der Vorderseite führen und auch weitere Schäden verursachen.
7. Halten Sie sich beim Aufbau des Gerätes an die Angaben des Herstellers.
8. Stellen Sie das Gerät nicht in der Nähe von Heizkörpern, Heizungsklappen oder anderen Wärmequellen (einschließlich Verstärkern) auf.
9. Verlegen Sie das Netzkabel des Gerätes niemals so, daß man darüber stolpern kann oder daß es gequetscht wird.
10. Benutzen Sie nur das vom Hersteller empfohlene Zubehör.
11. Verwenden Sie ausschließlich Wagen, Ständer, oder Tische, die speziell für professionelle Audio- und Musikinstrumente geeignet sind. Achten Sie immer darauf, daß die jeweiligen Geräte sicher installiert sind, um Schäden und Verletzungen zu vermeiden. Wenn Sie einen Rollwagen benutzen, achten Sie darauf, das dieser nicht umkippt, um Verletzungen auszuschließen.
12. Ziehen Sie während eines Gewitters oder wenn Sie das Gerät über einen längeren Zeitraum nicht benutzen den Netzstecker aus der Steckdose.
13. Die Wartung sollte nur durch qualifiziertes Fachpersonal erfolgen. Die Wartung wird notwendig, wenn das Gerät beschädigt wurde oder aber das Stromkabel oder der Stecker, Gegenstände oder Flüssigkeit in das Gerät gelangt sind, das Gerät dem Regen oder Feuchtigkeit ausgesetzt war und deshalb nicht mehr normal arbeitet oder heruntergefallen ist.
14. Bei normalem Betrieb des Gerätes kommt es zu Wärmeentwicklungen.
15. Dieses Produkt kann in Verbindung mit einem Verstärker und Kopfhörern oder Lautsprechern Lautstärkepegel erzeugen, die anhaltende Gehörschäden verursachen. Betreiben Sie es nicht über längere Zeit mit hoher Lautstärke oder einem Pegel, der Ihnen unangenehm is. Wenn Sie ein Nachlassen des Gehörs oder ein Klingeln in den Ohren feststellen, sollten Sie einen Ohrenarzt aufsuchen.

## **INSTRUCTIONS TO THE USER**

This equipment has been tested and found to comply with the limits for a class B digital device, pursuant to Part 15 of the FCC Rules. These limits are designed to provide reasonable protection against harmful interference in a residential installation. This equipment generates, uses, and can radiate radio frequency energy and, if not installed and used in accordance with the instructions, may cause harmful interference to radio communications. However, there is no guarantee that interference will not occur in a particular installation. If this equipment does cause harmful interference to radio or television reception, which can be determined by turning the equipment off and on, the user is encouraged to try and correct the interference by one or more of the following measures:

- Reorient or relocate the receiving antenna.
- Increase the separation between the equipment and receiver.
- Connect the equipment into an outlet on a circuit different from that to which the receiver is connected.
- Consult the dealer or an experienced radio/TV technician for help.

This equipment has been verified to comply with the limits for a class B computing device, pursuant to FCC Rules. In order to maintain compliance with FCC regulations, shielded cables must be used with this equipment. Operation with non-approved equipment or unshielded cables is likely to result in interference to radio and TV reception. The user is cautioned that changes and modifications made to the equipment without the approval of manufacturer could void the user's authority to operate this equipment.

## **CE DECLARATION OF CONFORMITY**

**Manufacturer's Name:** Alesis Corporation

**Manufacturer's Address:** 1633 26<sup>th</sup> Street  
Santa Monica, CA 90404  
USA

*declares, that the product:*

**Product Name:** DG8  
**Model Type:** Digital Grand Piano

*conforms to the following Standards:*

**EMC:** EN55103: 1997 Class B

**Safety:** EN 60065

**European Contact:** Sound Technology  
17 Letchworth Point, Letchworth,  
Hertfordshire, SG6 1ND, England.  
Phone: +44.1462.480000  
Fax: +44.1462.480800

**June, 1999**



---

# INTRODUCTION

---

In the years since electronic musical instruments made their debut in the early 1970s, the quest for a transportable piano that had the sound and feel of a true acoustic instrument seemed to elude every manufacturer. They tried everything, including a rather ingenious re-design of the grand piano that you could take apart into two pieces when travelling. The trade-off? It was still bulky, rather expensive, and because it had strings (just like a real piano) it needed to be tuned periodically. If you moved it often, you had to tune it often.

Even as digital sampling technology began to mature in the early 1990s and piano products started popping up all over, something always seemed to be missing: the sound was thin or the keys didn't feel right or the pedals didn't respond like you'd expect or... well, you get the point.

But no matter how big my music rig gets – no matter how many gadgets and boxes and toys I accumulate – the one sound that I have always insisted upon is a great piano. The Alesis DG8 is a great piano. And more.

The DG8 sounds like a piano and feels like a piano. Its 88-key, fully-weighted, hammer-action keyboard is an advanced design that provides the response you'd expect from, well, a real piano. Complementing its piano realism are four pedal inputs: sustain/sostenuto and soft pedal expression plus an AUX jack for volume/modulation. Factor in the DG8's 64-voice polyphony, and you have an instrument that faithfully reproduces all the nuances of a fine acoustic piano.

But we wouldn't be satisfied with just a standard piano. We've tailored our selection of pianos to be ideally suited for classical, jazz, rock and pop, and included an entire suite of electric pianos, pipe and electric organs, synthesizers, strings, choirs, basses, clavinet, vibes and harpsichord. In addition to its 88 preset programs, the DG8's 24MB of sound ROM is expandable to 32MB via a PCMCIA expansion card slot, ideally suited for any Alesis *QCard*<sup>™</sup> expansion module.

The DG8's velocity-sensitive keyboard can be layered and split, of course. The split point can be set to any point on the keyboard you want, and the Transpose feature puts the DG8 into any key.

And to further enhance the DG8's sound capability, the Alesis *QS Parallel Matrix Effects*<sup>™</sup> provide reverb and chorus on nearly all internal Keyboard Programs (the electric organ programs substitute a rotary speaker effect for chorus). Add to that a 5-band analog graphic equalizer and a built-in 100-watt-per-channel, discrete stereo bi-amped amplifier and speakers, and the DG8 is a fully-integrated powerhouse instrument.

We've just touched on the some of the highlights of this product; there's much more to be explored. After you've read through this brief document, and experienced the sound and feel of the DG8, I'm confident that you will be every bit as excited about it as I am.

Dave Bertovic  
Spring 1999

### TYPOGRAPHIC CONVENTIONS

In this manual, we attempt to make the reading as easy as possible by using fonts and symbols that are easy to identify. The following list describes the conventions we use in the manual for special or important information.

Slider, button and back panel labels are in **SMALL BOLD CAPITALS**.

Words or phrases that appear in the display are printed using type that resembles the display characters.

A new or important term is in *italics* followed by its definition or contextual meaning.

*Paragraphs in italics provide additional information on a topic that might be helpful in understanding certain important concepts.*

**Tip:** A hint or special example called a *Tip* is set off from the main text by a box with a light-gray fill.

Important instructions or emphasis on a word or phrase are **printed in boldface type**.



When something extremely important appears in the manual, an icon like the one on the left will appear in the left margin. This indicates that this information is *vital* when operating the DG8.

---

# GETTING STARTED

---

## WHAT YOU'LL NEED

The DG8 is a completely self-contained instrument that needs nothing more than a standard AC electrical outlet and a stand to put it on. Before placing the DG8 on a stand, see the topic **Set It Up** at the bottom of this page for specifics.

## USING THE DG8 WITH OTHER EQUIPMENT

If you plan to use the DG8 with other equipment, such as other MIDI devices, a sound system or in recording environment, you'll need:

1. Standard MIDI cables that connect your DG8 to other MIDI devices in your system. See the topic **Hook It Up** on page 19 for more information.
2. A standard AC outlet where you can plug the unit in.
3. A basic working knowledge of MIDI. If you're new to all of this, read our brief MIDI tutorial in Chapter 3.
4. Audio cables to connect your DG8 to a sound system.

## UNPACK IT

The DG8 is packaged in a cardboard container with molded styrofoam inserts. After you remove your DG8, its AC power cord, the Warranty card and this manual, we suggest you keep all packing materials in a safe place. You'll need the box and styrofoam in case the unit needs to be transported or shipped.

## SET IT UP

You can place the DG8 just about anywhere that's convenient. For tips on setting up the DG8 in your home, see the topic on page 19.

Before placing the DG8 on a stand, be certain that is capable of securely holding an object that weighs 80 lbs. (36.3kg). Also take in to consideration how aggressive a player you are: the harder you pound the keys, the stronger a stand you'll need. If the stand collapses under the DG8's weight (or your playing), the unit could suffer permanent damage, and you could be injured. Don't take chances; take the time right now to make sure that your stand is adequate.

You might also want to consider the optional Alesis GS-1 Digital Piano stand. This attractive accessory is ideal for the home or studio where the DG8 has a permanent place of residence.



## **ATTACHING THE MUSIC STAND**

The DG8 is shipped with a music stand that attaches easily to the top of the instrument:

1. Remove the music stand from its plastic wrapping and extend the braces away from the front of the stand approximately 5 - 6 inches. The braces swing out from the front of the stand on a pair of hinges.

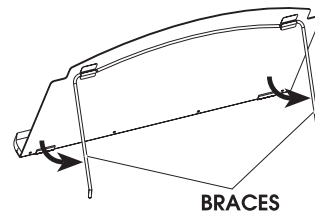

2. Insert the ends of the braces into the two mounting holes located along the rear edge of the DG8's top.

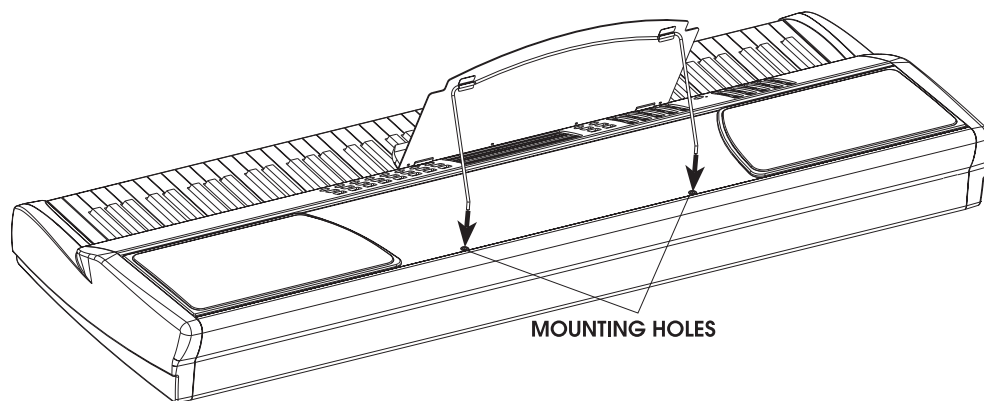

3. You can adjust the angle of the stand once it is in place. Grip the front of the stand at the bottom corners and **gently** pull towards you or push away from you to adjust the angle.

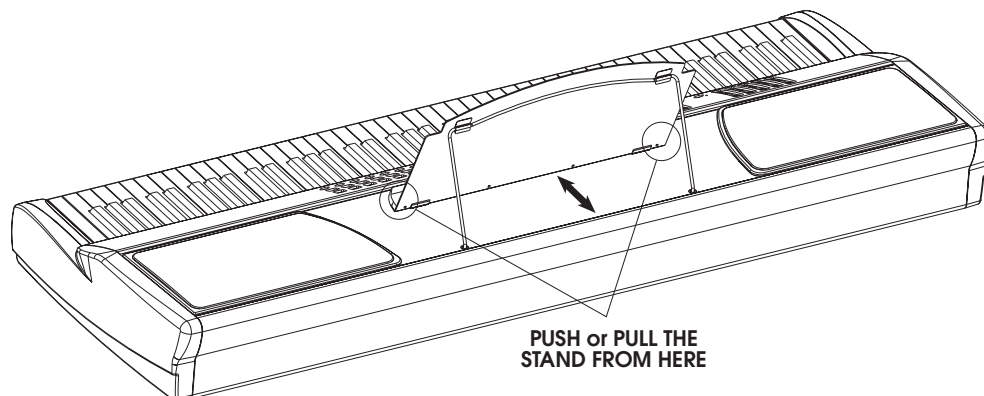

## **SETTING UP THE DG8 IN A HOME**

Placement of your DG8 in the room can have a great effect on its overall tonal balance. Placing the DG8 is like placing loudspeakers in a room – placing the unit right up against a wall will accentuate the bass and if the wall has thick draperies, they will also cut the treble producing a dark, boomy sound.

The most accurate sound is usually achieved when the DG8 is placed on an appropriate stand and positioned out and away from highly reflective or highly absorptive wall surfaces. But when the DG8 **must** be situated close to a wall, as in a home, here are some recommendations:

- If the wall is hard and smooth (a “reflective” surface), try positioning the keyboard at least 6” away. Too close and the tweeter frequencies will bounce back at you and cause a blurred and “splashy” high frequency effect. Also in this position, the wall may give a “boomy” character to the lower octaves. This is called *bass coupling* where bass sounds get a boost from the nearby wall.
- If the nearby wall is curtained or otherwise presents a highly absorptive environment, the DG8 should be positioned out at least 12”. As mentioned earlier, thick draperies will cut treble and the result will be a dark, muffled sound.

## **HOOK IT UP**

### **POWER**

Use the AC power cord (or equivalent) that is included with the DG8. Make sure that the unit is turned off before you plug the power cord into the rear panel receptacle and the wall outlet. The unit has a universal power supply that should work with local AC power in most countries. If in doubt, check with your power company before plugging it in. In the U.S., the DG8 must be plugged into a standard 117 VAC, 50 - 60 Hz outlet.

### **SUSTAIN PEDAL**

Before powering on the DG8, plug the included sustain pedal into the **SUSTAIN/SOST** jack on the back panel.

### **THE DG8 AS A STAND-ALONE INSTRUMENT**

After you’ve set up the DG8 and plugged it into an AC outlet, you can go right ahead and dig in. If you plan to play the DG8 by itself, skip ahead to the topic **Turn It On and Play It** on page 23.

If you plan to use the DG8 with other MIDI instruments and devices in a music system, use the examples on the next few pages to connect it to your rig.

## **THE DG8 IN A MUSIC SYSTEM**

If you plan to use the DG8 with other MIDI instruments and devices in a music system, you'll need to integrate it into your system. Here's a list of items you're likely to need:

1. standard MIDI cables: refer to the following examples for possible connection schemes.
2. a basic working knowledge of MIDI. If you're new to all of this, read our brief MIDI tutorial in Chapter 3.
3. two 2-conductor (unbalanced) audio cables if you plan to route the DG8's audio to your sound system or audio mixer.

**As a Master:**

If you intend to use the DG8 as the master controller in your MIDI rig, plug a standard MIDI cable into the DG8's **MIDI OUT** port. The other end of this cable should plug into the **MIDI IN** of the first slave in the system. If there are several MIDI instruments in your setup, connect **MIDI THRU** from the first slave to the **MIDI IN** of the second device and so forth to create a "chain".

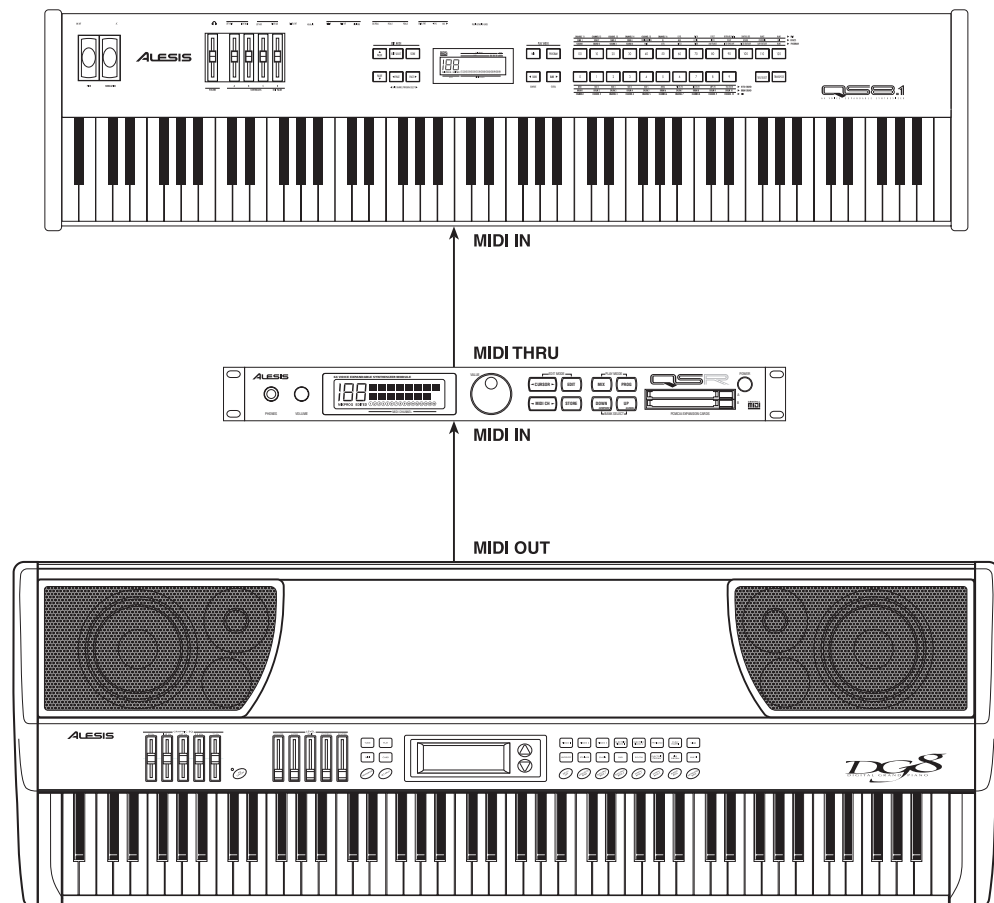

**As a Slave:**

If you plan to control the DG8 from another MIDI device, you'll need a MIDI cable connected to its **MIDI IN** port.

You will also need a MIDI cable connected to the DG8's **MIDI THRU** if you plan to pass MIDI data from the master through the DG8 to other MIDI devices in your rig. Connect one end of a MIDI cable to the DG8's **MIDI THRU**. Plug the other end of the cable to the **MIDI IN** of the next device in the system.

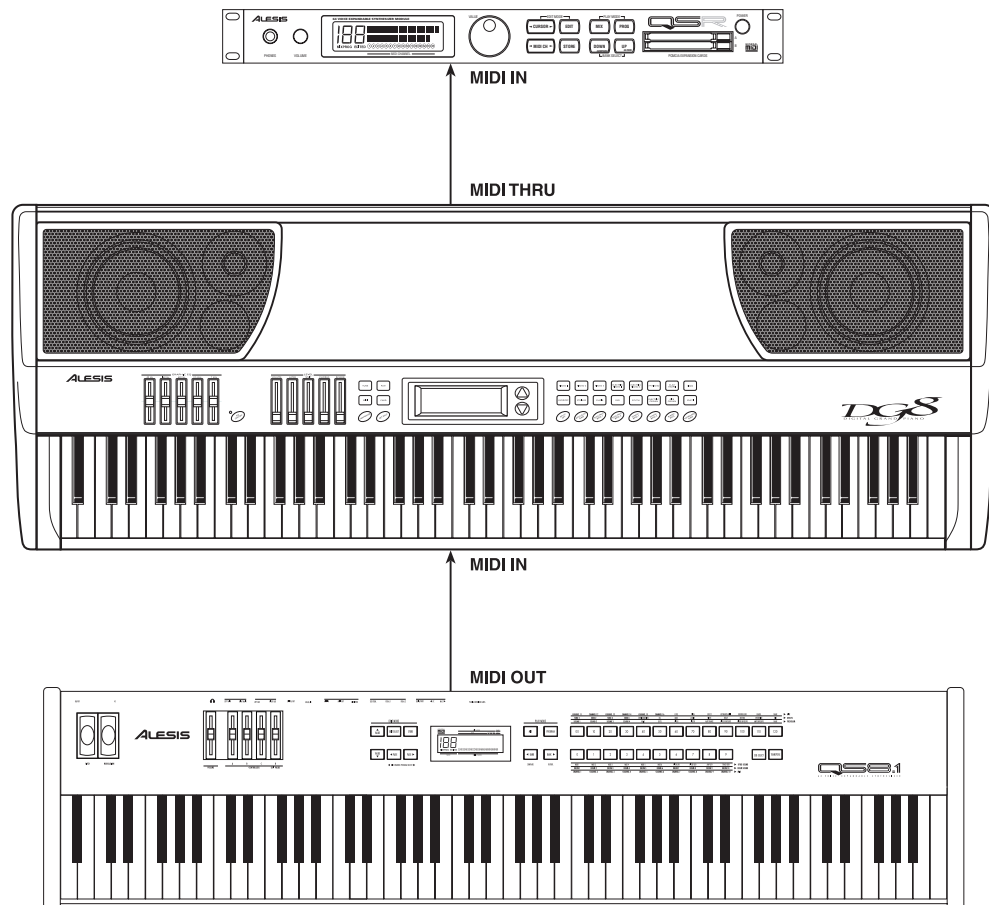

### With a MIDI Patchbay:

If you're using a MIDI patchbay or "patcher" to connect all of your MIDI devices centrally, it's likely that the patcher's back panel will have a series of paired **MIDI OUT** and **MIDI IN** ports for each device in your rig (the DG8 being one of them).

Connect the DG8's **MIDI OUT** to the **MIDI IN** of one of the pairs. The same pair's **MIDI OUT** connects to the **MIDI IN** of the DG8. Consult the patcher's Owner's Manual to find out how it routes MIDI data among the devices connected to it.

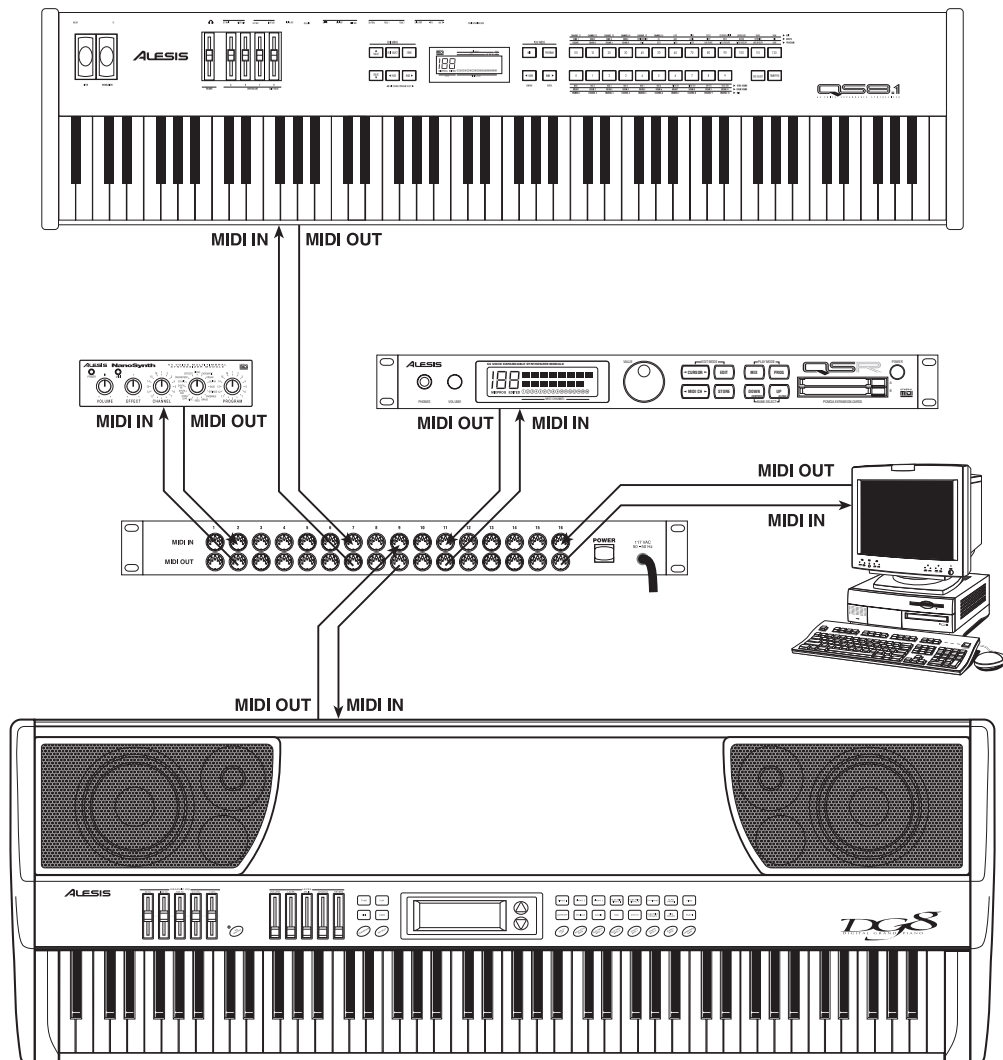

## TURN IT ON AND PLAY IT

Flip the power switch on the DG8's rear panel. The front panel display will illuminate and, if this is the first time you've used the DG8, it will recall Keyboard Program Pro1A: True Grand and display it under the **PRIMARY SOUND** heading.

### 1. AutoDemos

Press and hold the **PLAY** button, then press the **TUNE** button to enter Demo mode. The display will prompt you to select one of three demonstration songs to play by pressing the **PIANO 1**, **PIANO 2** or **PIANO 3** Bank buttons. You can listen to any demo in its entirety, or press the **PLAY** button to end a demo that is playing.

## HOW THE SOUNDS ARE ORGANIZED

### 2. Keyboard Banks

The Keyboard Banks contain the main polyphonic sound programs in the DG8's internal memory.

Each of the 15 Keyboard Banks contains **four** Keyboard Programs. Thus, each Bank represents a *sound category* – a group of related sounds – and the name of the category is printed on each button.

The Keyboard Bank buttons are used in conjunction with the **▲** and **▼** arrows to access the Keyboard Programs in each Bank:

- Press a Keyboard Bank button to select a Keyboard category. The name of a Keyboard Program from the selected Bank will appear in the **PRIMARY SOUND** segment of the display.
- Use the **▲** arrow on the right side of the display to scroll forward through the four Keyboard Programs in the Bank. If you continue to scroll forward with the **▲** arrow, when the last Program in the bank is reached, the display will “wrap” to the first Program.
- Use the **▼** arrow to scroll backward through the four Keyboard Programs in each Bank. If you continue to scroll backward with the **▼** arrow, when the first Program in the Bank is reached, the display will wrap to the last Program.

Keyboard Programs can be played by themselves, layered together (or layered with a Card Program) or split with a Bass or Card Program. See topics 4, 5 and 6 on the next few pages for information on these Play modes.

### 3. Bass Banks

Similar to the Keyboard Banks, the Bass Banks contain the main **bass** sound programs in the DG8's internal memory. And, like the Keyboard Banks, each of the seven Bass Banks contains **four** Bass Programs. Each Bank represents a category of related bass sounds and the name of the category is printed on each button.

Note that the DG8's internal Bass Programs are programmed without modulation – they will not respond to the modulation setting for the AUX pedal, nor modulation commands received over MIDI. Also, there is a minimal amount of Reverb and Chorus effects programmed into the Bass Programs.

The Bass Bank buttons are used in conjunction with the ▲ and ▼ arrows to access the Bass Programs in each Bank:

- Press a Bass Bank button to select a Bass category. **Bass Programs are always played as the Split sounds** on the lower range of the keyboard, and the selected Bass Program's label will appear in the **SPLIT** segment of the display.
- Use the ▲ arrow on the right side of the display to scroll forward through the four Bass Programs in the Bank. If you continue to scroll forward with the ▲ arrow, when the last Program in the bank is reached, the display will "wrap" to the first Program.
- Use the ▼ arrow to scroll backward through the four Bass Programs in each Bank. If you continue to scroll backward with the ▼ arrow, when the first Program in the Bank is reached, the display will wrap to the last Program.

#### 4. The Card Bank

You can take advantage of the DG8's expandability by acquiring an Alesis QCard or other compatible PCMCIA Type I sound card. This card provides an additional library of new sounds you can play on the DG8 and is inserted into the **EXPANSION CARD** slot on the DG8's back panel.

- Once selected, these external sounds act just like the internal DG8 programs, except that there are 128 of them on a QCard. Press the **CARD** button: the last card sound that was selected will load and its name will appear in the display.

*Tip:* Card sounds can be used in Layers and Splits. They can be combined with the DG8's internal sounds or can be layered and split among the other programs in the Card Bank. See topics 6 and 7 in the following pages.

- Use the ▲ arrow on the right side of the display to scroll forward through the Card Programs. If you continue to forward scroll with the ▲ arrow, when the last Program in the bank is reached, the display will "wrap" to the first Program.
- Use the ▼ arrow to scroll backward through the card programs. If you continue to scroll backward with the ▼ arrow, when the first Program in the Bank is reached, the display will wrap to the last Program.

*Tip:* If you press and **hold** either arrow button, the display will accelerate its scrolling through the available programs. Also, pressing **both** arrows **together** resets the Card Program to 000.



**Do not physically remove the card from the rear slot while any Card Program is active. This holds true for Primary, Layer or Split sounds. If a Card Program is the Primary Sound, simply switch the Card Program to an internal Keyboard Program. If a Card Program is the Layer or Split Sound, simply turn off the Layer or Split.**

Also note that the effects programmed into QCard sounds may act unpredictably when used with the DG8.

## HOW THE SOUNDS ARE SELECTED

### 5. Single Mode

The DG8 is in Single mode when a Keyboard or Card Program is played alone – the DG8 is not in a Layer or Split. The Program's name and label appears in the top line of the display under the **PRIMARY SOUND** heading. The Keyboard or Card Program that is displayed here will be appropriately called the Primary sound or simply "the Primary" throughout the manual.



**The important concept to understand here is that a Primary sound is always active, whether it is an internal Keyboard Program or a Card Program.**

With this principle in mind, you can think of a Layer as "adding another Keyboard or Card Program to be played on top of the current Primary". Likewise, a Split is created when "a Bass or Card Program is played on the lower range of keys with the Primary on the upper range". The Layer and Split play modes are described in the following two topics:

### 6. Layers

A Layer is simply two Keyboard or Card Programs (or one of each) stacked one on top of the other. Selecting a Layer causes the keys to play the two Programs simultaneously. There are two methods you can use to create a Layer:

- Press and hold the **LAYER/OFF** button then press a Keyboard Bank button or the **CARD** button. The current Program in the **PRIMARY** display will be layered with a **second** Keyboard Program (or a Card Program) that appears in the **LAYER** segment of the display.

OR

- Press a Keyboard Bank button to select the Primary sound. **While you are still pressing the Keyboard Bank button**, press another Keyboard Bank or the **CARD** button to select the Layer sound.
- In either case, use the **▲** and **▼** arrows, if necessary, to select the desired Keyboard Program or Card Program of the **LAYER** sound.

*Variations:*

- You can layer two Programs from the same Keyboard Bank. After selecting the desired Primary program, press and hold the **LAYER/OFF** button and press the same Keyboard Bank button. Use the **▲** and **▼** arrows to select the desired Keyboard Program in that Bank. Please note that this method is the only way you can layer two Keyboard Programs from the **same** Bank.
- If a Card Program is the Primary, pressing and holding **LAYER/OFF** then pressing **CARD** causes **two** Card Programs to be layered. Please note that this method – using the **LAYER/OFF** button to create the Layer – is the only way you can layer two Card Programs.
- Use the **LAYER LEVEL** slider to adjust the volume of the **LAYER** sound **relative** to the **PRIMARY**.
- To exit this mode, press the **LAYER/OFF** button.



### 7. Splits

A Split is simply a Bass or Card Program played on the lower range of keys with a Primary sound played from the upper range. (Remember that the Primary can be selected from the Keyboard Banks or the Card Bank.)

- To set up a Split, press any Bass Bank button. To select a Card Program as the split sound, press and hold **SPLIT/OFF** then press **CARD**. Use the ▲ and ▼ arrows to select the desired Split sound from within the selected Bass Bank or the Card Bank.
- In either case, the Bass Program or Card Program will be recalled from memory as the sound on the lower (left-hand) range of keys and its label will appear in the **SPLIT** segment of the display.
- The default split-point is key “C2”, the C that is one octave below Middle C. To change the split point, press the **SET SPLIT** button. The display will prompt you to press a key on the DG8’s keyboard. This key will be the highest note of the lower range.

Note that if you don’t press a key within two seconds, the display will revert back to the program display, leaving the current split point unchanged.

- To change the lower sound, use the ▲ and ▼ arrows to select another program in the current Bass Bank or Card Bank, or press another Bass Bank button.
- To change the upper sound, press another Keyboard Bank button; to switch the upper sound to the Card Bank, press **CARD**. Use the ▲ and ▼ arrows to select the desired Program in the Keyboard/Card Banks.
- To exit this mode, press the **SPLIT/OFF** button.

### 8. Split-with-Layer

**When the DG8 is playing a Split:** press and hold the **LAYER/OFF** button and press another Keyboard Bank button or the Card Button to add a **LAYER** sound to the upper range of the keyboard.

**If the DG8 is playing a Layer:** press any Bass Bank button to split the layered keyboard with an internal Bass Program on the lower range of the keyboard. To split a layered keyboard with a Card Program, press and hold **SPLIT/OFF** and press **CARD**.

*Tip:* For Primaries, Layers and Splits, the DG8’s memory **independently** keeps track of the most recently selected programs for each Bank button. This principle is true for the Keyboard, Bass and Card Banks.

9. Using the Cursor and the ▲ and ▼ Arrows

When interacting with the display, the sound that is underlined by the cursor is the one that will be affected by the ▲ and ▼ arrows. You can always keep track of where the cursor is because during normal operation, the last sound that you select has the cursor. But if necessary, you can move the cursor to another active segment of the display by pressing the **PLAY** button.

Repeated pressing of the **PLAY** button moves the cursor among the active fields in the display. Just keep in mind that you can't move the cursor to a blank field. For example, in a Layer, the cursor will only move between the **PRIMARY** and the **LAYER** sounds. In a Split, the cursor will only move between the **PRIMARY** and the **SPLIT** sounds. In a Split-with-Layer, the cursor will move among all three **PRIMARY**, **SPLIT** and **LAYER** sounds.

*Tip:* You can perform a quick reset when certain parameters are being displayed. Pressing the ▲ and ▼ arrows together will reset the following parameters:

<b>SET SPLIT</b>	split point resets to C2
<b>TRANPOSE</b>	transpose value resets to Middle C
<b>TUNE</b>	Master Tune resets to 00
<b>MIDI Page 4: Keyboard Scaling</b>	resets to 50

When the display is in its normal mode of displaying selected Sound Programs, pressing the ▲ and ▼ arrows together will reset Keyboard Bank and Bass Bank programs to "A". Card Bank programs reset to 000.

## USING THE CONTROLS

10. Level Controls

Raise or lower the **VOLUME** slider to adjust the output level to a comfortable listening volume. The **VOLUME** slider adjusts the overall level for everything: Primary sounds, Layers, Splits and Effects. But you can also use the **LEVEL** sliders to make further adjustments to the sound balance:

- Adjusting the **LAYER** slider changes the output of the Layer sound relative to the Primary sound. The output level of the Primary Sound stays constant when playing a Layer.
- Adjusting the **SPLIT** slider changes the output of the Bass Program or the Card Program assigned to the lower keyboard range relative to the Primary. The output level of the Primary Sound stays constant when playing a Split.
- Reverb and Chorus have been pre-programmed in nearly all of the sounds. You can raise or lower the amount of effects with the **REVERB** and **CHORUS** sliders.

The exception to this is the **ELECTRIC ORGAN** Bank which substitutes a rotating speaker effect instead of chorus. The **CHORUS LEVEL** slider acts as a speed control for the rotating speaker.

- Remember also that the DG8's built-in speakers can be turned off by using the **SPEAKER ON/OFF** switch on the back panel.

### 11. Transpose

You can transpose the DG8  $\pm 1$  octave. Using Middle C (key "C3") as your reference, press and hold the **TRANSPOSE** button and press a key on the keyboard. Pressing a key above Middle C will transpose the DG8 **up** by the interval and pressing a key below Middle C will transpose the DG8 **down** by that interval.

The selected key will be the new key for the DG8 in any Play mode (Primary, Layer, Split or Split-with-Layer) until the transpose amount is changed or the instrument is initialized.

Also, if you attempt a transpose value more than the one octave limit, the DG8 will keep the pitch the same but the key selected will be the nearest one within the one octave range. For example, if you try to transpose up to key E5 (the highest E on the keyboard), the DG8 will transpose the keyboard up to E3, the E above C3 (Middle C). Also, transposing the keyboard will not affect the Split Point's physical location on the keyboard.

The Transpose display will exit as soon as you press a key on the DG8's keyboard. To exit this mode without transposing, press **PLAY**.

### 12. TUNE Button

*Page 1: Master Tune*

The DG8 can be tuned to other instruments, a tuning device or your CD player, cassette player, etc. Press the **TUNE** button and use the **▲** button to raise the pitch of the DG8 and the **▼** button to lower it. The range is  $\pm 1$  half step, and each press of an arrow key changes the tuning by 1 cent (100 cents = 1 half step) up or down.

Pressing both **▲** and **▼** arrows together resets Master Tune to  $\text{♩}$ .

To exit this mode, press the **PLAY** button.

*Page 2: Stretch Tuning*

Pressing the **TUNE** button a second time enters Stretch Tuning mode which employs the tuning method that is actually used to tune real acoustic pianos. With Stretch Tuning, the low strings are tuned increasingly flat, and the high strings are tuned increasingly sharp compared to the equally-tempered scale.

This function defaults to **ON**, and is only active on the three piano groups **PIANO 1**, **PIANO 2** and **PIANO 3**. This feature of the DG8 was not just designed as an esoteric function, but provides an **unusual level of realism** to the piano Programs.

While this mode is desirable when playing a piano program alone, it can cause problems when used with Layers or other MIDI instruments. To partially avert this, the DG8 **automatically** turns off this function when you enter Layer mode so as to avoid tuning conflicts with other internal DG8 Programs. However, when playing the DG8 with other instruments via MIDI, you may need to defeat Stretch Tuning because the high and low ends of the DG8 may sound out of tune with other MIDI instruments. Use the **▼** arrow to turn this function **OFF**. When Stretch Tuning is off, the piano programs will always be tuned to the equally-tempered scale whether used as a Primary Program or as a Layer.

Note that, like other settings in the DG8, if turning Stretch Tuning is set to **OFF** it will remain off until you change it or re-initialize the instrument.

To exit this mode, press the **PLAY** button.

13. **Graphic EQ**

The 5-band analog graphic equalizer on the left side of the control panel allows you to make tonal adjustments to the sound. Press the **EQ ON/OFF** button (its LED will light) to activate the equalizer and raise or lower the frequency sliders to adjust the tone. Every time you power on the DG8, the EQ will be off.

The equalizer affects the final output of the DG8 for all Primary, Layer and Split setups for both internal and Card Programs. The equalizer also affects Reverb and Chorus, the inputs and all outputs: the rear panel audio outs plus the two headphone jacks.

14. **MIDI Channel Function**

The **MIDI** button accesses the six MIDI functions of the DG8. For this section of manual, we will cover only the Channel function. For a complete description of the other MIDI Functions, turn to page 46.

Pressing the **MIDI** button will step between six different pages of MIDI and other utility functions. Press the **MIDI** button until the display reads:

```

BASIC
MIDI Channel = X
    
```

... where X is one of the 16 MIDI Channels or Off. When set to Off, the DG8 will neither transmit nor receive MIDI information.

Use the ▲ and ▼ arrows to select the new Basic MIDI Channel, or Off. To confirm your selection and exit this mode, press **PLAY**.

**How the Basic MIDI Channel Works on the DG8**

When you first power on the DG8, the Basic Channel defaults to Channel 1.

So that the DG8 will communicate effectively with other MIDI devices, the DG8 treats Primary Sounds, Layers and Splits differently:

- The MIDI Channel displayed is the Basic Channel for all messages affecting **Primary Sounds**. In addition, the Basic MIDI Channel affects all messages for the **Layer sound, except Program Change commands**.
- The MIDI Channel assignment for just the Layer Program Changes **follows sequentially**: Layer Program Changes = Basic Channel + 1.
- The MIDI Channel assignment for all messages for Splits **again follows sequentially**: Splits = Basic Channel + 2.

Here's a summary of these functions using the MIDI Channel default as an example:

MIDI Channel 1	Primary Sounds Layer Programs	all supported Channel Messages all supported Channel Messages <b>except</b> Program Change commands
MIDI Channel 2	Program Change commands (only) for the Layer sound	
MIDI Channel 3	Split Programs	all supported Channel Messages Program Change commands only affect the Bass Program.



CHAPTER 2

# PLAYING THE DG8

---

## OVERVIEW

The DG8 contains a total of 88 sound programs in its internal memory. 60 of these are called Keyboard Programs and represent a selection of pianos and other keyboard instruments such as harpsichord, electric piano, clavinet, pipe and electric organs. In addition, popular electronic keyboard sounds such as traditional synthesizer and “pad” sounds, strings (orchestral or ensemble type), choir and vibes are included. For Splits – where the DG8 plays a sound on the lower range and another sound on the upper range of the keyboard – a selection of 28 popular Bass Programs are included for left hand accompaniment on the lower keyboard range.

Each of the DG8’s sound programs is a *digital sample* – an electronic recording of an audible sound – that is stored in the instrument’s memory. The DG8’s memory is a type of memory used in a wide variety of electronic instruments and computers called ROM (“Read-Only Memory”) which cannot be erased or altered.

Sound programs in the DG8 may be constructed of only one instrument or, as in the case of **PAD**, **SYNTH** or **MULTI** sounds (to name a few), a *composite* sound.

*A composite sound is a sound that was constructed from one or more synthesizers and/or samplers. When playing one of these DG8 sounds, you may hear what appears to be several sounds mixed together. In this case, that’s exactly what we did. The resulting program in the DG8 is a rich and full sound, but only takes up a single location in memory.*

## HOW THE SOUNDS ARE ORGANIZED

The DG8 divides its sound memory into two categories, internal and external sounds. Internal sounds are accessed from the Keyboard Banks and the Bass Banks. External sounds are called Card Bank programs and are accessed from a sound card inserted in the back panel’s **EXPANSION CARD** slot.

### Keyboard Banks

The DG8 has 60 Keyboard Programs in its internal memory. These 60 sounds are arranged into 15 **Banks** that correspond to the 15 rectangular buttons on the right side of the control panel.

**Each Bank contains four variations of the sound that is printed on the button label.** For example, **FM PIANO** contains four well-known FM-type electronic piano sounds; **PIPE ORGAN** contains four variations of pipe organ ensembles usually associated with church or cathedral organs.

The Keyboard Bank buttons are used in conjunction with the ▲ and ▼ arrows to access the Keyboard Programs in each Bank:

- Press a Keyboard Bank button to select a Keyboard category. The name and label of a Keyboard Program from the selected Bank will appear in the **PRIMARY SOUND** segment of the display.
- Use the ▲ arrow on the right side of the display to scroll forward through the four Keyboard Programs in the Bank. If you continue to scroll forward with the ▲ arrow, when the last Program in the bank is reached, the display will “wrap” to the first Program.
- Use the ▼ arrow to scroll backward through the four Keyboard Programs in each Bank. If you continue to scroll backward with the ▼ arrow, when the first Program in the Bank is reached, the display will wrap to the last Program.

A Keyboard Program can be played by itself as single program, layered with another Keyboard Program or Card Program, or split with a Bass (or Card) Program. See the topics on Layers and Splits starting on page 36 for information on these Play Modes.

### Bass Banks

Similar to the Keyboard Banks, the Bass Banks contain the main **bass** sound programs in the DG8’s internal memory. And, like the Keyboard Banks, each of the seven Bass Banks contains **four** Bass Programs. Each Bank represents a category of related bass sounds and the name of the category is printed on each button.

Note that the DG8’s internal Bass Programs are programmed without modulation – they will not respond to a mod pedal plugged into its back panel or to received MIDI modulation commands. Also, there is a minimal amount of Reverb and Chorus effects programmed into the Bass Programs.

The Bass Bank buttons are used in conjunction with the ▲ and ▼ arrows to access the Bass Programs in each Bank:

Press a Bass Bank button to select a Bass category. **Bass Programs are always played as the Split sounds on the lower range of keys**, and the selected Bass Program’s label will appear in the **SPLIT** segment of the display.

Use the ▲ and ▼ arrows to step forward or backward through the four Bass Programs in the Bank.

### The Card Bank

You can take advantage of the DG8’s expandability by acquiring an Alesis QCard or other compatible PCMCIA Type I sound card. The QCard provides an additional library of 128 new sounds you can play on the DG8. Just be aware that the effects programmed into each card sound may act unpredictably.

The card’s sounds act just like the internal DG8 programs. You can use Card Programs for Primaries, Layers and Splits by pressing the **CARD** button instead of a Bank button when selecting a sound. The last card sound that was selected will load and its name and/or label will appear in the appropriate segment of the display. Use the ▲ and ▼ arrows to step forward or backward through the Card Programs in the Card Bank to select another program.

Card sounds can be combined with the DG8’s internal sounds or can be layered and/or split within the Card Bank. A complete tutorial on using Card Programs is provided in the section **Using the External Card Sounds** starting on page 40.

## USING THE DISPLAY AND SOUND SELECTION BUTTONS

In Play mode, the display shows the name(s) of the selected sound(s) – all three if a Split-with-Layer is selected. The **most recently selected sound is underlined by the cursor**. In our first example, a Split-with-Layer is shown:

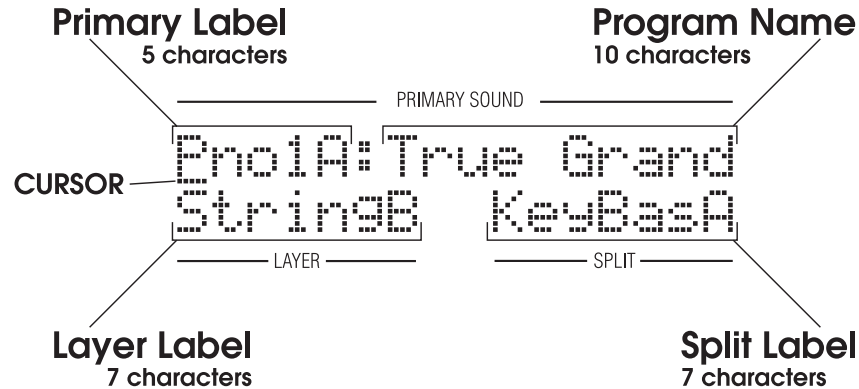

In this next example, an **internal** Primary Sound is layered with an optional **external** Card Program. Notice that the Split display segment is blank indicating that Split keyboard mode is not active:

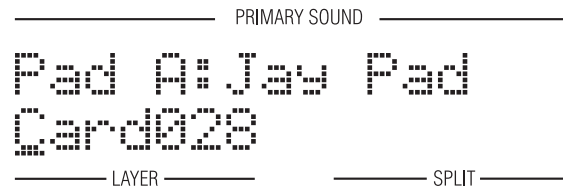

### How Sound Programs are Named

Primary Sounds are displayed with a 10-character name and a 5-character *label* – a combination of the name of the Bank Button plus A, B, C or D representing the four sound variations in each Keyboard Bank. Card Programs substitute a 3-digit number for the A, B, C or D because each Alesis QCard has 128 sound programs.

Layer and Split sound programs use only labels in the display. For the complete list of DG8 sound labels, see the **DG8 Sound Chart** on page 43.

### Using the Cursor and the ▲ and ▼ Arrows

When interacting with the display, one of the key concepts is to keep track of where the cursor is located. Notice in the first diagram above that the cursor is an underline of the first character in the Program Label. **The sound that is underlined by the cursor is the one that will be affected by the ▲ and ▼ arrows**. Keeping track of the cursor will not be an issue when playing Primary Sounds only, or if you're in the process of setting up a Layer or Split. But it will be a real time-saver when you're selecting **new** sounds for an **existing** Layer, Split or Split-with-Layer.

To move the cursor when a Layer, Split or Split-with-Layer is active, press the **PLAY** button. Repeated presses of the **PLAY** button move the cursor around the display. When the cursor is at the **LAYER** sound, for example, pressing the ▲ and ▼ arrows will



select another Program within the current Keyboard or Card Bank for the Layer sound. When the cursor is at the **SPLIT** sound, pressing the ▲ and ▼ arrows will select another Program within the current Bass Bank or Card Bank for the Split sound.

A complete tutorial on using the ▲ and ▼ arrows and cursor to select sound programs and setting up Layers and Splits is provided in the section **Selecting Internal Sounds** on the next page.

### Other ▲ and ▼ Arrow Functions

The ▲ and ▼ arrows are also used to select parameters and change numeric values in the **TUNE** and **MIDI** modes.

### Acceleration

Note that when selecting Programs and changing numeric values in the display, pressing and holding an arrow will accelerate the scrolling. This is most noticeable (and most handy) when selecting Card Sounds. Because there are 128 sounds on an Alesis QCard, this feature is another time-saver.

### Display Wrap

Also, when selecting Programs (internal or card), pressing an arrow repeatedly (or holding it down) will *wrap* the display: pressing or holding the ▲ button when selecting any internal sound will display all four sounds in that Bank in succession. When the fourth sound is reached, continued pressing of the ▲ button will wrap the display to the first sound in the Bank and continue on. By the same token, scrolling backward with the ▼ arrow wraps the display back to the fourth sound after the first sound is reached.

Wrapping is also especially handy with Card Sounds as it solves the problem of scrolling through 128 programs just to get to the first (or last) sound on the card. Wrapping also occurs when selecting MIDI Channels.

### Reset

The last feature of the arrows is the Reset function. When selecting numeric values for Master Tune or Keyboard Scaling, for example, pressing **both** arrows simultaneously resets the function to its default value, which is usually 0 or a value that represents a mid-point in the function's range. When displayed, pressing the ▲ and ▼ arrows together will reset the following parameters:

<b>SET SPLIT</b>	split point resets to C2
<b>TRANPOSE</b>	transpose value resets to Middle C
<b>TUNE</b>	Master Tune resets to 00
<b>MIDI Page 4: Keyboard Scaling</b>	resets to 50

When the display is in its normal mode of displaying selected Programs, pressing the ▲ and ▼ arrows together will reset Keyboard Bank or Bass Bank programs to "F". Card Bank programs reset to 000. When resetting a displayed Program, move the cursor to the sound you want to reset with the **PLAY** button.

## SELECTING INTERNAL SOUNDS

The DG8's internal sounds can be selected and arranged in any of four *Play Modes* or keyboard setups: Single, Layer, Split and Split-with-Layer.

To make things a little more interesting – and flexible – these modes can also be used with an external set of sounds provided on an optional PCMCIA Type I-compatible ROM card such as an Alesis QCard. This Card Bank contains additional sounds that can be played as Primary sounds but can also be played in a Layer, Split or Split-with-Layer. Things **really** get interesting when you combine internal programs with the external sounds on the QCard.

**But for now, we will limit our discussion of selecting sounds and creating Layers and Splits to the DG8's internal Programs, for simplicity. A section dealing with incorporating external Card Programs will be provided starting on page 40.**

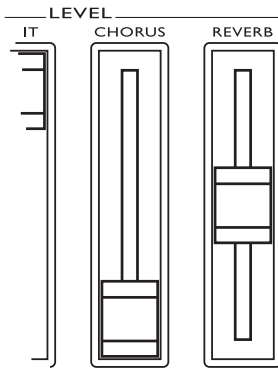

*Tip:* Before proceeding with auditioning sounds in the DG8, raise the **REVERB** slider to its middle position. Each internal Sound Program contains an appropriate reverb setting and using the mid-point for the slider is a good place to start. You can always raise or lower a slider at any time to get the reverb level you like, or pull the slider all the way down to turn it completely off.

Also, we'd like to suggest that you keep the **CHORUS** slider at its off position – all the way down – for now. Most of the internal Sound Programs also contain an amount of chorus, but when listening to the DG8's sounds for the first time, Chorus should be off. This will give you the most practical demo of the DG8's sounds. You can always raise the slider at any time to get the chorus level you like.

### Single Mode

The DG8 is in Single mode when a Keyboard or Card Program is played alone – the DG8 is not in a Layer or Split. The Program's name and label appear in the top line of the display under the **PRIMARY SOUND** heading. The Keyboard or Card Program that is displayed here will be appropriately called the Primary Sound or simply "the Primary" throughout the manual.



**The important concept to understand here is that a Primary Sound is always active, even when the DG8 is playing a Layer or a Split.**

**In addition, the Primary Sound is always a Keyboard or a Card Program, and internal Keyboard Programs can never be the Split sound.**

Press any one of the Keyboard Bank buttons to select a Keyboard Bank. The last Keyboard Program that was selected from this Bank will be recalled from memory and displayed under the **PRIMARY SOUND** heading.

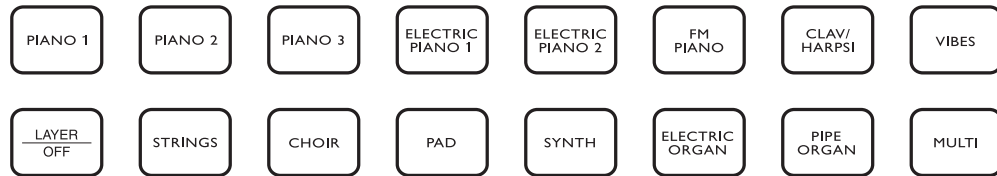

Press the ▲ arrow to scroll through the other three Keyboard Programs in the Bank. Use the ▼ arrow to scroll backward through the Programs.

You can think of a Layer as “adding another Keyboard Program to be played simultaneously with the current Primary”. The Keyboard Program that creates the Layer appears in the **LAYER** segment of the display.

Likewise, a Split is created when “a Bass or Card Program is played with a Primary”. The Bass Program appears in the display as the **SPLIT** sound and is played from the lower range of keys. (The Layer and Split play modes are described in the following two topics.)

**For Primaries, Layers and Splits, the DG8’s memory independently keeps track of the most recently selected programs for each Bank button. This principle is true for the Keyboard, Bass and Card Banks.**

### Layer Mode

Layer mode takes two Keyboard Programs and puts “one on top of the other” so that notes played on the keyboard – or received MIDI notes – play both sounds at once. Both sounds are layered across the entire keyboard. A Layer can be comprised of two Keyboard Programs from different Keyboard Banks, the same Bank, or even the same Keyboard Program layered with itself.

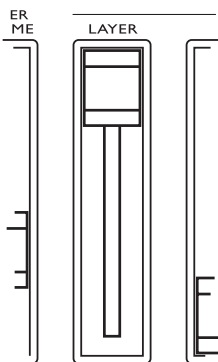

*Tip:* Before proceeding, raise the **LAYER** slider all the way to the top. At this position, the output level of the Layer sound is approximately equal to the Primary Sound. You can then lower the level of the Layer sound relative to the Primary Sound if necessary.

Bear in mind that if the **LAYER** slider is all the way off (at the bottom), the Layer sound will not be heard when a Layer is created.

There are two methods you can use to create a Layer:

- Press and hold the **LAYER/OFF** button then press a Keyboard Bank button. A Keyboard Program from this Bank will appear in the **LAYER** display, layered with the current Program in the **PRIMARY** display. Use the **▲** and **▼** arrows, if necessary, to select the desired Keyboard Program from the Bank.

**OR**

- Press a Keyboard Bank button to select the Primary Sound. **While you are still pressing the Keyboard Bank button**, press another Keyboard Bank to select the Layer sound.
- You can layer two Programs from the same Keyboard Bank. After selecting the desired Primary program, press and hold the **LAYER/OFF** button and press the same Keyboard Bank button. Use the **▲** and **▼** arrows to select the desired Keyboard Program in that Bank. Please note that this method is the only way you can layer two Keyboard Programs from the **same** Bank.
- Once a Layer has been set up, you can change the Primary or the Layer sounds:
  - To change the Primary sound **to another Program in the same Bank**, press the **PLAY** button to move the cursor to the **PRIMARY SOUND** display. Then use the **▲** or **▼** arrows to select another Program in the Bank.
  - If you want to change the Primary sound **to another Bank**, simply press another Keyboard Bank button (in this case it doesn't matter where the cursor is; pressing a Keyboard Bank button automatically changes the Primary).
  - To change the Layer sound **to another Program in the same Bank**, press the **PLAY** button to move the cursor to the **LAYER** display, then use the **▲** or **▼** arrows to select another Program in the Bank.
  - If you want to change the Layer sound **to another Bank**, press and hold **LAYER/OFF**. While **LAYER/OFF** is still being pressed, press another Keyboard Bank button, then use the **▲** or **▼** arrows (if necessary) to select another Program in the Bank.

To exit this mode, press the **LAYER/OFF** button. The DG8 will remove the Layer sound and keep the Primary Sound. The cursor will move to the Primary Sound display.

### Split Mode

A Split is simply a Bass Program played with a Primary Sound: the Bass Program will be played from the lower range of keys and the Primary Sound will play from the upper range.

As with Primary Sounds, each Bass Bank button represents a group of four related Bass Programs that are selected with the ▲ and ▼ arrows:

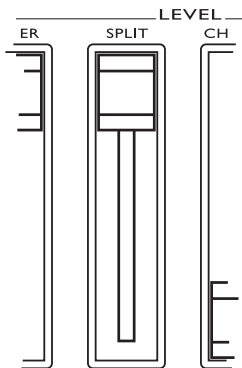

**Tip:** Before proceeding, raise the **SPLIT** slider all the way to the top. At this position, the output level of the Bass Program – the **SPLIT** sound – is approximately equal to the Primary Sound. You can then use the slider to lower the level of the Split sound relative to the Primary Sound (which remains constant) if necessary.

Bear in mind that if the **SPLIT** slider is all the way off (at the bottom), the Bass Program will not be heard when a Split is selected.

- To create a Split, just press any of the Bass Bank buttons. The last Bass Program that was used in that Bank will be recalled and its label will appear in the **SPLIT** segment of the display. Use the ▲ and ▼ arrows, if necessary, to select the desired Bass Program in the Bank. The current Primary Sound will be used as the sound in the upper range of keys.
- After you set up a Split, you can change the sounds in the Split:
  - To change the Split sound **to another Program in the same Bank**, press the **PLAY** button to move the cursor to the **SPLIT** display, then use the ▲ or ▼ arrows to select another Bass Program in the Bank.
  - If you want to change the Split sound **to another Bank**, just press another Bass Bank button. Use the ▲ or ▼ arrows (if necessary) to select another Program in the Bank.
  - To change the Primary sound **to another Program in the same Bank**, press the **PLAY** button to move the cursor to the **PRIMARY SOUND** display. Then use the ▲ or ▼ arrows to select another Program in the Bank.
  - If you want to change the Primary sound **to another Bank**, simply press another Keyboard Bank button (in this case it doesn't matter where the cursor is; pressing a Keyboard Bank button automatically changes the Primary).

- The default split-point is key “C2”, the C that is one octave below Middle C:

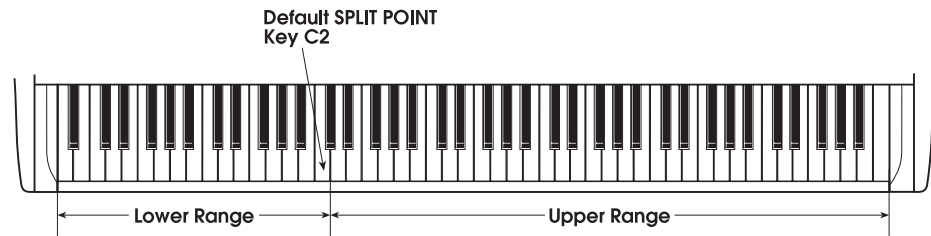

- To change the split point press the **SET SPLIT** button, then press any key on the DG8’s keyboard. This key will be the highest note of the bass range. This will also be the Split Point for all Splits until it is changed. And remember: you have two seconds to set your new split point when you press the **SET SPLIT** button. After two seconds, the display reverts back to the program display, leaving the current split point unchanged.

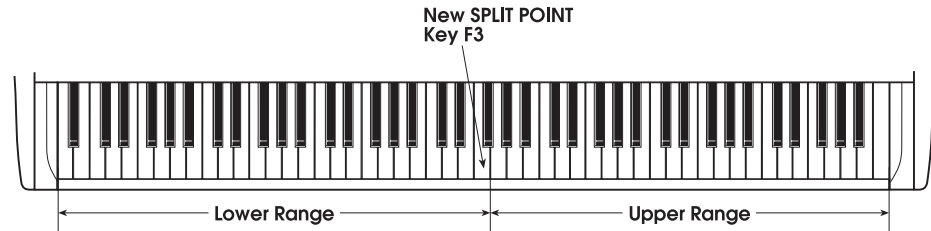

*Tip:* You can also use the ▲ or ▼ arrows to set the split point. To reset the split point back to C2, press the ▲ and ▼ arrows **together** while this display is being shown.

- To exit Split mode, press the **SPLIT/OFF** button. The DG8 will keep the Primary Sound used in the Split, and the cursor will move to the Primary Sound name.

### Split-with-Layer

When a Split is being played, you can set up a Layer to be played from the upper key range instead of just a single Primary sound.

- Set up a Split following the procedure for Splits on the previous page.
- Press and hold the **LAYER/OFF** button and press any of the Keyboard Bank buttons. Use the ▲ and ▼ arrows to select the desired Keyboard Program in the Bank to be the Layer for the upper key range (this procedure is the same as selecting a Layer for the whole keyboard).
- To exit the Split (and keep the Layer), press **SPLIT/OFF**.  
To exit the Layer (and keep the Split), press **LAYER/OFF**.  
To exit both Layer **and** Split modes to return the DG8 to Single mode, press **LAYER/OFF** and **SPLIT/OFF**.

*Tip:* Note that **you don’t have to create a Split first** to play a Layer. If the DG8 is already playing a Layer, just press a Bass Bank and you’re there. (We could have easily called this “Layer-with-Split”.)

### USING THE EXTERNAL CARD SOUNDS

You can take advantage of the DG8's expandability by acquiring an Alesis QCard™ or other compatible PCMCIA Type I sound card. The Alesis QCard is a credit-card-sized memory module that is pre-programmed with 128 additional sounds for Alesis-compatible instruments. This PCMCIA Type I card is inserted into the DG8's **EXPANSION CARD** slot on the rear panel.

Each QCard contains a library of new sounds that complement and expand upon the internal sounds in the DG8's memory, complete with reverb, chorus and other effects. But please note that when used with the DG8, some effects may act unpredictably.

#### Card Programs in Single Mode

You can access sounds on the QCard just like the DG8's internal Keyboard Programs:

1. Make sure that the DG8 is in Single mode by pressing the **SPLIT/OFF** button and/or the **LAYER/OFF** button, if necessary.
2. Press the **CARD** button just to the left of the display. The first sound in the Card Bank loads into the DG8 and its name and label appear in the top line of the display. Use the **▲** or **▼** arrows to advance or reverse through the 128 QCard Programs numbered 000 through 127.
3. Pressing any of the Keyboard Bank buttons exits the Card Bank.

*Tip:* If you press and **hold** either arrow button, the display will accelerate its scrolling through the available programs. Also, pressing **both** arrows **together** resets the Card Program to 000.

#### Card Programs in a Layer

You can layer a QCard Program with a DG8 Primary Sound. There are three ways of using this feature: the QCard as the Layer sound, the QCard as the Primary Sound or the QCard as both Primary and Layer.

QCard as Layer sound:

1. Make sure that the DG8 is not in a Split or Layer.
2. Select an internal Keyboard Program in the DG8 by pressing any of the Keyboard Bank buttons. Use the **▲** and **▼** arrows, if necessary, to select the desired Program in the Bank.
3. To add a QCard Program as the Layer sound, press and hold the **LAYER/OFF** button. While you are pressing **LAYER/OFF**, press **CARD**. The last Program used from the card as a Layer sound is recalled so you can use the **▲** and **▼** arrows, if necessary, to select the desired QCard Program.
4. You can also select a Card Program for the Layer sound **as you are selecting a Keyboard Bank**: press and hold a Keyboard Bank button (to select the Keyboard Bank for the Primary) and while you are still holding the Keyboard Bank button down, press **CARD**. (This speeds things up by bypassing the **LAYER/OFF** button.)
5. To exit this mode, press the **LAYER/OFF** button. The DG8 will turn off the Layer and keep the Primary Sound you selected in Step 2.

QCard as Primary:

1. Select a QCard Program to be the Primary by pressing the **CARD** button. Use the **▲** and **▼** arrows, if necessary, to select the desired QCard Program.
2. Press and hold the **LAYER/OFF** button, then press a Keyboard Bank button. Use the **▲** and **▼** arrows, if necessary, to select the desired Layer sound.

QCard as Both Primary and Layer:

1. Select a QCard Program to be the Primary by pressing the **CARD** button. Use the **▲** and **▼** arrows, if necessary, to select the desired QCard Program.
2. Press and hold the **LAYER/OFF** button, then press the **CARD** button again. This selects another QCard Program to be the Layer sound. Use the **▲** and **▼** arrows, if necessary, to select the desired QCard Program. Please note that this method – using the **LAYER/OFF** button to create the Layer – is the only way you can layer two Card Programs.

### **QCard Programs in a Split**

You can select a QCard Program to be the Split sound in the lower range:

1. Press and hold the **SPLIT/OFF** button. While you are pressing **SPLIT/OFF**, press **CARD**. The QCard becomes the Split sound on the lower range of the keyboard. Use the **▲** and **▼** arrows, if necessary, to select the desired QCard Program.
2. The DG8 will keep the current Primary Sound selected as the sound for the upper range of the keyboard. If necessary, press any of the Keyboard Bank buttons to select a new Primary Sound; use the **▲** and **▼** arrows, if necessary, to select the desired Keyboard Program.

You can select a QCard program to be the Primary Sound in the upper range of a Split setup:

1. Press a Bass Bank button to set up a standard split.
2. Press the **CARD** button. This selects the QCard as the Primary for the upper range. Use the **▲** and **▼** arrows, if necessary, to select the desired QCard Program.

You can select two QCard Programs in a Split setup, one for the Split sound in the lower range of the keyboard and one for the Primary Sound in the upper:

1. Press and hold the **SPLIT/OFF** button. While you are pressing **SPLIT/OFF**, press **CARD**. The QCard Program becomes the Split sound on the lower range of the keyboard. Use the **▲** and **▼** arrows, if necessary, to select the desired QCard Program for the lower range.
2. Press the **CARD** button (without holding any other buttons). The QCard becomes the Primary sound on the upper range of the keyboard. Use the **▲** and **▼** arrows, if necessary, to select the desired QCard Program for the upper range.



### QCard Programs In a Split-with-Layer

In the following examples, a Split is created first, then the Layer sound is added to complete the Split-with-Layer. Note that **you don't have to create the Split first**; you can create a Layer first if you like, then add the Split sound. We'll use the "Split first, then add the Layer" approach as just one way of accomplishing these setups:

You can select a QCard Program to be the Layer sound of a Split-with-Layer:

#### *Create the Split*

1. Start off with the DG8 in Single mode, with an internal Keyboard Program as the Primary.
2. Press a Bass Bank button to set up the Split; use the ▲ and ▼ arrows, if necessary, to select the desired Bass Program.

#### *Add the Layer*

3. Press and hold the **LAYER/OFF** button and press **CARD**; use the ▲ and ▼ arrows, if necessary, to select the desired Card Program for the Layer sound.

Note that you can select a Card Program in Step 1 as the Primary Sound, and a Keyboard Program as the Layer in Step 3 if you like.

You can select a QCard Program to be **both** sounds in the Layer range of a Split-with-Layer:

#### *Create the Split*

1. Start off with the DG8 in Single mode, but this time with an external Card Program as the Primary: press **CARD** and use the arrows to select the Card Program.
2. Press a Bass Bank button to set up the Split; use the ▲ and ▼ arrows, if necessary, to select the desired Bass Program for the lower range.

#### *Add the Layer*

3. Press and hold the **LAYER/OFF** button and press **CARD** again; use the ▲ and ▼ arrows, if necessary, to select the desired Card Program.

Last, but not least, you can use the QCard for all three sounds in a Split-with-Layer:

#### *Create the Split*

1. Start off with the DG8 in Single mode with an external Card Program as the Primary: press **CARD** and use the arrows to select the Card Program.
2. Press and hold **SPLIT/OFF** then press **CARD** again; use the arrows to select the Card Program that will be used for the **SPLIT** sound.

#### *Add the Layer*

3. Press and hold the **LAYER/OFF** button and press **CARD** for the third time; use the ▲ and ▼ arrows, if necessary, to select the desired Card Program.



**Do not physically remove the card from the rear slot while any Card Program is active. This holds true for Primary, Layer or Split.**

**If a Card Program is the Primary Sound, simply switch the Card Program to an internal Keyboard Program. If a Card Program is the Layer or Split Sound, simply turn off the Layer or Split.**

## DG8 SOUND CHART

GROUP NAME	PRIMARY SOUND LABELS	LAYER/SPLIT SOUND LABELS
PIANO 1	Pno1A, Pno1B, Pno1C, Pno1D	Piano1A, Piano1B, Piano1C, Piano1D
PIANO 2	Pno2A, Pno2B, Pno2C, Pno2D	Piano2A, Piano2B, Piano2C, Piano2D
PIANO 3	Pno3A, Pno3B, Pno3C, Pno3D	Piano3A, Piano3B, Piano3C, Piano3D
ELECTRIC PIANO 1	EP1 A, EP1 B, EP1 C, EP1 D	EIPno1A, EIPno1B, EIPno1C, EIPno1D
ELECTRIC PIANO 2	EP2 A, EP2 B, EP2 C, EP2 D	EIPno2A, EIPno2B, EIPno2C, EIPno2D
FM PIANO	FMPnA, FMPnB, FMPnC, FMPnD	FMPno A, FMPno B, FMPno C, FMPno D
HARPSI/CLAV	HClvA, HClvB, HClvC, HClvD	HrpClvA, HrpClvB, HrpClvC, HrpClvD
VIBES	VibeA, VibeB, VibeC, VibeD	Vibes A, Vibes B, Vibes C, Vibes D
STRINGS	StrgA, StrgB, StrgC, StrgD	StringA, StringB, StringC, StringD
CHOIR	ChorA, ChorB, ChorC, ChorD	Choir A, Choir B, Choir C, Choir D
PAD	Pad A, Pad B, Pad C, Pad D	Pad A, Pad B, Pad C, Pad D
SYNTH	SyntA, SyntB, SyntC, SyntD	Synth A, Synth B, Synth C, Synth D
ELECTRIC ORGAN	EOrgA, EOrgB, EOrgC, EOrgD	EOrganA, EOrganB, EOrganC, EOrganD
PIPE ORGAN	POrgA, POrgB, POrgC, POrgD	POrganA, POrganB, POrganC, POrganD
MULTI	MultA, MultB, MultC, MultD	Multi A, Multi B, Multi C, Multi D
ACOUSTIC BASS	N/A	AcBassA, AcBassB, AcBassC, AcBassD
ELECTRIC BASS 1	N/A	EBass1A, EBass1B, EBass1C, EBass1D
ELECTRIC BASS 2	N/A	EBass2A, EBass2B, EBass2C, EBass2D
SYNTH BASS 1	N/A	SBass1A, SBass1B, SBass1C, SBass1D
SYNTH BASS 2	N/A	SBass2A, SBass2B, SBass2C, SBass2D
PIANO BASS	N/A	PnoBasA, PnoBasB, PnoBasC, PnoBasD
KEYBOARD BASS	N/A	KeyBasA, KeyBasB, KeyBasC, KeyBasD
CARD SOUND	Cd000 through Cd127	Card000 through Card127

## FRONT PANEL CONTROLS

### TUNE

*Page 1: Master Tune*

The DG8 can be globally tuned to another instrument or tuning device, and this operation can be performed in any Play Mode. Press the **TUNE** button and use the **▲** button to raise the pitch of the DG8 and the **▼** button to lower it. The range is  $\pm 1$  half step: each press of an arrow key changes the tuning by 1 cent (100 cents = 1 half step).

**Tip:** Remember that if you want to do a quick reset, press the **▲** and **▼** arrows together. The display will reset the tuning to 00.

Also, holding either arrow down will accelerate the scrolling of the tuning values.

To exit this mode, press the **PLAY** button.

*Page 2: Stretch Tuning*

Pressing the **TUNE** button a second time enters Stretch Tuning mode which employs the tuning method that is actually used to tune real acoustic pianos. With Stretch Tuning, the low strings are tuned increasingly flat, and the high strings are tuned increasingly sharp compared to the equally-tempered scale.

This function defaults to **ON**, and is only active on the three piano groups **PIANO 1**, **PIANO 2** and **PIANO 3**. This feature of the DG8 was not just designed as an esoteric function, but provides an **unusual level of realism** to the piano Programs.

While this mode is desirable when playing a piano program alone, it can cause problems when used with Layers or other MIDI instruments. To partially avert this, the DG8 **automatically** turns off this function when you enter Layer mode so as to avoid tuning conflicts with other internal DG8 Programs. However, when playing the DG8 with other instruments via MIDI, you may need to defeat Stretch Tuning because the high and low ends of the DG8 may sound out of tune with other MIDI instruments. Use the **▼** arrow to turn this function **OFF**. When Stretch Tuning is off, the piano programs will always be tuned to the equally-tempered scale whether used as a Primary sound or as a Layer sound.

Note that, like other settings in the DG8, if turning Stretch Tuning is set to **OFF** it will remain off until you change it or re-initialize the instrument.

To exit this mode, press the **PLAY** button.

### TRANSCOPE

You can transpose the DG8  $\pm 1$  octave. Using Middle C (key "C3") as your reference, press and hold the **TRANSCOPE** button and press a key on the keyboard. Pressing a key above Middle C will transpose the DG8 up by the interval and pressing a key below Middle C will transpose the DG8 down by that interval.

**Tip:** You can also use the **▲** or **▼** arrows to transpose. To reset the transpose to Middle C, press the **▲** and **▼** arrows **together** while this display is being shown.

The selected key will be the new key for the DG8 in any Play mode until it is changed. The Transpose function actually changes the MIDI Note Number sent by

the keyboard *globally* (affects all modes), whether to an external MIDI device or to the internal DG8 sounds or card sounds. Once the keyboard is transposed, all Primaries, Layers and Splits are transposed by the same interval until you change the transpose (even if the DG8 is turned off) or re-initialize the instrument.

Also, if you attempt a transpose value more than the one-octave limit, the DG8 will keep the pitch the same but the key selected will be the nearest one within the one octave range. For example, if you try to transpose up to key E5 (the highest E on the keyboard), the DG8 will transpose the keyboard up to E3, the E above Middle C. Also, transposing the keyboard will not effect the Split Point's physical location on the keyboard.

The Transpose display will exit as soon as you press a key on the DG8's keyboard. To exit this mode without transposing, press **PLAY**.

## **EFFECTS**

Reverb and Chorus have been pre-programmed into nearly all\* of the DG8's sounds. You adjust the level of the effects by moving the appropriate **LEVEL** slider. Just keep in mind that the Reverb and Chorus amounts are determined by the sliders' positions, so if a slider is all the way down, that effect will not be heard at all.

\* The exception to this is the **ELECTRIC ORGAN** Bank which substitutes a rotating speaker effect instead of chorus. The **CHORUS LEVEL** slider acts as a speed control for the rotating speaker.

Note that Bass Programs have a minimal amount of Reverb and Chorus.

## **GRAPHIC EQ**

The DG8's stereo 5-band graphic equalizer provides the tone controls for shaping the overall sound output of the instrument. Press the **EQ ON** button to activate the equalizer. Each slider provides 6dB of boost or cut around each frequency.

The settings made on the EQ affect all sounds in all Play Modes – Primary, Layer, Spilt and Split-with-Layer – and affect all inputs and outputs including the DG8's built-in speakers and headphones. The EQ is also "post-effects" so that reverb, chorus and rotary speaker effects are equalized as well. The EQ settings are **not** changed at power-up or if the DG8 is initialized, but every time you power on the DG8, the EQ will be off.

## **MIDI FUNCTIONS**

Pressing the **MIDI** button puts the DG8 into MIDI Edit mode.

Pressing the **MIDI** button **repeatedly** will **step through the six different pages** of the DG8's MIDI functions.

Press the **PLAY** button to exit any of the pages in this mode.

*Page 1: Basic MIDI Channel*

This is the MIDI Channel for Primary Sounds and Layers. The MIDI Channel assignments for Layer Program Changes and Split channels follow sequentially:  
Layer Program Changes = Basic Channel + 1, Splits = Basic Channel + 2.

The DG8 operates in MIDI "Mode 3: Omni Off/Poly" **only**, and defaults to MIDI Channel 1. To set the DG8 to transmit and receive on another MIDI Channel:

1. Press the **MIDI** button. The last MIDI function display that was accessed will be shown. Press the MIDI button repeatedly until the display reads:

```
BASIC  
MIDI Channel = X
```

... where X is one of the 16 MIDI Channels or Off. When set to Off, the DG8 will neither transmit nor receive MIDI information.

2. Use the ▲ and ▼ arrows to select the new Basic MIDI Channel or Off.
3. To confirm your selection and exit this mode, press **PLAY**.

The DG8 transmits and receives the following MIDI data. Exceptions are noted in parentheses:

### **Channel Messages**

Pitch Bend (receive only)

Velocity

Release Velocity (receive only)

Program Changes

### **Controller Name**

### **MIDI Controller #**

Bank Select (for QCard access)

0

Modulation

1

Volume

7

Pan (receive only)

10

Expression (receive only)

11

Sustain Pedal

64

Sostenuto Pedal

66

Soft Pedal

67

Reverb Level

91

Chorus Level

93

*Page 2: Local Control*

It is possible to use the DG8 as a MIDI controller in a MIDI system **without playing its own internal or card sounds** by turning Local Control off. In this situation, the DG8's keyboard becomes a MIDI transmitter only and does not affect the voices.

This feature is particularly useful when playing the DG8 with a sequencer. The sequencer controls the DG8 while the DG8's keyboard can be used to play another MIDI instrument. Just be sure that the sequencer (or any device controlling the DG8) is not "echoing" MIDI notes from the DG8's keyboard back into the DG8 (unless that's what you want to do).

When this display is shown, pressing the ▲ and ▼ arrows turns Local Control **ON** (the default setting; the keyboard plays the DG8 normally) or **OFF** (the DG8's keyboard plays to **MIDI OUT** only).

*Page 3: AUX Pedal Assignment*

This page allows you to determine how the rear panel **FOOT PEDAL AUX** jack responds to a pedal input, either modulation – rotating speaker for the **ELECTRIC ORGAN** Bank – or volume control. This means that you can tell the DG8 that if a pedal is plugged into the **AUX** jack, it be either a modulation pedal or a volume control pedal.

When this display is shown, pressing the ▲ and ▼ arrows toggles between Modulation and Volume. The default setting is Volume.

*Page 4: Keyboard Scaling*

This function is a sensitivity control for the DG8's velocity response. This function tells the DG8 how to respond to changes in how hard or how soft you play the keys.

When this page is displayed, you will have a choice of values between 00 and 99 with the default setting at 50. It's harder to play loudly and easy to play softly when Keyboard Scaling is set to 00.

At the other extreme, a setting of 99 makes it very easy to play loudly and difficult to play softly.

Use the ▲ and ▼ arrows to scroll through the range until the desired scaling value is displayed. Pressing ▲ and ▼ together resets the display to the default value of 50.

*Page 5: Bass Sustain*

When using the sustain pedal in Split mode, it is usually not desirable to have the left-hand bass sustain when the pedal is stepped on. This parameter defaults to **OFF** so that only the sound on the upper key range sustains. Use the ▲ and ▼ arrows to turn this function **ON** if you want the Bass Programs to sustain with the pedal.

*Page 6: Sustain Catching*

There may be circumstances where the DG8's Sustain Pedal Catching function is not especially useful for what you're playing. Use the ▲ and ▼ arrows on this page to turn the Sustain Catching feature of the DG8 **ON** or **OFF**. For details on what this function does, see the description on the next page. Its default setting is **ON**.

## PEDALS

### BACKGROUND

Understanding the keyboard mechanism of an acoustic piano will help in understanding how the pedals operate on the DG8. Before a piano is played, a series of *dampers* – small blocks of a felt-like material – rest on each string to prevent them from vibrating. When a key is played, the damper for that note lifts up and a hammer strikes the string (and immediately falls back allowing the string to vibrate). As long as you are holding down that key, the damper stays lifted allowing the string to vibrate freely. When the key is released, the damper falls back on the string and stops it from vibrating.

The pedals of an acoustic piano are used to modify the action of the dampers. The DG8's pedals emulate the action of an acoustic piano's pedals **electronically**. The following descriptions illustrate how each pedal works on the DG8.

### SUSTAIN

The DG8's Sustain pedal provides the digital equivalent of the traditional sustain capability of an acoustic piano: **all dampers are lifted** allowing all played keys to sustain as long as the pedal is held down. This provides the rich sound we associate with an acoustic piano. Releasing the pedal causes all vibrating strings to mute due to the action of the dampers. If the pedal is kept down long enough, the sustained notes will fade to silence.

On the DG8, keys played while the Sustain pedal is down will sustain and fade until the pedal is released. There are, however, many variations on the way you can use the Sustain pedal. An great amount of flexibility in musical expression can be achieved in the way the Sustain pedal is used while playing. Here are a few things we built into the DG8:

- a) **Sustain Pedal "Catching"**: If a key or keys are played quickly and the sustain pedal is pressed **after the keys are released**, the sustain of the notes can be "caught" before it fades out completely. The notes will then sustain and fade from the point where the Sustain Pedal is pressed.
- b) **Re-Entering Sustain**: If the pedal is sustaining a note or notes and the pedal is released and then suddenly stepped on again, the DG8 will resume the sustained note(s) but at a lower volume. This imitates the tendency of the mechanical damping action of an acoustic piano to take some amount of time to stop played strings from vibrating. If a damper isn't given enough time to fully stop the strings, they will continue to vibrate, although with less energy. This can be repeated several times until the sound has completely faded out.

Although these two features correctly emulate the behavior of a real piano, they can rob the DG8 of voices and/or make sequences which were recorded on a MIDI device without a sustain catching feature sound a bit muddy. Conversely, if a pre-recorded sequence sounds a bit "choppy", try turning Sustain Catching to **ON**. The Sustain Pedal Catching and Re-entering Sustain features can both be defeated by setting Sustain Catching to **OFF**.

## **SOSTENUTO**

This pedal on an acoustic grand piano\* causes **only the dampers on played keys to lift** until the pedal is released. In other words, if you play a chord, step on the Sostenuto pedal, and then release the keys, the notes you were playing continue to ring. What makes this different from a sustain pedal is that you can play every other note on the keyboard and they won't sustain, but if you play the notes you were holding when you stepped on the sostenuto pedal, they will still sustain. Try a glissando down the keys and you'll hear the chord you played spelled out as you pass those notes!

On the DG8, this pedal produces the digital equivalent of "lifting dampers" only on the played keys.

\* **NOTE:** The DG8 emulates the sostenuto pedal of a **grand** piano, not an upright, and we want to make that distinction clear. On upright pianos, what the "middle pedal" does varies from brand to brand.

## **SOFT PEDAL**

This pedal on an acoustic piano is so named because it produces a quieter performance. The way acoustic pianos accomplish this varies. In some pianos, the soft pedal causes all dampers to be lifted but not as high as the sustain pedal lifts them, so that the brightness and loudness of the notes are "softened". In others, the soft pedal accomplishes its task by shifting the position of the keybed so the hammers strike the strings in a different way.

This last option takes two different forms. For example, all acoustic pianos have many notes for which there are two or more strings per key. On a concert grand piano, the soft pedal physically moves the keybed sideways so the hammers strike fewer strings per key.

Other pianos employ a third method that lowers the entire set of keys into the keybed a little. This reduces the distance the keys are able to travel, which in turn limits the amount of kinetic energy which can be transferred from the hammers into the strings, thereby resulting in a quieter performance.

On the DG8, this pedal achieves a similar "softening" of the brightness and loudness by reducing the keyboard's response to velocity, which therefore makes the sound somewhat lower in volume and brightness.

## **PEDAL CONNECTIONS**

*Momentary* footswitches are used for the Sustain, Sostenuto and Soft Pedal features of the DG8. "Momentary" means that it is a spring-loaded switch that operates by "pressing and releasing".

Pedals are plugged into the DG8's rear panel jacks. Each jack is labeled so that you'll know which pedal performs which function.

These pedals – they're actually electrical switches, but we'll refer to them as **pedals** to keep consistent with piano terms – are designed to reproduce the same response as their acoustic counterparts. But since we're dealing with an electronic instrument, the concept here is that when a switch like this is pressed, it is in its **on** position; when you release it, it's **off**.



A *momentary* foot **switch** with a 2-conductor 1/4" connector is used for the Soft Pedal function of the DG8. A momentary footswitch with a 3-conductor 1/4" connector is used for the Sustain/Sostenuto functions of the DG8. "Momentary" means that it is a spring-loaded switch that operates by "pressing and releasing" for on (press) or off (release) signals.



**If you use a footswitch with a 2-conductor connector for Sustain/Sostenuto, the Sostenuto function will NOT operate.**

*Potentiometer* foot **pedals** with 2-conductor connectors are used for volume and modulation. "Potentiometer" means that the pedal mechanically operates an internal **knob** (technically known as a potentiometer) giving you "more" or "less" rather than "on" or "off" like a switch. These pedals are often referred to as "rocker pedals".

The diagram below shows what the right kind of connector looks if you want to purchase footpedals, or if you need a pedal that is different from the one shipped with the DG8.

Connector for the optional Soft Pedal, the included Sustain Pedal and Volume and Modulation Pedal

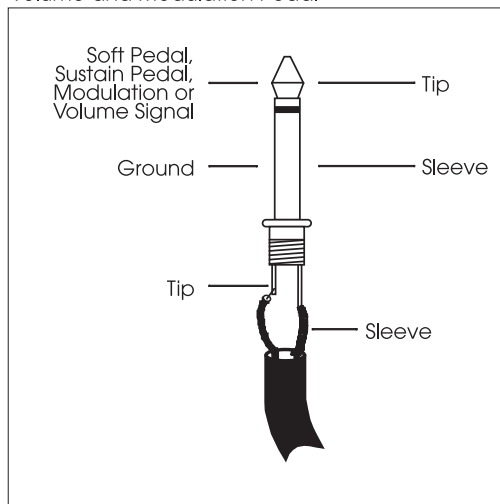

Connector for the optional Sustain/Sostenuto Pedal

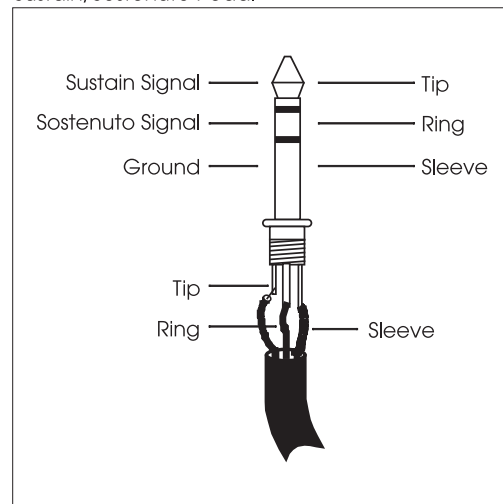

Plug the pedals into the DG8's back panel jacks. Each jack is labeled so that you'll know which pedal or switch performs which function.

For the volume or modulation pedal, use the **AUX** jack. Note that the DG8 must be set to perform either volume control **or** modulation, not both. To select the operation of the pedal, press the **MIDI** button on the front panel repeatedly until **AUX Pedal** appears in the display. Use the **▲** or **▼** arrows to select between **Modulation** or **Volume**. Press the **PLAY** button to confirm your choice and return the DG8 back to Play mode.

## AUDIO INPUTS AND OUTPUTS

The DG8 uses standard 2-conductor 1/4" tip-sleeve unbalanced connectors for back panel audio connections and a 3-conductor 1/4" tip-ring-sleeve connector for the two headphone outputs on the front. The diagram below shows what the right kind of connector looks like when purchasing audio cables and headphones.

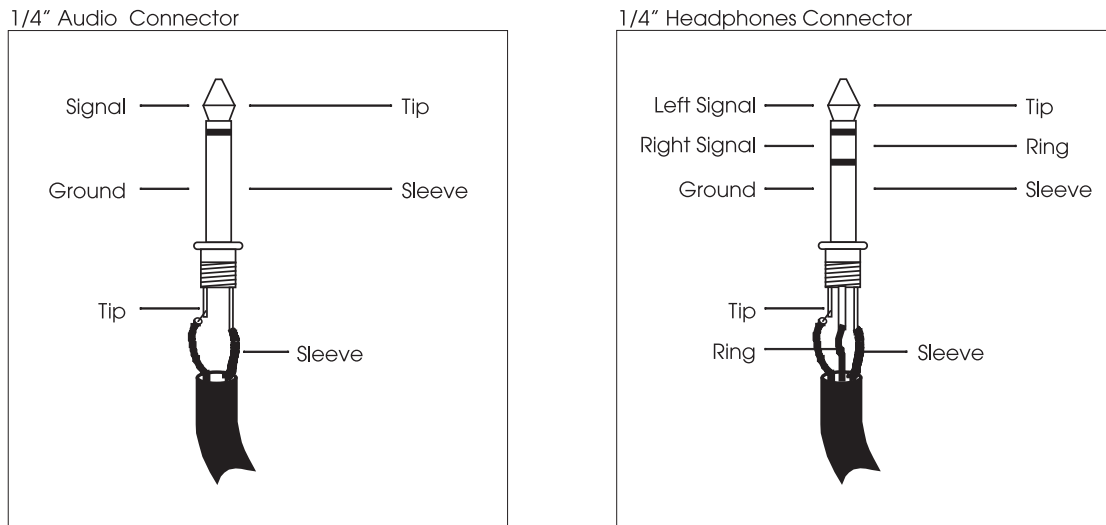

### Outputs

To connect your DG8 to a sound system in **stereo**, connect two 2-conductor unbalanced audio cables from the unit's **R** and **L/MONO** jacks on the back panel **OUTPUTS** section to two inputs on your sound system. If you are connecting the DG8 to a mixer, pan the channels hard left and right to obtain a full stereo image.

To connect your DG8 to a sound system in **mono**, connect a 2-conductor unbalanced audio cable from the unit's **L/MONO** jack on the back panel **OUTPUTS** section to an input on your sound system.

*Tip:* If necessary, you can turn the DG8's internal sound system off. There's a slide switch on the back panel adjacent to the stereo outputs that turns the speakers on or off.

### Inputs

The DG8 accommodates audio inputs from such sources as a stereo cassette or audio CD player. These signals are mixed with the DG8's internal sound system and output to the speakers. The DG8's **VOLUME** slider adjusts the volume level of the composite mix of the DG8's internal sounds, external card sounds and signals coming into the **INPUTS** jacks. The level of the cassette or CD player must be set on the cassette or CD player itself in order to control it separately from the DG8's internal sounds.

To connect an external audio source in **stereo**, connect two 2-conductor unbalanced audio cables from the source to the DG8's **R** and **L/MONO** jacks on the back panel **INPUTS** section. To connect an external audio source in **mono**, use one 2-conductor unbalanced cable from the source to the **L/MONO** jack. This will route the mono signal to both speakers. Plugging the cable into the **R** jack will route the sound to the right speaker only.

## INITIALIZING THE DG8

### FACTORY DEFAULTS

When the DG8 is shipped from the factory, its user parameters are set to certain values so that the unit will perform its most basic functions right out of the box. These are called *defaults* – values that are set at the factory as the most useful and/or logical starting points for the various functions within the unit. You may have noticed this as you explored the DG8's functions, and this manual refers to these default values from time to time.

If for any reason you want to return the DG8 to the state it was in when it shipped, you can *initialize* (perform a complete reset) of the DG8 and return it to its default state. This feature is particularly useful in the event a power problem causes the DG8 to behave strangely, or if certain functions do not seem to be operating as expected.

To initialize the DG8:

- Turn it off.
- Press and hold the ▲ and ▼ arrows.
- While the arrows are being held down, turn the DG8 back on.

This simple procedure resets the following parameters:

- MIDI volume is reset to the maximum of 127 for the Primary Sound, Layer and Split
- EQ is turned off
- modulation is reset to 0
- Program Piano1A is selected with no Layers or Splits
- all Primary Sound and Bass Program sound banks are reset to the A program. Selecting a Card Program will recall program 000 whether used as Primary Layer or Split.
- tuning is reset to A440; the Master Tune display resets to 00
- default Split Point is reset to key "C2", the C one octave below Middle C
- the AUX pedal is reset to Volume
- Keyboard Scaling is reset to the mid-point value of 50
- Stretch Tuning is turned on
- Sustain Catch is turned on
- Local Control is turned on
- Basic MIDI Channel is set to 1
- Bass Sustain is turned off

### POWER-UP RESETTING

There are two parameters and one function which reset every time you turn the DG8 on. Modulation and volume values are reset upon power up, and the **EQ ON/OFF** button is turned off.

---

# MIDI FUNCTIONS

---

## MIDI BASICS

Before we delve into the specific MIDI functions of the DG8, we'd like to provide a brief background on MIDI for those who may not be familiar with this technology.

MIDI (pronounced "MID-ee") is the acronym for **M**usical **I**nstrument **D**igital **I**nterface. It was developed and adopted by electronic musical instrument manufacturers in the early 1980s as a common system of connecting electronic musical instruments and devices so that they could share music data as well as other digital information.

Just about any device that has a microprocessor (synthesizers, samplers, sequencers and drum machines, analog and digital recorders and mixers, effects devices and computers) can share music data (notes and chords) and various digital information such as pitch bend and vibrato, sustain and volume pedal, keyboard velocity, pressure and aftertouch, patch change commands, timing data (called "MIDI Clock") and a wide variety other types of data.

Thus, virtually any musical expression that is generated by an electronic musical device could be shared in a system of MIDI devices. But we are not limited to musical applications alone. With the addition of MIDI Time Code for example, the ability to interface a music system with video production was realized. There are even stage lighting systems that use MIDI for programming light control and data storage.

A document called the *MIDI Specification* describes all possible MIDI functions and how they should work. Manufacturers use this spec when designing products so that a fairly high level of compatibility among different brands can be reasonably expected.

Generally, a manufacturer will also include a MIDI Implementation chart with each product so that you can know how MIDI was designed into that particular model. This is usually helpful to know because not every MIDI function needs to be included in every musical product. For example, certain MIDI functions that are unique to keyboard instruments are unnecessary on, say, digital effects devices. Manufacturers have the option of including whatever MIDI functions are appropriate to the product. You can find the MIDI Implementation chart for the DG8 on page 67.

# MIDI HARDWARE

MIDI instruments and devices are connected by a fairly simple system of cables. The **MIDI OUT** port transmits data from one device one-way through the cable to the receiving instrument's **MIDI IN**. You can setup each device in the system to send and respond to MIDI commands in a certain way. For example, you can tell a keyboard or guitar synth to send everything in MIDI except for Program Change commands. By the same token, you can tell your sound module to respond to any MIDI command sent to it but ignore Velocity data.

**MIDI THRU** simply passes data received by **MIDI IN** right back out to another device connected to it. This makes "chaining" possible in a MIDI system. For some examples in connecting MIDI devices together, see our illustrations in the section entitled **The DG8 in a Music System** starting on page 20.

Also of importance in discussing MIDI hardware is the term *voice*. An instrument's voice is the most basic unit of sound generation. It can be an integrated circuit chip (or chips) or can be a sampled sound in the instrument's memory, like the DG8.

# MIDI MESSAGES

There are two types of MIDI messages that are communicated through your network of MIDI cables: *Channel* and *System*.

Channel Messages are typically the messages you'll be most concerned with for routine MIDI operations and can originate (be transmitted) from virtually any device in the system. MIDI provides 16 "Channels" through which certain MIDI data is shared among devices in the system. The communication of certain messages along Channels makes it possible to connect many devices together but allows you to specify **which devices communicate directly with each other**. For example, you could have seven MIDI devices that are all connected to each other. Two of the devices can be communicating on Channel 2, two others on Channel 9 and the remaining three on Channel 4, as one possible setup.

Channel messages are further divided into two groups: *Voice* messages and *Mode* messages. Because these messages are *channelized* – they are communicated on a designated Channel number – they are only recognized by instruments that have been set to receive on that Channel.

System messages, on the other hand, **do not have a channel number** and can be received **by any device in a system**. This permits devices in a MIDI system to share certain data without having to be set to a particular Channel. System messages, like Channel messages, can originate from just about any MIDI device in the system. The three types of System messages are called *Real Time* messages, *Common* messages and *Exclusive* messages. Because none of these types of messages are implemented on the DG8, we will not be covering them in this manual.

## CHANNEL MESSAGES: VOICE MESSAGES

Each MIDI device is assigned a *Basic MIDI Channel*. This is the MIDI Channel that the instrument will use to **transmit** MIDI data and can be set to any Channel # 1 - 16. This is also the MIDI Channel that the instrument will **receive** on.

This principle is not set in concrete, however. For many MIDI instruments, the ability to communicate – both transmit and receive – on **several** Channels at once is quite

common. For example, certain instruments are designed such that you can set a Voice or group of voices to MIDI Channels other than the Basic Channel. This provides enormous flexibility in the way that the instrument can control other instruments in the system, or be controlled by another MIDI device. You might want to think of a device's Basic Channel as the one on which other Channels can be based – hence the word “basic”. A good place to start is a setup that instructs the unit to transmit and receive on the Basic Channel, then build from there if you need to.

The DG8 is a prime example of a multiple MIDI Channel instrument in that three **successive** MIDI Channels are designated to communicate data: Primary Sounds and Layers transmit and receive on the Basic Channel **except** Program Change commands for Layers, which happen on the next higher Channel (Basic Channel +1); Splits transmit and receive on the next higher Channel (Basic Channel + 2). For an in-depth look at how this is implemented on the DG8, see page 58.

MIDI messages that affect your instrument's voices include:

**Note On.** This message communicates that a particular note is being played and corresponds to a key being pressed down; values range from 000 (the lowest possible note) to 127 (the highest possible note). Middle C is MIDI Note #60.

**Note Off.** Where a Note On message communicates when a note is to be played, this message tells when the key has been released. This may appear a little like overkill, but remember that we're dealing with computers here: every action requires a corresponding message to be communicated.

**Velocity.** A Velocity message corresponds to the *dynamics* of your playing by telling the receiving device how quickly (or slowly) a note was played. Typically, Velocity affects the loudness and brightness of the sound – playing harder makes the sound louder and brighter; playing softly makes the sound quieter and less bright. In the more elaborate products, this data can be routed to other aspects of the sound as well for some very interesting results. Velocity values range from 001 (minimum velocity) to 127 (maximum velocity). A velocity of 000 is equivalent to a Note Off message.

**Program Change.** Sending a Program Change command from a sequencer or another MIDI keyboard can change synth patches automatically. There are 128 Program Change command numbers.

Also note that not all instruments and devices number programs consistently. Some number them as 000-127, others as 001-128, and still others arrange programs in banks of eight programs (such as A1-A8, B1-B8, C1-C8, etc.) or, as in the case of the DG8, Banks of four programs designated A, B, C and D.

**Pitch Bend.** This “bends” a note from its standard pitch.

**Continuous Controllers.** This term is sometimes abbreviated “CC” and is followed by a number sign and a number, as in “CC #7”. If you look at the chart on the next page, you'll see that “Continuous Controller #7” controls MIDI (or Main) Volume. What we mean by “continuous” is that the controller is able “to go from 0 to 127 in increments of 1”. Although this might first appear as a rough stepping from one value to the next, the resolution of 128 increments is small enough to provide a smooth transition through this range. If this resolution is not fine enough, the manufacturer can opt to add more resolution by using a second byte to define the range. Controller #'s 32 through 63 are used for this purpose.

Footpedals, breath controllers, and modulation wheels can vary sounds as you play, thus adding expressiveness. MIDI allows for 32 continuous controllers and 58

continuous/switch controllers (which can act like continuous controllers, but some are assumed to choose between two possible states, such as on and off).

Each type of controller is stamped with its own controller identification number. Not all controller numbers have been standardized for specific functions, but the following indicates the current list of assigned controllers.

CONTROLLER #	FUNCTION	DATA RANGE
0	Bank Select	0 - 127
1	Modulation Wheel	0 - 127
2	Breath Controller	0 - 127
3	Early DX7 Aftertouch	0 - 127
4	Foot Controller	0 - 127
5	Portamento Time	0 - 127
6	Data Slider	0 - 127
7	Main Volume	0 - 127
8	Balance	0 - 127
10	Pan	0 - 127
11	Expression	0 - 127
16	General Purpose #1	0 - 127
17	General Purpose #2	0 - 127
18	General Purpose #3	0 - 127
19	General Purpose #4	0 - 127
32-63	Least Significant Bytes (LSB), Controllers 0-31	0 - 127
64	Sustain Pedal	0 or 127
65	Portamento On/Off	0 or 127
66	Sostenuto Pedal	0 or 127
67	Soft Pedal	0 or 127
69	Hold 2	0 or 127
80	General Purpose #5	0 or 127
81	General Purpose #6	0 or 127
82	General Purpose #7	0 or 127
83	General Purpose #8	0 or 127
91	Reverb Depth	0 - 127
92	Tremolo Depth	0 - 127
93	Chorus Depth	0 - 127
94	Celeste Depth	0 - 127
95	Phase Depth	0 - 127
96	Data Increment	0 or 127
97	Data Decrement	0 or 127
98	Non-Registered Parameter MSB	0 - 127
99	Non-Registered Parameter LSB	0 - 127
100	Registered Parameter MSB	0 - 127
101	Registered Parameter LSB	0 - 127
121	Reset All Controllers	0
122	Local Control On/Off	0 or 127
123	All Notes Off	0
124	Omni Off	0
125	Omni On	0
126	Mono On	0-16; 0 = Omni Off
127	Poly On	0

## **CHANNEL MESSAGES: MODE MESSAGES**

There are four types of messages that determine the MIDI *Mode* of the instrument. The “mode” of a device refers to **how it will respond to incoming MIDI data**. The MIDI Specification outlines four possible modes and the DG8 implements a modified version of one of these four modes called “Mode 3: Omni Off/Poly”.

Mode 3 describes how polyphonic instruments in general receive notes on one Channel only. But as we discovered on page 55, the DG8 uses **multiple** MIDI Channels when communicating with other devices. Three **successive** MIDI Channels are designated to communicate data: Primary Sounds and Layers transmit and receive on the Basic Channel **except** Program Change commands for Layers, which happen on the next higher Channel (Basic Channel +1); Splits transmit and receive on the next higher Channel (Basic Channel + 2). For an in-depth look at how this is implemented on the DG8, see page 58.

Portions of this Chapter are abridged versions of material from *Power Sequencing with Master Tracks Pro/Pro 4* and *The Complete Guide to the Alesis HR-16 and MMT-8*, copyright 1990 and 1989 respectively by AMSCO Publications, and are adapted with permission.



## MIDI AND THE DG8

With the previous description of MIDI basics in mind, let's continue with a few more details concerning the MIDI functions that are present in the DG8. A **MIDI Implementation Chart** is provided in Appendix C that lists the MIDI functions supported by the DG8.

### CHANNEL MESSAGES

As we mentioned in the "Voice Messages" section of this Chapter, certain instruments are designed such that you can set a voice or group of voices to MIDI Channels other than the Basic Channel the instrument has been set to. This is an important concept to understand when setting up the DG8 as a master (transmitting MIDI to other instruments) or as a slave (receiving MIDI from other instruments) in a MIDI music system.

In the case of the DG8, a "group of voices" would be the two Programs in a Layer, as one example – the Primary Sound plus the Layer sound. Some of the DG8's voices are allocated to the Primary Sound and some to the Layer sound. For a Split, voices are grouped for the Bass Program played from the lower range of the keyboard and the Primary Sound played from the upper range, as another example of voice grouping.

A key point to consider when using MIDI on the DG8 is that three **successive** MIDI Channels are designated to transmit and/or receive data: the Primary Sound and Layer transmit and receive on the Basic Channel **with one exception** which is Program Change commands for the Layer which happens on the next higher Channel (Basic Channel + 1). A Split transmits and receives on the next higher Channel (Basic Channel + 2). Note that Program Change commands for the Bass Program only occur on the Basic Channel +2.

Therefore, if you set the DG8's Basic MIDI Channel to, say, Channel 6, the Primary Sound and Layer transmit and receive on Channel 6 (the Basic Channel), Program Change commands for the Layer occur on Channel 7 (Basic Channel + 1) and the Split transmits and receives on Channel 8 (Basic Channel + 2).

When you first power on the DG8, it defaults to the following MIDI settings:

MIDI Basic Channel: Channel 1

Receive – Mode 3: OMNI Mode off/Poly.

MIDI Channel 1	Primary Sound Layer	all supported Channel Messages all supported Channel Messages <b>except</b> Program Change commands
MIDI Channel 2	Program Change commands (only) for the Layer sound	
MIDI Channel 3	Split	all supported Channel Messages Program Change commands only affect the Bass Program.

### **Program Changes**

The way the DG8 sends and responds to MIDI Program Change commands was designed to imitate the way Programs – whether Primary, Layer or Split – are selected from the front panel buttons. This is an important concept to understand and the following examples will help to illustrate how this works in the real world.

Specific MIDI operations are explained with these examples:

1. When the DG8 is playing Primary Sounds only (not in a Layer or Split) and you press a Keyboard Bank button, the DG8 recalls the last Keyboard Program that was used in that Bank and transmits its MIDI Program Number on the Basic Channel.

If you use the ▲ or ▼ arrows to select another Keyboard Program in that Bank, the MIDI Program Number that corresponds to each Keyboard Program as it comes up in the display is also sent on the Basic Channel.

MIDI Program Numbers 000 through 003 correspond to DG8 Keyboard Programs Piano 1 “A” through “D”; MIDI Program Numbers 004 through 007 correspond to DG8 Keyboard Programs Piano 2 “A” through “D” and so on up to MIDI Program 059.

Card Programs are easier to keep track of since they correspond with MIDI Program Numbers exactly: Card Program 000 = MIDI Program Number 000, Card Program 001 = MIDI Program Number 001, and so forth on up to 127.

2. Since the Layer sound comes from the same sound banks as the Primary Sounds (either the Keyboard Banks or a Card), the same MIDI Program Change rules apply as in the examples above. Just remember that when changing the Layer sound from the DG8’s front panel, the MIDI Program Change number is transmitted from the DG8 on the Basic Channel + 1. When sending the DG8 a Program Change command from another device in your rig with the intent of changing the Layer sound, be sure to send it to the DG8 on this Channel.
3. When a Bass Bank button is pressed, the DG8 recalls the last Bass Program that was used in that Bank and transmits its MIDI Program Number on the Basic Channel + 2.

If you use the ▲ or ▼ arrows to select another Bass Program in that Bank, the MIDI Program Number that corresponds to each Bass Program as it comes up in the display is also sent on the Basic Channel + 2.

MIDI Program Numbers 000 through 003 correspond to DG8 Bass Programs Acoustic Bass “A” through “D”; MIDI Program Numbers 004 through 007 correspond to DG8 Bass Programs Electric Bass 1 “A” through “D” and so on up to MIDI Program 027. Notice that the same range of MIDI Program Numbers are used for the Bass Programs as for the Keyboard and Card Programs. But not to worry: since Program Change messages are communicated on different MIDI Channels for Primaries, Layers and Splits, no conflicts should occur.

The following chart summarizes the DG8's handling of transmitting and receiving MIDI Program Change commands:

MIDI Program #	Primary/Layer Program	Primary Channel	Layer Channel	Bass Program	Split Channel
000	Pno1A	Basic	Basic + 1	ABasA	Basic + 2
001	Pno1B	Basic	Basic + 1	ABasB	Basic + 2
002	Pno1C	Basic	Basic + 1	ABasC	Basic + 2
003	Pno1D	Basic	Basic + 1	ABasD	Basic + 2
↓	↓			↓	
024	HClvA	Basic	Basic + 1	KBasA	Basic + 2
025	HClvB	Basic	Basic + 1	KBasB	Basic + 2
026	HClvC	Basic	Basic + 1	KBasC	Basic + 2
027	HClvD	Basic	Basic + 1	KBasD	Basic + 2
↓	↓				
056	MultA	Basic	Basic + 1	—	—
057	MultB	Basic	Basic + 1	—	—
058	MultC	Basic	Basic + 1	—	—
059	MultD	Basic	Basic + 1	—	—

- When using MIDI Bank Select commands to remotely change banks on the DG8, internal Primary and Layer sounds are MIDI Bank 1, Bass sounds are MIDI Bank 2 and Card sounds are MIDI Bank 3. Card sounds are always MIDI Bank 3 regardless of whether they are used as a Primary, Layer or Split.

### Pedals

The DG8 transmits and receives pedal messages in accordance with the MIDI Specification: Sustain Pedal is assigned Controller #64, Sostenuto Pedal is assigned Controller #66 and Soft Pedal is assigned Controller #67.

Care must be taken when you are **sending** the DG8 MIDI Pedal messages. If you are playing the DG8 from a MIDI master that only has a sustain pedal, it will most likely be sending Controller #64. So if you intend to use the Soft Pedal function, for example, you will need to change your master to transmit the Soft Pedal message (MIDI Controller #67) instead of Sustain Pedal (MIDI Controller #64).

# GLOSSARY

## DG8 TERMS

<b>Bass Program</b>	a sound Program selected from one of the Bass Banks
<b>Card Program</b>	a sound Program selected from the "Card Bank", an external sound card inserted into the DG8's back panel
<b>Defaults</b>	settings or display values that are set at the factory as the most useful and/or logical starting points for the various functions within the unit
<b>Graphic EQ</b>	short for "graphic equalizer", the five sliders on the left side of the DG8's control panel that are used to adjust the tone of the sound output; the audio spectrum of the DG8 is divided into five "frequency bands" or ranges that can be boost or cut $\pm 6$ dB.
<b>Initialize</b>	to perform a complete reset of the DG8's functions to its defaults; see "Defaults"
<b>Keyboard Program</b>	a sound Program selected from one of the Keyboard Banks
<b>Layer</b>	a combination of two Keyboard or Card Programs in which playing the DG8 plays both sounds at once; this term also refers to the selected <b>LAYER</b> sound shown in the display
<b>Primary Sound</b>	the sound program shown in the display selected from the Keyboard Banks or the Card Bank; the Primary Sound is active in all Play Modes: Single, Layer, Split and Split-with-Layer
<b>Split</b>	the keyboard of the DG8 is divided into two play ranges: one of the 28 Bass Programs is assigned to the lower range of the keyboard (normally played with the left hand) and one of the 60 Primary Sounds assigned to the upper range of the keyboard (normally played with the right hand); see also "Split Point"
<b>Split Point</b>	the key that determines where the two ranges of a split are divided; the Split Point is the highest key of the "lower" range
<b>Split-with-Layer</b>	a keyboard setup where the Split function (a Bass Program on the lower range of keys) is used with the Primary Sound and a Layer on the upper key range
<b>Soft Pedal</b>	pressing this pedal reduces the loudness and brightness of the sound
<b>Sostenuto Pedal</b>	similar to Sustain Pedal, except that notes which are held when the sostenuto pedal is pressed are sustained while any new notes played after the pedal has been pressed are not sustained
<b>Stretch Tuning</b>	a common acoustic piano tuning method where low strings are tuned increasingly flat and high strings are tuned increasingly sharp
<b>Sustain Pedal</b>	pressing this pedal causes played notes to continue sounding after the key is released. They will fade or "decay" in a manner consistent with the selected instrument
<b>Transpose</b>	changes the key of the DG8 $\pm 1$ octave in half-step increments

## **MIDI TERMS**

<b>All Notes Off</b>	a command that is transmitted to all devices in a MIDI system that prevents notes from becoming stuck on
<b>Channel</b>	one of sixteen separate “paths” that Voice and Mode data can travel on
<b>Channel Messages</b>	data that communicates Voice and Mode messages on a specific, user-selected Channel
<b>Controllers</b>	commands that are used for musical expression (volume, sustain, vibrato, etc.) or remote control of other devices in the MIDI system (reverb depth, bank select, etc.)
<b>MIDI</b>	“Musical Instrument Digital Interface”; refers to the system of connecting microprocessor-controlled instruments and devices for sharing information
<b>MIDI IN</b>	the port on a device that receives MIDI data
<b>MIDI OUT</b>	the port on a device that transmits the MIDI data generated by the device
<b>MIDI THRU</b>	the port on a device that passes received MIDI data to the next device in the chain
<b>Mode</b>	a particular state that an instrument or device is currently in; in MIDI, “mode” refers to the unit’s <b>receive</b> state that determines 1. how MIDI messages are received, and 2. how voices will be assigned to handle MIDI notes
<b>Program Change</b>	a command that instructs the receiving instrument to recall a specific sound program from memory

# TROUBLESHOOTING

If you experience problems while operating your DG8, please use the following table to check for possible causes and solutions *before* contacting Alesis customer service for assistance. Some of them may seem rather obvious, but you'd be amazed at how easy it can be to overlook the basics.

Please note that many problems can be solved simply by re-initializing the DG8 – see page 52.

SYMPTOM	CAUSE	SOLUTION
The display does not light up when the <b>ON/OFF</b> switch is turned on.	No power.	Check that the power cable is plugged in properly.
No sound.	Volume is turned down or the volume pedal is at minimum.	Raise the <b>VOLUME</b> slider or volume pedal if one is being used.
	Speakers are turned off.	Turn speakers on using the switch on the back panel.
	MIDI Volume on master controller is set to 0.	Check MIDI Volume level on master MIDI device.
	Local Control is set to off.	Turn Local Control on – see page 47.
Layer sound cannot be heard.	Layer <b>LEVEL</b> slider is down.	Raise the <b>LAYER</b> slider.
Split sound cannot be heard.	Split <b>LEVEL</b> slider is down.	Raise the <b>SPLIT</b> slider.
Notes are stuck on.	MIDI sequencer or controller sent an incomplete MIDI message.	Step on the sustain pedal and release. Or select the Basic MIDI Channel page and set MIDI to off – see page 46.
I can hear Reverb and/or Chorus, but their sliders are down.	MIDI sequencer or controller sent a message to increase these levels.	Move the <b>REVERB</b> or <b>CHORUS</b> slider a little to re-activate it, then set the amount as desired.
Non-layered piano programs are out of tune with external MIDI devices or other instruments.	Stretch Tuning is on.	Select the Stretch Tuning page and turn it off – see page 44.

## Appendix B: Troubleshooting

---

SYMPTOM	CAUSE	SOLUTION
All programs are out of tune with external MIDI devices or other instruments.	Master Tune has been changed.	Adjust Master Tune – see page 44.
DG8 is not playing at concert pitch.	Keyboard has been transposed.	Press the <b>TRANPOSE</b> button, then play Middle C to set transpose to +00 – see page 44.
DG8 sounds chorused or tinny even when chorus fader is down.	MIDI Echo turned on in a MIDI sequencer, or DG8's Local Control is still on while using a MIDI sequencer.	Turn Local Control off in the DG8 (see page 47) or turn MIDI Echo off in the sequencer or computer.
The AUX pedal is not controlling the volume.	AUX pedal has been set to control modulation.	Set AUX pedal to Volume – see page 47.
The AUX pedal is not controlling modulation or the rotary speaker effect on Electric Organ programs.	AUX pedal has been set to control volume.	Set AUX pedal to Modulation – see page 47.
The sustain pedal is controlling the volume or brightness.	Sustain pedal is plugged into the <b>SOFT</b> pedal jack.	Plug the sustain pedal into the <b>SUSTAIN/SOST</b> jack.
Soft pedal causes notes to sustain.	Soft pedal is plugged into the <b>SUSTAIN/SOST</b> jack.	Plug the soft pedal into the <b>SOFT</b> jack.

## **CLEANING AND MAINTENANCE**

While your DG8 should not need much attention, here are some tips for preventive maintenance:

- Disconnect the AC power Adapter, then use a damp cloth to clean the DG8's metal and plastic surfaces. For heavy dirt, use a non-abrasive household cleaner such as Formula 409® or Fantastik®. **DO NOT SPRAY THE CLEANER DIRECTLY ONTO THE FRONT OR BACK OF THE UNIT AS IT MAY CONTAMINATE THE INTERNAL CARD SLOT CONTACTS, THE DISPLAY OR THE FRONT PANEL BUTTONS!** Spray onto a cloth, then use the cloth to clean the unit.
- Periodically check the power adapter for signs of fraying or damage.
- Unplug the DG8's AC power adapter when not in use for extended periods of time.
- Place a dust cover over the unit when it is not in use.
- Vacuum around the RAM card slot to keep dust from falling into it. **DO NOT SPRAY ANY KIND OF CLEANER OR LUBRICANT** into the card slot.
- The one place where contact cleaner may be useful is on the three 1/4" back panel jacks and cables. Periodically disconnect the DG8 from AC power and all cables, and clean the 1/4" cable ends with rubbing alcohol or electronic contact cleaner, then work the plug into the jack repeatedly. **DO NOT SPRAY CONTACT CLEANER DIRECTLY INTO THE JACKS.** It's better to use a damp plug to clean the jacks, or use a cotton or foam swab (but be careful not to get cotton or foam stuck in the unit). While Alesis does not endorse the use of any specific product, certain contact enhancers (such as Cramolin™) may be used to keep the connections from corroding in the future.





# SPECIFICATIONS

## MIDI IMPLEMENTATION CHART

Function		Transmitted	Recognized	Remarks
Basic Channel	Default Changed	1 - 3 <sup>1</sup> 1 - 16	1 - 3 <sup>1</sup> 1 - 16	Any three consecutive Channels.
Mode	Default Messages Altered	Mode 3 X *****	Mode 3 X	
Note Number	True Voice	9 - 120 *****	0 - 127 0 - 127	
Velocity	Note On Note Off	○ ○	○ X <sup>2</sup>	
After Touch	Keys Ch's	X X	X X <sup>2</sup>	
Pitch Bender		X	○	
Control Change	0	○	○	Bank Select From AUX pedal " " "
	1	○	○	
	7	○	○	
	11	X	○	Sustain Sostenuto Soft Pedal Reverb Depth Chorus Depth
	64	○	○	
	66	○	○	
	67	○	○	
91	○	○		
93	○	○		
Prog Change	True #	0 - 59 <sup>3,4</sup> *****	0 - 59 <sup>3,4</sup> 0 - 59	
System Exclusive		X	X	
System Common	Song Position	X	X	
	Song Select	X	X	
	Tune Request	X	X	
System Realtime	Clock	X	X	
	Commands	X	X	
Aux Messages	Local On/Off	X	X	CC #121
	All Notes Off	X	X	
	Active Sense	X	X	
	System Reset	X	○	
Notes:		<sup>1</sup> Layer Channel sends/receives Program Change/Bank Select only. <sup>2</sup> Some card programs may respond to Channel Aftertouch/Note Off value. <sup>3</sup> 0 - 27 for internal Split Programs. <sup>4</sup> 0 - 127 for Card Programs.		

Mode 1: OMNI ON, POLY  
Mode 2: OMNI ON, MONO

Mode 3: OMNI OFF, POLY  
Mode 4: OMNI OFF, MONO

○ : Yes  
X : No

## **SPECIFICATIONS**

Sound Generation Method:

16 Bit Linear 48kHz Sample ROM with sweepable lowpass filter per voice

Polyphonic Voices:

64

Keyboard Section:

88 weighted keys, velocity sensitive

Sound ROM:

24 MB, expandable to 32 MB via PCMCIA Expansion Card Slot

Program Memory:

88 internal preset Programs

Effects:

QS Parallel Matrix Effects™ (4 independent stereo multieffect processing busses)

Expansion Slot:

PCMCIA card slot, will play QCards and cards created with Alesis SoundBridge™ software

Pedal Jacks:

sustain, sostenuto/soft pedal and AUX (modulation or volume)

MIDI Jacks:

In, Out, Thru

Audio Outputs:

Stereo (L/R) outputs on 1/4" jacks, 2 headphone outputs on 1/4" TRS jacks

Audio Inputs:

Stereo (L/R) inputs on 1/4" jacks

Dimensions (WxHxD):

54" x 5.25" x 18.5"  
(1370mm x 133mm x 471mm)

Weight:

80 lbs. (36.3kg)

---

# WARRANTY

---

This product is warranted by Alesis to the original purchaser against defects in material and workmanship for a period of 1 year for parts and labor from the date of purchase. Complete terms of the Limited Warranty are stated on the Warranty Card packed with the product. Please retain a copy of your dated sales receipt for proof of warranty status should repairs be necessary.

## REFER ALL SERVICING TO ALESIS



We believe that the DG8 should provide years of trouble-free use. However, should problems occur, DO NOT attempt to service the unit yourself. Service on this product should be performed only by qualified technicians. THERE ARE NO USER-SERVICEABLE PARTS INSIDE.

## OBTAINING REPAIR SERVICE

Before contacting Alesis, check over all your connections, and make sure you've read the manual. Your Alesis dealer may be able to offer further assistance.

### Customers in the USA:

If the problem persists, copy down the serial number of your DG8 and call Alesis USA at 1-800-5-ALESIS and request the Technical Support Department. Talk the problem over with one of our technicians; if necessary, you will be given a return authorization (RA) number and instructions on how to return the unit to Alesis or the nearest authorized service center. All units must be shipped prepaid and COD shipments will not be accepted.

You must indicate the RA number on the shipping label or the shipment will not be accepted. If you do not have the original packing, ship the DG8 in a sturdy carton with shock-absorbing materials such as foam or "bubble-pack" surrounding the unit. Shipping damage caused by inadequate packing is not covered by the Alesis warranty. Ship the unit with insurance via a carrier that provides a tracking system.

Tape a note to the top of the unit describing the problem, include your name and a phone number where Alesis can contact you if necessary, as well as instructions on where you want the product returned. Alesis will pay for standard one-way shipping back to you on any repair covered under the terms of this warranty.

Field repairs are not authorized during the warranty period, and repair attempts by unqualified personnel may invalidate the warranty.

### Customers outside the USA:

Contact your local Alesis dealer for warranty assistance. Do not return products to the factory unless you have been given specific instructions to do so. Your warranty is valid only in the country of purchase.

### Internet Addresses:

Important information and advice is available on our web site:  
<http://www.alesis.com>

E-mail may be addressed to: [alecorp@alesis1.usa.com](mailto:alecorp@alesis1.usa.com)



# INDEX

- A**  
AC power ..... 19  
Alesis contact information ..... 4  
arrow buttons ..... 27  
    tutorial ..... 33–34  
audio outputs..... 51  
AutoDemos ..... 23
- B**  
Bass Banks, defined ..... 23, 32
- C**  
Card Bank, defined ..... 24, 32  
Card sounds  
    as Primary Programs..... 40  
    in a Layer  
        as both Primary and Layer ..... 41  
        as the Layer sound ..... 40  
        as the Primary Program ..... 41  
    in a Split  
        as both Primary and Split sound ..... 41  
        as the Primary Program ..... 41  
        as the Split sound..... 41  
    in a Split-with-Layer ..... 42  
    using the Alesis QCard..... 40  
CE Declaration of Conformity..... 13  
Chorus..... *See effects*  
Cleaning and maintenance..... 65  
connections..... 19  
    DG8 as MIDI master..... 20  
    DG8 as MIDI slave..... 21  
    DG8 with MIDI patchbay..... 22  
    pedals..... 49  
Continuous Controllers ..... 55  
cursor..... 27, 33
- D**  
DG8 setup  
    AC power ..... 19  
    basics ..... 17  
    music stand ..... 18  
    setting up in the home ..... 19  
    sustain pedal..... 19  
    unpacking..... 17  
    using in a music system..... 20  
    using with other equipment ..... 17  
DG8 sound chart ..... 43  
display..... 33
- E**  
effects..... 45
- F**  
factory defaults..... 52
- FCC information..... 12
- G**  
graphic equalizer ..... 29, 45
- I**  
initializing ..... 52
- K**  
Keyboard Banks, defined ..... 23, 31  
Keyboard Scaling function ..... 47
- L**  
LAYER LEVEL slider..... 27  
LAYER/OFF button..... 25, 37, 39, 40, 41  
Layers  
    defined ..... 25, 36, 61  
    tutorial..... 36–37
- M**  
Master Tune..... *See TUNE button*  
MIDI  
    Channel function ..... 29  
    Channel Mode Messages ..... 57  
    Channel Voice Messages..... 54  
    DG8 functions  
        Bass Sustain ..... 47  
        Channel messages  
            Basic Channel ..... 29, 46  
            Program Change commands ..... 59  
        Local Control..... 47  
        Sustain Catching..... 47  
    list of controller numbers..... 56  
    MIDI defined..... 53, 62  
MIDI Implementation chart  
    defined ..... 53  
    DG8 MIDI chart..... 67
- P**  
pedals  
    AUX Pedal assignment ..... 47  
    connections ..... 49  
    rocker pedals..... 50  
    sostenuto pedal..... 49  
    sustain pedal ..... 48  
    tutorial..... 48  
    volume and modulation pedals ..... 50  
PLAY button..... 27  
power-up reset function..... 52  
Primary Programs, defined ..... 25, 32, 35
- R**  
Reverb..... *See effects*

<b>S</b>	
Safety Instructions	
English .....	7
French .....	9
German .....	11
selecting sounds .....	35
SET SPLIT button.....	26, 39
Single mode, defined.....	25, 35
Sound Slection buttons .....	33
specifications.....	68
SPLIT LEVEL slider.....	27
SPLIT/OFF button.....	26, 39, 40, 41
Splits	
defined .....	26, 36
tutorial .....	36–39
Split-with-Layer	
defined .....	26
tutorial .....	39
sustain pedal .....	19
Sustain Pedal Catching.....	48
<b>T</b>	
TRANSPOSE button .....	28, 44
Troubleshooting.....	63
TUNE button.....	23, 28, 44
<b>U</b>	
unpacking .....	17
<b>V</b>	
VOLUME LEVEL slider .....	27
<b>W</b>	
Warranty information .....	69

## Free Manuals Download Website

<http://myh66.com>

<http://usermanuals.us>

<http://www.somanuals.com>

<http://www.4manuals.cc>

<http://www.manual-lib.com>

<http://www.404manual.com>

<http://www.luxmanual.com>

<http://aubethermostatmanual.com>

Golf course search by state

<http://golfingnear.com>

Email search by domain

<http://emailbydomain.com>

Auto manuals search

<http://auto.somanuals.com>

TV manuals search

<http://tv.somanuals.com>