

# **Agilent U2121A-101 RF Switch Driver Board**

## **Operating Guide**



**Agilent Technologies**

## Notices

© Agilent Technologies, Inc. , 2008

No part of this manual may be reproduced in any form or by any means (including electronic storage and retrieval or translation into a foreign language) without prior agreement and written consent from Agilent Technologies, Inc. as governed by United States and international copyright laws.

### Manual Part Number

U2931-90001

### Edition

Second Edition, June 6, 2008

Agilent Technologies, Inc.  
3501 Stevens Creek Blvd.  
Santa Clara, CA 95052 USA

### Trademark Acknowledgements

Pentium is a U.S. registered trademark of Intel Corporation.

Microsoft, Visual Studio, Windows, and MS Windows are trademarks of Microsoft Corporation in the United States and/or other countries.

### Warranty

**The material contained in this document is provided “as is,” and is subject to being changed, without notice, in future editions. Further, to the maximum extent permitted by applicable law, Agilent disclaims all warranties, either express or implied, with regard to this manual and any information contained herein, including but not limited to the implied warranties of merchantability and fitness for a particular purpose. Agilent shall not be liable for errors or for incidental or consequential damages in connection with the furnishing, use, or performance of this document or of any information contained herein. Should Agilent and the user have a separate written agreement with warranty terms covering the material in this document that conflict with these terms, the warranty terms in the separate agreement shall control.**

### Technology Licenses

The hardware and/or software described in this document are furnished under a license and may be used or copied only in accordance with the terms of such license.

### Restricted Rights Legend

U.S. Government Restricted Rights. Software and technical data rights granted to the federal government include only those rights customarily provided to end user customers. Agilent provides this customary commercial license in Software and technical data pursuant to FAR 12.211 (Technical Data) and 12.212 (Computer Software) and, for the Department of Defense, DFARS 252.227-7015 (Technical Data - Commercial Items) and DFARS 227.7202-3 (Rights in Commercial Computer Software or Computer Software Documentation).

### Safety Notices

#### CAUTION

A **CAUTION** notice denotes a hazard. It calls attention to an operating procedure, practice, or the like that, if not correctly performed or adhered to, could result in damage to the product or loss of important data. Do not proceed beyond a **CAUTION** notice until the indicated conditions are fully understood and met.

---















#### WARNING

A **WARNING** notice denotes a hazard. It calls attention to an operating procedure, practice, or the like that, if not correctly performed or adhered to, could result in personal injury or death. Do not proceed beyond a **WARNING** notice until the indicated conditions are fully understood and met.

---

## Safety Symbols

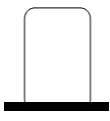
The following symbols on the instrument and in the documentation indicate precautions, which must be taken to maintain safe operation of the instrument.

	Direct current (DC)		Equipment protected throughout by double insulation or reinforced insulation
	Alternating current (AC)		Off (supply)
	Both direct and alternating current		On (supply)
	Three-phase alternating current		Caution, risk of electric shock
	Earth (ground) terminal		Caution, risk of danger (refer to this manual for specific Warning or Caution information)
	Protective conductor terminal		Caution, hot surface
	Frame or chassis terminal		Out position of a bi-stable push control
	Equipotentiality		In position of a bi-stable push control

## General Safety Information

### WARNING

- **Do not load the output terminals above the specified current limits.**
  - **Do not use the device if it appears damaged or defective.**
  - **Observe all markings on the device before connecting any wiring to the device.**
  - **Do no operate the device in the presence of flammable gases or fumes.**
  - **Do no install substitute parts or perform any unauthorized modification to the device.**
- 

### CAUTION

- Applying excessive voltage or overloading the device will cause irreversible damage to the circuitry.
  - Use the device with the cables provided.
  - Repair or service that is not covered in this manual should only be performed by qualified personnels.
  - To avoid ESD damage to the RF switch driver board, users are highly recommended to comply with the following cautions:
    - User are required to discharge themselves to any large metal object (e.g. Shelf, desk, etc.) prior to operating the RF switch driver board.
    - Operate the RF switch driver board under an ESD protected workstation, with the minimum requirements of using wrist strap (connected to ground) and ESD pad. The wrist strap can be grounded by connecting to the power supply ground and/or circuit board ground.
  - Avoid human body contact or a charged material to the on-board components and circuitries. Always hold the board edges when carrying the RF switch driver board.
-

## Environmental Conditions

This instrument is designed for indoor use and in an area with low condensation. The table below shows the general environmental requirements for this instrument.





Environmental conditions	Requirements
Operating temperature	0 °C to 40 °C
Storage temperature	-40 °C to 70 °C
Operating humidity	Up to 85% at 40 °C (non-condensing)
Storage humidity	5% to 90% RH (non-condensing)

### CAUTION

The U2121A-101 RF switch driver board complies with the following safety and EMC requirements.

- IEC 61326-2002/EN 61326:1997+A1:1998+A2:2001+A3:2003
- Canada: ICES-001:2004
- Australia/New Zealand: AS/NZS CISPR11:2004
- IEC 61010-1:2001/EN 61010-1:2001 (2nd edition)

## Regulatory Markings

	<p>The CE mark is a registered trademark of the European Community. This CE mark shows that the product complies with all the relevant European Legal Directives.</p>		<p>The C-tick mark is a registered trademark of the Spectrum Management Agency of Australia. This signifies compliance with the Australia EMC Framework regulations under the terms of the Radio Communication Act of 1992.</p>
<p><b>ICES/NMB-001</b></p>	<p>ICES/NMB-001 indicates that this ISM device complies with the Canadian ICES-001. Cet appareil ISM est conforme a la norme NMB-001 du Canada.</p>		<p>This instrument complies with the WEEE Directive (2002/96/EC) marking requirement. This affixed product label indicates that you must not discard this electrical/electronic product in domestic household waste.</p>
 <p><b>ESD</b></p>	<p>This symbol indicates that a device, or part of a device, may be susceptible to electrostatic discharges (ESD), which can result in damage to the product. Observe ESD precautions given on the product, or its user documentation, when handling equipment bearing this mark.</p>		

## Waste Electrical and Electronic Equipment (WEEE) Directive 2002/96/EC

This instrument complies with the WEEE Directive (2002/96/EC) marking requirement. This affixed product label indicates that you must not discard this electrical/electronic product in domestic household waste.

Product Category:

With reference to the equipment types in the WEEE directive Annex 1, this instrument is classified as a "Monitoring and Control Instrument" product.

The affixed product label is shown as below.



**Do not dispose in domestic household waste**

**To return this unwanted instrument, contact your nearest Agilent Technologies, or visit:**

**[www.agilent.com/environment/product](http://www.agilent.com/environment/product)**

for more information.



**Agilent Technologies**

**DECLARATION OF CONFORMITY**  
According to EN ISO/IEC 17050-1:2004



**Manufacturer's Name:** Agilent Technologies Microwave Products (M) Sdn. Bhd  
**Manufacturer's Address:** Bayan Lepas Free Industrial Zone,  
11900, Bayan Lepas, Penang, Malaysia

**Declares under sole responsibility that the product as originally delivered**

**Product Name:** Agilent RF Switch Board  
**Models Number:** U2931A  
**Product Options:** This declaration covers all options of the above product(s)

**complies with the essential requirements of the following applicable European Directives, and carries the CE marking accordingly:**

Low Voltage Directive (2006/95/EC)  
EMC Directive (2004/108/EC)

**and conforms with the following product standards:**

EMC	Standard	Limit
	IEC 61326:2002 / EN 61326:1997+A1:1998+A2:2001+A3:2003	
	CISPR 11:1990 / EN55011:1990	Class A Group 1
	IEC 61000-4-2:1995 / EN 61000-4-2:1995	4 kV CD, 8 kV AD
	IEC 61000-4-3:1995 / EN 61000-4-3:1996	3 V/m, 80-1000 MHz
	IEC 61000-4-4:1995 / EN 61000-4-4:1995	0.5 kV signal lines, 1 kV power lines
	IEC 61000-4-5:1995 / EN 61000-4-5:1995	0.5 kV line-line, 1 kV line-ground
	IEC 61000-4-6:1996 / EN 61000-4-6:1996	3 V, 0.15-80 MHz
	IEC 61000-4-11:1994 / EN 61000-4-11:1994	1 cycle / 100%

Canada: ICES-001:2004  
Australia/New Zealand: AS/NZS CISPR11:2004

The product was tested in a typical configuration with Agilent Technologies test systems.

**Safety** IEC 61010-1:2001 / EN 61010-1:2001

**Additional Information:**  
**The U2931A receives power from an AC/DC power supply model DSA-60W-20 1 24060.**

**This DoC applies to above-listed products placed on the EU market after:**

31-March-2008  
Date

**Tay Eng Su**  
Quality Manager

For further information, please contact your local Agilent Technologies sales office, agent or distributor,  
or Agilent Technologies Deutschland GmbH, Herrenberger Straße 130, 71034 Böblingen, Germany.

Template: A5971-5302-2, Rev. E

U2931A

DoC Revision 1.0



## Product Regulations

### EMC

IEC 61326-1:2002 / EN 61326-1:1997+A1:1998+A2:2001+A3:2003

### Performance Criteria

CISPR 11:1990 / EN 55011:1990 – Group 1 Class A	
IEC 61000-4-2:1995 / EN 61000-4-2:1995 (ESD 4kV CD, 8kV AD)	A
IEC 61000-4-3:1995 / EN 61000-4-3:1996 (3V/m, 80% AM)	A
IEC 61000-4-4:1995 / EN 61000-4-4:1995 (EFT 0.5kV line-line, 1kV line-earth)	A
IEC 61000-4-5:1995 / EN 61000-4-5:1995 (Surge 0.5kV line-line, 1kV line-earth)	A
IEC 61000-4-6:1996 / EN 61000-4-6:1996 (3V, 0.15–80 MHz, 80% AM, power line)	A
IEC 61000-4-11:1994 / EN 61000-4-11:1994 (Dips 1 cycle, 100%)	A
Canada: ICES-001:2004	
Australia/New Zealand: AS/NZS CISPR11:2004	

**Safety** IEC 61010-1:2001 / EN 61010-1:2001

### Additional Information:

The product herewith complies with the essential requirements of the Low Voltage Directive 2006/95/EC and the EMC Directive 2004/108/EC and carries the CE Marking accordingly (European Union).

### Performance Criteria:

- A Pass - Normal operation, no effect.
- B Pass - Temporary degradation, self recoverable.
- C Pass - Temporary degradation, operator intervention required.
- D Fail - Not recoverable, component damage.
- N/A – Not applicable

### Notes:

#### **Regulatory Information for Canada**

ICES/NMB-001:2004

This ISM device complies with Canadian ICES-001.

Cet appareil ISM est conforme à la norme NMB-001 du Canada.

#### **Regulatory Information for Australia/New Zealand**

This ISM device complies with Australian/New Zealand AS/NZS CISPR11:2004

 **N10149**



# Contents

Introduction	2
Standard Purchase Items Checklist	4
Product at a Glance	5
Product outlook	5
Product dimensions	6
Connector Pins Configuration	7
Installation Guide	10
A. Check your system	11
B. Install prerequisites and software	12
C. Connect the hardware solution to your PC	14
D. Launch the Agilent U2121A-Based RF Switch Driver Software	15
Supported Switches	19
Product Characteristics and Specifications	21
Maintenance	23
Disassemble Procedure	24
Ordering Info	26
Optional accessory	26
Appendix A: Control Instructions	29
Appendix B: Y1157A Cable Assembly Instructions	31

# Introduction

The Agilent U2121A-101 (also known as U2931A) RF switch driver with cable is an adapter board designed for use with the Agilent U2121A digital IO device. It enables you to control various types of RF switches easily and has enhanced driving capability and consists of different types of connectors to suit different switches.

The U2121A-101 purchase consists of a driver interface module, an interface cable (equipped with a 37-pin D-sub connector on one end and four 10-way terminal block connectors on the other end), a 10-pin to D-sub adapter, and a 24 VDC, 2.5 A power adapter. This module is connected to the U2121A using the provided interface cable. You can also use the Y1157A<sup>[1]</sup> cable, which is a 10-pin ribbon connector to 9-pin D-Sub cable kit for the Agilent N1810/11/12 coaxial switches.

This module is consists of five RF switch driver channels and one general IO terminal. Each channel is pre-programmed to drive three different types of Agilent RF switches. Only one type of RF switch can be connected to a single channel during operation.

## CAUTION

**DO NOT** connect different types of RF switches to the same channel during operating time.

---

The U2121A-101 module is designed to handle 24 VDC switches.

[1] Refer to Appendix B for Y1157A cable kit assembly.

### **Power supply**

The switches on this module are powered by the provided power adapter. There is only one power supply voltage available for this module, which is 24 VDC, 2.5 A.

### **Power consumption**

The U2121A-101 can drive up to 1500 mA continuously using the provided power supply. For each channel, it is able to drive up to 300 mA load per switch. Precaution must be taken to ensure that the total current consumption on all channels is not more than 1500 mA, which is the maximum driving capability of the module.

## Standard Purchase Items Checklist

Verify that you have received the following items with your purchase. U2121A-101 RF switch driver board with cable purchase. If anything is missing or damaged, please contact the nearest Agilent Sales Office.

- ✓ RF switch driver board
- ✓ RF switch driver board interface
- ✓ U2931-60013 10 ways IDC to 9-pins D-Sub adapter
- ✓ U2931-60012 power adapter
- ✓ Agilent U2121A-101 RF Switch Driver Board Operating Guide
- ✓ Agilent U2931A RF Switch Driver Product Reference CD-ROM

# Product at a Glance

## Product outlook

Top view (without casing)

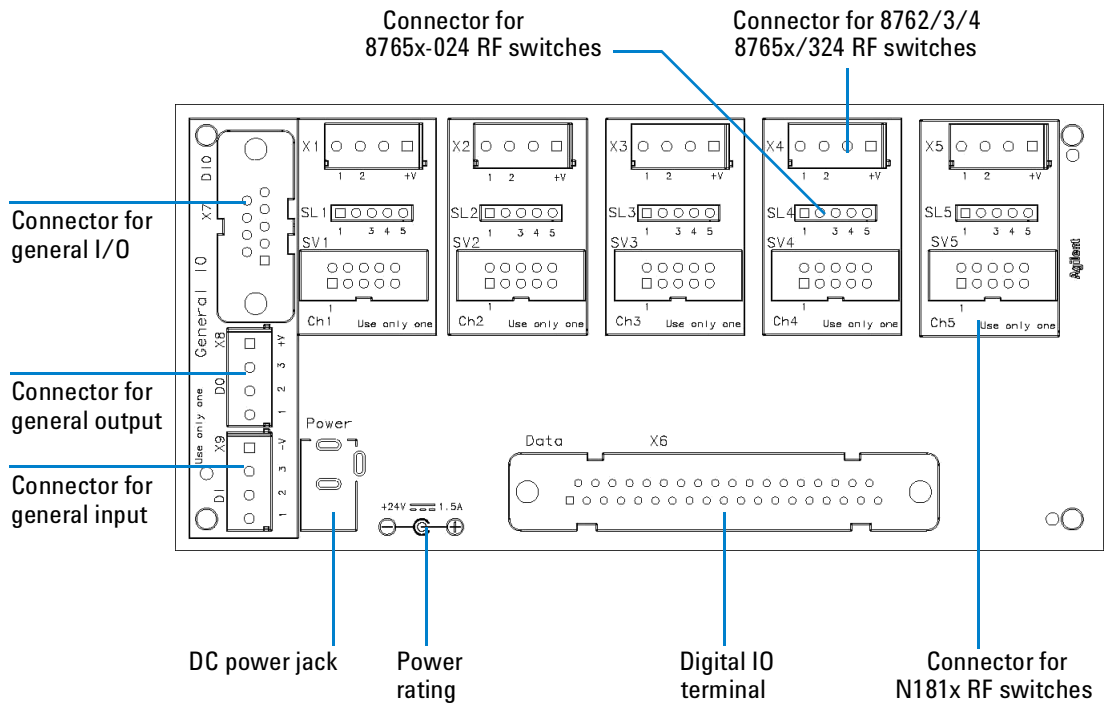

# Product dimensions

## Top view (without casing)

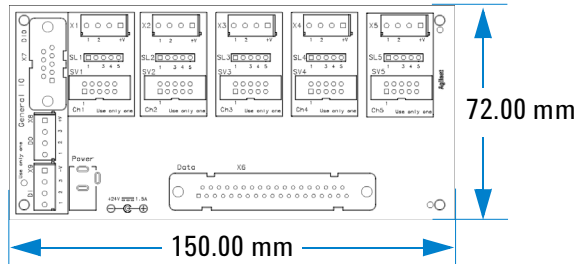

## Top view (with casing)

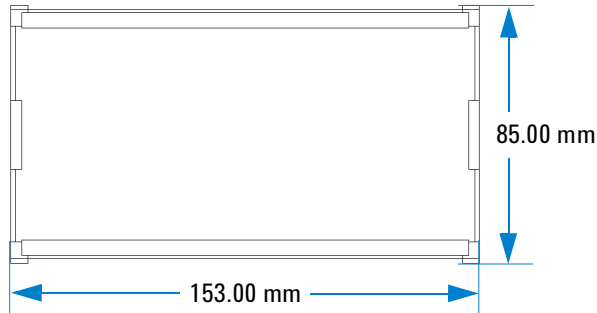

## Front view (with casing)

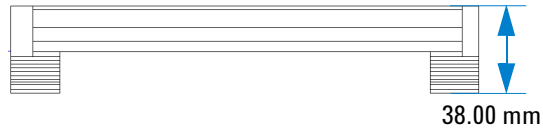

## Side view (with casing)

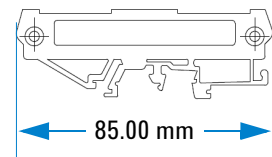



# Connector Pins Configuration

## Pin out configuration for all terminals

**Table 1** 8762/2/3 and 8765x-324 Series switches (X1 to X5)

Pin	Function
1	Position #1
2	Position #2
3	N.C.
4	+24 V

**Table 2** 8765x-024 Series switches (SL1 to SL5)

Pin	Function
1	Position #2
2	N.C.
3	+24 V
4	+24 V
5	Position #1

**Table 3** N181X Series switches (SV1 to SV5)

Pin	Function	Pin	Function
1	GND	2	+5 V
3	N.C.	4	Indicator B
5	Position B	6	+5 V
7	Position A	8	Indicator A
9	+24 V	10	N.C.

## IO mapping

There are three main control bits used in the U2121A-101 as shown in tables below. These control bits also refers to the U2121A control bit status.

**Table 4** Output enable/disable control

Control Stage	Control Bit, D014	Description
Output disabled	OFF (0)	To disable all outputs in U2121A- 101
Output enabled	ON (0)	To enable all outputs in U2121A- 101

**Table 5** Position information read back control

RF Switches	Control Bit		Description
	D16	D15	
8765x and 8762/3/4	OFF (0)	ON (1)	Read position information from 8765x and 8762/3/4 series switches
N181x	ON (1)	OFF (0)	Read position information from N181x series switches

### **WARNING**

**DO NOT set both D15 and D16 control bits to ON stage!**

Each of the five RF switch channels uses two digital output pins and two digital input pins during the operation.

**Table 6a** IO mapping for 8762/3/4, 8765x-324 and N181x Series RF switches

Channel	Control Bit		Position Bit	
	State A	State B	State A	State B
1	01	02	I1	I2
2	03	04	I3	I4
3	05	06	I5	I6
4	07	08	I7	I8
5	09	010	I9	I10
General IO	011, 012 & 013		I11, I12 & I13	

**Table 6b** IO mapping for 8765x-024 Series RF switches

Channel	Control Bit		Position Bit	
	State A	State B	State A	State B
1	02	01	I2	I1
2	04	03	I4	I3
3	06	05	I6	I5
4	08	07	I8	I7
5	010	09	I10	I9
General IO	011, 012 & 013		I11, I12 & I13	

**Table 7** Position indicator stage definition

RF Switches Model	Activated	Deactivated
8732/3/4 Series and 875x Series	OFF (0)	ON (1)
N181x Series	ON (1)	OFF (0)

# Installation Guide

Follow the step-by-step instructions shown in the following flowchart to get started with the preparations and installations of your Agilent U2121A-Based RF Switch Driver Software.

## NOTE

You need to install the IVI-COM driver if you are going to use the U2121A-101 with Agilent VEE Pro, LabVIEW, or Microsoft® Visual Studio®.

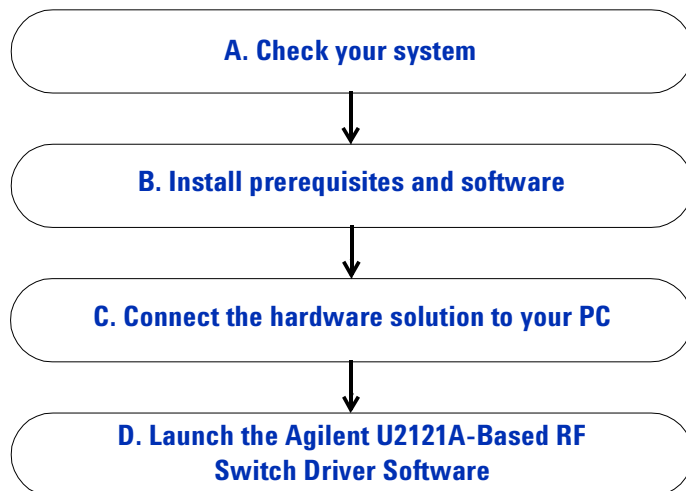

## A. Check your system

Prior to any installation or configuration, please ensure that your PC meets the following minimum system requirements.

### Hardware requirements

Hardware required	Specification (minimum)
Processor	1.6 GHz Pentium® IV or higher
Operating System	Windows® XP Professional or Home Edition (Service Pack 1 or later), or Windows® 2000 Professional (Service Pack 4 or later)
Video	1024×768 recommended
Browser	Microsoft® Internet Explorer 5.01 or higher (6.0 or higher recommended)
Available RAM	128 MB or higher (256 MB or higher recommended)
Hard Disk Space	1 GB required for installation

### Software requirements

Software required	Version (minimum)
Agilent VEE Pro Runtime	Version 8.5 <sup>[1]</sup>
Agilent U2121 IVI Driver	Version 1.0.9.0 <sup>[1]</sup>
Agilent IO Libraries Suite	Version 15.0 <sup>[2]</sup> or higher
Microsoft® .NET Framework	Version 1.1 and 2.0 <sup>[1]</sup>

#### NOTE

Agilent IO Libraries Suite 15.0 is required if your PC is running on Microsoft® Windows Vista™ 32-bit operating system.

[1] Bundled with Agilent U2121A-Based RF Switch Driver Software installer.

[2] Obtained from Agilent Automation-Ready CD.

## B. Install prerequisites and software

There are two options you may choose from to install the prerequisites and Agilent U2121A-Based RF Switch Driver Software. You may choose to install from the provided Product Reference CD-ROM or obtain the installation software from Agilent's website to install the software.

### NOTE

Prior to installing the prerequisites and Agilent U2121-Based RF Switch Driver Software, ensure that your PC meets the minimum system requirements for installation and operation processes.

### Installing the application software from CD

- 1 Disconnect any instrument that is connected to your PC and close all other applications on your PC.
- 2 Insert the *Product Reference CD-ROM* into your CD-ROM drive.
- 3 The installer will automatically launch the Agilent U2121A-Based Installation Menu. Click **Application** to begin installation of the following items:
  - i Microsoft .NET Framework 2.0
  - ii Agilent VEE Pro 8.5 Runtime
  - iii Agilent U2121 IVI Driver
  - iv Agilent U2121A-Based RF Switch Driver Software

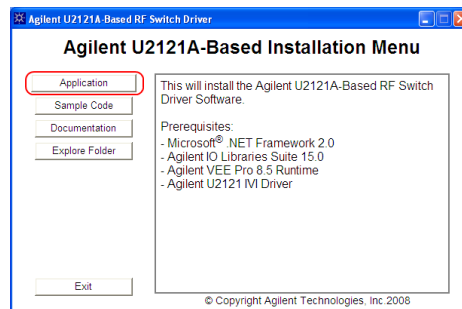

- 4 If the installation menu does not appear after a few seconds, go to **Start > Run** and type <drive>:\Application\setup.exe where <drive> is your CD-ROM drive location.
- 5 Click **OK** to begin the installation of the following items.
- 6 If you do not have any of the prerequisites installed, the **InstallShield Wizard** software prerequisite will appear.
- 7 Click **OK** to begin the installation of the listed missing prerequisites.
- 8 Once the above installation has completed, installation of the U2121A-Based RF Switch Driver Software will proceed as normal.
- 9 The **Agilent RF Switch Driver InstallShield Wizard** dialog will appear. Click **Next** to begin.
- 10 Read the License Agreement and select **I accept the terms in the License Agreement** to proceed. You may click **Print** to print a hardcopy of the Agilent License Terms for your reference. Click **Next** to proceed.
- 11 Fill in the Customer Information Form accordingly, and click **Next**.
- 12 Click **Next** to install to the specified folder or click **Change** to install to a different folder.
- 13 Click **Install** to begin the installation of the U2121A-Based RF Switch Driver Software.
- 14 Click **Finish** when the installation has completed.
- 15 A shortcut to this software will be created to your desktop.

#### NOTE

USING THE LICENSED MATERIALS INDICATES YOUR ACCEPTANCE OF THE LICENSE TERMS. IF YOU DO NOT AGREE TO ALL OF THESE TERMS, YOU MAY RETURN ANY UNOPENED LICENSED MATERIAL FOR A FULL REFUND, IF THE LICENSED MATERIALS ARE BUNDLED OR PRE-LOADED WITH ANOTHER PRODUCT, YOU MAY RETURN THE ENTIRE UNUSED PRODUCT FOR A FULL REFUND.

---

#### Downloading the application software from the Web

- 1 Go to <http://www.agilent.com/find/DIOsolution/>, and download the Agilent U2121A-Based RF Switch Driver Software.
- 2 Save the file to any location on your hard disk.

- 3 Disconnect any instrument that is connected to your PC and close all other applications on your PC.
- 4 Double-click the saved installation file to begin installation.
- 5 If you do not have any of the prerequisites installed, the **InstallShield Wizard** software prerequisite will appear.
- 6 Click **OK** to begin the installation of the listed missing prerequisites.
- 7 Once the above installation has completed, installation of the Agilent U21210A-BASed RF Switch Driver Software will proceed as normal.
- 8 Follow the instructions on your screen to begin the installation.
- 9 Click **Finish** once the installation has completed.

## C. Connect the hardware solution to your PC

- 1 Connect the U2121A-101 board digital IO terminal to the U2121A terminal block using the interface cable.
- 2 Connect the power adapter to the RF switch driver board's DC power jack.
- 3 Connect the RF switches as below:
  - i For 8762/3/4 and 8765x-324 RF switches, connect to any SL1<sup>[1]</sup> to SL5<sup>[1]</sup> slot.
  - ii For 8765x-024 RF switches, connect to any X1<sup>[2]</sup> to X5<sup>[2]</sup> slot.
  - iii For N181x RF switches, connect to any SV1<sup>[3]</sup> to SV5<sup>[3]</sup> slot.

### NOTE

Connect only one type of the RF switch to one channel. Do not use multiple switches simultaneously on one channel.

- 4 Connect other types of load to general IO, X7<sup>[4]</sup> or X8<sup>[5]</sup> and X9<sup>[6]</sup> if required. The load voltage is 24 VDC. The maximum load should not exceed 300 mA per output channel and 3 mA per input channel.



## WARNING

The total allowable current is 1500 mA. Please ensure that the total current consumption is not more than 1500 mA.

---

[1] SL1 to SL5 refers to the 8762/3/4 and 8765x-324 RF switch connectors for Ch1 to Ch5.

[2] X1 to X5 refers to the 8765x-024 RF switch connectors for Ch1 to Ch5.

[3] SV1 to SV5 refers to the N181x RF switch connectors for Ch1 to Ch5.

[4] X7 refers to the connector for general I/O on the switch driver board.

[5] X8 refers to the connector for general output on the switch driver board.

[6] X9 refers to the connector for general input on the switch driver board.

## D. Launch the Agilent U2121A-Based RF Switch Driver Software

### NOTE

Before you proceed, ensure that your system meets the minimum system requirements.

---

- 1 Before attempting to start-up your U2121A-Based RF Switch Driver Software, it is recommended to follow the step-by-steps instructions below.
- 2 Plug in your instrument via the supported USB socket.
- 3 Go to **Start > All Programs > Agilent IO Libraries Suite > Agilent Connection Expert** to launch the Connection Expert.
- 4 The detected U2121A will be visible on the **Instrument I/O on this PC** explorer pane. Right-click on the U2121A instrument on the explorer pane.
- 5 A context menu will appear as shown below. Select **Send Commands To This Instrument**.



- 6 The *Agilent Interactive IO* dialog box will appear. Click **Send & Read** to send the \*IDN? default command. The instrument's response should appear in the **Instrument Session History** panel.



- 7 If the Connection Expert can successfully communicate with the U2121A, this indicates that the instrument has been installed correctly.

#### NOTE

- The IO Control will launch automatically when you start your PC.
- Launching the VEE without the IO Control running will cause failure of the VEE to detect or establish any connection with the U2121A connected to your PC.
- To run the IO Control, go to **Start > All Programs > Agilent IO Libraries Suite > Utilities > IO Control**.

8 Double-click **Agilent U2121A-Based RF Switch Driver Software** icon on your desktop or go to **Start > All Programs > Agilent U2121A-Based RF Switch Driver > U2121A-Based RF Switch Driver Software** to launch the software.

9 The U2121A-Based RF Switch Driver Software screen will appear.

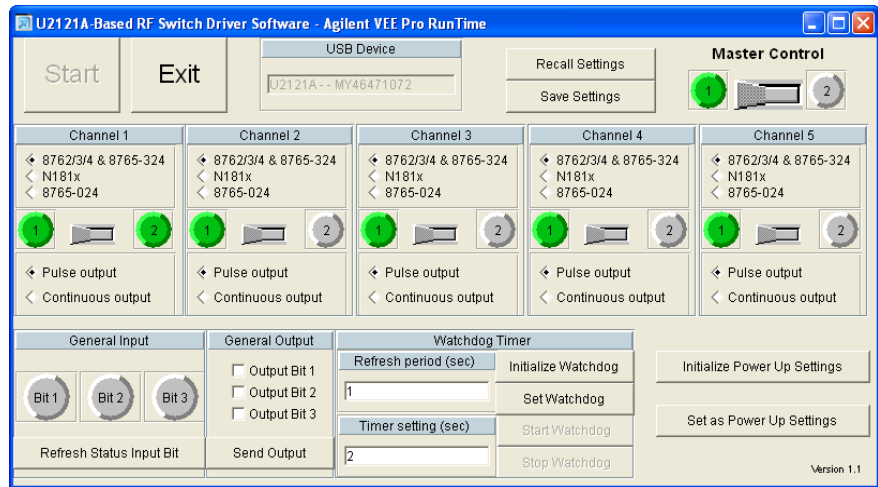

10 To start the application, click on the **Start** button. The **Select USB Device** dialog box will appear displaying the connected U2121A devices. Select a U2121A device and click on it to establish the connection.

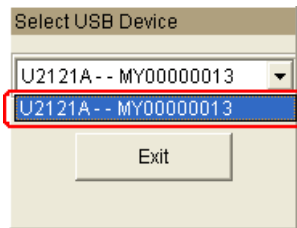

11 Select the switch type corresponding to the connected switch on each channel.

- 12** Use the toggle paddle for each channel in the program to select respective switch position.
- 13** Use the checkbox and the **Send Output** button in the General Output section to control the output devices connected to the RF switches.
- 14** To view the General Input Status, click the **Refresh Input Status Bits** button in the General Input section.
- 15** Click **Exit** to leave the program, all switches will be disabled upon exiting the program.

**NOTE**

Refer to the *Agilent U2121A-Based RF Switch Driver Software Help File* for more information.

---

# Supported Switches

The U2121A-101A supports three types of Agilent RF switches as shown in [Table 9](#). User can choose to drive the same switches in all five channels or a mixture of three switches for five channels. However, only one type of switch can be used in a channel at a time. Do not use multiple types of switches in the same channel.

## Drive modes

The RF switch driver board drives the switches using the open collector drive method. It provides a current path to the ground when asserted.

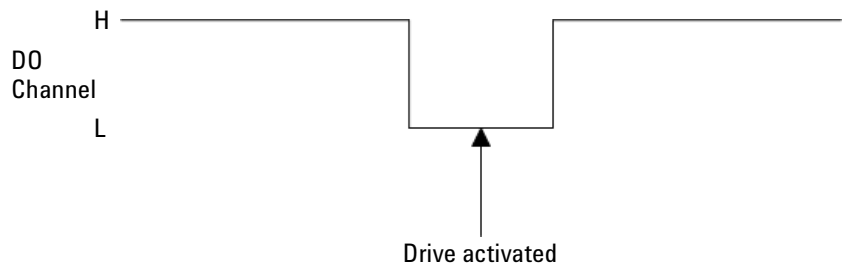

## Continuous Drive

Continuous drive method controls the switches by activating the control bit and holds it until it is disabled. This mode will have a consistent current draw when the switch is activated.

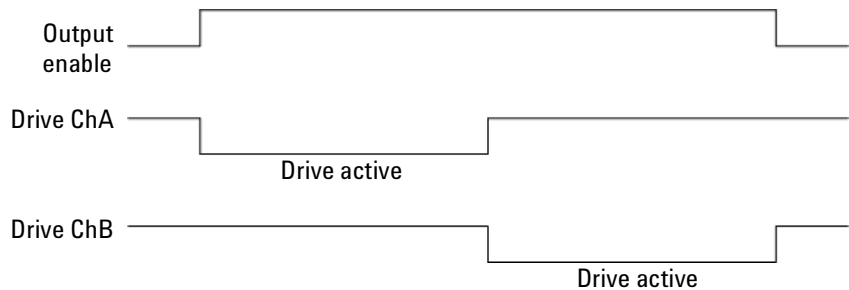

### Pulse drive

Pulse drive method controls the switches using a ~30 ms pulse. As shown in the figure below, the control signal is applied to one of the control bit and held for the preset time.

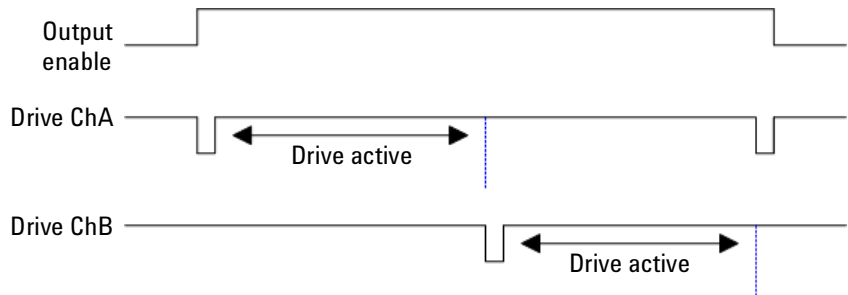

### General IO

There are three digital outputs and three digital inputs available in the U2121A-101 as an auxiliary port. These three output pins are capable to drive up to 300 mA of load. The digital input pin has a direct connection to the U2121A.

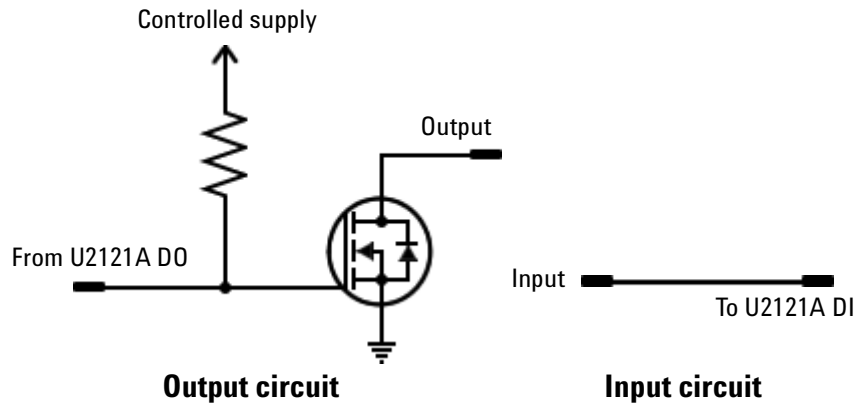

# Product Characteristics and Specifications

**Table 8** General characteristics of the U2121A-101 RF switch driver board

<b>General Characteristics</b>	
Power consumption	<ul style="list-style-type: none"><li>• +24 VDC, 2.5 A</li><li>• Isolated ELV supply source</li></ul>
Operating environment	0 °C to 40 °C
Storage temperature	-40 °C to 70 °C
Operating humidity	Up to 85% at 40 °C (non-condensing)
Storage humidity	5% to 90% RH (non-condensing)
EMC	<ul style="list-style-type: none"><li>• IEC61326-2002/EN61326:1997+A1:1998+A2:2001+A3:2003</li><li>• Canada: ICES-001:2004</li><li>• Australia/New Zealand: AS/NZS CISPR11:2004</li></ul>
Safety	IEC 61010-1:2001/EN 61010-1:2001 (2nd edition)
Driving current per channel	300 mA (max)
Total current	1500 mA (max)
IO channels for RF switch	5 channels
Generic IO	3 digital inputs and 3 digital outputs
Board dimension (W x D)	150 mm x 72 mm
Casing dimension (W x D x H)	153 mm x 85 mm x 38 mm
Weight	<ul style="list-style-type: none"><li>• With casing: 146 g</li><li>• Without casing: 86 g</li></ul>
Warranty	One year

**Table 9** Type of switches supported by U2121A-101 RF switch driver board

Switch/Attenuator	Reference Document No.	Coil Voltage	Connection Type	Drive Options
<b>Agilent N1810/11/12 Coaxial Switches</b>				
N1810UL/TL N1811TL N1812TL	5968-9653E	Option 124 24 VDC	Option 201 D-Sub 9-pin female	Option 402 Position Indicators
<b>Agilent 8762/63/64 Coaxial Switches</b>				
8762A/B/C/F 8763A/B/C 8764A/B/C	5952-1873E	Option 024 24 VDC	Solder Lugs	STD Direct coil for open drain
<b>Agilent Microwave SPDT Switches</b>				
8765A/B/C/D	5952-2231E	Option 324 24VDC	Solder Terminals	STD Direct coil for open drain
8765A/B/C/D	5952-2231E	Option 024 24 VDC	Ribbon cable terminated with single in-line	STD Direct coil for open drain



## Maintenance

- 1 Power off your device, unplug the DC power jack and remove the RF switch driver board interface cable from your device.
- 2 Remove your device from the plastic casing.
- 3 Shake out any dirt that may have accumulated on the RF switch driver board.
- 4 Wipe your RF switch driver board with a dry cloth and install the plastic casing back in place.

## Disassemble Procedure

The following steps shows the disassemble procedure of the RF switch driver board from its casing.

- 1 Remove the two screws on either side of the board.

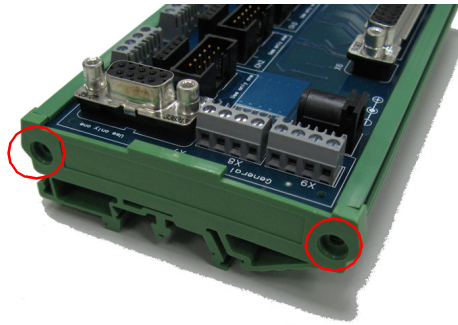

- 2 Remove the side panel from the casing.

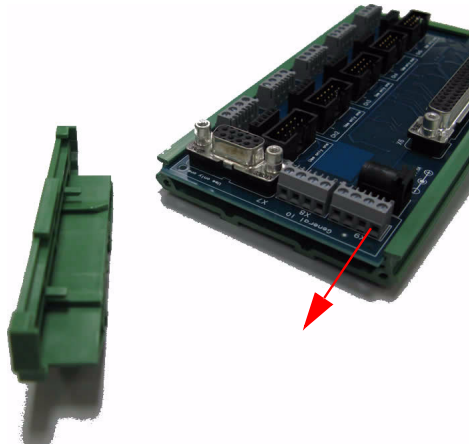

**3** Remove the PCA from the casing.

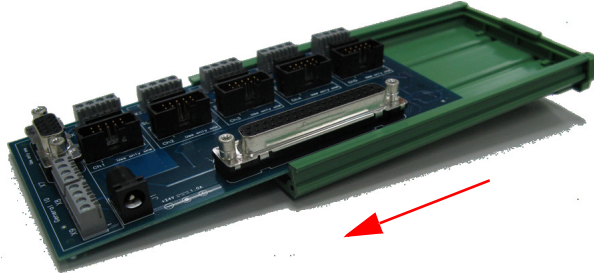

**4** The disassembled RF switch driver board is shown below.

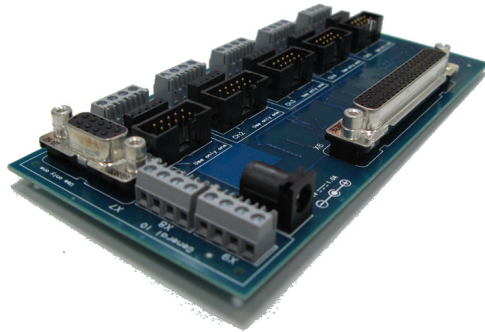

## Ordering Info

To order the U2931A RF switch driver, please select the U2121A and U2121A-101 ordering options. This will include the U2121A digital IO device and U2121A-101 RF switch driver board and cable. You can also order the U2931A RF switch driver board as a standalone unit by choosing the U2931A-101 ordering option.

**Table 10** RF switch driver board ordering options

	Ordering Option (with U2121A)	Ordering Option (as standalone)	Description
1	U2121A-01	U2931A-101	U2121A-101 RF switch driver board
2		U2931A-102	U2121A-101 RF switch driver board cable

## Optional accessory

**Table 11** RF switch driver board optional accessory

	Ordering Options	Description
1	Y1157A	9-to-10 pin extension cable for N181x — supplies to build 4 cables

## Appendix A: Control Instructions

The COM driver minimum system requirements are as shown below.

<b>Minimum System Requirements</b>	
PC hardware	450 MHz Pentium II or higher, 128 MB RAM, 40 GB hard disk space, CD-ROM drive.
Operating system	Windows® XP Professional or Home Edition, Service Pack 1 or later, Windows® 2000 Professional, Service Pack 4 or later.
Software driver	IVI-COM
Compatible with programming environments	<ul style="list-style-type: none"><li>• Agilent VEE</li><li>• Microsoft® Visual Studio.NET, C/C++</li><li>• Microsoft® Visual Basic 6/7</li><li>• LabVIEW</li></ul>

Please adhere to the following instructions strictly to create the COM driver.

### To read digital input information.

- 1 When reading digital input, set the desired channel to **ON** (1) and then read the target bit. Set the channel back to **OFF** (0) when the information has been read.
- 2 Do not activate both Ch15 and Ch16 at the same time because this will cause an excessive current flow; which will result in a sudden temperature increase in the buffer IC and regulator IC.

#### NOTE

Prolonged exposure to increased temperature will cause overheating in your buffer IC and regulator IC.

### To set digital output.

- 1 To enable digital output control, set Ch14 to **ON** (1).
- 2 For channel 1 to channel 5, only activated one bit at a time. Do not activate both bits together because this will damage your RF switches.
- 3 Some RF switches will need pulse current control instead of continuous current control. Please refer to the respective RF switches' datasheets for more information. The wrong control method will lead to RF switch damage.

#### NOTE

- Prolonged exposure to a continuous supplied current will cause overheating in your RF switch. Please ensure your devices temperatures are constantly monitored when supplying continuous current.
  - Refer to the *Agilent U2121A-Based RF Switch Driver COM Object Help File* for more information.
-

## Appendix B: Y1157A Cable Assembly Instructions

The Y1157A is a 10-pin ribbon connector to 9-pin D-Sub cable kit which contains materials to build four cables.

The key to building the cables correctly is to understand the orientation of the socket pins on the distribution boards and the pin number orientation of the cable connectors. This orientation is shown in [Figure B-1](#). When using the D-sub connector, always refer to the pin orientation shown in [Figure B-1](#). Do not use the pin numbers printed on the part.

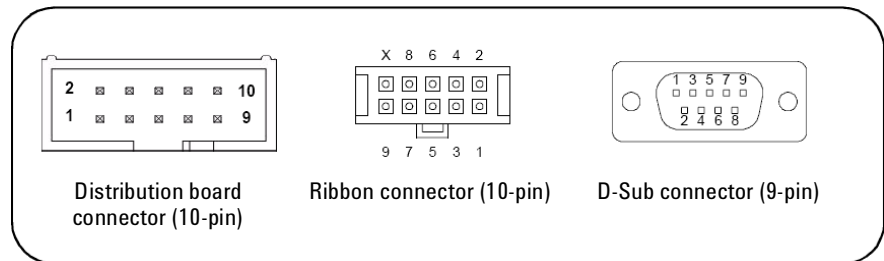

**Figure B-1** Distribution board socket and Y1157A cable connector Orientation

The steps for building the cables are as follows:

- 1 Cut the ribbon cable slightly longer than the desired length.
- 2 Position the D-Sub connector and the ribbon cable connector as shown in [Figure B-2](#). Route the cable **through** the connectors, noting the location of cable pin 1. By convention, pin 1 is indicated in red (the dark line in the drawing).

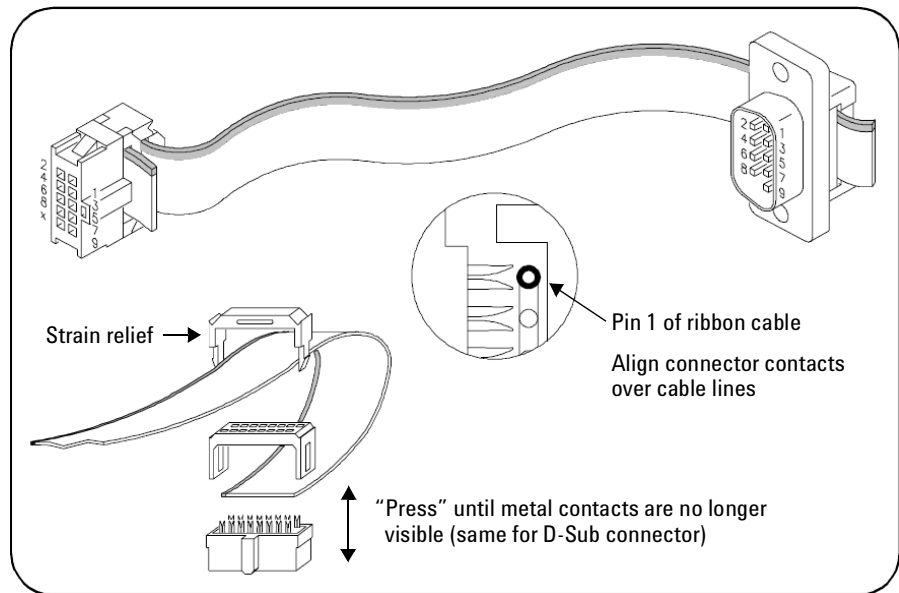

**Figure B-2** Y1157A connector orientation and ribbon cable routing

- 3 Move the connectors to the ends of the cable, allowing for some overlap on the D-Sub connector end and strain relief on the ribbon cable connector end. **Note the orientation of the connectors and cable in Figure B-2.**
- 4 Align the metal contacts of the ribbon connector over cable pin 1 (Figure B-2) and the other pins, press the ribbon cable connector onto the cable using a vise or clamp to press the contacts **evenly** through the cable insulation. Continue to press the connector until the metal contacts are no longer visible.
- 5 Fasten the strain relief clamp over the cable and into the ribbon cable connector as shown in Figure B-2. Remove any excess cable after the clamp is in place.
- 6 Align the metal contacts of the D-Sub connector over cable pin 1 and the other pins, press the D-Sub connector onto the cable using a vise or clamp to press the contacts **evenly** through the cable insulation. Continue to press the connector until the metal contacts are no longer visible. Remove any excess cable after the connector is in place.



**www.agilent.com**

### **Contact us**

To obtain service, warranty or technical assistance, contact us at the following phone or fax numbers:

United States:

(tel) 800 829 4444 (fax) 800 829 4433

Canada:

(tel) 877 894 4414 (fax) 800 746 4866

China:

(tel) 800 810 0189 (fax) 800 820 2816

Europe:

(tel) 31 20 547 2111

Japan:

(tel) (81) 426 56 7832 (fax) (81) 426 56

7840

Korea:

(tel) (080) 769 0800 (fax) (080) 769 0900

Latin America:

(tel) (305) 269 7500

Taiwan:

(tel) 0800 047 866 (fax) 0800 286 331

Other Asia Pacific Countries:

(tel) (65) 6375 8100 (fax) (65) 6755 0042

Or visit Agilent World Wide Web at:

[www.agilent.com/find/assist](http://www.agilent.com/find/assist)

Product specifications and descriptions in this document are subject to change without notice. Always refer to Agilent web site for the latest revision.

© Agilent Technologies, Inc. 2008

Printed in Malaysia

Second Edition, June 6, 2008

U2931-90001



**Agilent Technologies**

## Free Manuals Download Website

<http://myh66.com>

<http://usermanuals.us>

<http://www.somanuals.com>

<http://www.4manuals.cc>

<http://www.manual-lib.com>

<http://www.404manual.com>

<http://www.luxmanual.com>

<http://aubethermostatmanual.com>

Golf course search by state

<http://golfingnear.com>

Email search by domain

<http://emailbydomain.com>

Auto manuals search

<http://auto.somanuals.com>

TV manuals search

<http://tv.somanuals.com>