

IPPC-9151 Series

**Rugged Industrial Panel PC with
Intel® Pentium® 4 or Celeron®
and 15" LCD Display**

Users Manual

Copyright notice

This document is copyrighted 2005, by Advantech Co. Ltd. All rights are reserved. Advantech Co., Ltd. reserves the right to alter the products described in this manual at any time without notice. No part of this manual may be reproduced, copied, translated or transmitted in any form or by any means without the prior written permission of Advantech. Information provided in this manual is intended to be accurate and reliable. However, Advantech assumes no responsibility for use of this manual, nor for any infringements upon the rights of third parties which may result from such use. All brand and product names mentioned herein are trademarks or registered trademarks of their respective holders.

Acknowledgments

IBM and PC are trademarks of International Business Machines Corporation.

For more information on this and other Advantech products, please visit our website at: <http://www.advantech.com>

For technical support and service, please visit our support website at: <http://www.advantech.com.tw/support/>

警告使用者

這是甲類的資訊產品，在居住的環境中使用時，可能會造成射頻干擾，在這種情況下，使用者會被要求採取某些適當的對策。

Part No. 2003915101

Edition 1.3

June 2007

FCC Class A

Note: This equipment has been tested and found to comply with the limits for a Class A digital device, pursuant to part 15 of the FCC Rules. These limits are designed to provide reasonable protection against harmful interference when the equipment is operated in a commercial environment. This equipment generates, uses, and can radiate radio frequency energy and, if not installed and used in accordance with the instruction manual, may cause harmful interference to radio communications. Operation of this equipment in a residential area is likely to cause harmful interference in which case the user will be required to correct the interference at his own expense.

Warning! Any changes or modifications made to the equipment which are not expressly approved by the relevant standards authority could void your authority to operate the equipment.



Packing List

Before setting up the system, check that the item is among those listed below and is in good condition. If your Panel PC does not match any of those below, please contact your dealer immediately.

1 x IPPC-9151 Panel PC

1 x Accessory pack, with:

- DESKTOP BRACKET(L)
- DESKTOP BRACKET(R)
- FIX Bracket x 4
- COMPRESSION SPRING x 4
- THERMAL GREASE
- Registration and 1 year Warranty card
- CD ROM for IPPC Series DRV
- Urethane Seal (UP/DOWN)
- Urethane Seal (L/R)
- Screw Bag
 - S/S D=5 H=1 + M3*5L ST Ni x 6
 - 1/4R/S D=8.1 H=2.2 + #6-32*3/16"L ST Ni x 6
 - 1/4R/S D=6.6 H=1.5 + M3*5L ST Ni x 8
 - ROUND M6*25 x 4
 - SP/S D=8 H=1.5 - M4*6L ST Ni x 8

The IPPC-9151 Series of Industrial Panel PCs includes the following models:

IPPC-9151G-XAE

Rugged Pentium 4 Industrial Panel PC with 15" LCD,180W AC power supply, Stainless steel chassis and aluminum front panel

IPPC-9151G-RAE

IPPC-9151G-XAE with resistive touchscreen

IPPC-9151F-XAE

Rugged Pentium 4 Industrial Panel PC with 15" LCD,180W AC power supply, Stainless steel chassis and flat-sealed aluminum front panel

IPPC-9151F-RAE

IPPC-9151F-XAE with resistive touchscreen

Additional Information and Assistance

- Step 1. Visit the Advantech web site at **www.advantech.com** where you can find the latest information about the product.
- Step 2. Contact your distributor, sales representative, or Advantech's customer service center for technical support if you need additional assistance. Please have the following information ready before you call:

- Product name and serial number
- Description of your peripheral attachments
- Description of your software (operating system, version, application software, etc.)
- A complete description of the problem
- The exact wording of any error messages

Safety Instructions

1. Read these safety instructions carefully.
2. Keep this User's Manual for later reference.
3. Disconnect this equipment from any AC outlet before cleaning. Use a damp cloth. Do not use liquid or spray detergents for cleaning.
4. For plug-in equipment, the power outlet socket must be located near the equipment and must be easily accessible.
5. Keep this equipment away from humidity.
6. Put this equipment on a reliable surface during installation. Dropping it or letting it fall may cause damage.
7. The openings on the enclosure are for air convection. Protect the equipment from overheating. **DO NOT COVER THE OPENINGS.**
8. Make sure the voltage of the power source is correct before connecting the equipment to the power outlet.
9. Position the power cord so that people cannot step on it. Do not place anything over the power cord.
10. All cautions and warnings on the equipment should be noted.
11. If the equipment is not used for a long time, disconnect it from the power source to avoid damage by transient overvoltage.
12. Never pour any liquid into an opening. This may cause fire or electrical shock.
13. Never open the equipment. For safety reasons, the equipment should be opened only by qualified service personnel.
14. If one of the following situations arises, get the equipment checked by service personnel:
 - a. The power cord or plug is damaged.
 - b. Liquid has penetrated into the equipment.
 - c. The equipment has been exposed to moisture.
 - d. The equipment does not work well, or you cannot get it to work according to the user's manual.
 - e. The equipment has been dropped and damaged.
 - f. The equipment has obvious signs of breakage.
15. **DO NOT LEAVE THIS EQUIPMENT IN AN ENVIRONMENT WHERE THE STORAGE TEMPERATURE MAY GO BELOW -20° C (-4° F) OR ABOVE 60° C (140° F). THIS COULD DAMAGE THE EQUIPMENT. THE EQUIPMENT SHOULD BE IN A CONTROLLED ENVIRONMENT.**
16. **CAUTION: DANGER OF EXPLOSION IF BATTERY IS INCORRECTLY REPLACED. REPLACE ONLY WITH THE SAME OR EQUIVALENT TYPE RECOMMENDED BY THE MANUFACTURER, DISCARD USED BATTERIES ACCORDING TO THE MANUFACTURER'S INSTRUCTIONS.**

The sound pressure level at the operator's position according to IEC 704-1:1982 is no more than 70 dB (A).

DISCLAIMER: This set of instructions is given according to IEC 704-1. Advantech disclaims all responsibility for the accuracy of any statements contained herein.

Wichtige Sicherheitshinweise

1. Bitte lesen sie Sich diese Hinweise sorgfältig durch.
2. Heben Sie diese Anleitung für den späteren Gebrauch auf.
3. Vor jedem Reinigen ist das Gerät vom Stromnetz zu trennen. Verwenden Sie Keine Flüssig-oder Aerosolreiniger. Am besten dient ein angefeuchtetes Tuch zur Reinigung.
4. Die Netzanschlussteckdose soll nahe dem Gerät angebracht und leicht zugänglich sein.
5. Das Gerät ist vor Feuchtigkeit zu schützen.
6. Bei der Aufstellung des Gerätes ist auf sicheren Stand zu achten. Ein Kippen oder Fallen könnte Verletzungen hervorrufen.
7. Die Belüftungsöffnungen dienen zur Luftzirkulation die das Gerät vor überhitzung schützt. Sorgen Sie dafür, daß diese Öffnungen nicht abgedeckt werden.
8. Beachten Sie beim Anschluß an das Stromnetz die Anschlußwerte.
9. Verlegen Sie die Netzanschlusbleitung so, daß niemand darüber fallen kann. Es sollte auch nichts auf der Leitung abgestellt werden.
10. Alle Hinweise und Warnungen die sich am Geräten befinden sind zu beachten.
11. Wird das Gerät über einen längeren Zeitraum nicht benutzt, sollten Sie es vom Stromnetz trennen. Somit wird im Falle einer Überspannung eine Beschädigung vermieden.
12. Durch die Lüftungsöffnungen dürfen niemals Gegenstände oder Flüssigkeiten in das Gerät gelangen. Dies könnte einen Brand bzw. elektrischen Schlag auslösen.
13. Öffnen Sie niemals das Gerät. Das Gerät darf aus Gründen der elektrischen Sicherheit nur von autorisiertem Servicepersonal geöffnet werden.
14. Wenn folgende Situationen auftreten ist das Gerät vom Stromnetz zu trennen und von einer qualifizierten Servicestelle zu überprüfen:
 - a - Netzkabel oder Netzstecker sind beschädigt.
 - b - Flüssigkeit ist in das Gerät eingedrungen.
 - c - Das Gerät war Feuchtigkeit ausgesetzt.
 - d - Wenn das Gerät nicht der Bedienungsanleitung entsprechend funktioniert oder Sie mit Hilfe dieser Anleitung keine Verbesserung erzielen.
 - e - Das Gerät ist gefallen und/oder das Gehäuse ist beschädigt.
 - f - Wenn das Gerät deutliche Anzeichen eines Defektes aufweist.
15. VORSICHT: Explosionsgefahr bei unsachgemabem Austausch der Batterie.Ersatz nur durch denselben oder einem vom Hersteller empfohlene-mähnlichen Typ. Entsorgung gebrauchter Batterien navh Angaben des Herstellers.
16. ACHTUNG: Es besteht die Explosionsgefahr, falls die Batterie auf nicht fach-männische Weise gewechselt wird. Verfangen Sie die Batterie nur gleicher oder entsprechender Type, wie vom Hersteller empfohlen. Entsorgen Sie Bat-terien nach Anweisung des Herstellers.

Der arbeitsplatzbezogene Schalldruckpegel nach DIN 45 635 Teil 1000 beträgt 70dB(A) oder weiger.

Haftungsausschluss: Die Bedienungsanleitungen wurden entsprechend der IEC-704-1 erstellt. Advantech lehnt jegliche Verantwortung für die Richtigkeit der in diesem Zusammenhang getätigten Aussagen ab.

Contents

| | | |
|------------------|---|-----------|
| Chapter 1 | General Information | 2 |
| 1.1 | Introduction | 2 |
| 1.2 | Specifications | 3 |
| 1.2.1 | General | 3 |
| 1.2.2 | Standard PC Functions | 3 |
| 1.2.3 | AGP SVGA/Flat Panel Interface | 4 |
| 1.2.4 | Audio Function | 4 |
| 1.2.5 | PCI bus Ethernet Interface | 5 |
| 1.2.6 | PCMCIA interface | 5 |
| 1.2.7 | Analog Resistive Touchscreen (optional) | 5 |
| 1.2.8 | Optional Accessories | 5 |
| 1.2.9 | Environmental | 5 |
| 1.3 | Dimensions | 6 |
| | Figure 1.1:IPPC-9151FA Dimensions | 6 |
| | Figure 1.2:IPPC-9151GA Dimensions | 6 |
| Chapter 2 | System Setup | 8 |
| 2.1 | A Quick Tour of IPPC-9151 | 8 |
| | Figure 2.1:Side View | 9 |
| | Figure 2.2:Bottom View | 9 |
| 2.1.1 | PS/2 Mouse and Keyboard | 10 |
| 2.1.2 | Parallel Port | 10 |
| 2.1.3 | VGA port | 10 |
| 2.1.4 | Serial COM ports | 11 |
| 2.1.5 | USB ports | 11 |
| 2.1.6 | Audio Interface | 11 |
| 2.1.7 | Ethernet | 12 |
| 2.1.8 | Adjusting the LCD brightness | 12 |
| 2.1.9 | System turn ON/OFF | 12 |
| 2.2 | Installing SDRAM | 13 |
| 2.3 | Installing a CPU | 15 |
| 2.4 | Installing a 3.5" HDD | 16 |
| 2.5 | Installing Add-on Cards | 18 |
| 2.6 | Mounting Instructions | 18 |
| | 2.6.1 Panel Mounting | 18 |
| | 2.6.2 Rack Mounting | 18 |
| Chapter 3 | Jumper Settings & Connectors | 20 |
| 3.1 | Jumpers and Connectors | 20 |
| 3.1.1 | Setting jumpers | 20 |
| 3.1.2 | Jumpers and switches | 21 |

| | | |
|------------------|--|-----------|
| | Table 3.1: Jumpers, switches and their functions | 21 |
| 3.1.3 | Jumper Locations | 21 |
| | Figure 3.1: Jumpers on the IPPC-9151 motherboard | 21 |
| 3.1.4 | Connectors | 22 |
| | Table 3.2: Panel PC connectors | 22 |
| 3.1.5 | Locating connectors | 23 |
| | Figure 3.2: Connectors on IPPC-9151 motherboard | 23 |
| 3.2 | CPU Installation | 24 |
| 3.3 | CMOS Clear for External RTC (JP3) | 24 |
| | Table 3.4: CMOS clear (JP3) | 24 |
| 3.4 | COM-port interface (JP4, JP5) | 25 |
| 3.4.1 | COM2 RS-232/422/485 setting (JP4) | 25 |
| | Table 3.5: COM2 RS-232/422/485 setting (JP4) | 25 |
| | Table 3.6: COM 1/2 Pin 9 setting (JP5) | 26 |
| 3.5 | VGA interface | 26 |
| 3.5.1 | LCD panel power setting | 26 |
| | Table 3.7: LCD Panel Power Setting (JP2) | 26 |
| Chapter 4 | Intel Chipset | 28 |
| 4.1 | Introduction | 28 |
| 4.2 | Driver Installation | 28 |
| 4.2.1 | Installation for Windows 98/NT/ME/2000/XP | 29 |
| 4.3 | Further Information | 30 |
| Chapter 5 | PCI Bus Ethernet Interface | 32 |
| 5.1 | Introduction | 32 |
| 5.2 | Installation of Ethernet Driver | 32 |
| 5.2.1 | Installation for Windows 98/NT/ME/2000 | 33 |
| 5.3 | Further Information | 35 |
| Chapter 6 | VGA Setup | 38 |
| 6.1 | Introduction | 38 |
| 6.1.1 | Chipset | 38 |
| 6.1.2 | Display memory | 38 |
| 6.1.3 | Display types | 38 |
| 6.2 | Installation of the VGA Driver | 39 |
| 6.2.1 | Installation for Windows 95/98/ME | 39 |
| 6.3 | Further Information | 40 |
| Chapter 7 | Audio Setup | 42 |
| 7.1 | Introduction | 42 |
| 7.2 | Installation of the Audio Driver | 42 |
| 7.2.1 | Installation for Windows 98/ME/2000/XP | 43 |
| Chapter 8 | Touchscreen | 46 |
| 8.1 | Introduction | 46 |
| 8.2 | Touchscreen Specifications | 46 |

| | | | |
|-------------------|--------|--|-----------|
| | 8.3 | Installing Driver for Windows 2000/XP | 47 |
| | 8.4 | Configuring PenMount Windows 2000/XP Driver..... | 52 |
| | 8.4.1 | PenMount Control Panel | 52 |
| | 8.4.2 | PenMount Monitor Menu Icon | 62 |
| | 8.4.3 | PenMount Rotating Functions | 63 |
| | 8.5 | Uninstall the PenMount Windows 2000/XP driver..... | 64 |
| Chapter 9 | | PCMCIA | 66 |
| | 9.1 | Introduction | 66 |
| | 9.2 | Installation of PCMCIA Driver..... | 66 |
| | 9.2.1 | Installation for Windows | 67 |
| Chapter 10 | | Award BIOS Setup..... | 70 |
| | 10.1 | Award BIOS Setup..... | 70 |
| | 10.2 | CMOS Setup Utility..... | 70 |
| | 10.2.1 | Standard CMOS Setup..... | 71 |
| | | Figure 10.1:Standard CMOS features..... | 71 |
| | | Figure 10.2:Standard CMOS features..... | 72 |
| | 10.3 | Advanced BIOS Features | 74 |
| | 10.4 | Advanced Chipset Features | 78 |
| | 10.5 | Integrated Peripherals..... | 81 |
| | 10.6 | Power Management Setup..... | 85 |
| | 10.7 | PnP/PCI Configuration..... | 89 |
| | 10.8 | PC Health Status..... | 91 |
| | 10.9 | Frequency/Voltage Control | 92 |
| | 10.10 | Load Optimized Defaults | 92 |
| | 10.11 | Set Password | 93 |
| | 10.12 | Save & Exit Setup | 94 |
| | 10.13 | Exit Without Saving..... | 94 |
| Appendix A | | LCD Specifications..... | 96 |
| Appendix B | | Pin Assignments | 98 |
| | B.1 | ATX Power connector 1 (CN1) | 98 |
| | | Table B.1:AT Power connector 1 (CN1)..... | 98 |
| | B.2 | ATX power connector 2 (CN2)..... | 99 |
| | | Table B.2:ATX power connector 2 (CN2) | 99 |
| | B.3 | LVDS connector 1(CN4) | 99 |
| | | Table B.3:LVDS connector 1(CN4) | 99 |
| | B.4 | LVDS connector 2(CN6) | 100 |
| | | Table B.4:Table B.4: LVDS connector 2 (CN6) | 100 |
| | B.5 | Inverter power connector (CN5) | 100 |
| | | Table B.5:Inverter power connector (CN5)..... | 100 |
| | B.6 | FDD connector (CN9)..... | 101 |
| | | Table B.6:FDD connector (CN9)..... | 101 |
| | B.7 | Internal speaker connector (CN15) | 102 |

| | | |
|-----|--|-----|
| | Table B.7:Internal speaker connector (CN15)..... | 102 |
| B.8 | IR connector (CN24)..... | 102 |
| | Table B.8:IR connector (CN24)..... | 102 |
| B.9 | Fan power connector (FAN1 & FAN2) | 102 |

General Information

This chapter gives background information on the IPPC-9151 series
Sections include:

- Introduction
- Specifications
- Dimensions

Chapter 1 General Information

1.1 Introduction

The IPPC-9151 series of industrial panel PCs is especially designed to fit in space-limited environments where expansion is restricted. Its solid structure enables systems to operate under harsh industrial conditions.

Sturdy structure

The whole system is protected by a firm solid structure. The front panel is made of sturdy aluminum and has strengthened glass. It is shock resistant, and complies with NEMA4/IP65. The stainless steel case (SUS304) on the rear side is rugged and corrosion resistant, and enables the system to operate reliably in even the harshest of environments.

Easy maintenance

A back door with lock is located right above the motherboard. Thus users can easily maintain the CPU, HDD, SDRAM and CD-ROM drive. Jumpers can be easily set without removing a single screw. The lock protects the system from intruders.

Economical

The PCM-9683 motherboard has Socket 478 architecture. It supports Pentium 4 up to 2.8 GHz and Celeron up to 2.4 GHz. Socket 478 is an economical yet powerful system. Its reliability enables the system to operate faultlessly in industrial environments.

Friendly HMI

Systems in the IPPC-9151 series are equipped with a 15" LCD screen, which provides high resolution display quality. The result is vivid, bright, and sharp quality images. The panel PC is perfectly suited for Windows OS. The touchscreen version enables simple operation, making the Panel PC a solid industrial digital controller interface. In addition, the rugged design of the IPPC-9151 series offers 3 front panel options with aluminum/stainless/flat-seal for various requirements.

1.2 Specifications

1.2.1 General

- **Dimensions (W x H x D):**

Front Panel: 428 x 310 x 8 mm (16.85" x 12.2" x 0.31")

Cabinet: 402 x 290 x 162 mm (15.82" x 11.41" x 6.37")

Cut out dimension: 406 x 294 mm (15.98" x 11.57")

- **Weight:** 13 kg (28 lb)
- **Power supply:** 180 W
- **Input voltage:** 100 V AC ~ 240 V AC @ 50 ~ 60 Hz, 2A
- **Output voltage:** +5 V @ 15 A, +12 V @ 5 A, -12V @ 0.5A
- **Disk drive housing:**
Supports one 3.5" HDD, one slim size CD-ROM and FDD drive.
- **Chassis:**
Aluminum front frame complies with NEMA4/IP65. SUS304 stainless steel back case

1.2.2 Standard PC Functions

- **CPU:**
Socket 478 Pentium 4 up to 2.8 GHz.
Celeron up to 2.4 GHz
- **BIOS:** Award 4 MB Flash BIOS, supports Plug & Play, APCI
- **Chipset:** Intel 845GV / ICH4
- **2nd level cache:** On-die 256 or 512 KB
- **RAM:**
Two 184-pin DDR DIMM sockets up to 2GB DDR SDRAM
- **PCI bus master IDE interface:**
Supports two connectors. Each connector has one channel and supports two IDE devices. Each channel supports PIO modes 0 ~ 4, DMA modes 0 ~ 2, and Ultra DMA 33 simultaneously. The secondary connector is designated for the CD-ROM drive. BIOS supports IDE CD-ROM boot-up.
- **Parallel port:**
One parallel port, supports SPP/EPP/ECP parallel mode. BIOS configurable to LPT1, LPT2, LPT3 or disabled

- **Serial ports:**
Two serial ports with one RS-232 port (COM1) and one RS-232/422/485 port (COM2). Both ports are compatible with 16C550 UARTs
- **Universal serial bus (USB) port:** Supports up to 4 USB (version 2.0) ports.
- **PCI bus expansion slots:**
Two expansion slots for two PCI cards.
- **Watchdog timer:**
62-level, interval 1 ~ 62 seconds. Automatically generates system reset or IRQ11 when the system stops due to a program error or EMI.
Jumperless selection and software enabled/disabled
- **Battery:** 3.0 V @ 195 mA lithium battery

1.2.3 AGP SVGA/Flat Panel Interface

- **Chipset:** Intel 845GV chipset with integrated Intel Extreme Graphics 2 for 2D/3D video accelerator
- **Display memory:** 8 MB share main memory
- **Display type:**
Simultaneously supports CRT and flat panel displays (TFT)
- **Display resolution:**
Supports LCD displays up to 1024 x 768 @ 262K in colors

1.2.4 Audio Function

- **Chipset:** Integrated in Intel 845GV ICH4 South Bridge
- **Audio controller:**
AC97 Ver.2.0 compliant interface, Multi stream, Direct sound and Direct Sound 3D acceleration
- **Stereo sound:**
18-bit full-duplex codec
- **Audio interface:**
Microphone-in, line-in, line-out, and game ports MPU-401.

1.2.5 PCI bus Ethernet Interface

- **Chipset:** Intel RC82540Em local bus.
- **Ethernet Interface:**
Fully complies with IEEE 802.3u 100Base-T and 10 Base-T specifications. Includes software drivers and boot ROM
- **100/10Base-T auto-sensing capability**

1.2.6 PCMCIA interface

- Chipset: RICOH R5C554
- Cardbus controller: A PC card controller offers a single chip solution as a bridge between the PCI bus and the Cardbus

1.2.7 Analog Resistive Touchscreen (optional)

- **Type:** Analog resistive
- **Resolution:** 1024 x 1024
- **Light Transmission:**
75% (Gouge Hardness is greater than 4H per ASTM D3363-92 for HCC01, HCG10 and HCG12)
- **Controller:** RS-232 interface
- **Power Consumption:** +5 V @ 200 mA
- **Software Driver:**
Supports DOS, Windows 3.1, Windows 98/ME/2000/XP and Windows NT 4.0

1.2.8 Optional Accessories

- **IPPC-9151G-RMKE**
19" rack mounting kit for IPPC-9151 series.

1.2.9 Environmental

- **Operating temperature:** 0 ~ 50° C (32 ~ 122° F)
- **Storage temperature:** -20 ~ 60° C (-4 ~ 140° F)
- **Relative humidity:** 10 ~ 90% @ 40° C (non-condensing)
- **Shock:** 30 G peak acceleration (11 ms duration)
- **Power MTBF:** 100,000 hrs
- **Certifications:** CE, CCC, FCC Class, UL, BSMI

1.3 Dimensions

IPPC-9151FA

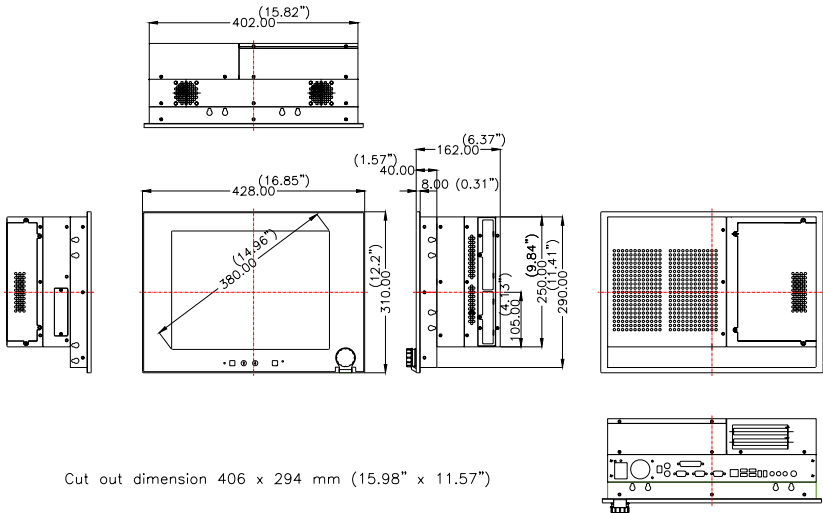

Figure 1.1: IPPC-9151FA Dimensions

IPPC-9151GA

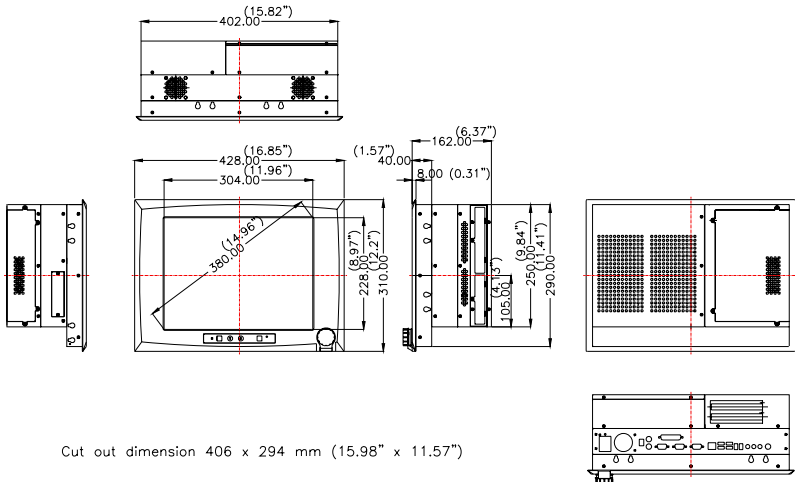

Figure 1.2: IPPC-9151GA Dimensions

System Setup

This chapter details system setup for the IPPC-9151 Series.

Sections include:

- General
- Installing SDRAM
- Installing a CPU
- Installing a 2.5" HDD
- Installing a CD-ROM Drive
- Installing Add-on Cards
- Mounting Instructions

Chapter 2 System Setup

2.1 A Quick Tour of IPPC-9151

Before you start the computer, please follow these procedures to set up the system.

1. Check and adjust jumpers on the motherboard (see Chapter 3)
2. Install SDRAM
3. Install a CPU
4. Install add-on cards
5. Connect the wires, cables and accessories
6. Mount the computer
7. Program the BIOS settings
8. Install an operating system.

Warnings



1. Switch off and unplug the computer every time you access its interior.

2. The motherboard inside the system is composed of many delicate ICs, chips and other integrated circuit components. These components are easily damaged by static shock. When you begin to install components, please:

- *Avoid touching metal parts of the motherboard.*
- *Wear an anti-static ring when handling a CPU or SDRAM module.*
- *Put SDRAM modules and the CPU inside an anti-static bag or a similar place before installation.*



Figure 2.1: Side View

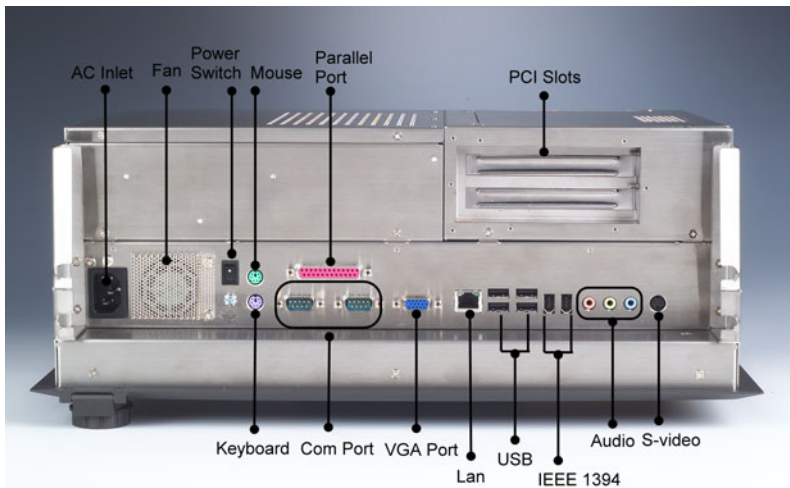

Figure 2.2: Bottom View

2.1.1 PS/2 Mouse and Keyboard

If you wish to use a full-size desktop keyboard and PS/2 mouse with your panel PC, follow these instructions:

1. Be sure the panel PC is turned off.
2. Attach the keyboard adapter to the 5-pin green port on the rear bottom side of the rear cover.
3. Attach the mouse adapter to the 5-pin purple port on the rear bottom side of the rear cover.

2.1.2 Parallel Port

The panel PC supports the latest EPP and ECP parallel port protocols for improved performance and versatility with compatible printers or other devices.

To connect the panel PC to a printer or other devices:

1. Make sure both the panel PC and the printer/devices are turned off.
2. Connect the 25-pin male connector of the printer cable to the 25-pin female port on the panel PC labelled "parallel port."
3. If necessary, attach the other end of your printer cable to your printer, and fasten any retaining screws.
4. Turn on the printer and any other peripheral devices you may have connected to the panel PC. Then turn on the panel PC.
5. If necessary, run the panel PC's BIOS setup program to configure the parallel port to respond as required by your printer and software operating environment.

2.1.3 VGA port

An external VGA-compatible device may be connected to the system via the 15-pin external port located on the rear of the system unit. The panel PC simultaneously supports an external CRT monitor in addition to its own LCD display.

2.1.4 Serial COM ports

There are two serial COM ports on the bottom of the rear cover. You can easily attach a serial device to the panel PC, such as an external modem or mouse. Follow these instructions:

1. Make sure the panel PC and any other peripheral devices you may have connected to the panel PC are turned off.
2. Attach the interface cable of the serial device to the panel PC's serial port. (See Fig. 2-2.) If necessary, attach the other end of the interface cable to your serial device. Fasten any retaining screws.
3. Turn on any other peripheral devices you may have connected to the panel PC, and then turn on the panel PC.
4. Refer to the manual(s) which accompanied your serial device(s) for instructions on configuring your operating environment to recognize the device(s).
5. Run the BIOS setup program to set the I/O address and IRQ, and configure the jumper settings to change the mode of the COM ports (refer to section 3.3).

2.1.5 USB ports

An external USB device may be connected to the system via the 4-pin USB ports located on the rear side of the system unit.

1. Connect the external device to the system.
2. The USB ports support hot plug-in connection. You should install the device driver before you use the device.

2.1.6 Audio Interface

The audio interface includes three jacks: microphone-in, line-out and line-in. Their functions are:

Microphone-in: Use an external microphone to record voice and sound.

Line-out: Output audio to external devices such as speakers or earphones. The built-in speaker will not be disabled when the line-out jack is connected to external audio devices.

Line-in: Input audio from an external CD player or radio.

1. Connect the audio device to the system.
2. Install the driver before you use the device.

2.1.7 Ethernet

To install Ethernet for your system:

1. Connect the Ethernet cable.
2. Turn on the panel PC.
3. Under DOS, run `\IPPC-9151\LAN\RSET8139.EXE` to check hardware network status before installing the Ethernet driver.
4. Run the Ethernet driver to connect up to the network.

2.1.8 Adjusting the LCD brightness

The brightness control key on the front panel allows you to adjust the brightness of the LCD display panel. Its setting procedure is as follows.

1. If you want to extend the brightness, please press the OSD key until the LED stops blinking. (See Pic. #1)
2. If you want to lower down the brightness, please press the OSD key until the LED stops blinking. (See Pic. #2)

2.1.9 System turn ON/OFF

The IPPC-9151 series offers 2 system on/off options, which are:

1. Front Panel system on/off, which is the default setting.(pic)
2. Rear Cover system on/off. If you choose this one, you need to reconnect the cable. Please refer to the following procedures.

2.2 Installing SDRAM

You can install from 64 MB to 2 GB (x2) of DDR SDRAM memory. The Panel PC system provides one 184-pin DIMM (Double Inline Memory Module) socket, and supports 2.5 V DDR SDRAM.

1. Unlock the back cover and open it.
2. Disconnect the FDD and CD-ROM cable.



3. Unscrew the screws of the FDD and CD-ROM module and take off the FDD and CD-ROM.



4. Disconnect the HDD cable.



5. Undo the seven screws of the HDD Module so you can install the SDRAM.

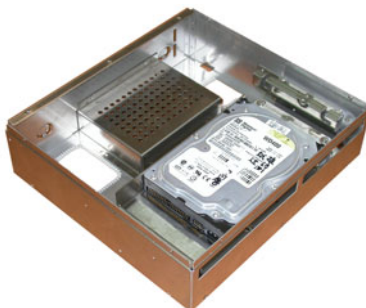

6. Push the two white eject levers on each side of the DIMM outward until they are separated from the black vertical posts.
7. Insert the memory module into the socket at an angle of 90 degrees.
8. Push the two eject levers toward the vertical posts at each end of the socket until the module is upright.

2.3 Installing a CPU

The CPU can be upgraded to improve system performance. The system provides Socket 478 architecture which supports Pentium 4 CPU up to 2.8 GHz, and Celeron up to 2.4 GHz..

Warnings



Always disconnect the power cord from your panel PC when you are working on it. Do not make connections while the power is on, because sensitive electronic components can be damaged by the sudden rush of power. Only experienced electronics personnel should open the panel PC.

1. Remove the HDD, FDD and CD-ROM module. The removal procedure is the same as the SDRAM.
2. The CPU board will auto-detect CPU's voltage and frequency; there are no jumper settings.
3. Open the CPU socket by pulling up the lever sideways from the socket, then upwards at an angle of 90 degrees.
4. Insert the CPU with the correct orientation. The notched corner of the CPU (with the white dot) should point toward the end of the lever. The end of the lever is the blank area where one hole is missing from the corner of the square array of pin holes. An arrowhead printed on the motherboard points to the end of the lever.
5. Slide the CPU in gently. It should insert easily. If not, pull the lever up a little more and make sure the pins of the CPU correspond with the holes of the socket. **DO NOT USE EXCESSIVE FORCE!**
6. Press the lever down. The plate will slide forward.
7. Place the heat sink on top of the CPU, and secure with heat sink clip.
8. Connect the CPU's cooling fan power connector.
9. Push the HDD, FDD and CD-ROM module bracket into the chassis.

2.4 Installing a 3.5" HDD

You can attach one enhanced Integrated Device Electronics (IDE) hard disk drive to IPPC-9151's internal controller which uses PCI local bus interface. The following instructions are for installation:

1. Unlock the back cover and open it.
2. Remove the two screws and take off FDD, CD-ROM Module.

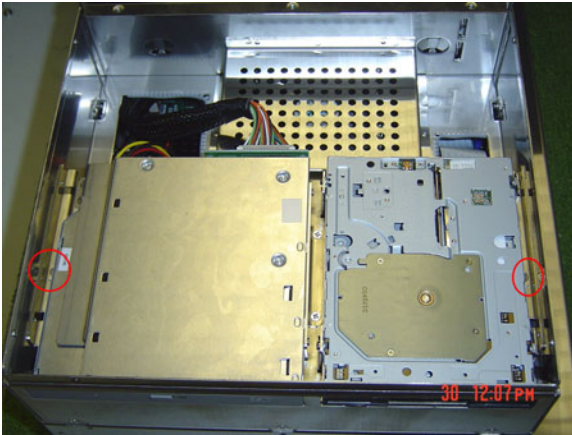

3. Remove four screws and take off HDD bracket.

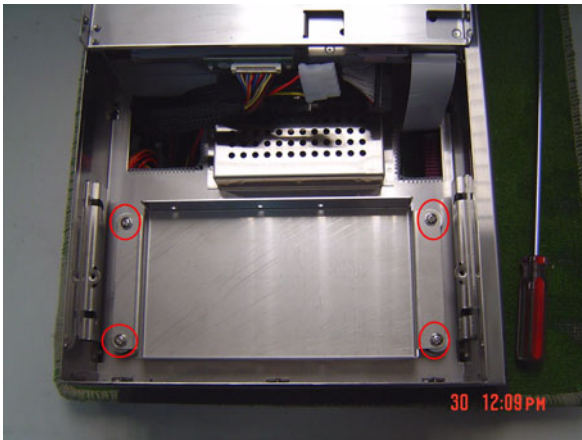

4. Insert the HDD into the bracket (see figure 2.4.3)
5. Put the HDD bracket into the Chassis and fasten the four screws. Then attach the HDD flat cable and power cable.



6. Insert the FDD, CD-ROM Module and fix the back cover.



2.5 Installing Add-on Cards

This system supports two PCI expansion cards.

1. Detach the five screws on the back to open the lid.
2. Take away the slot bracket.
3. Insert the add-on card, and put on the lid.



2.6 Mounting Instructions

There are two ways to mount the system: panel mounting or rack mounting.

2.6.1 Panel Mounting

1. Take the four mounting brackets out of the accessory box.
2. Attach the four mounting brackets by inserting the screws into the keyhole slots on the cover of the monitor.
3. Use the screws to secure the brackets to the cover. Tighten the screws to secure the monitor to the back panel.

2.6.2 Rack Mounting

The monitor can be mounted to a 19" industrial rack with an optional bracket.

Jumper Settings and Connectors

This chapter tells how to set up the panel PC hardware, including instructions on setting jumpers and connecting peripherals, switches and indicators. Be sure to read all the safety precautions before you begin the installation procedures.

Sections include:

- Jumpers and Connectors
- CPU Installation
- CMOS Clear for External RTC (JP8)
- COM-port Interface
- Internal -12 V Source Selection Setting (JP1)
- VGA Interface
- Watchdog Timer Configuration

Chapter 3 Jumper Settings & Connectors

3.1 Jumpers and Connectors

3.1.1 Setting jumpers

You can configure your panel PC to match the needs of your application by setting jumpers. A jumper is the simplest kind of electrical switch. It consists of two metal pins and a small metal clip (often protected by a plastic cover) that slides over the pins to connect them. To “close” a jumper, you connect the pins with the clip. To “open” a jumper you remove the clip. Sometimes a jumper will have three pins, labeled 1, 2, and 3. In this case, you would connect either pins 1 and 2 or pins 2 and 3.

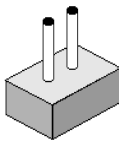

open

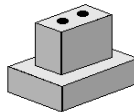

closed

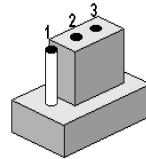

closed 2-3

The jumper settings are schematically depicted in this manual as follows:.



open



closed

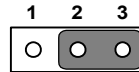

closed 2-3

A pair of needle-nose pliers may be helpful when working with jumpers. If you have any doubts about the best hardware configuration for your application, contact your local distributor or sales representative before you make any changes.

3.1.2 Jumpers and switches

The motherboard of the IPPC-9151 has a number of jumpers that allow you to configure your system to suit your applications. The table below lists the function of each of the board's jumpers.

Table 3.1: Jumpers, switches and their functions

| Label | Function |
|-------|-------------------------------------|
| JP1 | FSB (Front Side Bus) Setting |
| JP2 | LCD Power Setting |
| JP3 | Clear CMOS |
| JP4 | COM2 RS232/422/485 jumper setting |
| JP5 | COM1/COM2 pin 9 output type setting |
| JP6 | PS2 Interface for touchscreen |
| SW1 | Panel type setting |

3.1.3 Jumper Locations

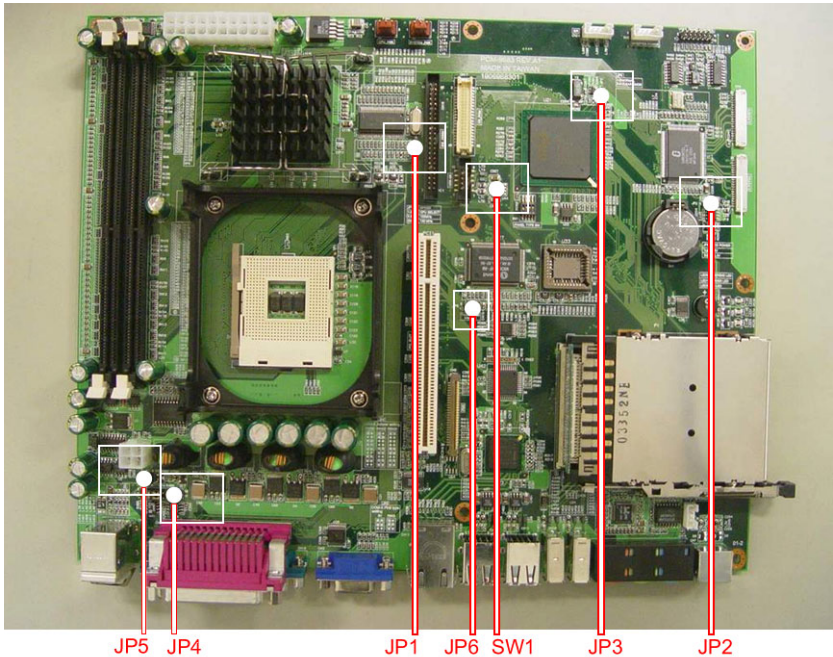

Figure 3.1: Jumpers on the IPPC-9151 motherboard

3.1.4 Connectors

Onboard connectors link the panel PC to external devices such as hard disk drives or floppy drives. The table below lists the function of each of the board's connectors.

Table 3.2: Panel PC connectors

| Label | Function |
|--------------|-----------------------------|
| CN1 | ATX 20 pin power connector |
| CN2 | ATX 12V Power connector |
| CN4 | LVDS connector 1 |
| CN5 | Invertor Power connector 2 |
| CN6 | LVDS connector 2 |
| CN9 | FDD Connector |
| CN15 | Internal Speaker Connector |
| CN16 | EIDE HDD connector |
| CN17 | CD-ROM Connector |
| CN24 | IR connector |
| CN25 | USB4/5 connector |
| FAN1 | CPU fan power connector |
| FAN2 | System fan power connector |
| PCI1 | PCI1 PCI bus expansion slot |

3.1.5 Locating connectors

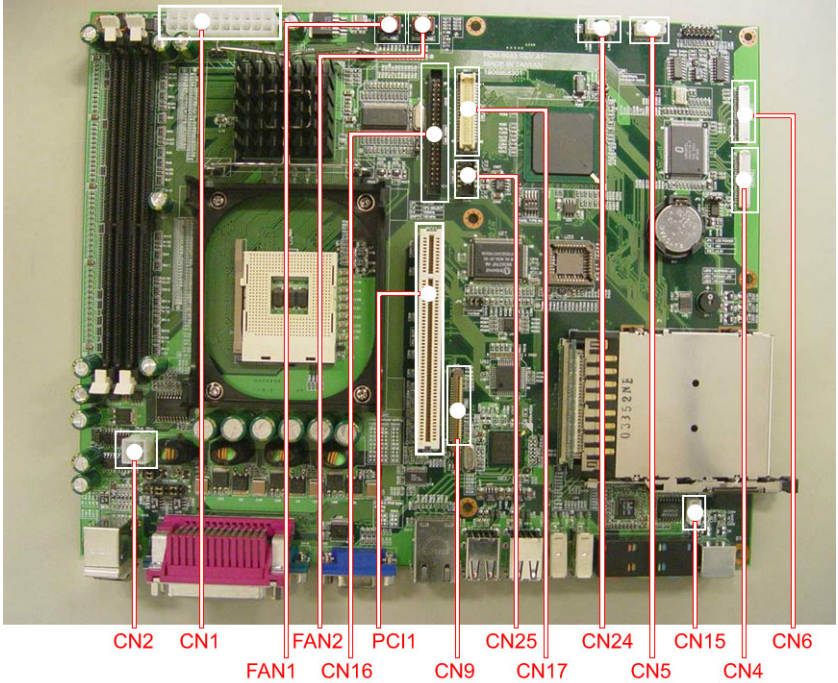

Figure 3.2: Connectors on IPPC-9151 motherboard

3.2 CPU Installation

You can install an Intel Pentium 4 or Celeron CPU without setting any frequency ratio or voltage.

Warning! To avoid damaging the computer, always turn off the power supply before setting "Clear CMOS". Set the jumper back to "Normal operation" before turning on the power supply.

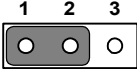
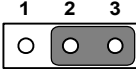
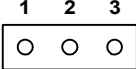

Table 3.3: Front Side Bus Setting (JPI)

| *Decided by CPU | Select 100 MHz | Select 133 MHz |
|---|---|---|
|  |  |  |

*Default setting

3.3 CMOS Clear for External RTC (JP3)

This jumper is used to erase CMOS data and reset system BIOS information.

The procedure for clearing CMOS is:

1. Turn off system.
2. Short pin 2 and pin 3.
3. Return jumper to pins 1 and 2.
4. Turn on the system. The BIOS is now reset to its default setting.

Table 3.4: CMOS clear (JP3)

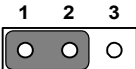
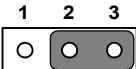
| *Normal operation | Clear CMOS |
|---|---|
|  |  |

* default setting

3.4 COM-port interface (JP4, JP5)

The panel PC provides two serial ports. COM1 (RS-232) and COM2 (RS-232/422/485) in one COM port connector.

3.4.1 COM2 RS-232/422/485 setting (JP4)

COM2 can be configured to operate in RS-232, RS-422, or RS-485 mode. This is done via JP6.

Table 3.5: COM2 RS-232/422/485 setting (JP4)

***RS-232**

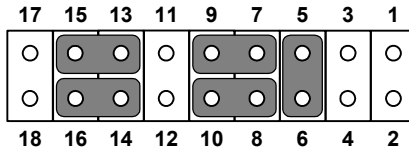

RS-422

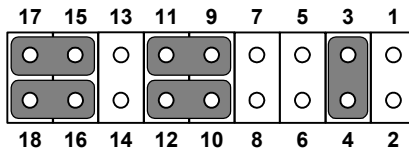

RS-485

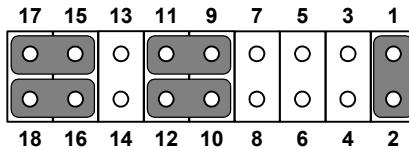

* default setting

The IRQ and the address ranges for COM 1 and 2 are fixed. However, if you wish to disable the port or change these parameters later you can do this in the system BIOS setup. The table overleaf shows the default settings for the panel PC's serial ports.

Table 3.6: COM 1/2 Pin 9 setting (JP5)



* default setting

3.5 VGA interface

The panel PC's AGP VGA interface can drive conventional CRT displays. It is also capable of driving a wide range of flat panel displays, including electroluminescent (EL), gas plasma, passive LCD and active LCD displays.

3.5.1 LCD panel power setting

The panel PC's AGP SVGA interface supports 5 V and 3.3 V LCD displays. The LCD cable already has a built-in default setting. You do not need to adjust any jumper or switch to select the panel power.

Table 3.7: LCD Panel Power Setting (JP2)

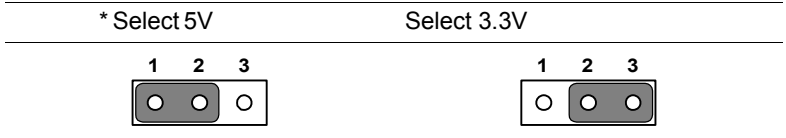

*Default setting

Intel Chipset

This chapter provides information on the Intel chipset configuration.

Sections include:

- Introduction
- Installation of chipset driver for Windows 98/NT/ME/2000/XP
- Further Information

Chapter 4 Intel Chipset

4.1 Introduction

IPPC-9151 uses the 845GV chipset from Intel., with built-in high performance 2D/3D Intel Extreme Graphics 2, flexible 100/133MHz system bus settings, support for DDR266 SDRAM and multiple power saving modes. This makes Intel 845GV the ideal integrated SMA chipset for the Intel Pentium 4 and Intel Celeron processors.

The VIA VT82C686B PSIPC (PCI Super-I/O Integrated Peripheral Controller) can support Intel and non-Intel based processor to PCI bus bridge functionality to make a complete Microsoft PC99-compliant PCI/ISA system, moreover, it also supports master mode enhanced IDE controller with dual channel DMA engine (includes UltraDMA-33/66/100) and interlaced dual channel commands.

4.2 Driver Installation

Before installing the driver, note the procedures below. You must know which operating system you are using in your IPPC-9151, and then refer to the corresponding installation flow chart. Then just follow the steps described in the flow chart. You will quickly and successfully complete the installation, even if you are not familiar with instructions for Windows..

Important: 1. *The following windows illustrations are examples only. You must follow the flow chart instructions and pay attention to the instructions which then appear on your screen.*

Notes: 1. *The CD-ROM drive is designated as "D" throughout this chapter.*
2. *<Enter> means pressing the "Enter" key on the keyboard.*

4.2.1 Installation for Windows 98/NT/ME/2000/XP

1. a. Select "Start", "Run".
b. Enter the driver path "D:\IPPC-9151G& 9171G_DRV&Utility \Chipset Software\IAA Driver\2.3\iaa23_multi.exe".
c. Click "OK".
2. Press "Next" to continue the installation.

Extracting Files

The contents of this package are being extracted.

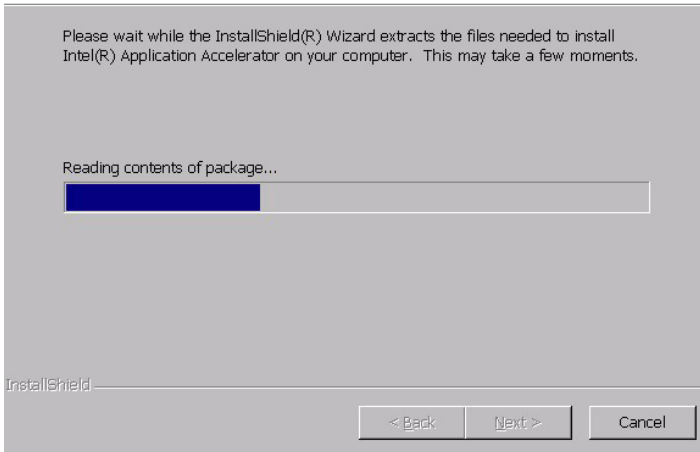

3. When you finish the IAA driver installation. Please continue to install the INF driver. The driver path "E:\IPPC-9151G& 9171G_DRV&Utility\Chipset Software\INF Driver\4.30.1006\infinst_autol.exe"

4.3 Further Information

For further information about the AGP/VGA installation in your IPPC-9151, including driver updates, troubleshooting guides and FAQ lists, visit the following web resources:

Intel website: www.intel.com

Advantech website: www.advantech.com

If you need to know more details about installation, please refer to
\\PPC-9151G& 9171G_DRV&Utility\Chipset Software

PCI Bus Ethernet Interface

This chapter provides information on Ethernet configuration.

Sections include:

- Introduction
- Installation of Ethernet Driver for Windows 98/NT/ME/2000/XP
- Further Information

Chapter 5 PCI Bus Ethernet Interface

5.1 Introduction

The IPPC-9151 series is equipped with a high performance 32-bit Ethernet chipset, which is fully compliant with IEEE 802.3 100 Mbps CSMA/CD standards. It is supported by major network operating systems, and is also both 100Base-T and 10Base-T compatible.

The Ethernet port provides a standard RJ-45 jack. The network boot feature can be utilized by incorporating the boot ROM image files for the appropriate network operating system. The boot ROM BIOS files are combined with system BIOS, which can be enabled/disabled in the BIOS setup.

5.2 Installation of Ethernet Driver

Before installing the Ethernet driver, note the procedures below. You must know which operating system you are using in your IPPC-9151, and then refer to the corresponding installation flow chart. Then just follow the steps described in the flow chart. You will quickly and successfully complete the installation, even if you are not familiar with instructions for Windows.

Important: The following Windows illustrations are examples only. You must follow the flow chart instructions and pay attention to the instructions which then appear on your screen.

Note 1: The CD-ROM drive is designated as "D" throughout this chapter.

Note 2: <Enter> means pressing the "Enter" key on the keyboard.

5.2.1 Installation for Windows 98/NT/ME/2000

1.
 - a. Select "Start", "Run"
 - b. Enter the path, "D:\IPPC-9151G& 9171G_DRV&Utility \Intel Lan 6.2\Setup.exe"
 - c. Click "OK"
2.
 - a. Click "Next"

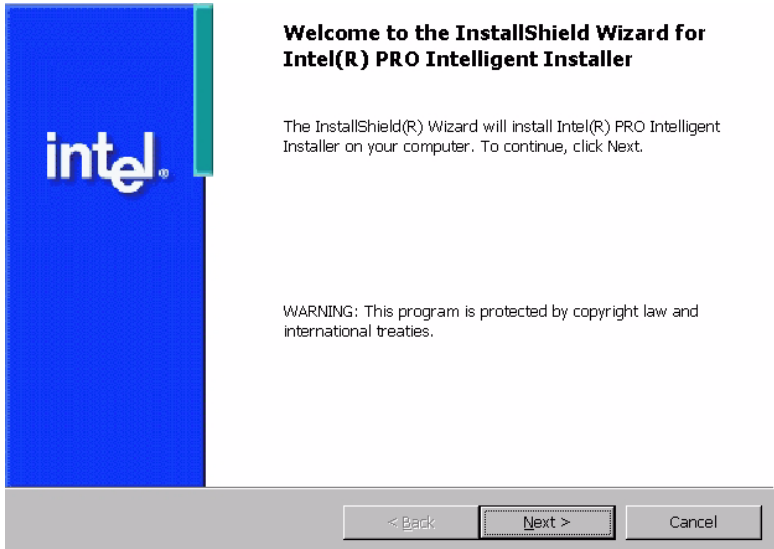

3.
 - a. Read the license agreement and click "Yes" if you accept the terms and wish to continue.
 - b. Click "Next"

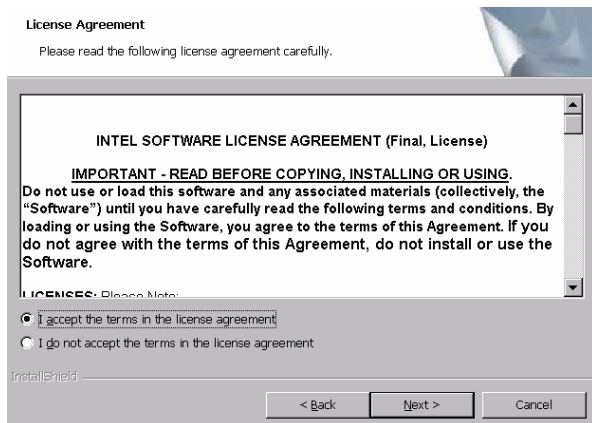

4. a. Click "Next"

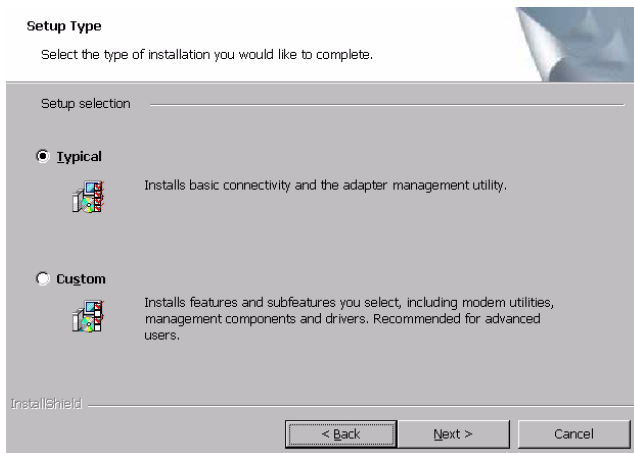

5. a. Click "Install"

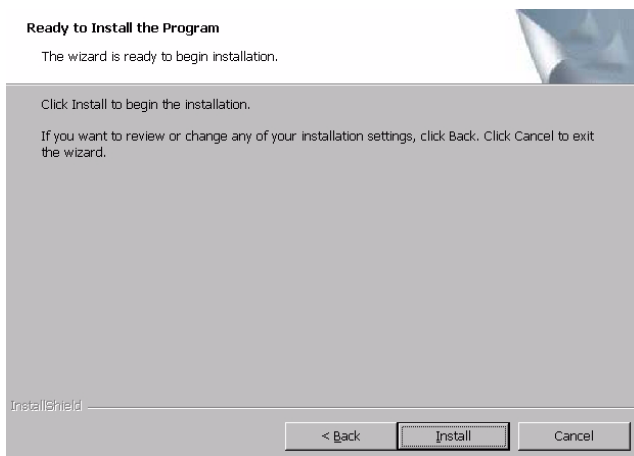

6. a. Click "Finish"

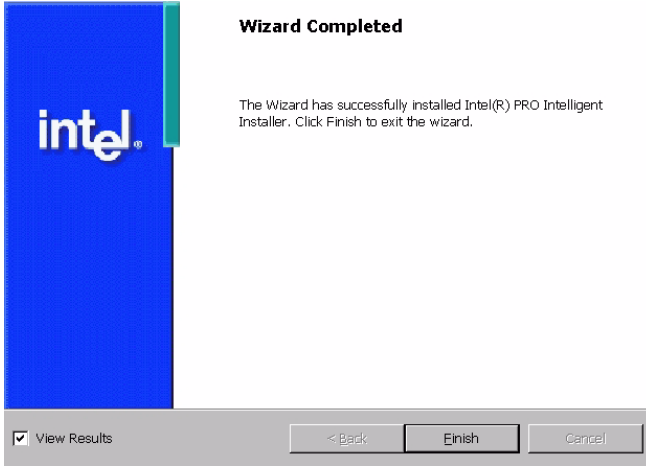

5.3 Further Information

Intel website: www.intel.com

Advantech website: www.advantech.com

VGA Setup

This chapter provides information on the VGA setup.

Sections include:

- Introduction
- Installation of VGA Drivers
 - for Windows 98/2000/ME
 - for Windows NT
 - for Windows XP
- Further Information

Chapter 6 VGA Setup

6.1 Introduction

The IPPC-9151 has an onboard AGP flat panel/VGA interface. The specifications and features are described as follows:

6.1.1 Chipset

IPPC-9151 uses a 845G chipset from Intel for its controller. It supports many popular LCDs, and LVDS LCD displays and conventional analog CRT monitors. The 845G VGA BIOS supports color TFT and DSTN LCD flat panel displays. In addition, it also supports interlaced and non-interlaced analog monitors (color and monochrome VGA) in high-resolution modes while

maintaining complete IBM VGA compatibility. Digital monitors (i.e. MDA, CGA, and EGA) are NOT supported. Multiple frequency (multisync) monitors are handled as if they were analog monitors.

6.1.2 Display memory

The 845G chip can support 8MB frame buffer shared with system memory; the VGA controller can drive CRT displays or color panel displays with resolutions up to 1024 x 768 @ 256K colors.

6.1.3 Display types

CRT and panel displays can be used simultaneously. The IPPC-9151 can be set in one of three configurations: on a CRT, on a flat panel display, or on both simultaneously. The system is initially set to simultaneous display mode. If you want to enable the CRT display only or the flat panel display only, please contact Intel, or our sales representative for detailed information.

6.2 Installation of the VGA Driver

Complete the following steps to install the VGA driver. Follow the procedures in the flow chart that apply to the operating system that you are using within your IPPC-9151.

6.2.1 Installation for Windows 95/98/ME

1.
 - a. Select "Start", "Run"
 - b. Enter the path "D:\IPPC-9151G& 9171G_DRV&Utility \VGA\WIN9X_ME\SETUP.EXE"

Notes:

1. *Installation for Windows 2000, please type the path "D:\IPPC-9151G& 9171G_DRV&Utility \VGA\Win2K_XP\Setup.exe"*
2. *Installation for Win NT, please type the path "D:\IPPC-9151G& 9171G_DRV&Utility \VGA\WinNT4\winnt4m1141.exe"*

2. Click "Next" on the Welcome screen.

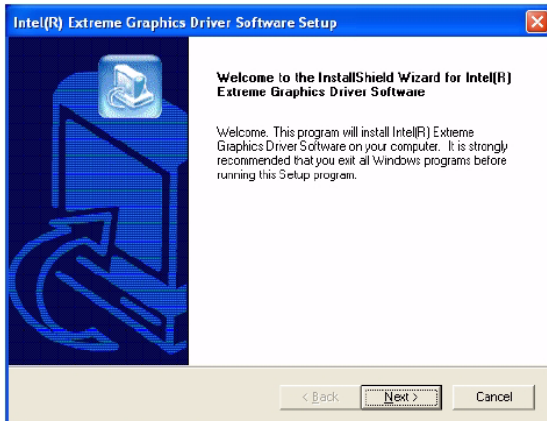

3. Read the license agreement and click "Yes" if you accept the terms and wish to continue.

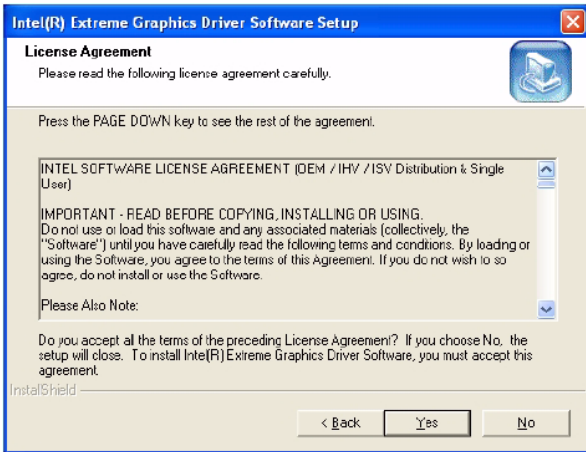

4. The driver files will now be installed. When the install finishes, choose the "Yes." option to restart, and click "Finish" to restart your computer. The driver will now be loaded.

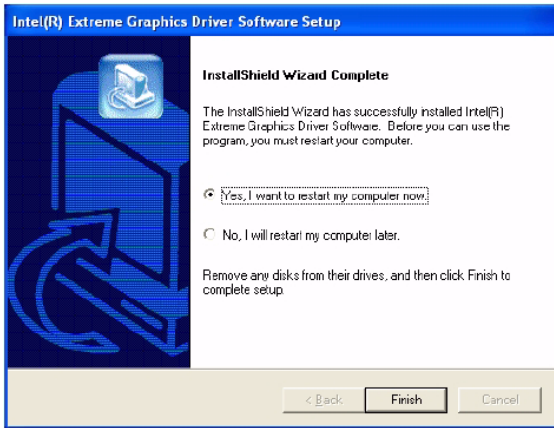

6.3 Further Information

For further information about the AGP/VGA installation in your IPPC-9151, including driver updates, troubleshooting guides and FAQ lists, visit the following web resources:

Intel website: www.intel.com

Advantech website: www.advantech.com

Audio Setup

This chapter provides information on the Audio setup.

Sections include:

- Introduction
- Installation of Audio Driver
 - for Windows 98/2000/ME
 - for Windows NT
 - for Windows XP

Chapter 7 Audio Setup

7.1 Introduction

The IPPC-9151's on-board audio interface provides high-quality stereo sound and FM music synthesis (ESFM) by using the VIA VT82C686 audio controller from VIA. The audio interface can record, compress, and play back voice, sound, and music with built-in mixer control.

The IPPC-9151 on board audio interface also supports the Plug & Play (PnP) standard and provides PnP configuration for the audio, FM, and MPU-104 logical devices. It is compatible with Sound Blaster™; Sound Blaster Pro™ version 3.01, voice and music functions. The ESFM synthesizer is register compatible with the OPL3 and has extended capabilities.

7.2 Installation of the Audio Driver

Before installing the audio driver, please take note of the procedures detailed below. You must know which operating system you are using in your IPPC-9151, and then refer to the corresponding installation flow chart. Just follow the steps in the flow chart. You can quickly and successfully complete the installation, even though you are not familiar with instructions for Windows.

- Notes:**
- 1. The windows illustrations in this chapter are intended as examples only. Please follow the listed steps, and pay attention to the instructions which appear on your screen.*
 - 2. For convenience, the CD-ROM drive is designated as "D" throughout this chapter.*
 - 3. <Enter> means pressing the "Enter" key on the keyboard.*

7.2.1 Installation for Windows 98/ME/2000/XP

1. a. Select "Start", "Run"
 - b. Enter the path "D:\IPPC-9151G& 9171G_DRV&Utility \ALC202\WinXP_2K_Me_9X\Setup.exe"

Notes:

1. *Installation for Windows 95, please Type the path "D:\IPPC-9151G& 9171G_DRV&Utility \ALC202\win95\Setup.exe"*
2. *Installation for Windows NT, please Type the path "D:\IPPC-9151G& 9171G_DRV&Utility \ALC202\winnt\Setup.exe"*

2. Click "Finish"



Touchscreen

This chapter contains information on the touchscreen, its installation and configuration.

Chapter 8 Touchscreen

8.1 Introduction

The IPPC-9151 Series' optional touchscreen uses advanced 8-wire resistive technology. It provides more accurate sensing capacity than other technologies. The touchscreen is specially designed for tough industrial environments, and has been approved to FCC Class B standards.

8.2 Touchscreen Specifications

Electrical

- **Contact bounce:** < 10 ms
- **Operating voltage:** 5 V (typical)
- **Sheet Resistance:** 350 +/- 22% per Square.
- **Linearity:** <1.5% full scale linearity error in either direction.
- **Insulation Resistance:** >20 M @ 25VDC

Durability

- **Test conditions:** 4 H hardness, 0.04" stylus pen, 350 gram load
- **Point activation:**
1 Million activations on a single point with a 5/8" diameter silicone finger with a 350g load at 2 Hz
- **Character Activation Life:**
>100,000 characters written within a 20 mm x 20 mm area on the touch screen.
- **Chemical resistance:**
Hard coating is highly resistant to most solvents and chemicals

Optical

- **Visible light transmission:** 75% typical (>74% @ 550 nm test)
- **Clarity:** Clear Finish - 25%, Antiglare Finish - 15%

Sensor board

- Chemical strengthened glass with 4 H hardness standard.
(Test condition: ASTM D3363-92A)

Ball drop test

- Able to bear a 225 g steel ball dropped from 660 mm elevation without breaking

Environmental Specifications

- **Operating Temperature Range:** -20° C ~ +50° C, 2 weeks at 50° C / 90% RH.
- **Storage Temperature High:** +70° C, 240 hours at ambient humidity.
- **Storage Temperature Low:** -40° C, continuous at ambient humidity.
- **Accelerated Aging:** 100 hours at 60° C / 95% RH.
- **Thermal Shock:** 25 cycles (one cycle is 30 min. dwell alternating from -40 to +85° C with less than 10 min. transfer time.

8.3 Installing Driver for Windows 2000/XP

The touchscreen has drivers for Windows 2000 and Windows XP. You should read the instructions in this chapter carefully before you attempt installation.

Note 1: The following windows illustrations are examples only. You must follow the flow chart instructions and pay attention to the instructions which then appear on your screen.

Note 2: Install the HMI CD Driver into the system CD-ROM (D:\ means CD-ROM)

Before installing the Windows 2000/XP driver software, you must have the Windows 2000/XP system installed and running on your computer.

You must also have one of the following PenMount Serial Interface controller boards installed: 90A4, 9026B, 9036 or 9084. Contents of the PenMount Windows 2000/XP driver folder are listed below.

DMC9000.inf

DMC9000.sys

DMC9000.cat

SETUP.EXE

If you have an older version of the PenMount Windows 2000/XP driver installed in your system, please remove it first. Follow the steps below to install the PenMount Windows 2000/XP driver.

1. When the system first detects the controller board, a screen appears that shows “Unknown Device.” Do not use this hardware wizard. Press Cancel.



2. Insert the PenMount Driver CD-ROM. Go to the Windows 2000-XP Driver folder. Click **setup.exe**.

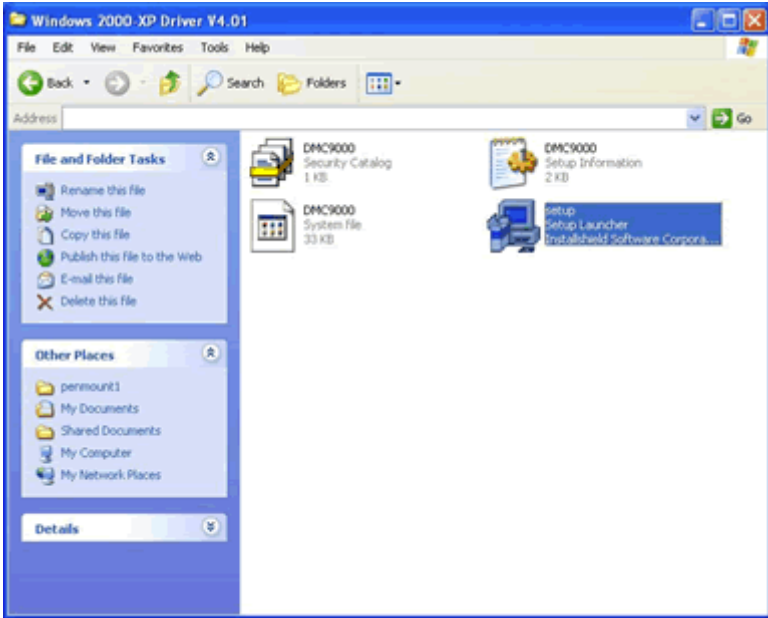

3. The screen displays the installation wizard for the PenMount software. Click "Next".

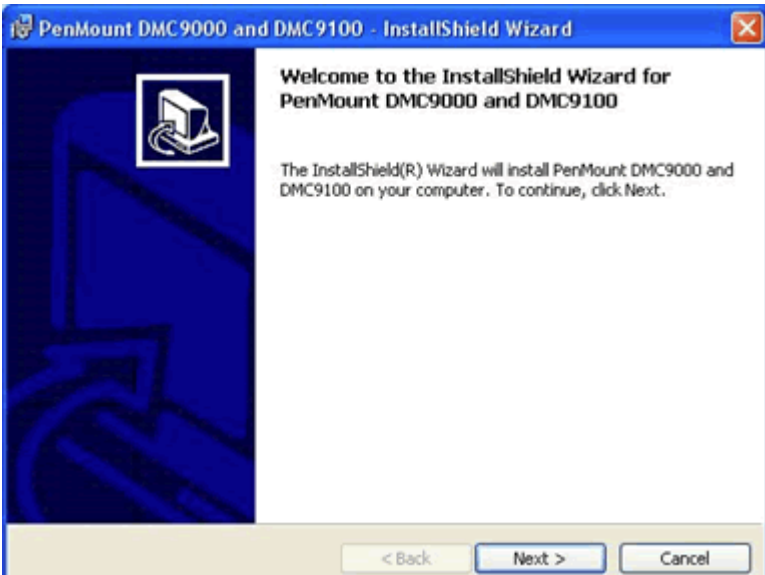

4. A License Agreement appears. Click “I accept...” and “Next”

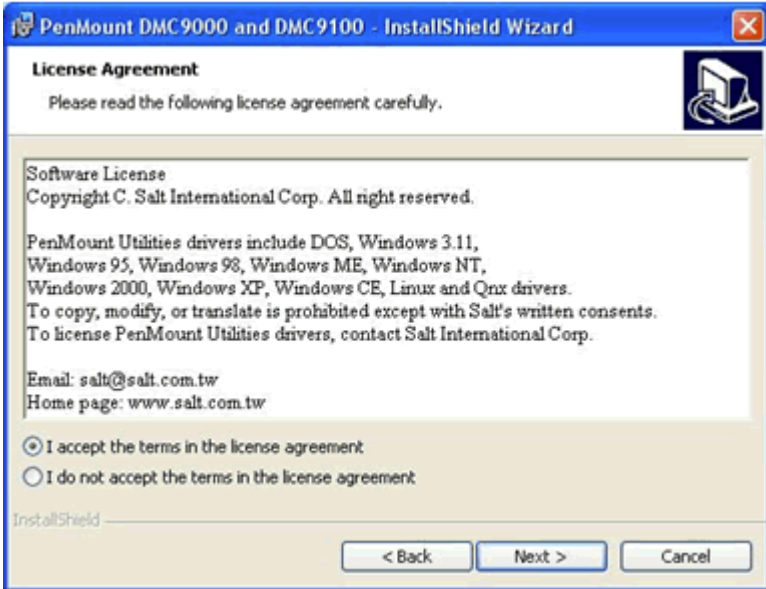

5. The “Ready to Install the Program” screen appears. Select “Install.”

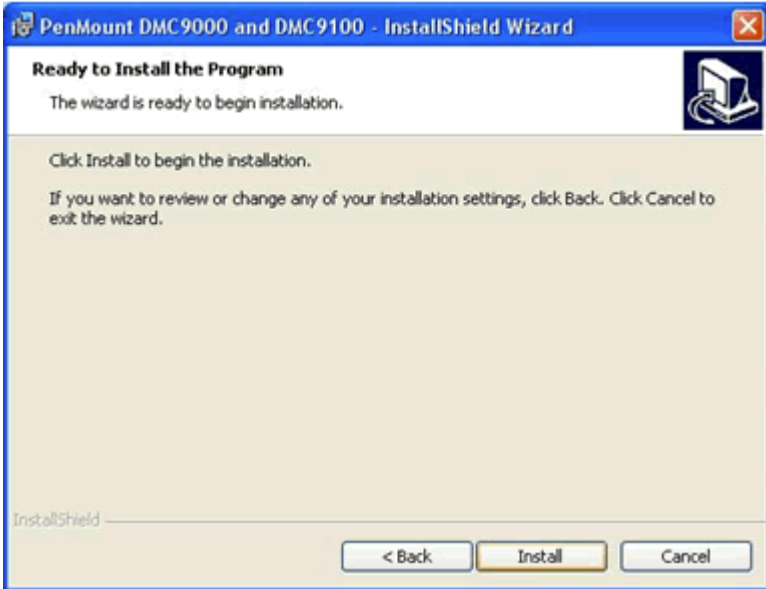

6. The next screen is “Hardware Installation.” Select “Continue Anyway.”



7. The “InstallShield Wizard Completed” appears. Click “Finish.”

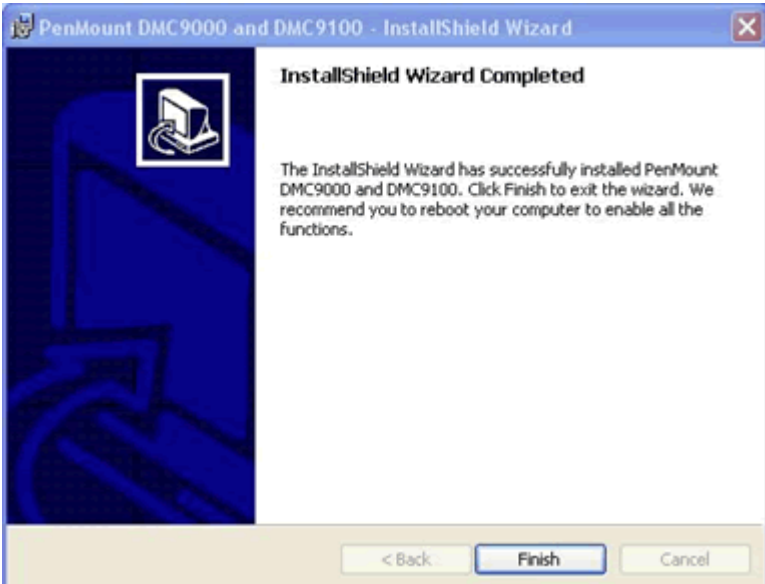

8.4 Configuring PenMount Windows 2000/XP Driver

Upon rebooting, the computer automatically finds the new 9000 controller board. The touch screen is connected but not calibrated. Follow the procedures below to carry out calibration.

1. After installation, click the PenMount Monitor icon “PM” in the menu bar.
2. When the PenMount Control Panel appears, click “Calibrate.”

8.4.1 PenMount Control Panel

The functions of the PenMount Control Panel are Calibrate, Draw, Multiple Monitors, Option, and About, which are explained in the following sections.

Calibrate

This function offers two ways to calibrate your touch screen. ‘Standard Calibration’ adjusts most touch screens. ‘Advanced Calibration’ adjusts aging touch screens.

| | |
|----------------------|--|
| Standard Calibration | Click this button and arrows appear pointing to red squares. Use your finger or stylus to touch the red squares in sequence. After the fifth red point calibration is complete. To skip, press ‘ESC’. |
| Advanced Calibration | Advanced Calibration uses 4, 9, 16 or 25 points to effectively calibrate touch panel linearity of aged touch screens. Click this button and touch the red squares in sequence with a stylus. To skip, press ‘ESC’. |



NOTE: *The older the touch screen, the more Advanced Mode calibration points you need for an accurate calibration. Use a stylus during Advanced Calibration for greater accuracy.*

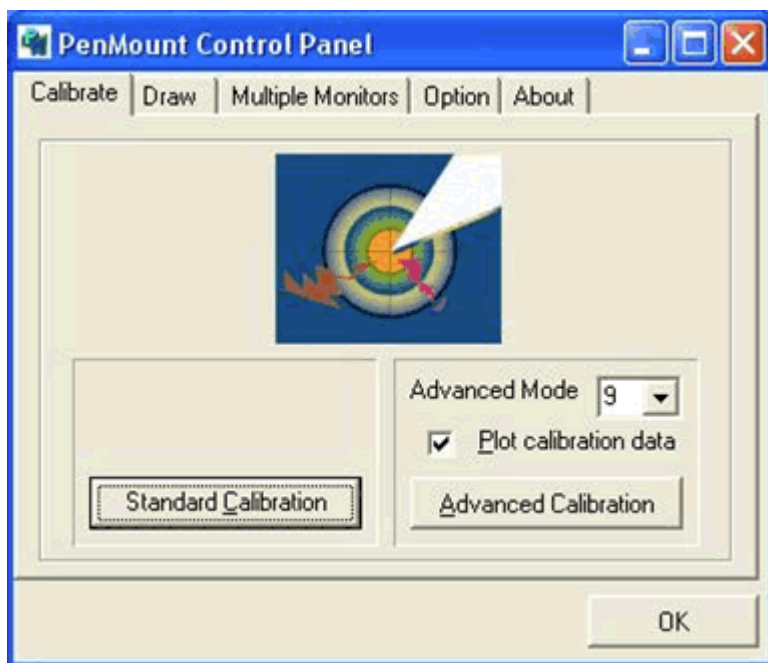
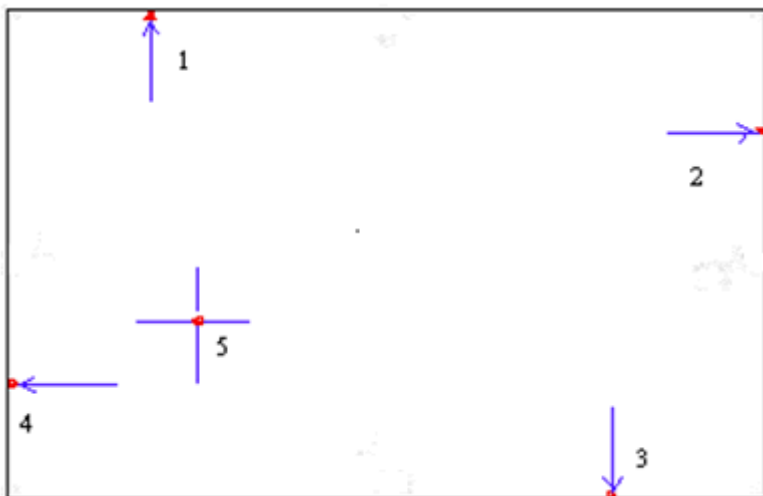



Plot Calibration Data

Check this function and a touch panel linearity comparison graph appears when you have finished Advanced Calibration. The blue lines show linearity before calibration and black lines show linearity after calibration.

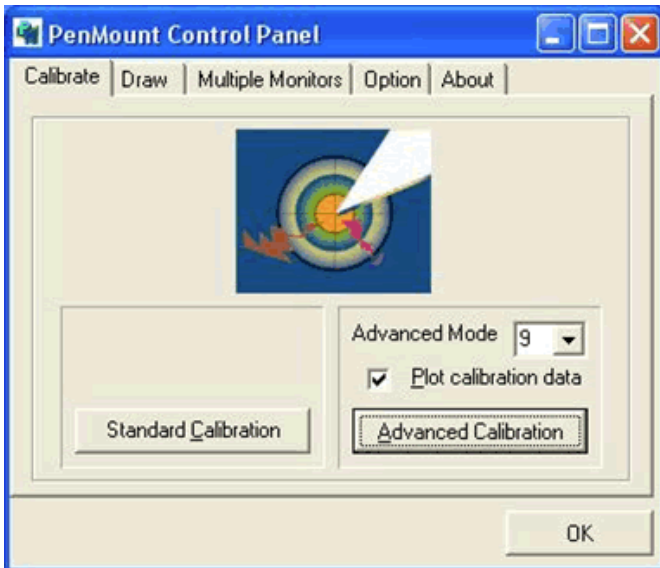

Draw

Tests or demonstrates the PenMount touch screen operation. The display shows touch location. Click Draw to start. Touch the screen with your finger or a stylus and the drawing screen registers touch activity such left, right, up, down, pen up, and pen down.

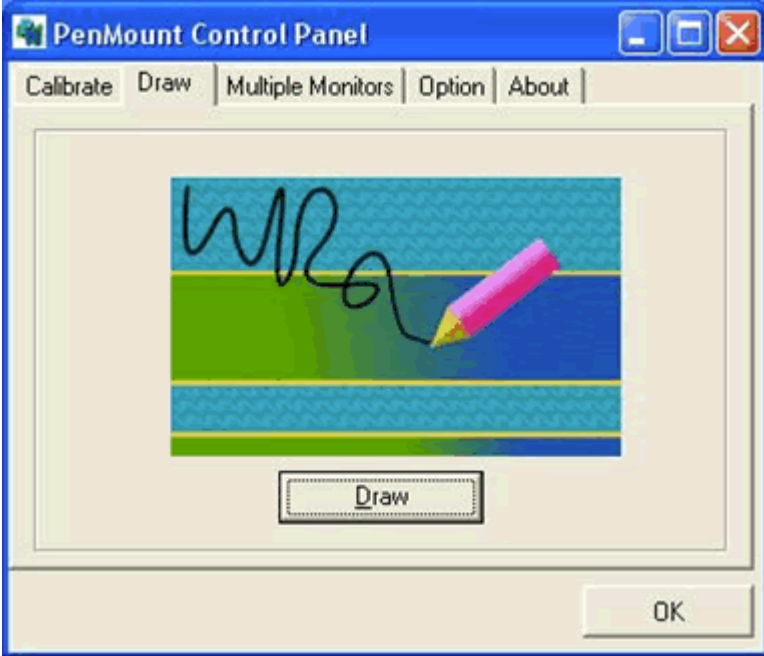

Touch the screen with your finger or a stylus and the drawing screen registers touch activity such left, right, up, down, pen up, and pen down.



Click Clear Screen to clear the drawing.

Multiple Monitors

Multiple Monitors supports from two to six touch screen displays for one system. The PenMount drivers for Windows 2000/XP support Multiple Monitors. This function supports from two to six touch screen displays for one system. Each monitor requires its own PenMount touch screen control board, either installed inside the display or in a central unit. The PenMount control boards must be connected to the computer COM ports via the RS-232 interface. Driver installation procedures are the same as for a single monitor. Multiple Monitors supports the following modes:

Windows Extend Monitor Function

Matrox DualHead Multi-Screen Function

nVidia nView Function

NOTE: *The Multiple Monitors function is for use with multiple displays only. Do not use this function if you have only one touch screen display. Please note once you turn on this function the Rotating function is disabled.*

Enable the multiple display function as follows:

1. Check the **Enable Multiple Monitor Support** box; then click **Map Touch Screens** to assign touch controllers to displays.

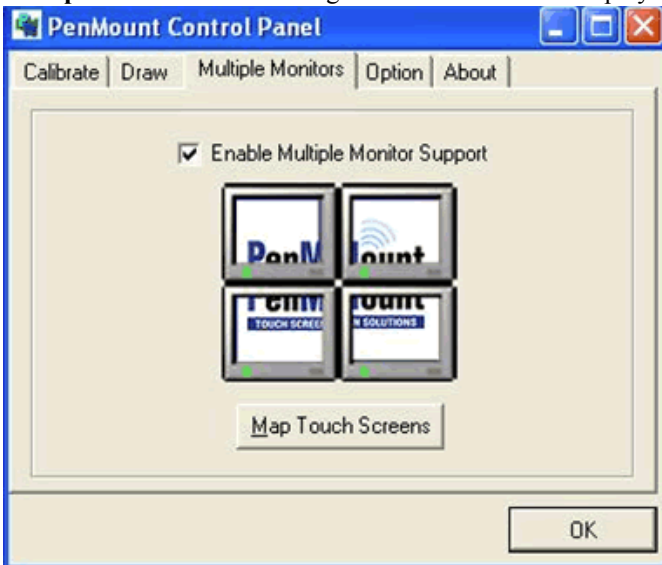

2. When the mapping screen message appears, click OK.

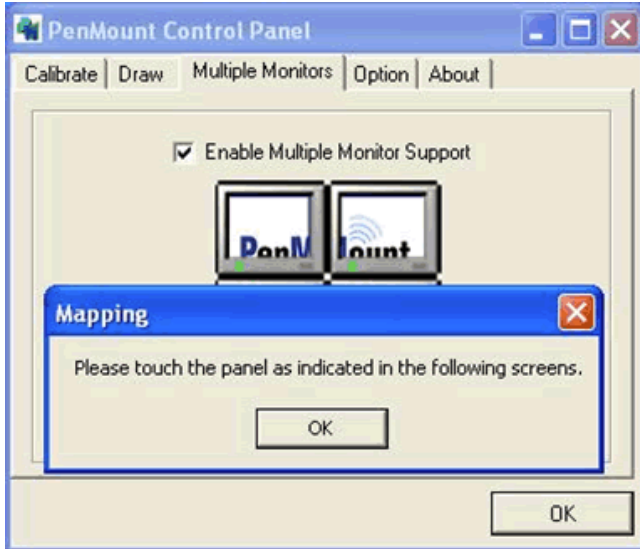

3. Touch each screen as it displays "Please touch this monitor." Following this sequence and touching each screen is called **mapping the touch screens**.



4. Touching all screens completes the mapping and the desktop reappears on the monitors.

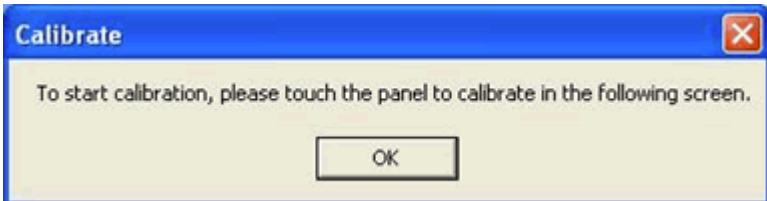

5. Select a display and execute the 'Calibration' function. A message to start calibration appears. Click OK.

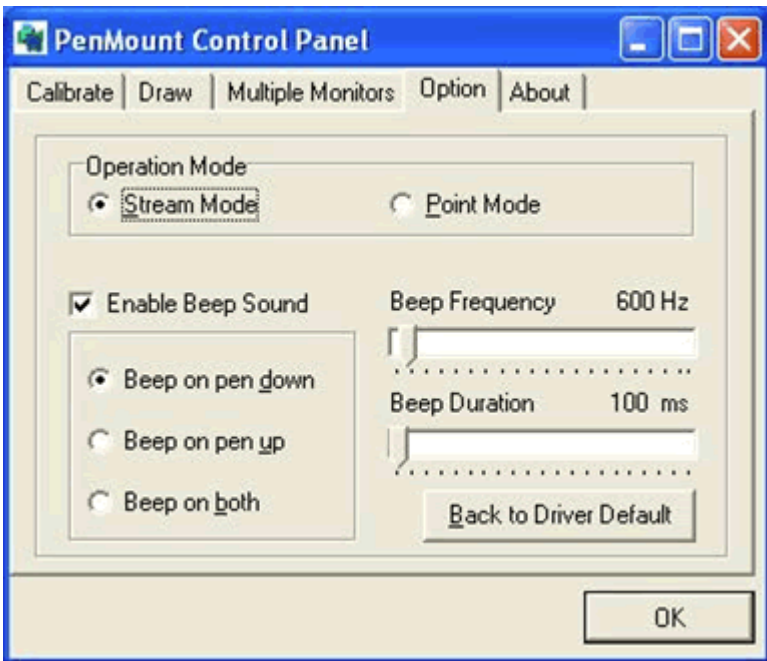

6. "Touch this screen to start its calibration" appears on one of the screens. Touch the screen.
7. "Touch the red square" messages appear. Touch the red squares in sequence.
8. Continue calibration for each monitor by clicking **Standard Calibration** and touching the red squares.

- NOTE:**
1. *If you used a single VGA output for multiple monitors, please do not use the Multiple Monitors function. Just follow the regular procedure for calibration on each of your desktop monitors.*
 2. *The Rotating function is disabled if you use the Multiple Monitors function.*
 3. *If you change the resolution of display or screen address, you have to redo Map Touch Screens so the system understands where the displays are.*

Option

This panel function supports two modes—Operation Mode and Beep Sound Mode—which allow configuration for specific touch screen applications, such as point-of-sales (POS) terminals.

| | |
|-----------------|--|
| Operation Mode | <p>This mode enables and disables the mouse's ability to drag on-screen icons—useful for configuring POS terminals.</p> <p><i>Stream Mode</i> – Select this mode and the mouse functions as normal and allows dragging of icons.</p> <p><i>Point Mode</i> – Select this mode and the mouse only provides a click function, and dragging is disabled.</p> |
| Beep Sound Mode | <p><i>Enable Beep Sound</i> – turns beep function on and off</p> <p><i>Beep on Pen Down</i> – beep occurs when pen comes down</p> <p><i>Beep on Pen Up</i> – beep occurs when pen is lifted up</p> <p><i>Beep on both of Pen Down/Up</i> – beep occurs on both</p> <p><i>Beep Frequency</i> – modifies sound frequency</p> <p><i>Beep Duration</i> – modifies sound duration</p> |

About

This panel displays information about the PenMount controller and driver version.

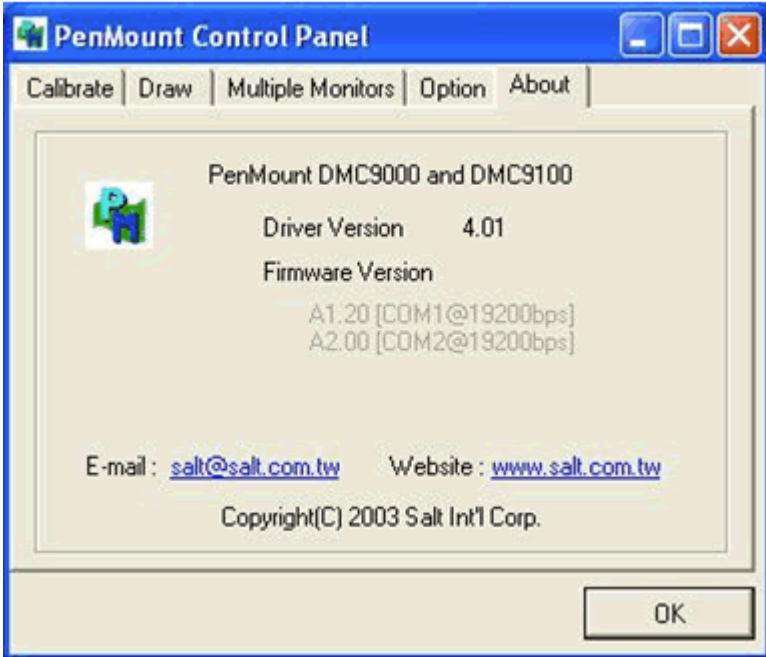

8.4.2 PenMount Monitor Menu Icon

The PenMount monitor icon (PM) appears in the menu bar of Windows 2000/XP system when you turn on PenMount Monitor in PenMount Utilities.



PenMount Monitor has the following functions.



Beep Turns beep on or off.

Right Button When you select this function, a mouse icon appears in the right-bottom of the screen. Click this icon to switch between Right and Left Button functions.



Pen Stabilizer Check this function to reduce cursor vibration for relatively unstable touch screens, or where there may be excess vibration. Normally this function is not checked.

Exit Exits the PenMount Monitor function.

8.4.3 PenMount Rotating Functions

The PenMount driver for Windows 2000/XP supports several display rotating software packages. Please see Chapter 5 for more information. The PenMount drivers for Windows 95, Windows 98/Me, Windows 2000/XP, as well as Windows 98 USB and Windows Me/2000/XP support display rotating software packages such as:

- Portrait's Pivot Screen Rotation Software
- ATI Display Driver Rotate Function
- nVidia Display Driver Rotate Function
- SMI Display Driver Rotate Function
- Intel 845G/GE Display Driver Rotate Function

Configuring the Rotate Function

1. Install the rotation software package.
2. Choose the rotate function (0°, 90°, 180°, 270°) in the 3rd party software. The calibration screen appears automatically. Touch this point and rotation is mapped.

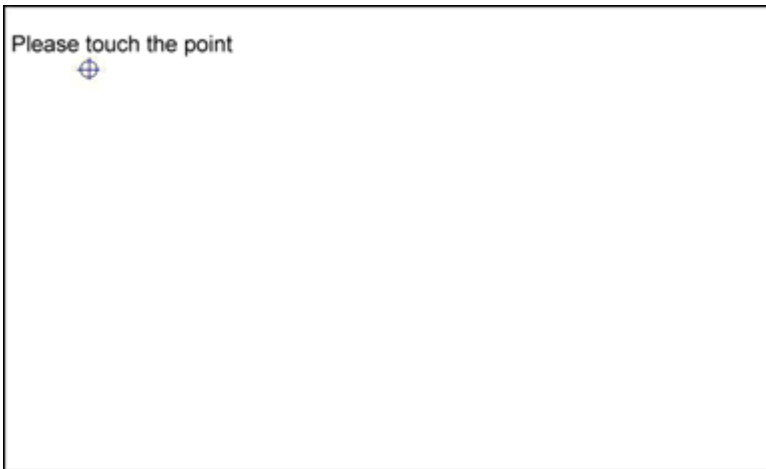

NOTE: The Rotate function is disabled if you use Monitor Mapping

8.5 Uninstall the PenMount Windows 2000/XP driver

1. Exit the PenMount monitor (PM) in the menu bar.
2. Go to Settings, then Control Panel, and then click Add/Remove program. Select PenMount DMC9000 and click the Add/Remove button.

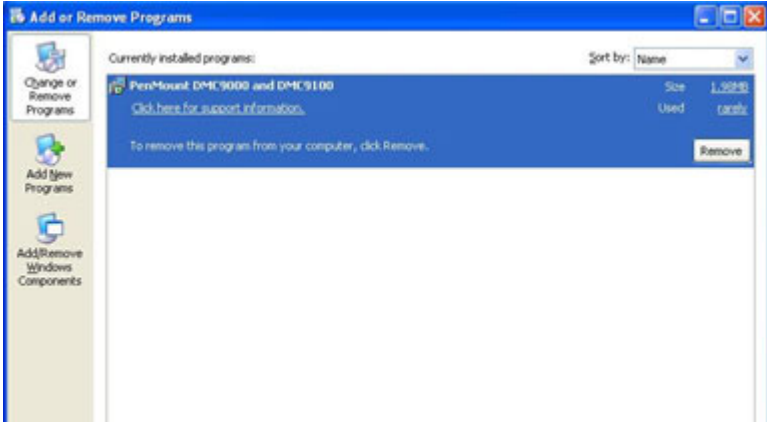

3. Select PenMount DMC9000 and DMC9100. Click the Remove button.

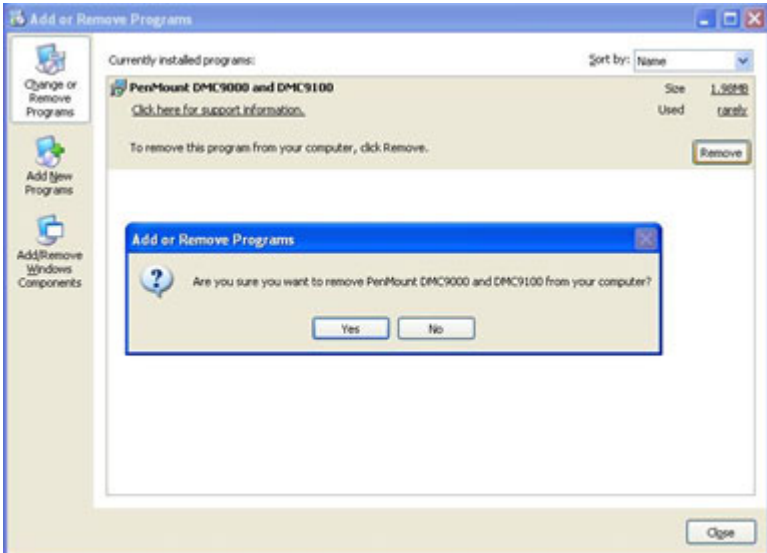

4. Select 'Yes' and "Close" to remove the PenMount Windows 2000/XP driver, and reboot the system.

PCMCIA

Sections include:

- Introduction
- Installation of PCMCIA driver for Windows

Chapter 9 PCMCIA

9.1 Introduction

The IPPC-9151 is equipped with a high performance PCMCIA interface which complies with the 1995 PCMCIA card standard by using the RICOH Cardbus controller. The panel PC supports two PCMCIA card/ cardbus slots. Two sockets support both a 16-bit PCMCIA card and a 32-bit Cardbus simultaneously, with hot insertion and removal.

9.2 Installation of PCMCIA Driver

The PCMCIA driver for Windows 95 is included in the "Drivers and Utilities" CD-ROM included with your IPPC-9151. The installation procedure is shown in the next section in this chapter.

Other operating systems such as Windows 98 and Windows NT also support PCMCIA drivers. However, the drivers for these operating systems are not included in the "Drivers and Utilities" CD-ROM. Installation for these operating systems is not explained in this manual..

Important: 1. *The following windows illustrations are examples only. You must follow the flow chart instructions and pay attention to the instructions which then appear on your screen.*

Notes: 1. *The CD-ROM drive is designated as "D" throughout this chapter.*
2. *<Enter> means pressing the "Enter" key on the keyboard.*

9.2.1 Installation for Windows

1. a. In "Start", "Run", type the path:
"D:\IPPC-9151G& 9171G_DRV&Utility\CardReader
\Drivers\Windows\Setup.exe"

Setup

Installation actions are now being performed.

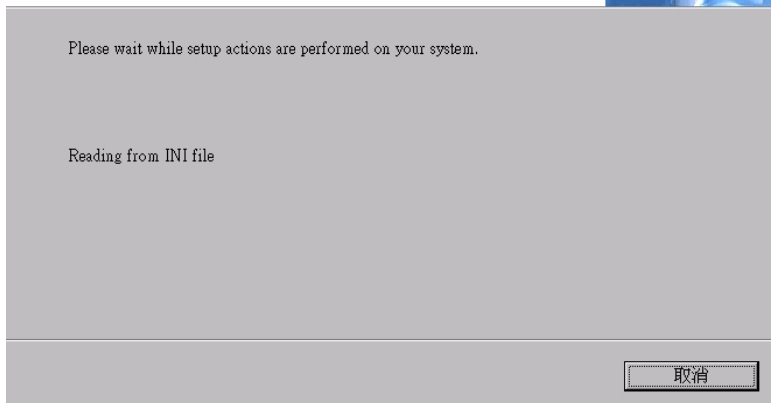

2. a. Click "Next" to continue the installation.
3. a. Click "Yes".

CHAPTER 10

Award BIOS Setup

This chapter describes how to set BIOS configuration data

Chapter 10 Award BIOS Setup

10.1 Award BIOS Setup

The IPPC-9151 comes with an Award BIOS chip that contains the ROM setup for your system. This chip serves as an interface between the processor and the rest of the mainboard's components. This chapter explains the information contained in the setup program and tells you how to modify the settings according to your system configuration. Some setup items will not be explained, because it is recommended that users do not change such items.

Note: Values for the various setup items that appear on your own screen (including default values) may not be the same as the values shown on the screen figures in this chapter. This is because the BIOS is revised and updated from time to time. If in doubt, check Advantech's website for the latest BIOS versions and related information.

10.2 CMOS Setup Utility

A setup program, built into the system BIOS, is stored in the CMOS RAM that allows the configuration settings to be changed. This program is executed when the user changes the system configuration; when the user changes the system backup battery; or when the system detects a configuration error and asks the user to run the setup program. At power-on RAM testing, the message "Press DEL to enter Setup" appears. After pressing the "DEL" key, the CMOS setup utility screen will appear as shown in followings. Use the arrow keys to select and press "Enter" to run the selected program.

| | |
|---|--|
| Standard CMOS Features Advanced BIOS Features Advanced Chipset Features Integrated Peripherals Power Management Setup PnP/PCI Configurations | Frequency/Voltage Control Load Optimized Defaults Set Password Save & Exit Setup Exit without Saving |
| Esc : Quit F10 : Save & Exit Setup | |
| ↑ ↓ → ← : Select Item | |
| Time, Date, hard disk Type... | |

10.2.1 Standard CMOS Setup

Standard CMOS Setup records some basic system hardware configuration and sets the system clock and error handling. You only need to modify the configuration values of this option if you want to change your system hardware configuration or when the data stored in the CMOS memory gets lost or damaged.

Run the STANDARD CMOS SETUP as follows:

1. Choose "STANDARD CMOS SETUP" from the Main Menu and a screen with a list of options will appear:

| | | |
|-----------------------|---------------------|------------|
| Date (mm:dd:yy) | Mon, January 1 2001 | Item Help |
| Time (hh:mm:ss) | 12 : 05 : 55 | Menu Level |
| IDE Primary Master | None | |
| IDE Primary Slave | None | |
| IDE Secondary Master | None | |
| IDE Secondary Slave | None | |
| Drive A | 1.44M, 3.5 in. | |
| Drive B | None | |
| Video | EGA/VGA | |
| Halt On | All Errors | |
| Select Display Device | Auto | |
| TV Type | NTSC | |
| Base Memory | 640K | |
| Extended Memory | 31744K | |
| Total Memory | 32768K | |

Figure 10.1: Standard CMOS features

- Use one of the arrow keys to move between options and modify the selected options by using PgUp / PgDn / + / - keys.

Date (mm:dd:yy)

The BIOS determines the day of the week from the other date information. This field is for information only. Press the left or right arrow key to move to the desired field (date, month, year). Press the PgUp or PgDn key to increment the setting, or type the desired value into the field.

Time (hh:mm:ss)

The time format is based on the 24-hour military-time clock. For example, 1 p.m. is 13:00:00. Press the left or right arrow key to move to desired field. Press the PgUp or PgDn key to increment the setting, or type the desired value into the field.

Primary / Secondary & Master / Slave

This field records the specifications for all non-SCSI hard disk drives installed in your system. Refer to the respective documentation on how to install the drives.

| | | |
|-----------------------------------|--------------|------------|
| IDE HDD Auto-Detection | Press Enter | Item Help |
| IDE Primary Master Access mode | Auto Auto | Menu Level |
| Capacity | 13022 MB | |
| Cylinder | 25232 | |
| Head | 16 | |
| Percomp | 0 | |
| Landing Zone | 25231 | |
| Sector | 63 | |

Figure 10.2: Standard CMOS features

Drive A / Drive B

Select this field to the type(s) of floppy disk drive(s) installed in your system. The choices are:

360 KB, 5.25 in;

1.2 MB, 5.25 in;

720 KB, 3.5 in;

1.44 MB, 3.5 in;

2.88 MB, 3.5 in;

None.

Video

Select the type of primary video subsystem in your computer. The BIOS usually detects the correct video type automatically. The BIOS supports a secondary video subsystem, but you do not select it in setup.

Halt On

During the power-on self-test (POST), the computer stops if the BIOS detects a hardware error. You can tell the BIOS to ignore certain errors during POST and continue the boot-up process.

Select Display Device

Select this field to the display device. The choices are:

Auto

CRT

LCD

CRT+LCD

TV

CRT+TV

TV Type

Select this field to the type of TV. The choices are:

NTSC

PAL

Base Memory

Typically 640KB. Also called conventional memory. The DOS operating system and conventional applications use this area.

Extended Memory

Above the 1MB boundary. Early IBM personal computers could not use memory above 1MB, but current PCs and their software can use extended memory.

Total Memory

This option shows system memory capacity.

3. Press <ESC> to return to the Main Menu when you finish setting up all items.

10.3 Advanced BIOS Features

Advanced BIOS Features improves your system performance or sets up system features according to your preference.

Run the ADVANCED BIOS FEATURES as follows:

1. Choose “Advanced BIOS Features” from the Main Menu and a screen with a list of options will appear.
2. Use one of the arrow keys to move between options and modify the selected options by using PgUp / PgDn / + / - keys.

| | | |
|----------------------------|----------|------------|
| Virus Warning | Disabled | Item Help |
| CPU Internal Cache | Enabled | Menu Level |
| External Cache | Enabled | |
| CPU L2 Cache ECC Checking | Enabled | |
| Processor Number Feature | Enabled | |
| Quick Power On Self Test | Enabled | |
| First Boot Device | Floppy | |
| Second Boot Device | HDD-0 | |
| Third Boot Device | CDROM | |
| Boot Other Device | Enabled | |
| Swap Floppy Drive | Disabled | |
| Boot Up Floppy Seek | Enabled | |
| Boot Up NumLock Status | On | |
| Gate A20 Option | Fast | |
| Typematic Rate Setting | Disabled | |
| Typematic Rate (Chars/Sec) | 6 | |
| Typematic Delay (Msec) | 250 | |
| Security Option | Setup | |
| PS/2 Mouse Function | | |
| OS Select For DRAM > 64MB | Non-OS2 | |
| Reports No FDD For Win95 | | |
| Video BIOS Shadow | Enabled | |
| C8000-CBFFF Shadow | Disabled | |
| CC000-CFFFF Shadow | Disabled | |
| D0000-D3FFF Shadow | Disabled | |
| D4000-D7FFF Shadow | Disabled | |
| D8000-DBFFF Shadow | Disabled | |
| DC000-DFFFF Shadow | Disabled | |
| Small Logo (EPA) Show | | |

Virus Warning

When enabled, you receive a warning message if a program (specifically, a virus) attempts to write to the boot sector or the partition table of the hard disk drive.

You should then run an antivirus program. Keep in mind that this feature protects only the boot sector, not the entire hard drive.

Note: Many disk diagnostic programs that access the boot sector table can trigger the virus warning message. If you plan to run such a program, we recommend that you disable the virus warning.

CPU Internal Cache/External Cache

Cache memory is additional memory that is much faster than conventional DRAM (system memory). CPUs from 486-type up contain internal cache memory, and most, but not all, modern PCs have additional (external) cache memory. When the CPU requests data, the system transfers the requested data from the main DRAM into cache memory, for faster access by the CPU.

CPU L2 Cache ECC Checking

When you select Enabled, it will speed up memory checking when the external cache contains ECC SRAMs. The choices: Enabled; Disabled.

Processor Number Feature

Choose Disabled or Enabled. When enabled, the processor serial number will display during the boot up screen.

Quick Power On Self Test

Select Enabled to reduce the amount of time required to run the power-on self-test (POST). A quick POST skips certain steps. We recommend that you normally enable quick POST.

First/Second/Third/Other Boot Device

The BIOS attempts to load the operating system from the devices in the sequence selected in these items. The choices: Floppy; LS/ZIP; HDD; SCSI; CDROM; Disabled.

Swap Floppy Drive

When enabled, floppy drives A and B will be exchanging without any physical connection and modification on the cables.

Boot Up Floppy Seek

When enabled, the BIOS tests (seeks) floppy drives to determine whether they have 40 or 80 tracks. Only 360-KB floppy drives have 40 tracks; drives with 270KB, 1.2MB, and 1.44MB capacity all have 80 tracks. Because very few modern PCs have 40-track floppy drives, we recommend that you set this field to disabled to save time.

Boot Up NumLock Status

Toggle between On or Off to control the state of the NumLock key when the system boots. If On, the numeric keypad is in numeric mode. If off, the numeric keypad is in cursor control mode.

Gate A20 Option

Gate A20 refers to the way the system addresses memory above 1 MB (extended memory). When set to Fast, the system chipset controls Gate A20. When set to Normal, a pin in the keyboard controller controls Gate A20. Setting Gate A20 to Fast improves system speed, particularly with OS/2 and Windows.

Typematic Rate Setting

When Disabled, the following two items (Typematic Rate and Typematic Delay) are irrelevant. Keystroke repeats at a rate determined by the keyboard controller in your system. When Enabled, you can select a typematic rate and typematic delay.

Typematic Rate (Chars / Sec)

When the typematic rate setting is enabled, you can select a typematic rate (the rate at which character repeats when you hold down a key) of 6, 8, 10, 12, 15, 20, 24, or 30 characters per second.

Typematic Delay (Msec)

Choices: 250; 500; 750; 1000. This option sets the time interval for displaying the first and the second characters. If enabled, the time interval is optional.

Security Option

If you have set a password, select whether the password is required every time the System boots, or only when you enter setup. The choices: system; setup.

PS/2 Mouse Function

Disabled: Prevents any installed PS/2 mouse from functioning but free up occupied IRQ.

Enabled: Allows the operating system to determine whether to enable or disable the mouse.

OS Select For DRAM > 64MB

Select OS2 only if you are running OS/2 operating system with greater than 64MB of RAM on your system.

Reports No FDD For Win95

Video BIOS Shadow

Performance will be improved by copying Video BIOS to Shadow RAM.

C8000-CBFFF to DC000-DFFFF Shadow

These options are used to shadow other expansion card ROMs.

Small Logo (EPA) show

3. Press <ESC> to return to the Main Menu when you finish setting up all items.

10.4 Advanced Chipset Features

Advanced Chipset Features is used to modify the values of chipset buffers. These buffers control the system options.

Run the Advanced Chipset Features as follows:

1. Choose “Advanced Chipset Features” from the Main Menu and a list of options will appear.

| | | Item Help |
|-------------------------|----------|------------|
| DRAM Timing by SPD | Enabled | Menu Level |
| DRAM Clock | Host CLK | |
| SDRAM Cycle Length | 3 | |
| Bank Interleave | Disabled | |
| Memory Hole | Enabled | |
| P2C/C2P Concurrency | Enabled | |
| System BIOS Cacheable | Enabled | |
| Video RAM Cacheable | Enabled | |
| Frame Buffer Size | 16M | |
| AGP Aperture Size | 64M | |
| APG-4X Mode | Enabled | |
| AGP Driving Control | Auto | |
| AGP Driving Value | DA | |
| Boot Device Select | Both | |
| OnChip USB | Enabled | |
| USB Keyboard Support | Disabled | |
| OnChip Sound | Enabled | |
| CPU to PCI Write Buffer | Enabled | |
| PCIDynamic Bursting | Enabled | |
| PCIMaster 0 WS Write | Enabled | |
| PCIDelay Transaction | Enabled | |
| PC#2 Access #1 Retry | Disabled | |
| AGP Master 1 WS Write | Disabled | |
| AGP Master 1 WS Read | Disabled | |

Use one of the arrow keys to move between options and modify the selected options by using PgUp / PgDn / + / - keys.

DRAM Timing by SPD

When this item is Enabled, DRAM Timing is set by SPD. SPD (Serial Presence Detect) is located on the memory modules, BIOS reads information coded in SPD during system boot up.

DRAM Clock

This item allows you to control the DRAM speed.

The choices are : Host Clock, HCLK+33M.

SDRAM Cycle Length

Select CAS latency time in HCLKs of 2 or 3. The system designer already set the values. Do not change the default value unless you change specifications of the installed DRAM or the installed CPU.

Bank Interleave

Please use default setting. The choices: Disabled; 2 Bank; 4 Bank.

Memory Hole

In order to improve performance, certain space in memory is reserved for ISA cards. This memory must be mapped into the memory space below 16 MB. The choices: 15M-16M; Disabled.

P2C/C2P Concurrency

This item allows you to enable/disable the PCI to CPU, CPU to PCI concurrency. The choices: Enabled; Disabled.

System BIOS Cacheable

selecting Enabled allows caching of the system BIOS ROM at F0000h-FFFFFh, resulting in better system performance.

Video RAM Cacheable

Selecting Enabled allows caching of the video memory (RAM) at A0000h to AFFFFh, resulting in better video performance. However, check your AGP manual to find out if any compatibility problem exists.

Frame Buffer size

This option allows you select memory size shared to on-chip graphics.

AGP Aperture Size

Series of options are available: 4, 8, 16, 32, 64, 128 or 256 MB. Memory mapped and graphics data structures can reside in a Graphics Aperture. This area is like a linear buffer. BIOS will automatically report the starting address of this buffer to the O.S. The default setting is 64 MB.

AGP- 4X Mode

This item allows you to enable AGP-4X mode. The choices are: Disabled, Enabled

AGP Driving Control

This item allows you to adjust the AGP driving force. Choose Manual to key in a AGP Driving Value in the next selection. This field is recommended to set in Auto for avoiding any error in your system. The choice: Manual, Auto.

AGP Driving Value

This item allows you to adjust the AGP driving force.

The choice: Min=0000 ~ Max=00FF.

Boot Device Select

This item allows you to select your boot display device. The choices are: Both, Auto

OnChip USB

This should be enabled if our system has a USB installed on the system board and you wish to use it. Even when so equipped, if you add a higher performance controller, you will need to disable this feature.

The choices: Enabled; Disabled.

USB Keyboard Support

Enable function when the USB keyboard is being used. When the AT keyboard is being used, choose disabled. The choices:Enabled; Disabled.

OnChip Sound

Select Enabled to use the on-chip Audio capability of your system. Most of the following field do not appear when this field is Disabled. For user who wants to use another sound card, this field must be Disabled.

CPU to PCI Write Buffer

When this field is Enabled, writes from the CPU to the PCI bus are buffered, to compensate for the speed differences between the CPU and the PCI bus. When Disabled, the writes are not buffered and the CPU must wait until the write is complete before starting another write cycle.

The choices: Enabled; Disabled.

PCI Dynamic Bursting

When Enabled, every write transaction goes to the write buffer. Bursting transactions then burst on the PCI bus and non-bursting transactions don't. The choices: Enabled; Disabled.

PCI Delay Transaction

Leave this field at default. The choice: Enabled, Disabled.

PCI Master 0 WS Write

When Enabled, writes to the PCI bus are executed with zero wait states.

The choice: Enabled, Disabled.

PCI # 2 Access # 1 Retry

Leave this field at default. The choice: Enabled, Disabled(default).

AGP Master 1 WS Write

Leave this field at default. The choice: Enabled, Disabled(default).

AGP Master 1 WS Read

Leave this field at default. The choice: Enabled, Disabled(default).

Press <ESC> to return to the Main Menu when you finish setting up all items.

10.5 Integrated Peripherals

Integrated Peripherals option allows you to get some information inside your system when it is working.

Run the INTEGRATED PERIPHERALS as follows:

1. Choose "Integrated Peripherals" from the Main Menu and a list of options will appear.
2. Use one of the arrow keys to move between options and modify the selected options by using PgUp / PgDn / + / - keys.

| | | |
|-------------------------|----------|------------|
| On-Chip IDE Channel 0 | Enabled | Item Help |
| On-Chip IDE Channel 1 | Enabled | Menu Level |
| IDE Prefetch Mode | Enabled | |
| Primary Master PIO | Auto | |
| Primary Slave PIO | Auto | |
| Secondary Master PIO | Auto | |
| Secondary Slave PIO | Auto | |
| Primary Master UDMA | Auto | |
| Primary Slave UDMA | Auto | |
| Secondary Master UDMA | Auto | |
| Secondary Slave UDMA | Auto | |
| Init Display First | PCI Slot | |
| IDE HDD Block Mode | Enabled | |
| Onboard FDD Controller | Enabled | |
| Onboard Serial Port 1 | Auto | |
| Onboard Serial Port 2 | Auto | |
| UART 2 Mode | Standard | |
| IR Function Duplex | Half | |
| TX, RX inverting enable | No, Yes | |
| Onboard Parallel Port | 378/IRQ7 | |
| Onboard Parallel Mode | Normal | |
| ECP Mode Use DMA | 3 | |
| Parallel Port EPP Type | EPP1.9 | |
| Onboard Serial Port 3 | | |
| Serial Port 3 use IRQ | | |
| Onboard Serial Port 4 | | |
| Serial Port 4 Use IRQ | | |
| Onboard Legacy Audio | Enabled | |
| Sound Blaster | Disabled | |

OnChip IDE Channel 0/1

The chipset contains a PCI IDE interface with support from two IDE channels. Select Enabled to activate the first and/or the second IDE interface. Select Disabled to inactivate an interface if you install a primary and/or second add-on IDE interface. The choices: Enabled; Disabled.

IDE Prefetch Mode

The on-board IDE drive supports IDE prefetching for faster drive accesses. If the IDE device doesn't support prefetching, set this field to Disabled. The choices: Enabled; Disabled.

Primary Master / Slave PIO & Secondary Master / Slave PIO

Choose Auto or Mode 0~4. The BIOS will detect the HDD mode type automatically when you choose Auto. You need to set to a lower mode than Auto when your hard disk becomes unstable.

The choices: Auto; Mode 0; Mode 1; Mode 2; Mode 3; Mode 4.

Primary Master / Slave UDMA & Secondary Master / Slave UDMA

Ultra DMA33/66/100 implementation is possible only if your IDE hard drive supports it, if the operating environment includes a DMA drive, and if your system software both support Ultra DMA33/66/100. Select "Auto" to enable BIOS support. The choices: Auto; Disabled.

Init Display First

Initialize the AGP video display before initializing any other display device on the system. Thus the AGP display becomes the primary display. The choices: PCI Slot; AGP.

IDE HDD Block Mode

Block mode is also called block transfer, multiple commands, or multiple sector read/write. If your IDE hard drive supports block mode (most new drives do), select Enabled for automatic detection of the optimal number of block read/write per sector the drive can support.

The choices: Enabled; Disabled.

Onboard FDD Controller

Select Enabled if your system has a floppy drive controller (FDC) installing in the system board and you want to use it. If you install add-in FDC or the system has no floppy drive, select Disabled in this field. The choices: Enabled; Disabled.

Onboard Serial Port 1 / Port2

Select an address and corresponding interrupt for the first and second serial ports.

The choices: 3F8/IRQ4; 2E8/IRQ3; 3E8/IRQ4; 2F8/IRQ3; Disabled; Auto.

UART 2 Mode

The second serial port on your system may offer a variety of infrared port modes. Click here for a description of various modes. (Click your browser's Back button, or your right mouse button, to return to this page.) The choices: Standard; HPSIR; ASKIR.

IR Function Duplex

This item allows you to select the IR half / full duplex function.

The choices: Half; Full.

TX, RX inverting enable

This item allows you to enable the TX, RX inverting which depends on different H/W requirement. This field is not recommended to change its default setting.

The choices: “No, No”; “No, Yes”; “Yes, No”; “Yes, Yes”.

Onboard Parallel Port

Select a logical LPT port name and matching address for the physical parallel (printer) port.

The choices: 378H/IRQ7; 278H/IRQ5; 3BC/IRQ7; Disabled.

Onboard Paralle Mode

Select an operating mode for the onboard parallel (printer) port. Select Normal, Compatible, or SPP unless you are certain your hardware and software both support one of the other available modes. The choices: SPP; EPP; ECP; ECP + EPP.

ECP Mode Use DMA

Select a DMA channel for the parallel port for use during ECP mode.

The choices: 3; 1.

Parallel Port EPP Type

Select EPP port type 1.7 or 1.9. The choices: EPP1.7; 1.9.

Onboard Legacy Audio

This field controls the on-board audio.

- Sound Blaster
- SB I/O Base Address
- SB IRQ Select
- SB DMA Select
- MPU-401
- MPU-401 I/O Address
- Game Port (200-207H)

3. Press <ESC> to return to the Main Menu when you finish setting up all items.

10.6 Power Management Setup

POWER MANAGEMENT SETUP allows you to set the system's power saving functions.

Run the POWER MANAGEMENT SETUP as follows:

1. Choose "Integrated Peripherals" from the Main Menu and a list of options will appear.
2. Use one of the arrow keys to move between options and modify the selected options by using PgUp / PgDn / + / - keys.

| | | |
|--------------------|-----------------|------------|
| ACPI Function | Disabled | Item Help |
| Power Management | Press Enter | Menu Level |
| PM Control by APM | Yes | |
| Video Off Option | Suspend --> Off | |
| Video Off Method | V/H SYNC+Blank | |
| MODEM Use IRQ | 3 | |
| Soft-Off by PWRBTN | Instand-Off | |
| Wake Up Events | Press Enter | |

ACPI Function

Select Enabled only if your computer's operating system supports the Advanced Configuration and Power Interface (ACPI) specification. Currently, Windows NT 5.0 supports ACPI.

Power Management

When this option is chosen, the following item appears for user's configuration.

| | | |
|------------------|-------------|------------|
| Power Management | User Define | Item Help |
| HDD Power Down | Disable | Menu Level |
| Doze Mode | Disable | |
| Suspend Mode | Disable | |

- **Power Management:** This option allows you to select the type (or degree) of power saving for Doze, Standby, and Suspend modes. This table describes the power management modes for your reference:

| | |
|-------------|---|
| Max Saving | Maximum power savings. Only Available for SL CPUs. Inactivity period is 1 minute in each mode. |
| User Define | Set each mode individually. Select time-out period in the section for each mode stated below. |
| Min Saving | Minimum power savings. Inactivity period is 1 hour in each mode (except the hard drive). |

- **HDD Power Down:** When enabled and after the set time of system inactivity, the hard disk drive will be powered down while all other devices remain active.
- **Suspend Mode:** After the selected period of system inactivity, the chipset enters a hardware suspend mode, stopping the CPU clock and possibly causing other system devices to enter power management modes.
- **Doze Mode:** After the selected period of system inactivity, the CPU clock runs at slower speed while all other devices still operate at full speed.

PM Control by APM

If Advanced Power Management (APM) is installed on your system, selecting “Yes” gives better power savings. The Choices: Yes; No.

Video Off Option

When enabled, this feature allows the VGA adapter to operate in a power saving mode.

| | |
|-----------------|---|
| Always On | Monitor will remain on during power saving modes. |
| Suspend → Off | Monitor blanked when the systems enters the Suspend mode. |
| All Modes → Off | Monitor blanked when the system enters either Suspend or Standby modes. |

Video Off Method

This determines the manner in which the monitor is blanked.

| | |
|------------------|---|
| V/H SYNC + Blank | This selection will cause the system to turn off the vertical and horizontal synchronization ports and write blanks to video buffer. |
| Blank Screen | This option only writes blanks to the video buffer. |
| DPMS Supports | Select this option if you monitor supports the Display Power Management Signaling (DPMS) standard of the Video Electronics Standards to select video power management values. |

MODEM Use IRQ

This determines the IRQ which the MODEM can use.

The choices: 3; 4; 5; 7; 9; 10; 11; NA.

Soft-Off by PWRBTN

When Enabled, turning the system off with the on/ off button places the system in a very low-powerusage state, with only enough circuitry receiving power to detect power button activity or Resume by Ring activity.

WAKE UP EVENTS

When this option is chosen, the following item appears for user's configuration.

| | | |
|---------------|-------------|------------|
| VGA | Off | Item Help |
| LPT & COM | LPT/COM | Menu Level |
| HDD & FDD | On | |
| PCIMaster | Off | |
| IRQs Activity | | |
| Monitoring | Press Enter | |

- **VGA:** When Enabled, you can set the VGA awakens the system.
- **LPT & COM:** When LPT & COM is ON, any activity from one of the listed system peripheral devices or IRQs wakes up the system.
- **HDD & FDD:** When HDD & FDD is ON, any activity from one of the listed system peripheral devices wakes up the system.
- **PCI Master:** When PCI Master is ON, any activity from one of the listed system peripheral devices wakes up the system.

- **Primary INTR:** When set to on, any event occurring at will awaken a system which has been powered down.

On(default):The system can not enter the power saving mode when I/O ports or IRQ# is activated. Off:The system still can enter the power saving mode when I/O ports or IRQ# is activated.

- **IRQ Activity Monitoring:** The following is a list of IRQ's (Interrupt Requests), which can be exempted much as the COM ports and LPT ports above can. When an I/O device wants to gain the attention of the operating system, it signals this by causing an IRQ to occur. When the operating system is ready to respond to the request, it interrupts itself and performs the service. When set On, activity will neither prevent the system from going into a power management mode nor awaken it.

When this option is chosen, the following item appears for user's configuration.

| | | Item Help |
|----------------------|----------|------------|
| IRQ-3 (COM2) | Enabled | Menu Level |
| IRQ-4 (COM1) | Enabled | |
| IRQ-5 (LPT2) | Enabled | |
| IRQ-6 (Floppy Disk) | Enabled | |
| IRQ-7 (LPT1) | Enabled | |
| IRQ-8 (RTC Alarm) | Disabled | |
| IRQ-9 (IRQ2 Redir) | Disabled | |
| IRQ-10 (Reserved) | Disabled | |
| IRQ-11 (Reserved) | Disabled | |
| IRQ-12 (PS/2 Mouse) | Enabled | |
| IRQ 13 (Coprocessor) | Disabled | |
| IRQ 14 (Hard Disk) | Enabled | |
| IRQ 15 (Reserved) | Disabled | |

3. Press <ESC> to return to the Main Menu when you finish setting up all items.

10.7 PnP/PCI Configuration

PnP/PCI Configuration allows you to modify the system's power saving functions.

Run the PnP/PCI Configuration as follows:

1. Choose "PnP/PCI Configuration" from the Main Menu and a list of options will appear.
2. Use one of the arrow keys to move between options and modify the selected options by using PgUp / PgDn / + / - keys.

| | | |
|--------------------------|-------------|------------|
| PNP OS Installed | No | Item Help |
| Reset Configuration Data | Disabled | Menu Level |
| Resources Controlled By | Auto(ESCD) | |
| IRQ Resources | Press Enter | |
| DMA Resources | Press Enter | |
| PCI/VGA Palette Snoop | Disabled | |
| Assign IRQ For VGA | Enabled | |
| Assign IRQ For USB | Enabled | |

PNP OS Installed

Select Yes if the system operating environment is Plug-and-Play aware (e.g. Windows 95).

Note: *BIOS will automatically disable all PnP resources except the boot device card when you select Yes on Non-PnP operating system.*

Reset Configuration Data

Normally, you leave this Disabled. Select Enabled to reset Extended System Configuration Data (ESCD), when you exit Setup if you have installed a new add-on and the system reconfiguration has caused such a serious conflict that the operating system cannot boot.

Resource Controlled By

The Plug and Play Award BIOS can automatically configure all the boot and Plug and Play-compatible devices. If you select Auto, all the interrupt request (IRQ) and DMA assignment fields disappear, as the BIOS automatically assigns them.

IRQ Resources

Press Enter. Please refer to the list below:

| | |
|--|------------|
| IR Q -9 assigned to P C I / I S A P n P | Item Help |
| | Menu Level |

DMA Resources

Press Enter. Please refer to the below list.

| | | |
|-------------------|-------------|------------|
| DMA-0 assigned to | PCI/ISA PnP | Item Help |
| DMA-1 assigned to | PCI/ISA PnP | Menu Level |
| DMA-3 assigned to | PCI/ISA PnP | |
| DMA-5 assigned to | PCI/ISA PnP | |
| DMA-6 assigned to | PCI/ISA PnP | |
| DMA-7 assigned to | PCI/ISA PnP | |

PCI/VGA Palette Snoop

This option allows the BIOS to preview VGA status, and to modify the information delivered from the feature Connector of the VGA card to MPEG card. This option can solve the display inversion to black after you have used MPEG card.

Assign IRQ for VGA

Select Enabled if you system has a VGA controller and you have one or more USB devices connected. If you are not using your system's VGA controller, select Disabled to free the IRQ resource.

Assign IRQ for USB

Select Enabled if you system has a USB controller and you have one or more USB devices connected. If you are not using your system's USB controller, select Disabled to free the IRQ resource.

3. Press <ESC> to return to the Main Menu when you finish setting up all items.

10.8 PC Health Status

This section helps you to get more information about your system including CPU temperature, FAN speed and voltage. It is recommended that you contact your mainboard supplier to get proper values about the setting of the CPU temperature.

Run the PC Health Status as follows:

1. Choose "PC Health Status" from the Main Menu and a list of options will appear.
2. Use one of the arrow keys to move between options and modify the selected options by using PgUp / PgDn / + / - keys.

| | |
|-----------------------|------------|
| Current CPUFAN1 Speed | Item Help |
| Current CPUFAN2 Speed | Menu Level |
| Vcore | |
| 2.5V | |
| 3.3V | |
| 5V | |
| 12V | |

Current CPU FAN1 Speed

Shows current CPU FAN1 speed. The fan must provide rotary pulse. (Normally these types of fan have a three-wire connector)

Current CPU FAN2 Speed

Shows current CPUFAN2 speed. The fan must provide rotary pulse. (Normally these types of fan have a three-wire connector)

Vcore/2.5V/3.3V/5V/1.2V

Shows power supply actual voltage value.

10.9 Frequency/Voltage Control

Run the Frequency/Voltage Control as follows:

1. Choose “Frequency/Voltage Control” from the Main Menu and a list of options will appear.
2. Use one of the arrow keys to move between options and modify the selected options by using PgUp / PgDn / + / - keys.

| | | |
|----------------------------|---------|------------|
| Auto Detect DIMM / PCI CLK | Enabled | Item Help |
| Spread Spectrum | Enabled | Menu Level |

Auto Detect DIMM/PCI CLK

To reduce the occurrence of electromagnetic interference (EMI), the BIOS detects the presence or absence of components in DIMM and PCI slots and turns off system clock generator pulses against empty slots.

Spread Spectrum

When the system clock generator pulses, the extreme values of the pulse generate excess EMI. Enabling pulse spectrum spread modulation changes the extreme values from spikes to flat curves, thus reducing EMI. This benefit may in some cases be outweighed by problems with timing-critical devices, such as a clock-sensitive SCSI device.

10.10 Load Optimized Defaults

When you press <Enter> on this item, you will get a confirmation dialog box with a message similar to:

“ Load Optimized Defaults (Y/N) ? N ”

“Y” is for “Yes”, and “N” is for “No”.

Pressing “Y” loads the BIOS default values that are factor settings for optimal performance of system operations.

10.11 Set Password

These option allows you to set your system passwords. The way to set up the password is as follows:

1. Choose “Change Password” in the Main Menu and press <Enter>. Then following message appears:
“Enter Password : “
2. The first time you run this option, enter your password up to 8 characters and press <Enter>. (The screen does not display the entered characters.)
3. After you enter the password, the following message appears prompting you to confirm the password:
“Confirm Password : “
4. Enter the same password “exactly” the same as you have just typed to confirm the password and press <Enter>.
5. Move the cursor to Save & Exit Setup to save the password.
6. If you need to delete the password entered before, choose the Supervisor Password and press <Enter>. It will delete the password that you have entered before.
7. Move the cursor to Save & Exit Setup to save the option you have just configured; otherwise the old password will still be there the next time you turn your system on.
8. Press <Enter> to exit to the Main Menu.

Note: *If you forget or lose the password, the only way to access the system is to clear the CMOS RAM. All setup informations will be lost and you need to run the BIOS setup program again.*

10.12 Save & Exit Setup

Save & Exit Setup allows you to save all modifications you have specified into the CMOS memory. Highlight this option on the Main Menu and the following message appears:

“Save to CMOS and Exit (Y/N) ? Y “

“Y” is for “Yes”, and “N” is for “No”.

Press <Enter> key to save the configuration changes.

10.13 Exit Without Saving

Exit Without Saving option allows you to exit the Setup Utility without saving the modifications that you have specified. Highlight this option on the Main Menu and the following message appears:

“Quit Without Saving (Y/N) ? N “

“Y” is for “Yes”, and “N” is for “No”.

You may change the prompt to “Y” and press <Enter> key to leave this option .

Appendix

A

LCD Specifications and Selection Settings

Appendix A LCD Specifications

IPPC-9120G/9150G/9151 Series LCD Specifications

| | IPPC-9120G | IPPC-9150G | IPPC-9151 |
|-----------------------|-----------------|------------------|-----------------|
| Display | 12.1" TFT LCD | 15" TFT LCD | 15" TFT LCD |
| Max. resolution | 800 X 600 | 1024 X 768 | 1024 X 768 |
| Colors | 262k | | |
| Dot pitch (mm) | 0.31 X 0.31 | | 0.29 X 0.29 |
| Viewing angle | 100°(H), 60°(V) | 120°(H), 100°(V) | |
| Luminance | 320 cd/sq meter | 250 cd/sq meter | 350 cd/sq meter |
| Viewing area | 246 x 184.5 mm | 304 x 228 mm | |
| Power consumption | 3.3V@0.25 A | 3.3V@1 A | |
| Operating temperature | 0 ~ 50° C | | |
| Storage temperature | -20 ~ 60° C | | |
| LCD MTBF | 50,000 hours | | |
| Backlight MTBF | 25,000 hours | | |

Note: *The color LCD display installed in the IPPC is of high quality and reliability. However, it may contain a few defective pixels which may not always illuminate. With current technology, it is impossible to completely eliminate defective pixels. Advantech is actively working to improve this technology.*

Appendix

B

Pin Assignments

Appendix B Pin Assignments

B.1 ATX Power connector 1 (CN1)

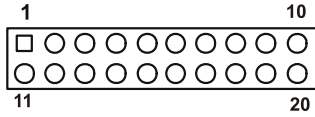

Table B.1: AT Power connector 1 (CN1)

| Pin | Signal | Pin | Signal |
|-----|--------|-----|--------|
| 1 | 3.3V | 11 | 3.3V |
| 2 | 3.3V | 12 | -12V |
| 3 | GND | 13 | GND |
| 4 | 5V | 14 | PS-ON |
| 5 | GND | 15 | GND |
| 6 | 5V | 16 | GND |
| 7 | GND | 17 | GND |
| 8 | PW-OK | 18 | -5V |
| 9 | 5VSB | 19 | 5V |
| 10 | 12V | 20 | 5V |

B.2 ATX power connector 2 (CN2)

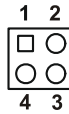

Table B.2: ATX power connector 2 (CN2)

| Pin | Signal | Pin | Signal |
|-----|--------|-----|--------|
| 1 | GND | 3 | 12V |
| 2 | GND | 4 | 12V |

B.3 LVDS connector 1(CN4)

Table B.3: LVDS connector 1(CN4)

| Pin | Signal | Pin | Signal |
|-----|--------|-----|---------|
| 1 | VDD | 11 | RXIN2+ |
| 2 | VDD | 12 | RXIN2- |
| 3 | GND | 13 | GND |
| 4 | GND | 14 | RXIN1+ |
| 5 | RXIN3+ | 15 | RXIN1- |
| 6 | RXIN3- | 16 | GND |
| 7 | GND | 17 | RXIN0+ |
| 8 | CLK0+ | 18 | RXIN0- |
| 9 | CLK0- | 19 | DDC_CLK |
| 10 | GND | 20 | DDC_DAT |

B.4 LVDS connector 2(CN6)

Table B.4: Table B.4: LVDS connector 2 (CN6)

| Pin | Signal | Pin | Signal |
|-----|--------|-----|----------|
| 1 | VDD | 11 | RXIN6+ |
| 2 | VDD | 12 | RXIN6- |
| 3 | GND | 13 | GND |
| 4 | GND | 14 | RXIN5+ |
| 5 | CLK1+ | 15 | RXIN5- |
| 6 | CLK1- | 16 | GND |
| 7 | GND | 17 | RXIN4+ |
| 8 | RXIN7+ | 18 | RXIN4- |
| 9 | RXIN7- | 19 | CONTRAST |
| 10 | GND | 20 | HPLG_DT |

B.5 Inverter power connector (CN5)

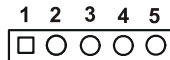

Table B.5: Inverter power connector (CN5)

| Pin | Signal |
|-----|-----------------|
| 1 | +12V |
| 2 | GND |
| 3 | ENABKL |
| 4 | Brightness Adj. |
| 5 | +5V |

B.6 FDD connector (CN9)

Table B.6: FDD connector (CN9)

| Pin | Signal | Pin | Signal |
|-----|----------------|-----|---------------|
| 1 | Vcc(+5V) | 14 | Step |
| 2 | Index | 15 | GND |
| 3 | Vcc(+5V) | 16 | Write data |
| 4 | Drive select | 17 | GND |
| 5 | Vcc(+5V) | 18 | Write enable |
| 6 | Disk change | 19 | GND |
| 7 | NC | 20 | Track 0 |
| 8 | NC | 21 | GND |
| 9 | NC | 22 | Write protect |
| 10 | Motor on | 23 | GND |
| 11 | NC | 24 | Read data |
| 12 | Direction | 25 | GND |
| 13 | Density select | 26 | Side 1 select |

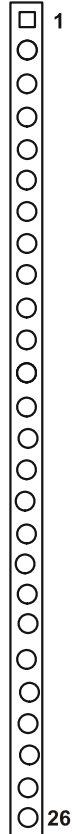

B.7 Internal speaker connector (CN15)

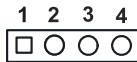

Table B.7: Internal speaker connector (CN15)

| Pin | Signal |
|-----|-----------------|
| 1 | Speaker out_R - |
| 2 | Speaker out_R + |
| 3 | Speaker out_L + |
| 4 | Speaker out_L - |

B.8 IR connector (CN24)

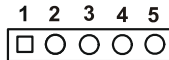

Table B.8: IR connector (CN24)

| Pin | Signal |
|-----|--------|
| 1 | Vcc |
| 2 | NC |
| 3 | IR_IN |
| 4 | GND |
| 5 | IR_OUT |

B.9 Fan power connector (FAN1 & FAN2)

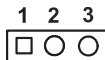

Table B.9: Fan power connector (FAN1 & FAN2)

| Pin | Signal |
|-----|---------|
| 1 | GND |
| 2 | +12V |
| 3 | FAN_DET |

Free Manuals Download Website

<http://myh66.com>

<http://usermanuals.us>

<http://www.somanuals.com>

<http://www.4manuals.cc>

<http://www.manual-lib.com>

<http://www.404manual.com>

<http://www.luxmanual.com>

<http://aubethermostatmanual.com>

Golf course search by state

<http://golfingnear.com>

Email search by domain

<http://emailbydomain.com>

Auto manuals search

<http://auto.somanuals.com>

TV manuals search

<http://tv.somanuals.com>