

ASUS[®]

Pundit P3-PH5

ASUS PC (Desktop Barebone)



Download the latest manual from the ASUS website: www.asus.com

E2789

First Edition V1
October 2006

Copyright © 2006 ASUSTeK COMPUTER INC. All Rights Reserved.

No part of this manual, including the products and software described in it, may be reproduced, transmitted, transcribed, stored in a retrieval system, or translated into any language in any form or by any means, except documentation kept by the purchaser for backup purposes, without the express written permission of ASUSTeK COMPUTER INC. ("ASUS").

Product warranty or service will not be extended if: (1) the product is repaired, modified or altered, unless such repair, modification or alteration is authorized in writing by ASUS; or (2) the serial number of the product is defaced or missing.

ASUS PROVIDES THIS MANUAL "AS IS" WITHOUT WARRANTY OF ANY KIND, EITHER EXPRESS OR IMPLIED, INCLUDING BUT NOT LIMITED TO THE IMPLIED WARRANTIES OR CONDITIONS OF MERCHANTABILITY OR FITNESS FOR A PARTICULAR PURPOSE. IN NO EVENT SHALL ASUS, ITS DIRECTORS, OFFICERS, EMPLOYEES OR AGENTS BE LIABLE FOR ANY INDIRECT, SPECIAL, INCIDENTAL, OR CONSEQUENTIAL DAMAGES (INCLUDING DAMAGES FOR LOSS OF PROFITS, LOSS OF BUSINESS, LOSS OF USE OR DATA, INTERRUPTION OF BUSINESS AND THE LIKE), EVEN IF ASUS HAS BEEN ADVISED OF THE POSSIBILITY OF SUCH DAMAGES ARISING FROM ANY DEFECT OR ERROR IN THIS MANUAL OR PRODUCT.

SPECIFICATIONS AND INFORMATION CONTAINED IN THIS MANUAL ARE FURNISHED FOR INFORMATIONAL USE ONLY, AND ARE SUBJECT TO CHANGE AT ANY TIME WITHOUT NOTICE, AND SHOULD NOT BE CONSTRUED AS A COMMITMENT BY ASUS. ASUS ASSUMES NO RESPONSIBILITY OR LIABILITY FOR ANY ERRORS OR INACCURACIES THAT MAY APPEAR IN THIS MANUAL, INCLUDING THE PRODUCTS AND SOFTWARE DESCRIBED IN IT.

Products and corporate names appearing in this manual may or may not be registered trademarks or copyrights of their respective companies, and are used only for identification or explanation and to the owners' benefit, without intent to infringe.

Contents

Notices.....	vi
Safety information	vii
About this guide	viii
System package contents.....	x

Chapter 1: System Introduction

1.1 Welcome!	1-2
1.2 Front panel.....	1-2
1.3 Rear panel.....	1-4
1.4 Internal components.....	1-6

Chapter 2: Basic Installation

2.1 Preparation	2-2
2.2 Before you proceed	2-2
2.3 Removing the covers.....	2-3
2.3.1 Removing the system cover.....	2-3
2.3.2 Removing the front panel assembly.....	2-4
2.4 Installing a CPU.....	2-5
2.4.1 CPU installation	2-5
2.4.2 Installing the CPU fan and heatsink assembly.....	2-8
2.5 Installing a DIMM.....	2-9
2.5.1 Memory configurations.....	2-9
2.5.2 Installing a DIMM	2-11
2.5.3 Removing a DIMM	2-11
2.6 Installing an expansion card.....	2-12
2.6.1 Expansion slots.....	2-12
2.6.2 Expansion card installation	2-12
2.7 Installing an optical drive.....	2-15
2.8 Removing the card reader.....	2-17
2.9 Installing hard disk drives (HDDs).....	2-18
2.9.1 Hard disk drive bays	2-18
2.9.2 SATA hard disk drive installation	2-18
2.9.3 IDE hard disk drive installation.....	2-20
2.9.4 Uninstalling a hard disk drive	2-20
2.10 Replacing the covers	2-21
2.10.1 Replacing the front panel assembly	2-21

Contents

2.10.2	Replacing the system cover	2-22
2.11	Installing the foot stands.....	2-23
2.12	Selecting the voltage	2-24
Chapter 3: Getting started		
3.1	Installing an operating system	3-2
3.2	Support CD information	3-2
3.2.1	Running the support CD	3-2
3.2.2	Drivers menu.....	3-3
3.2.3	Utilities menu	3-4
3.2.4	Make disk menu.....	3-5
3.2.5	Manual	3-6
3.2.6	ASUS contact information	3-6
3.2.7	Other information	3-7
Chapter 4: Motherboard info		
4.1	Motherboard overview.....	4-2
4.2	Jumper	4-3
4.3	Connectors	4-5
4.3.1	Rear panel connectors.....	4-5
4.3.2	Internal connectors	4-5
Chapter 5: BIOS setup		
5.1	Managing and updating your BIOS	5-2
5.1.1	Creating a bootable floppy disk.....	5-2
5.1.2	ASUS EZ Flash 2 utility.....	5-3
5.1.3	AFUDOS utility.....	5-4
5.1.4	ASUS CrashFree BIOS 3 utility	5-6
5.1.5	ASUS Update utility	5-8
5.2	BIOS setup program	5-11
5.2.1	BIOS menu screen.....	5-12
5.2.2	Menu bar.....	5-12
5.2.3	Navigation keys.....	5-12
5.2.4	Menu items	5-13
5.2.5	Sub-menu items.....	5-13
5.2.6	Configuration fields	5-13
5.2.7	Pop-up window	5-13

Contents

5.2.8	Scroll bar	5-13
5.2.9	General help	5-13
5.3	Main menu	5-14
5.3.1	System Time	5-14
5.3.2	System Date	5-14
5.3.3	Legacy Diskette A	5-14
5.3.4	Primary, Secondary, Third, Fourth IDE Master/Slave	5-15
5.3.5	IDE Configuration.....	5-16
5.3.6	System Information	5-17
5.4	Advanced menu	5-18
5.4.1	Jumperfree Configuration	5-18
5.4.2	USB Configuration	5-20
5.4.3	CPU Configuration	5-21
5.4.4	Chipset	5-23
5.4.5	Onboard Devices Configuration.....	5-25
5.4.6	PCI PnP	5-27
5.5	Power menu.....	5-28
5.5.1	Suspend Mode [Auto]	5-28
5.5.2	Repost Video on S3 Resume [Disabled].....	5-28
5.5.3	ACPI 2.0 Support [Disabled]	5-28
5.5.4	ACPI APIC Support [Enabled].....	5-28
5.5.5	APM Configuration.....	5-29
5.5.6	Hardware Monitor	5-30
5.6	Boot menu	5-31
5.6.1	Boot Device Priority	5-31
5.6.2	Boot Settings Configuration	5-32
5.6.3	Security	5-33
5.7	Tools menu	5-35
5.8	Exit menu	5-36

Appendix: CPU features

A.1	Intel® EM64T.....	A-2
A.2	Enhanced Intel SpeedStep® Technology (EIST).....	A-2
A.2.1	System requirements	A-2
A.2.2	Using the EIST	A-3
A.3	Intel® Hyper-Threading Technology.....	A-4

Notices

Federal Communications Commission Statement

This device complies with Part 15 of the FCC Rules. Operation is subject to the following two conditions:

- This device may not cause harmful interference, and
- This device must accept any interference received including interference that may cause undesired operation.

This equipment has been tested and found to comply with the limits for a Class B digital device, pursuant to Part 15 of the FCC Rules. These limits are designed to provide reasonable protection against harmful interference in a residential installation. This equipment generates, uses and can radiate radio frequency energy and, if not installed and used in accordance with manufacturer's instructions, may cause harmful interference to radio communications. However, there is no guarantee that interference will not occur in a particular installation. If this equipment does cause harmful interference to radio or television reception, which can be determined by turning the equipment off and on, the user is encouraged to try to correct the interference by one or more of the following measures:

- Reorient or relocate the receiving antenna.
- Increase the separation between the equipment and receiver.
- Connect the equipment to an outlet on a circuit different from that to which the receiver is connected.
- Consult the dealer or an experienced radio/TV technician for help.



WARNING! The use of shielded cables for connection of the monitor to the graphics card is required to assure compliance with FCC regulations. Changes or modifications to this unit not expressly approved by the party responsible for compliance could void the user's authority to operate this equipment.

Canadian Department of Communications Statement

This digital apparatus does not exceed the Class B limits for radio noise emissions from digital apparatus set out in the Radio Interference Regulations of the Canadian Department of Communications.

This class B digital apparatus complies with Canadian ICES-003.

Safety information

Electrical safety

- To prevent electrical shock hazard, disconnect the power cable from the electrical outlet before relocating the system.
- When adding or removing devices to or from the system, ensure that the power cables for the devices are unplugged before the signal cables are connected.
- If the power supply is broken, do not try to fix it by yourself. Contact a qualified service technician or your retailer.

Operation safety

- Before installing devices into the system, carefully read all the documentation that came with the package.
- Before using the product, make sure all cables are correctly connected and the power cables are not damaged. If you detect any damage, contact your dealer immediately.
- To avoid short circuits, keep paper clips, screws, and staples away from connectors, slots, sockets and circuitry.
- Avoid dust, humidity, and temperature extremes. Do not place the product in any area where it may become wet. Place the product on a stable surface.
- If you encounter technical problems with the product, contact a qualified service technician or your retailer.

Lithium-Ion Battery Warning

CAUTION: Danger of explosion if battery is incorrectly replaced. Replace only with the same or equivalent type recommended by the manufacturer. Dispose of used batteries according to the manufacturer's instructions.

VORSICHT: Explosionsgefahr bei unsachgemäßen Austausch der Batterie. Ersatz nur durch denselben oder einem vom Hersteller empfohlenem ähnlichen Typ. Entsorgung gebrauchter Batterien nach Angaben des Herstellers.

LASER PRODUCT WARNING

CLASS 1 LASER PRODUCT

About this guide

Audience

This guide provides general information and installation instructions about the ASUS Pundit P3-PH5 barebone system. This guide is intended for experienced users and integrators with hardware knowledge of personal computers.

How this guide is organized

This guide contains the following parts:

1. Chapter 1: System introduction

This chapter gives a general description of the barebone system. The chapter lists the system features including introduction on the front and rear panel, and internal components.

2. Chapter 2: Basic installation

This chapter provides step-by-step instructions on how to install components in the system.

3. Chapter 3: Getting started

This chapter helps you power up the system and install drivers and utilities from the support CD.

4. Chapter 4: Motherboard info

This chapter gives information about the motherboard that comes with the system. This chapter includes the motherboard layout, jumper settings, and connector locations.

5. Chapter 5: BIOS setup

This chapter tells how to change system settings through the BIOS Setup menu and describes the BIOS parameters.

6. Appendix: CPU features

The Appendix describes the CPU features and technologies that the motherboard supports.

Conventions used in this guide



WARNING: Information to prevent injury to yourself when trying to complete a task.



CAUTION: Information to prevent damage to the components when trying to complete a task.



IMPORTANT: Instructions that you **MUST** follow to complete a task.



NOTE: Tips and additional information to aid in completing a task.

Where to find more information

Refer to the following sources for additional information and for product and software updates.

1. **ASUS Websites**

The ASUS websites worldwide provide updated information on ASUS hardware and software products. Refer to the ASUS contact information.

2. **Optional Documentation**

Your product package may include optional documentation, such as warranty flyers, that may have been added by your dealer. These documents are not part of the standard package.

System package contents

Check your Pundit P3-PH5 system package for the following items.



If any of the items is damaged or missing, contact your retailer immediately.

Item description
1. ASUS Pundit P3-PH5 barebone system with
• ASUS motherboard
• 275 W PFC power supply unit
• 6-in-1 storage card reader
2. Accessories
• CPU fan and heatsink assembly
• Foot stand and screw (1 pair) for vertical placement
• Rubber stand (x 4) for horizontal placement
• Hard disk drive screw (x 8)
• Optical drive screw (x 2)
• Rubber washer (x 8)
3. Cables
• AC power cable
• Serial ATA signal cable (x 2)
• IDE cable (x 1)
4. Support CD and Recover Pro CD
5. Installation manual

Chapter 1

This chapter gives a general description of the barebone system. The chapter lists the system features including introduction on the front and rear panel, and internal components.



ASUS Pundit P3-PH5

System introduction

1.1 Welcome!

Thank you for choosing the ASUS Pundit P3-PH5!

The ASUS Pundit P3-PH5 is an all-in-one barebone system with powerful and flexible features.

The system comes in a stylish mini-tower casing, and powered by the ASUS motherboard that supports the Intel® Pentium® 4 processor in the 775-land package with 1066 MHz FSB and up to 8 GB system memory.





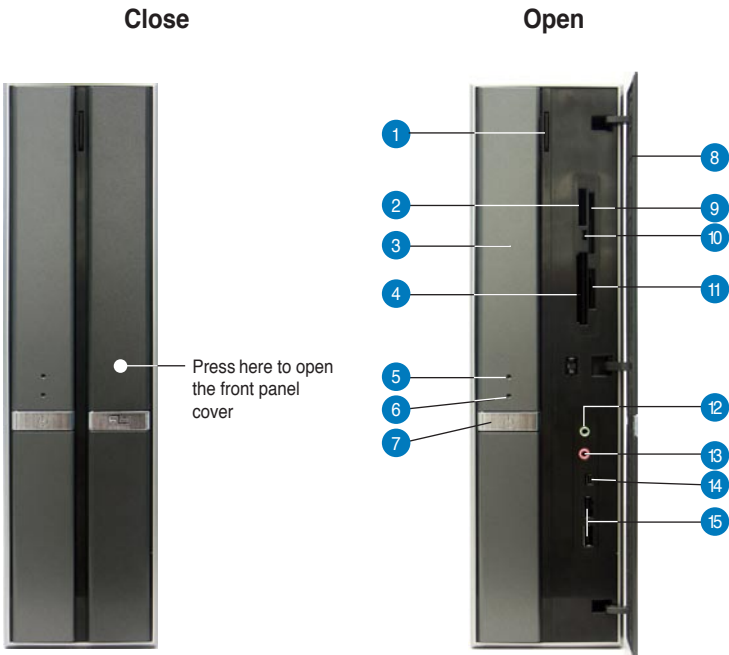

With audio capabilities, extensive connectivity, and Fast Ethernet LAN, Pundit P3-PH5 is designed for the sophisticated. The system's ergonomic design allows vertical or horizontal placement so you can maximize your desktop space.

With these and many more, the Pundit P3-PH5 definitely delivers the cutting edge technology for your computing and multimedia needs.

1.2 Front panel

The front panel includes the front panel cover, system and audio control buttons, and LEDs.



1. **Optical drive eject button.** Press this button to eject the optical drive tray.
2. **Memory Stick®/Memory Stick Pro™ card slot*.** This slot is for a Memory Stick®/Memory Stick Pro™ storage card.
3. **Optical drive/bay cover.** Covers the optical drive or optical drive bay.
4. **CompactFlash® card slot* .** This slot is for a CompactFlash® storage card.
5. **HDD LED.** This LED lights up when data is being read from or written to the hard disk drive.
6. **Power LED.** This LED lights up to indicate that the system is ON.
7. **Power button .** Press this button to turn the system on or off.
8. **Front panel cover.** Covers the 6-in-1 card reader and front panel I/O ports. Press the indicated area to open the front panel cover. Refer to the illustration in the previous page.
9. **SmartMedia® card slot* .** This slot is for a SmartMedia® storage card.
10. **Card reader LED.** This LED lights up when data is being read from or written to a storage card inserted in any of the card reader slots.
11. **Secure Digital™/MultimediaCard slot* .** This slot is for a Secure Digital™/MultimediaCard storage card.
12. **Headphone port .** This port connects a headphone with a stereo mini-plug.
13. **Microphone port .** This Mic (pink) port connects a microphone.
14. **4-pin IEEE 1394a port ~~1394~~.** This port provides high-speed connectivity for IEEE 1394a-compliant audio/video devices, storage peripherals, and other PC devices.
15. **USB 2.0 ports .** These Universal Serial Bus 2.0 (USB 2.0) ports are available for connecting USB 2.0 devices such as a mouse, printer, scanner, camera, PDA, and others.







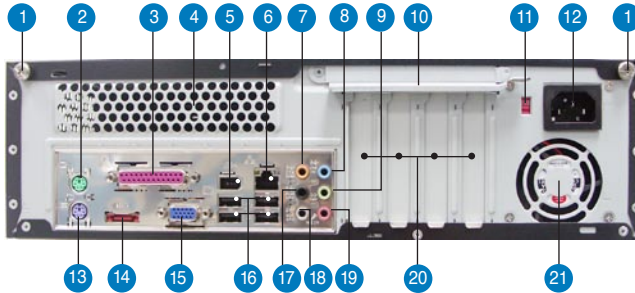

*Use and format a storage card according to the documentation that comes with it.

1.3 Rear panel

The system rear panel includes the power connector and several I/O ports that allow convenient connection of devices.



1. **Cover screw.** Secures the system cover.
2. **PS/2 mouse port** . This green 6-pin connector is for a PS/2 mouse.
3. **Parallel port** . This 25-pin port connects a printer, scanner, or other devices.
4. **Air vent.** Provides ventilation for the system.
5. **6-pin IEEE 1394a port** . Provides high-speed connectivity for IEEE 1394a-compliant audio/video devices, storage peripherals, and other consumer electronic devices.
6. **LAN (RJ-45) port** . This port allows Fast Ethernet connection to a Local Area Network (LAN) through a network hub.
7. **Center/Subwoofer port (yellow orange).** This port connects the center/subwoofer speakers.
8. **Line In port (light blue).** This port connects a tape player or other audio sources.
9. **Line Out port (lime).** This port connects a headphone or a speaker. In 4/6/8-channel configuration, the function of this port becomes Front Speaker Out.
10. **Metal bracket lock.** Secures the expansion slot/card metal brackets.
11. **Voltage selector.** Allows you to adjust the system input voltage according to the voltage supply in your area. See the “Voltage selector” section on page 2-x before adjusting this switch.
12. **Power connector.** Connects the power cable and plug.
13. **PS/2 keyboard port** . This purple 6-pin connector is for a PS/2 keyboard.

14. **External SATA port (eSATA).** Connects to an external SATA box or a Serial ATA port multiplier.
15. **VGA port** . Connects a VGA monitor.
16. **USB 2.0 ports** . These Universal Serial Bus 2.0 (USB 2.0) ports are available for connecting USB 2.0 devices such as a mouse, printer, scanner, camera, PDA, and others.
17. **Side Speaker Out port (black).** This port connects the side speakers in an 8-channel audio configuration.
18. **Rear Speaker Out port (gray).** This port connects the rear speakers in a 4/6/8-channel audio configuration.
19. **Microphone port (pink).** This port connects a microphone. In 2/4/6/8-channel mode, the function of this port becomes Surround Speaker.



The functions of the Line Out, Line In, and Microphone ports change when you select the 6/8-channel configuration. Refer to the table below for audio ports function variation.

Audio ports function variation

Port	Headset 2-channel	4-channel	6-channel	8-channel
Light Blue	Line In	Line In	Line In	Line In
Lime	Line Out	Front Speaker Out	Front Speaker Out	Front Speaker Out
Pink	Mic In	Mic In	Mic In	Mic In
Gray	-	Rear Speaker Out	Rear Speaker Out	Rear Speaker Out
Black	-	-	-	Side Speaker Out
Yellow Orange	-	-	Center/Subwoofer	Center/Subwoofer

20. **Expansion slots.** You can insert expansion boards into these slots to add memory and graphics capabilities to the system.
21. **Power fan vent.** The fan vent allows air to be circulated by the power supply fan.

1.4 Internal components

The illustration below is the internal view of the system when you remove the top cover and the chassis support bracket. The installed components are labeled for your reference. Proceed to Chapter 2 for instructions on installing additional system components.



- | | | | |
|----|-----------------------------------|-----|----------------------|
| 1. | 5.25-inch empty optical drive bay | 7. | PCI Express x4 slot |
| 2. | Front panel cover | 8. | PCI slots |
| 3. | Optical drive lock | 9. | PCI Express x16 slot |
| 4. | Hard disk drive bays | 10. | ASUS motherboard |
| 5. | Hard disk drive lock | 11. | Metal bracket lock |
| 6. | Power supply unit | 12. | LGA775 socket |
| | | 13. | DIMM sockets |

Chapter 2

This chapter provides step-by-step instructions on how to install components in the system.



ASUS Pundit P3-PH5

Basic installation

2.1 Preparation

Before you proceed, make sure that you have all the components you plan to install in the system.

Basic components to install

1. Central processing unit (CPU)
2. DDR2 Dual Inline Memory Module (DIMM)
3. Expansion card(s)
4. Hard disk drive
5. Optical drive

2.2 Before you proceed

Take note of the following precautions before you install components into the system.



- Use a grounded wrist strap or touch a safely grounded object or a metal object, such as the power supply case, before handling components to avoid damaging them due to static electricity.
- Hold components by the edges to avoid touching the ICs on them.
- Whenever you uninstall any component, place it on a grounded antistatic pad or in the bag that came with the component.

The system motherboard comes with an onboard standby power LED. This LED lights up to indicate that the system is ON, in sleep mode or in soft-off mode, and not powered OFF. Unplug the power cable from the power outlet and make sure that the standby power LED is OFF before installing any system component.

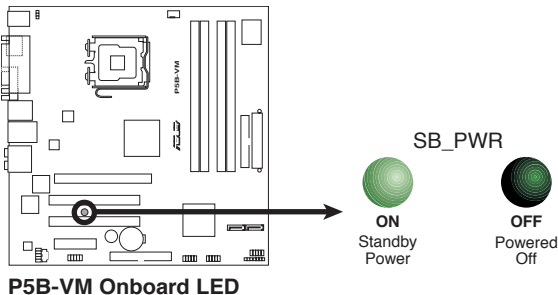

2.3 Removing the covers

2.3.1 Removing the system cover

To remove the cover and metal chassis support:

1. On the rear panel, locate the two thumb screws that secure the cover to the chassis.
2. Remove the cover screws. Keep the screws for later use.



3. Slightly pull the cover toward the rear panel until the cover hooks disengages from the chassis holes.
4. Lift the system cover, then set aside.

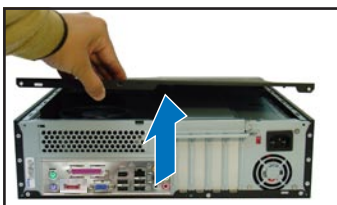
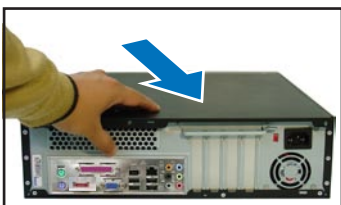

5. Lift the expansion card lock to a 90°-100° angle.
6. Lift the chassis support bracket to a 45° angle, then carefully pull to release. Set the chassis support bracket aside.

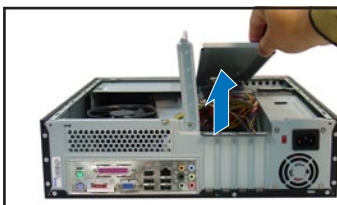

2.3.2 Removing the front panel assembly

To remove the front panel assembly:

1. Place the system vertically.
2. Locate the front panel assembly hooks.
3. Pull the hooks outward to release the front panel assembly.

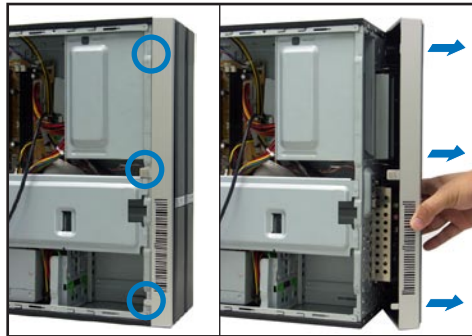

4. Swing the left edge of the front panel assembly outward.
5. Unhook the hinge-like tabs from the holes on the right side of the chassis to detach.

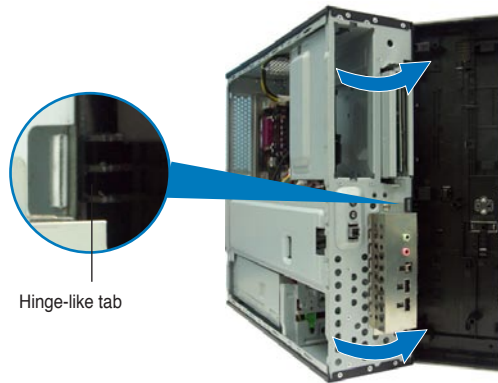

Do not use too much force when removing the front panel assembly.

2.4 Installing a CPU

The ASUS motherboard comes with a surface mount LGA775 socket designed for the Intel® Pentium® 4 processor in the 775-land package.

2.4.1 CPU installation



- Your boxed Intel® Pentium® 4 LGA775 processor package should come with installation instructions for the CPU, heatsink, and the retention mechanism. If the instructions in this section do not match the CPU documentation, follow the latter.
- Check your motherboard to make sure that the socket contacts are not bent. Contact your retailer immediately if you see any damage to the socket contacts/motherboard components. ASUS will shoulder the cost of repair only if the damage is shipment/transit-related.
- The product warranty does not cover damage to the socket contacts resulting from incorrect CPU installation or removal.

Installing the CPU

To install a CPU:

1. Locate the CPU socket on the motherboard.

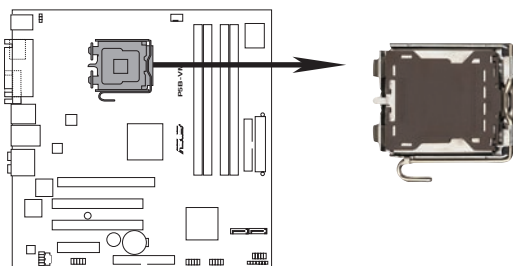

P5B-VM CPU Socket connector



Before installing the CPU, make sure that the socket box is facing towards you and the load lever is on your left.

2. Press the load lever with your thumb (A) and move it to the left (B) until it is released from the retention tab.

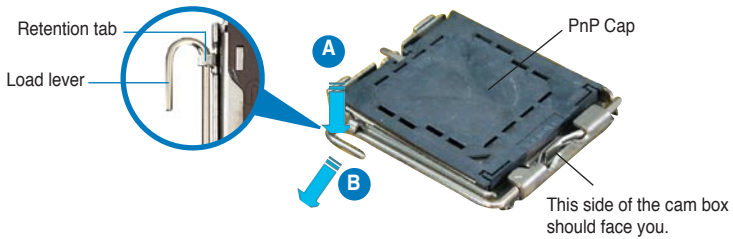

To prevent damage to the socket pins, do not remove the PnP cap unless you are installing a CPU.

3. Lift the load lever in the direction of the arrow to a 135° angle.

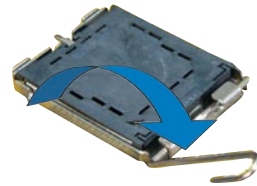

4. Lift the load plate with your thumb and forefinger to a 100° angle (A), then push the PnP cap from the load plate window to remove (B).

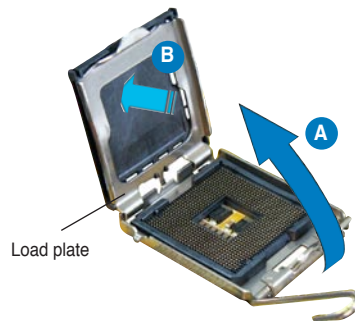

5. Position the CPU over the socket, making sure that the gold triangle is on the bottom-left corner of the socket. The socket alignment key should fit into the CPU notch.

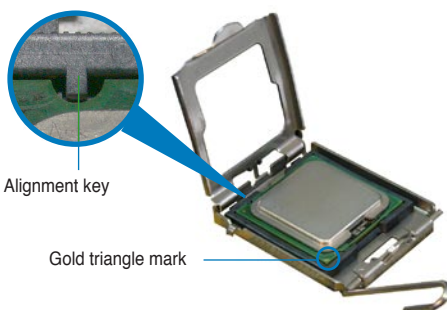

6. Close the load plate (A), then push the load lever (B) until it snaps into the retention tab.

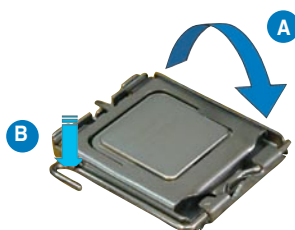

The CPU fits in only one correct orientation. DO NOT force the CPU into the socket to prevent bending the connectors on the socket and damaging the CPU!



The motherboard supports Intel® Pentium® 4 LGA775 processors with the Intel® Enhanced Memory 64 Technology (EM64T), Enhanced Intel SpeedStep® Technology (EIST), and Hyper-Threading Technology. Refer to the Appendix for more information on these CPU features.

2.4.2 Installing the CPU fan and heatsink assembly

The system package includes a pre-installed proprietary CPU fan and heatsink assembly to ensure optimum thermal condition and performance.



DO NOT replace the proprietary CPU fan and heatsink with other models.

To install the CPU fan and heatsink assembly:

1. Place the heatsink on top of the installed CPU.
2. Drive four screws into the fan holes to secure the fan to the motherboard.



3. Connect the CPU fan cable.

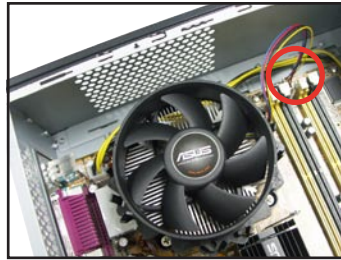

Do not forget to connect the CPU fan connector! Hardware monitoring errors can occur if you fail to plug this connector.

2.5 Installing a DIMM

The system motherboard comes with four Double Data Rate 2 (DDR2) Dual Inline Memory Module (DIMM) sockets.

A DDR2 module has the same physical dimensions as a DDR DIMM but has a 240-pin footprint compared to the 184-pin DDR DIMM. DDR2 DIMMs are notched differently to prevent installation on a DDR DIMM socket.

The figure illustrates the location of the DDR2 DIMM sockets.

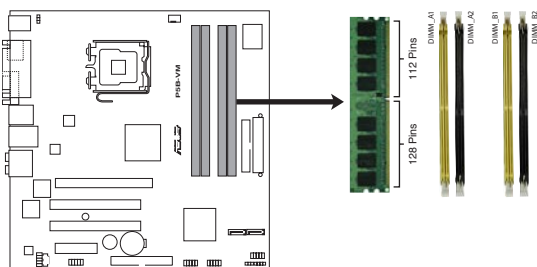

P5B-VM 240-pin DDR2 DIMM socket

Channel	Sockets
Channel A	DIMM_A1 and DIMM_A2
Channel B	DIMM_B1 and DIMM_B2

2.5.1 Memory configurations

You may install up to 8 GB system memory using 256 MB, 512 MB, 1 GB, and 2 GB DDR2 DIMMs.



- Installing DDR2 DIMMs other than the recommended configurations may cause memory sizing error or system boot failure. Use any of the recommended configurations in the table on the next page.
- Install only **identical** (the same type and size) DDR2 DIMM in DIMM_A and DIMM_B.
- Always install DIMMs with the same CAS latency. For optimum compatibility, we recommend that you obtain memory modules from the same vendor.
- Due to chipset resource allocation, the system may detect less than 4 GB system memory when you installed four 1 GB DDR2 memory.
- This motherboard does not support memory modules made up of 128 MB chips or double-sided x16 memory modules.

DDR2 Qualified Vendors List

The following tables list the memory modules that have been tested and qualified for use with this motherboard. Visit the ASUS website (www.asus.com) for the latest DDR2 DIMM modules for this motherboard.

DDR2 533 Qualified Vendors List

Size	Vendor	Model	Brand	SS/ DS	Component	DIMM support		
						A	B	C
512MB	SAMSUNG	M378T6553BG0-CD5	N/A	SS	K4T51083QB-GCD5	*	*	*
256MB	SAMSUNG	M378T3253FG0-CD5	N/A	SS	K4T56083QF-GCD5	*	*	*
512MB	SAMSUNG	M378T6453FG0-CD5	N/A	DS	K4T56083QF-GCD5	*	*	*
512MB	Infineon	HYS64T64000GU-3.7-A	Infineon	SS	HYB18T512800AC37	*	*	*
256MB	Infineon	HYS64T32000HU-3.7-A	Infineon	SS	HYB18T512160AF-3.7	*	*	*
1024MB	Infineon	HYS64T128020HU-3.7-A	Infineon	DS	HYB18T512800AF37	*	*	*
512MB	Infineon	HYS64T64000HU-3.7-A	Infineon	SS	HYB18T512800AF37	*	*	*
512MB	CORSAIR	CM2X512-4200	N/A	DS	N/A	*	*	*
512MB	MICRON	MT16HTF6464AG-53EB2	MICRON	DS	4FBII9BQM	*	*	*
1024MB	MICRON	MT16HTF12864AY-53EA1	MICRON	DS	4JAII9CRZ	*	*	*
256MB	MICRON	MT8HTF3264AY-53EB3	MICRON	SS	4FBII9CHM	*	*	*
512MB	MICRON	MT16HTF6464AY-53EB2	MICRON	DS	4FBII9CHM	*	*	*
1024MB	Kingston	D6408TE7BL-37	N/A	DS	E5108AB-5C-E	*	*	*
256MB	Kingston	E5116AB-5C-E	N/A	SS	HYB18T512160AC-3.7	*	*	*
512MB	Kingston	HY5PS56821F-C4	ELPIDA	SS	E5108AB-5C-E	*	*	*
512MB	Hynix	HYMP564U648-C4	N/A	SS	HY5PS12821F-C4	*	*	*
512MB	Hynix	HY5PS1282AFP-C3	N/A	SS	HYMP564U64AP8-C3	*	*	*
1024MB	Hynix	HYMP512U648-C4	N/A	DS	HY5PS12821FP-C4	*	*	*
512MB	ELPIDA	EBE51UD8ABFA-5C	ELPIDA	DS	E5108AB-5C-E	*	*	*
1024MB	ELPIDA	EBE11UD8ABFA-5C-E	ELPIDA	DS	E5108AB-5C-E	*	*	*

DDR2 667 Qualified Vendors List

Size	Vendor	Model	Brand	SS/ DS	Component	DIMM support		
						A	B	C
512MB	Hynix	HYMP564U64AP8-Y5	Hynix	SS	HY5PS12821AFP-Y5	*	*	*
1024MB	Hynix	HYMP512U64AP8-Y4	Hynix	DS	HY5PS12821AFP-Y4	*	*	*
512MB	Hynix	HYMP564U64AP8-Y4	Hynix	SS	HY5PS12821AFP-Y4	*	*	*
256MB	MICRON	MT8HTF3264AY-667B5	MICRON	SS	4SB42D9CZM	*	*	*
256MB	MICRON	MT8HTF3264AY-667B6	MICRON	SS	5FB42D9DPN	*	*	*
512MB	Infineon	HYS64T64000HU-3S-A	Infineon	SS	HYB18T512800AF3S	*	*	*
256MB	Infineon	HYS64T32000HU-3S-A	Infineon	SS	HYB18T512160AF-3S	*	*	*
1024MB	Infineon	HYS64T128020HU-3S-A	Infineon	DS	HYB18T512800AF3S	*	*	*
256MB	ELPIDA	EBE25UC8ABFA-6E-E	ELPIDA	SS	E2508AB-GE-E	*	*	*
512MB	ELPIDA	EBE51UD8AEFA-6E-E	ELPIDA	SS	E5108AE-GE-E	*	*	*
1024MB	ELPIDA	EBE11UD8AEFA-6E-E	ELPIDA	DS	N/A	*	*	*

Side(s): SS - Single Sided

DS - Double Sided

DIMM Support:

- A - supports one module inserted into either slot, in a Single-channel memory configuration.
- B - supports on pair of modules inserted into either the yellow slots or the black slots as one pair of Dual-channel memory configuration.
- C - support for 4 modules inserted into the yellow and black slots as two pairs of Dual-channel memory configuration.

2.5.2 Installing a DIMM



Unplug the power supply before adding or removing DIMMs or other system components. Failure to do so can cause severe damage to both the motherboard and the components.

To install a DIMM:

1. Unlock a DIMM socket by pressing the retaining clips outward.
2. Align a DIMM on the socket such that the notch on the DIMM matches the break on the socket.
3. Firmly insert the DIMM into the socket until the retaining clips snap back in place and the DIMM is properly seated.

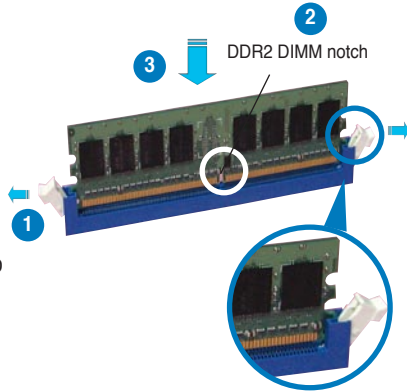

Unlocked retaining clip



- A DDR2 DIMM is keyed with a notch so that it fits in only one direction. Do not force a DIMM into a socket to avoid damaging the DIMM.
- The DDR2 DIMM sockets do not support DDR DIMMs. DO not install DDR DIMMs to the DDR2 DIMM sockets.

2.5.3 Removing a DIMM

To remove a DIMM:

1. Simultaneously press the retaining clips outward to unlock the DIMM.



Support the DIMM lightly with your fingers when pressing the retaining clips. The DIMM might get damaged when it flips out with extra force.

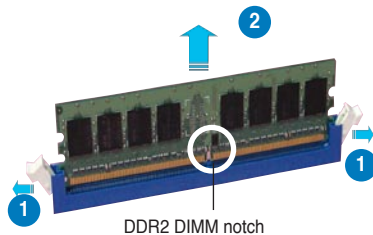

2. Remove the DIMM from the socket.

2.6 Installing an expansion card

In the future, you may need to install expansion cards. The motherboard has two PCI, one PCI Express™ x4, and one PCI Express™ x16 slot. The following subsections describe the slots and the expansion cards that they support.



The system supports low profile PCI, PCI Express x16, and PCI Express x4 cards. You can only install low profile expansion cards on this system. Ask your retailer for details.

2.6.1 Expansion slots

PCI slots

The PCI slots support cards such as a LAN card, SCSI card, USB card, and other cards that comply with PCI specifications.

PCI Express x16 slot

This motherboard supports PCI Express x16 graphic cards that comply with the PCI Express specifications. The following figure shows a graphics card installed on the PCI Express x16 slot.

PCI Express x4 slot

This motherboard supports PCI Express x4 network cards, SCSI cards and other cards that comply with the PCI Express specifications.



Before installing an expansion card, read the documentation that came with it and make the necessary hardware settings for the card.

2.6.2 Expansion card installation



Make sure to unplug the power cord before adding or removing expansion cards. Failure to do so may cause you physical injury and damage the motherboard.

To install an expansion card:

1. Lay the system on its side on a flat and stable surface.
2. Lift the expansion card lock to a 90°-100° angle.



2. Remove the chassis support bracket.

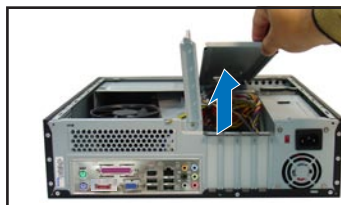

3. Remove the metal cover opposite the slot that you intend to use.

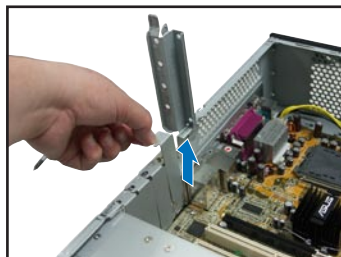

4. Align the card connector with the slot and press firmly until the card is completely seated on the slot.

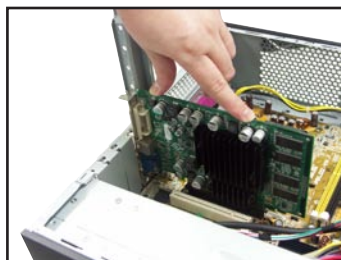

5. If you have already installed a hard disk drive, replace the chassis support bracket; otherwise, install other components before replacing the chassis support bracket.

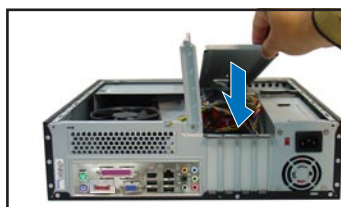

6. Replace the expansion card lock to secure the card to the chassis.



Standard interrupt assignments

IRQ	Standard function
0	System Timer
1	Keyboard Controller
2	Programmable Interrupt
4	Communications Port (COM1)
6	Floppy Disk Controller
7	Printer Port (LPT1)*
8	System CMOS/Real Time Clock
9	ACPI mode when used*
10	IRQ Holder for PCI Steering*
11	IRQ Holder for PCI Steering*
12	PS/2 Compatible Mouse Port*
13	Numeric Data Processor
14	Primary IDE Channel*

* These IRQs are usually available for ISA or PCI devices.

IRQ assignments for the system motherboard

	A	B	C	D	E	F	G	H
PCI Slot 1	-	-	-	-	-	used	-	-
PCI Slot 2	-	-	-	-	-	-	used	-
PCI Express x16 slot	shared	-	-	-	-	-	-	-
PCI Express x1 slot	-	shared	-	-	-	-	-	-
USB controller 1	-	-	-	-	-	-	-	shared
USB controller 2	-	-	-	shared	-	-	-	-
USB controller 3	-	-	shared	-	-	-	-	-
USB controller 4	shared	-	-	-	-	-	-	-
USB 2.0 controller	-	-	-	-	-	-	-	shared
LAN controller	-	-	-	-	shared	-	-	-
Audio controller	shared	-	-	-	-	-	-	-



When using a PCI card on shared slots, ensure that the drivers support "Share IRQ" or that the cards do not need IRQ assignments; otherwise, conflicts will arise between the two PCI groups, making the system unstable and the card inoperable.

2.7 Installing an optical drive

The system comes with a 5.25-inch drive bay for an optical drive.



If you plan to install an IDE hard disk drive, set the optical drive as a slave device before installing it to the system. Refer to the optical drive documentation for details on how to set the drive as slave device.

To install an optical drive:

1. Remove the front panel assembly following the instructions in section “2.3.2 Removing the front panel assembly.”

2. Drive a screw on the top right screw hole on both sides of the drive. The screw holes are approximately 5 cm from the drive front panel and 2 cm from the drive base.

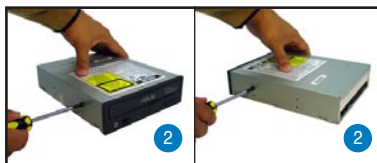

3. Lay the system on its side in a flat and stable surface.
4. Carefully pull the IDE and audio cables and plugs out from the bay until the cables are long enough to connect to the drive.

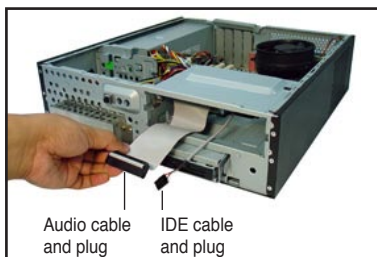

5. Connect the IDE cable to the IDE interface at the back of the drive. Match the red stripe on the cable with Pin 1 on the IDE interface.
6. Connect the optical drive audio cable to the 4-pin connector at the back of the optical drive.

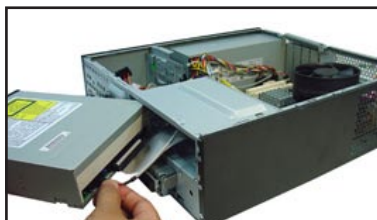

The IDE and audio plugs are pre-connected to the primary IDE and internal audio connectors on the motherboard. If you disconnected these plugs, refer to page 4-6 and 4-8 for their respective locations.

7. Carefully push the optical drive all the way into the bay until the optical drive lock clicks.
8. Connect a 4-pin power plug from the power supply unit to the power connector at the back of the drive.

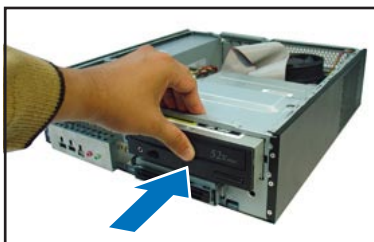

Uninstalling the optical drive

In the future, you may have to upgrade or replace a defective optical drive.

To uninstall the optical drive:

1. Remove the front panel assembly following the instructions in section “2.3.2 Removing the front panel assembly”.
2. Locate the optical drive screw lock.



3. Push the lock to release the optical drive screw (A), then slightly pull the drive out from the bay (B).

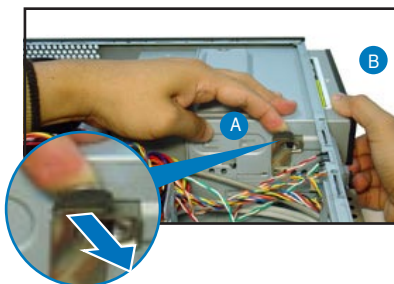

4. Disconnect the IDE, audio, and power cables and plugs from the back of the drive.
5. Pull out the drive completely from the bay, then replace it following the instructions in the previous section.

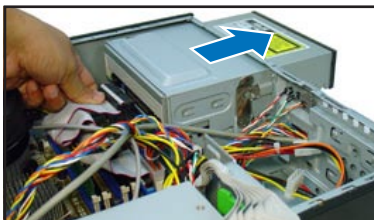

2.8 Removing the card reader

In the future, you may have to remove or replace the 6-in-1 card reader.

To uninstall the card reader:

1. Remove the front panel assembly following the instructions in “2.3.2 Removing the front panel assembly”.
2. Locate the lock on both sides of the card reader assembly.

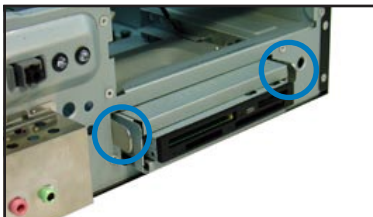

3. Press the card reader lock inwards (A), then slightly pull the card reader assembly outward (B) until the USB cable and plug is exposed.

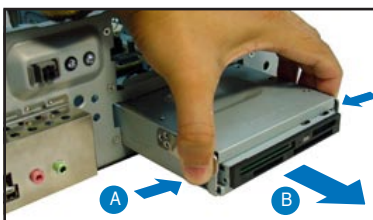

4. Disconnect the USB cable and plug from the card reader assembly, then set the card reader assembly aside.

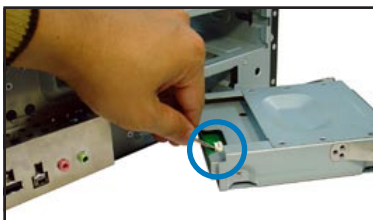

2.9 Installing hard disk drives (HDDs)

The system comes with two 3.5-inch drive bays (labeled 1 and 2) for installation of two Serial ATA hard disk drives or one IDE HDD (if you have installed an optical drive).

2.9.1 Hard disk drive bays

The drive bays incorporate a screw-less design that allows you to install and remove a hard disk drive without driving screws on the chassis. Each drive bay has a HDD screw lock and four screw rails (two on each side of the bay) that trap the HDD screws and secure the drive in the place.

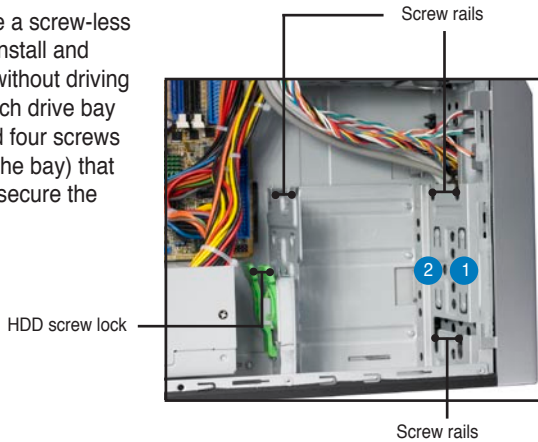

When installing one hard disk drive, install it on the upper HDD bay.

2.9.2 SATA hard disk drive installation

To install a SATA hard disk drive:

1. Insert the rubber washers to the HDD screws. Refer to the illustration on the right.
2. Drive four screws (two on each side of the drive) on the drive screw holes.

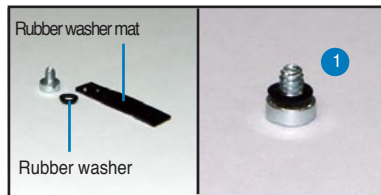

3. Connect one end of the supplied 7-pin SATA cable to the SATA connector at the back of the drive, then connect the other end to a SATA connector on the motherboard. See page 4-7 for the location of the SATA connectors.



4. Connect the 15-pin SATA power plug from the power supply unit to the power connector at the back of the drive.

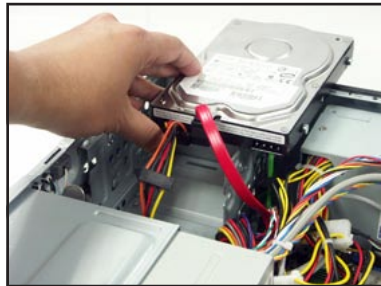

5. Place the HDD on the tray. Make sure that the HDD screws are aligned with the screw holes and rails.



6. When the HDD screws align with the screw rails, push the drive carefully until it is completely flushed on the bay.

The HDD screw lock clicks to indicate that the drive is properly in place.

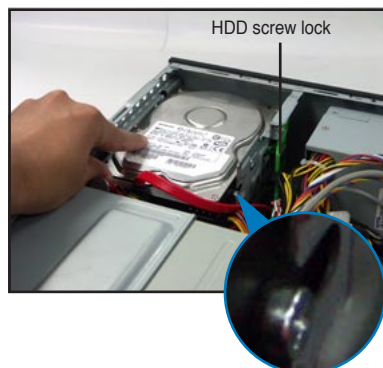

2.9.3 IDE hard disk drive installation



Set the IDE HDD as master device before connecting the IDE cable and power plug. Refer to the HDD documentation for details.

To install an IDE hard disk drive:

1. Follow steps 1 to 2 of the previous section.
2. Connect the IDE cable (gray connector) to the IDE interface at the back of the drive. Match the red stripe on the cable with Pin 1 on the IDE interface.
3. Connect a power cable from the power supply unit to the power connector at the back of the drive.
4. Follow steps 5 to 6 of the previous section to complete installation.

2.9.4 Uninstalling a hard disk drive

In the future, you may have to upgrade or replace a defective hard disk drive.

To uninstall the hard disk drive:

1. Press the HDD screw lock (A), then push the drive out from the bay (B) until the drive screws are released from the screw rails.



2. Slightly lift the HDD, then remove all plugs at the back of the drive.
3. Install a new HDD following the instructions in the previous section.



2.10 Replacing the covers

After you install all the necessary components on the system, replace the covers following the instructions in this section:

2.10.1 Replacing the front panel assembly

To replace the front panel assembly:

1. Hook the hinge-like tabs to the holes on the right side of the chassis.

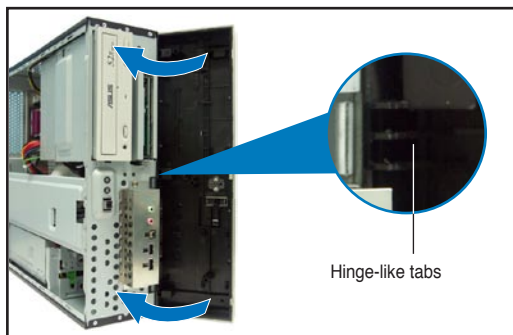

2. Swing the left edge of the front panel inward, then attach the front panel assembly hooks to the chassis until they snap in place.

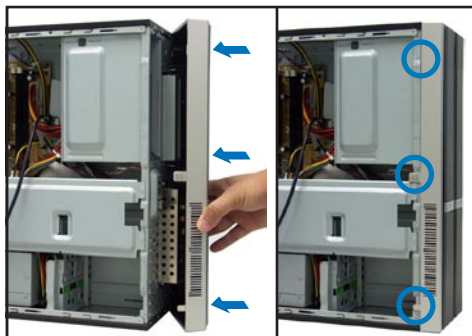

Do not use too much force when replacing the front panel assembly.

2.10.2 Replacing the system cover

To replace the metal chassis support:

1. Reinstall the metal chassis support and the expansion card lock.

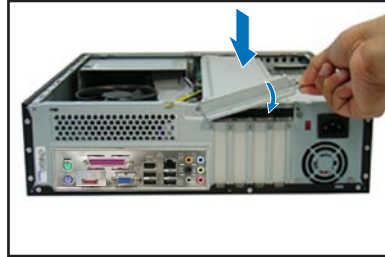

2. Match and insert the hooks of the cover to the elongated holes on the side of the chassis. All eight hooks (four hooks on both sides) of the cover must properly fit the designated holes.

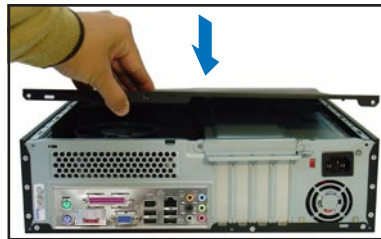

3. Slide the cover toward the front panel until it is in place.
4. Replace the cover screws.

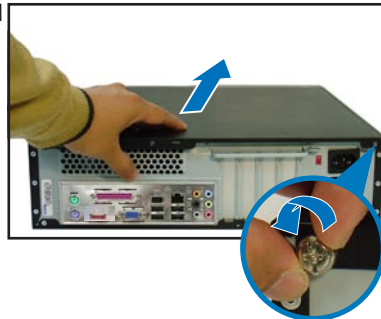

2.11 Installing the foot stands

You need to install the foot stands to place the system vertically on your desktop. To install the foot stands:

1. Lay the system on its side on a flat, stable, and elevated surface, then locate two screw holes on the left side of the system.
2. Extend the left side of the system at least 3 cm from the edge of the surface to facilitate installation.
3. Align the foot stand and chassis screw holes.
4. Drive in a screw to secure the footstand to the chassis.
5. Follow the same procedures when installing the second foot stand.



The photo on the right shows the system in a vertical desktop placement.



2.12 Selecting the voltage

The system's power supply unit has a 115 V/230 V voltage selector switch located beside the power connector. Use this switch to select the appropriate system input voltage according to the voltage supply in your area.

If the voltage supply in your area is 100-127 V, set the switch to 115 V.

If the voltage supply in your area is 200-240 V, set the switch to 230 V.



Setting the switch to 115 V in a 230 V environment will seriously damage the system!

Chapter 3

This chapter helps you power up the system and install drivers and utilities from the support CD.



ASUS Pundit P3-PH5

Getting started

3.1 Installing an operating system

This system supports Windows® 2000/2003 Server/XP operating systems (OS). Always install the latest OS version and corresponding updates to maximize the features of your system.



- Motherboard settings and hardware options vary. Use the setup procedures presented in this chapter for reference only. Refer to your OS documentation for detailed information.
- Make sure that you install Windows® 2000 Service Pack 4 or the Windows® XP Service Pack 1 or later versions before installing the drivers for better compatibility and system stability.

3.2 Support CD information

The support CD that came with the system package contains the drivers, software applications, and utilities that you can install to avail all system features.



The contents of the support CD are subject to change at any time without notice. Visit the ASUS website(www.asus.com) for updates.

3.2.1 Running the support CD

Place the support CD to the optical drive. The CD automatically displays the **Drivers** menu if Autorun is enabled in your computer.

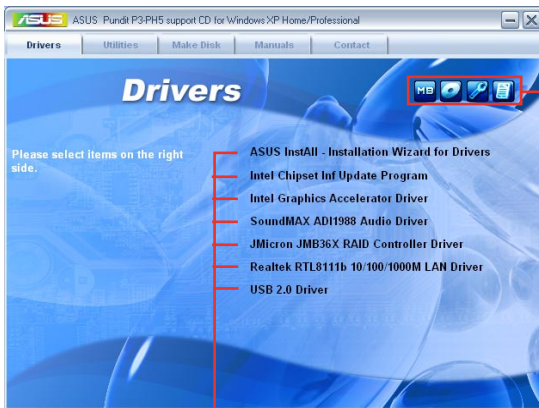

Click an icon to display support CD / motherboard information

Click an item to install



If **Autorun** is NOT enabled in your computer, browse the contents of the support CD to locate the file **ASSETUP.EXE** from the **BIN** folder. Double-click the **ASSETUP.EXE** to run the CD.

3.2.2 Drivers menu

The drivers menu shows the available device drivers if the system detects installed devices. Install the necessary drivers to activate the devices.



ASUS InstAll -Installation Wizard for Drivers

Launches the ASUS InstallAll driver installation wizard.

Intel Chipset Inf Update Program

Installs the Intel® chipset inf update program.

Intel Graphics Accelerator Driver

Installs the Intel® graphics accelerator driver.

SoundMAX ADI1988 Audio Driver

Installs the SoundMAX ADI1988 audio driver.

JMicron JMB36X RAID Controller Driver

Installs the JMicron® JMB36X Serial ATA RAID controller driver.

Realtek RTL8111b 10/100/1000M LAN Driver

Executes the wizard to install the Realtek® ALC655 audio driver and application.

USB 2.0 Driver

Installs the USB 2.0 driver.



The screen display and drivers option may not be the same for different operating system versions.

3.2.3 Utilities menu

The Utilities menu shows the applications and other software that the motherboard supports.

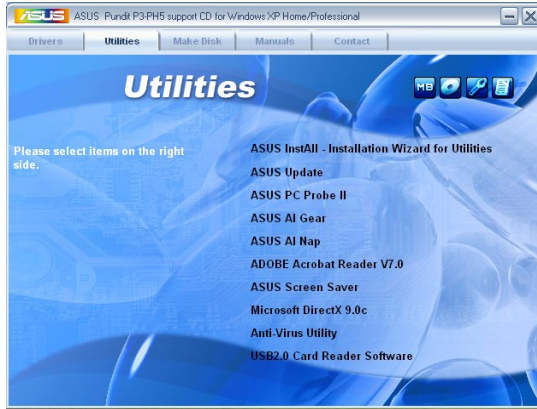

ASUS InstAll - Installation Wizard for Utilities

Launches the ASUS InstallAll utilities installation wizard.

ASUS Update

The ASUS Update utility allows you to update the motherboard BIOS in a Windows® environment. This utility requires an Internet connection either through a network or an Internet Service Provider (ISP).

ASUS PC Probe II

This smart utility monitors the fan speed, CPU temperature, and system voltages, and alerts you of any detected problems. This utility helps you keep your computer in healthy operating condition.

ASUS AI Gear

ASUS AI Nap

ADOBE Acrobat Reader V7.0

Installs the Adobe® Acrobat® Reader that allows you to open, view, and print documents in Portable Document Format (PDF).

ASUS Screen Saver

Installs the ASUS screen saver.

Microsoft DirectX 9.0c

Installs the Microsoft® DirectX 9.0c driver. The Microsoft DirectX® 9.0c is a multimedia technology that enhances computer graphics and sound. DirectX® improves the multimedia features of your computer so you can enjoy watching TV and movies, capturing videos, or playing games in your computer. Visit the Microsoft website (www.microsoft.com) for updates.

Anti-Virus Utility

The anti-virus application scans, identifies, and removes computer viruses. View the online help for detailed information.

USB 2.0 Card Reader Software

Installs the USB 2.0 card reader software.



The screen display and utilities option may not be the same for different operating system versions.

3.2.4 Make disk menu

The Make disk menu contains items to create the JMicron® JMB36X 32/64bit RAID /AHCI driver disk.



JMicron JMB36X 32bit RAID/AHCI Driver

Allows you to create an JMicron® JMB36X 32bit RAID/AHCI driver disk.

JMicron JMB36X 64bit RAID/AHCI Driver

Allows you to create an JMicron® JMB36X 64bit RAID/AHCI driver disk.

3.2.5 Manual

The Manual menu contains a list of supplementary user manuals. Click an item to open the folder of the user manual.

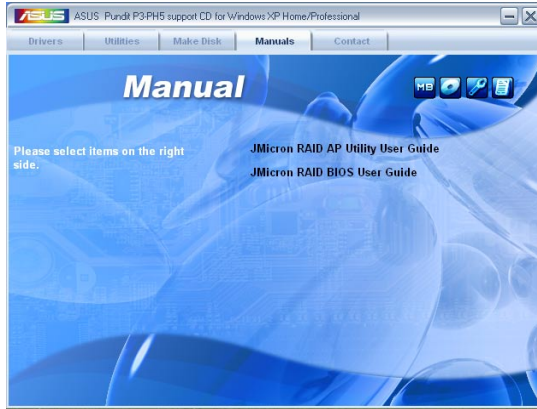

Most user manuals are in Portable Document Format (PDF). Install the Adobe® Acrobat® Reader from the **Utilities** menu before opening a user manual file.

3.2.6 ASUS contact information

Click the Contact tab to display the ASUS contact information. You can also find this information on the inside front cover of this user guide.



3.2.7 Other information

The icons on the top right corner of the screen give additional information on the motherboard and the contents of the support CD. Click an icon to display the specified information.

Motherboard Info

Displays the general specifications of the motherboard.

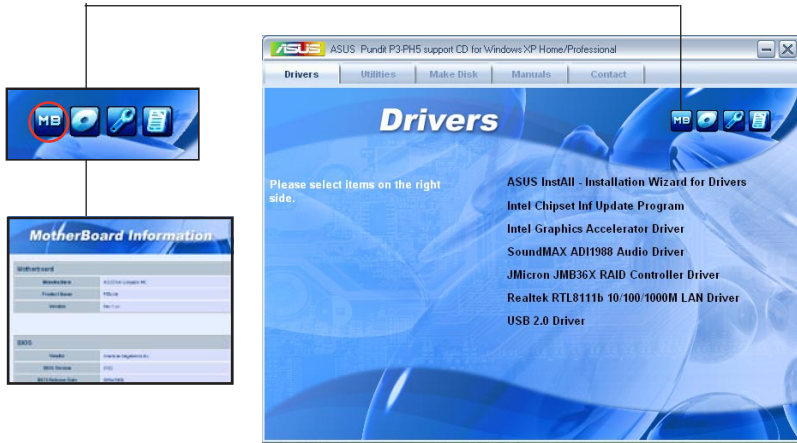

Browse this CD

Displays the support CD contents in graphical format.

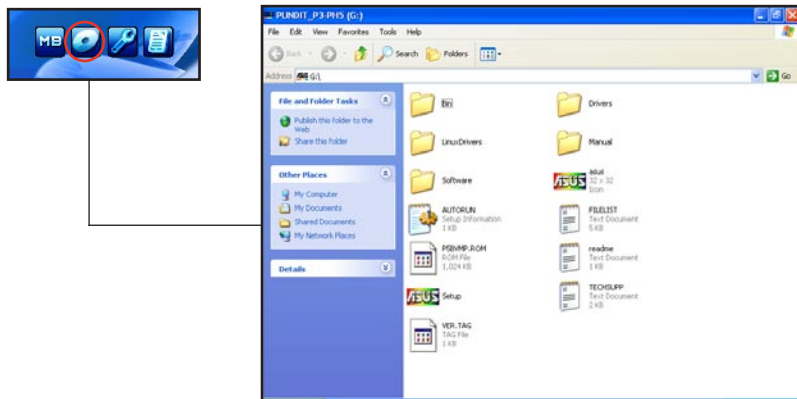

Technical support form

Displays the ASUS Technical Support Request Form that you have to fill out when requesting technical support.

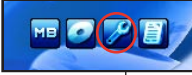

```
TECHSUPP - Notepad
File Edit Format View Help
ASUSTEK TECHNICAL SUPPORT REQUEST FORM      DATE:
-----
ORIGINATOR DESCRIPTION
-----
COMPANY NAME:                               CONTACT NAME:
PHONE (AREA) :                               FAX # (AREA):
EMAIL ADDRESS:
-----
HARDWARE DESCRIPTION
-----
MOTHERBOARD :                               SEVESTION #:                               BIOS:#A02LA0-
CPU BRAND :                                   SPEED(OHMZ):                               SPEED(OHMZ):
RAM BRAND :                                   SPEED(OHMZ) :                               SIZE(MB):
CACHE BRAND :                                SPEED(MS) :                                 SIZE(KB):
HDD DEFP :                                   MODEL NAME:                                 SIZE(MB):
CD/ROF BRAND :                                MODEL NAME:                                 SIZE(MB):
BACKUP BRAND :                                MODEL NAME:                                 SIZE(MB):
OTHER STORAGE:                               MODEL NAME:                                 SIZE(MB):
-----
ADD-IN CARD DESCRIPTION (MODEL NAME/VENDOR)
-----
-----
SOFTWARE DESCRIPTION
-----
OPERATING SYSTEM:
APPLICATION SOFTWARE:
```

Filelist

Displays the contents of the support CD and a brief description of each in text format.



```
FILELIST - Notepad
File Edit Format View Help
File list for the included support software for Pundit P3-PH5
-----
File Name      Description
-----
--drivers
-Chipset
-INTP      -Intel(R) Chipset Software Installation Utility v8.0.1.1002 for Windows 2000
-VGA
-32bit      -Intel(R) Graphics Media Accelerator Driver v6.14.10.4642 for Windows 2000/X
-64bit      -Intel(R) Graphics Media Accelerator Driver v6.14.10.4642 for 64bit Windows
-Audio
-32bit
-7L_XP      -SoundMAX AD1988A Audio driver v5.10.02.4580 for Windows 2000/XP
-7003      -SoundMAX AD1988A Audio Driver v5.10.02.4560 for Windows 2003
-64bit
-XP        -SoundMAX AD1988A Audio driver v5.10.02.4580 WHQL for Windows 64bit XP
-2003      -SoundMAX AD1988A Audio driver v5.10.02.4560 WHQL for Windows 64bit 2003.
-LAN
-Realtek RTL8111b 10/100/1000M LAN driver v5.652.0627.2006 for Windows 2000/
-RAID
-3MB363     -Micron 3MB36X RAID Controller driver v1.14.0.0 for Windows 2000/XP/2003 an
--software
-Acrobat      -Adobe Acrobat Reader V7.0.
-AFUDOS
-AFUDOS.txt  -Information on how to use the AMI FLASH DOS utility.
-AFUDOS.exe  -Utility V2.26 for update the motherboard's AMI BIOS.
-AFgear      -ASUS A1 Gear v1.00.13 for Windows 2000/XP/2003 and for Windows 64bit XP/200
-AFnap      -ASUS A1 Nap v1.00.14 for Windows 2000/XP/2003 and for Windows 64bit XP/2003
```

Chapter 4

This chapter gives information about the motherboard that comes with the system. This chapter includes the motherboard layout, jumper settings, and connector locations.



ASUS Pundit P3-PH5

Motherboard info

4.1 Motherboard overview

Motherboard layout

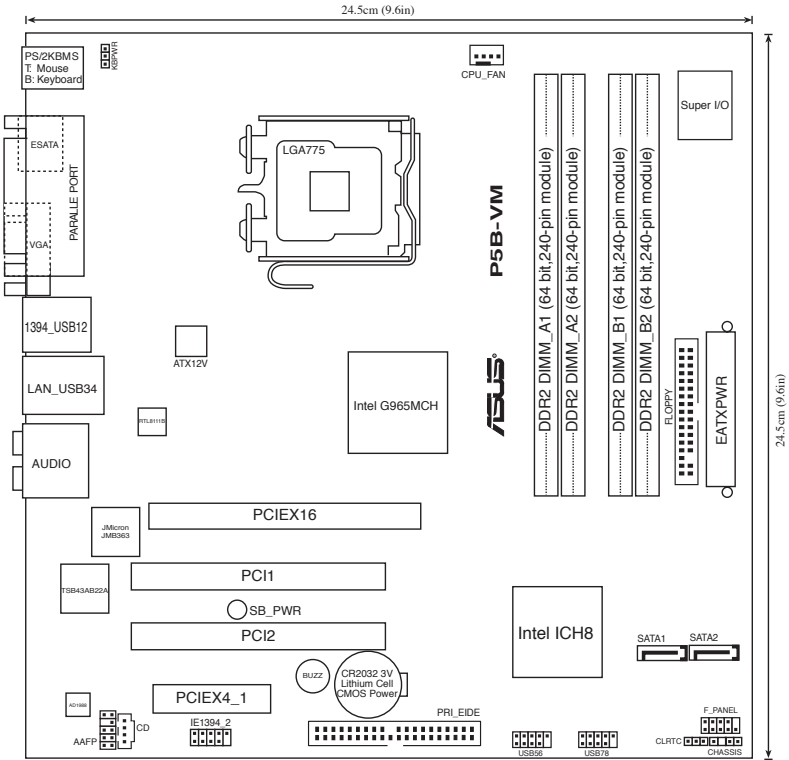

4.2 Jumper

Clear RTC RAM (CLRRTC)

This jumper allows you to clear the Real Time Clock (RTC) RAM in CMOS. You can clear the CMOS memory of date, time, and system setup parameters by erasing the CMOS RTC RAM data. The onboard button cell battery powers the RAM data in CMOS, which include system setup information such as system passwords.

To erase the RTC RAM:

1. Turn OFF the computer and unplug the power cord.
2. Remove the onboard battery.
3. Move the jumper cap from pins 1-2 (default) to pins 2-3. Keep the cap on pins 2-3 for about 5~10 seconds, then move the cap back to pins 1-2.
4. Reinstall the battery.
5. Plug the power cord and turn ON the computer.
6. Hold down the key during the boot process and enter BIOS setup to re-enter data.



Except when clearing the RTC RAM, never remove the cap on CLRRTC jumper default position. Removing the cap will cause system boot failure!

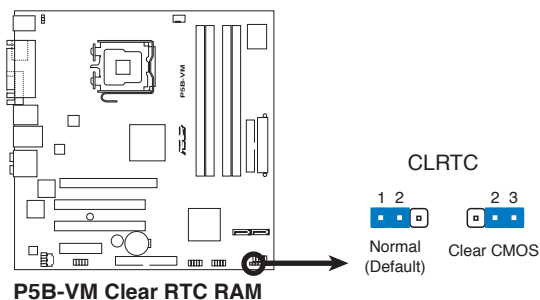

2. Keyboard power (3-pin KBPWR)

This jumper allows you to enable or disable the keyboard wake-up feature. Set this jumper to pins 2-3 (+5VSB) to wake up the computer when you press a key on the keyboard (the default is the Space Bar). This feature requires an ATX power supply that can supply at least 1A on the +5VSB lead, and a corresponding setting in the BIOS.

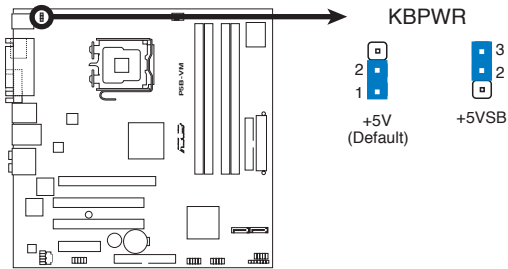

P5B-VM Keyboard Power Setting

4.3 Connectors

4.3.1 Rear panel connectors

Refer to section “1.3 Rear panel” for a description of the rear panel I/O ports.

4.3.2 Internal connectors

1. Floppy disk drive connector (34-1 pin FLOPPY)

This connector is for the provided floppy disk drive (FDD) signal cable. Insert one end of the cable to this connector, then connect the other end to the signal connector at the back of the floppy disk drive.



Pin 5 on the connector is removed to prevent incorrect cable connection when using an FDD cable with a covered Pin 5.

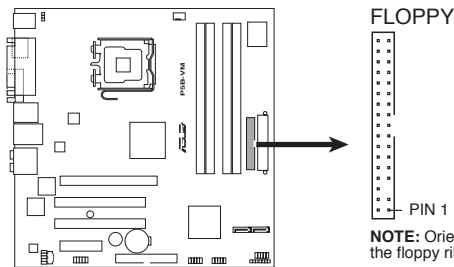

P5B-VM Floppy Disk Drive Connector

NOTE: Orient the red markings on the floppy ribbon cable to PIN 1.

2. Primary IDE connector (40-1 pin PRI_EIDE)

This connector is for an Ultra DMA 100/66 signal cable. The Ultra DMA 100/66 signal cable has three connectors: a blue connector for the primary IDE connector on the motherboard, a black connector for an Ultra DMA 100/66 IDE slave device (optical drive/hard disk drive), and a gray connector for an Ultra DMA 100/66 IDE master device (hard disk drive). If you install an optical drive and an IDE HDD, you must configure the optical drive as a slave device by setting its jumper accordingly. Refer to the optical drive or HDD documentation for the jumper settings.



- Pin 20 on the IDE connector is removed to match the covered hole on the Ultra DMA cable connector. This prevents incorrect insertion when you connect the IDE cable.
- Use the 80-conductor IDE cable for Ultra DMA 100/66 IDE devices.

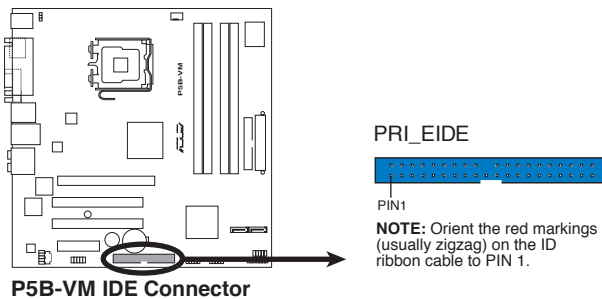

3. Serial ATA connectors (7-pin SATA1, SATA2)

These connectors are for the Serial ATA signal cables for Serial ATA hard disk drives.

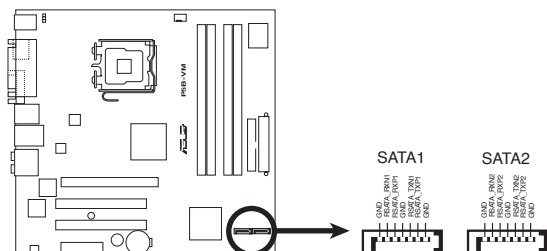

P5B-VM SATA Connectors



Important notes on Serial ATA

- You must install Windows® 2000 Service Pack 4 or the Windows® XP Service Pack1 before using Serial ATA hard disk drives.
- When using the connectors in standard IDE mode, you can connect the primary (boot) hard disk drive to any of the SATA connectors.

4. CPU fan connector (4-pin CPU_FAN)

The fan connector supports cooling fans of 350 mA~740 mA (8.88 W max.) or a total of 1 A~2.22 A (26.64 W max.) at +12V. Connect the fan cable to the fan connector on the motherboard, making sure that the cable's black wire matches the ground pin of the connector.



Do not forget to connect the fan cables to the fan connectors. Insufficient air flow inside the system may damage the motherboard components. These are not jumpers! Do not place jumper caps on the fan connectors!

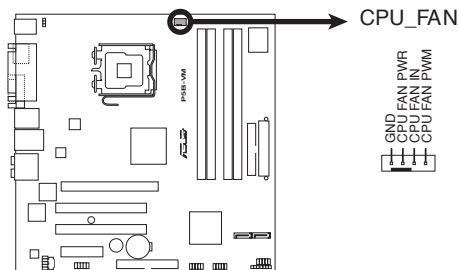

P5B-VM CPU Fan Connector

5. USB connectors (10-1 pin USB56, USB78)

These connectors are for USB 2.0 ports. Connect the USB/GAME module cable to any of these connectors, then install the module to a slot opening at the back of the system chassis. These USB connectors comply with USB 2.0 specification that supports up to 480 Mbps connection speed.

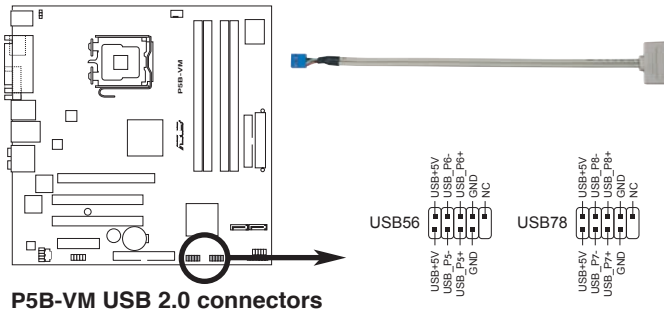

Never connect a 1394 cable to the USB connectors. Doing so will damage the motherboard!

6. Optical drive audio connector (4-pin CD)

This connector is for the 4-pin audio cable that connects to the audio connector at the back of the optical drive.

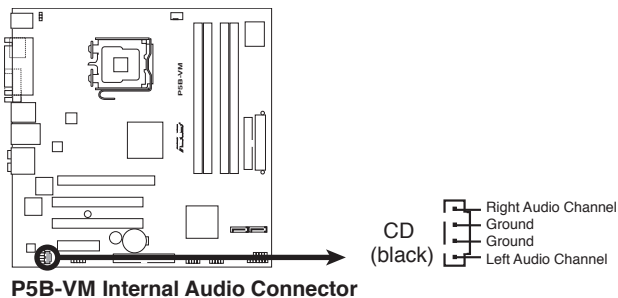

7. ATX power connectors (24-pin EATXPWR, 4-pin ATX12V)

These connectors are for ATX power supply plugs. The plugs from the power supply are pre-connected to these connectors. If you have disconnected them during installation, find the proper orientation and push down the plugs firmly to the connectors until they fit.

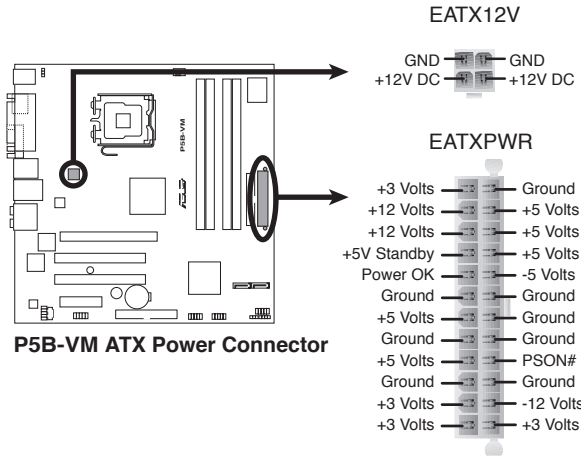

Important notes on the motherboard power requirements



- Do not forget to connect the 4-pin ATX +12 V power plug; otherwise, the system will not boot up.
- The system comes with a proprietary ATX 12 V Specification 2.0 power supply unit (PSU) with a minimum 275 W power rating.

8. Chassis intrusion connector (4-1 pin CHASSIS)

This connector is for a chassis-mounted intrusion detection sensor or switch. Connect one end of the chassis intrusion sensor or switch cable to this connector. The chassis intrusion sensor or switch sends a high-level signal to this connector when a chassis component is removed or replaced. The signal is then generated as a chassis intrusion event.

By default, the pin labeled “Chassis Signal” and “Ground” are shorted with a jumper cap. Remove the jumper caps only when you intend to use the chassis intrusion detection feature.

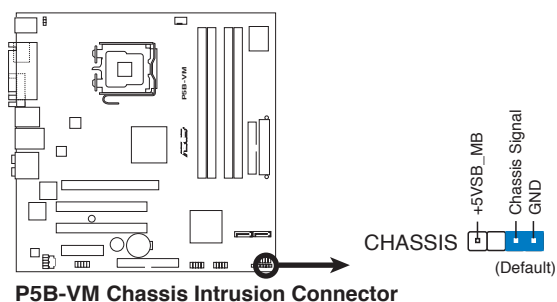

9. Front panel audio connector (10-1 pin AAFP1)

This connector supports the front panel audio I/O ports with either legacy AC'97 or High Definition Audio standard.

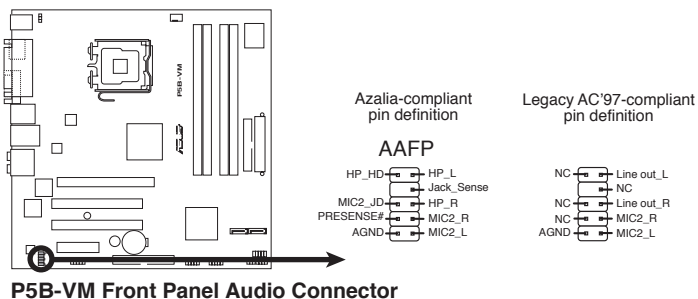

P5B-VM Front Panel Audio Connector



We recommend that you connect a high-definition front panel audio module to this connector to avail of the motherboard's High Definition Audio capability.

10. IEEE 1394a port connector (10-1 pin IE1394_2)

This connector supports the 4-pin IEEE 1394 port on the system front panel.

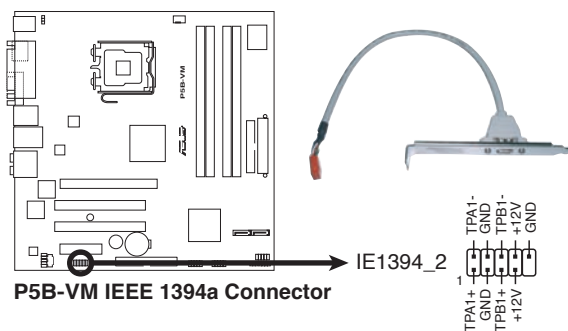

P5B-VM IEEE 1394a Connector



Never connect a USB cable to the IEEE 1394 connector. Doing so will damage the motherboard!

11. System panel connector (10-1 pin F_PANEL)

This connector supports several chassis-mounted functions.

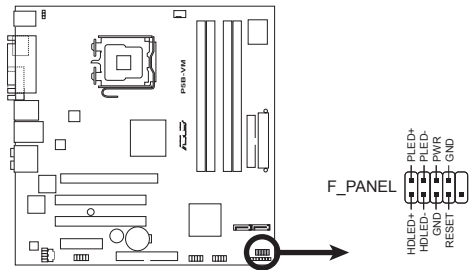

P5B-VM System Panel Connector



The system panel connector is color-coded for easy connection. Refer to the connector description below for details.

- **System power LED (Green 2-pin PWRLED)**
This 2-pin connector is for the system power LED. Connect the chassis power LED cable to this connector. The system power LED lights up when you turn on the system power, and blinks when the system is in sleep mode.
- **Hard disk drive activity LED (Red 2-pin PWRLED)**
This 2-pin connector is for the HDD Activity LED. Connect the HDD Activity LED cable to this connector. The IDE LED lights up or flashes when data is read from or written to the HDD.
- **ATX power button/soft-off button (Black 2-pin PWRSW)**
This connector is for the system power button. Pressing the power button turns the system on or puts the system in sleep or soft-off mode depending on the BIOS settings. Pressing the power switch for more than four seconds while the system is ON turns the system OFF.
- **Reset button (Blue 2-pin RESET)**
This 2-pin connector is for the chassis-mounted reset button for system reboot without turning off the system power.

Chapter 5

This chapter tells how to change system settings through the BIOS Setup menus and describes the BIOS parameters.



ASUS Pundit P3-PH5

BIOS setup

5.1 Managing and updating your BIOS

The following utilities allow you to manage and update the motherboard Basic Input/Output System (BIOS) setup.

1. **ASUS EZ Flash 2** (Updates the BIOS using a floppy disk, USB Flash, or the motherboard support CD during POST.)
2. **ASUS AFUDOS** (Updates the BIOS in DOS mode using a bootable floppy disk.)
3. **ASUS CrashFree BIOS 3** (Updates the BIOS using a bootable floppy, USB Flash disk, or the motherboard support CD when the BIOS file fails or gets corrupted.)
4. **ASUS Update** (Updates the BIOS in Windows® environment.)

Refer to the corresponding sections for details on these utilities.



Save a copy of the original motherboard BIOS file to a bootable floppy disk or a USB flash disk in case you need to restore the BIOS in the future. Copy the original motherboard BIOS using the ASUS Update or AFUDOS utilities.

5.1.1 Creating a bootable floppy disk

1. Do either one of the following to create a bootable floppy disk.
 - DOS environment
 - a. Insert a 1.44MB floppy disk into the drive.
 - b. At the DOS prompt, type `format A: /s` then press <Enter>.
 - Windows® XP environment
 - a. Insert a 1.44 MB floppy disk to the floppy disk drive.
 - b. Click **Start** from the Windows® desktop, then select **My Computer**.
 - c. Select the 3 1/2 Floppy Drive icon.
 - d. Click **File** from the menu, then select **Format. A Format 3 1/2 Floppy Disk** window appears.
 - e. Select **Create an MS-DOS startup disk** from the format options field, then click **Start**.

Windows® 2000 environment

To create a set of boot disks for Windows® 2000:

- a. Insert a formatted, high density 1.44 MB floppy disk into the drive.
- b. Insert the Windows® 2000 CD to the optical drive.
- c. Click **Start**, then select **Run**.
- d. From the Open field, type
`D:\bootdisk\makeboot a:`
assuming that D: is your optical drive.
- e. Press <Enter>, then follow screen instructions to continue.

2. Copy the original or the latest motherboard BIOS file to the bootable floppy disk.

5.1.2 ASUS EZ Flash 2 utility

The ASUS EZ Flash 2 feature allows you to update the BIOS without having to go through the long process of booting from a floppy disk and using a DOS-based utility. The EZ Flash 2 utility is built-in the BIOS chip so it is accessible by pressing <Alt> + <F2> during the Power-On Self-Test (POST).

To update the BIOS using EZ Flash 2:

1. Visit the ASUS website (www.asus.com) to download the latest BIOS file for the motherboard.
2. Save the BIOS file to a floppy disk or a USB flash disk, then restart the system.
3. You can launch the EZ Flash 2 by two methods.
 - (1) Insert the floppy disk / USB flash disk that contains the BIOS file to the floppy disk drive or the USB port.

Press <Alt> + <F2> during POST to display the following.

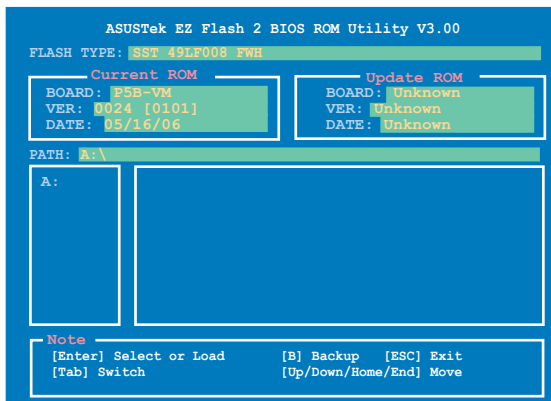

- (2) Enter BIOS setup program. Go to the **Tools** menu to select **EZ Flash2** and press <Enter> to enable it.

You can switch between drives by pressing <Tab> before the correct file is found. Then press <Enter>.
4. When the correct BIOS file is found, EZ Flash 2 performs the BIOS update process and automatically reboots the system when done.



- This function can support devices such as USB flash disk, or floppy disk with **FAT 32/16** format only.
- Do not shut down or reset the system while updating the BIOS to prevent system boot failure!



-
- This function can support devices such as USB flash disk, or floppy disk with **FAT 32/16** format only.
 - Do not shut down or reset the system while updating the BIOS to prevent system boot failure!
-

5.1.3 AFUDOS utility

The AFUDOS utility allows you to update the BIOS file in DOS environment using a bootable floppy disk with the updated BIOS file. This utility also allows you to copy the current BIOS file that you can use as backup when the BIOS fails or gets corrupted during the updating process.

Copying the current BIOS

To copy the current BIOS file using the AFUDOS utility:



-
- Make sure that the floppy disk is not write-protected and has at least 1024KB free space to save the file.
 - The succeeding BIOS screens are for reference only. The actual BIOS screen displays may not be same as shown.
-

1. Copy the AFUDOS utility (afudos.exe) from the motherboard support CD to the bootable floppy disk you created earlier.
2. Boot the system in DOS mode, then at the prompt type:

```
afudos /o[filename]
```

where the [filename] is any user-assigned filename not more than eight alphanumeric characters for the main filename and three alphanumeric characters for the extension name.

```
A:\>afudos /oOLDBIOS1.com
```

Main filename Extension name

3. Press <Enter>. The utility copies the current BIOS file to the floppy disk.

```
A:\>afudos /oOLDBIOS1.com
AMI Firmware Update Utility - Version 1.19 (ASUS V2.07 (03.11.24BB))
Copyright (C) 2002 American Megatrends, Inc. All rights reserved.
Reading flash ..... done
Write to file..... ok
A:\>
```

The utility returns to the DOS prompt after copying the current BIOS file.

Updating the BIOS file

To update the BIOS file using the AFUDOS utility:

1. Visit the ASUS website (www.asus.com) and download the latest BIOS file for the motherboard. Save the BIOS file to a bootable floppy disk.



Write the BIOS filename on a piece of paper. You need to type the exact BIOS filename at the DOS prompt.

2. Copy the AFUDOS utility (`afudos.exe`) from the motherboard support CD to the bootable floppy disk you created earlier.
3. Boot the system in DOS mode, then at the prompt type:
afudos /i [filename]

where [filename] is the latest or the original BIOS file on the bootable floppy disk.

```
A:\>afudos /iP5B-VM.ROM
```

4. The utility verifies the file and starts updating the BIOS.

```
A:\>afudos /iP5B-VM.ROM
AMI Firmware Update Utility - Version 1.19 (ASUS V2.07(03.11.24BB))
Copyright (C) 2002 American Megatrends, Inc. All rights reserved.

WARNING!! Do not turn off power during flash BIOS
Reading file ..... done
Reading flash ..... done

Advance Check .....
Erasing flash ..... done
Writing flash ..... 0x0008CC00 (9%)
```



Do not shut down or reset the system while updating the BIOS to prevent system boot failure!

5. The utility returns to the DOS prompt after the BIOS update process is completed. Reboot the system from the hard disk drive.

```
A:\>afudos /iP5B-VM.ROM
AMI Firmware Update Utility - Version 1.19 (ASUS V2.07(03.11.24BB))
Copyright (C) 2002 American Megatrends, Inc. All rights reserved.

WARNING!! Do not turn off power during flash BIOS
Reading file ..... done
Reading flash ..... done

Advance Check .....
Erasing flash ..... done
Writing flash ..... done
Verifying flash .... done

Please restart your computer

A:\>
```

5.1.4 ASUS CrashFree BIOS 3 utility

The ASUS CrashFree BIOS 3 is an auto recovery tool that allows you to restore the BIOS file when it fails or gets corrupted during the updating process. You can update a corrupted BIOS file using the motherboard support CD, the USB flash disk, or the floppy disk that contains the updated BIOS file.



- Prepare the motherboard support CD, the USB flash disk, or the floppy disk containing the updated motherboard BIOS before using this utility.
- Make sure that you rename the original or updated BIOS file in the floppy disk or the USB flash disk to **P5BVMP.ROM**.

If your display monitor is connected to the onboard VGA connector, the display monitor will turn-off and the system will beep once while CrashFree BIOS 3 starts updating your system. The system will beep once again while the process is finished, and the display will return after the system restarts.

Recovering the BIOS from a floppy disk

To recover the BIOS from a floppy disk:

1. Turn on the system.
2. Insert the floppy disk with the original or updated BIOS file to the floppy disk drive.
3. The utility displays the following message and automatically checks the floppy disk for the original or updated BIOS file.

```
Bad BIOS checksum. Starting BIOS recovery...  
Checking for floppy...
```

When found, the utility reads the BIOS file and starts flashing the corrupted BIOS file.

```
Bad BIOS checksum. Starting BIOS recovery...  
Checking for floppy...  
Floppy found!  
Reading file "P5BVMP.ROM". Completed.  
Start flashing...
```

4. Restart the system after the utility completes the updating process.

Recovering the BIOS from the support CD

To recover the BIOS from the support CD:

1. Remove any floppy disk from the floppy disk drive, then turn on the system.
2. Insert the support CD to the optical drive.
3. The utility displays the following message and automatically checks the floppy disk for the original or updated BIOS file.

```
Bad BIOS checksum. Starting BIOS recovery...
Checking for floppy...
```

When no floppy disk is found, the utility automatically checks the optical drive for the original or updated BIOS file. The utility then updates the corrupted BIOS file.

```
Bad BIOS checksum. Starting BIOS recovery...
Checking for floppy...
Floppy not found!
Checking for CD-ROM...
CD-ROM found!
Reading file "P5BVMP.ROM". Completed.
Start flashing...
```

4. Restart the system after the utility completes the updating process.

Recovering the BIOS from the USB flash disk

To recover the BIOS from the USB flash disk:

1. Insert the USB flash disk that contains BIOS file to the USB port.
2. Turn on the system.
3. The utility will automatically checks the devices for the BIOS file when found, the utility reads the BIOS file and starts flashing the corrupted BIOS file.
4. Restart the system after the utility completes the updating process.



The recovered BIOS may not be the latest BIOS version for this motherboard. Visit the ASUS website (www.asus.com) to download the latest BIOS file.



-
- Only the USB flash disk with FAT 32/16 format and single partition can support ASUS CrashFree BIOS 3. The device size should be smaller than 8GB.
 - DO NOT shut down or reset the system while updating the BIOS! Doing so can cause system boot failure!
-

5.1.5 ASUS Update utility

The ASUS Update is a utility that allows you to manage, save, and update the motherboard BIOS in Windows® environment. The ASUS Update utility allows you to:

- Save the current BIOS file
- Download the latest BIOS file from the Internet
- Update the BIOS from an updated BIOS file
- Update the BIOS directly from the Internet, and
- View the BIOS version information.

This utility is available in the support CD that comes with the motherboard package.



ASUS Update requires an Internet connection either through a network or an Internet Service Provider (ISP).

Installing ASUS Update

To install ASUS Update:

1. Place the support CD in the optical drive. The **Drivers** menu appears.
2. Click the **Utilities** tab, then click **Install ASUS Update**. See page 3-3 for the **Utilities** screen menu.
3. The ASUS Update utility is copied to your system.



Quit all Windows® applications before you update the BIOS using this utility.

Updating the BIOS through the Internet

To update the BIOS through the Internet:

1. Launch the ASUS Update utility from the Windows® desktop by clicking **Start > Programs > ASUS > ASUSUpdate > ASUSUpdate**. The ASUS Update main window appears.

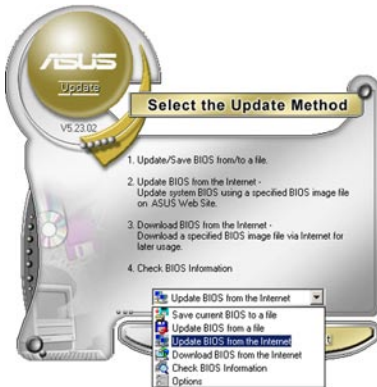
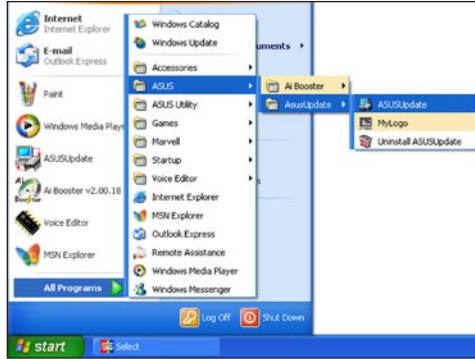

2. Select **Update BIOS from the Internet** option from the drop-down menu, then click **Next**.



3. Select the ASUS FTP site nearest you to avoid network traffic, or click **Auto Select**. Click **Next**.

- From the FTP site, select the BIOS version that you wish to download. Click **Next**.
- Follow the screen instructions to complete the update process.



The ASUS Update utility is capable of updating itself through the Internet. Always update the utility to avail all its features.



Updating the BIOS through a BIOS file

To update the BIOS through a BIOS file:

- Launch the ASUS Update utility from the Windows® desktop by clicking **Start > Programs > ASUS > ASUSUpdate > ASUSUpdate**. The ASUS Update main window appears.
- Select **Update BIOS from a file** option from the drop-down menu, then click **Next**.



- Locate the BIOS file from the **Open** window, then click **Open**.
- Follow the screen instructions to complete the update process.

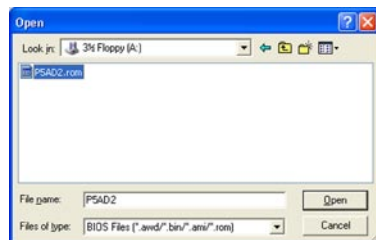

5.2 BIOS setup program

This motherboard supports a programmable firmware chip that you can update using the provided utility described in section “5.1 Managing and updating your BIOS.”

Use the BIOS Setup program when you are installing a motherboard, reconfiguring your system, or prompted to “Run Setup.” This section explains how to configure your system using this utility.

Even if you are not prompted to use the Setup program, you can change the configuration of your computer in the future. For example, you can enable the security password feature or change the power management settings. This requires you to reconfigure your system using the BIOS Setup program so that the computer can recognize these changes and record them in the CMOS RAM of the SPI chip.

The firmware chip on the motherboard stores the Setup utility. When you start up the computer, the system provides you with the opportunity to run this program. Press during the Power-On Self-Test (POST) to enter the Setup utility; otherwise, POST continues with its test routines.

If you wish to enter Setup after POST, reboot the system by doing any of the following procedures:

- Restart using the OS standard shut-down procedure.
- Press <Ctrl>+<Alt>+ simultaneously.
- Press the reset button on the system chassis.
- Press the power button to turn the system off then back on.



Using the **power button**, **reset button**, or the <Ctrl>+<Alt>+ keys to force reset from a running operating system can cause damage to your data or system. We recommend to always shut-down the system properly from the operating system.

The Setup program is designed to make it as easy to use as possible. Being a menu-driven program, it lets you scroll through the various sub-menus and make your selections from the available options using the navigation keys.



-
- The default BIOS settings for this motherboard apply for most conditions to ensure optimum performance. If the system becomes unstable after changing any BIOS settings, load the default settings to ensure system compatibility and stability. Select the **Load Setup Defaults** item under the Exit Menu. See section “5.8 Exit Menu.”
 - The BIOS setup screens shown in this section are for reference purposes only, and may not exactly match what you see on your screen.
 - Visit the ASUS website (www.asus.com) to download the latest BIOS file for this motherboard.
-

5.2.1 BIOS menu screen

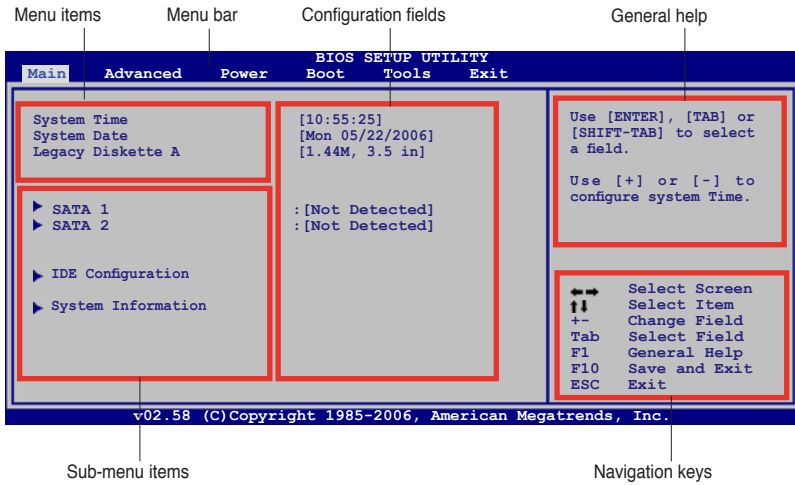

5.2.2 Menu bar

The menu bar on top of the screen has the following main items:

Main	For changing the basic system configuration
Advanced	For changing the advanced system settings
Power	For changing the advanced power management (APM) configuration
Boot	For changing the system boot configuration
Tools	For configuring options for special functions
Exit	For selecting the exit options and loading default settings

To select an item on the menu bar, press the right or left arrow key on the keyboard until the desired item is highlighted.

5.2.3 Navigation keys

At the bottom right corner of a menu screen are the navigation keys for that particular menu. Use the navigation keys to select items in the menu and change the settings.



Some of the navigation keys differ from one screen to another.

5.2.4 Menu items

The highlighted item on the menu bar displays the specific items for that menu. For example, selecting Main shows the Main menu items.

The other items (Advanced, Power, Boot, Tool, and Exit) on the menu bar have their respective menu items.

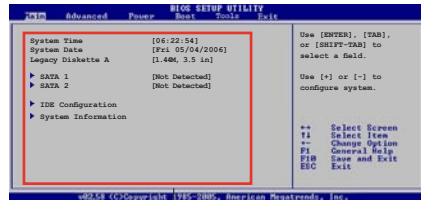

Main menu items

5.2.5 Sub-menu items

A solid triangle before each item on any menu screen means that the item has a sub-menu. To display the sub-menu, select the item and press <Enter>.

5.2.6 Configuration fields

These fields show the values for the menu items. If an item is user-configurable, you can change the value of the field opposite the item. You cannot select an item that is not user-configurable.

A configurable field is enclosed in brackets, and is highlighted when selected. To change the value of a field, select it then press <Enter> to display a list of options. Refer to "5.2.7 Pop-up window."

5.2.7 Pop-up window

Select a menu item then press <Enter> to display a pop-up window with the configuration options for that item.

5.2.8 Scroll bar

A scroll bar appears on the right side of a menu screen when there are items that do not fit on the screen. Press the Up/Down arrow keys or <Page Up> / <Page Down> keys to display the other items on the screen.

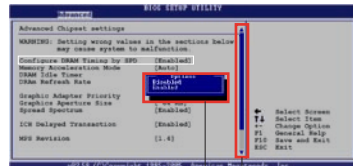

Pop-up window

Scroll bar

5.2.9 General help

At the top right corner of the menu screen is a brief description of the selected item.

5.3 Main menu

When you enter the BIOS Setup program, the Main menu screen appears, giving you an overview of the basic system information.



Refer to section "5.2.1 BIOS menu screen" for information on the menu screen items and how to navigate through them.

```
BIOS SETUP UTILITY
Main  Advanced  Power  Boot  Tools  Exit

System Time           [10:55:25]
System Date           [Mon 05/22/2006]
Legacy Diskette A     [1.44M, 3.5 in]

▶ SATA 1               : [Not Detected]
▶ SATA 2               : [Not Detected]

▶ IDE Configuration
▶ System Information

Use [ENTER], [TAB] or [SHIFT-TAB] to select a field.

Use [+] or [-] to configure system Time.

←→ Select Screen
↑↓ Select Item
+- Change Field
Tab Select Field
F1 General Help
F10 Save and Exit
ESC Exit

v02.58 (C) Copyright 1985-2006, American Megatrends, Inc.
```

5.3.1 System Time [xx:xx:xx]

Allows you to set the system time.

5.3.2 System Date [Day xx/xx/xxxx]

Allows you to set the system date.

5.3.3 Legacy Diskette A [1.44M, 3.5 in.]

Sets the type of floppy drive installed.

Configuration options: [Disabled] [360K, 5.25 in.] [1.2M, 5.25 in.] [720K, 3.5 in.] [1.44M, 3.5 in.] [2.88M, 3.5 in.]

5.3.4 SATA1 and SATA 2

While entering Setup, the BIOS automatically detects the presence of IDE devices. There is a separate sub-menu for each IDE device. Select a device item then press <Enter> to display the IDE device information.

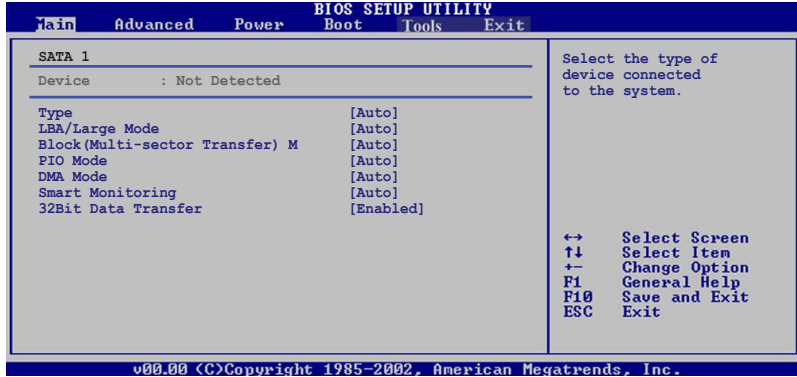

The BIOS automatically detects the values opposite the dimmed items (Device, Vendor, Size, LBA Mode, Block Mode, PIO Mode, Async DMA, Ultra DMA, and SMART monitoring). These values are not user-configurable. These items show N/A if no IDE device is installed in the system.

Type [Auto]

Selects the type of IDE drive. Setting to Auto allows automatic selection of the appropriate IDE device type. Select CDROM if you are specifically configuring a CD-ROM drive. Select ARMD (ATAPI Removable Media Device) if your device is either a ZIP, LS-120, or MO drive.

Configuration options: [Not Installed] [Auto] [CDROM] [ARMD]

LBA/Large Mode [Auto]

Enables or disables the LBA mode. Setting to Auto enables the LBA mode if the device supports this mode, and if the device was not previously formatted with LBA mode disabled. Configuration options: [Disabled] [Auto]

Block (Multi-sector Transfer) M [Auto]

Enables or disables data multi-sectors transfers. When set to Auto, the data transfer from and to the device occurs multiple sectors at a time if the device supports multi-sector transfer feature. When set to [Disabled], the data transfer from and to the device occurs one sector at a time.

Configuration options: [Disabled] [Auto]

PIO Mode [Auto]

Selects the PIO mode.

Configuration options: [Auto] [0] [1] [2] [3] [4]

DMA Mode [Auto]

Selects the DMA mode. Configuration options: [Auto] [SWDMA0] [SWDMA1] [SWDMA2] [MWDMA0] [MWDMA1] [MWDMA2] [UDMA0] [UDMA1] [UDMA2] [UDMA3] [UDMA4] [UDMA5]

SMART Monitoring [Auto]

Sets the Smart Monitoring, Analysis, and Reporting Technology.

Configuration options: [Auto] [Disabled] [Enabled]

32Bit Data Transfer [Enabled]

Enables or disables 32-bit data transfer.

Configuration options: [Disabled] [Enabled]

5.3.5 IDE Configuration

The items in this menu allow you to set or change the configurations for the IDE devices installed in the system. Select an item then press <Enter> if you wish to configure the item.

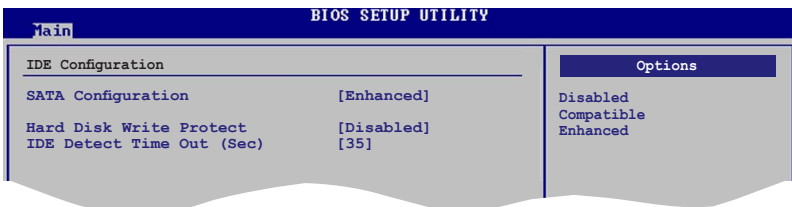

SATA Configuration [Enhanced]

Configuration options: [Disabled] [Compatible] [Enhanced]

Hard Disk Write Protect [Disabled]

Allows you to enable to disable the hard disk write protection. This will be effective only if device is accessed through BIOS.

Configuration options: [Disabled] [Enabled]

IDE Detect Time Out [35]

Selects the time out value for detecting ATA/ATAPI devices.

Configuration options: [0] [5] [10] [15] [20] [25] [30] [35]

5.3.6 System Information

This menu gives you an overview of the general system specifications. The BIOS automatically detects the items in this menu.

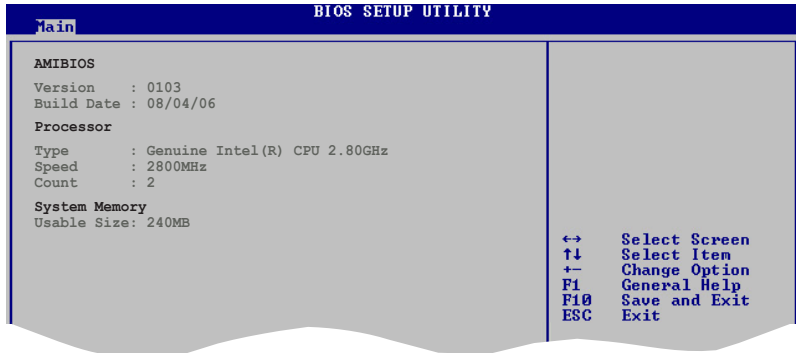

AMI BIOS

Displays the auto-detected BIOS information

Processor

Displays the auto-detected CPU specification

System Memory

Displays the auto-detected system memory

5.4 Advanced menu

The Advanced menu items allow you to change the settings for the CPU and other system devices.



Take caution when changing the settings of the Advanced menu items. Incorrect field values can cause the system to malfunction.

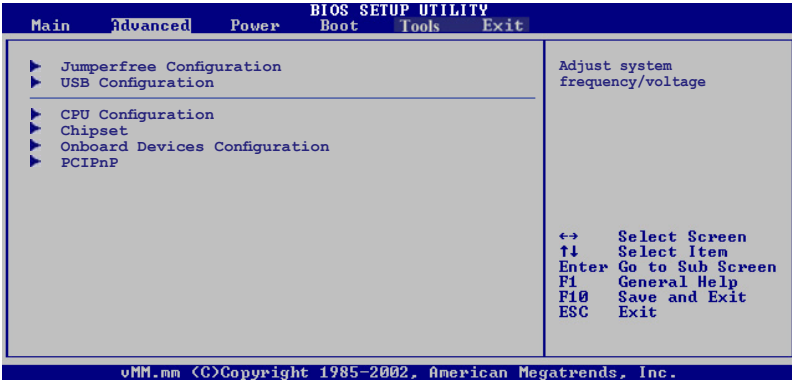

5.4.1 Jumperfree Configuration

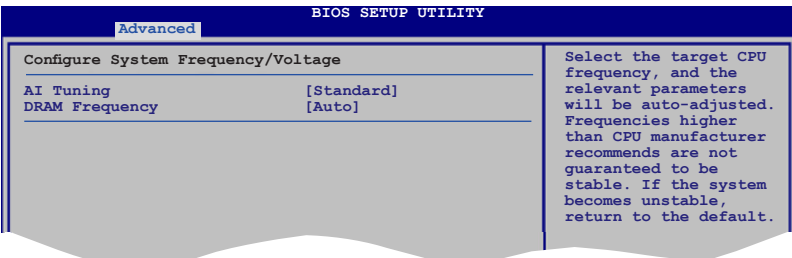

AI Tuning [Standard]

Allows selection of CPU frequency and auto adjustment of relevant parameters. Frequencies higher than CPU manufacturer recommends are not guaranteed to be stable. If the system becomes unstable, return to the default. Configuration options: [Manual] [Standard]



The following items appear only when the AI Tuning item is set to [Manual].

CPU Frequency [xxx]

Displays the frequency sent by the clock generator to the system bus and PCI bus. The value of this item is auto-detected by the BIOS. Use the \leftrightarrow and \leftrightarrow keys to adjust the CPU frequency. You can also type the desired CPU frequency using the numeric keypad. The values range from 100 to 400. Refer to the table below for the correct Front Side Bus and CPU External Frequency settings.

FSB/CPU External Frequency Synchronization

Front Side Bus	CPU External Frequency
FSB 1066	266 MHz
FSB 800	200 MHz
FSB 533	133 MHz

DRAM Frequency [Auto]

Allows you to set the DDR operating frequency.

Configuration options:

Available DRAM frequency options in various FSB settings

FSB	Configuration options					
	Auto	DDR2-533	DDR2-667	DDR2-800	DDR2-889*	DDR2-1067*
FSB 1066	•	•	•	•	•	•
FSB 800	•	•	•	•		

* Provided for overclocking purpose only.



Selecting a very high DRAM frequency may cause the system to become unstable! If this happens, revert to the default setting.



The DRAM Frequency item also appears when you set the AI Tuning item to [AI NOS].

PCI Express Frequency [Auto]

Allows you to select PCI Express frequency.

Configuration options: [Auto] [90] [91] [92] [93]... [150]

Spread Spectrum [Enabled]

Allows you to enable or disable the clock generator spread spectrum.

Configuration options: [Disabled] [Enabled]

Memory Voltage [Auto]

Allows you to select the memory voltage or set it to auto for safe mode.

Configuration options: [Auto] [1.80V] [1.85V] [1.90V] [1.95V]

CPU VCore Voltage [Auto]

Allows selection of the CPU VCore voltage. The configuration options vary depending on the CPU installed. Setting to Auto allows the BIOS to detect the VCore voltage of the CPU installed.



Refer to the CPU documentation before setting the CPU VCore voltage. A very high Vcore voltage can severely damage the CPU!

5.4.2 USB Configuration

The items in this menu allows you to change the USB-related features. Select an item then press <Enter> to display the configuration options.

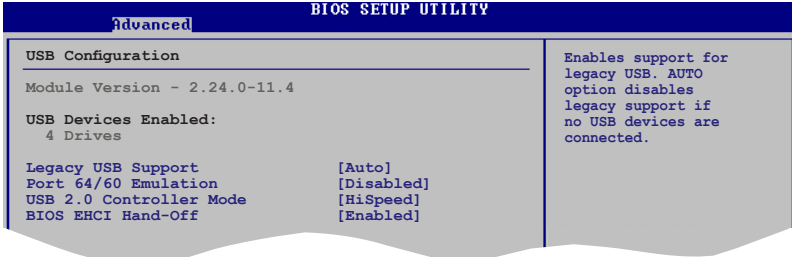

The Module Version and USB Devices Enabled items show the auto-detected values. If no USB device is detected, the item shows None.

Legacy USB Support [Auto]

Allows you to enable or disable support for USB devices on legacy operating systems (OS). Setting to Auto allows the system to detect the presence of USB devices at startup. If detected, the USB controller legacy mode is enabled. If no USB device is detected, the legacy USB support is disabled.

Configuration options: [Disabled] [Enabled] [Auto]

Port 64/60 Emulation [Disabled]

Allows you to disable or enable the I/O port 60h/64h emulation support. This should be enabled for the complete USB keyboard legacy support for non-USB aware OSes. Configuration options: [Disabled] [Enabled]

USB 2.0 Controller Mode [HiSpeed]

Allows you to configure the USB 2.0 controller in HiSpeed (480 Mbps) or Full Speed (12 Mbps). Configuration options: [Full Speed] [HiSpeed]

BIOS EHCI Hand-Off [Enabled]

Allows you to enable support for operating systems without an EHCI hand-off feature. Configuration options: [Disabled] [Enabled]

5.4.3 CPU Configuration

The items in this menu show the CPU-related information that the BIOS automatically detects.

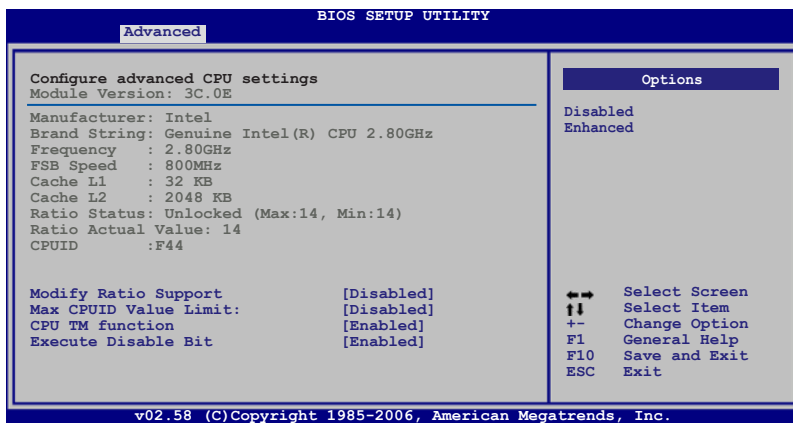

Modify Ratio Support [Disabled]

Configuration options: [Disabled] [Enabled]



The following item appears when the item **Modify Ratio Support** is set to **Enabled**.

Ratio CMOS Setting: [14]

Max CPUID Value Limit [Disabled]

Setting this item to [Enabled] allows legacy operating systems to boot even without support for CPUs with extended CPUID functions.

Configuration options: [Disabled] [Enabled]

CPU TM function [Enabled]

Allows you to enable or disable the CPU internal thermal control function. In TM mode, the CPU power consumption is reduced. Configuration options: [Disabled] [Enabled]

Execute Disable Bit [Enabled]

Allows you to enable or disable the No-Execution Page Protection Technology. Setting this item to [Disabled] forces the XD feature flag to always return to zero (0). Configuration options: [Disabled] [Enabled]



The following item appears only when you installed an Intel® Pentium® 4 CPU that supports the Hyperthreading Technology and Enhanced Intel SpeedStep® Technology (EIST).

Hyper-Threading Technology [Enabled]

Allows you to enable or disable the processor Hyper-Threading Technology. Refer to the Appendix for more information on the Hyper-Threading Technology. Configuration options: [Disabled] [Enabled]

Intel(R) SpeedStep Technology [Automatic]

Allows you to use the Enhanced Intel SpeedStep® Technology. When set to [Automatic], you can adjust the system power settings in the operating system to use the EIST feature.

Set this item to [Maximum] or [Disabled] if you **do not** want to use the EIST. The CPU constantly operates at a lower internal frequency when you set this item to [Minimum]. Configuration options: [Maximum] [Minimum] [Automatic] [Disabled]

5.4.4 Chipset

The Chipset menu allows you to change the advanced chipset settings. Select an item then press <Enter> to display the sub-menu.

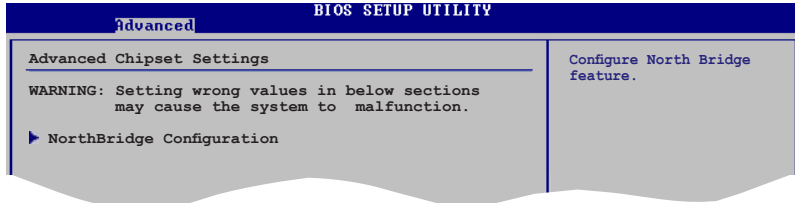

NorthBridge Configuration

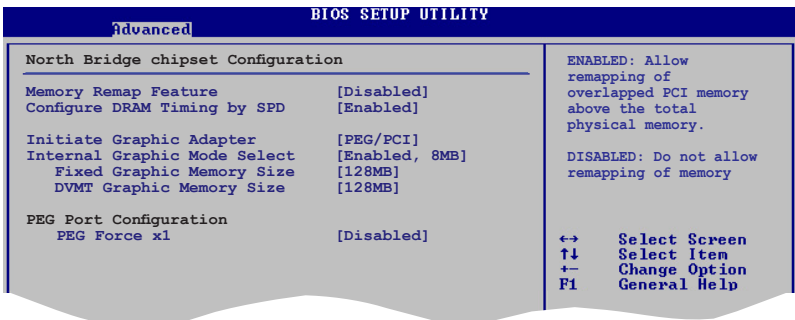

Memory Remap Feature [Disabled]

Allows you to enable or disable the remapping of the overlapped PCI memory above the total physical memory. Enable this option only when you install 64-bit operating system. Configuration options: [Disabled] [Enabled]

Configure DRAM Timing by SPD [Enabled]

When this item is enabled, the DRAM timing parameters are set according to the DRAM SPD (Serial Presence Detect). When disabled, you can manually set the DRAM timing parameters through the DRAM sub-items. Configuration options: [Enabled] [Disabled]

Initiate Graphic Adapter [PEG/PCI]

Allows you to select the graphics controller as the primary boot device. Configuration options: [IGD] [PCI/IGD] [PCI/PEG] [PEG/IGD] [PEG/PCI]

Internal Graphic Mode Select [Enabled, 8MB]

Allows you to select the amount of system memory used by the Internal graphics device. Configuration options: [Disabled] [Enabled, 1MB] [Enabled, 8MB]

Fixed Graphic Memory Size [128MB]

Allows you to select the Fixed graphic memory size.

Configuration options: [0MB] [32MB] [64MB] [128MB]

DVMT Graphic Memory Size [128MB]

Allows you to select the DVMT graphic memory size.

Configuration options: [0MB] [32MB] [64MB] [128MB] [224MB]

PEG Force x1 [Disabled]

Configuration options: [Enabled] [Disabled]

5.4.5 Onboard Devices Configuration

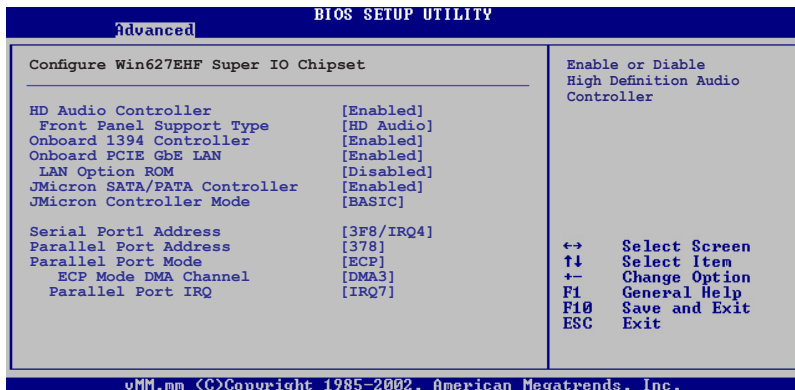

HD Audio Controller [Enabled]

Allows you to enable or disable the High Definition Audio Controller.

Configuration options: [Disabled] [Enabled]

Front Panel Support Type [HD Audio]

Allows you to set the front panel audio connector (AAFP) mode to legacy AC'97 or high-definition audio depending on the audio standard that the front panel audio module supports. Configuration options: [AC97] [HD Audio]

Onboard 1394 Controller [Enabled]

Allows you to enable or disable the onboard 1394 controller.

Configuration options: [Enabled] [Disabled]

Onboard PCIE Gb LAN [Enabled]

Allows you to enable or disable the onboard PCIE Gigabit LAN controller.

Configuration options: [Enabled] [Disabled]

LAN Option ROM [Disabled]

Configuration options: [Disabled] [Enabled]

JMicron SATA/PATA Controller [Enabled]

Allows you to enable or disable the JMicron SATA/PATA controller.

Configuration options: [Disabled] [Enabled]

JMicron Controller Mode [Basic]

Configuration options: [BASIC] [AHC]

Serial Port1 Address [3F8/IRQ4]

Allows you to select the Serial Port1 base address.

Configuration options: [Disabled] [3F8/IRQ4][2F8/IRQ3] [3E8/IRQ4] [2E8/IRQ3]

Parallel Port Address [378]

Allows you to select the Parallel Port base addresses.

Configuration options: [Disabled] [378] [278] [3BC]

Parallel Port Mode [ECP]

Allows you to select the Parallel Port mode.

Configuration options: [Normal] [Bi-directional] [EPP] [ECP]

ECP Mode DMA Channel [DMA3]

Appears only when the Parallel Port Mode is set to [ECP]. This item allows you to set the Parallel Port ECP DMA.

Configuration options: [DMA0] [DMA1] [DMA3]

Parallel Port IRQ [IRQ7]

Configuration options: [IRQ5] [IRQ7]

5.4.6 PCI PnP

The PCI PnP menu items allow you to change the advanced settings for PCI/PnP devices. The menu includes setting IRQ and DMA channel resources for either PCI/PnP or legacy ISA devices, and setting the memory size block for legacy ISA devices.



Take caution when changing the settings of the PCI PnP menu items. Incorrect field values can cause the system to malfunction.

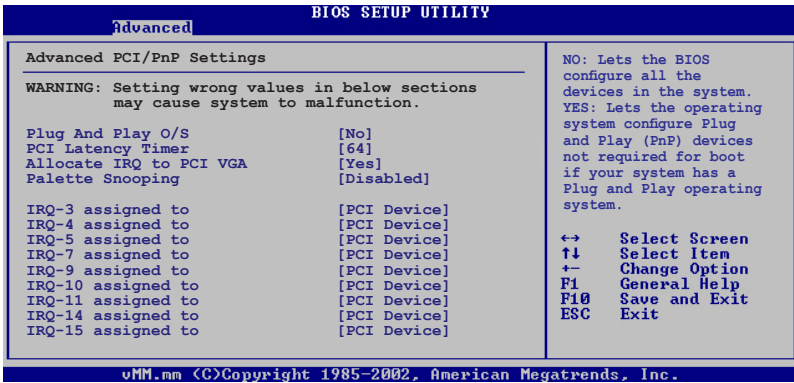

Plug and Play O/S [No]

When set to [No], BIOS configures all the devices in the system. When set to [Yes] and if you install a Plug and Play operating system, the operating system configures the Plug and Play devices not required for boot.

Configuration options: [No] [Yes]

PCI Latency Timer [64]

Allows you to select the value in units of PCI clocks for the PCI device latency timer register. Configuration options: [32] [64] [96] [128] [160] [192] [224] [248]

Allocate IRQ to PCI VGA [Yes]

When set to [Yes], BIOS assigns an IRQ to PCI VGA card if the card requests for an IRQ. When set to [No], BIOS does not assign an IRQ to the PCI VGA card even if requested. Configuration options: [No] [Yes]

Palette Snooping [Disabled]

When set to [Enabled], the palette snooping feature informs the PCI devices that an ISA graphics device is installed in the system so that the latter can function correctly. Configuration options: [Disabled] [Enabled]

IRQ-xx assigned to [PCI Device]

When set to [PCI Device], the specific IRQ is free for use of PCI/PnP devices. When set to [Reserved], the IRQ is reserved for legacy ISA devices. Configuration options: [PCI Device] [Reserved]

5.5 Power menu

The Power menu items allow you to change the settings for the Advanced Power Management (APM). Select an item then press <Enter> to display the configuration options.

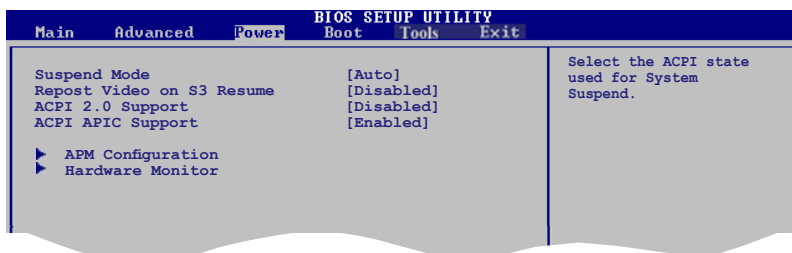

5.5.1 Suspend Mode [Auto]

Allows you to select the Advanced Configuration and Power Interface (ACPI) state to be used for system suspend.

Configuration options: [S1(POS) Only] [S3 Only] [Auto]

5.5.2 Repost Video on S3 Resume [Disabled]

Allows you to determine whether to invoke VGA BIOS POST on S3/STR resume.

Configuration options: [Disabled] [Enabled]

5.5.3 ACPI 2.0 Support [Disabled]

Allows you to add more tables for Advanced Configuration and Power Interface (ACPI) 2.0 specifications. Configuration options: [Disabled] [Enabled]

5.5.4 ACPI APIC Support [Enabled]

Allows you to enable or disable the Advanced Configuration and Power Interface (ACPI) support in the Application-Specific Integrated Circuit (ASIC). When set to Enabled, the ACPI APIC table pointer is included in the RSDT pointer list.

Configuration options: [Disabled] [Enabled]

5.5.5 APM Configuration

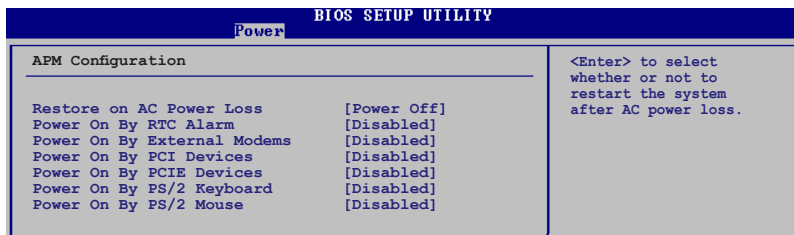

Restore on AC Power Loss [Power Off]

When set to Power Off, the system goes into off state after an AC power loss. When set to Power On, the system goes on after an AC power loss. When set to Last State, the system goes into either off or on state, whatever the system state was before the AC power loss.

Configuration options: [Power Off] [Power On] [Last State]

Power On By RTC Alarm [Disabled]

Allows you to enable or disable RTC to generate a wake event. When this item is set to Enabled, the items RTC Alarm Date / RTC Alarm Hour / RTC Alarm Minute / RTC Alarm Second will become user-configurable with set values.

Configuration options: [Disabled] [Enabled]

Power On By External Modems [Disabled]

This allows either settings of [Enabled] or [Disabled] for powering up the computer when the external modem receives a call while the computer is in Soft-off mode.

Configuration options: [Disabled] [Enabled]



The computer cannot receive or transmit data until the computer and applications are fully running. Thus, connection cannot be made on the first try. Turning an external modem off and then back on while the computer is off causes an initialization string that turns the system power on.

Power On By PCI Devices [Disabled]

Allows you to enable or disable the PME to wake up from S5 by PCI devices.

Configuration options: [Disabled] [Enabled]

Power On By PCIE Devices [Disabled]

Allows you to enable or disable the PCIE devices to generate a wake event.

Configuration options: [Disabled] [Enabled]

Power On By PS/2 Keyboard [Disabled]

Allows you to use specific keys on the keyboard to turn on the system. This feature requires an ATX power supply that provides at least 1A on the +5VSB lead. Configuration options: [Disabled] [Space Bar] [Ctrl-Esc] [Power Key]

Power On By PS/2 Mouse [Disabled]

When set to [Enabled], this parameter allows you to use the PS/2 mouse to turn on the system. This feature requires an ATX power supply that provides at least 1A on the +5VSB lead. Configuration options: [Disabled] [Enabled]

5.5.6 Hardware Monitor

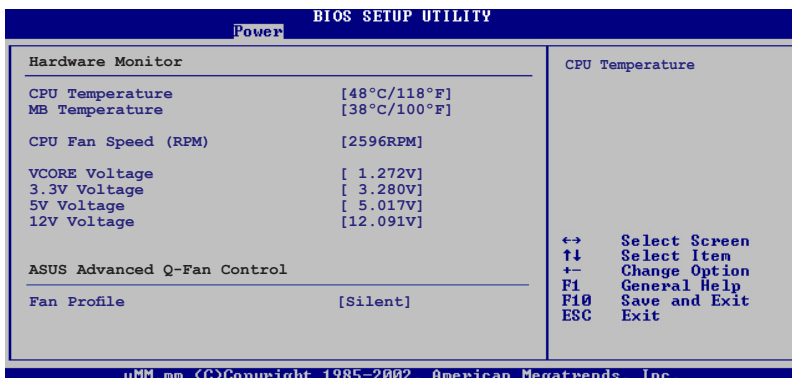

CPU Temperature [xxx°C/xxx°F]

MB Temperature [xxx°C/xxx°F]

The onboard hardware monitor automatically detects and displays the motherboard and CPU temperatures. Select **Ignored** if you do not wish to display the detected temperatures.

CPU Fan Speed (RPM) [Ignored] or [xxxxRPM]

The onboard hardware monitor automatically detects and displays the CPU fan speed in rotations per minute (RPM). Select **Ignored** if you do not wish to display the detected speed.

VCORE Voltage, 3.3V Voltage, 5V Voltage, 12V Voltage

The onboard hardware monitor automatically detects the voltage output through the onboard voltage regulators. Select **Ignored** if you do not wish to display these items.

Fan Profile [Enabled]

Allows you to select the ASUS Advanced Q-Fan control.
Configuration options: [Disabled] [Enabled]

5.6 Boot menu

The Boot menu items allow you to change the system boot options. Select an item then press <Enter> to display the sub-menu.

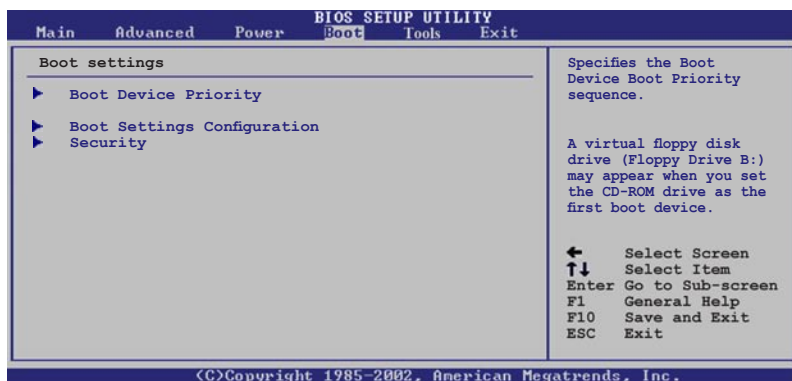

5.6.1 Boot Device Priority

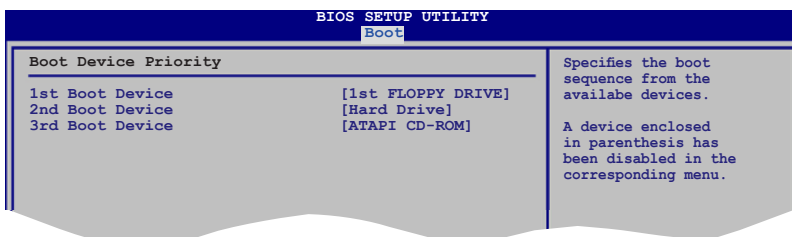

1st ~ xxth Boot Device [xxx Drive]

These items specify the boot device priority sequence from the available devices. The number of device items that appears on the screen depends on the number of devices installed in the system. Configuration options: [xxx Drive] [Disabled]

5.6.2 Boot Settings Configuration

BIOS SETUP UTILITY	
Boot	
Boot Settings Configuration	
Quick Boot	[Enabled]
Full Screen Logo	[Enabled]
AddOn ROM Display Mode	[Force BIOS]
Bootup Num-Lock	[On]
PS/2 Mouse Support	[Auto]
Wait For 'F1' If Error	[Enabled]
Hit 'DEL' Message Display	[Enabled]
Interrupt 19 Capture	[Disabled]

Allows BIOS to skip certain tests while booting. This will decrease the time needed to boot the system.

Quick Boot [Enabled]

Enabling this item allows the BIOS to skip some power on self tests (POST) while booting to decrease the time needed to boot the system. When set to [Disabled], BIOS performs all the POST items.

Configuration options: [Disabled] [Enabled]

Full Screen Logo [Enabled]

This allows you to enable or disable the full screen logo display feature.

Configuration options: [Disabled] [Enabled]



Set this item to [Enabled] to use the ASUS MyLogo2™ feature.

Add On ROM Display Mode [Force BIOS]

Sets the display mode for option ROM.

Configuration options: [Force BIOS] [Keep Current]

Bootup Num-Lock [On]

Allows you to select the power-on state for the NumLock.

Configuration options: [Off] [On]

PS/2 Mouse Support [Auto]

Allows you to enable or disable support for PS/2 mouse.

Configuration options: [Disabled] [Enabled] [Auto]

Wait for 'F1' If Error [Enabled]

When set to Enabled, the system waits for the F1 key to be pressed when error occurs. Configuration options: [Disabled] [Enabled]

Hit 'DEL' Message Display [Enabled]

When set to Enabled, the system displays the message "Press DEL to run Setup" during POST. Configuration options: [Disabled] [Enabled]

Interrupt 19 Capture [Disabled]

When set to [Enabled], this function allows the option ROMs to trap Interrupt 19.
Configuration options: [Disabled] [Enabled]

5.6.3 Security

The Security menu items allow you to change the system security settings. Select an item then press <Enter> to display the configuration options.

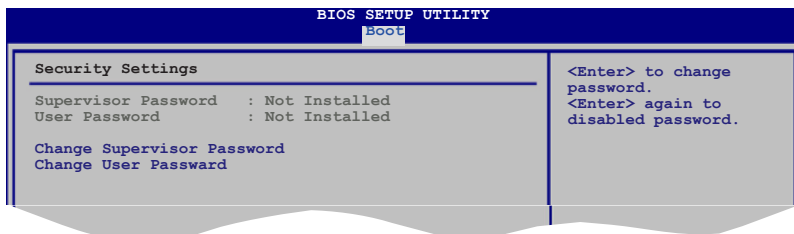

Change Supervisor Password

Select this item to set or change the supervisor password. The Supervisor Password item on top of the screen shows the default Not Installed. After you set a password, this item shows Installed.

To set a Supervisor Password:

1. Select the Change Supervisor Password item and press <Enter>.
2. From the password box, type a password composed of at least six letters and/or numbers, then press <Enter>.
3. Confirm the password when prompted.

The message "Password Installed" appears after you successfully set your password.

To change the supervisor password, follow the same steps as in setting a user password.

To clear the supervisor password, select the Change Supervisor Password then press <Enter>. The message "Password Uninstalled" appears.



If you forget your BIOS password, you can clear it by erasing the CMOS Real Time Clock (RTC) RAM. See section "4.2 Jumpers" for information on how to erase the RTC RAM.

After you have set a supervisor password, the other items appear to allow you to change other security settings.

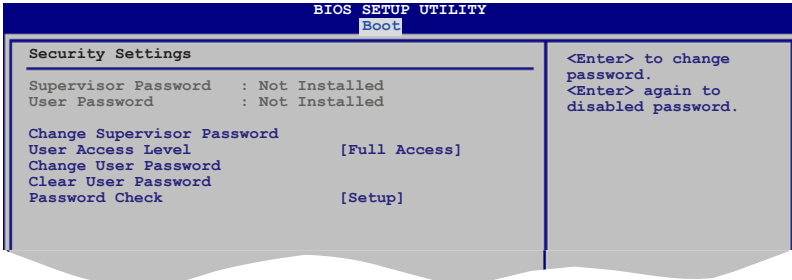

User Access Level [Full Access]

This item allows you to select the access restriction to the Setup items.
Configuration options: [No Access] [View Only] [Limited] [Full Access]

No Access prevents user access to the Setup utility.

View Only allows access but does not allow change to any field.

Limited allows changes only to selected fields, such as Date and Time.

Full Access allows viewing and changing all the fields in the Setup utility.

Change User Password

Select this item to set or change the user password. The User Password item on top of the screen shows the default Not Installed. After you set a password, this item shows Installed.

To set a User Password:

1. Select the Change User Password item and press <Enter>.
2. On the password box that appears, type a password composed of at least six letters and/or numbers, then press <Enter>.
3. Confirm the password when prompted.

The message "Password Installed" appears after you set your password successfully.

To change the user password, follow the same steps as in setting a user password.

Clear User Password

Select this item to clear the user password.

Password Check [Setup]

When set to [Setup], BIOS checks for user password when accessing the Setup utility. When set to [Always], BIOS checks for user password both when accessing Setup and booting the system.

Configuration options: [Setup] [Always]

5.7 Tools menu

The Tools menu items allow you to configure options for special functions. Select an item then press <Enter> to display the sub-menu.



5.7.1 ASUS EZ Flash 2

Allows you to run ASUS EZ Flash 2. When you press <Enter>, a confirmation message appears. Use the left/right arrow key to select between [Yes] or [No], then press <Enter> to confirm your choice. Please see section 5.1.2 for details.

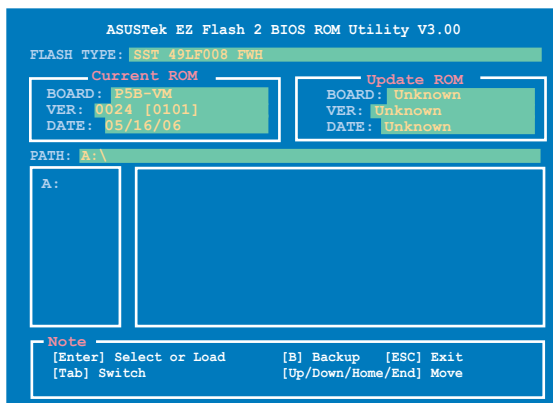

5.8 Exit menu

The Exit menu items allow you to load the optimal or failsafe default values for the BIOS items, and save or discard your changes to the BIOS items.

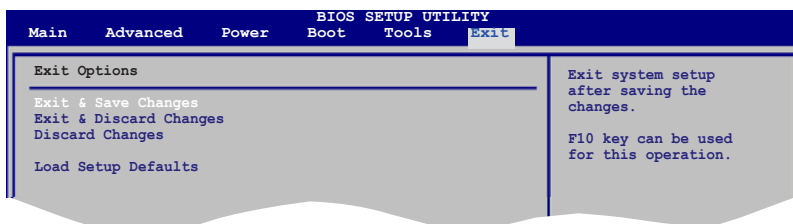

Pressing <Esc> does not immediately exit this menu. Select one of the options from this menu or <F10> from the legend bar to exit.

Exit & Save Changes

Once you are finished making your selections, choose this option from the Exit menu to ensure the values you selected are saved to the CMOS RAM. An onboard backup battery sustains the CMOS RAM so it stays on even when the PC is turned off. When you select this option, a confirmation window appears. Select **OK** to save changes and exit.



If you attempt to exit the Setup program without saving your changes, the program prompts you with a message asking if you want to save your changes before exiting. Press <Enter> to save the changes while exiting.

Exit & Discard Changes

Select this option only if you do not want to save the changes that you made to the Setup program. If you made changes to fields other than System Date, System Time, and Password, the BIOS asks for a confirmation before exiting.

Discard Changes

This option allows you to discard the selections you made and restore the previously saved values. After selecting this option, a confirmation appears. Select **OK** to discard any changes and load the previously saved values.

Load Setup Defaults

This option allows you to load the default values for each of the parameters on the Setup menus. When you select this option or if you press <F5>, a confirmation window appears. Select **OK** to load default values. Select **Exit & Save Changes** or make other changes before saving the values to the non-volatile RAM.

Appendix

The Appendix describes the CPU features and technologies that the system supports.



ASUS Pundit P3-PH5

CPU features

A.1 Intel® EM64T



- The motherboard is fully compatible with Intel® Pentium® 4 LGA775 processors running on 32-bit operating systems.
 - The motherboard comes with a BIOS file that supports EM64T. You can download the latest BIOS file from the ASUS website (www.asus.com/support/download/) if you need to update the BIOS file. See Chapter 5 for details.
 - Visit www.intel.com for more information on the EM64T feature.
 - Visit www.microsoft.com for more information on Windows® 64-bit OS.
-

Using the Intel® EM64T feature

To use the Intel® EM64T feature:

1. Install an Intel® Pentium® 4 CPU that supports the Intel® EM64T.
2. Install a 64-bit operating system (Windows® XP Professional x64 Edition or Windows® Server 2003 x64 Edition).
3. Install the 64-bit drivers for the motherboard components and devices from the support CD.
4. Install the 64-bit drivers for expansion cards or add-on devices, if any.



Refer to the expansion card or add-on device(s) documentation, or visit the related website, to verify if the card/device supports a 64-bit system.

A.2 Enhanced Intel SpeedStep® Technology (EIST)



- The motherboard comes with a BIOS file that supports EIST. You can download the latest BIOS file from the ASUS website (www.asus.com/support/download/) if you need to update the BIOS. See Chapter 5 for details.
 - Visit www.intel.com for more information on the EIST feature.
-

A.2.1 System requirements

Before using EIST, check your system if it meets the following requirements:

- Intel® Pentium® 4 processor with EIST support
- BIOS file with EIST support
- Operating system with EIST support (Windows® XP SP2/Windows® Server 2003 SP1/Linux 2.6 kernel or later versions)

A.2.2 Using the EIST

To use the EIST feature:

1. Turn on the computer, then enter the BIOS Setup.
2. Go to the **Advanced Menu**, highlight **CPU Configuration**, then press <Enter>.
3. Set the **Intel(R) SpeedStep Technology** item to [Automatic], then press <Enter>. See page 5-22 for details.
4. Press <F10> to save your changes and exit the BIOS setup.
5. After the computer restarts, right click on a blank space on the desktop, then select **Properties** from the pop-up menu.
6. When the **Display Properties** window appears, click the **Screen Saver** tab.
7. Click the **Power** button on the Monitor power section to open the **Power Options Properties** window.

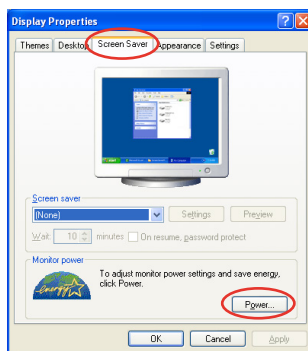

8. On the **Power schemes** section, click , then select any option except **Home/Office Desktop** or **Always On**.
9. Click **Apply**, then click **OK**.
10. Close the **Display Properties** window. After you adjust the power scheme, the CPU internal frequency slightly decreases when the CPU loading is low.

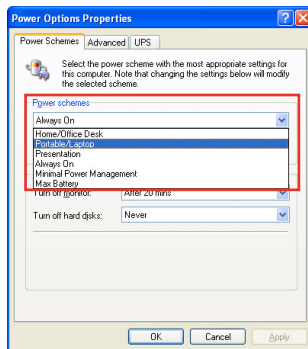

The screen displays and procedures may vary depending on the operating system.

A.3 Intel® Hyper-Threading Technology



- The motherboard supports Intel® Pentium® 4 LGA775 processors with Hyper-Threading Technology.
 - Hyper-Threading Technology is supported under Windows® XP/2003 Server and Linux 2.4.x (kernel) and later versions only. Under Linux, use the Hyper-Threading compiler to compile the code. If you are using any other operating systems, disable the Hyper-Threading Technology item in the BIOS to ensure system stability and performance.
 - Installing Windows® XP Service Pack 1 or later version is recommended.
 - Make sure to enable the Hyper-Threading Technology item in BIOS before installing a supported operating system.
 - For more information on Hyper-Threading Technology, visit www.intel.com/info/hyperthreading.
-

Using the Hyper-Threading Technology

To use the Hyper-Threading Technology:

1. Install an Intel® Pentium® 4 CPU that supports Hyper-Threading Technology.
2. Power up the system and enter the BIOS Setup. Under the **Advanced Menu**, make sure that the item **Hyper-Threading Technology** is set to **Enabled**. See page 5-22 for details.
The BIOS item appears only if you installed a CPU that supports Hyper-Threading Technology.
3. Restart the computer.

Free Manuals Download Website

<http://myh66.com>

<http://usermanuals.us>

<http://www.somanuals.com>

<http://www.4manuals.cc>

<http://www.manual-lib.com>

<http://www.404manual.com>

<http://www.luxmanual.com>

<http://aubethermostatmanual.com>

Golf course search by state

<http://golfingnear.com>

Email search by domain

<http://emailbydomain.com>

Auto manuals search

<http://auto.somanuals.com>

TV manuals search

<http://tv.somanuals.com>