

---

# User and Service Guide

---

## Agilent 83446A/B Lightwave Clock/Data Receiver

Agilent part number: 83446-90018  
Edition 1 Printed in USA March 2000

1400 Fountaingrove Parkway,  
Santa Rosa, CA  
95403-1799, USA

**Notice.** The information contained in this document is subject to change without notice. Agilent Technologies makes no warranty of any kind with regard to this material, including but not limited to, the implied warranties of merchantability and fitness for a particular purpose. Agilent Technologies shall not be liable for errors contained herein or for incidental or consequential damages in connection with the furnishing, performance, or use of this material.

**Restricted Rights Legend.** Use, duplication, or disclosure by the U.S. Government is subject to restrictions as set forth in subparagraph (c) (1) (ii) of the Rights in Technical Data and Computer Software clause at DFARS 252.227-7013 for DOD agencies, and subparagraphs (c) (1) and (c) (2) of the Commercial Computer Software Restricted Rights clause at FAR 52.227-19 for other agencies.

©Copyright Agilent Technologies 2000  
All Rights Reserved. Reproduction, adaptation, or translation without prior written permission is prohibited, except as allowed under the copyright laws.

---

## Printing History

<b>Agilent Part Number</b>	<b>Edition</b>	<b>Date</b>
83446-90004	Edition 1	October 1994
83446-90011	Edition 1	June 1995
83446-90018	Edition 1	March 2000

---

## Safety Symbols

The following safety symbols are used throughout this manual. Familiarize yourself with each of the symbols and its meaning before operating this instrument.

---

### CAUTION

---

The *caution* sign denotes a hazard to the instrument. It calls attention to a procedure which, if not correctly performed or adhered to, could result in damage to or destruction of the instrument. Do not proceed beyond a *caution* sign until the indicated conditions are fully understood and met.

---

### WARNING

---

The *warning* sign denotes a life-threatening hazard. It calls attention to a procedure which, if not correctly performed or adhered to, could result in injury or loss of life. Do not proceed beyond a *warning* sign until the indicated conditions are fully understood and met.



The **instruction manual** symbol. The product is marked with this symbol when it is necessary for the user to refer to the instructions in the manual.

---



This symbol denotes that the instrument uses alternating current.

---



This symbol denotes that the power supply is turned on.

---



This symbol denotes that the power supply is turned off.

---

CE

The CE mark is a registered trademark of the European Community.

---

ISM1-A

This symbol denotes that the instrument is an Industrial Scientific and Medical Group 1 Class A product.

---

The CSA mark is a registered trademark of the Canadian Standards Association.



---

## General Safety Considerations

---

**WARNING**

---

This is a Safety Class I product (provided with a protective earthing ground incorporated in the power cord). The mains plug shall only be inserted in a socket outlet provided with a protective earth contact. Any interruption of the protective conductor inside or outside of the instrument is likely to make the instrument dangerous. Intentional interruption is prohibited.

---

**WARNING**

---

*Before this instrument is switched on*, make sure it has been properly grounded through the protective conductor of the ac power cable to a socket outlet provided with protective earth contact. Any interruption of the protective (grounding) conductor, inside or outside the instrument, or disconnection of the protective earth terminal can result in personal injury.

---

**WARNING**

---

If this instrument is not used as specified, the protection provided by the equipment could be impaired. This instrument must be used in a normal condition (in which all means for protection are intact) only.

---

**WARNING**

---

There are many points in the instrument which can, if contacted, cause personal injury. Be extremely careful. Any adjustments or service procedures that require operation of the instrument with protective covers removed should be performed only by trained service personnel.

---

**WARNING**

---

No operator serviceable parts inside. Refer servicing to qualified personnel. To prevent electrical shock, do not remove covers.

---

**WARNING**

---

For continued protection against fire hazard, replace line fuse only with same type and ratings. The use of other fuses or materials is prohibited.

---

**CAUTION**

---

Always use the three-prong AC power cord supplied with this instrument. Failure to ensure adequate earth grounding by not using this cord may cause instrument damage.

---

**CAUTION**

---

This product has autoranging line voltage input. Be sure the supply voltage is within the specified range.

---

## Certification and Assistance

Agilent Technologies certifies that this product met its published specifications at the time of shipment from the factory. Agilent Technologies further certifies that its calibration measurements are traceable to the United States National Institute of Standards and Technology (NIST), to the extent allowed by the Institute's calibration facility, and to the calibration facilities of other International Standards Organization members.

*Product maintenance agreements and other customer assistance agreements are available for Agilent Technologies products.*

*For any assistance, contact your nearest Agilent Technologies Sales and Service Office.*

# Declaration of Conformity

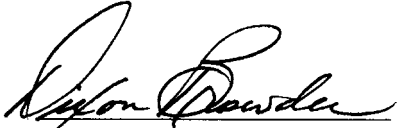
DECLARATION OF CONFORMITY according to ISO/IEC Guide 22 and EN 45014	
<b>Manufacturer's Name:</b>	Hewlett-Packard Co.
<b>Manufacturer's Address:</b>	1400 Fountaingrove Parkway Santa Rosa, California 95403 U.S.A.
<b>Declares that the product:</b>	
Product Name:	Lightwave Clock Data Receiver
Model Numbers:	HP 83446A/B
Product Options:	This declaration covers all options of the above products.
<b>Conforms to the following product specifications:</b>	
Safety:	IEC 1010-1:1990 + A1/EN 61010-1:1993 CAN/CSA-C22.2 No. 1010.1-92
EMC:	CISPR 11:1990 /EN 55011:1991, Group 1 Class A IEC 801-2:1991 /EN 50082-1:1992, 4 kV CD, 8 kV AD IEC 801-3:1984 /EN 50082-1:1992, 3V/m, 27-500 MHz IEC 801-4:1988 /EN 50082-1:1992, 500 V signal, 1000 V AC
<b>Supplementary Information:</b>	
The products herewith comply with the requirements of the Low Voltage Directive 73/23/EEC and the EMC Directive 89/336/EEC.	
Santa Rosa, California	<u>4/19/95</u> 
<b>Location</b>	<b>Date</b> <b>Dixon Browder / Quality Manager</b>
<b>European Contact:</b> Your local Hewlett-Packard Sales and Service Office or Hewlett-Packard GmbH, Department ZQ/Standards Europe, Herrenberger Straße 130, D-71034 Boeblingen (FAX: + 49-7031-14-3143)	

---

# Warranty

This Agilent Technologies instrument product is warranted against defects in material and workmanship for a period of one year from date of shipment. During the warranty period, Agilent Technologies will, at its option, either repair or replace products which prove to be defective.

For warranty service or repair, this product must be returned to a service facility designated by Agilent Technologies. Buyer shall prepay shipping charges to Agilent Technologies and Agilent Technologies shall pay shipping charges to return the product to Buyer. However, Buyer shall pay all shipping charges, duties, and taxes for products returned to Agilent Technologies from another country.

Agilent Technologies warrants that its software and firmware designated by Agilent Technologies for use with an instrument will execute its programming instructions when properly installed on that instrument. Agilent Technologies does not warrant that the operation of the instrument, or software, or firmware will be uninterrupted or error-free.

## LIMITATION OF WARRANTY

The foregoing warranty shall not apply to defects resulting from improper or inadequate maintenance by Buyer, Buyer-supplied software or interfacing, unauthorized modification or misuse, operation outside of the environmental specifications for the product, or improper site preparation or maintenance.

NO OTHER WARRANTY IS EXPRESSED OR IMPLIED. AGILENT TECHNOLOGIES SPECIFICALLY DISCLAIMS THE IMPLIED WARRANTIES OF MERCHANTABILITY AND FITNESS FOR A PARTICULAR PURPOSE.

## EXCLUSIVE REMEDIES

THE REMEDIES PROVIDED HEREIN ARE BUYER'S SOLE AND EXCLUSIVE REMEDIES. AGILENT TECHNOLOGIES SHALL NOT BE LIABLE FOR ANY DIRECT, INDIRECT, SPECIAL, INCIDENTAL, OR CONSEQUENTIAL DAMAGES, WHETHER BASED ON CONTRACT, TORT, OR ANY OTHER LEGAL THEORY.



---

# Contents

<b>1. General Information</b>	
Description of the Agilent 83446A/B . . . . .	1-3
Front-panel features . . . . .	1-6
Rear panel features . . . . .	1-8
Agilent 83446A/B Specifications and Characteristics . . . . .	1-9
Electrostatic Discharge Information . . . . .	1-12
Reducing ESD damage . . . . .	1-14
<b>2. Installation and Preparation for Use</b>	
Installing the Agilent 83446A/B . . . . .	2-3
Step 1. Inspect the shipment . . . . .	2-3
Step 2. Set the line voltage selector . . . . .	2-5
Step 3. Check the fuse . . . . .	2-6
Step 4. Connect the Agilent 83446A/B to a power source . . . . .	2-7
Step 5. Turn on the Agilent 83446A/B . . . . .	2-10
Connecting the Agilent 83446A/B to a Bit-Error-Ratio Test Set . . . . .	2-11
Performing a Quick Confidence Check . . . . .	2-13
If the verification check fails . . . . .	2-13
How to Return the Agilent 83446A/B for Service . . . . .	2-15
Packaging . . . . .	2-15
Instrument shipping preparation procedure . . . . .	2-16
Sales and service offices . . . . .	2-17
Cleaning Connections for Accurate Measurements . . . . .	2-19
To clean a non-lensed connector . . . . .	2-21
To clean an adapter . . . . .	2-22
To test insertion loss . . . . .	2-23
To test return loss . . . . .	2-23
<b>3. Using the Agilent 83446A/B</b>	
Bit-Error-Ratio Test . . . . .	3-3
Example of measuring dispersion power penalty of single-mode fiber . . . . .	3-3
System sensitivity calibration . . . . .	3-4
Determining dispersion power penalty . . . . .	3-7
Bit-Error-Ratio Test . . . . .	3-10

**Replaceable parts**

Example of optimizing laser extinction ratio . . . . . 3-11  
Waveform Test . . . . . 3-13  
Example of measuring eye diagram using recovered clock  
signal . . . . . 3-13

**4. Servicing the Agilent 83446A/B**

General information . . . . . 4-3  
Troubleshooting . . . . . 4-5  
Adjustment Procedures . . . . . 4-8  
    Power supply adjustment procedure . . . . . 4-8  
    Photodetector/clock/data recovery assembly adjustment  
    procedure . . . . . 4-10  
Performance Tests . . . . . 4-11  
    Test 1. Sensitivity . . . . . 4-15  
    Test 2. Maximum operating input power . . . . . 4-20  
    Test 3. Electrical output signal amplitudes . . . . . 4-21  
    Test 4. Rear-panel input port verification (functional  
    check only) . . . . . 4-23  
    Test 5. Input optical return loss . . . . . 4-24  
Replacement Procedures . . . . . 4-26  
    Replacing the RF cable or the RF connector . . . . . 4-27  
    Replacing the ac cable assembly . . . . . 4-28  
    Replacing the power supply . . . . . 4-30  
    Replacing the PCDR assembly . . . . . 4-31  
Replaceable parts . . . . . 4-32

**Index**

---

## Figures

1-1. Agilent 83446A/B block diagram. . . . .	1-4
1-2. The Agilent 83446A/B front-panel. . . . .	1-6
1-3. The Agilent 83446A/B rear panel. . . . .	1-8
1-4. Example of a static-safe work station. . . . .	1-13
2-1. Opening the fuse holder door. . . . .	2-5
2-2. Selecting the line voltage value and checking the fuse. . . . .	2-6
2-3. AC power cables available. . . . .	2-9
2-4. Connecting the Agilent 83446A/B to a bit error ratio test system. . . . .	2-11
3-1. Setup for calibration of dispersion power penalty test system. . . . .	3-4
3-2. Setup to measure dispersion power penalty of single-mode fiber. . . . .	3-7
3-3. Setup for optimizing laser extinction ratio. . . . .	3-12
3-4. Setup for measuring eye diagram by triggering from recovered clock. . . . .	3-14
4-1. Agilent 83446A/B block diagram. . . . .	4-5
4-2. Laser transmitter setup. . . . .	4-12
4-3. Agilent 83446A/B test equipment setup. . . . .	4-16
4-4. Wiring diagram for the line module. . . . .	4-28
4-5. Wiring Diagram for the power supply terminals. . . . .	4-30
4-6. Agilent 83446A/B assembly level replaceable parts. . . . .	4-34
4-7. Agilent 83446A/B replaceable hardware. . . . .	4-36

---

## Tables

1-1. Agilent 83446A/B Specifications and Characteristics . . . . .	1-10
1-2. Static-Safe Accessories . . . . .	1-14
2-1. Agilent 83446A/B Power Requirements . . . . .	2-7
2-2. Agilent Technologies Service Numbers . . . . .	2-18
3-1. Average Gating Period to Achieve 100 Errors . . . . .	3-5
4-1. Required Tools . . . . .	4-4
4-2. Voltages on the DC Power Supply Terminals . . . . .	4-7
4-3. Required Test Equipment . . . . .	4-11
4-4. Laser Transmitter Setup . . . . .	4-13
4-5. Sensitivity Test Setup . . . . .	4-17
4-6. Input Optical Return Loss . . . . .	4-24
4-7. Torque Values . . . . .	4-27
4-8. Line Module to DC Power Supply Connections . . . . .	4-29
4-9. DC Power Supply Terminal Connections . . . . .	4-30
4-10. Assembly-Level Replaceable Parts . . . . .	4-35
4-11. Replaceable Hardware . . . . .	4-37

---

## General Information

---

## General Information

**What you'll find in this chapter**

- A brief description of the Agilent 83446A/B lightwave clock/data receiver.
- A list of options and accessories available.
- Agilent 83446A/B specifications and characteristics.
- Information about the lightwave receiver's serial number label.
- Information about avoiding damage to the instrument from electrostatic discharge.

---

## Description of the Agilent 83446A/B

The Agilent 83446A/B lightwave clock/data receivers are designed to extract clock and data information from digitally modulated lightwave signals. They operate at the following SONET/SDH rates:

Agilent 83446A .....	2.48832 Gb/s
Agilent 83446B .....	622.08 Mb/s

Both receivers have been designed per the recommendations of ITU-T G.957, G.958, and Bellcore GR-253-CORE for the 1310/1550 nanometer wavelength ranges. Outputs are optimized for use with bit-error-ratio testers, such as the Agilent 71604B.

### Select optical or electrical input

An input on the rear panel is provided for recovering clock and data from an electrical signal at the specified data rate. A slide switch on the rear panel selects between the front panel optical input and the rear panel electrical input. For best sensitivity, signals should not be applied to both the front and rear panel inputs simultaneously.

### Monitor the quality of the analog eye

The auxiliary output on the front panel can be used to monitor the quality of the analog eye. When monitoring an optical signal this output is gain-limited by the AGC amplifier and its level is constant for input signals above approximately  $-23$  dBm. When monitoring an electrical signal this output is not gain-limited so its level is directly proportional to the incoming signal level.

#### NOTE

This auxiliary output on the front panel is intended for monitoring purposes only and should not be used for rigorous eye mask compliance testing. The frequency response of the auxiliary output does not conform to the requirements for eye mask testing as described in ITU-T G.957 and Bellcore GR-253-CORE. For mask testing use an appropriate reference receiver, such as the Agilent 83440-series reference receivers.

**Description of the Agilent 83446A/B**

For more information on using the lightwave clock/data receiver refer to Chapter 3.

**Learning the inside story . . .**

The block diagram for the Agilent 83446A/B is shown in Figure 1-1. The optical-to-electrical conversion is performed by a sensitive APD photodetector which covers the 1310 and 1550 nm wavelength ranges. The optical input uses 50 μm multimode fiber for compatibility with either single-mode or multimode fiber inputs. (A slight loss in sensitivity results when used with 62.5 μm fiber.) The photodetector output is amplified in an automatic-gain-control (AGC) amplifier and, after going through the MMIC switch, is split into two paths. One path provides an auxiliary output on the receiver's front panel. The other path goes to the clock and data recovery hybrid. The clock signal is recovered using a phase and frequency-locked loop circuit. The data is threshold-detected and re-timed to the recovered clock signal. Clock and data outputs are noninverting with respect to the incoming signal. The phase relationship between the two outputs at the front panel interface is maintained to approximately ±0.25 unit intervals.

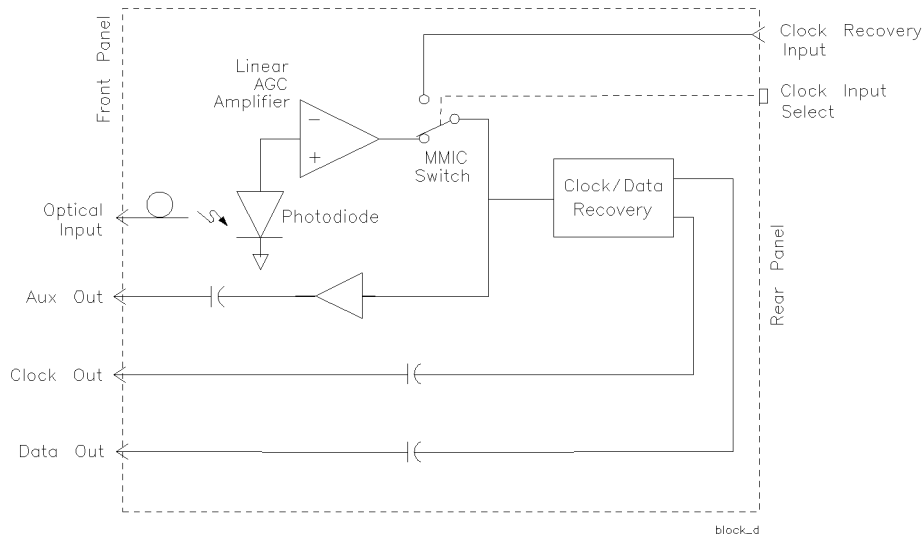

**Figure 1-1. Agilent 83446A/B block diagram.**



- Accessories supplied** The Agilent 83446A/B lightwave clock/data receiver is shipped with:
- Power cable (refer to Figure 2-3)
  - FC/PC front-panel connector interfaces
- Agilent 83446A/B Lightwave Clock/Data Receiver User and Service Guide.*
- Options** The following option is available:
- Option 010 Deletes FC/PC front-panel connector interface
- The *Fiber Optics Handbook*, Agilent part number 5952-9654, is an introduction and reference for fiber-optic measurements.
- Serial Numbers** Agilent Technologies makes frequent improvements to its products to enhance their performance, usability, or reliability, and to control costs. Agilent Technologies service personnel have access to complete records of design changes to each type of equipment, based on the equipment's serial number. Whenever you contact Agilent Technologies about your lightwave receiver, have the complete serial number available to ensure obtaining the most complete and accurate information possible.
- A serial-number label is attached to the rear of the lightwave receiver. It contains the serial number and the options installed in the lightwave receiver. Whenever you specify the serial number or refer to it in obtaining information about your lightwave receiver, be sure to use the complete number.

---

## Front-panel features

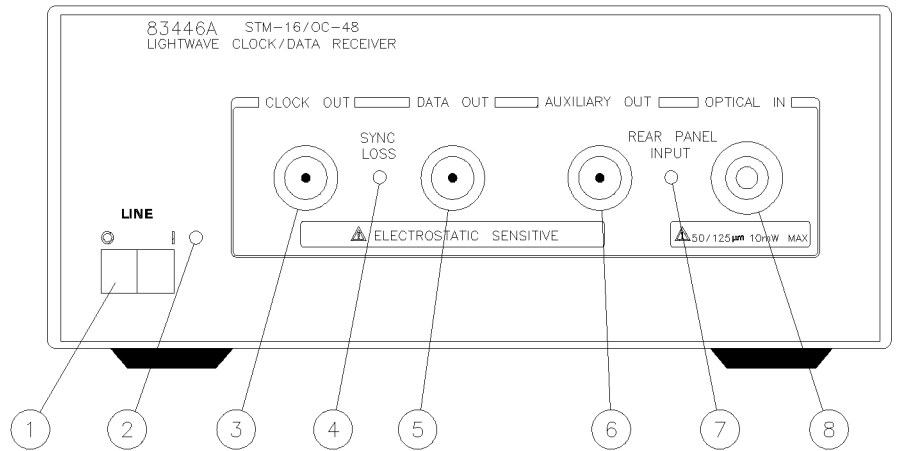

83446fp

**Figure 1-2. The Agilent 83446A/B front-panel.**

1. Line switch.
2. Powerline LED.
3. **CLOCK OUT** connector. Output is nominally 2.48832 GHz (622.08 MHz for Agilent 83446B). When the **SYNC LOSS** indicator is extinguished this output is synchronized with the bit rate of the input signal. When not synchronized to an input signal the output free-runs near the nominal clock frequency.
4. **SYNC LOSS** indicator. This LED is off whenever the clock output is synchronized to the bit rate of the input signal. Note that **CLOCK OUT** can remain synchronized to input signals several dB below the onset of errors at **DATA OUT**.
5. **DATA OUT** connector. This output provides an amplified, retimed signal corresponding to the incoming data stream. Data transitions are aligned to clock transitions to  $\pm 0.25$  unit intervals.
6. **AUXILIARY OUT** connector. This output provides a non-retimed analog version of the input signal. When used with an optical input this port is amplitude stabilized for input signals greater than approximately  $-23$  dBm. When used with an electrical input this output is not amplitude stabilized so its output amplitude is directly proportional to the amplitude of the incoming signal.
7. **REAR PANEL INPUT** indicator. This LED is on when the input selector switch on the rear panel is set to the **REAR** position.
8. **OPTICAL IN** connector. Maximum signal input is  $-9$  dBm, damage level input is  $+10$  dBm. This input accepts any of the connector interface adapters from the Agilent 81000-series.

---

## Rear panel features

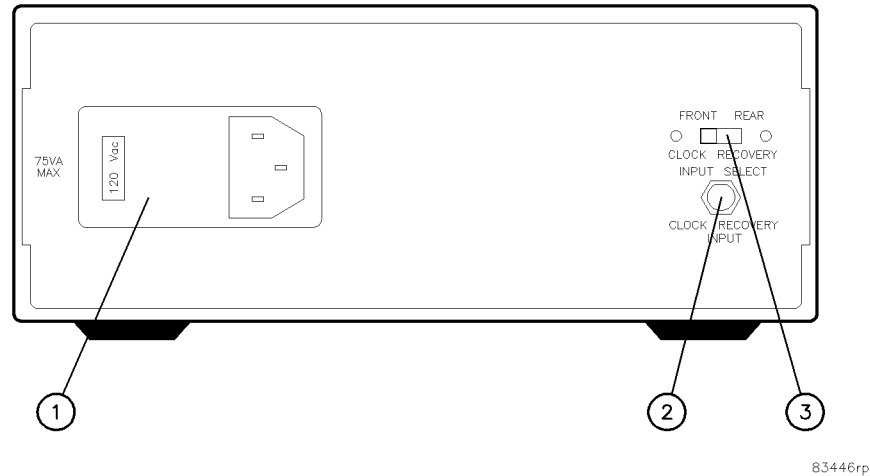

**Figure 1-3. The Agilent 83446A/B rear panel.**

1. Power line module.
2. **CLOCK RECOVERY INPUT** connector. Use to recover clock and data from an electrical signal.
3. **CLOCK RECOVERY INPUT SELECT** switch. Use to select between front optical input and rear electrical input.

---

# Agilent 83446A/B Specifications and Characteristics

Table 1-1 lists specification, *characteristics*, typical performance, and nominal values. The distinction between these terms is described as follows:

- Specifications describe warranted performance over the temperature range 0°C to +55°C (unless otherwise noted). All specifications apply after the instrument's temperature has been stabilized after 30 minutes of continuous operation.
- *Characteristics* provide useful information by giving functional, but nonwarranted, performance parameters. *Characteristics are printed in italics.*
- Typical Performance, where listed, is not *warranted*, but indicates performance which most units will meet.
- Nominal Value indicates the expected, but not *warranted*, value of the parameter.

**Agilent 83446A/B Specifications and Characteristics****Table 1-1. Agilent 83446A/B Specifications and Characteristics**

<b>Specifications<sup>1</sup></b>	<b>Agilent 83446A</b>	<b>Agilent 83446B</b>
Data rate	2.48832 Gb/s   $\pm 0.5\%$	622.08 Mb/s   $\pm 0.5\%$
Sensitivity <sup>2,3,4</sup>	$\leq -27$ dBm	$\leq -28$ dBm
Data amplitude <sup>5</sup>	0.5 Vp-p	0.5 Vp-p
Clock amplitude	0.4 Vp-p	0.4 Vp-p
Maximum operating input power <sup>2</sup>	-9 dBm	-9 dBm
Input optical return loss <sup>6</sup>	$\leq -27$ dB	$\leq -27$ dB
<b>Characteristics</b>		
<i>Wavelength range</i>	<i>1200–1600 nm</i>	<i>1200–1600 nm</i>
<i>Maximum safe, continuous optical input power</i>	<i>10 mW peak</i>	<i>10 mW peak</i>
<i>Output electrical return loss (all electrical outputs)</i>		
<i>at 1.0 GHz</i>	<i>-12 dB</i>	<i>-12 dB</i>
<i>at 2.0 GHz</i>	<i>-9 dB</i>	<i>-9 dB</i>
<i>at 2.5 GHz</i>	<i>-6 dB</i>	<i>-6 dB</i>
<i>RMS jitter on clock/data outputs<sup>7</sup></i>	<i>5 degrees</i>	<i>5 degrees</i>
<i>3 dB bandwidth at auxiliary output</i>	<i>0.0001–1.5 GHz</i>	<i>0.0001–1.0 GHz</i>
<i>Maximum safe electrical clock recovery input</i>	<i>2 Vp-p</i>	<i>2 Vp-p</i>
<i>Allowable mark density range</i>	<i>40–60%</i>	<i>40–60%</i>
<i>Electrical clock recovery input sensitivity</i>	<i>200 mVp-p</i>	<i>200 mVp-p</i>
<i>Auxiliary output (optical input)</i>		
<i>&gt; -23 dBm input</i>	<i>0.5 Vp-p</i>	<i>0.5 Vp-p</i>
<i>&gt; -27 dBm input</i>	<i>0.25 Vp-p</i>	<i>0.25 Vp-p</i>
<i>Auxiliary output (electrical input)</i>	<i>&lt; 6 dB down from input signal level</i>	<i>&lt; 6 dB down from input signal level</i>

1 Tested at 1310 nm and 1550 nm using SONE/SDH-Compliant DFB laser directly modulated at the specified data rate, NRZ coding format. Extinction ratio  $\geq 8.2$  dB.

2 Better than  $10^{-10}$  bit error ratio using  $2^{23}-1$  PRBS pattern with 50% mark density.

3 Sensitivity may be degraded if signals are applied simultaneously to both the front optical input and rear electrical input.

4 Sensitivity specification applies at temperatures  $\leq 30^\circ\text{C}$ .

5 Noninverting outputs.

6 Tested with physical contact connector, single mode fiber input.

7 Clock edge aligned to data transitions to  $\pm 0.25$  unit interval.

**Agilent 83446A/B Specifications and Characteristics****Table 1-1. Agilent 83446A/B Specifications and Characteristics, continued**

<b>GENERAL SPECIFICATIONS</b>	
<b>Temperature Range</b>	
Operating	0°C to +55°C
Storage	–40°C to +75°C
<b>Humidity</b>	Maximum relative humidity 80% for temperatures up to 31°C., decreasing linearly to 50% relative humidity at 40°C.
<b>Altitude</b>	Altitude up to 15,000 feet (4,572 meters).
<b>EMI Compatibility</b>	Conducted and radiated emissions meet the requirements of CISPR Publication 11 and EN 55011 Group 1, Class A.
<b>Power Requirements</b>	100/120/220/240 V (±10%), 47 to 63 Hz
Power Consumption	Power consumption 75 VA max
<b>Installation Category</b>	Category II per I.E.C. 1010
<b>Pollution Degree</b>	Degree 2 per I.E.C. 664
<b>Usage</b>	For indoor use.
<b>Weight</b> ( <i>characteristic</i> )	3.36 kg (7.5 lb)
<b>Dimensions</b> (H × W × D)	10 × 21.3 × 36 cm 3.9 × 8.4 × 14.2 in
<b>FRONT-PANEL INPUT / OUTPUT</b>	
<b>Optical Input Connector</b>	50/125 $\mu$ m multimode fiber connector compatible with adapters in Agilent 81000-series.
<b>Output Connectors</b>	Type-N female, 50 $\Omega$ (nominal)

---

## Electrostatic Discharge Information

Electrostatic discharge (ESD) can damage or destroy electronic components. All work on electronic assemblies should be performed at a static-safe work station. Figure 1-4 shows an example of a static-safe work station using two types of ESD protection:

- Conductive table-mat and wrist-strap combination.
- Conductive floor-mat and heel-strap combination.

Both types, when used together, provide a significant level of ESD protection. Of the two, only the table-mat and wrist-strap combination provides adequate ESD protection when used alone.

To ensure user safety, the static-safe accessories must provide at least 1 M $\Omega$  of isolation from ground. Refer to Table 1-2 for information on ordering static-safe accessories.

---

### **WARNING**

---

These techniques for a static-safe work station should not be used when working on circuitry with a voltage potential greater than 500 volts.



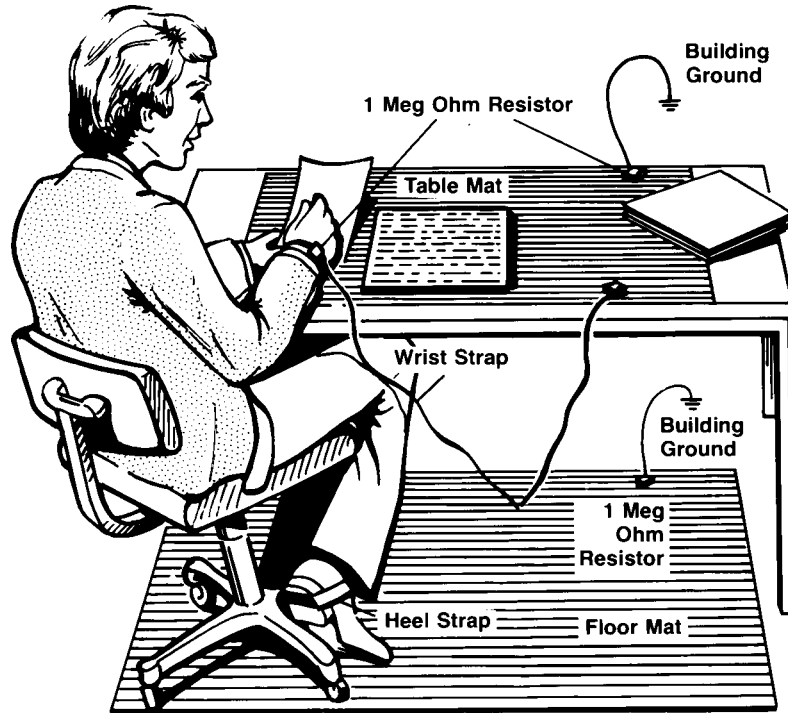

Figure 1-4. Example of a static-safe work station.

---

## Reducing ESD damage

The following suggestions may help reduce ESD damage that occurs during testing and servicing operations.

- Before connecting any coaxial cable to an instrument connector for the first time each day, momentarily ground the center and outer conductors of the cable.
- Personnel should be grounded with a resistor-isolated wrist-strap before touching the center pin of any connector and before removing any assembly from the unit.
- Be sure that all instruments are properly earth-grounded to prevent a buildup of static charge.

Table 1-2 lists static-safe accessories that can be obtained from Agilent Technologies using the Agilent part numbers shown.

**Table 1-2. Static-Safe Accessories**

<b>Agilent Part Number</b>	<b>Description</b>
9300-0797	Set includes: 3M static control mat 0.6 m × 1.2 m (2 ft × 4 ft) and 4.6 cm (15 ft) ground wire. (The wrist-strap and wrist-strap cord are not included. They must be ordered separately.)
9300-0980	Wrist-strap cord 1.5 m (5 ft).
9300-1383	Wrist-strap, color black, stainless steel, without cord, has four adjustable links and a 7 mm post-type connection.
9300-1169	ESD heel-strap (reusable 6 to 12 months).

---

## Installation and Preparation for Use

---

## Installation and Preparation for Use

### What you'll find in this chapter

- Installing the Agilent 83446A/B.
- Connecting the Agilent 83446A/B lightwave clock/data receiver to a bit-error-ratio tester.
- How to perform a quick confidence check of the Agilent 83446A/B.
- How to return the Agilent 83446A/B for service.
- Cleaning connections for accurate measurements.

This instrument has been designed and tested in accordance with IEC Publication 61010, *Safety Requirements for Electronic Measuring Apparatus*, and has been supplied in a safe condition. The instruction documentation contains information and warnings which must be followed by the user to ensure safe operation and to maintain the instrument in a safe condition.

### NOTE

Clean the cabinet using a damp cloth only.

---

## Installing the Agilent 83446A/B

---

**CAUTION**

VENTILATION REQUIREMENTS: When installing the instrument in a cabinet, the convection into and out of the instrument must not be restricted. The ambient temperature (outside the cabinet) must be less than the maximum operating temperature of the instrument by 4°C for every 100 watts dissipated in the cabinet. If the total power dissipated in the cabinet is greater than 800 watts, then forced convection must be used.

---

**CAUTION**

This product is designed for use in Installation Category II and Pollution Degree 2 per IEC 1010 and 664 respectively.

---

### Step 1. Inspect the shipment

Inspect the lightwave clock/data receiver shipping container for damage. If the shipping container or cushioning material is damaged, keep it until you have verified that the contents are complete and you have tested the lightwave receiver mechanically and electrically.

The lightwave clock/data receiver is packed within a carton. Refer to “How to Return the Agilent 83446A/B for Service”, for the description and part numbers of the packaging materials. Refer to “Accessories” in “Description of the Agilent 83446A/B” in Chapter 1, for the accessories shipped with the lightwave receiver.

If the contents are incomplete or if the lightwave receiver does not pass the verification test (this procedure is provided in “Performing a Quick Confidence Check”), notify the nearest Agilent Technologies office. If the shipping container is damaged or the cushioning material shows signs of stress, also notify the carrier. Keep the shipping materials for the carrier’s inspection. The Agilent Technologies office will arrange for repair or replacement without waiting for a claim settlement.

If the shipping materials are in good condition, retain them for possible future use. You may wish to ship the lightwave receiver to another location

Installation and Preparation for Use  
**Installing the Agilent 83446A/B**

or return it to Agilent Technologies for service. Refer to “How to Return the Agilent 83446A/B for Service”.

---

## Step 2. Set the line voltage selector

Use the following procedure to set the lightwave clock/data receiver's voltage selector to the voltage range (100, 120, 220, or 240V) corresponding to the available ac voltage.

---

### **CAUTION**

Before connecting the lightwave receiver to the power source, you must set the rear-panel voltage selector correctly to adapt the lightwave receiver to the power source. An improper selector setting can damage the lightwave receiver when it is turned on.

1. Pry open the fuse holder door with a small screwdriver.

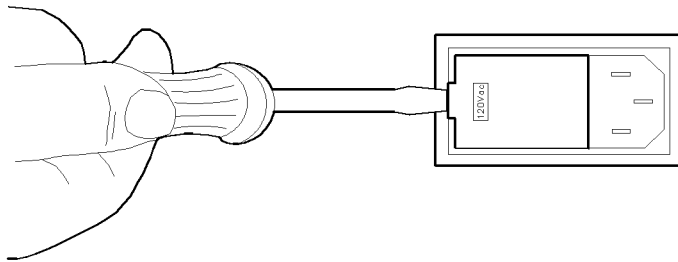

**Figure 2-1. Opening the fuse holder door.**

---

### **CAUTION**

You must remove the voltage tumbler to change the voltage selector. Rotating the voltage tumbler while it is in the line module damages the line module.

2. Remove the voltage tumbler (the voltage tumbler is not attached to the unit).
3. Replace the voltage tumbler so the desired line voltage value shows through the small opening in the fuse holder door.

---

### Step 3. Check the fuse

The recommended fuse is listed below:

- For a 100/120V operation: T 0.315A, 250V, time delay, Agilent part number 2110-0449.
- For a 220/240V operation: T 0.16A, 250V, time delay, Agilent part number 2110-0448.

---

#### **WARNING**

For continued protection against fire hazard, replace line fuse only with same type and ratings. The use of other fuses or materials is prohibited.

The line fuse is housed in a small container next to the voltage tumbler (refer to Figure 2-2). The spare fuse is stored below the line fuse.

To check the fuse, insert the tip of a screwdriver on the side of the container and gently pull outward to remove the container.

If the fuse is defective or missing, install a new fuse in the proper position and reinsert the fuse container.

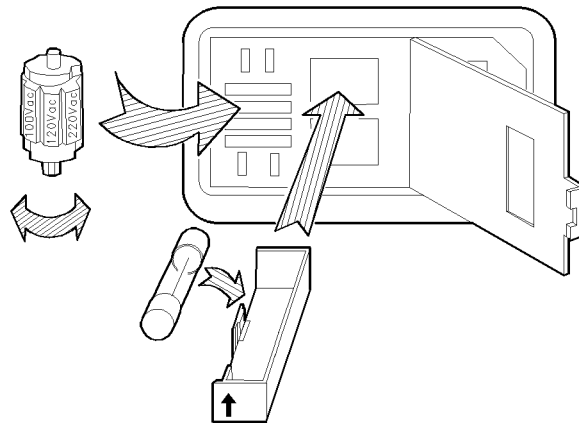

**Figure 2-2. Selecting the line voltage value and checking the fuse.**



---

## Step 4. Connect the Agilent 83446A/B to a power source

The lightwave clock/data receiver is a portable instrument and requires no physical installation other than connection to a power source.

---

### CAUTION

*Do not* connect ac power until you have verified that the line voltage is correct, the proper fuse is installed, and the line voltage selector switch is properly positioned, as described in the following paragraphs. Damage to the equipment could result.

**Table 2-1. Agilent 83446A/B Power Requirements**

Characteristic	Requirement
Input Voltage	100, 120, 220, or 240 V   $\pm 10\%$
Frequency	47 to 63 Hz
Power	75 VA  maximum

### Power cable

The lightwave receiver is equipped with a three-wire power cable, in accordance with international safety standards. When connected to an appropriate power line outlet, this cable grounds the instrument cabinet.

---

### WARNING

Failure to ground the lightwave receiver properly can result in personal injury. Before turning on the lightwave receiver, you must connect its protective earth terminals to the protective conductor of the main power cable. Insert the main power cable plug only into a socket outlet that has a protective earth contact. *Do not* defeat the earth-grounding protection by using an extension cable, power cable, or autotransformer without a protective ground conductor.

If you are using an autotransformer, make sure its common terminal is connected to the protective earth contact of the power source outlet socket.

Various power cables are available to connect the lightwave receiver to the types of ac power outlets unique to specific geographic areas. The cable appropriate for the area to which the lightwave receiver is originally shipped is included with the unit. You can order additional ac power cables for use in

**Installing the Agilent 83446A/B**

different areas. Figure 2-3 lists the available ac power cables, illustrates the plug configurations, and identifies the geographic area in which each cable is appropriate.





---

**CAUTION**

---

Always use the three-prong ac power cord supplied with this instrument. Failure to ensure adequate earth grounding by not using this cord may cause instrument damage.

Installation and Preparation for Use  
**Installing the Agilent 83446A/B**

PLUG TYPE **	CABLE HP PART NUMBER	PLUG DESCRIPTION	CABLE LENGTH CM (INCHES)	CABLE COLOR	FOR USE IN COUNTRY
<b>250V</b> 	8120-1351 8120-1703	Straight* BS1363A 90°	229 (90) 229 (90)	Mint Gray Mint Gray	Great Britain, Cyprus, Nigeria, Singapore, Zimbabwe
<b>250V</b> 	8120-1369 8120-0696	Straight* NZSS198/ASC112 90°	201 (79) 221 (87)	Gray Gray	Argentina, Australia, New Zealand, Mainland China
<b>250V</b> 	8120-1689 8120-1692	Straight* CEE7-Y11 90°	201 (79) 201 (79)	Mint Gray Mint Gray	East and West Europe, Central African Republic, United Arab Republic (unpolarized in many nations)
<b>125V</b> 	8120-1348 8120-1538	Straight* NEMA5-15P 90°	203 (80) 203 (80)	Black Black	United States Canada, Japan (100 V or 200 V), Brazil, Colombia, Mexico, Philippines, Saudi Arabia, Taiwan
	8120-1378 8120-4753 8120-1521 8120-4754	Straight* NEMA5-15P Straight 90° 90°	203 (80) 230 (90) 203 (80) 230 (90)	Jade Gray Jade Gray Jade Gray Jade Gray	
<b>250V</b> 	8120-5182 8120-5181	Straight* NEMA5-15P 90°	200 (78) 200 (78)	Jade Gray Jade Gray	Israel
<p>* Part number for plug is industry identifier for plug only. Number shown for cable is HP Part Number for complete cable, including plug.  ** E = Earth Ground; L = Line; N = Neutral.</p>					

**Figure 2-3. AC power cables available.**

---

## Step 5. Turn on the Agilent 83446A/B

With the power cable inserted into the line module, turn the lightwave receiver on by pressing the line switch. The green light-emitting diode (LED) should light. If the LED should fail to light, refer to “Performing a Quick Confidence Check” in this chapter.

---

## Connecting the Agilent 83446A/B to a Bit-Error-Ratio Test Set

The following procedure describes how to connect the lightwave clock/data receiver to a bit error ratio test set (BERT). Refer to Figure 2-4.

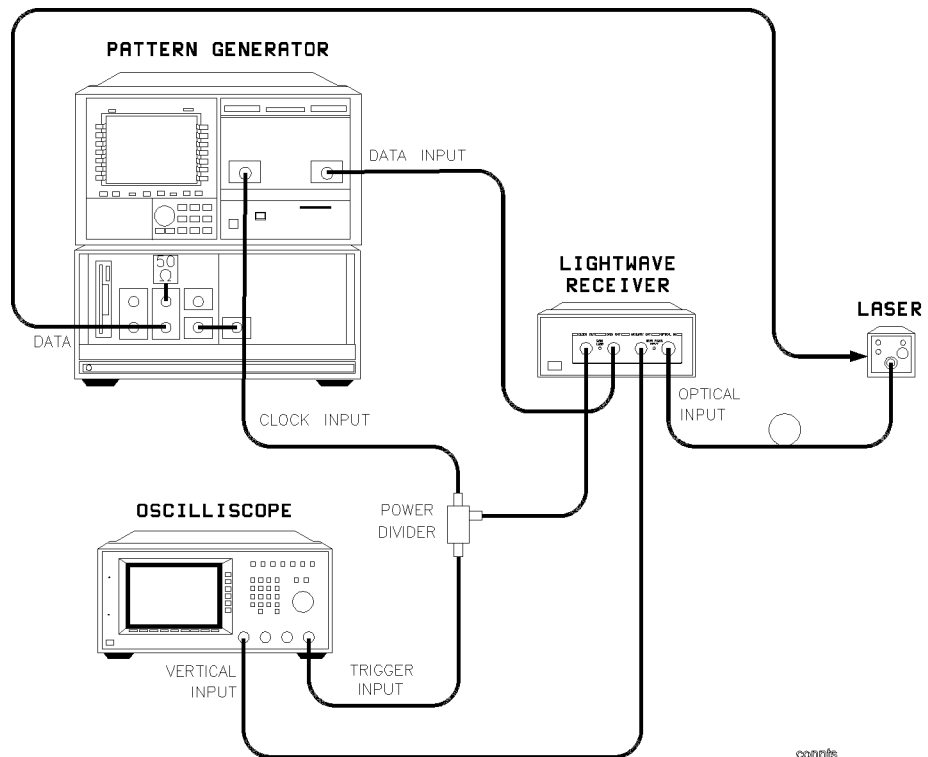

**Figure 2-4. Connecting the Agilent 83446A/B to a bit error ratio test system.**

1. Turn the lightwave clock/data receiver on. Let it warm up for 30 minutes.
2. Turn the BERT on and let it warm up according to its specifications.
3. Perform any calibrations indicated in the documentaion for the BERT.

### Connecting the Agilent 83446A/B to a Bit-Error-Ratio Test Set

4. Connect a cable from the **CLOCK OUT** connector on the receiver to the clock input connector of the BERT. An adapter may be necessary.
5. Connect a cable from the **DATA OUT** connector on the receiver to the data input connector on the BERT. An adapter may be necessary.
6. Clean the end of the receiver's **OPTICAL INPUT** glass fiber and the end of the glass fiber in the laser output cable. Refer to "Cleaning Connections for Accurate Measurements", in Chapter 2, for instructions.
7. Connect the optical connector interface to the **OPTICAL INPUT**. Notice the connector interface has a small protrusion. This protrusion fits in the slot of the **OPTICAL INPUT** connector.
8. Connect the cable from the laser output to the optical connector interface.
9. Connect the laser source to the fiber optic cable.

---

**CAUTION**

---

Do not exceed the maximum input to the receiver's **OPTICAL INPUT**. The maximum input power is shown on the front panel of the clock/data receiver.

10. If you want to monitor the analog eye on an oscilloscope, connect the receiver's **AUX OUT** to the oscilloscope's vertical input. To provide a trigger signal to the oscilloscope use a power splitter, such as the Agilent 11636A, at the clock output of the receiver. Connect one side of the splitter output to the oscilloscope's trigger input. Connect the other side of the splitter output to the clock input of the BERT.

---

## Performing a Quick Confidence Check

To verify the basic functionality of the clock/data receiver, use the following procedure. (Clean all optical interfaces as described in “Cleaning Connections for Accurate Measurements”, before making measurements.)

1. Turn on the clock/data receiver and observe the **SYNC LOSS** LED lights.
2. Connect the optical source 1200–1600 nm  $>-27$  dBm with modulation at 2.48832 Gb/s rate to optical input. (Use a 622.08 Mb/s rate at  $>-28$  dBm with Agilent 83446B instruments.)
3. The **SYNC LOSS** LED is extinguished.
4. The clock and data outputs to an oscilloscope.
5. Waveforms appear on these ports.

---

### If the verification check fails

If the clock/data receiver does not pass the verification check, you should review the procedure being performed when the problem occurred. A few minutes spent performing some simple checks may save waiting for your instrument to be repaired. Before calling Agilent Technologies or returning the unit for service, please make the following checks:

1. Is the rear-panel voltage selector switch set correctly? Is the line fuse good?
2. Does the line socket have power?
3. Is the unit plugged in to the proper ac power source?
4. Is the unit turned on? Check that the green light-emitting diode (LED) next to the line switch is on, indicating that the power supply is on.
5. If other equipment, cables, and connectors are being used with the clock/data receiver, are they connected properly and operating correctly?

**Performing a Quick Confidence Check**

6. Review the procedure for the test being performed when the problem appeared. Are all the settings correct?
7. Are the connectors clean? Refer to “Cleaning Connections for Accurate Measurements” for more information about cleaning the connectors.

If the clock/data receiver still fails, you have two options:

- Return the lightwave receiver to Agilent Technologies for repair. If the lightwave receiver is still under warranty or is covered by an Agilent Technologies maintenance contract, it will be repaired under the terms of the warranty or contract (the warranty is at the front of this manual). If the lightwave receiver is no longer under warranty or is not covered by an Agilent maintenance plan, Agilent Technologies will notify you of the cost of the repair after examining the unit. Refer to “How to Return the Agilent 83446A/B for Service”, later in this chapter, for more information.
- Have the unit repaired by qualified service personnel. Refer to Chapter 4.

---

**WARNING**

---

No operator serviceable parts inside. Refer servicing to qualified personnel. To prevent electrical shock do not remove covers.



---

## How to Return the Agilent 83446A/B for Service

When an instrument is returned to a Agilent Technologies service office for servicing, it must be adequately packaged and have a complete description of the failure symptoms attached.

When describing the failure, please be as specific as possible about the nature of the problem. Include copies of additional failure information (such as instrument failure settings, data related to instrument failure, and error messages) along with the instrument being returned.

Please notify the service office before returning your instrument for service. Any special arrangements for the instrument can be discussed at this time. This will help the service office to service and return your instrument as quickly as possible.

---

## Packaging

The original shipping containers should be used. If the original materials were not retained, identical packaging materials are available through any Agilent Technologies office. Packaging materials are listed below.

Outer Carton .....	9211-6485
Foam Pad Set .....	9220-4805

---

### **CAUTION**

Instrument damage can result from using packaging materials other than those specified. Never use styrene pellets as packaging material. They do not adequately cushion the instrument or prevent it from shifting in the carton. They may also cause instrument damage by generating static electricity.

---

---

## Instrument shipping preparation procedure

1. Write a complete description of the failure and attach it to the instrument. Include any specific performance details related to the problem.

The following information should be returned with the instrument.

- Type of service required.
- Description of the problem:
  - Whether problem is constant or intermittent.
  - Whether instrument is temperature-sensitive.
  - Whether instrument is vibration-sensitive.
  - Instrument failure settings.
  - Error codes.
  - Performance data.
- Company name and return address.
- Name and phone number of technical contact person.
- Model number of returned instrument.
- Full serial number of returned instrument.
- List of any accessories returned with instrument.

2. Pack the instrument in the appropriate packaging material. Refer to “Packaging”, in this section, for information about the original packaging material.

If the original or equivalent packaging materials cannot be obtained, instruments can be packaged using the following instructions.

---

### **CAUTION**

Inappropriate packaging of instruments may result in damage to the instrument during transit.

- Wrap the instrument in antistatic plastic to reduce the possibility of damage caused by electrostatic discharge.
- For instruments weighing less than 54 kg (120 lb), use a double-walled, corrugated cardboard carton of 159 kg (350 lb) test strength.
- The carton must be large enough to allow 3 to 4 inches on all sides of the instrument for packing material, and strong enough to accommodate the weight of the instrument.
- Surround the equipment with 3 to 4 inches of packing material, to protect the instrument and prevent it from moving in the carton. If packing foam is not available, the best alternative is S.D-240 Air Cap™

from Sealed Air Corporation (Commerce, California 90001). Air Cap™ looks like a plastic sheet filled with air bubbles. Use the pink (antistatic) Air Cap™ to reduce static electricity. Wrapping the instrument several times in this material will protect the instrument and prevent it from moving in the carton.

3. Seal the carton with strong nylon adhesive tape.
4. Mark the carton "FRAGILE, HANDLE WITH CARE".
5. Retain copies of all shipping papers.

---

## Sales and service offices

Agilent Technologies has sales and service offices located around the world to provide complete support for Agilent Technologies products. To obtain servicing information or to order replacement parts, contact the nearest Agilent Technologies Sales and Service Office. In any correspondence or telephone conversation, refer to the instrument by its model number, serial number, and option designation.

Before returning an instrument for service, call the Agilent Technologies Instrument Support Center at (800) 403-0801, visit the Test and Measurement Web Sites by Country page at <http://www.tm.agilent.com/tmo/country/English/index.html>, or call one of the numbers listed below.

**How to Return the Agilent 83446A/B for Service**

**Table 2-2. Agilent Technologies Service Numbers**

Austria	01/25125-7171
Belgium	32-2-778.37.71
Brazil	11  7297-8600
China	86 10 6261 3819
Denmark	45 99 12 88
Finland	358-10-855-2360
France	01.69.82.66.66
Germany	0180/524-6330
India	080-34 35788
Italy	+ 39 02 9212 2701
Ireland	01 615 8222
Japan	81 -426-56-7832
Korea	82/2-3770-0419
Mexico	5  258-4826
Netherlands	020-547 6463
Norway	22 73 57 59
Russia	+ 7-095-797-3930
Spain	34/91  631 1213
Sweden	08-5064 8700
Switzerland	01  735 7200
United Kingdom	01 344 366666
United States and Canada	800  403-0801

---

## Cleaning Connections for Accurate Measurements

Accurate and repeatable measurements require clean connections. Use the following guidelines to achieve the best possible performance when making measurements on a fiber-optic system:

- Keep connectors covered when not in use.
- Use dry connections whenever possible.
- Use the cleaning methods described in this section.
- Use care in handling all fiber-optic connectors.
- When inserting a fiber-optic connector into a front-panel adapter, make sure that the fiber end does not touch the outside of the mating connector or adapter.

Because of the small size of cores used in optical fibers, care must be used to ensure good connections. Poor connections result from core misalignment, air gaps, damaged fiber ends, contamination, and improper use and removal of index-matching compounds.

Use dry connections. Dry connectors are easier to clean and to keep clean. Dry connections can be used with physically contacting connectors (for example, Diamond HMS-10, FC/PC, DIN, and ST). If a dry connection has 40 dB return loss or better, making a wet connection will probably not improve (and can degrade) performance.

---

### CAUTION

Agilent Technologies strongly recommends that index matching compounds NOT be applied to their instruments and accessories. Some compounds, such as gels, may be difficult to remove and can contain damaging particulates. If you think the use of such compounds is necessary, refer to the compound manufacturer for information on application and cleaning procedures.

---

#### Cleaning Accessories

Item	Agilent Part Number
Any commercially available denatured alcohol	-
Cotton swabs	8520-0023
Small foam swabs	9300-1223
Compressed dust remover [non-residue]	8500-5262

**Cleaning Connections for Accurate Measurements**

**Dust Caps Provided with Lightwave Instruments**

Item	Agilent Part Number
Laser shutter cap	08145-64521
FC/PC dust cap	08154-44102
Biconic dust cap	08154-44105
DIN dust cap	5040-9364
HMS 10 dust cap	5040-9361
ST dust cap	5040-9366

**Inspecting Fiber-Optic Cables**

Consistent measurements with your lightwave equipment are a good indication that you have good connections. However, you may wish to know the insertion loss and/or return loss of your lightwave cables or accessories. If you test your cables and accessories for insertion loss and return loss upon receipt, and retain the measured data for comparison, you will be able to tell in the future if any degradation has occurred.

Connector (or insertion) loss is one important performance characteristic of a lightwave connector. Typical values are less than 1 dB of loss, and sometimes as little as 0.1 dB of loss with high performance connectors. Return loss is another important factor. It is a measure of reflection: the less reflection the better (the larger the return loss, the smaller the reflection). The best physically contacting connectors have return losses better than 50 dB, although 30 to 40 dB is more common.

**You can visually inspect your cables**

Although it is not necessary, visual inspection of fiber ends can be helpful. Contamination or imperfections on the cable end face can be detected as well as cracks or chips in the fiber itself. Use a microscope (100X to 200X magnification) to inspect the entire end face for contamination, raised metal, or dents in the metal as well as any other imperfections. Inspect the fiber for cracks and chips. Visible imperfections not touching the fiber core may not affect performance (unless the imperfections keep the fibers from contacting).

---

**WARNING**

---

Always remove both ends of fiber-optic cables from any instrument, system, or device before visually inspecting the fiber ends. Disable all optical sources before disconnecting fiber-optic cables. Failure to do so may result in permanent injury to your eyes.

---

## To clean a non-lensed connector

---

**CAUTION**

---

Do not use any type of foam swab to clean optical fiber ends. Foam swabs can leave filmy deposits on fiber ends that can degrade performance.

1. Apply isopropyl alcohol to a clean lint-free cotton swab or lens paper.  
Cotton swabs can be used as long as no cotton fibers remain on the fiber end after cleaning.
2. Before cleaning the fiber end, clean the ferrules and other parts of the connector.
3. Apply isopropyl alcohol to a new clean lint-free cotton swab or lens paper.
4. Clean the fiber end with the swab or lens paper. Move the swab or lens paper back and forth across the fiber end several times.

Some amount of wiping or mild scrubbing of the fiber end can help remove particles when application of alcohol alone will not remove them. This technique can remove or displace particles smaller than one micron.

5. Immediately dry the fiber end with a clean, dry, lint-free cotton swab or lens paper.
6. Blow across the connector end face from a distance of 6 to 8 inches using filtered, dry, compressed air. Aim the compressed gas at a shallow angle to the fiber end face.

Nitrogen gas or compressed dust remover can also be used.

### **Cleaning Connections for Accurate Measurements**

---

**CAUTION**

---

Do not shake, tip, or invert compressed air canisters, because this releases particles in the can into the air. Refer to instructions provided on the compressed air canister.

7. As soon as the connector is dry, connect or cover it for later use.

---

### **To clean an adapter**

1. Apply isopropyl alcohol to a clean foam swab.

Cotton swabs can be used as long as no cotton fibers remain after cleaning. The foam swabs listed in this section's introduction are small enough to fit into adapters.

Although foam swabs can leave filmy deposits, these deposits are very thin, and the risk of other contamination buildup on the inside of adapters greatly outweighs the risk of contamination by foam swabs.

2. Clean the adapter with the foam swab.
3. Dry the inside of the adapter with a clean, dry, foam swab.
4. Blow through the adapter using filtered, dry, compressed air.

Nitrogen gas or compressed dust remover can also be used.

---

**CAUTION**

---

Do not shake, tip, or invert compressed air canisters, because this releases particles in the can into the air. Refer to instructions provided on the compressed air canister.



---

## To test insertion loss

Use an appropriate lightwave source and a compatible lightwave receiver to test insertion loss. Examples of test equipment configurations include the following equipment:

- Agilent 71450A or Agilent 71451A optical spectrum analyzers with Option 002 built-in white light source.
- Agilent 8702 or Agilent 8703 lightwave component analyzer system
- Agilent 83420 lightwave test set with an Agilent 8510 network analyzer
- Agilent 8153 lightwave multimeter with a source and power sensor module

---

## To test return loss

Use an appropriate lightwave source, lightwave receiver, and lightwave coupler to test return loss. Examples of test equipment configurations include the following equipment:

- Agilent 8703 lightwave component analyzer
- Agilent 8702 analyzer with the appropriate source, receiver, and lightwave coupler
- Agilent 8504 precision reflectometer
- Agilent 8153 lightwave multimeter with a source and power sensor module in conjunction with a lightwave coupler
- Agilent 81554SM dual source and Agilent 81534A return loss module

Installation and Preparation for Use

**Cleaning Connections for Accurate Measurements**



---

## Using the Agilent 83446A/B

---

## Using the Agilent 83446A/B

**What you'll find in this chapter**

- Example of measuring dispersion power penalty of an optical fiber.
- Example of optimizing the bias on a laser for lowest bit error ratio.
- Example of generating oscilloscope eye diagrams when a separate clock trigger is not available.

---

## Bit-Error-Ratio Test

Optical fiber suffers from chromatic dispersion, which causes light at different wavelengths to travel through the fiber at slightly different velocities. Since the linewidth of a laser is not infinitesimally narrow, the different wavelength components will not all arrive at the end of a long length of fiber at the same time. This tends to flatten and spread out fast risetime pulses, leading to intersymbol interference. This effect, called dispersion power penalty, is defined as the difference in minimum detectable power level with and without dispersion.

---

### Example of measuring dispersion power penalty of single-mode fiber

The Agilent 83446A/B, in conjunction with the Agilent 71604B error performance analyzer or similar BERT, can measure the dispersion power penalty of an optical fiber when used with a particular laser source. Since dispersion power penalty depends on the spectral characteristics of the laser source, it is important that the test laser be representative of the laser to be used in the actual system.

**Bit-Error-Ratio Test**

## System sensitivity calibration

System sensitivity without dispersion is determined by connecting the laser output through an optical attenuator and directly to the clock/data receiver. To find sensitivity for  $1 \times 10^{-10}$  BER:

1. Connect the equipment as shown in Figure 3-1. Set the optical attenuator so the input power to the clock/data receiver is approximately -20 dBm. Confirm the SYNC LOSS LED on the clock/data receiver is extinguished and the BERT reads a bit error ratio of zero. If necessary, perform automatic CLOCK/DATA alignment on the BERT to achieve minimum error ratio. Allow all equipment to warm up at least 30 minutes.

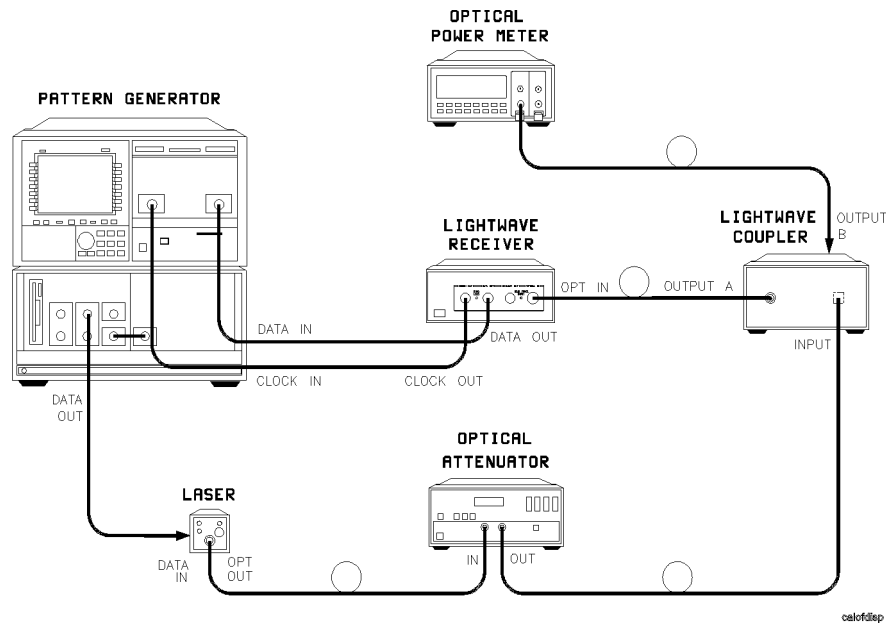

**Figure 3-1. Setup for calibration of dispersion power penalty test system.**

2. Set the BERT as follows:

Pattern .....  $2^{23}-1$  PRBS  
 Clock Frequency (Agilent 83446A) ..... 2.48832 GHz

Clock Frequency (*Agilent 83446B*) ..... 622.08 MHz  
 Polarity ..... *As necessary for proper pattern synchronization*  
 Data Amplitude,  
     Data High ..... *As necessary to achieve required extinction ratio*  
 Gating ..... Single  
 Gating Period ..... Sufficient to capture 100 errors

Refer to Table 3-1 for approximate gating line times.

For very low error ratios, this may result in unacceptably long gating times. In this case, the gating time may be reduced with corresponding reduction in accuracy. Error ratios determined from less than 25 errors should be considered only approximate.

**Table 3-1. Average Gating Period to Achieve 100 Errors**

Error Rate	Gating Period (sec)	
	2.48832 Gb/s	622.08 Mb/s
$1 \times 10^{-12}$	40,188	160,752
$1 \times 10^{-11}$	4,019	16,076
$1 \times 10^{-10}$	402	1608
$1 \times 10^{-9}$	40	160
$1 \times 10^{-8}$	4	16

3. Calibrate the input of the clock/data receiver as follows:
  - a. Remove the input fiber from the optical power meter. Remove the input fiber from the clock/data receiver and connect it to the optical power meter. (Clean all optical interfaces as described in “Cleaning Connections for Accurate Measurements” in Chapter 2, before making measurements.)
  - b. Provide a good optical match for output B of the optical power splitter by connecting it to the clock/data receiver optical input.
  - c. Record the attenuator setting necessary to achieve -27.0 dBm (-28.0 dBm for Agilent 83446B) output power as measured on the optical power meter.

**Bit-Error-Ratio Test**

- d. Reconnect splitter output A to the input of the clock/data receiver and splitter output B to the optical power meter.
- e. Keeping the attenuator set as determined in step 3c, calculate the calibration factor necessary for the power meter to read  $-27.0$  dBm ( $-28.0$  dBm for Agilent 83446B). This calibration factor is then applied to all subsequent power meter readings to determine the input power to the clock/data receiver.
4. Set the attenuator so the input power to the clock/data receiver is  $-27.0$  dBm ( $-28.0$  dBm for Agilent 83446B). Set **GATING PERIOD** to 5 minutes and press the **RUN GATING** key on the BERT to initiate gating cycle. Record the error ratio indicated at the conclusion of the cycle. Confirm the BERT measures an error ratio of  $1 \times 10^{-10}$  or better.
5. Set **GATING PERIOD** as necessary to capture 100 errors and repeat list item 4 for at least three input powers over the range  $10^{-8}$  to  $10^{-4}$  BER.
6. Plot the results on log-log graph paper. Points should fall roughly on a straight line. Draw a best-fit straight line through the data and determine the power level for  $1 \times 10^{-10}$  BER. This is the system sensitivity. If a more accurate analysis is necessary, follow the procedure described in *TIA/EIA 526-5, OFSTP-5, Data Analysis of Bit Error Ratio Versus Received Power For Digital Fiber Optic Systems* (Telecommunications Industries Association, 2001 Pennsylvania Avenue, NW, Suite 800, Washington, DC 20006-1813).



## Determining dispersion power penalty

To determine dispersion power penalty:

1. Connect the equipment as shown in Figure 3-2. Fiber length should be representative of length anticipated under normal operation.

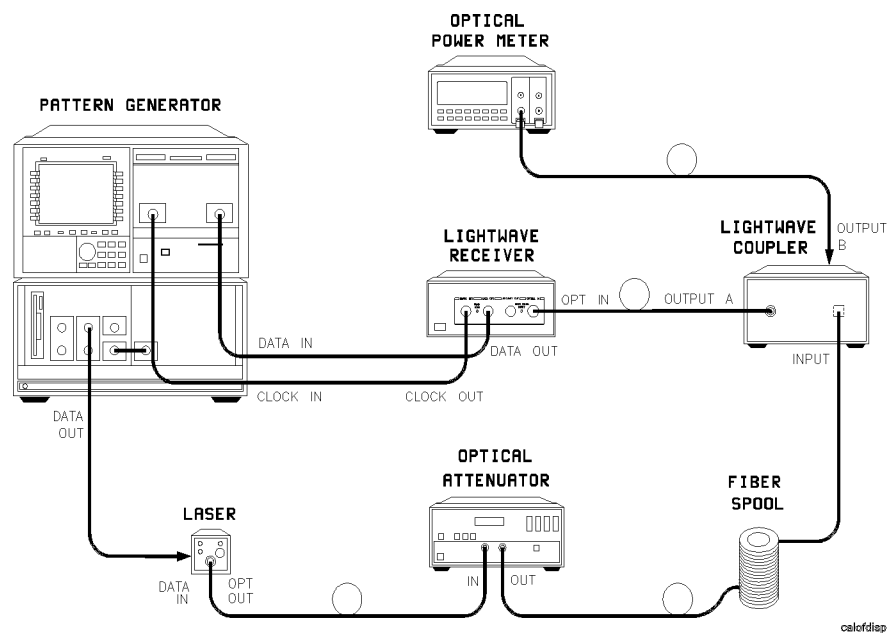

**Figure 3-2. Setup to measure dispersion power penalty of single-mode fiber.**

2. Confirm the BERT is set to the following:

Pattern .....	$2^{23}-1$ PRBS
Clock Frequency ( <i>Agilent 83446A</i> ) .....	2.48832 GHz
Clock Frequency ( <i>Agilent 83446B</i> ) .....	622.08 MHz
Polarity .....	<i>As necessary for pattern synchronization</i>
Data Amplitude,	
Data High .....	<i>As necessary to achieve required extinction ratio</i>
Gating .....	Single

Using the Agilent 83446A/B  
**Bit-Error-Ratio Test**

Gating Period ..... As necessary to capture at least 100 errors

3. Do a preliminary scan of the sensitivity by stepping the variable attenuator through a range of values and observing the delta error ratio on BERT. Record the power level into the clock/data receiver that gives roughly  $1 \times 10^{-10}$  BER. Leaving the attenuator at this setting, press **RUN GATING** key on the BERT to initiate a gating cycle. Record the error ratio indicated at the conclusion of the cycle.
4. Repeat Step 3 for at least three input powers over the range  $10^{-8}$  to  $10^{-4}$  BER.
5. Plot results on log-log graph paper. Points should fall roughly on a straight line. Draw a best fit straight line through the data and determine power level for  $1 \times 10^{-10}$  BER. If a more accurate analysis is necessary, follow the procedure described in *TIA/EIA 526-5, OFSTP-5, Data Analysis of Bit Error Ratio Versus Received Power For Digital Fiber Optic Systems*.
6. Calculate the power penalty using the equation:

$$L = P_{\text{meas}} - P_{\text{cal}}$$

where:

$L$  = dispersion power penalty in dB

$P_{\text{meas}}$  = power in dB for  $1 \times 10^{-10}$  BER with fiber in place

$P_{\text{cal}}$  = power in dB for  $1 \times 10^{-10}$  BER without fiber in place

---

## Bit-Error-Ratio Test

Digital optical transmission systems send data by intensity modulating the optical source. In principle, a logical one is represented by a time interval of full-intensity light while a logical zero is represented by an interval of no light. This ideal case produces the maximum intensity difference between a one and a zero, yielding the best signal-to-noise ratio and lowest possible bit-error-ratio.

In reality, when a laser transmitter is biased completely off, it suffers from turn-on jitter and chromatic dispersion that degrade performance. To reduce this problem, the laser is biased so a small amount of light continues to be emitted even during the transmission of a logical zero. This is measured as extinction ratio, which is defined as the ratio of the average optical power in a logical one pulse to the average optical power in a logical zero pulse. Optimum performance becomes a tradeoff between the highest extinction ratio and the lowest turn-on jitter.

---

## Example of optimizing laser extinction ratio

The clock/data receiver can be used to determine the laser bias point that produces the lowest bit-error-ratio. This is determined by adjusting laser bias for the minimum error ratio while monitoring real-time error performance on a BERT.

### **NOTE**

Because of fiber dispersion, the optimum bias point through a short length of fiber may not be the same as through a long fiber. If fiber dispersion is of concern, perform the adjustment with a representative length of fiber inserted between the variable optical attenuator and the clock/data receiver.

1. Connect the equipment as shown in Figure 3-3. Allow all equipment to warm up at least 30 minutes. Set the optical attenuator so the input power to the clock/data receiver is approximately -20 dBm. Confirm the **SYNC LOSS** LED on the clock/data receiver is extinguished and the BERT reads a bit-error-ratio of zero. If necessary, perform automatic **CLOCK/DATA** alignment on the BERT to achieve the minimum error ratio.

2. Set the BERT to the following:

Pattern .....	$2^{23}-1$ PRBS
Clock Frequency ( <i>Agilent 83446A</i> ) .....	2.48832 GHz
Clock Frequency ( <i>Agilent 83446B</i> ) .....	622.08 MHz
Polarity .....	<i>As necessary for proper pattern synchronization</i>
Data Amplitude, Data High .....	<i>As required by laser</i>
Gating .....	Manual
Gating .....	Off

### Bit-Error-Ratio Test

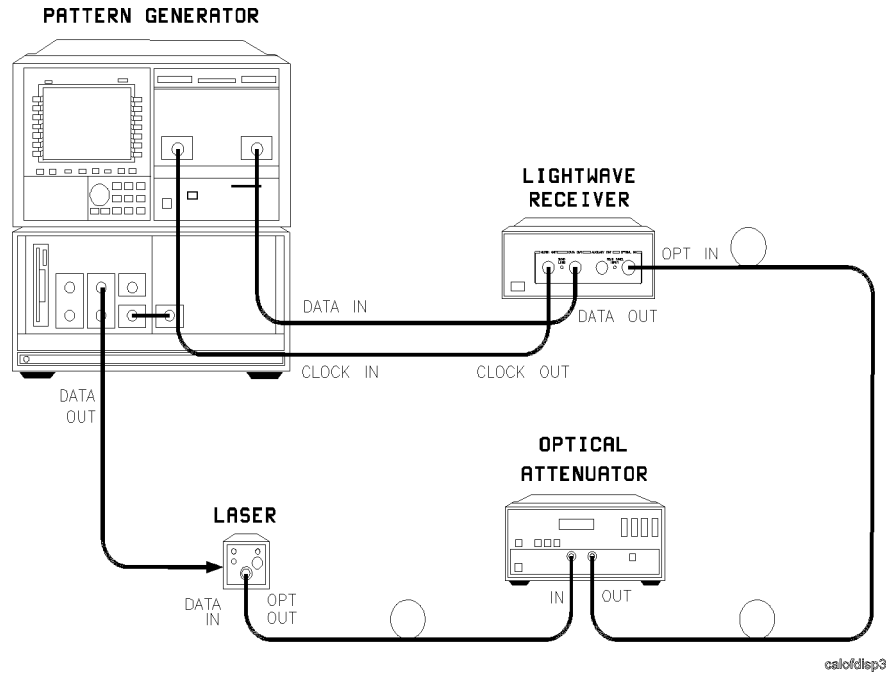

Figure 3-3. Setup for optimizing laser extinction ratio.

3. Observe the delta-error-ratio on the BERT. Set the attenuator to an attenuation level high enough to cause a measurable error ratio in the range of  $10^{-6}$  to  $10^{-9}$ .
4. While observing the delta-error-ratio on the BERT, slowly adjust the laser bias in the direction that causes the error ratio to improve. If the error ratio goes to zero, increase the attenuation to again obtain a measurable error ratio. Continue adjustment until no further improvement in error ratio is obtained. This is the point of optimum bias.

---

## Waveform Test

Eye diagrams are important tools for characterizing the waveform performance of a laser source. An eye diagram is generated on an oscilloscope by observing the data output from the laser while triggering the oscilloscope from a separate signal at the clock frequency.

---

### Example of measuring eye diagram using recovered clock signal

In many cases a separate clock signal is not readily accessible. To generate a valid eye diagram, the clock must be recovered from the data waveform and used to trigger the oscilloscope. The Agilent 83446A/B is ideal for generating this recovered clock. In addition, the waveform from the clock/data receiver's **AUXILIARY OUT** port is often adequate for use as the data input to generate the eye diagram.

Certain industry standards such as SONET and Fibre Channel require that the eye diagram be measured through a reference receiver having a carefully-controlled frequency response. In this case the clock/data receiver can be used to recover the clock and a separate reference receiver used to display the eye diagram.

The following procedure can be used to make SONET-compliant measurements when no separate clock signal is available.

1. Connect the equipment as shown in Figure 3-4. The attenuation value for the optical attenuator should be selected so the input optical power to the clock/data receiver is within the range  $-9$  dBm to  $-27$  dBm ( $-9$  dBm to  $-28$  dBm for Agilent 83446B). Note that the optical coupler need not have symmetric outputs on its two ports. To maximize input power into the reference receiver and reduce the effect of oscilloscope noise, it may be advantageous to use a coupler with a coupling factor of approximately 20 dB on output B and very low loss on output A.

### Waveform Test

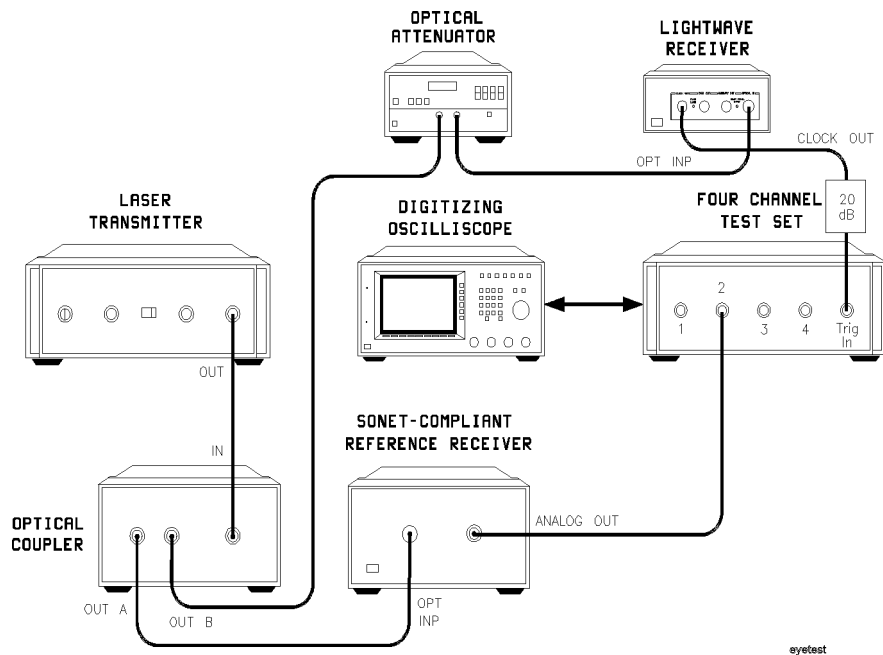

**Figure 3-4. Setup for measuring eye diagram by triggering from recovered clock.**

2. Adjust the trigger level on the oscilloscope to achieve reliable triggering.
3. Set the oscilloscope **TIME/DIV** to 100 ps. Adjust the vertical scale on the oscilloscope to obtain a convenient signal level on the display. The displayed eye diagram now accurately represents the contributions of all possible bit combinations.



---

**Servicing the Agilent  
83446A/B**

---

## Servicing the Agilent 83446A/B

### What you'll find in this chapter

- General information
- Troubleshooting
- Adjustment procedure
- Replacement procedures
- Replaceable parts

---

**WARNING**

---

These servicing instructions are for use by qualified personnel only. To avoid electrical shock, do not perform any servicing unless you are qualified to do so.

---

**WARNING**

---

The opening of covers or removal of parts is likely to expose dangerous voltages. Disconnect the instrument from all voltage sources while it is being opened.

---

**WARNING**

---

The power cord is connected to internal capacitors that may remain live for five seconds after disconnecting the plug from its power supply.

---

**WARNING**

---

This is a Safety Class 1 Product (provided with a protective earthing ground incorporated in the power cord). The mains plug shall only be inserted in a socket outlet provided with a protective earth contact. Any interruption of the protective conductor inside or outside of the instrument is likely to make the instrument dangerous. Intentional interruption is prohibited.

---

**WARNING**

---

For continued protection against fire hazard, replace line fuse only with same type and ratings, (type T 0.315A/250V for 100/120V operation *or* T 0.16A/250V for 220/240V operation). The use of other fuses or materials is prohibited.

---

## General information

**NOTE**

Clean the cabinet using a damp cloth only.

**Serial-number information**

Whenever you contact Agilent Technologies about your lightwave receiver, have the complete serial number and option designation available. This will ensure you obtain accurate service information. Refer to “Description of the Agilent 83446A/B” in Chapter 1 for more information.

**Safety considerations**

Before servicing this lightwave receiver, familiarize yourself with the safety markings on the instrument and the safety instructions in this manual. This instrument has been manufactured and tested according to international safety standards. To ensure safe operation of the instrument and the personal safety of the user and service personnel, the cautions and warnings in this manual must be heeded.

Refer to the summary of safety considerations at the front of this manual. Individual chapters also contain a detailed safety notation.

---

**WARNING**

Failure to ground the lightwave receiver properly can result in personal injury, as well as instrument damage.

Before turning on the lightwave receiver, connect a three-wire power cable with a standard IEC 320-C13 (CEE 22-V) inlet plug to the lightwave receiver power receptacle. The power cable outlet plug must be inserted into a power-line outlet socket that has a protective earth-contact. *Do not* defeat the earth-grounding protection by using an extension cable, power cable, or autotransformer without a protective ground conductor.

If you are using an autotransformer, make sure its common terminal is connected to the protective ground conductor of its power-source outlet socket.

---

**General information**

**Reliability considerations**

The lightwave receiver input circuitry can be damaged by power levels that exceed the maximum safe input-level specifications. Refer to Table 1-1 for the input specifications. To prevent input damage, these specified levels must not be exceeded.

**Protection from electrostatic discharge**

Electrostatic discharge (ESD) can damage or destroy electronic components. All work on electronic assemblies should be performed at a static-safe work station. Refer to “Electrostatic Discharge Information” in Chapter 1 for more information on preventing ESD.

**Required service tools**

Table 4-1 lists the tools that may be required to service the clock/data receiver.

**Table 4-1. Required Tools**

<b>Description</b>	<b>Agilent Part Number</b>
Small Pozidriv screwdriver	8710-0899
Wire cutter	8710-0012
Long-nose pliers	8710-1107
3/16 nut driver	N/A
5/16 box wrench	8720-0015
5/8 open end wrench	8710-1894
7 mm nut driver	8710-1217
8 mm nut driver	8710-1222
Torx driver T-10	8710-1623
Torx driver T-15	8710-1622
<b>Description</b>	<b>Suhner P/N</b>
Suhner connector removal tool	74Z-0-0-225

# Troubleshooting

The main functional blocks of the clock/data receiver are the power supply and the photodetector/clock/data recovery unit.

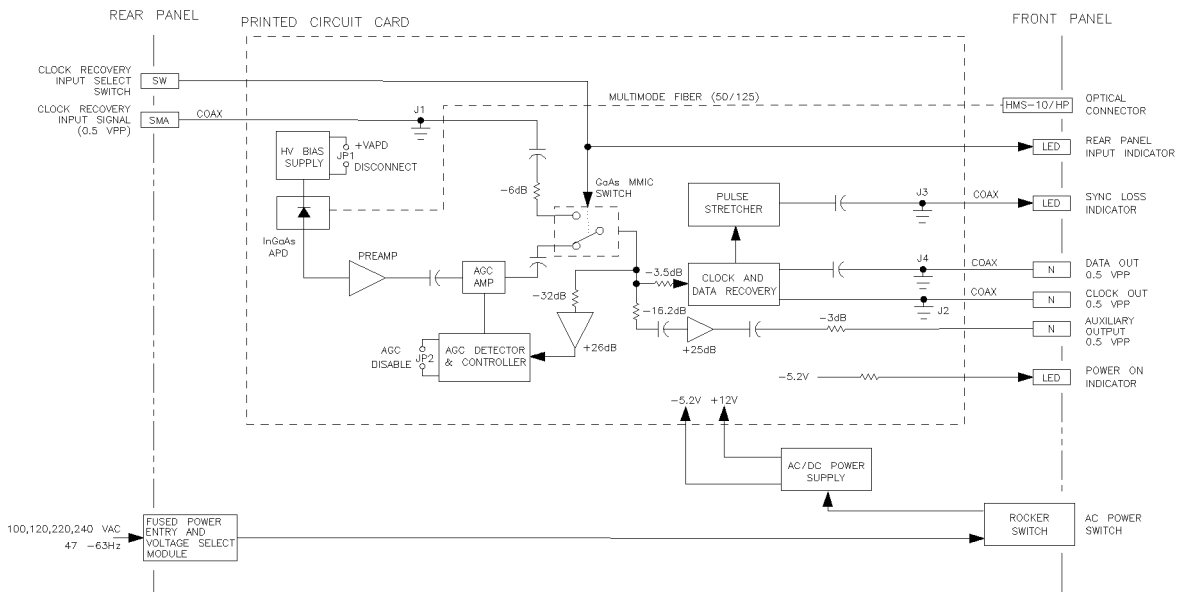

recbd\_d

Figure 4-1. Agilent 83446A/B block diagram.

**WARNING**

The opening of covers or removal of parts is likely to expose dangerous voltages. Disconnect the instrument from all voltage sources while it is being opened.

**WARNING**

The power cord is connected to internal capacitors that may remain live for five seconds after disconnecting the plug from its power supply.

## Troubleshooting

### Photodetector and clock/data recovery assembly

Modulated light enters the InGaAs avalanche photodetector diode (APD) through a multimode fiber front panel connector. The APD converts the modulated light to a current replica of the modulation. The APD is biased in the 40 to 100V range by a thermally compensated high voltage bias supply.

The APD output signal is converted to a voltage and amplified by a low noise preamp stage. The preamp output is ac coupled to a linear gain controlled stage, which outputs a fixed signal level independent of the optical input. A GaAs SPDT switch routes either this AGC output, or the rear panel electrical input, to the CDR hybrid through about 3.5 dB of power splitting loss. The CDR input can be selected by a rear-panel switch. A front-panel LED indicates when the rear-panel electrical input is active.

The CDR hybrid recovers synchronous clock signals and data signals which may be noisy and corrupted by transmission distortion. Both clock signals and data signals are ac coupled to the front-panel output ports. The CDR chip also generates an indication of its synchronization status, which is pulse-stretched and used to drive a front-panel sync loss LED.

The first step in the CDR recovery process is to compare the corrupted input to a detection threshold. The exact setting of this threshold is critical. An internal adjustment optimizes this setting for optimum sensitivity.

Two samples of the CDR hybrid input are routed through loss pads to different buffer amplifiers. The first amplifier drives the AGC detector to set the signal level of the detected optical signal. The second signal is amplified and routed to the Auxiliary Output port on the front panel. This provides a means of observing the CDR hybrid input waveform quality.

### Troubleshooting the power supply

If the +5 V power supply output voltage is low, the power supply could be in a current-limiting or overvoltage crowbar mode. If the power supply is too low, use the R12 potentiometer to decrease the voltage, then cycle the power of the clock/data receiver. Decreasing the voltage and cycling the power may bring the power supply back to normal operation. If the power supply output voltage cannot be brought within tolerance, disconnect the power supply from the photodetector and electrical amplifier unit, and recheck the +5 V power supply. If the power supply is still low, replace the power supply. If the power supply is operational, suspect the photodetector/clock/data assembly.

The -12 V power supply is *not* used. The voltages on the power supply terminals are described in Table 4-2.

**Table 4-2. Voltages on the DC Power Supply Terminals**

<b>Terminal</b>	<b>Description</b>	<b>Voltage</b>
E2, -OUT	-5.2V power supply	-5.32 Vdc $\pm$ 10 mV
E2, +OUT	Common ground	0 Vdc
E1, -OUT	-12 V power supply	-12 Vdc (approximate)
E1, COM	Common ground	0 Vdc
E1, +OUT	+12 V power supply	+12.12 Vdc $\pm$ 10 mV

---

# Adjustment Procedures

---

---

## Power supply adjustment procedure

The clock/data receiver has several adjustments, two of which are on the power supply. To adjust the power supply, use an Agilent 3456A digital multimeter (or equivalent) to measure the dc output voltage at the power supply terminals. If the dc output voltage is not within tolerance, adjust the power supply.

---

**WARNING**

---

Only trained service personnel should perform measurements inside the instrument chassis. Use extreme care. The exposed terminals on the power supply transformer carry ac line voltage. You can be killed or seriously injured if you contact them when power is applied.

1. On the power supply board, connect the multimeter between the –OUT terminal and the +OUT terminal of E2 on the dc power supply.
2. Measure the power supply output voltage. The voltage reading should be  $+5.32 \text{ Vdc} \pm 10 \text{ mV}$ .

**NOTE**

The +5 V power supply circuit has current-limiting and overvoltage control. If the +5 V power supply is adjusted above +5.8 V (approximate), the +5 V power supply will shut down.

3. If the voltage reading is not  $+5.32 \text{ Vdc}$ , adjust the +5V ADJ potentiometer (R12) for a reading of  $+5.32 \text{ Vdc} \pm 10 \text{ mV}$ .
4. On the power supply board, connect the multimeter between COM and +OUT.



5. Measure the power supply output voltage. The voltage reading should be  $+12.12 \text{ Vdc} \pm 10 \text{ mV}$ .
6. If the voltage is not  $+12.12 \text{ Vdc}$ , adjust the  $+12\text{V ADJ}$  for a reading of  $+12.12 \text{ Vdc} \pm 10 \text{ mV}$ .

---

## Photodetector/clock/data recovery assembly adjustment procedure

There are three adjustments on the photodetector/clock/data recovery assembly.

- The R50 + VAPD adjust sets the APD bias for optimum sensitivity.
- The R82 Threshold Adjust sets the CDR detection threshold for optimum sensitivity.
- The R78 High Input Limit Set sets maximum operating power for the specified error rate.

Since the equipment setup is the same as the setup required for testing instrument sensitivity, the adjustment procedures are included after the performance test.

Replacement photodetector/clock/data recovery assemblies come from the factory pre-adjusted. Slight re-adjustments may be required as the instrument ages.

## Performance Tests

The performance tests in this section require the following test equipment:

**Table 4.3. Required Test Equipment**

Agilent Model Number	Type
70001A	modular measurement system mainframe
70004A	color display
70841B	pattern generator module
70842B	BER detector module
70311A	clock source
54120B	digitizing oscilloscope mainframe
54121A	four-channel test set
8157A	optical attenuator with option 002 (1300 nm–1550 nm) and option 012 (FC/PC connectors)
8153A	lightwave multimeter
81536A	power sensor module
81534A	optical return loss module
81554SM	laser source module, 1300–1550 nm
81000BR	reference reflector
81109AC	patchcord HRL, Diamond HMS-10
83440B opt 050	optical to electrical converter
87441B	STM-4/OC-12 filter
87441D	STM-16/OC-48 filter
83440A	20 dB pads (3 each), 10 dB pad (1 each)
BCP 410A-23S-102	Lsr Xmit 1300, 2.5 Gbit *
BCP 410A-33S-102	Lsr Xmit 1550, 2.5 Gbit *
*BCP (Broadband Communications Products, Inc.) 305 East Drive, Suite A Melbourne, FL 32904 (407) 984-3671	

**Performance Tests**

**Setting up and biasing the laser transmitter**

1. Connect equipment as in Figure 4-2.
  - a. Connect the pattern generator output to the laser analog modulation input.
  - b. Connect the laser output to attenuator input.
  - c. Connect the attenuator output to the O/E converter input.
  - d. Connect the O/E output to the scope input.
  - e. Initialize the instruments.

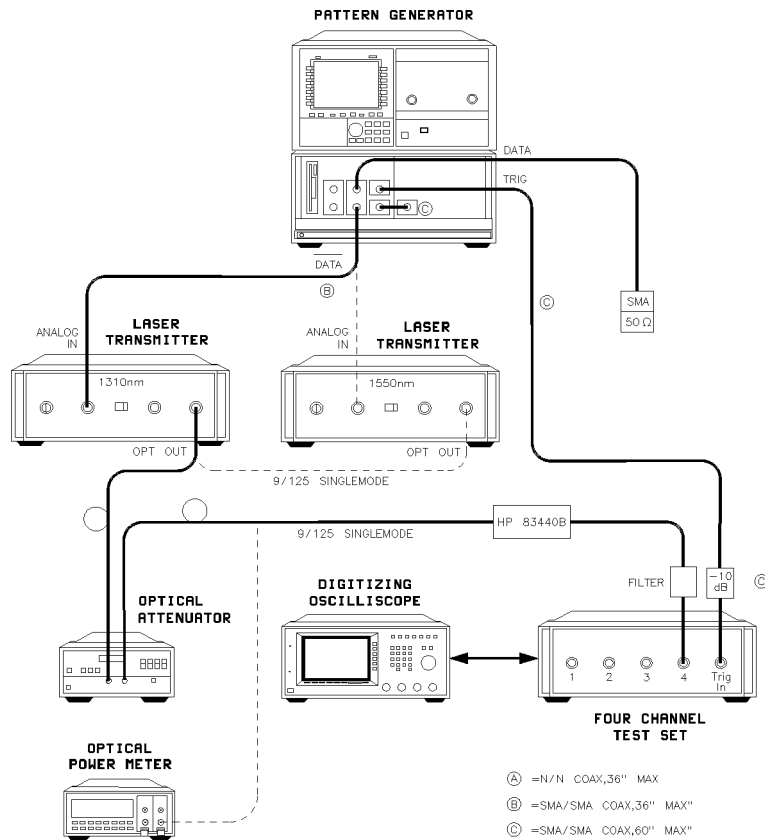

**Figure 4-2. Laser transmitter setup.**

2. Set the test equipment to the settings shown in Table 4-4.

**Table 4-4. Laser Transmitter Setup**

Pattern Generator	$2^{23} - 1$ pattern 1.00 Vpp data amplitude 0.000V data high level (0V term.) normal polarity, clock trigger trigger mode clock/32 23 zeroes trigger pattern
Error Detector	$2^{23} - 1$ pattern auto 0/1 threshold positive clock edge normal data polarity auto clock-data alignment gating manual gating <b>OFF</b>
Clock Source	2.48832 GHz frequency (Agilent 83446A), 622.08 MHz (Agilent 83446B) <b>ON</b>
Laser Transmitter (both 1310/1550 nm)	analog mode bias cal mode connect up the 1310 nm unit first. clean the optical connectors, FC/PC adapter. 1.00 Vpp drive
Optical Attenuator	clean the optical connectors calibrate to read actual power fully charged or on an ac adapter Set power to 0 dBm FC/PC adapters
Optical Power Meter	1310 nm wavelength clean the connector FC/PC adapter
Digitalizing Oscilloscope	channel 4 <b>ON</b> channels 1, 2, 3 <b>OFF</b> 100 ps/div (Agilent 83446A), 400 ps/div (Agilent 83446B) 4 mV/div -400 mV trigger level display persistence = 1 sec, zero mV offset
Optical to Electrical Converter	connected to Channel 4 on oscilloscope with STM-16/OC-48 filter for Agilent 83446A (STM-4/OC-12 filter for Agilent 83446B).

3. With the laser turned off, perform the scope oscilloscope vertical calibration.

**Performance Tests**

4. Turn on the laser and observe the eye pattern on the digitizing oscilloscope. Set a time window of 10% of the eye, centered in the eye pattern.
5. Use voltage histograms to measure the mean "1" level and the mean "0" level of V1 and V0.
6. Turn off the laser and measure the offset level (V<sub>off</sub>).
7. Calculate the extinction ratio  $(V1 - V_{off}) / (V0 - V_{off})$ .
8. Adjust the pattern generator output level, if necessary, for an extinction ratio of between 6.6 and 7.4:1.

---

## Test 1. Sensitivity

**NOTE**

Allow the Agilent 83446A/B and test equipment to warm up for at least 30 minutes.

**Procedure**

1. Connect equipment as in Figure 4-3.
2. Initialize the test equipment as shown in Table 4-5.
3. Turn on the Agilent 83446A/B. Initiate an auto clock/data alignment on the error detector. The error detector should synchronize and the error flag should disappear. An eye diagram should appear on the oscilloscope.
4. Adjust the optical power level for an error rate of less than  $1 \times 10^{-10}$ . Reset the error detector after each adjustment. Let the errors accumulate for exactly 10 minutes and then record the following:

**1310 nm**

- Number of errors |149 max. Agilent 83446A or 37 max. Agilent 83446B| \_\_\_\_\_
- Error rate |less than  $1 \times 10^{-10}$ | \_\_\_\_\_
- Optical Power |−27.0 dBm max. Agilent 83446A or −28.0 dBm max. Agilent 83446B| \_\_\_\_\_

Servicing the Agilent 83446A/B  
**Performance Tests**

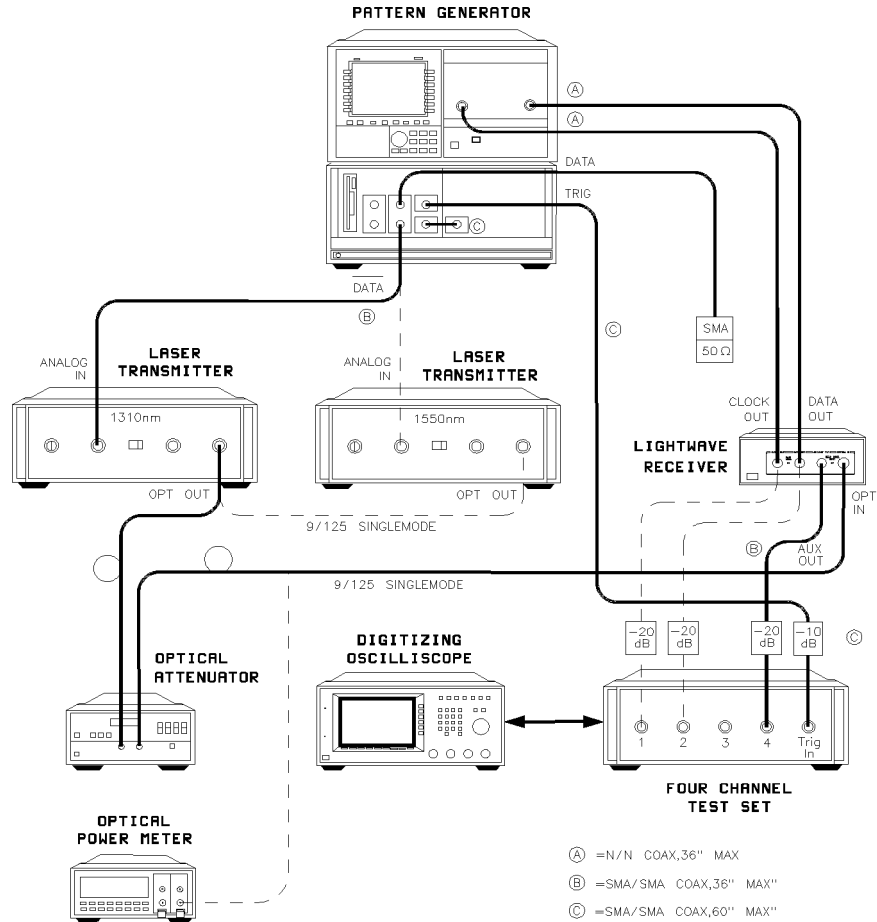

testpro

**Figure 4-3. Agilent 83446A/B test equipment set up.**



**Table 4-5. Sensitivity Test Setup**

Pattern Generator	$2^{23} - 1$ pattern data amplitude set for 6.6:1 extinction ratio on transmitter 0.000V data high level (0V term.) normal polarity clock trigger trigger mode clock/32 23 zeroes trigger pattern clock input termination $-2V$
Error Detector	$2^{23} - 1$ pattern auto 0/1 threshold positive clock edge normal data polarity auto clock-data alignment gating manual gating <b>OFF</b>
Clock Source	2.49832 GHz frequency (Agilent 83446A), 622.08 MHz (Agilent 83446B)
Laser Transmitter (both 1310/1550 nm)	analog mode bias cal mode connect up the 1310 nm unit first clean the optical connectors FC/PC adapter drive set for 6.6:1 extinction ratio
Optical Attenuator	clean the optical connectors calibrate to read actual power set power to $-15$ dBm FC/PC adapters
Optical Power Meter	1310 nm wavelength clean the connector FC/PC adapter
Digitalizing Oscilloscope	channel 4 <b>ON</b> channels 1, 2, 3 <b>OFF</b> 100 ps/div (Agilent 83446A), 400 ps/div (Agilent 83446B) $10 \times$ attenuation 100 mV/div $-400$ mV trigger level display persistence = 1 sec zero mV offset

**Performance Tests**

**Table 4-5. Sensitivity Test Setup (continued)**

Agilent 83446A/B being tested	Rear panel switch to <b>FRONT</b> – 15 dBm input power clean the optical connectors FC/PC adapter
-------------------------------	--

- Substitute the 1550 nm laser transmitter in place of the 1310 nm unit. Set the drive level for a 6.6:1 extinction ratio. Recalibrate the optical attenuator. Connect the fiber to the Agilent 83446A/B and reduce the power until errors begin. Carefully adjust the power until the error rate is less than  $1 \times 10^{-10}$ . Let the errors accumulate for exactly 10 minutes and record the following:

1550 nm

- Number of errors |149 max. Agilent 83446A or 37 max. Agilent 83446B| \_\_\_\_\_
- Error rate |less than  $1 \times 10^{-10}$ | \_\_\_\_\_
- Optical Power |–27.0 dBm max. Agilent 83446A or –28 dBm max. Agilent 83446B| \_\_\_\_\_

If the test fails, readjust R50 and R82.

**+VAPD adjustment**

- The +VAPD Adjustment (R50) is clearly labeled on the printed circuit card. The objective of this adjustment is to set the avalanche photodetector gain for near-optimum sensitivity.

**WARNING**

Hazardous voltage because +VAPD is nominally 100 Vdc. Use caution when making this measurement.

Reduce the input optical power until errors are observed. Adjust the power until roughly 10-20 errors are counted per gating cycle. Using a small flathead screwdriver, slowly adjust +VAPD (R50) either clockwise or counterclockwise so as to minimize the errors. If the errors go to zero, reduce the optical power. When the null is found, back the adjustment off *very slightly* in the counterclockwise direction, observing only a small increase in errors. Leave the adjustment set in this position. The optical power will probably be below –27 dBm.

- Verify that sync loss indicator is **OFF** \_\_\_\_\_

- Detection threshold adjustment**
7. This adjustment is marked THRESHOLD on the printed circuit card (R7). Set the optical power for about 10-20 errors per gating cycle. Adjust the THRESHOLD pot for minimum errors. If the errors go to zero during the adjustment, reduce the optical power. The THRESHOLD is optimum at the error null setting.
- Sensitivity verification**
8. After the +VAPD and THRESHOLD adjustments are complete, verify the sensitivity specification as follows. Set the optical power to  $-27.0$  dBm (Agilent 83446A) or  $-28$  dBm (Agilent 83446B). Run a 10 minute error test for Agilent 83446A (40 minutes for Agilent 83446B) and verify the total number of errors does not exceed 115. This corresponds to a bit-error-ratio of better than  $1 \times 10^{-10}$  with 95% confidence.

---

## Test 2. Maximum operating input power

**Test Setup**

The maximum operating input power test requires the same setup as “Test 1. Sensitivity”. If sensitivity testing has just been completed, the test equipment is already properly initialized. If not, initialize as instructed in the section titled “Sensitivity” in this chapter. The test may begin with either the 1310 or 1550 nm transmitter.

**Procedure**

Set the optical power into the Agilent 83446A/B at  $-9$  dBm. No errors should be detected. If errors occur at  $-9$  dBm optical power, adjust R78 as follows.

1. Raise the power to  $-7.0$  dBm. Total errors may be occurring. Slowly adjust R78 (high input limit) clockwise until the errors reduce to zero. This should happen rather abruptly. Leave R78 set just slightly past the point where the errors go to zero, and record the following:

- Transmitter wavelength \_\_\_\_\_
- Agilent 83446A: Errors at  $-8.68$  dBm in 5 minutes (5 errors, max) \_\_\_\_\_
- Agilent 83446B: Errors at  $-8.68$  dBm in 20 minutes (5 errors, max) \_\_\_\_\_
- Verify that the Sync Loss indicator is **OFF** \_\_\_\_\_

2. Change to the opposite wavelength transmitter and repeat the above measurement *without* adjusting R78.

- Transmitter wavelength \_\_\_\_\_
- Agilent 83446A: Errors at  $-8.68$  dBm in 5 minutes (5 errors, max) \_\_\_\_\_
- Agilent 83446B: Errors at  $-8.68$  dBm in 20 minutes (5 errors, max) \_\_\_\_\_
- Verify that the Sync Loss indicator is **OFF** \_\_\_\_\_

---

## Test 3. Electrical output signal amplitudes

**Test setup**

The electrical output signal amplitude test requires the same setup as shown in Figure 4-3. If the sensitivity and maximum operating input power tests have just been completed, the equipment is already initialized. If not, initialize as instructed in the section "Sensitivity".

The following procedure may be done with either the 1310 or 1550 nm transmitter.

**Procedure**

1. Disconnect all input cables from the scope 4-channel test set, including the trigger cable. Select the utility/cal menu. Execute a vertical cal procedure. Reconnect the cables as shown in Figure 4-3.
2. Disconnect the Agilent 83446A/B clock-out and data-out coax cables from the error detector and reconnect through  $-20$  dB pads to channels 1 and 2 of the 4-channel test set, respectively. N-to-SMA adapters will have to be used. Leave channels 1 and 2 **OFF**, for now. Channel 4 should be **ON**. Set offset to 0 mV, attenuation factor to 10, and vertical scale to 150 mV/div.
3. Set the optical power into the Agilent 83446A/B to  $-15$  dBm. Confirm that an eye diagram appears on the screen with a peak-peak voltage of approximately 0.5 Vpp.
4. On the oscilloscope, turn channel 4 **OFF** and turn channel 1 **ON** (Agilent 83446A/B Clock Out). Measure the peak-to-peak amplitude, using the same voltage histogram procedure as above (measure at the sinusoidal high/low peaks).

- Clock high level mean voltage \_\_\_\_\_
- Clock low level mean voltage \_\_\_\_\_
- Clock high mean value minus low mean value (must be  $>0.400$  Vpp) \_\_\_\_\_

5. Turn channel 1 **OFF** and channel 2 **ON** (Agilent 83446A/B data out). A data eye diagram should be displayed. Set the voltage histogram cursors near the eye mid-point and measure the mean high and low levels, and record:

Servicing the Agilent 83446A/B

**Performance Tests**

- Data high level mean voltage \_\_\_\_\_
- Data low level mean voltage \_\_\_\_\_
- Data high mean value minus low mean value |must be  $>0.500$  Vpp| \_\_\_\_\_

---

## Test 4. Rear-panel input port verification (functional check only)

**Test setup**

The rear-panel input port verification test requires the same setup as shown in “Test 1. Sensitivity”. If the section “Maximum operating input power” has just been completed, the test equipment has already been properly initialized. If not, initialize as instructed in the section “Sensitivity”.

**Procedure**

1. Remove the female 50 ohm termination from the pattern generator data output coax cable. Plug the SMA coax connector into the Agilent 83446A/B rear-panel SMA jack through a 6-dB pad. Set the data level to 0.350 V<sub>pp</sub>, no change in the data high level voltage. (This corresponds to 200 mV at the rear-panel input.) Turn the connected laser transmitter **OFF**. The front panel Sync Loss indicator should now be **ON**.
2. Place the Agilent 83446A/B rear-panel slide switch to the **REAR** position. The front-panel sync loss indicator should now be **OFF** and the error detector should be showing no current errors. Reset the errors to zero and verify that 74 errors maximum occur for a period of five minutes.
3. Place the rear-panel slide switch to the **FRONT** position. Disconnect the rear-panel coax and reterminate the coax plug with the 50 ohm terminator. Readjust the pattern generator data amplitude to the amplitude required for 6.6:1 extinction ratio. Switch the laser transmitter ac power **ON**.

**Performance Tests**

---

**Test 5. Input optical return loss****Test equipment****Table 4-6. Input Optical Return Loss**

<b>Agilent Product</b>	<b>Description</b>	<b>Quantity</b>
8153A	Lightwave multimeter	1 each
81534A	Return loss module	1 each
81000AI	Diamond HMS-10 connector interface	4 each
81000BR	Reference reflector	1 each
81000UM	Universa through adapter	1 each
81554SM	1310/1550 nm single mode source module	1 each
81101AC	patchcord, Diamond HMS-10	1 each
81109AC	patchcord HRL, Diamond HMS-10	1 each

**Procedure**

This test can be performed at either 1310 or 1550 nm. Make sure that the test equipment has warmed up before proceeding.

1. Before mating, carefully clean all connectors. Refer to “Cleaning Connections for Accurate Measurements” in Chapter 2.
2. To calibrate the return loss module:
  - a. Connect the **OPTICAL OUTPUT** of the Agilent 8155SM to the **OPTICAL INPUT** of the Agilent 81534A using a Diamond fiber patchcord.
  - b. Make sure the source is turned off.
  - c. Zero the return loss meter.
  - d. Connect the orange end (higher return loss connector) of the Agilent 81109AC fiber patchcord to the **OPTICAL OUTPUT** of the Agilent 81534A.
  - e. Connect the other end (HMS-10 Diamond) of the Agilent 81109AC fiber patchcord to the Agilent 81000BR reference reflector.



- f. Set the Agilent 81554SM as follows:
    - Averaging time ..... 200 ms
    - Lambda ..... 1310 nm
    - CAL REF ..... 0.18 db
  - g. Turn the source on and measure the reference reflection (Dispersion→Reference).
  - h. Remove the Agilent 81000BR from the test setup and terminate the fiber for no reflections. This may be done by wrapping the fiber around the shaft of a 5-mm diameter rod five times.
  - i. Set Param REF AUX (T: is displayed on the left).
  - j. Measure the reference absorption (Dispersion→Reference).
3. Connect the output fiber of the Agilent 81534A to the **OPTICAL INPUT** of the Agilent 83446A/B. Measure the optical return loss.

---

## Replacement Procedures

**What you'll find in this section**

This section contains the replacement procedures for the following assemblies:

- RF cable and RF connector
- AC cable assembly
- Power supply
- Photodetector/clock/data recovery assembly

---

**CAUTION**

---

This instrument contains static-sensitive components. Read the electrostatic discharge information in Chapter 1 before removing any assemblies.

---

## Replacing the RF cable or the RF connector

When replacing the RF cable or RF output connectors, use the appropriate torque value. Refer to Table 4-7. When disconnecting the cables at the photodetector assembly, use the Suhner removal tool (Table 4-7).

---

### CAUTION

Avoid bending or distorting any semirigid cables when removing or reinstalling assemblies. Before removing an assembly, always loosen both ends of any semirigid cable attached to the assembly. When reinstalling cables, tighten to specified torque only. If a torque-measuring tool is not available, make semirigid cable connections finger-tight only. *Do not overtighten.*

---

### NOTE

Replacing the RF cable or the RF connector may cause the clock/data receiver to no longer meet the specifications and characteristics. (Refer to Table 1-1.) The RF cable and RF connector must be replaced *carefully* to minimize the risk of the clock/data receiver failing specifications. To be sure it does meet specifications, you should return the clock/data receiver to Agilent Technologies for recalibration.

**Table 4-7. Torque Values**

Description	Tool Size	Torque
Nut RF OUTPUT type-N connectors	1/2 inch	25 inch-pounds
SMA cable connections	5/16 inch	10 inch-pounds
PCB surface mount connectors	Suhner tool 74Z-0-0-225	



**Table 4-8. Line Module to DC Power Supply Connections**

<b>Index Number</b>	<b>Cable Attachment (from the Line Module)</b>	<b>Cable Color</b>
1	ac power harness	White/brown/gray
2	ac power harness	Gray
3	dc power supply (labeled 5)	White
4	dc power supply (labeled 4)	Yellow
5	dc power supply (labeled 3)	Orange
6	dc power supply (labeled 2)	Red
7	dc power supply (labeled 1)	Blue
8	ac power harness	White/gray/red
9	ac power harness	White/gray
10	Terminal solder lug  bottom of rear-panel	—

**Replacement Procedures**

## Replacing the power supply

Unsolder the connections to the dc power supply. Remove the four screws that attach the power supply to the chassis. Refer to Table 4-1, Figure 4-5, Table 4-9, and Table 4-8 when installing a new power supply.

Adjust the 5.2V and 12V power supplies to the proper voltages listed in Figure 4-5.

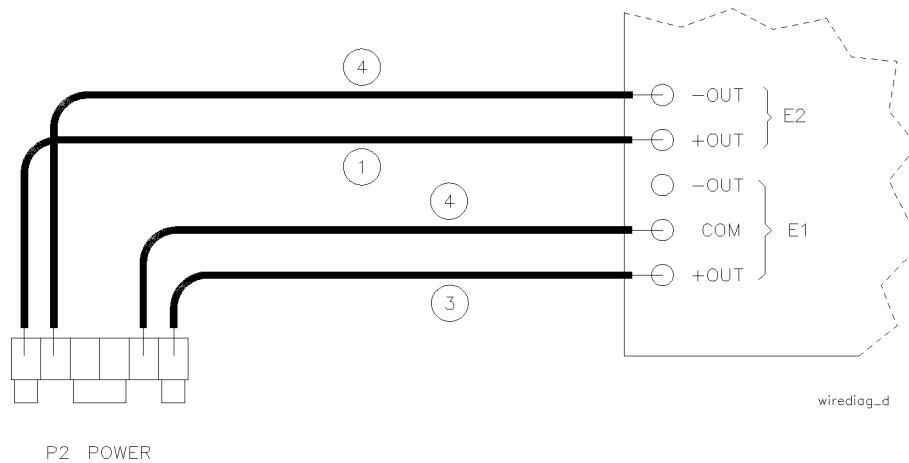

**Figure 4-5. Wiring Diagram for the power supply terminals.**

**Table 4-9. DC Power Supply Terminal Connections**

Index Number	Cable Attachment	Cable Color
1	E2 +OUT	black
2	E2 -OUT	violet
3	E1 +OUT	red
4	E1 COM	black

---

## Replacing the PCDR assembly

1. Remove the cable assemblies from connectors P1, P2, and P3 on the photodetector/clock/data recovery (PCDR) assembly.
2. Use the Huber Suhner connector tool (refer to Table 4-1) to remove the four coax cable assemblies from the PCDR assembly.

---

### **CAUTION**

---

These connectors are small and delicate. Failure to use the Huber Suhner connector tool can result in concealed damage that will cause an unreliable connection.

3. Carefully remove the optical fiber connector from the front flange connector on the front panel. Be careful not to kink the optical fiber.
4. Remove the eight screws securing the PCDR assembly to the chassis and remove the assembly.
5. Install the replacement PCDR assembly.
6. With the ac power switched on, check the three front panel LED indicators. They should indicate as follows:

Power indicator (green) .....	On
Sync loss indicator (red) .....	On
Rear-panel input indicator (yellow)	
Rear-panel slide switch to <b>REAR</b> .....	On
Rear-panel slide switch to <b>FRONT</b> .....	Off

7. Leave the rear-panel slide switch in the **FRONT** position (indicator off).

---

# Replaceable parts

## What you'll find in this section

This section contains information for:

- identifying and ordering replacement assemblies
- mechanical parts for the Agilent 83446A/B lightwave receiver

### Replaceable parts table format

Table 4-10 lists information for each major assembly and for each major mechanical and electrical part that is not part of a major assembly. Table 4-11 lists information for the clock/data receiver replaceable hardware. The following information is listed in Table 4-10 and Table 4-11:

- Item number of callout in Figure 4-6 and Figure 4-7.
- Agilent Technologies part number.
- Description of the assembly.

### Part ordering information

To order an assembly or mechanical part listed in this chapter, quote the Agilent Technologies part number, and indicate the quantity required.

To order a part that is *not* listed, include the following information with the order:

- Lightwave receiver model number.
- Lightwave receiver serial number.
- Description of where the part is located, what it looks like, and its function (if known).
- Quantity needed.

Parts can be ordered by addressing the order to the nearest Agilent Technologies office. Customers within the USA can also use either the direct mail-order system or the direct phone-order system described below. The direct phone-order system has a toll-free phone number available.



**Direct mail-order system**

Within the USA, Agilent Technologies can supply parts through a direct mail-order system. Advantages of using the system are as follows:

- Direct ordering and shipment from Agilent Technologies.
- No maximum or minimum on any mail order. (There is a minimum order amount for parts ordered through a local Agilent Technologies office when the orders require billing and invoicing.)
- Prepaid transportation. (There is a small handling charge for each order.)
- No invoices.

To provide these advantages, a check or money order must accompany each order. Mail-order forms and specific ordering information are available through your local Agilent Technologies office.

**Direct phone-order system**

Within the USA, a phone order system is available for regular and hotline replacement parts service. A toll-free phone number is available, and Mastercard and Visa are accepted.

**Regular orders**

The toll-free phone number, (800) 227-8164, is available Monday through Friday, 6 am to 5 pm (Pacific time). Regular orders have a 4-day delivery time.

**Hotline orders**

Hotline service is available 24 hours a day, 365 days a year, for emergency parts ordering. The toll-free phone number, (800) 227-8164, is available Monday through Friday, 6 am to 5 pm (Pacific time). After-hours and on holidays, call (415) 968-2347.

To cover the cost of freight and special handling, there is an additional hotline charge on each order (three line items maximum per order). Hotline orders are normally delivered the next business day after they are ordered.

# Servicing the Agilent 83446A/B

## Replaceable parts

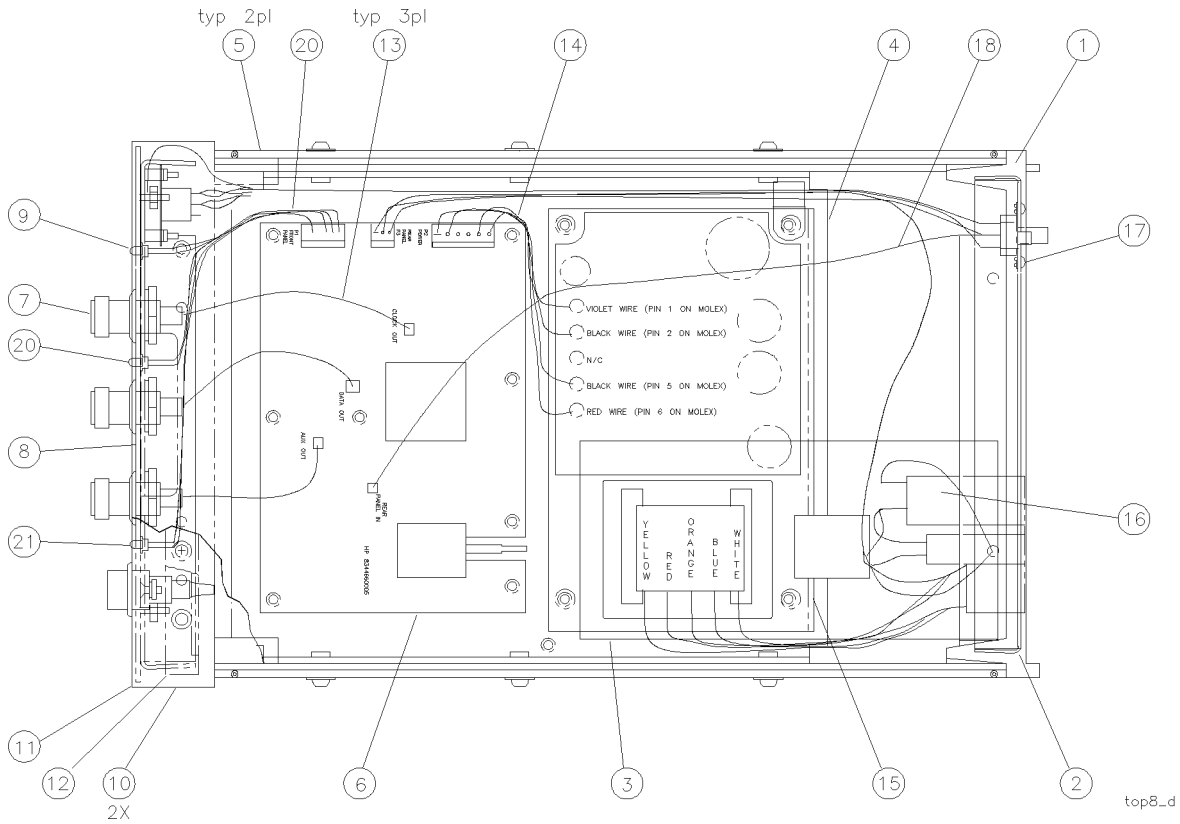
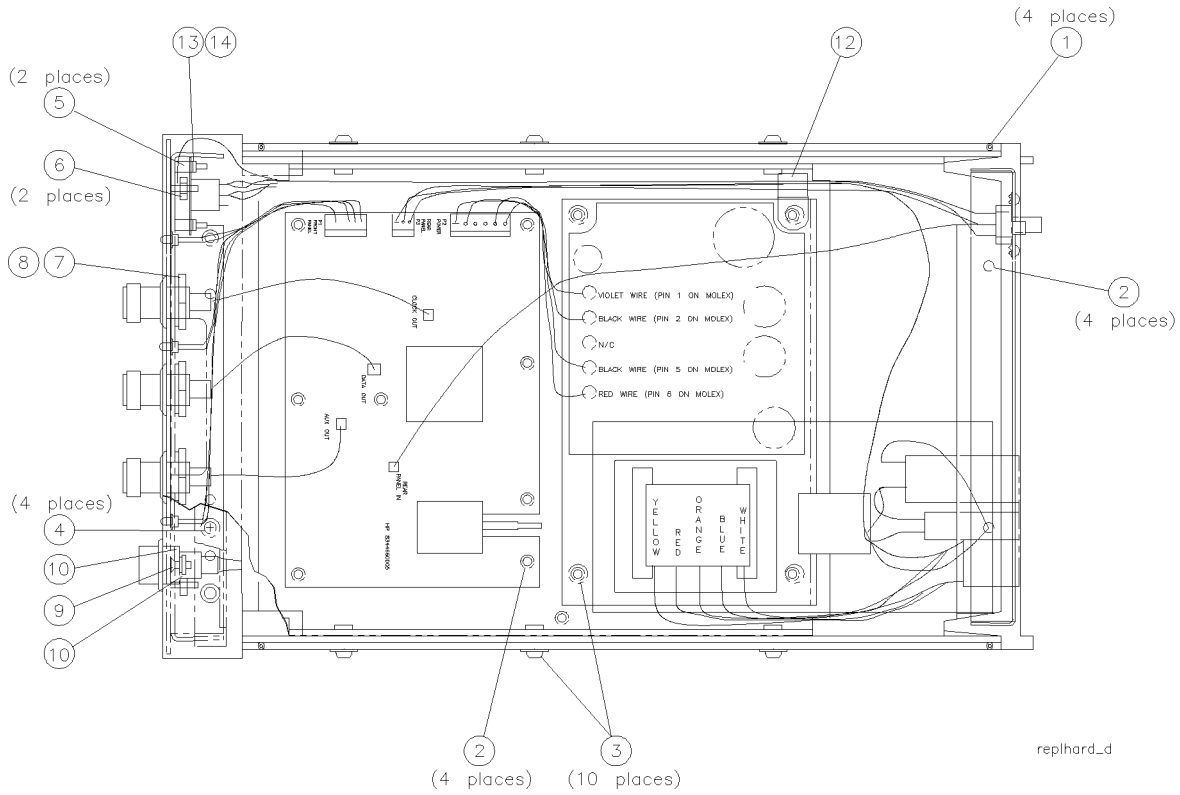

Figure 4-6. Agilent 83446A/B assembly level replaceable parts.

**Replaceable parts****Table 4-10. Assembly-Level Replaceable Parts**

<b>Index Number</b>	<b>Agilent Part Number</b>	<b>Description</b>
1	5021-5814	REAR FRAME
2	CH834454A-CDR	PANEL, REAR
3	11982-00003	INSULATOR
4	CH834452A-CDR	DECK
5	5021-5830	SIDE STRUT
6	83446-60005	Agilent 83446A: PHOTODETECTOR/CLOCK/DATA RECOVERY ASSY
	83446-69005	Agilent 83446A: EXCHANGE PHOTODETECTOR/CLOCK/DATA RECOVERY ASSY
	83446-60012	Agilent 83446B: PHOTODETECTOR/CLOCK/DATA RECOVERY ASSY
	83446-69012	Agilent 83446B: EXCHANGE PHOTODETECTOR/CLOCK/DATA RECOVERY ASSY
7	1250-1811	RF CONNECTOR, TYPE N
8	CH834453A-CDR	FRONT PANEL, DRESS
9	1990-1238	LED, GREEN
	85680-40004	LED MOUNT (NOT SHOWN)
10	5001-0538	TRIM, SIDE
11	5021-8413	FRONT FRAME
	CH834451A-CDR	FRONT PANEL, SUB (NOT SHOWN)
12	5041-8803	TRIM, TOP
13	834456B-CDR	CABLE, RF
14	834460A-CDR	DC CABLE ASSEMBLY
15	0950-2099	POWER SUPPLY
16	11982-60002	AC CABLE ASSEMBLY (INCLUDES THE LINE SWITCH AND LINE MODULE)
17	834458B-CDR	CLOCK RECOVERY INPUT SELECT SWITCH CABLE ASSY
18	834457B-CDR	CLOCK RECOVERY INPUT CABLE
19	834459B-CDR	LED WIRE HARNESS
20	1990-0486	LED, RED
21	1990-0487	LED, YELLOW
	5041-8801	FOOT, BOTTOM FRONT (NOT SHOWN)
	1460-1345	TILT STANDS FOR FRONT FEET (NOT SHOWN)
	5041-8822	FOOT, BOTTOM REAR (NOT SHOWN)
	5062-3729	TOP COVER (NOT SHOWN)
	5062-3887	BOTTOM COVER (NOT SHOWN)
	5062-3805	SIDE COVER (NOT SHOWN)
	2110-0202	FUSE (NOT SHOWN)
	0890-0732	SHRINK TUBING (NOT SHOWN)
	1400-0249	TY-RAP (NOT SHOWN)
	HWMWS-1-CDR	OPTICAL FIBER CABLE CLAMPS

Servicing the Agilent 83446A/B  
**Replaceable parts**



**Figure 4-7. Agilent 83446A/B replaceable hardware.**

**Replaceable parts****Table 4-11. Replaceable Hardware**

<b>Index Number</b>	<b>Agilent Part Number</b>	<b>Description</b>
1	0515-2044	SCREW, MACH M4.0 X 10MM FLAT-HD
2	0515-0372	SCREW, MACH M3.0 X 8MM PAN-HD
3	0515-0947	SCREW, MACH M3.5 X 10MM PAN-HD
4	0515-1400	SCREW, MACH M3.5 X 8MM FLAT-HD
5	0380-0019	STANDOFFS
6	0535-0082	HEX NUT WITH LOCK WASHER, 7 MM
7	2190-0016	LOCK WASHER
8	2950-0001	HEX NUT, 3/8 X 32
9	2200-0166	SCREW, MACH 4-40 X 5/16 FLAT-HD
10	83410-20003	OPTICAL ADAPTER BEZEL
11	2260-0009	4-40 NUT WITH LOCK WASHER
12	1400-0249	CABLE CLAMP
13	0610-0001	#2-56 HEX NUT
14	2190-0014	#2 LOCK WASHER

Servicing the Agilent 83446A/B

**Replaceable parts**



---



## Index

---

# Index

- A**
- ac cable assembly, 4-28
  - accessories, 1-5
  - ac power cables, 2-8
  - adjustment procedure, 4-8, 4-10
  - Agilent maintenance contract, 2-14
  - Agilent Technologies Sales and Service Offices, 2-17
  - altitude, 1-10
  - assembly-level replaceable parts, 4-34
  - assistance, vi
  - auxiliary out connector, 1-7
  - avalanche photodetector diode (APD), 4-6
- B**
- bit-error-ratio test
    - measuring dispersion power, 3-3
  - Bit-Error-Ratio Test
    - optimizing laser extinction, 3-10
  - bit-error-ratio test set, 2-11
- C**
- cabinet, cleaning, 2-2
  - calibration
    - system sensitivity, 3-4
  - certification, vi
  - characteristics for the Agilent 83446A/B, 1-9-11
  - checking the fuse, 2-6
  - cleaning
    - adapters, 2-22
    - non-lensed connectors, 2-21
  - cleaning, cabinet, 2-2
  - cleaning fiber-optic connections, 2-19, 2-21
  - clock/data recovery assembly, 4-6
  - clock out connector, 1-7
  - clock recovery input connector, 1-8
  - clock recovery input select switch, 1-8
  - confidence check
    - performing, 2-13
  - connector care, 2-19
  - connector interface
    - front-panel, 1-5
  - crowbar
    - overvoltage mode, 4-6
  - current-limiting, 4-6



- D** data out connector, 1-7
  - description
    - Agilent 83446A/B lightwave receiver, 1-3
  - detection threshold adjustment, 4-19
  - direct mail-order system, 4-33
  - direct phone-order system, 4-33
  - dispersion power penalty, 3-3-9
  
- E** electrical output signal amplitudes, 4-21
  - electrostatic discharge (ESD), 1-12
    - protection, 4-4
    - reducing damage, 1-14
    - static-safe work station, 1-13
  - EMI compatibility, 1-10
  - error ratio, 3-10
  - eye diagram
    - measuring from recovered clock signal, 3-13
  
- F** fiber-optic cables
  - cleaning connections, 2-19
  - inspecting, 2-20
  - fiber optics handbook, 1-5
  - front panel
    - connector interface, 1-5
    - features, 1-6
    - optical input connector, 1-10
    - output connector, 1-10
  - fuse holder door, 2-5
  
- H** hotline orders, 4-33
  - humidity, 1-10
  
- I** index-matching compounds, 2-19
  - index matching gel, 2-19
  - initial inspection, 2-3
  - input connector, 2-19
  - input optical return loss, 4-24
  - input voltage, 2-7
  - inspecting
    - cables, 2-20
  - installation category, 1-10
  - instrument shipping preparation, 2-16

- L** laser extinction
  - optimizing, 3-10
  - laser extinction ratio, 3-11
  - laser transmitter setup, 4-11
  - lightwave receiver, 1-3
  - line frequency, 2-7
  - line fuse, 2-6
  - line module, 4-28
  - line voltage range, 2-5
  - line voltage selector, 2-5
  - low voltage servicing, 4-6
  
- M** maximum operating input
  - power adjustment, 4-20
  
- O** opening the fuse holder door, 2-5
  - optical in connector, 1-7
  - options, 1-5
  - overvoltage servicing, 4-6
  
- P** packaging, 2-15
  - part ordering information, 4-32
  - performance tests, 4-11
  - photodetector assembly, 4-6
  - photodetector/clock/data recovery adjustment, 4-10
  - photodetector/clock/data recovery assembly
    - replacing, 4-31
  - pollution degree, 1-10
  - power cable, 2-7
  - power requirements, 1-10, 2-7
  - power source connection, 2-7
  - power supply
    - adjustment, 4-8
    - service, 4-30
  
- R** ratio
  - error, 3-10
  - laser extinction, 3-11
  - signal-to-noise, 3-10
- rear panel features, 1-8
- rear panel input indicator, 1-7
- rear panel input port verification, 4-23
- rear panel voltage selector, 2-5
- regular orders, 4-33
- reliability considerations
  - servicing, 4-4

- repair options, 2-14
- replaceable parts, 4-32
- replacement procedures, 4-26
- replacing
  - photodetector/clock/data recovery assembly, 4-31
- replacing the ac cable assembly, 4-28
- replacing the line module
  - servicing, 4-28
- replacing the power supply, 4-30
- responsivity testing, 2-13
- returning for service, 2-15
- RF cable or connector servicing, 4-27

**S**

- safety
  - symbols, iv
- safety considerations, v
  - servicing, 4-3
- sales and service offices, 2-17
- sensitivity testing, 4-15
- sensitivity verification, 4-19
- serial numbers, 1-5, 4-3
- service
  - assembly-level parts, 4-34
  - options, 2-14
  - power supply replacement, 4-30
  - tools, 4-4
- servicing
  - low voltage, 4-6
  - troubleshooting, 4-6
- shipping preparation, 2-16
- signal-to-noise ratio, 3-10
- single-mode fiber, 3-3
- SONET/SDH, 1-3
- specifications for the Agilent 83446A/B, 1-9-11
- static-safe accessories, 1-14
- sync loss indicator, 1-7
- system sensitivity calibration, 3-4

**T**

- temperature range, 1-10
- testing
  - performance, 4-11
  - responsivity, 2-13
  - sensitivity, 4-15
- torque requirements, 4-27
- troubleshooting, 4-5
  - servicing, 4-6
- turning on the lightwave receiver, 2-10

**V** +VAPD adjustment, 4-18  
VA power requirements, 2-7  
ventilation requirements, 2-3  
verification test  
    falling, 2-13  
voltage range, 2-5  
voltage tumbler, 2-5

**W** warranty, 2-14  
warranty information, viii  
waveform test  
    measuring eye diagram, 3-13

## Free Manuals Download Website

<http://myh66.com>

<http://usermanuals.us>

<http://www.somanuals.com>

<http://www.4manuals.cc>

<http://www.manual-lib.com>

<http://www.404manual.com>

<http://www.luxmanual.com>

<http://aubethermostatmanual.com>

Golf course search by state

<http://golfingnear.com>

Email search by domain

<http://emailbydomain.com>

Auto manuals search

<http://auto.somanuals.com>

TV manuals search

<http://tv.somanuals.com>