

# User Guide

## CF or CFAST Drive (AE6CFHI / AE6CAHI)

[www.addonics.com](http://www.addonics.com)

v3.1.11

### Technical Support

If you need any assistance to get your unit functioning properly, please have your product information ready and contact Addonics Technical Support at:

**Hours: 8:30 am - 6:00 pm PST**

**Phone: 408-453-6212**

**Email: <http://www.addonics.com/support/query/>**

Download from [Www.Somanuals.com](http://www.Somanuals.com). All Manuals Search And Download.

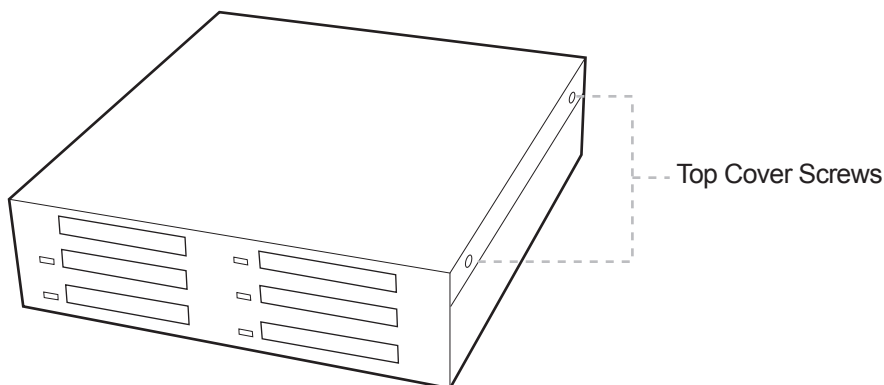

## Removing Cover of CF / CFAST Drive

To remove the top cover of the CF / CFAST Drive, loosen the 4 screws located at the side of the device using a Philips screwdriver by turning counter-clockwise. Separate the metal casing of the drive from the housing by lifting up the casing.

## Installing CF / CFAST cards into the CF Drive

Slide the CF card into each of the slot on the CF / CFAST Drive.

**Note:** It is recommended to fill up the CF / CFAST Drive with CF / CFAST cards from top to bottom, left to right. This is to help in identifying which cards connect to which ports for easier troubleshooting.

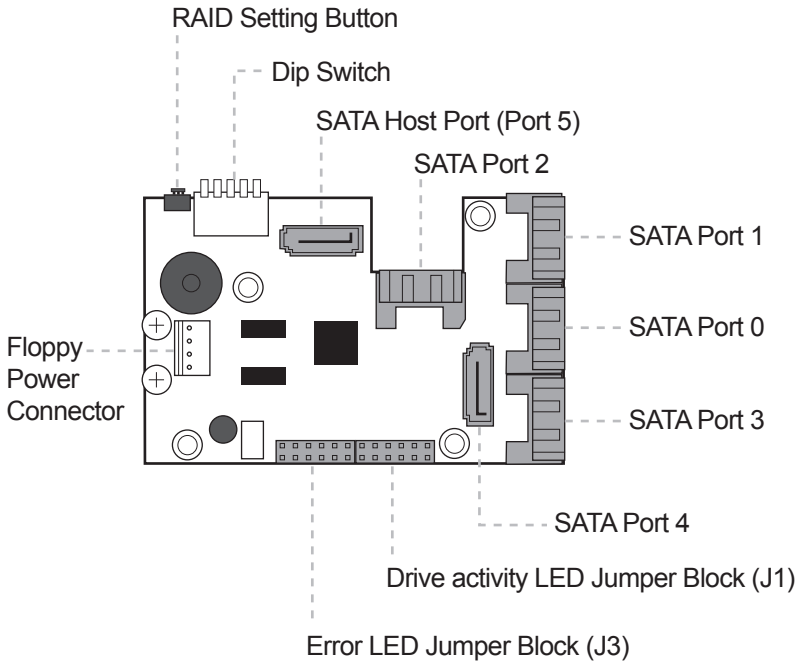

|                                       | Dip Switch Settings              |  |                      |     |     |
|---------------------------------------|----------------------------------|--|----------------------|-----|-----|
| Raid Mode                             | 1                                | 2  | 3                    | 4   | 5   |
| Individual Drive<br>(Factory Default) | OFF                              | OFF                                      | OFF                  | OFF | OFF |
| 0                                     | OFF                              | OFF                                      | ON                   | ON  | ON  |
| 1 and 10                              | OFF                              | OFF                                      | ON                   | ON  | OFF |
| 3                                     | OFF                              | OFF                                      | ON                   | OFF | OFF |
| 5                                     | OFF                              | OFF                                      | ON                   | OFF | ON  |
| Clone                                 | OFF                              | OFF                                      | OFF                  | ON  | ON  |
| Large                                 | OFF                              | OFF                                      | ON                   | OFF | ON  |
|                                       | Enable<br>ERR Buzzer<br>Function | Auto-<br>Rebuilding<br>to Spare<br>Drive | Port Multiplier Mode |     |     |

# Default factory DIP Switch setting:

## SW1 – RAID Setting DIP Switch

BZS – Error buzzer function

EZ – Automatic rebuilding to spare drive (one of the drives on the raid is set as a spare). If EZ is ENABLED and a drive failure occurs, the spare will automatically act as a drive replacement and rebuilding will automatically start.

M2 – RAID mode 2

M1 – RAID mode 1

M0 – RAID mode 0

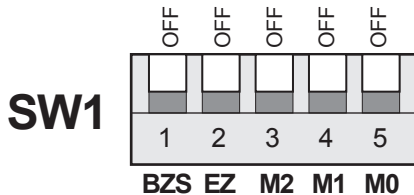

1. Error buzzer function is ENABLED (BZS) when dip switch is in OFF position
2. Auto-rebuilding to spare drive is DISABLED (EZ)
3. Individual drive mode is ENABLED (M0~M2)

**Note:** When the default factory RAID setting is used, independent drive configuration and optical drive are supported only when connecting to controllers with Silicon Image Sil3124, Sil3132 chip set or controllers that are Port Multiplier (PM) compatible. Simultaneous DVD writing was tested using the Nero Burning Rom.

## LED Pin Header

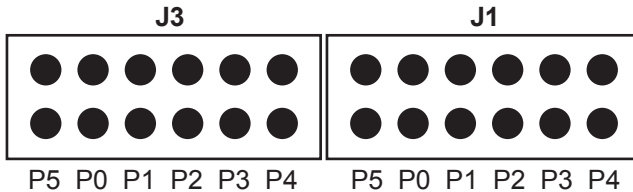

### Error LED

### Activity LED

#### J1 – Drive Activity LED

P5 – Activity LED for eSATA host port lights up when it is connected to a SATA controller card.

P0, P1, P2, P3 & P4 - Activity LEDs for port 0, 1, 2, 3, 4 & 5 light up when a drive is connected and blinks when there's drive activity.

#### J3 – Error LED

P5 – error LED for eSATA host port

P0, P1, P2, P3 & P4 - error LED for port 0, 1, 2, 3, 4 & 5

# Setting or Modifying the RAID Mode Using the JMicron HW RAID Manager Utility Program:

1. For Windows users, install the JMicron HW RAID Manager located on the SATA Controller CD. In the CD, go to Configuration Utilities > JMB393. This manager can be used to create and monitor the status of the RAID volume.

It is recommended to use the default factory RAID DIP switch setting when using the JMicron HW RAID Manager.

2. Modify the RAID mode on the 5-port HPM-XA using DIP switch

Recommended to be used on operating system without JMicron HW RAID Manager support like Linux, Mac & Solaris. Windows users can also use the procedure below.

**Note: Steps A to D need to be performed each time the raid mode is modified.**

- a. Set the DIP switch as shown below.

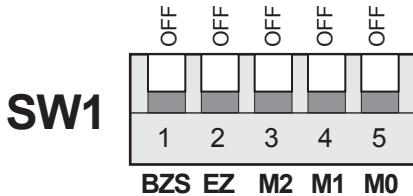

- b. Press the RAID setting button with a ball point pen.
- c. While pressing the RAID setting button turn on the system power where the HPM is connected. The buzzer will sound while holding the RAID setting button. Release it after at least 5 seconds for hardware initialization. A single beep will be heard to indicate initialization is completed. The above steps act as a reset.
- d. Power off the system power.

- e. On the DIP switch, change (M0 to M2) setting to the desired RAID mode using the diagram below.

All settings on the diagram shows

- Error buzzer function is ENABLED
- EZ function is DISABLED.

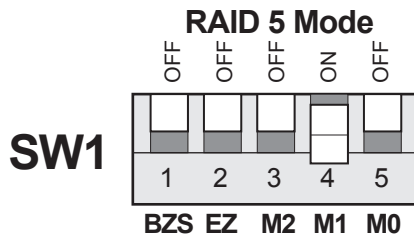
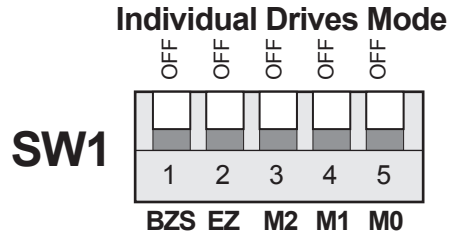
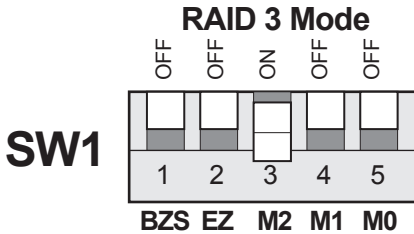
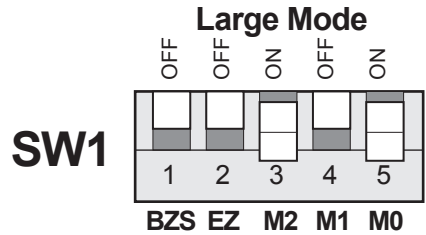
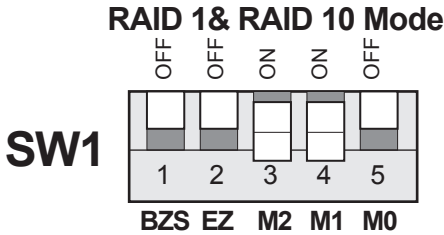
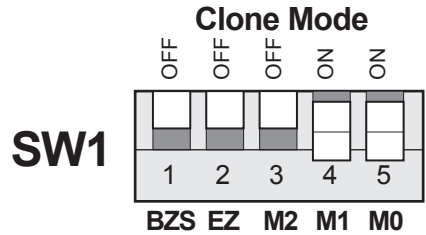
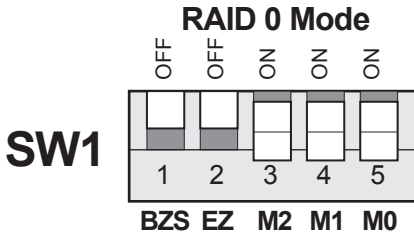

## RAID Setting Notes:

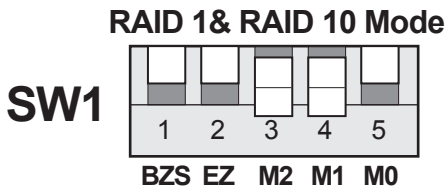

When 2 drives are connected to the HPM-XA, and DIP switch is set to this setting, the 2 drives will be configured as a 2-drive RAID1 array.

When 4 drives are connected to the HPM-XA, the 4 drives will be configured as a 4-drive RAID10 array.

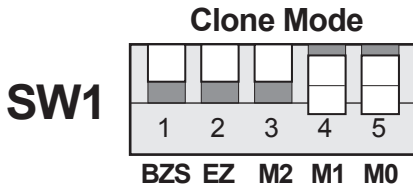

Clone's action is similar to RAID1. However, all of the hard drives will be mirrored. Clone mode is useful especially when users like to copy data from a source hard drive to the drives connected to the HPM-XA.

- f. Press the RAID setting button with a ball point pen.
- g. While pressing the RAID setting button turn on the system power where the HPM is connected. The buzzer will sound while holding the RAID setting button. Release it after at least 5 seconds for hardware initialization. A single beep will be heard to indicate initialization is completed.
- h. Verify if the RAID array is detected by the system.
- i. If the 5-port HPM-XA is connected to the motherboard onboard SATA, on the CMOS setup utility, the raid array will display as "Addonics H/W RAID5" if setup as a RAID5 array.
- j. If the 5-port HPM-XA is connected to an eSATA host controller card, on the RAID BIOS, the raid array will display as "Addonics H/W RAID0" if setup as a RAID0 array.
- k. If booted into Windows, in Disk Drives under Device Manager, the raid array will display as "Addonics H/W LARGE" if setup as a LARGE array.
- l. Once raid array is verified, you can set the buzzer either ON or OFF.

# Notes on Spare Drives using the Easy RAID Setting (EZ)

When EZ function is ENABLED, the auto-rebuilding to spare drive is automatic. The degraded RAID group will start rebuilding automatically by using the existing spare drive.

\* Spare drive can be either plugged before RAID building or a new drive can be plug as the spare drive when RAID rebuild is required.

## A. Which port acts as a spare drive?

The last drive will automatically become the spare drive.

For a 3-drive RAID5 with spare:

Drives connected to SATA ports 1~3 belong to the active RAID5 array and drive connected to port 4 is the spare.

For a 4-drive RAID10 with spare:

Drives connected to SATA ports 1~4 belong to the active RAID10 array and drive connected to port 5 is the spare.

For a 2-drive RAID1 with spare:

Drives connected to SATA ports 1& 4 belong to the active RAID1 array and drive connected to port 5 is the spare.

## B. When will rebuild action start?

- When the raid fails and EZ is enabled, the HPM-XA will automatically rebuild the RAID group using the spare.
- When the raid fails and EZ is disabled, the HPM-XA will NOT rebuild the raid group unless you install a good drive to replace the failed drive.

# CONTACT US

**www.addonics.com**

**Phone: 408-573-8580**

**Fax: 408-573-8588**

**Email: <http://www.addonics.com/sales/query/>**



## Free Manuals Download Website

<http://myh66.com>

<http://usermanuals.us>

<http://www.somanuals.com>

<http://www.4manuals.cc>

<http://www.manual-lib.com>

<http://www.404manual.com>

<http://www.luxmanual.com>

<http://aubethermostatmanual.com>

Golf course search by state

<http://golfingnear.com>

Email search by domain

<http://emailbydomain.com>

Auto manuals search

<http://auto.somanuals.com>

TV manuals search

<http://tv.somanuals.com>