

SMART View

MULTISCREEN

SMARTVIEW MULTISCREEN



INSTALLATION & USE

SMART View MULTISCREEN



www.addertec.com

SVMS4-QUAD 4 port SmartView Multiscreen with 4 monitor connections

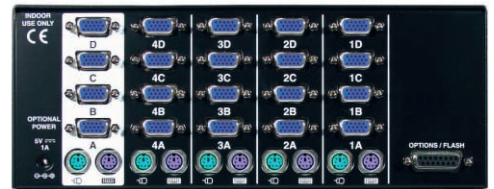

SVMS4-DUAL 4 port SmartView Multiscreen with 2 monitor connections

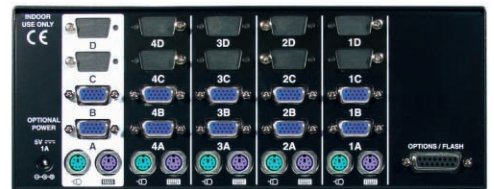

SVMS2-QUAD 2 port SmartView Multiscreen with 4 monitor connections



SVMS4-DUAL 2 port SmartView Multiscreen with 2 monitor connections



Remote Control Pad/Display RC1



About this manual

SmartView Multiscreen - Installation and Use

First edition (August 2001)

Part No. ADD0040/1

(c) 2001 Adder Technology Ltd.

www.addertec.com

All rights reserved. Whilst every precaution has been taken in the preparation of this manual, Adder Technology Ltd assumes no responsibility for errors or omissions. Neither is any liability assumed for damages resulting from the use of the information contained herein. We reserve the right to change the specifications, functions and circuitry of the product without notice. All trademarks acknowledged.

Safety information

- For use in dry, oil free indoor environments only.
- Do not attempt to service the SmartView Multiscreen yourself.
- Follow all warnings and instructions marked on the SmartView Multiscreen, its optional power adapter and its accessories.
- Warning - live parts contained within optional power adapter.
- No user serviceable parts within optional power adapter - do not dismantle.
- Replace the optional power adapter with a manufacturer approved type only.
- If you use a power extension cord with the SmartView Multiscreen, make sure the total ampere rating of the devices plugged into the extension cord does not exceed the cord's ampere rating. Also, make sure that the total ampere rating of all the devices plugged into the wall outlet does not exceed the wall outlet's ampere rating.

Warranty

Adder Technology Ltd warrants that this product shall be free from defects in workmanship and materials for a period of one year from the date of original purchase. If the product should fail to operate correctly in normal use during the warranty period, Adder will replace or repair it free of charge. No liability can be accepted for damage due to misuse or circumstances outside Adder's control. Also Adder will not be responsible for any loss, damage or injury arising directly or indirectly from the use of this product. Adder's total liability under the terms of this warranty shall in all circumstances be limited to the replacement value of this product.

If any difficulty is experienced in the installation or use of this product that you are unable to resolve, please contact your supplier.

Trademarks

All trademarks mentioned in this manual are acknowledged to be the property of the respective trademark owners.

Adder is a registered trademark of Adder Technology Limited.

Compaq is a registered trademark of Compaq Computer Corporation.

Hewlett-Packard is a registered trademark of Hewlett-Packard.

IBM, PC/AT, PS/2, RS/6000 and ThinkPad are registered trademarks of International Business Machines Corporation.

Logitech, MouseMan+ and Pilot Mouse+ are trademarks of Logitech Inc.

Microsoft and Windows are registered trademarks, and IntelliMouse is a trademark of Microsoft Corporation.

Velcro is a trademark of Velcro USA Inc.

Radio Frequency Energy

Shielded cables must be used with this equipment to maintain compliance with radio frequency energy emission regulations and ensure a suitably high level of immunity to electromagnetic disturbances.

European EMC directive 89/336/EEC

This equipment has been tested and found to comply with the limits for a class B computing device in accordance with the specifications in the European standard EN55022. These limits are designed to provide reasonable protection against harmful interference. This equipment generates, uses and can radiate radio frequency energy and if not installed and used in accordance with the instructions may cause harmful interference to radio or television reception. However, there is no guarantee that harmful interference will not occur in a particular installation. If this equipment does cause interference to radio or television reception, which can be determined by turning the equipment on and off, the user is encouraged to correct the interference with one or more of the following measures: (a) Reorient or relocate the receiving antenna. (b) Increase the separation between the equipment and the receiver. (c) Connect the equipment to an outlet on a circuit different from that to which the receiver is connected. (d) Consult the supplier or an experienced radio / TV technician for help.



FCC Compliance Statement (United States)

This equipment generates, uses and can radiate radio frequency energy and if not installed and used properly, that is, in strict accordance with the manufacturer's instructions, may cause interference to radio communication. It has been tested and found to comply with the limits for a class A computing device in accordance with the specifications in Subpart J of part 15 of FCC rules, which are designed to provide reasonable protection against such interference when the equipment is operated in a commercial environment. Operation of this equipment in a residential area may cause interference, in which case the user at his own expense will be required to take whatever measures may be necessary to correct the interference. Changes or modifications not expressly approved by the manufacturer could void the user's authority to operate the equipment.

Canadian Department of Communications RFI statement

This equipment does not exceed the class A limits for radio noise emissions from digital apparatus set out in the radio interference regulations of the Canadian Department of Communications.

Le présent appareil numérique n'émet pas de bruits radioélectriques dépassant les limites applicables aux appareils numériques de la classe A prescrites dans le règlement sur le brouillage radioélectriques publié par le ministère des Communications du Canada.

Contents

1. Introduction	6
1.1 Key features	6
1.2 Package contents	8
1.3 Remote controller contents	8
1.4 Product information	9
2. Installation	12
2.1 What you will need	12
2.2 Mounting the SmartView Multiscreen	13
2.3 Connecting your devices	13
2.4 'Interface powered' operation without the optional power adapter	14
2.5 Configuring your PCs	14
2.6 Configuring the SmartView Multiscreen	14
2.7 Summary of SmartView Multiscreen configuration options	15
2.8 Resetting the SmartView Multiscreen without disconnecting your devices	17
2.9 Other useful installation information	18
2.10 Re-enabling a disconnected PS/2 mouse	18
2.11 Hot plugging the SmartView Multiscreen into running systems and re-enabling disconnected PS/2 CPU mouse connections	19
2.12 Upgrading the SmartView's flash memory	20

3. Using the SmartView Multiscreen 23

3.1 Power on status	23
3.2 Front panel keys and remote controller.....	23
3.3 Status display.....	24
3.4 Switching operation.....	25
3.5 Keyboard hotkey control	25
3.6 Mouse control.....	26
3.7 RS232 control	27
3.8 Cascading SmartView Multiscreens	27
3.9 Synchronising SmartView Multiscreens for multiple video head applications	29

4. SmartView Multiscreen configuration options 31

4.1 Screen saver time delay	31
4.2 Autoscan lock on mode and delay time	31
4.3 Mouse mode and mouse switching of channels	32
4.4 Keyboard hotkey combination	34
4.5 Cycling between all channels or just the active channels	34
4.6 Firmware functions (version query, mouse restore and reset)	34
4.7 Setting a security password	35
4.8 Cascade query code	36
4.9 Resolving slow mouse problems	36
4.10 Exit configure mode	37

Appendices

A - Cable and connector specifications	38
B - Problem solving	43

1. Introduction

Thank you for purchasing the SmartView Multiscreen. Your SmartView Multiscreen is a high performance Keyboard, Video monitor and Mouse (KVM) sharing device which supports a wide range of PC hardware and software platforms. The Multiscreen is a new concept in KVM switches and enables you to benefit from all the convenience of the proven SmartView switches whilst taking advantage of the multiple monitor facilities available on many modern computers.

Computers fitted with multiple video cards are becoming more common as operating systems have developed to make use of the extended video "real estate" offered by multiple monitors. The increased display area enables more information to be presented to the user without reducing the resolution. The Multiscreen enables several computers equipped with these multiple video facilities to be controlled from a keyboard, mouse and an array of monitors. All the monitors and the keyboard and mouse are switched together from one computer to the next giving you full control of the wider picture.

1.1 Key features

- Control several multi-video enabled PCs with from a single keyboard, mouse and a bank of monitors.
- Dual and quad video head models available with two or four computer ports.
- Two or more SmartViews may be synchronously switched by linking their options ports.
- Switch 4,8,12 or 16 monitors together by synchronising Multiscreens.
- Excellent for banking, security and engineering applications.
- Supports high bandwidth monitors at resolutions up to 1920 x 1440 with an excellent video transfer characteristic - high bandwidth and low distortion.
- Continuous keyboard and mouse emulation on all ports ensures problem free computer bootup.
- Interface powered operation – SmartView Multiscreen draws its power from the connected computers for maximum convenience.

- Intelligent switching feature enables users to switch between all ports or just the active ports.
- Mixed AT/PS2 keyboards and PS2/RS232 mice supported as standard.
- Flash upgradeable - SmartView Multiscreen's firmware may be upgraded by connecting a computer's serial port and running a download program.
- Can be cascaded to provide a video switching network.
- Video channels support Display Data Channel (DDC/DDC1/DDC2) signalling.
- Password security prevents unauthorised use.
- User options stored in EEPROM memory.
- Optional remote control module for convenient operation.
- Channel switching by front panel key, keyboard hotkey, or 3 button mouse.
- Automatically restores keyboard and mouse states when channel changed.
- Supports keyboard modes 1,2 and 3 and mouse prompt and stream modes for IntelliMouse, IntelliMouse Explorer, and other mice.

- Supports very wide range of software including Windows 3.X, WFWG, 95, 98, 2000, NT,ME, XP, DOS, Unix, Linux, NetWare, OS/2, BSD etc.
- Supports the additional shortcut, web access and media control keys found on extended keyboards.
- May be connected to AdderView GEM products for synchronised switching applications.
- Optional power adapter can be used for 'video only' or cascade applications.

1.2 Package contents

- SmartView Multiscreen.
- This installation guide.
- (Please note that a power adapter is NOT required for most applications and so is not included. This may be purchased separately if required - part code SVMSPSU).

1.3 Remote controller contents (part code: RC1)

- Remote control module.
- Velcro strip for mounting remote controller.

1.4 Product information

Key for changing channels. Also used to access configure mode

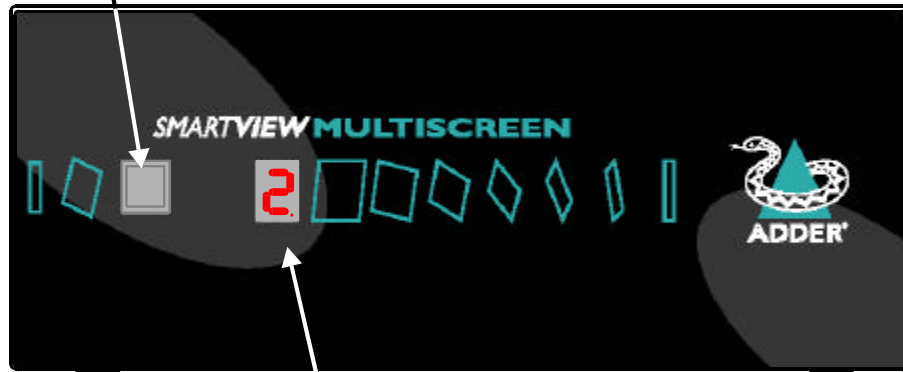

Display indicates selected channel and SmartView status

Figure 1 - SmartView Multiscreen front view

Power connection for optional power adapter

User monitor connections A,B,C and D

Computer video connections coloured BLUE. Each computer has 4 video connections (A,B,C and D)

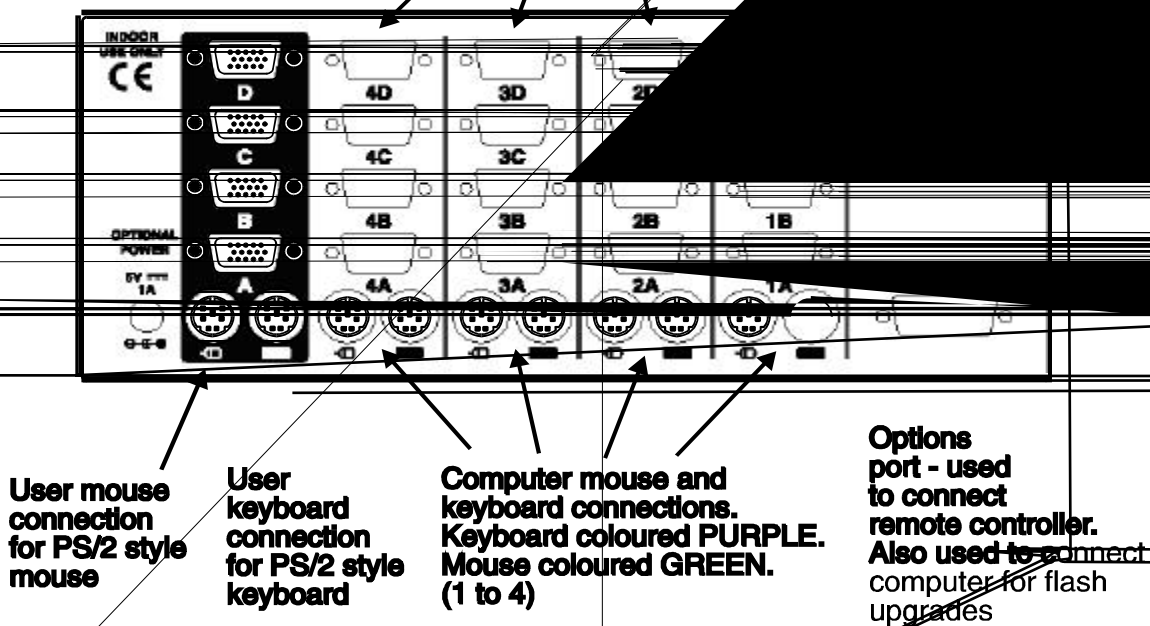

User mouse connection for PS/2 style mouse

User keyboard connection for PS/2 style keyboard

Computer mouse and keyboard connections. Keyboard coloured PURPLE. Mouse coloured GREEN. (1 to 4)

Options port - used to connect remote controller. Also used to connect computer for flash upgrades



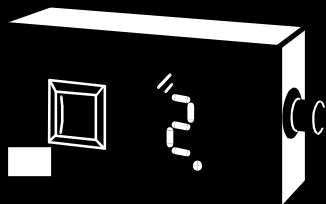

2. Installation

2.1 What you will need

- Cables to connect the SmartView Multiscreen to each of your PC keyboard, video and mouse ports. Cable specifications are given in appendix A. For convenience we suggest that you connect your keyboard, mouse and first video port using an Adder 3-in-1 combination cable. Additional video ports may then be connected using video-only cables.

- Monitors with standard VGA/SVGA (15 pin) connectors that will work when connected directly to each of your PCs. SmartView Multiscreen supports low and high resolution monitors.

- A standard AT or PS/2 style keyboard. If you are using an AT keyboard with a 5 pin connector you may connect this to the SmartView Multiscreen using a standard AT to PS/2 keyboard adapter.

- A PS/2 style two or three button Microsoft or Logitech compatible mouse or a Microsoft IntelliMouse / IntelliMouse Explorer compatible mouse. If you wish to use the mouse to switch the SmartView Multiscreen's channel then you will need a three button mouse or an IntelliMouse.

(The SmartView Multiscreen supports 'Internet Mice' that are compatible with the Microsoft IntelliMouse. These are fitted with a wheel or other scroll control and sometimes have additional buttons. Examples are: Microsoft IntelliMouse, Logitech Pilot Mouse+, Logitech MouseMan+, Genius NetMouse and Genius NetMouse Pro.)

- A suitable mouse driver for your PCs. Supported types are:
 - PS/2 or RS232 two button mouse driver (any manufacturer).
 - Microsoft mouse driver (including IntelliMouse).
 - Logitech mouse driver (including two button, three button and wheel mouse).

Use of PS/2 and RS232 style mice with the SmartView Multiscreen - All of the mouse connections from SmartView Multiscreen to PCs support either a PS/2 or an RS232 mouse. SmartView Multiscreen automatically converts from the PS/2 mouse commands to RS232 serial mouse commands. Serial mice types are selected by using an adapter as described in Appendix A. The SmartView will operate without a mouse connected if you do not wish to use one.

2.2 Mounting the SmartView Multiscreen

The SmartView Multiscreen has been designed for use on a desktop or shelf in close proximity to the user's monitor and peripherals. The optional remote controller may be used if you wish to locate the SmartView Multiscreen on a desk or shelf that is some distance from the monitor and peripherals.

2.3 Connecting your devices

Ensure that the optional power adapter is disconnected from the SmartView Multiscreen and that all the devices which are to be attached are switched off. Connect the shared keyboard, PS/2 mouse and monitors to the connectors at the rear of the SmartView Multiscreen (see figs 1, 2 and 3). Next, connect each computer system unit in turn with the keyboard cable, mouse cable and video cables. For the keyboard, mouse and first video port, Adder 3-in-1 keyboard/video/mouse cables are recommended for maximum convenience. Any unused computer connections can be left unconnected. To connect computers with serial mouse connections and AT style keyboard connections use the adapters specified in appendix A. If you have an existing 6-pin mini-DIN to 9-pin serial adapter that came with a mouse it may not be suitable for use with the SmartView as there are several different standard wiring configurations for these adapters.

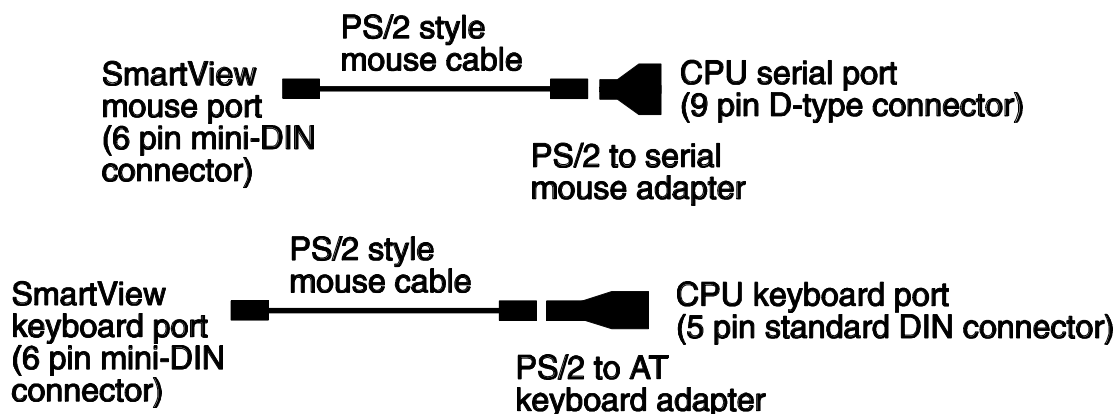

The SmartView Multiscreen is now ready for use and will start to operate as soon as one of the attached PCs is powered on. If you are connecting to PCs using cables that are longer than 5 metres or are cascading the SmartView Multiscreen to another SmartView Multiscreen you will need to use the optional power adapter. When using the optional power adapter, ensure that it is connected to the mains and powering the SmartView Multiscreen before you switch on the connected computers. Failure to switch the SmartView Multiscreen and computers on in the correct order can lead

to the mouse and/or keyboard not being recognised by the computers when they are switched on.

2.4 'Interface powered' operation without the optional power adapter

The SmartView Multiscreen draws its power from the connected computers via the keyboard cables. A single keyboard connection is normally sufficient to power the SmartView Multiscreen provided that the cable is no longer than 5 metres. If more than one computer is connected then the power will be intelligently drawn from all computers. Cables longer than 5 metres may be used provided that the SmartView Multiscreen is already powered by another connected computer or the optional power adapter. If you are cascading the SmartView Multiscreen to another SmartView Multiscreen then a power adapter must be connected to all SmartView Multiscreens.

2.5 Configuring your PCs

Configure your PC in the same way that you would if your keyboard, mouse and monitor were all connected directly to your PC. SmartView Multiscreen emulates Microsoft compatible serial, IntelliMouse, IntelliMouse Explorer and PS/2 mice, so ensure that your PC software is configured for a Microsoft mouse of the correct type. Refer to the list of supported drivers in section 2.1.

2.6 Configuring the SmartView Multiscreen

The SmartView Multiscreen is supplied pre-configured with factory defaults which are suitable for most applications. There are a number of more advanced options which can be set by the user. These are stored in the SmartView Multiscreen's EEPROM memory and are retained when the power is disconnected.

The options may be changed whilst the SmartView Multiscreen is in configure mode. You may enter configure mode at initial power on or whilst the SmartView Multiscreen is running:

To enter configure mode at power on:

Switch off all the attached PCs and the SmartView Multiscreen. Hold down the front panel key whilst powering on the SmartView Multiscreen. Remember that the SmartView Multiscreen draws its power from any attached PC via the keyboard cable and so will power itself on when the attached PC is switched on or when the optional power adapter is connected. Do not release the key until the SmartView Multiscreen displays 'C' to show that it has entered configure mode.

To enter configure mode whilst the SmartView Multiscreen is running:

Hold down the front panel key for 5 seconds until the front panel display shows 'C'.

In configure mode, options are entered by typing a letter followed by a number followed by (return). Use ESC to abort the entry of an option. The SmartView Multiscreen will remain in configure mode until you type 'E' (return).

For example: to set hotkey option 2 type the following at the 'C' prompt

(at SmartView Multiscreen 'C' prompt) H 2 f

To exit configure mode type: E f

2.7 Summary of SmartView Multiscreen configuration options

Full details of each of the configuration options and their uses are given in section 4.

- B1** - screen saver disabled (default)
- B2** - Blank screen after 1 minute of inactivity
- B3** - Blank screen after 2 minutes of inactivity
- B4** - Blank screen after 4 minutes of inactivity
- B5** - Blank screen after 8 minutes of inactivity
- B6** - Blank screen after 12 minutes of inactivity
- B7** - Blank screen after 16 minutes of inactivity
- B8** - Blank screen after 20 minutes of inactivity

- L1** - SmartView Multiscreen locks on to active ports only during autoscanning (default)
- L2** - SmartView Multiscreen locks on to every port during autoscanning
- L3** - SmartView Multiscreen powers on in autoscan mode and locks on to active ports only
- L4** - SmartView Multiscreen powers on in autoscan mode and locks on to all ports

- L5** – Allow the mouse to run at any speed (default)
- L6** – Don't allow the mouse to run at very slow speeds

- L7** - Cascade query code = AD (default)
- L8** - Cascade query code = EF

- T1** - 2 seconds autoscan delay time before switching to next port (default)
- T2** - 5 seconds autoscan delay time before switching to next port
- T3** - 7 seconds autoscan delay time before switching to next port
- T4** - 10 seconds autoscan delay time before switching to next port
- T5** - 15 seconds autoscan delay time before switching to next port
- T6** - 20 seconds autoscan delay time before switching to next port
- T7** - 30 seconds autoscan delay time before switching to next port
- T8** - 60 seconds autoscan delay time before switching to next port

- U1** - SmartView Multiscreen channels are switchable using a 3 button mouse or IntelliMouse (default)
(SmartView Multiscreen reports 2 button mouse mode to PCs)
- U2** - SmartView Multiscreen channels are not switchable using 3 button mouse or IntelliMouse
(SmartView Multiscreen reports 2 button mouse mode to PCs)
- U3** - SmartView Multiscreen channels are not switchable using 3 button mouse or IntelliMouse
(SmartView Multiscreen reports 3 button mouse mode to PCs)
- U4** - SmartView Multiscreen channels are switchable using 3 button mouse or IntelliMouse
(SmartView Multiscreen reports IntelliMouse mode to PCs)
- U5** - SmartView Multiscreen channels are not switchable using 3 button mouse or IntelliMouse
(SmartView Multiscreen reports IntelliMouse mode to PCs)

- U7** – Cycle between all ports when switching with 'Hotkeys + Tab' or three button mouse (default)
- U8** – Cycle between active ports only when switching with 'Hotkeys + Tab' or three button mouse

- H1** - Hotkey combination is CTRL + ALT + command key (default)
- H2** - Hotkey combination is CTRL + SHIFT + command key
- H3** - Hotkey combination is ALT + SHIFT + command key
- H4** - Hotkey combination is RIGHT ALT + command key
- H5** - Hotkey combination is LEFT ALT + RIGHT ALT + command key
- H6** - Hotkey combination is LEFT CTRL + LEFT ALT + command key
- H7** - Hotkey combination is RIGHT CTRL + RIGHT ALT + command key
- H8** - No hotkey combination enabled

- F1** - Display firmware first digit (Note: F1 is **F** followed by **1** NOT **I**)
- F2** - Display firmware second digit
- F3** - Display firmware third digit
- F5** - Restore PS/2 mouse function
- F6** - Restore IntelliMouse function
- F8** - RESET all configurations to default settings. (Display confirms with 'r').

P - Sets password - see section 4.6 for instructions.

E - Exits configure mode and returns the SmartView Multiscreen to normal operation mode.

2.8 Resetting the SmartView Multiscreen without disconnecting your devices

The SmartView Multiscreen draws its power from the connected computers and therefore may only be fully powered down when all the connected computers have been switched off or disconnected. However, the SmartView Multiscreen may be reset without disconnecting or powering down your computers by using the reset switch on the underside of the unit. Performing a reset using this switch performs a complete hardware reset on the SmartView Multiscreen and is equivalent to switching off the power. To perform a hardware reset, move option switch 8 to the ON position (halt and reset) and then back to the OFF position (normal operation).

2.9 Other useful installation information

PC boot up sequence - When your PCs are powered on they communicate with any attached keyboards and mice and setup parameters required by the particular operating system. It is necessary for the SmartView Multiscreen to be attached and powered on during this sequence so that it can give the required responses and keep track of all the modes and settings requested by each of the connected PCs.

Mouse characteristics - do not unplug a PS/2 mouse connection from a PC whilst the PC is on. Due to the design of PS/2 mice communications the mouse function on the PC will be lost and you will have to re-boot the PC to regain normal operation. Unplugging the mouse from the SmartView Multiscreen will also cause it to stop operating when it is plugged back in. RS232 mice can usually be unplugged and plugged back in provided that a mouse was connected when the operating system initially booted. The SmartView Multiscreen is fitted with a PS/2 mouse recovery system which allows you to disconnect and re-connect the shared mouse without powering down the system (although this is generally not advisable) - see section 2.10 for details.

Keyboard and mouse mode switching - The SmartView Multiscreen keeps a log of the keyboard and mouse mode and resolution settings requested by each of the connected PCs. These settings are automatically restored to the shared keyboard and mouse when the SmartView Multiscreen channel is switched thus ensuring maximum software compatibility. The keyboard num, caps and scroll lock states are an obvious example of this process.

2.10 Re-enabling a disconnected PS/2 mouse

If you disconnect the shared PS/2 mouse from the SmartView Multiscreen by accident during operation then the mouse operation will be lost when the mouse is plugged back in. To avoid having to reboot the entire system in this situation the SmartView Multiscreen is fitted with an automatic mouse recovery system.

With the PS/2 mouse disconnected, change the channel using the keypad or keyboard hotkeys. The SmartView Multiscreen detects that the mouse has been disconnected and triggers the automatic recovery system. Plug in the PS/2 mouse and the SmartView Multiscreen will re-initialise it.

Alternatively you can reset the keyboards and mice by holding down the front panel key for 5 seconds. When the character 'C' is displayed on the front of the SmartView

Multiscreen, press the front panel key again. A complete power off reset of the connected keyboards and mice will then be performed. This function only resets the shared keyboard and mice that are plugged into the control port. It does not affect the status of any of the other ports on the switch or the CPU connections.

2.11 Hot plugging the SmartView Multiscreen into running systems and re-enabling disconnected CPU PS/2 mouse connections

It is advisable to switch off the systems that are going to be connected to the SmartView Multiscreen before installation. However, if this is not possible then most systems can be hot plugged by using the SmartView Multiscreen's mouse restoration functions. The keyboard connection will normally restore itself automatically.

On many PCs, mouse movement will be lost if the PS/2 mouse is unplugged and plugged back in whilst the PC is running. Mouse movement can then only be restored by rebooting the PC. This is because the mouse drivers only setup and enable the mouse when the PC is initially booted.

If you have switched off your SmartView Multiscreen or you are attempting to 'hot plug' it into a system that is already running, you may be able to restore lost mouse movement using the SmartView Multiscreen's mouse restoration functions.

Mouse restoration functions should be used with care as unpredictable results may occur if the wrong mouse type is selected. If in doubt restore the mouse by powering down the PC normally.

Standard PS/2 mouse data uses a different data format to IntelliMouse data and so two reset functions are provided on the SmartView Multiscreen. The type of data format expected by the PC depends upon the driver and the type of mouse that was connected when the driver was booted. The following table may be used as a guide.

Note that the mouse reset functions predict the likely mouse resolution settings but may not restore the speed or sensitivity of the mouse exactly as they were when the PC originally booted.

Type of mouse / system Connected at bootup	Driver type	Likely expected data format	Suggested restoration
PS/2	PS/2 only	PS/2	F5
PS/2	IntelliMouse	PS/2	F5
IntelliMouse / SmartView MS	PS/2 only	PS/2	F5
IntelliMouse / SmartView MS	IntelliMouse	IntelliMouse	F6

To restore lost mouse movement on a CPU connected to the SmartView Multiscreen:

- 1) Select the CPU that has lost its mouse movement
- 2) Press the select key on the front of the SmartView Multiscreen for 5 seconds until 'C' is displayed. You are now in configure mode.
- 3) To restore a PS/2 mouse connection press

F 5 f

Or, to restore an IntelliMouse connection press

F 6 f

- 4) Exit from configure mode by typing

E f

- 5) Test the mouse movement by moving the mouse a short distance.

F5 - Restore PS/2 mouse function

F6 - Restore IntelliMouse function

2.12 Upgrading the SmartView's flash memory

The SmartView Multiscreen uses flash memory technology which enables the firmware code to be upgraded by the user. Upgrades are performed by connecting a PC's serial port to the SmartView's options port and running an upgrade program on the PC. This upgrade program downloads the new firmware to the SmartView and checks that the data has been programmed correctly.

To perform a firmware upgrade on your SmartView Multiscreen you will need a suitable serial upgrade cable and an IBM PC compatible computer with an RS232 serial port and an operating system that supports DOS. Upgrade cables may be purchased for Adder Technology or may be made using the wiring specification given in Appendix A4. You will also need to download the latest version of the SmartView Multiscreen firmware which is available free of charge at www.addertec.com.

To perform a flash upgrade on the SmartView Multiscreen:

Step 1 - Connect your computer to the SmartView

Connect your computer's serial port to the SmartView Multiscreen's options port (labelled OPTIONS/FLASH).

Step 2 - Select flash upgrade mode using option switch 7

Move option switch 7 on the underside of the SmartView Multiscreen to the ON position.

Step 3 - Reset the SmartView Multiscreen

Reset the SmartView Multiscreen by moving option switch 8 to the ON position (halt and reset) and then back to the OFF position (normal operation). Alternatively you may reset the SmartView by powering off all the attached computers and removing the optional power adapter.

Step 4 - Ensure that the SmartView is powered on

Ensure that the SmartView is powered on. It is normally possible to upgrade the SmartView when it is powered from a single computer, however it is good practice to ensure that there is the maximum possible power availability during flash upgrades and so if possible ensure that all the computers are powered on. The upgrade program monitors the SmartView's voltage and will not allow an upgrade to be performed if the voltage is insufficient.

The display should now show:

DISPLAY SHOWS

Lower case u

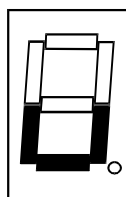

MEANING

**SmartView MULTISCREEN
is ready to be upgraded**

Step 5 - Run the upgrade program

The latest version of the SmartView Multiscreen firmware is available from the Adder Technology website at www.addertec.com. The SmartView Multiscreen uses the same firmware as the AdderView GEM product. The program and data files are supplied as a pair e.g.

AVG129.EXE AVG129.HEX

and should be downloaded to the same directory on your PC. Run the file AVGxxx.EXE (e.g. AVG129.EXE) and follow the on-screen instructions. During the upgrade the display will show an upper case U and the dot will flash to show that the upgrade is in progress.

DISPLAY SHOWS

Upper case U

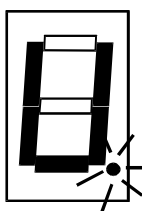

MEANING

**SmartView MULTISCREEN
is in flash upgrade mode**

**Flashing dot indicates
that data is being
received from the PC**

The display will again show a lower case U when the download is complete. Move option switch 7 to the OFF position to exit upgrade mode and start normal operation. You may check the new firmware version by entering configure mode and using the firmware version query function.

Some useful issues to bear in mind when performing flash upgrades

The upgrade program rewrites the SmartView's firmware code. If the upgrade process is interrupted then the SmartView will have invalid code and will not be able to operate. It is therefore good practice to ensure that the upgrade process is always fully completed. A partial or failed upgrade may be rectified by performing another upgrade. If the upgrade process is interrupted accidentally then you should immediately repeat the upgrade process without moving switch 7 from the flash upgrade (ON) position. Switch 7 forces the SmartView into flash upgrade mode and prevents the upgraded code from being run. Running faulty or partially upgraded code may have unpredictable results and may damage your SmartView or computing equipment. For obvious reasons, the code that the SmartView uses to perform upgrades is not itself upgradeable - a common problem on some flash upgradeable products that could effectively be destroyed by a partial upgrade!

WARNING - Running faulty or partially upgraded code may have unpredictable results and may damage your SmartView or computing equipment.

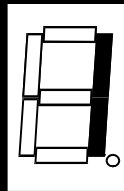
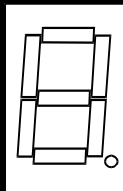

particularly useful in applications where the SmartView Multiscreen is located away from the desktop. The remote controller can be conveniently attached to your keyboard with a couple of Velcro strips to give instant channel information and key control.

3.3 Status display

The status display usually shows the currently selected port. If autoscan mode is selected, the segments will illuminate in sequence in a clockwise direction interspersed with a display of the currently selected channel. If SmartView Multiscreen has been locked, 'P' will be displayed until a valid password has been typed to unlock the unit. Data flow from the mouse or keyboard causes the dot to flash.

DISPLAY SHOWS

Channel number displayed and dot in lower right hand corner flashes (0 indicates SmartView is disabled)

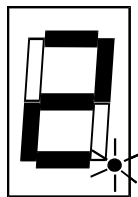

MEANING

Activity on keyboard or mouse

Illuminated segment shifts clockwise with port number shown after each scan round

Auto-scan mode - scanning from channel to channel at rate as programmed by user

3.4 Switching operation

When you select a port, your keyboard and mouse will control the computer that is connected to that port and the video feeds from that that computer will be displayed on the monitors. For example, if you select channel 2 then the video signal arriving at port 2A will be sent to the monitor that is attached to port A. Video arriving at ports 2B, 2C and 2D will be displayed on the monitors attached to ports B, C and D respectively.

3.5 Keyboard hotkey control

SmartView Multiscreen can be conveniently controlled by selecting channel, autoscan mode or security locking from the keyboard. All of the hotkey control commands are invoked by holding down the two hotkeys and then pressing a command key. By default, the two hotkeys are 'CTRL' and 'ALT', although other combinations can be selected by reconfiguring the hotkeys (see section 4.4). Once the hotkey command has been activated you will need to release the hotkeys and the command key before a new hotkey command is accepted by the SmartView Multiscreen. HOTKEYs + TAB is an exception and this allows you to 'tab through' the ports by holding down the hotkeys and repeatedly pressing TAB.

The hotkey command are summarised below (note that the numbers on the numeric keypad do not form part of a valid hotkey) :

'HOTKEYs' and '1' - selects channel 1

'HOTKEYs' and '2' - selects channel 2

'HOTKEYs' and '3' - selects channel 3

'HOTKEYs' and '4' - selects channel 4

'HOTKEYs' and 'TAB' - selects the next channel

'HOTKEYs' and 'A' - selects autoscan mode where each channel is displayed for the selected time (see section 4.2). To cancel autoscan mode simply select any fixed channel either by hotkey or using the SmartView Multiscreen button.

'HOTKEYs' and '0' – switches off the video signal and displays 0. This will cause some monitors to go into standby mode or switch off. The video signal can be re-enabled by selecting a channel.

'HOTKEYs' and 'L' - disables the SmartView Multiscreen's keyboard and mouse

and displays 0. The video signal is switched off. If a password has not been set then the SmartView Multiscreen can be re-enabled by selecting a channel. If a password has been set then the SmartView Multiscreen displays 'P' to indicate that a valid password must be entered to unlock the switch. Simply type the same key combination as was set during configuration (see section 4.7) followed by the (return) key. Note - if anyone has typed at the keyboard whilst in secure mode, it will be necessary to type (return) first to clear the invalid password, then type the valid password followed by (return) again.

Examples of common hotkey sequences (assuming CTRL + ALT hotkey option):

To select channel 2:

press **b a 2** release **2 b a**

To 'tab through' channels:

press **b a v** release **v** press **v**
release **v** press **v** release **v b a**

3.6 Mouse control

Computers may conveniently be selected using a three button mouse. In order to switch to the next computer simply hold down the central mouse button (the wheel mouse button on an IntelliMouse) and click on the left hand mouse button to select the next computer or the right hand mouse button to select the previous computer. If the SmartView has been set to scan active ports then the next or previous active channel will be selected. If it has been set to scan all ports then the next or previous numerical channel in sequence will be selected (see section 4.5 for more details). Mouse switching may be enabled or disabled by setting options during configuration (see section 4.3). When mouse switching is disabled the third button or wheel button state is 'passed through' the SmartView and seen by the application software.

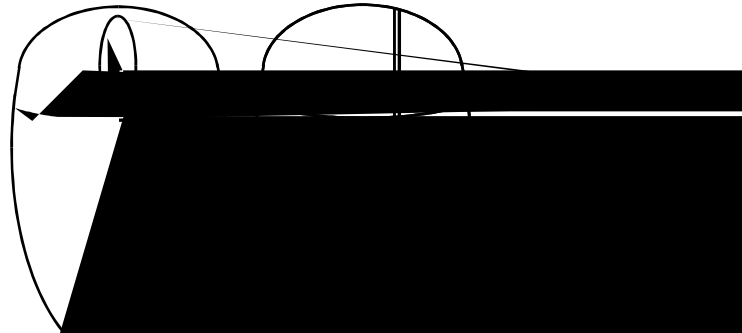
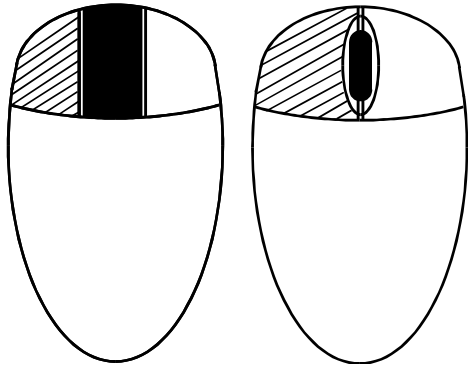

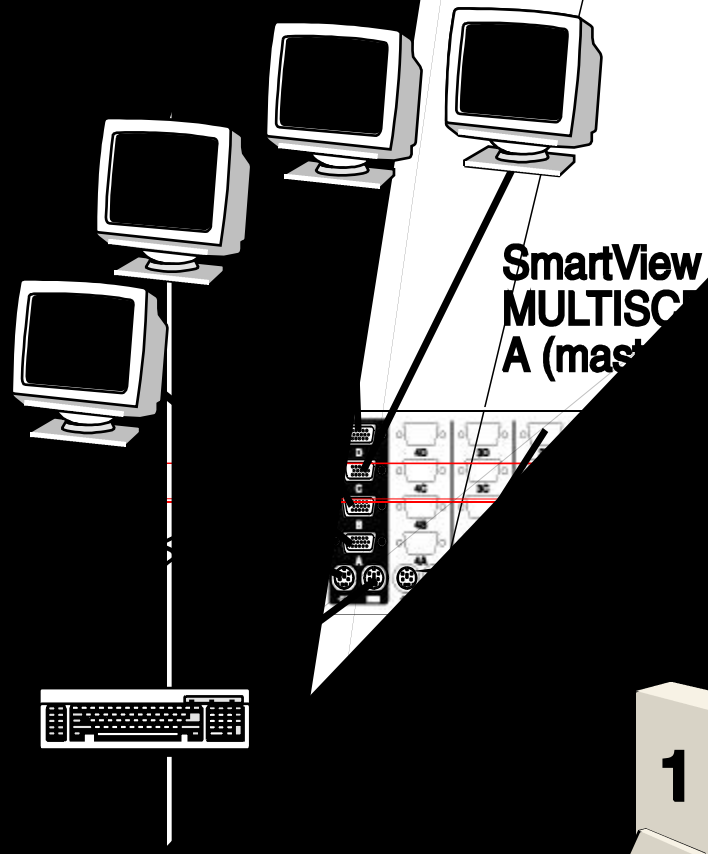

cascade of two SmartView Multiscreens

'2' of the first SmartView Multiscreen unit A.

For example to connect to port 3 on the SmartView Multiscreen cascaded off port 2 of your first SmartView Multiscreen use:

press **b a 2** release **2**

press **3** release **3 b a**

3.9 Synchronising SmartView Multiscreens for applications that require synchronised switching of more than four monitors

A single SmartView Multiscreen supports up to four monitors. For applications that require switching of more than four monitors, multiple SmartViews may be connected together so that they operate in a synchronised manner. Whenever the SmartView's channel is switched it sends an RS232 command out on its serial interface. The SmartView switches its channel if it receives the same command on its serial interface. Consequently, by linking the serial interfaces a master unit may be made to automatically switch a daisy chain of slaved units as shown in the diagram below. The slave units will require the optional power adapters because they cannot draw their power from the video link alone.

The SmartView Multiscreen may also be synchronised together with AdderView GEM products as their OPTIONS ports operate in the same way.

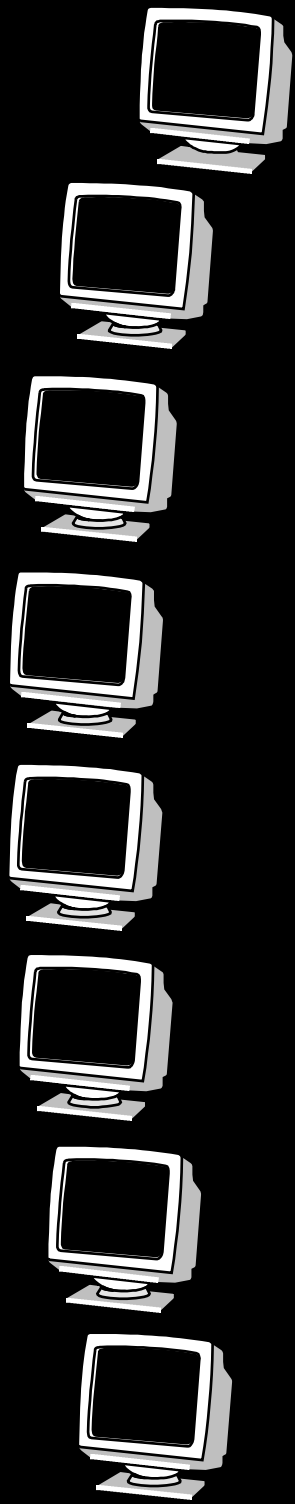

4. SmartView Multiscreen configuration options

All the options described in this section are entered in SmartView Multiscreen configure mode - see section 2.6 for instructions on entering configure mode.

4.1 Screen saver time delay

SmartView Multiscreen contains a programmable screen saver which will blank the display after the set time delay with no keyboard or mouse activity. Simply typing at the keyboard or moving the mouse will re-enable the display. The SmartView's 7-segment display will flash whilst the SmartView Multiscreen is in screen save mode.

- B1** - screen saver disabled (default)
- B2 - Blank screen after 1 minute of inactivity
- B3 - Blank screen after 2 minutes of inactivity
- B4 - Blank screen after 4 minutes of inactivity
- B5 - Blank screen after 8 minutes of inactivity
- B6 - Blank screen after 12 minutes of inactivity
- B7 - Blank screen after 16 minutes of inactivity
- B8 - Blank screen after 20 minutes of inactivity

4.2 Autoscan 'lock on' mode and delay time

SmartView Multiscreen can be set to select each channel in turn for a period of time set by the autoscan delay time. Autoscan mode is entered by typing the hotkey keys together with 'A'. By default, only those channels which have a powered up computer connected to them will be scanned. Sometimes it may be desirable to scan all channels, even if the attached computer is switched off (this will simply show a blank screen when it is selected). All the SmartView Multiscreen's ports will be scanned if option L2 is selected. Some applications may also require the SmartView Multiscreen to power on in autoscan mode. This feature can be selected using the L3 or L4 options.

- L1 - SmartView Multiscreen only locks on to active ports during autoscanning (default)
- L2 - SmartView Multiscreen locks on to every port in turn during autoscanning
- L3 - SmartView Multiscreen powers on in autoscan mode and locks on to active ports only
- L4 - SmartView Multiscreen powers on in autoscan mode and locks on to all ports

- T1 - 2 seconds autoscan delay time before switching to next port (default)
- T2 - 5 seconds autoscan delay time before switching to next port
- T3 - 7 seconds autoscan delay time before switching to next port
- T4 - 10 seconds autoscan delay time before switching to next port
- T5 - 15 seconds autoscan delay time before switching to next port
- T6 - 20 seconds autoscan delay time before switching to next port
- T7 - 30 seconds autoscan delay time before switching to next port
- T8 - 60 seconds autoscan delay time before switching to next port

Note: Autoscan mode is ended simply by selecting a fixed channel using the keypad, the keyboard hotkeys or the mouse.

WARNING - Many modern monitors are fitted with automatic power save relays and will switch off after a few seconds if connected to an inactive PC. If you are using such a monitor you must not use the L2 feature. Constant switching on and off of your monitor's relay will eventually damage your monitor.

4.3 Mouse mode and mouse switching of channels

A three button PS/2 mouse or an IntelliMouse can be used to switch channels on the SmartView Multiscreen. To switch to the next channel, the user simply holds down the central button or wheel button and presses the left or right hand button to change the channel (see section 3.6). If the user does not wish to take advantage of this feature, it can be disabled by selecting U2, U3 or U5. If the third button is being used to switch the SmartView Multiscreen then it is not available for use with PC software although the function of an IntelliMouse wheel is not affected. Consequently in modes U1, U2 and U4 the SmartView Multiscreen reports to the PCs that a 2 button mouse is connected. If you wish to use the full function of a 3 button mouse or IntelliMouse for your PC software then you should select options U3 or U5.

The SmartView Multiscreen supports 'Internet Mice' that are compatible with the Microsoft IntelliMouse. These are fitted with a wheel or other scroll control and sometimes have additional buttons.

Examples are:

- Microsoft IntelliMouse
- Logitech Pilot Mouse +
- Logitech MouseMan+
- Genius NetMouse
- Genius NetMouse Pro

Standard PS/2 and IntelliMouse compatible mice can be connected to the control port. You may configure your CPUs using Microsoft PS/2 or IntelliMouse drivers in any combination as required. The IntelliMouse features are supported on both PS/2 and RS232 CPU connections. When using PS/2 CPU connections, the SmartView Multiscreen will automatically configure itself to the type of mouse requested by the driver. If you are using RS232 CPU connections then you will need to select mouse options U4 or U5 to enable the IntelliMouse features.

U1 - SmartView Multiscreen channels are switchable using a 3 button mouse or IntelliMouse (default)

(SmartView Multiscreen reports 2 button mouse mode to PCs)

U2 - SmartView Multiscreen channels are not switchable using 3 button mouse or IntelliMouse

(SmartView Multiscreen reports 2 button mouse mode to PCs)

U3 - SmartView Multiscreen channels are not switchable using 3 button mouse or IntelliMouse

(SmartView Multiscreen reports 3 button mouse mode to PCs)

U4 - SmartView Multiscreen channels are switchable using 3 button mouse or IntelliMouse

(SmartView Multiscreen reports IntelliMouse mode to PCs)

U5 - SmartView Multiscreen channels are not switchable using 3 button mouse or IntelliMouse

(SmartView Multiscreen reports IntelliMouse mode to PCs)

4.4 Keyboard hotkey combination

The keyboard hotkey combination is used to change a channel, set autoscan mode or secure the product (so that the password needs to be typed before it can be used again). The following keyboard hotkey combinations can be selected. These hotkey combinations are used together with the command keys to trigger the required SmartView Multiscreen function. The left and right alt key combination is particularly suitable for extended keyboards where additional keys can be programmed to act as a combination of other keys. Such keyboards are supplied with some Gateway 2000 computers. Programming spare keys to trigger the hotkey combination allows channels to be selected via a single key stroke.

H1 - 'CTRL' and 'ALT' keys together (left or right hand keys operate) (default)

H2 - 'CTRL' and 'SHIFT' keys together (left or right hand keys operate)

H3 - 'ALT' and 'SHIFT' keys together (left and right hand keys operate)

H4 - 'RIGHT ALT' key

H5 - 'LEFT ALT' and 'RIGHT ALT' keys together

H6 - 'LEFT CTRL' and 'LEFT ALT' keys together

H7 - 'RIGHT CTRL' and 'RIGHT ALT' keys together

H8 - No hotkey enabled

4.5 Cycling between all channels or just the active channels

The SmartView Multiscreen can be set to cycle between all channels or just the active channels when using 'Hotkeys + Tab' or a three button mouse to switch the channel. This avoids wasting time viewing channels that are not active. Option are:

U7 – Cycle between all ports when switching with 'Hotkeys + Tab' or three button mouse (default)

U8 – Cycle between active ports only when switching with 'Hotkeys + Tab' or three button mouse

4.6 Firmware functions (version query, mouse restore and reset)

For technical support purposes, it may be necessary to find the firmware release version for the control software in your SmartView Multiscreen. For example, if the release version is v1.29 the response shown to **F 1 f** will be a brief display of the digit '1', then **F 2 f** will be a brief display of the digit '2', then **F 3 f** will be a brief display of the digit '9'. You can reset all of the configured options back to

the factory default states by typing **F 8 f** . Use options **F 5 f** and **F 6 f** to restore mouse function on disconnected PS/2 CPU mouse connections.

- F1 - Display firmware first digit (Note: F1 is **F** followed by **1** NOT **I**)
- F2 - Display firmware second digit
- F3 - Display firmware third digit
- F5 - Restore PS/2 mouse function to the currently selected CPU's mouse port
- F6 - Restore IntelliMouse function to the currently selected CPU's mouse port
- F8 - Reset all configurations to factory default settings. An 'r' will show briefly on the display to confirm that the reset has been completed.

4.7 Setting a security password

There are many situations where unrestricted access to corporate file servers or sensitive information needs to be controlled. In such circumstances, the SmartView Multiscreen can be locked away in a room or secure cabinet and controlled remotely. In this mode typing the keyboard hotkeys together with 'L' will blank the screen, disconnect the keyboard and mouse from all of the computers and display 'P' on the SmartView Multiscreen display. Control can only be regained by typing the correct password on the keyboard.

To set the password in configure mode, first type 'P' then (return). The display on SmartView Multiscreen will change to show '=' and you can then type your password. The password is not case sensitive and can be any combination of key strokes, including the function keys, but excluding the (ctrl), (alt), (shift) and (return) keys. When you have typed in your password type (return) to register it in the stored memory. Do not worry if you type the password incorrectly, you can always re-enter configure mode and set the password again. If you have lost the password and the SmartView Multiscreen is locked, the unit may be unlocked by powering down the SmartView Multiscreen, entering configure mode at power on (see section 2.6), and performing a complete reset using the F8 function.

NOTE - The password consists of a combination of key strokes rather like the code to a safe. The key strokes are not case sensitive and can include all the keys on the keyboard (except ctrl, alt, shift and enter). Consequently the following 'password' would be valid:

o F R E D g

4.8 Cascade query code

The SmartView Multiscreens use a special 'query code' to detect whether or not they are connected to another SmartView Multiscreen. By default your SmartView Multiscreen uses query code AD. SmartView Pro (another range of keyboard / mouse / video switches from Adder Technology) units with firmware versions less than 1.09 used query code EF. This was found to conflict with a small number of other (rare) devices that used the same query code so an alternative query code was provided to ensure compatibility. Either query code may be used but you should make sure that all cascaded SmartView Multiscreen and SmartView Pro units are set to use the same query code. If any of the cascaded SmartView Pros have firmware versions less than 1.09 then the cascade query code for all the SmartView Multiscreens and SmartViews should be set to EF.

L7 – Cascade query code = AD (default)

L8 – Cascade query code = EF

4.9 Resolving slow mouse problems

Due to certain technical reasons some systems running particular combinations of operating system and mouse drivers are sensitive to small timing changes relating to mouse communications. The introduction of a switch like the SmartView inevitably causes some timing changes and in rare cases interactions have been observed that causes the mouse to run very slowly. Certain HP Vectra computers running later versions of Windows NT with Logitech mouse drivers and Logitech mice have been observed to exhibit such interactions with older switches. One solution to this problem is to change the mouse driver.

The SmartView Multiscreen is a high performance device that is carefully engineered to minimise such interactions and should not exhibit this characteristic. Nevertheless such interactions are unpredictable and so the SmartView is fitted with a feature that ensures that the mouse can never operate at a very slow rate regardless of such interactions. This feature is activated using the following options:

L5 – Allow the mouse to run at any speed (default)

L6 – Don't allow the mouse to run at very slow speeds

4.10 Exit configure mode

When you have finished configuring any special options, simply type 'E' followed by (return) to exit configure mode and return to normal operation mode. The attached computers can now be switched on.

Appendix A. Cable and connector specifications

IMPORTANT NOTE

The maximum cable lengths supported vary widely between devices and cables. It may be possible to use cables that are longer than those specified below with certain PCs and peripherals but this cannot be guaranteed. If you experience problems try using shorter cables.

A1. Keyboard, monitor and mouse to SmartView Multiscreen

All of the shared devices plug directly into the relevant ports at the rear of the SmartView Multiscreen. If you use an AT style keyboard you will need an AT (5 pin DIN female) to PS/2 (6 pin mini-DIN male) converter.

Cable specification (self-powered operation):

Keyboard, monitor and mouse cables should be no longer than 2 metres.

Cable specification (with optional power adapter):

Keyboard, monitor and mouse extension cables can be used to increase the distance from SmartView Multiscreen up to 10m. Most keyboards and mice will also operate at distances of 20 metres.

A2. SmartView Multiscreen to PCs 1 to 4

Cable specifications:

Video - 15 pin high density male D connector to 15 pin high density male D connector wired as a standard VGA PC to monitor cable. There are two types commonly available. The best type cables which will give excellent quality are constructed with coaxial cable cores. Cheaper 'data' cables are often used, but can degrade video quality if used over longer distances. Avoid using 'data' cables longer than 2 metres unless the video quality is not important. Good quality coaxial video cables may be run at distances up to 30 metres with little loss of video quality. If you

wish to make use of the DDC (Display Data Channel) capabilities of the SmartView Multiscreen then you will need to use cables that have the DDC signalling lines connected (pins 12 and 15 on the 15-way video connector). Not all video cables have these DDC lines connected.

Keyboard and PS/2 mice - 6 pin mini-DIN male connector to 6 pin mini-DIN male connector with all lines connected straight through (1-1,2-2 etc.). If the PC has a 5-pin DIN AT style keyboard connector you will need a PS/2 to AT keyboard adapter 6-pin mini-DIN female to 5-pin DIN male (readily available). For 'interface powered' operation without the optional power adapter the cables should be no longer than 5 metres (see section 2.4 for more details). For operation with the power adapter, cables should be no longer than 30 metres.

RS232 serial mice - these require a special converter to connect the RS232 lines present on the SmartView Multiscreen mouse ports to the RS232 port on a PC.

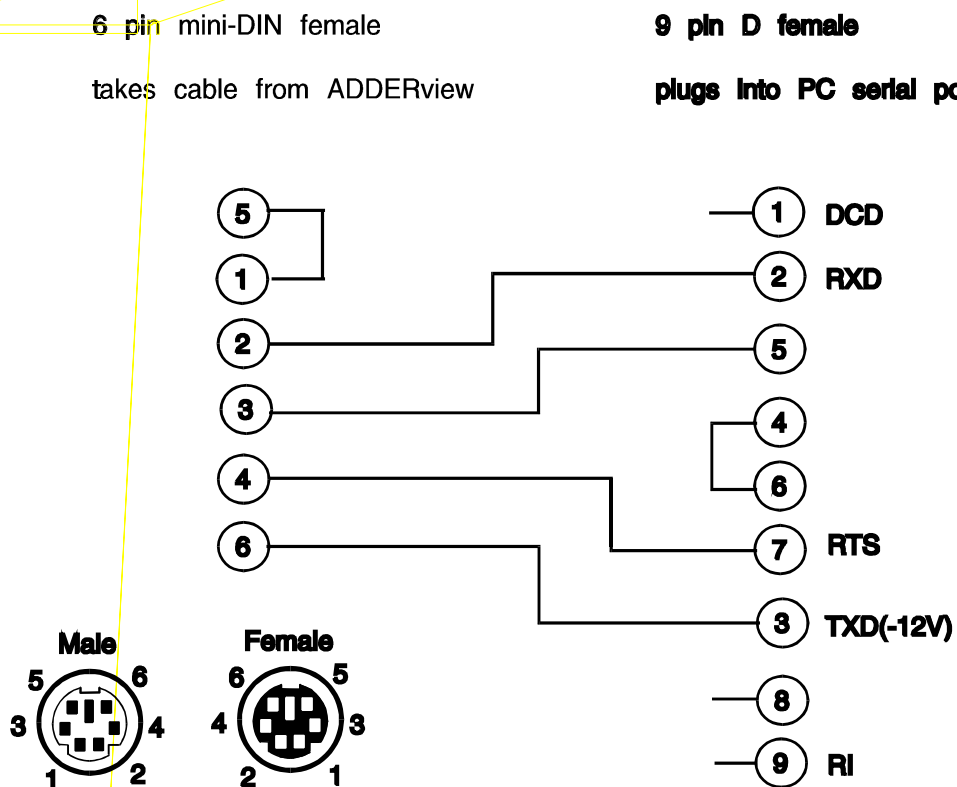

NOTE - There are several common wiring specifications for 6-pin mini-DIN to 9-pin serial adapters. If you have an adapter that has been supplied with a mouse it may have a completely different internal wiring to that shown above and may not be compatible with the SmartView

Recommended cables:

3-in-1 keyboard, video and mouse combination cable - For convenience, neatness and high video quality we recommend the Adder brand 3-in-1 combination cables for the keyboard, mouse and first video head connections. These cables are constructed with tri-coax video links to ensure that high video quality is maintained. They also support DDC signalling and are colour coded in PC99 specification colours for your convenience. These match the colours used on the back of your SmartView Multiscreen and most modern PCs. These cables are available in various different lengths to suit your requirements. They may be purchased with or without the adapters for AT keyboards and RS232 serial mice. Please quote the following part codes when ordering from your supplier.

Part code	Description	Length
VKVM-2M	3-in-1 Adder cable	2 metres
VKVM-2M-AT	3-in-1 Adder cable, with AT and serial adapters	2 metres
VKVM-5M	3-in-1 Adder cable	5 metres
VKVM-5M-AT	3-in-1 Adder cable, with AT and serial adapters	5 metres
VKVM-10M	3-in-1 Adder cable *	10 metres
VKVM-10M-AT	3-in-1 Adder cable, with AT and serial adapters *	10 metres

* The optional power adapter may be required (see section 2.4).

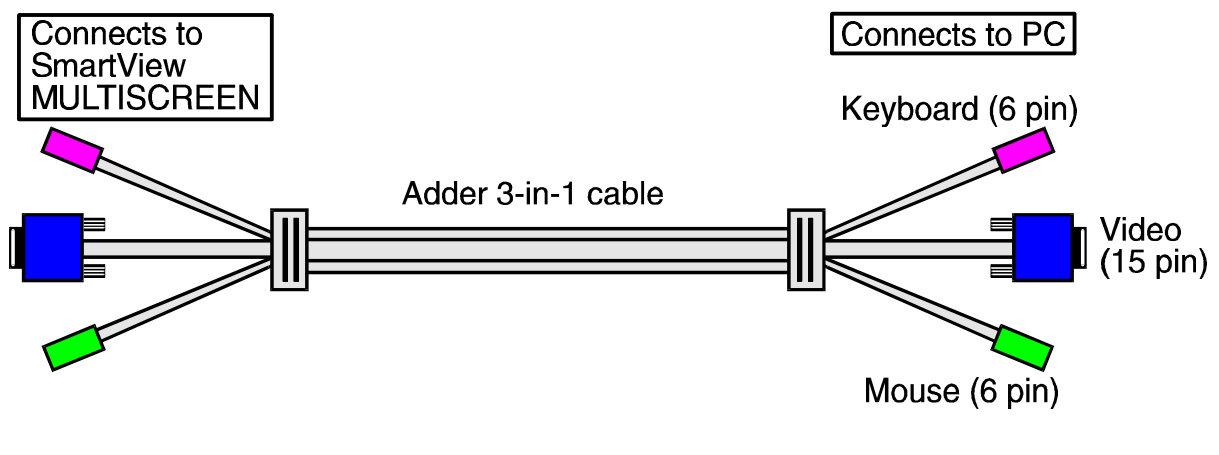

A3. Options port pin assignments

The 15 way D connector located on the back of the SmartView Multiscreen (labelled OPTIONS / FLASH) provides connections for the remote control module and allows an external RS232 device to control the SmartView Multiscreen. See section 3.7 for more details.

Pin 9 = GND

Pin 10 = TXD

Pin 11 = RXD

Other pins to be left unconnected

A.4 Flash upgrade cable connection

The cable connections shown below are to connect either COM1 or COM2 of a PC to the SmartView Multiscreen to allow flash upgrades.

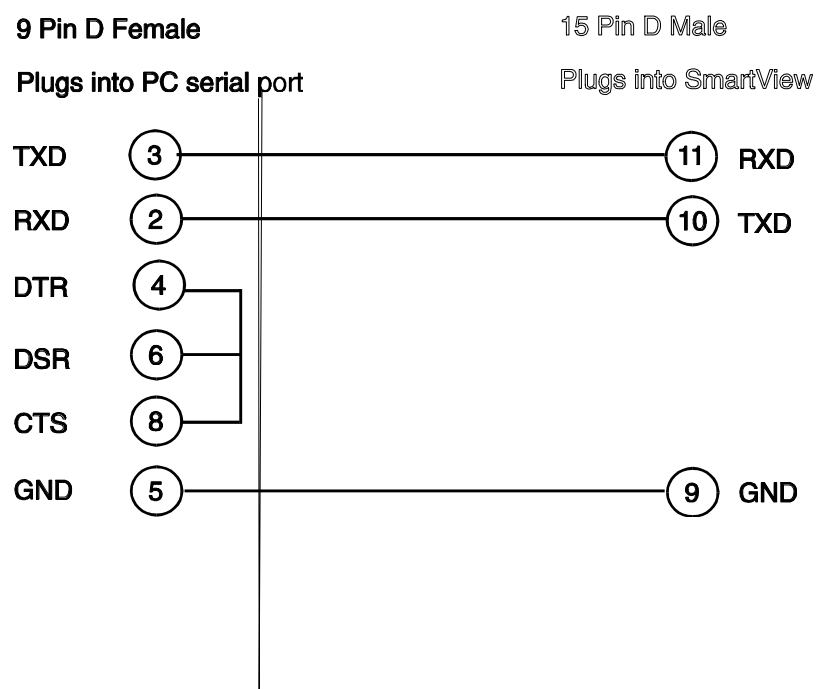

A.5 RS232 synchronisation cable pin assignments

The cable connections shown below are to connect two SmartView Multiscreens together for synchronised operation (see section 3.9)

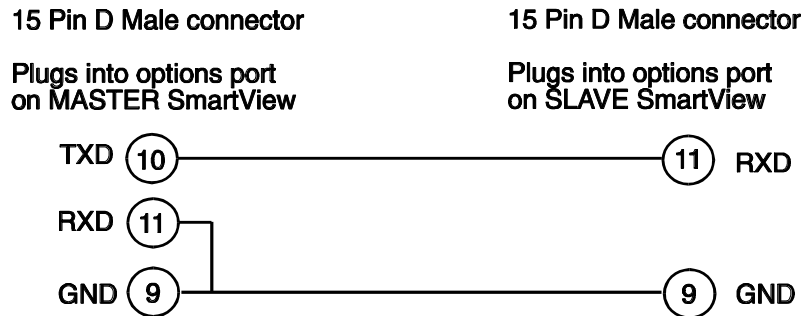

Appendix B. Problem Solving

Problem:

Poor video quality with smearing fuzziness or ripple.

Action:

Use screened coaxial video cables to connect your devices to the SmartView Multiscreen.

Problem:

Mouse does not move cursor on screen.

Action:

Ensure that the mouse and computer are both connected to SmartView Multiscreen before power is connected and ensure that the SmartView Multiscreen is powered on before the attached computer. Ensure that your software is configured to accept a Microsoft compatible mouse of the type that you have connected (PS/2 or RS232). If you move the mouse and the activity indicator (dot on 7 segment display) does not flash then the SmartView Multiscreen is not receiving data from the mouse. Check the mouse connection to the SmartView Multiscreen, try resetting the mouse using the reset function (section 2.10) or re-powering the SmartView Multiscreen. If you are attempting to connect the SmartView Multiscreen to a CPU with a PS/2 mouse connection that has not been powered down then you will need to use the mouse restoration functions F5 or F6 (see section 2.11).

Problem:

Keyboard does not function or functions intermittently. Num lock light does not always come on when the num lock key is pressed.

Action:

Some older keyboards were designed for use with specific computers and are not truly AT or PS/2 compatible. These are not common but if you experience problems try another keyboard.

Problem:

Mouse causes channel to change.

Action:

Some cheaper mice are not fully compatible with the SmartView Multiscreen and can lose data causing the channel to be changed (if mouse switching of channels is enabled). If you experience this problem then change the mouse and use a Microsoft, Logitech, IBM, Compaq or Hewlett-Packard type. Ensure that you are using a Microsoft compatible mouse driver on your PC. Some other manufacturers' drivers may switch the mouse to use a proprietary mouse data format not supported by the SmartView Multiscreen. If you have unplugged and re-connected a mouse to the SmartView Multiscreen then ensure that you reset it using the mouse reset function (see section 2.10).

Problem:

Mouse jumps around the screen after disconnecting the mouse cable or powering down the SmartView Multiscreen.

Action:

If you have disconnected and re-connected a CPU mouse cable or you have powered down the SmartView Multiscreen then the mouse data format may be out of synchronisation with that required by the PC (PS/2 or Intellimouse). Try the 'restore Intellimouse' function (F6) to resolve the problem or re-power the CPU.

Problem:

Mouse moves very slowly but otherwise functions correctly.

Action:

Change the mouse driver to a Microsoft type or take the action recommended in section 4.9.

SMART *View*

MULTISCREEN

INSTALLATION & USE

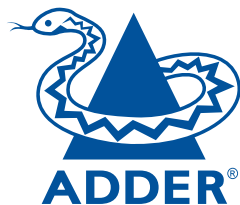

ADDER Technology Limited

Technology House

Trafalgar Way

Bar Hill

Cambridge

CB3 8SQ • England

T: +44 (0) 1954 780044

F: +44 (0) 1954 780081

sales@addertec.com

www.addertec.com

Free Manuals Download Website

<http://myh66.com>

<http://usermanuals.us>

<http://www.somanuals.com>

<http://www.4manuals.cc>

<http://www.manual-lib.com>

<http://www.404manual.com>

<http://www.luxmanual.com>

<http://aubethermostatmanual.com>

Golf course search by state

<http://golfingnear.com>

Email search by domain

<http://emailbydomain.com>

Auto manuals search

<http://auto.somanuals.com>

TV manuals search

<http://tv.somanuals.com>