

OPERATION GUIDE

1F95-80

7 Day Multi-stage Electronic Digital
Thermostat with Programmable Fan



WHITE-RODGERS

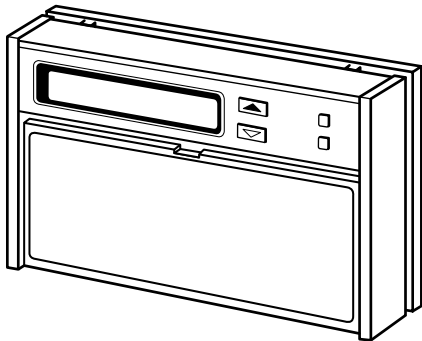

Operator: Save this booklet for future use!

About Your New Thermostat . . .

Your new Digital COMFORT SET II Multi-stage Thermostat uses the technology of a solid-state microcomputer to provide precise time/temperature control. The COMFORT SET II Thermostat offers you the flexibility to design heating and cooling programs that fit your needs.

Please read this manual thoroughly before operating or programming your thermostat. If you have questions, you may write to our Technical Service Department at the address shown on the back cover of this booklet.

In This Guide . . .

| | | |
|---|----|--|
| YOUR NEW THERMOSTAT'S FEATURES | 4 | Program Heating and Cooling Temperatures |
| OPERATING YOUR THERMOSTAT | 5 | Enter Heating Program |
| PARTS OF THE THERMOSTAT | | Enter Cooling Program |
| The Back Of the Thermostat Body | | Using the COPY Button |
| The Display | | CHECK YOUR PROGRAMMING |
| The Thermostat Buttons | | QUESTIONS AND ANSWERS |
| OPERATING FEATURES | | 32 |
| PROGRAMMING YOUR THERMOSTAT | 18 | |
| PLANNING FOR YOUR NEEDS | | |
| ENTERING YOUR PROGRAM | | |
| Set Current Time and Day | | |

Operator: Save this booklet for future use!

YOUR NEW THERMOSTAT'S FEATURES

- Computed Energy Management Recovery (EMR)
- Automatic changeover
- Two hour temperature override
- Manual program override (HOLD temperature)
- °F/°C convertibility
- Keypad lockout (optional)
- Simultaneous heat and cool program storage
- Two separate time and two separate temperature settings per 24-hour period
- Backlit LCD displays continuous set point, time, and room temperature
- Adjustable cycle times
- 9 volt Energizer® alkaline battery backup
- Compressor short cycle protection
- Blower delay in the cooling cycle
- Up to 2 stages of heat and up to 2 stages of cool
- Initial total system checkout
- Preprogrammed temperature control
- Separate setback programming for 7 independent days
- Electric heat (optional)
- Audio and visual prompting for programming
- Armchair programming capability
- Programmable blower control
- Temperature range 40° to 99°F
- Compatible with Remote Sensor (optional)

OPERATING YOUR THERMOSTAT

Before you begin programming your thermostat, you should be familiar with its features and with the display and the location and operation of the thermostat buttons. The information in this section will help you become familiar with your new thermostat so that you can easily program it.

Your thermostat consists of two parts: the **thermostat body** and the **subbase**.

CAUTION

Use  to turn thermostat to **OFF mode before removing or attaching the thermostat body. Failure to do so may result in equipment damage and/or personal injury.**

The subbase is attached to the wall, but you can remove the thermostat body for easy programming. To remove the thermostat body from the subbase, grasp the thermostat body and gently pull it straight out from the subbase. To attach the thermostat body, line up the four terminal pins on the upper section of the thermostat back with the matching connector on the subbase. Insert these, then gently pivot the thermostat body down to connect the eight pin connectors on the lower portion of the thermostat back. Gently push until the snap connectors engage. **DO NOT FORCE OR PRY THE THERMOSTAT** as this may damage the unit.

PARTS OF THE THERMOSTAT

The Back of The Thermostat Body

Turn the thermostat body over. On the back are the 9 volt Energizer® alkaline battery and the option switches.

1. The 9 volt Energizer® alkaline battery provides power to the thermostat when the 24VAC power is interrupted (for example, when you remove the thermostat from the wall for programming) A fresh battery will maintain the stored program for approximately a week. If power loss is long enough for the program to be lost, the thermostat will automatically return to the factory pro-



grammed temperatures (64°F heating and 82°F cooling) when power is restored. You must reprogram the thermostat if this happens.

If the word **BATTERY** is flashing in the display window, the battery is low and should be replaced with a fresh 9 volt Energizer® alkaline battery. The battery will provide power for all functions except the display light and audio prompting beep, which work only on 24VAC power.

CAUTION

Use  to turn thermostat to **OFF mode before removing thermostat from the wall to replace the battery.**

2. You may adjust the option switches for keypad lockout (see **OPERATING FEATURES**).

The buttons (other than  and ) are located behind the thermostat door. To open the door, use your fingernail in the indentation at the top center of the door. Pull the door out, then swing the door down on its hinges.

Following are brief descriptions of the display and the thermostat buttons.

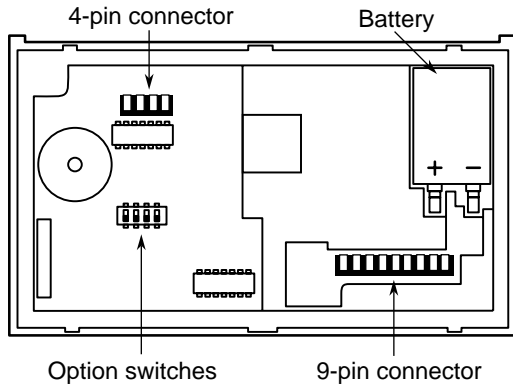



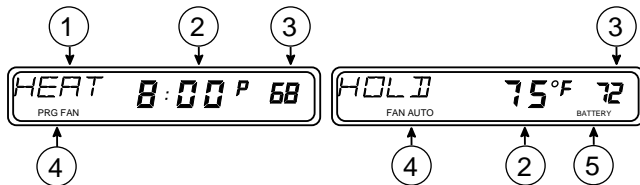
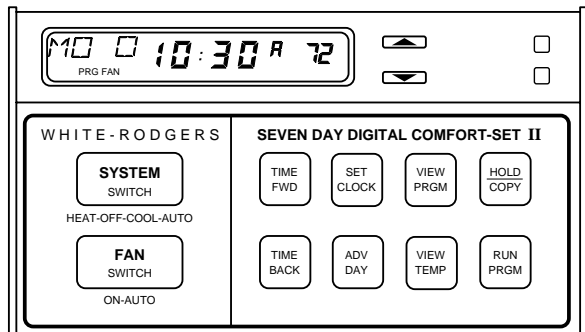

BACK OF THERMOSTAT BODY

The Display

- ① Continuously displays system mode (**HEAT, OFF, COOL, AUTO, HOLD**). During programming, the day of the week is displayed (**MO, TU, WE**, etc.).
- ② Alternately displays room temperature (**F** denotes degrees Fahrenheit and **C** denotes degrees Celsius) and time of day (**A** denotes AM time and **P** denotes PM time).
- ③ Displays the setpoint temperature.
- ④ When **VIEW TEMP** button is pressed, **O** is displayed when the setpoint temperature displayed (at the far right) is the occupied heating or cooling temperature (depending on mode). **U** is displayed when the unoccupied heating or cooling temperature is being displayed.
- ⑤ **FAN AUTO** is displayed during automatic fan operation (when the blower cycles with the heating or cooling system). **PRG FAN** is displayed when the fan has been programmed to run continuously during the program period.
- ⑥ The word **BATTERY** flashes on the display when the 9 volt alkaline battery power is weak and the battery should be replaced.



The Thermostat Buttons

- ⑦ Sets the system mode (**HEAT**ing, **OFF**, **COOL**ing, or **AUTO**matic changeover).
- ⑧ Selects fan operation (see #5, above). This button is also used to program the fan to run continuously during a program period.
- ⑨ Runs display forward or backward through time, day, or anticipation settings during programming.
- ⑩ Used in conjunction with  and  to set current time and day of the week.
- ⑪ Used during programming to set the day of the week to be programmed.
- ⑫ Used to initiate programming or to review programming for a given day (program viewing automatically begins with Monday's program; use **ADV DAY** button to view programming for following days).
- ⑬ Used in conjunction with  and  to select setpoint temperatures.
- ⑭ Used to manually override programming to hold at a selected temperature (when **HOLD** is displayed). Also used to copy one day's programming to another day (when **COPY** is displayed).
- ⑮ Used to start program operation after programming. Also used to return thermostat to program operation after being in **HOLD** mode.
- ⑯ (Red arrow) Raises temperature setting (99°F or 37°C maximum).
- ⑰ (Blue arrow) Lowers temperature setting (40°F or 4°C minimum).

18 Red indicator is lit whenever heating or cooling is in operation. Yellow indicator is lit

whenever the second stage of heating or cooling is in operation.

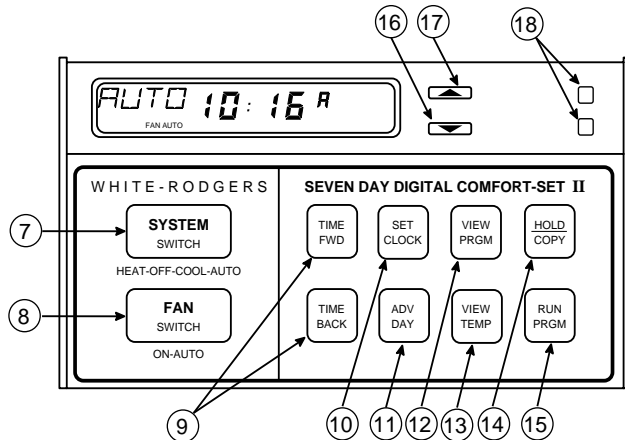

OPERATING FEATURES

Now that you are familiar with the thermostat display and buttons, read the following information to learn about the many features of the thermostat.

- **COMPUTED ENERGY MANAGEMENT RECOVERY (EMR)** — The thermostat's microcomputer automatically calculates the time it will take to change the temperature to the next program setting. Then the thermostat will activate the heating or cooling system to change the temperature so that the desired temperature is reached at the beginning of the next program period. As an example of this feature, assume that you have programmed your thermostat to provide an overnight heating temperature

of 62°F, and that during the next program period, beginning at 6:00 AM, you have programmed a temperature of 70°F. The thermostat will automatically activate the heating system at about 5:00 AM, so that the programmed 70°F temperature is reached by about 6:00 AM.

This feature is enabled by option switch #3. To **enable** the EMR function, you must move option switch #3 (located on the back of the thermostat body) to the **ON** position.

To do this, press  until **OFF** is displayed on the thermostat. Remove the thermostat body from the wall, turn it over, and check the position of option switch #3. If the switch is **ON** (up), simply put the thermostat back on the wall and press



 until the desired operating mode is

displayed. If the switch is **OFF** (down), use a pencil or small screwdriver to move the switch to the **ON** position (see figure below). Remove the battery for at least two minutes, to allow the thermostat to reset itself. Replace the battery and put the thermostat back on the wall. Press  until the desired operating mode is displayed.

EMR (ON)



Switch #1 set at installation (**DO NOT CHANGE**)
Switch #2 set at installation (**DO NOT CHANGE**)
Switch #3 **ON**
Switch #4 (see **TOTAL KEYPAD LOCKOUT**)

To **disable** EMR, press  until **OFF** is displayed. Remove the thermostat body from the wall and use a pencil or small screwdriver to move option switch #3 to the **OFF** (down) position. Remove the battery and allow at least two minutes for the thermostat to reset itself. Replace the battery, press  until **OFF** is displayed, then replace the thermostat on the wall. Press  until the desired operating mode is displayed.



- **AUTOMATIC CHANGEOVER** — If your thermostat was configured for this option at installation, you can set the thermostat to automatically switch the system from heating to cooling as needed. Press  to set the thermostat to **AUTO** (the

setpoint display is blank in the **AUTO** mode). The system will now automatically switch between heating and cooling depending on the actual room temperature.

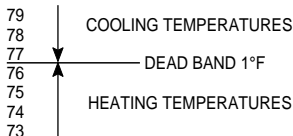

NOTE



If the thermostat is configured for automatic changeover, the thermostat will not allow the temperature separation between the highest heat setting and the lowest cool setting to be less than 1°F. For example, if the highest heat setting is 76°F, the lowest cool setting cannot be below 77°F (see diagram below).









- **TWO HOUR TEMPERATURE OVERRIDE** — Press  or  until the display shows the temperature you want. The thermostat will override current programming and keep the room temperature at the selected temperature for two hours. After two hours, the thermostat will automatically revert to the program.

NOTE

This feature will not work in the **AUTO** mode. Therefore, we do not recommend using the temperature override feature when the thermostat is in the **AUTO** mode. Pressing  or  in the **AUTO** mode will cause the thermostat to revert to the mode (heat or cool) in which it was last cycled before switching to the **AUTO** mode and will prevent automatic switching for









two hours. If you do press  or  in the **AUTO** mode, you may press  to return to programmed operation in the **AUTO** mode.

- **HOLD TEMPERATURE** — The thermostat can hold any temperature within its range for an indefinite period, without reverting to the program. Press . **HOLD** will be displayed. Then choose the desired hold temperature by pressing  or . The thermostat will hold the room temperature at the selected setting until you press  to start program operation again. This feature is ideal for energy conservation when the building is unoccupied for an extended period of time.

- **°F/°C CONVERTIBILITY** — Press  and  at the same time until the temperature display is in °C (Celsius). To display °F, repeat the process.
- **ADJUSTABLE HEATING AND COOLING CYCLE TIMES (ANTICIPATION)** — If the heating/cooling system is turning on and off too often (short cycles) or not often enough (long cycles), you may want to adjust the anticipation setting.



 **CAUTION**

A cooling anticipation setting of less than 10 may cause decreased compressor life.

To adjust anticipation, press  and  at the same time. The display will show **HEAT 5** (this is the factory preprogrammed heating anticipation setting). You may select any anticipation setting from 4 to 40. If the heat cycles are too short, press  to increase the cycle time. If the heat cycles are too long, press  to decrease the cycle time. To set cooling anticipation, press  and  at the same time again. The display will show **COOL 14** (factory preprogrammed cooling anticipation). Press  or  to adjust anticipation. Press  to return to your program.

- **LOW BATTERY INDICATOR** — The word **BATTERY** will flash on the display if the 9 volt alkaline battery is low and should be replaced.
- **AUDIO PROMPTING** — Each time you press a button, the thermostat will beep (this feature works only when the thermostat is attached to the wall and 24VAC power is present to the thermostat).
- **BACKLIT DISPLAY** — When you press any button on the thermostat, the display is lit for approximately eight seconds (this feature works only when the thermostat is attached to the wall and 24VAC power is present to the thermostat).
- **COMPRESSOR SHORT CYCLE PROTECTION** — To protect your compressor from potential damage due to rapid cycling, this thermostat has a built-in delay of

5 minutes between cooling cycles. The following may cause a time delay in **COOL**:

- Return of power after a power outage.
- Pressing  to change operating modes.
- Pressing  or , creating a call for **COOL** too soon after a previous call.

- **SYSTEM INDICATOR LIGHTS** — The red indicator light comes on whenever the heating or cooling system is operating. The yellow indicator light comes on when the second stage of heating or cooling is operating.
- **TOTAL KEYPAD LOCKOUT** — When option switch #4 is in the total keypad lockout position (**ON**), programs cannot be altered and all buttons are disabled.

NOTE

Programming should be completed and battery should be installed **before** changing option switch #4.

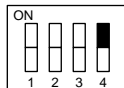

TOTAL KEYPAD LOCKOUT (ON)



Switch #1 set at installation (**DO NOT CHANGE**)
Switch #2 set at installation (**DO NOT CHANGE**)
Switch #3 (see **EMR**)
Switch #4 **ON**

Switches #1 and #2 are set at installation and should not be changed. To enable total keypad lockout, move option switch #4 to **ON**. To disable total keypad lockout, move option switch #4 to **OFF**.

- **PROGRAMMABLE BLOWER CONTROL** — You may program the fan blower to run continuously during any given program period, regardless of the cycling of the heating or cooling system. During programming, after entering the time and tem-

perature for the time period, press  until **PRG FAN** appears. To override constant fan, press  until **FAN AUTO** appears.

PROGRAMMING YOUR THERMOSTAT

Now you are ready to program your thermostat. This section will help you plan and program your thermostat to meet your needs. For maximum comfort and efficiency, keep the following guidelines in mind when planning your program.

- When heating (cooling) your building, program the temperatures to be cooler (warmer) when the building is vacant or during periods of low activity.

- During early morning hours, the need for cooling is usually minimal.

PLANNING FOR YOUR NEEDS

First, answer the following questions to help you decide what your needs are.

- 1a. What time does the first person arrive at the building in the morning?

- b. What temperature should the building be at this time? (heating? cooling?)
- 2a. What time does the building become vacant?
- b. What temperature should the building be at this time?

Now look at the factory preprogrammed times and temperatures shown below. If this program will suit your needs, simply press  to begin running the factory preset program.

| FACTORY PREPROGRAMMING | | | | |
|---|---------|------|------|--------|
| Heating Program for ALL days of the Week: | | | | |
| PERIOD | TIME | TEMP | FAN | DAMPER |
| Occupied (O) | 8:00 AM | 70 | PRG | Open |
| Unoccupied (U) | 5:00 PM | 64 | AUTO | Closed |
| Cooling Program for ALL days of the Week: | | | | |
| PERIOD | TIME | TEMP | FAN | DAMPER |
| Occupied (O) | 8:00 AM | 78 | PRG | Open |
| Unoccupied (U) | 5:00 PM | 82 | AUTO | Closed |

If you want to change the preprogrammed times and temperatures, do the following.

Determine the heating and cooling times and temperatures you want to use. Use the following table to plan your program time periods and temperatures. You may also want to look at the sample program table to get an idea of how the thermostat can be programmed. You may select up to two heating temperatures (**HEAT O** for occupied temperature and **HEAT U** for unoccupied temperature), and up to two cooling temperatures (**COOL O** and **COOL U**).

NOTE

To operate properly in the **AUTO** mode, there must be a **minimum 1°F separation** between the highest heat temperature and the lowest cool temperature.

Heating/Cooling Schedule Plan

| | Heating Program | | | | Cooling Program | | | |
|------------------|----------------------------|------------------------|------------------------------|--------------------------|----------------------------|------------------------|------------------------------|--------------------------|
| | Occupied Period Start Time | Occupied Heating Temp. | Unoccupied Period Start Time | Unoccupied Heating Temp. | Occupied Period Start Time | Occupied Cooling Temp. | Unoccupied Period Start Time | Unoccupied Cooling Temp. |
| Monday | | | | | | | | |
| Tuesday | | | | | | | | |
| Wednesday | | | | | | | | |
| Thursday | | | | | | | | |
| Friday | | | | | | | | |
| Saturday | | | | | | | | |
| Sunday | | | | | | | | |

NOTE: Damper operation is linked to occupied or unoccupied **temperature settings**, not time periods. If you program an unoccupied temperature during an occupied time period, the damper will not operate during that occupied period. We suggest programming occupied temperatures only during occupied time periods, and unoccupied temperatures during unoccupied time periods.

SAMPLE Heating/Cooling Schedule Plan

Joe's Restaurant
Open: Mon-Sat 10:00 AM to 9:30 PM
Sun 12:00PM to 6:00 PM

| | Heating Program | | | | Cooling Program | | | |
|------------------|----------------------------|------------------------|------------------------------|--------------------------|----------------------------|------------------------|------------------------------|--------------------------|
| | Occupied Period Start Time | Occupied Heating Temp. | Unoccupied Period Start Time | Unoccupied Heating Temp. | Occupied Period Start Time | Occupied Cooling Temp. | Unoccupied Period Start Time | Unoccupied Cooling Temp. |
| Monday | 9:30 AM | 73°F | 10:00 PM | 62°F | 9:30 AM | 74°F | 10:00 PM | 79°F |
| Tuesday | 9:30 AM | 73°F | 10:00 PM | 62°F | 9:30 AM | 74°F | 10:00 PM | 79°F |
| Wednesday | 9:30 AM | 73°F | 10:00 PM | 62°F | 9:30 AM | 74°F | 10:00 PM | 79°F |
| Thursday | 9:30 AM | 73°F | 10:00 PM | 62°F | 9:30 AM | 74°F | 10:00 PM | 79°F |
| Friday | 9:30 AM | 73°F | 10:00 PM | 62°F | 9:30 AM | 74°F | 10:00 PM | 79°F |
| Saturday | 9:30 AM | 73°F | 10:00 PM | 62°F | 9:30 AM | 74°F | 10:00 PM | 79°F |
| Sunday | 11:30 AM | 73°F | 6:30 PM | 62°F | 11:30 AM | 74°F | 6:30 PM | 79°F |

NOTE: In the above sample program, the fan will be programmed to run continuously (PRG FAN) during periods with occupied temperatures, and will be programmed for automatic cycling (FAN AUTO) during periods with unoccupied temperatures. In your programming, you may choose automatic fan operation (FAN AUTO) or continuous fan operation (PRG FAN) during both occupied and unoccupied periods.

Download from [Www.Somanuals.com](http://www.Somanuals.com). All Manuals Search And Download.

ENTERING YOUR PROGRAM

Follow these steps to enter the heating/cooling program you have selected.

NOTE



We recommend that you remove the thermostat from the wall for programming (especially for entering cooling programming). A fresh 9 volt Energizer® alkaline battery must be installed to perform off-wall programming. **BE SURE SYSTEM SWITCH IS SET TO OFF POSITION BEFORE REATTACHING THERMOSTAT TO SUBBASE!**

You cannot program the thermostat with the **SYSTEM SWITCH** in the **AUTO** position.

Set Current Time and Day



1. Press  once. The display will show minutes only.



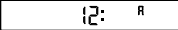

EXAMPLE: 

2. Press and hold either  or  until you reach the correct minutes.

3. Press  once. The display window will show the hour only.



EXAMPLE: 





4. Press and hold either  or  until you reach the correct hour and AM/PM designation (**AM** begins at midnight; **PM** begins at noon).









5. Press  once. The display will show the day of the week as an abbreviation (**MO** for Monday, **TU** for Tuesday, etc.).
6. Press and hold either  or  until you reach the correct day of the week.
7. Press  once. The display will show the correct time and room temperature alternately.





Program Heating and Cooling Temperatures

During programming, if you don't press any buttons for 5 minutes, the thermostat will enter the **HOLD** mode and will maintain a constant temperature. The display will revert to the alternating time/temperature display. To resume



programming after this happens, press  until you are at the point where you stopped programming. Then you may continue to enter your programs normally. If you want to stop programming at any time, simply press  to resume program operation.

1. Press  until **HEAT** is displayed.
2. Press  once. The display will continue to show **HEAT**. Beside **HEAT** is the letter **O**, representing the occupied heating temperature (**HEAT O**). At the right of the display is the currently programmed **HEAT O** setting.
3. Press either  or  to change the temperature to your selected **HEAT O** setting.

4. Press  once. The letter **O** will change to the letter **U**, representing the unoccupied heating temperature (**HEAT U**).
5. Press either  or  to change the temperature to your selected **HEAT U** setting.
6. Press  .
7. Press  until **COOL** is displayed.
8. Press  once. The display will show **COOL** and **O**, representing the occupied cooling temperature (**COOL O**).
9. Press either  or  to change the temperature to your selected **COOL O** setting.

10. Press  once. Press  or  to set your selected **COOL U** (unoccupied cooling) setting.
11. Press  .





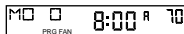

Enter Heating Program

1. Press  until **HEAT** is displayed.
2. Press  once. **MO**, the abbreviation for Monday, and the letter **O**, representing the **occupied** heating period, will appear in the display. Also displayed are the currently programmed start time for the occupied heating period and the currently programmed **HEAT O** temperature.

EXAMPLE:



This display window shows that for Monday's occupied heating period, the start time is 8:00 AM, 70° is the programmed temperature, and the fan is set to **PRG FAN** (continuous fan operation); this example reflects factory preprogramming, where 70° is the **HEAT O** temperature.

3. To change the displayed start time to your selected start time for Monday's occupied heating period, press  or  until your selected time appears. The time will change in 15 minute increments.
4. If the temperature displayed is not the **HEAT O** temperature you want for Monday's occupied heating period, press  or  (if you continue to press  or , the display will alternate

between the **HEAT O** and **HEAT U** temperatures you previously selected).

NOTE

Damper operation is linked to the occupied or unoccupied **temperature** selections, not to the occupied or unoccupied time periods. The damper will be open only during periods with occupied temperatures. Therefore, we suggest that you program occupied temperatures during occupied periods and unoccupied temperatures during unoccupied periods.



5. If you want the fan to run continuously during Monday's occupied heating period, press  until **PRG FAN** is displayed.

6. After selecting the desired heating temperature for Monday's occupied heating period, press . The currently programmed start time and heating temperature for Monday's **unoccupied** heating period will be displayed.
7. Repeat steps 3 through 5 to select the start time and heating temperature for Monday's unoccupied heating period.

NOTE

The thermostat has a built-in **COPY** feature. This feature automatically copies the heating and cooling programs you select for Monday into Tuesday through Sunday's programs. If you want to have the same programming every day, after you program Monday's schedule, you simply press  to start the thermostat's







programmed operation. Every day will then use the same program you set for Monday. You may also choose to use the  button to copy any day's heating and cooling program into any other day's program (see **USING THE COPY BUTTON**).



8. To enter Tuesday's through Sunday's heating programs, use  button or press  until the correct day's abbreviation appears in the display. Repeat the above steps to program each day's heating periods and temperatures.
9. When you have completed programming your heating/cooling periods and heating temperatures, press  to begin program operation.

Enter Cooling Program

CAUTION

If outside temperature is below 50°F, we recommend that you remove the thermostat from the wall before proceeding with the following steps to program cooling temperatures. Personal injury or property damage may occur due to air conditioner compressor slugging. A fresh 9 volt Energizer® alkaline battery must be installed to perform off-wall programming. Programming away from the wall should prevent accidental compressor operation. **BE SURE SYSTEM SWITCH IS SET TO OFF POSITION BEFORE REATTACHING THE THERMOSTAT TO THE SUBBASE!**





1. Press  until **COOL** is displayed.
2. Press  once. **MO**, the abbreviation for Monday, and the letter **O**, representing the **occupied** cooling period, will appear in the display. Also displayed are the currently programmed start time for the occupied cooling period and the currently programmed **COOL O** temperature.
3. To change the displayed start time to your selected start time for Monday's occupied cooling period, press  or  until your selected time appears. The time will change in 15 minute increments.
4. If the temperature displayed is not the **COOL O** temperature you want for Monday's occupied cooling period, press  or  (if you continue to press

 or , the display will alternate between the **COOL O** and **COOL U** temperatures you previously selected).

NOTE

Damper operation is linked to the occupied or unoccupied **temperature** selections, not to the occupied or unoccupied time periods. The damper will be open only during periods with occupied temperatures. Therefore, we suggest that you program occupied temperatures during occupied periods and unoccupied temperatures during unoccupied periods.

5. If you want the fan to run continuously during Monday's occupied cooling period, press  until **PRG FAN** is displayed.





6. After selecting the desired cooling temperature for Monday's occupied cooling period, press . The currently programmed start time and cooling temperature for Monday's **unoccupied** cooling period will be displayed.
7. Repeat steps 3 through 5 to select the start time and cooling temperature for Monday's unoccupied cooling period.
8. To enter Tuesday's through Sunday's cooling programs, use  or press  until the correct day's abbreviation appears in the display. Repeat the above steps to program each day's cooling periods and temperatures.
9. After you enter or copy heating and cooling programs for all 7 days, press  to

Using The COPY Button



You can copy the entire heating/cooling program into any or all other days' programs. However, you must perform each copy function separately. Each time you begin a **COPY** operation, you must start with the day's program you wish to copy **FROM**. A **COPY** operation is not complete until  has been pressed **TWICE**.

NOTE

For most efficient programming, you should enter both the heating and cooling programs for the day you wish to copy **FROM** before using the **COPY** function, since the **COPY** function copies the entire day's heating and cooling programs to other days.







1. Press  .
2. Press  until the day you want to copy **FROM** is displayed. If you have not completed programming for this day, do so before proceeding.
3. Press  once. **COPY** will appear on the display. A number from **1** to **7** will also appear, representing the day you have selected to copy (Monday is **1**, Tuesday is **2**, Wednesday is **3**, etc.). For example, if in step 2 you displayed Wednesday's program, when you press  , **COPY 3** will appear in the display (as shown below).

EXAMPLE: 

4. Press  to select the day you want to copy the program **TO**.
5. Press . **COPY** will disappear from the display, and the display will show the copied heating/cooling time and temperature for the day you copied **TO**.
6. Repeat the above steps to copy any day's programming into any other day's program.
7. Press  to begin program operation.



CHECK YOUR PROGRAMMING

Follow these steps to check your thermostat programming one final time before beginning thermostat operation.

1. Press  until **HEAT** is displayed.
2. Press and hold  to view the heating times and temperatures for Monday.
3. Press  once to advance to Tuesday.
4. Press and hold  to view heating times and temperatures for Tuesday.
5. Repeat steps 3 and 4 to review all remaining days' programming. If you find an error in any day's programming, go back to the programming instructions to correct the error (you can change any part of your program while you are reviewing it).
6. Press .
7. Press  until **COOL** is displayed.

- Repeat steps 2 through 5 to check cooling times and temperatures.
- Press  to begin program operation.





YOUR THERMOSTAT IS NOW COMPLETELY PROGRAMMED AND READY TO AUTOMATICALLY PROVIDE MAXIMUM COMFORT AND EFFICIENCY!

Press  until **OFF** is displayed. Reattach thermostat to subbase. Then press  to select the operation mode you want (**HEAT, COOL, AUTO**).

When you have completed programming and selected the desired operating mode, you may set option switch #4 for total keypad lockout.



QUESTIONS AND ANSWERS

1. How can I permanently change a part of my program?

Press  and  until you reach the time/temperature schedule you want. Then press  or  and  and  to change the program. See **PROGRAMMING YOUR THERMOSTAT**.

2. How can I finish my programming if the display has already changed to time/temperature?

During programming, if no buttons are pressed for five minutes, the thermostat will enter the **HOLD** mode and maintain a constant temperature. The display will change to the time/temperature mode. To

resume programming, press  and  until you return to the point where you stopped programming. Then you may continue to program the thermostat normally. If you want to stop programming at this point, press  to start the normal program function. See **PROGRAMMING YOUR THERMOSTAT**.

3. What happens if the electricity goes off or is manually shut off?

If you have not installed a 9 volt alkaline battery, the display will go blank and the program will be lost in five seconds. When electricity is restored, the thermostat will maintain a heating temperature of 64°F and a cooling temperature of 82°F until you

re-enter your program. Setpoint temperature will not be displayed.

If a fresh 9 volt Energizer® alkaline battery is installed, the program will be maintained for about one week with no 24VAC power present to the thermostat. See **OPERATING YOUR THERMOSTAT**.

4. Why can't I program the thermostat in the **AUTO** mode?

The thermostat can only be programmed in the **HEAT** and **COOL** modes. See **PROGRAMMING YOUR THERMOSTAT**.

5. What can cause the thermostat display to freeze or go blank?

A completely blank display may indicate that power has been lost to the thermostat and the backup battery is also dead. However, if there is power to the thermostat and

the display is blank or frozen, static discharge is probably the cause.

During periods of low humidity (especially during cold weather), you may feel or see a spark discharge when you touch the thermostat. This may cause the program to be lost or the thermostat to display incorrectly. To correct this, remove the thermostat from the wall and disconnect the battery. Wait about two minutes, then reconnect the battery. The thermostat will revert to the factory preset program until you reprogram the thermostat. If you don't want to reprogram the thermostat immediately, press  until **OFF** is displayed and replace the thermostat on the wall.

Then press  until **HEAT, COOL,**

etc. is displayed, and press  to begin the factory preset program. Or you may reprogram the thermostat, then replace it on the wall.

To prevent further static discharge problems, touch another object to release static build-up before touching the thermostat. See **OPERATING YOUR THERMOSTAT**.

6. Why won't the setpoint temperature go to the temperature I want?

The highest heating setpoint temperature you select must be at least 1°F lower than the lowest cooling setpoint temperature you select (for example, if 70°F is your lowest selected cooling temperature, you cannot select a heating temperature any higher than 68°F). If such a conflict exists, you must set the lowest cooling tempera-

ture higher in order to set the heating temperature higher. To set a lower cooling temperature, you must select a lower heating temperature. See **PROGRAMMING YOUR THERMOSTAT**.



7. Why doesn't the display light come on when I press a button? Why don't I hear a beep when I press a button?

The display light and audio prompting (beep) only work when the thermostat is on the wall and 24VAC power is present to the thermostat. These features will not work on battery power alone. See **OPERATING YOUR THERMOSTAT**.

8. **The display is flashing BATTERY. What does this mean?**

The 9 volt battery installed in the thermostat is low and should be replaced with a fresh 9 volt Energizer® alkaline battery. See **OPERATING YOUR THERMOSTAT**.

9. **Why won't the system turn on, even though the thermostat display is functioning normally?**

Either the compressor lockout feature is in operation or the thermostat is not currently calling for heat or cool. Wait about 5 minutes for the compressor lockout to expire. If the system is still not running, read the cautionary statement at right. **If conditions permit**, use the  or  buttons to move the temperature above or below the setpoint temperature. See **OPERATING YOUR THERMOSTAT**.

 **CAUTION**

If the outside temperature is below 50°F, DO NOT use the  button to move the temperature below the setpoint temperature. Personal injury and/or property damage may result due to compressor operation in cold weather.

10. **Why doesn't the temperature change at the time I programmed?**

There may be a number of causes for this situation. The following are primary reasons.

- The **EMR** function is operating. The **EMR** function will energize the system automatically to bring the temperature to the selected level by the beginning of

the next program period. See **OPERATING YOUR THERMOSTAT**.

- You have programmed the incorrect day or time. Check your programming (be sure that the times you programmed are correct AM or PM times). See **PROGRAMMING YOUR THERMOSTAT**.
- The thermostat is in the **HOLD** mode.

Press  to start program operation.

See **OPERATING YOUR THERMOSTAT**.

- The compressor lockout feature is operating; wait about 5 minutes for system to begin running. See **OPERATING YOUR THERMOSTAT**.



11. Why does the blower fan keep running after the system has turned off?

- You have programmed the fan to run continuously during this period. See **PROGRAMMING YOUR THERMOSTAT**.
- The blower delay feature is operating. This energy saving feature continues to blow conditioned air through the ducts after the system has turned off, rather than letting the air dissipate.

12. Why is the system turning on and off so frequently (seldom)?

The anticipation setting is too low (high). To change anticipation settings, see **OPERATING YOUR THERMOSTAT**.

13. **Between heating and cooling seasons, I want to turn my system off. Can I do this without affecting my thermostat programming?**

Any time you wish to turn your system off, simply press  until the display shows **OFF**. This will not affect thermostat programming in any way. To turn the system back on, press  until **HEAT, COOL,** or **AUTO** is displayed. The system will automatically begin operating according to the current thermostat program, unless the thermostat is in the **HOLD** mode. See **OPERATING YOUR THERMOSTAT**.



14. **I live in an area where daylight savings time is observed. How do I change the thermostat clock twice a year without affecting thermostat programming?**

To change your clock, follow the instructions for setting current time and day. See **ENTERING YOUR PROGRAM**. Thermostat operation is not affected when you change the clock.

15. **Do I have to reprogram my thermostat after I change the battery?**

When the thermostat is on the wall and the system has power, the thermostat is being powered by a 24VAC source. If power is lost, or if the thermostat is removed from the wall, the program will be maintained for about **one minute** if there is no battery installed or if the installed battery is dead. If you are changing the battery after seeing

a flashing **BATTERY** on the display, the installed battery may be dead. If you remove the old battery and install a fresh battery within one minute, you may not lose your programming. After installing a new battery, follow the procedures in **CHECK YOUR PROGRAMMING** to determine whether your programming was maintained. If the thermostat retains program-

ming, press  until **OFF** is displayed, put the thermostat back on the wall, press  to select the operating mode you want, then press  to start program operation. If the program is lost, you must reprogram the thermostat. See **PROGRAMMING YOUR THERMOSTAT**.

NOTES

If you need further information on programming or operation, please write to us at:

White-Rodgers Division, Emerson Electric Co.
9797 Reavis Road
St. Louis, MO 63123-5398
Attention: Technical Service Department



WHITE-RODGERS DIVISION
EMERSON ELECTRIC CO.
9797 REAVIS ROAD
ST. LOUIS, MISSOURI 63123-5398

Part No. 37-5210A

9318

Free Manuals Download Website

<http://myh66.com>

<http://usermanuals.us>

<http://www.somanuals.com>

<http://www.4manuals.cc>

<http://www.manual-lib.com>

<http://www.404manual.com>

<http://www.luxmanual.com>

<http://aubethermostatmanual.com>

Golf course search by state

<http://golfingnear.com>

Email search by domain

<http://emailbydomain.com>

Auto manuals search

<http://auto.somanuals.com>

TV manuals search

<http://tv.somanuals.com>