

SHARP®

MODEL **UX-CC500**

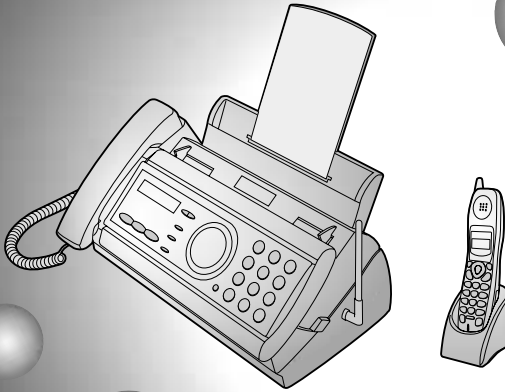

FACSIMILE OPERATION MANUAL

1. **Installation**
2. **Using the Cordless Handset**
3. **Using the Answering System**
4. **Sending Faxes**
5. **Receiving Faxes**
6. **Making Copies**
7. **Special Functions**
8. **Printing Lists**
9. **Maintenance**
10. **Troubleshooting**

SHARP®

FROM SHARP MINDS
COME SHARP PRODUCTS™



GENUINE SUPPLIES

To ensure Sharp quality, look for the Sharp Genuine Supplies Logo on Your business products. We provide a full line of supplies that are designed and tested to maximize the life and performance of all Sharp products.

SharpPlace

congratulations on the purchase of your new Sharp Product!

For your convenience, Genuine Sharp Supplies, Accessories, and additional Sharp Products can be purchased from the Authorized Sharp Reseller where you purchased your product or on-line at:

www.SharpPlace.com

visit SharpPlace to enter periodic contests and drawings!

© 2002 Sharp Electronics Corporation
Design and specifications are subject to change without notice.

WARNING - FCC Regulations state that any unauthorized changes or modifications to this equipment not expressly approved by the manufacturer could void the user's authority to operate this equipment.

Note: This equipment has been tested and found to comply with the limits for a Class B digital device, pursuant to Part 15 of the FCC Rules.

These limits are designed to provide reasonable protection against harmful interference in a residential installation.

This equipment generates, uses and can radiate radio frequency energy and, if not installed and used in accordance with the instructions, may cause harmful interference to radio communications. However, there is no guarantee that interference will not occur in a particular installation. If this equipment does cause harmful interference to radio or television reception, which can be determined by turning the equipment off and on, the user is encouraged to try to correct the interference by one or more of the following measures:

- Reorient or relocate the receiving antenna.
- Increase the separation between the equipment and the receiver.
- Connect the equipment into an outlet on a circuit different from that to which the receiver is connected.
- Consult the dealer or an experienced radio/TV technician for help.

IMPORTANT NOTICE

Fax machine

FCC Radiation Exposure Statement:

This equipment complies with FCC radiation exposure limits set forth for uncontrolled equipment.

This equipment should be installed and operated with minimum distance at least 20cm between the radiator and persons body (excluding extremities: hands, wrists, feet and legs) and must not be co-located or operated with any other antenna or transmitter.

Cordless handset

For body worn operation, this phone has been tested and meets FCC RF exposure guidelines when used with an accessory that contains no metal and that positions the handset a minimum of 1.5cm from the body.

Use of other accessories may not ensure compliance with FCC RF exposure guidelines.

ABOUT THE TELEPHONE CONSUMER PROTECTION ACT OF 1991

"The Telephone Consumer Protection Act of 1991 makes it unlawful for any person to use a computer or other electronic device to send any message via a telephone facsimile machine unless such message clearly contains in a margin at the top or bottom of each transmitted page or on the first page of the transmission the following information:

- (1) The date and time of transmission.
- (2) Identification of either the business, business entity or individual sending the message.
- (3) Telephone number of either the sending machine, business, business entity or individual.

In order to program this information into your facsimile machine, please refer to the appropriate instructions in the operation manual."



As an ENERGY STAR® partner, SHARP has determined that this product meets the ENERGY STAR® guidelines for energy efficiency.

Introduction

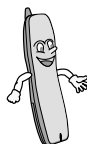

Welcome, and thank you for choosing a SHARP UX-CC Series fax machine and cordless handset!

In addition to the cordless handset that comes with the fax machine, you can purchase up to three accessory cordless handsets. The cordless handsets can be used as an intercom system, and each cordless handset has its own personal box in the answering system.

Fax machine and general specifications.

Automatic dialing	Common book: 40 numbers Private book: 5 numbers (each cordless handset has 1 private book)
Imaging film	Initial starter roll (included with machine): 32 ft. (10 m) (approx. 30 letter-size pages) Replacement roll (not included): UX-5CR 164 ft. (50 m) (one roll yields approx. 150 letter-size pages)
Memory size*	448 KB (approx. 24 average pages with no voice messages recorded, or 20 minutes of voice messages (including OGMs) with no faxes in memory)
Modem speed	14,400 bps with automatic fallback to lower speeds.
Transmission time*	Approx. 6 seconds (only when ECM is on)
Resolution	Horizontal: 203 pels/inch (8 pels/mm) Vertical: Standard: 98 lines/inch (3.85 lines/mm) Fine /Halftone: 196 lines/inch (7.7 lines/mm) Super fine: 391 lines/inch (15.4 lines/mm)
Automatic document feeder	10 pages max. (letter/A4, 20 lb paper)
Recording system	Thermal transfer recording
Display	16-digit LCD display

*Based on Sharp Standard No. 1 Chart at standard resolution in Sharp special mode, excluding time for protocol signals (i.e., ITU-T phase C time only).

Halftone (grayscale)	64 levels
Compression scheme	MR, MH, MMR
Applicable telephone line	Public switched telephone network
Paper tray capacity	Letter: Approx. 50 sheets (20-lb. copier paper at room temperature; maximum stack height should not be higher than the line on the tray) Legal: 5 sheets Recommended paper weight: 20-lb. Copy Bond
Compatibility	ITU-T (CCITT) G3 mode
Input document size	Automatic feeding: Width: 5.8 to 8.5" (148 to 216 mm) Length: 5.5 to 11" (140 to 279 mm) Manual feeding: Width: 5.8 to 8.5" (148 to 216 mm) Length: 5.5 to 23.6" (140 to 600 mm)
Effective scanning width	8.3" (210 mm) max.
Effective printing width	8.3" (210 mm) max.
Contrast control	Automatic/Dark selectable
Reception modes	TEL/FAX/TAD
Copy function	Single / Multi (99 copies/page)
Telephone function	Yes (cannot be used if power fails)
Power requirements	120 V AC, 60 Hz
Operating temperature	41 - 95°F (5 - 35°C)
Humidity	25 - 85% RH
Power consumption	Standby: 4.3 W Maximum: 100 W
Dimensions (without attachments)	Width: 13.9" (353 mm) Depth: 7.6" (193 mm) Height: 6.9" (174 mm)
Weight (without attachments)	Approx. 6.2 lbs. (2.8 kg)

Cordless handset specifications

Frequency	2.4 GHz (2.405 to 2.475 GHz)
Dimensions	Width: 1.8" (46 mm) Depth: 1.7" (42 mm) Height: 7.1" (180 mm) (not including antenna)
Weight	Approx. 0.3 lbs. (115 g) (without battery)
Battery	3.6 V Ni-MH battery; capacity: 850 mAh
Power consumption	Approx. 1.0 W (in standby mode)
Initial charging	Approx. 10 hours for initial charge
Battery life	Approx. 4 hours (240 minutes) (at room temp.)
Battery life in standby mode	Approx. 3 days with one full charge (at room temperature) <i>Battery life (both normal and in standby mode) may vary depending on usage, range from base machine, and environmental conditions such as temperature.</i>

Accessory cordless handset UX-K01 (up to 3 handsets can be added)

As a part of our policy of continuous improvement, SHARP reserves the right to make design and specification changes for product improvement without prior notice. The performance specification figures indicated are nominal values of production units. There may be some deviations from these values in individual units.

Important: This fax machine is not designed for use on a line which has call waiting, call forwarding, or certain other special services offered by your telephone company. If you attempt to use the fax machine in conjunction with any of these services, you may experience errors during transmission and reception of facsimile messages. The fax machine is not compatible with digital telephone systems.

Important safety information

Do not disassemble this machine or attempt any procedures not described in this manual. Refer all servicing to qualified service personnel.

Do not install or use the machine near water, or when you are wet. For example, do not use the machine near a bath tub, wash bowl, kitchen sink or laundry tub, in a wet basement, or near a swimming pool. Take care not to spill any liquids on the machine.

Unplug the machine from the power outlet and telephone jack and consult a qualified service representative if any of the following situations occur:

- Liquid has been spilled into the machine or the machine has been exposed to rain or water.

- The machine produces odors, smoke, or unusual noises.
- The power cord is frayed or damaged.
- The machine has been dropped or the housing damaged.

Do not allow anything to rest on the power cord, and do not install the machine where people may walk on the power cord.

This machine must only be connected to a 120 V, 60 Hz, grounded (3-prong) outlet. Connecting it to any other kind of outlet will damage the machine and invalidate the warranty.

Never insert objects of any kind into slots or openings on the machine. This could create a risk of fire or electric shock. If an object falls into the machine that you cannot remove, unplug the machine and consult a qualified service representative.

Do not place this machine on an unstable cart, stand or table. The machine could be seriously damaged if it falls.

Never install telephone wiring during a lightning storm.

Never install telephone jacks in wet locations unless the jack is specifically designed for wet locations.

Never touch bare telephone wires or terminals unless the telephone line has been disconnected at the network interface.

Use caution when installing or modifying telephone lines.

Avoid using a telephone (other than a cordless type) during an electrical storm. There may be a remote risk of electric shock from lightning.

Do not use a telephone to report a gas leak in the vicinity of the leak.

The power outlet must be installed near the equipment and must be easily accessible.

Battery

Use only the battery specified in this manual. Use only the provided charger to charge the battery.

Do not open or mutilate the battery pack. Corrosive fluid may leak out and cause injury or burns to the eyes and skin. The fluid may be toxic if swallowed. In case of contact with eyes, flush with clean water (do not rub), and seek medical attention immediately.

Do not store or carry the battery with other metal objects such as keys or pins. These may short the battery and cause it to overheat.

Do not allow the battery to become wet.

Do not dispose of the battery in a fire or heat the battery. The battery may explode.

Health care facilities and equipment

Radio frequency energy emitted from the cordless handset equipment may cause medical equipment to malfunction. Verify that any personal medical equipment you are using is adequately shielded from external radio frequency energy before using the cordless handset equipment. Do not use the cordless handset equipment in health care facilities where such use is prohibited.

Table of Contents

A Look at the Operation Panel	7
<hr/>	
1. Installation	12
<hr/>	
Unpacking Checklist	12
Setting Up	13
Loading the Imaging Film	22
Loading Printing Paper	24
Entering Your Name and Fax Number	26
Setting the Date and Time	28
Setting the Reception Mode	30
Volume Adjustment - Fax Machine.	31
Volume Adjustment - Cordless Handset.	32
2. Using the Cordless Handset	34
<hr/>	
Making a Phone Call	34
Receiving a Phone Call	35
Receiving a Fax Using the Cordless Handset	36
Storing and Using Auto-Dial Numbers	36
Redial	41
Using the Intercom Feature	41
Transferring Calls	44
3. Using the Answering System	47
<hr/>	
Recording an Outgoing Message.	48
Setting a Passcode for a Personal Box	49
Operating the Answering System.	50
Optional Answering System Settings	56
Transfer Function	59
Remote Operations	62
4. Sending Faxes	69
<hr/>	
Transmittable Documents.	69
Loading the Document	70
Adjusting the Resolution and Contrast	71
Sending a Fax by Normal Dialing.	73

Table of Contents

Sending a Fax by Automatic Dialing	74
Sending a Fax From Memory	81
5. Receiving Faxes	83
Using FAX Mode	83
Using TEL Mode	84
Optional Reception Settings	86
Substitute Reception to Memory	88
6. Making Copies	89
7. Special Functions	91
Caller ID (Requires Subscription to Service)	91
Distinctive Ring (Requires Subscription to Service)	97
Blocking Reception of Unwanted Faxes	98
8. Printing Lists	99
9. Maintenance	103
Replacing the Cordless Handset Battery	106
10. Troubleshooting	108
Problems and Solutions	108
Messages and Signals	114
Clearing Paper Jams	119
Ordering Parts	121
FCC Regulatory Information	122
Quick Reference Guide	125
Guía de referencia rápida	127
Index	129

A Look at the Operation Panel

Fax machine

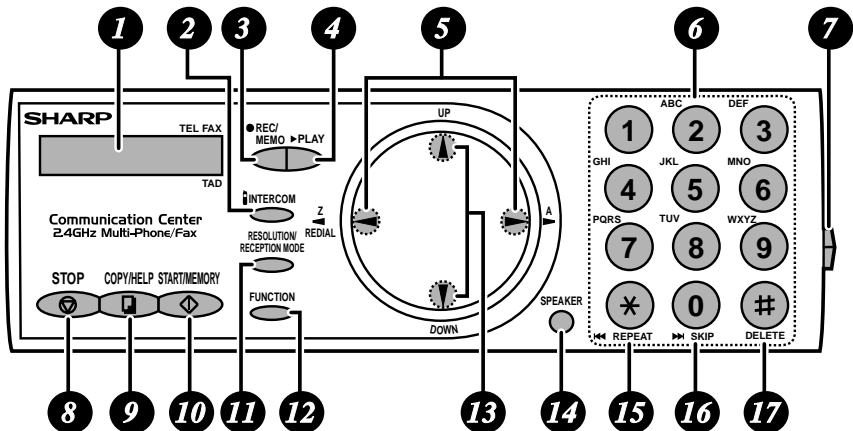

- 1 Display**
This displays messages and prompts to help you operate the machine.
- 2 INTERCOM key**
Press this key to page or locate the cordless handset.
- 3 REC/MEMO key**
Press this key to record an outgoing message, phone conversation, or memo.
- 4 PLAY key**
Press this key to play recorded messages.
- 5 Left and right arrow keys**
Auto-dial numbers: When sending a fax or making a phone call, press these keys to scroll through your auto-dial numbers, the "REVIEW CALLS" list (only available if you have Caller ID), and the last number dialed (redial).
FUNCTION key settings: Press the right arrow key after scrolling with the up and down arrow keys to select a **FUNCTION** key setting.
- 6 Number keys**
Use these keys to dial numbers, and enter numbers and letters when storing auto-dial numbers.
- 7 Panel release**
Press this release to open the operation panel.

- 8 STOP key**
Press this key to cancel an operation before it is completed.
- 9 COPY/HELP key**
When a document is in the feeder, press this key to make a copy of a document. At any other time, press this key to print out the Help List, a quick reference guide to the operation of your fax machine.
- 10 START/MEMORY key**
Press this key after dialing to begin fax transmission. Press this key before dialing to send a fax through memory. The key can also be pressed in the date and time display to show the percentage of memory currently used.
- 11 RESOLUTION / RECEPTION MODE key**
When a document is in the feeder, press this key to adjust the resolution for faxing or copying. At any other time, press this key to select the reception mode (an arrow in the display will point to the currently selected reception mode).
- 12 FUNCTION key**
Press this key followed by the arrow keys to select special functions and settings.
- 13 UP and DOWN arrow keys**
Enlarge/reduce setting: When making a copy of a document, press these keys to select an enlarge/reduce setting.
Volume setting: When a document is not in the feeder, press these keys to change the handset volume when the handset is lifted, the speaker volume when the **SPEAKER** key has been pressed, or the ringer volume at any other time.
FUNCTION key settings: Press these keys after pressing the **FUNCTION** key to scroll through the FUNCTION MODE settings.
- 14 SPEAKER key**
Press this key to listen to the line and fax tones through the speaker when faxing a document.
Note: **This is not a speakerphone.** You must pick up the handset to talk with the other party.
- 15 REPEAT key**
Press this key while listening to a message to play it again.
- 16 SKIP key**
Press this key while listening to a message to skip to the next message.
- 17 DELETE key**
Press this key to erase recorded messages.

Cordless handset

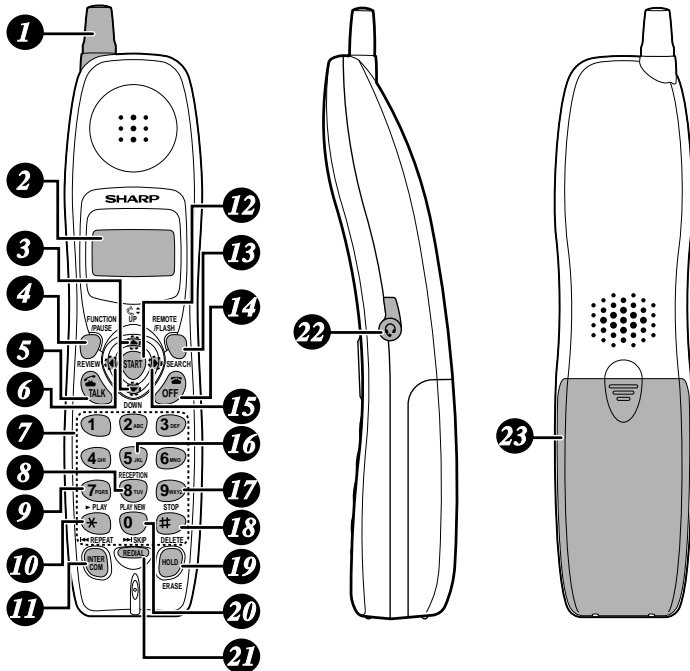

1 Antenna

2 Display

This displays messages and prompts to help you use the cordless handset.

3 UP and DOWN arrow keys

Receiver volume: When talking on the cordless handset, press these keys to adjust the receiver volume. This also adjusts the volume when using a headset (purchased separately) connected to the cordless handset.



Ringer volume: When not talking on the cordless handset, press these keys to adjust the cordless handset ringer volume.

Scroll through numbers: Press these keys to scroll when searching for an auto-dial number or reviewing received calls (only available when you have Caller ID).

4 FUNCTION/PAUSE key

Press this key to after pressing  SEARCH to store a new auto dial number.

When entering an auto-dial number, press this key to insert a pause between digits.

- 5 TALK key**
Press this key to make or answer a call.
- 6 REVIEW (left) arrow key**
Press the **REVIEW** arrow key and then the **UP** or **DOWN** arrow key to scroll through your 30 most recent calls (only available if you have Caller ID). This key can also be used to move the cursor left when entering or editing an auto-dial number or name.
- 7 Number keys**
Use these keys to dial numbers, and enter numbers and letters when storing auto-dial numbers.
- 8 PLAY NEW key**
Press this key after pressing  to listen to new messages recorded in the personal box corresponding to the cordless handset.
- 9 PLAY key**
Press this key after pressing  to listen to all messages recorded in the personal box corresponding to the cordless handset.
- 10 REPEAT key**
Press this key while listening to a message to play it again.
- 11 INTERCOM key**
Press this key to page the fax machine or another cordless handset.
- 12 START key**
Press this key to start fax reception from the cordless handset, or to complete entries when storing, editing, or deleting auto-dial numbers.
- 13 REMOTE/FLASH key**
Press this key to perform remote operations on the fax machine. The key is also used to access special services from your phone company that require subscription (contact your phone company for details).
- 14 OFF key**
Press this key to end a call.
- 15 SEARCH (right) arrow key**
Press the **SEARCH** arrow key and then the **UP** or **DOWN** arrow key to scroll through your auto-dial numbers. This key can also be used to move the cursor right when entering or editing an auto-dial number or name.

16 RECEPTION key

Press this key after pressing  to change the reception mode on the fax machine.

17 STOP key

Press this key to stop playback of messages.

18 DELETE

Press this key while listening to a message to delete it. To delete all your messages, press this key after playback ends (while the display shows REMOTE MODE), followed by .

19 HOLD/ERASE key

Hold: Press this key during a call to put the other party on hold.

Erase: Press this key to delete a phone number when searching through your recently received calls (only when you have Caller ID), or when searching through your auto-dial numbers. Press the key to delete a digit or character when storing or editing an auto-dial number.

20 SKIP key

Press this key while listening to your messages to skip to the next message.

21 REDIAL key

Press this key to redial the last number dialed using the cordless handset.

22 Headset jack

This jack lets you connect a headset (purchased separately) to the cordless handset.

23 Battery cover

Remove this cover to install or replace the handset battery.

1. Installation

Unpacking Checklist

Before setting up, make sure you have all of the following items.



If any are missing, contact your dealer or retailer.

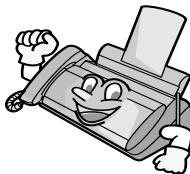

Paper tray

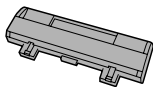

Paper tray extension



Operation manual

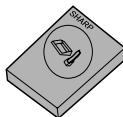

Gears (2)



Handset



Handset cord

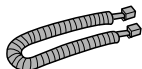

Telephone line cord



Imaging film (initial starter roll)

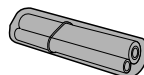

Cordless handset



Battery cover



Battery pack



AC adapter

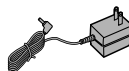

Cordless handset charger



Setting Up

Selecting a location for the fax machine

To maximize the talking range of the cordless handset, we recommend installing the fax machine in a high and central location away from obstructions such as walls.

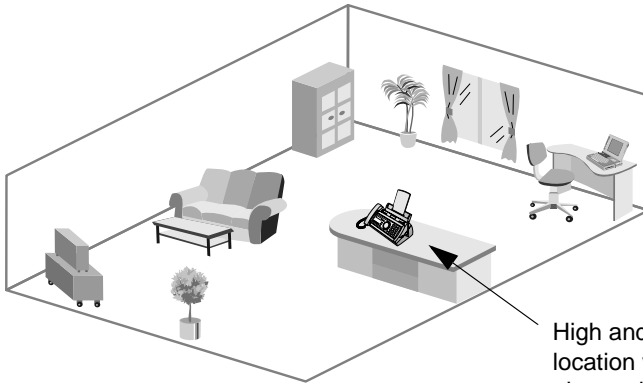

High and central location with no obstructions

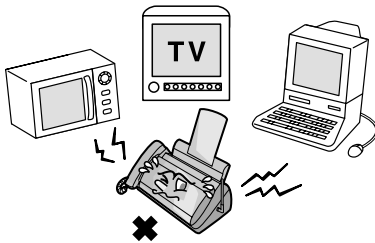

Keep the fax machine away from other electrical appliances such as TVs, microwave ovens, computers, and other cordless phones.

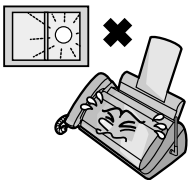

Do not place the machine in direct sunlight.

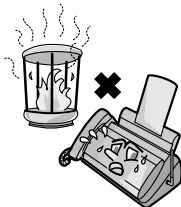

Do not place the machine near heaters or air conditioners.

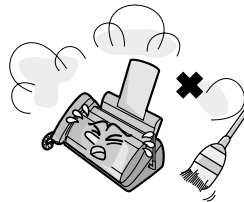

Keep dust away from the machine.

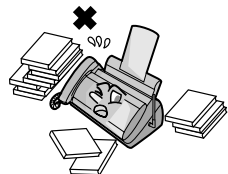

Keep the area around the machine clear.

Connecting the handset

Connect the handset as shown and place it on the handset rest.

- ◆ The ends of the handset cord are identical, so they will go into either jack.

Make sure the handset cord goes into the jack marked with a handset symbol on the side of the machine!

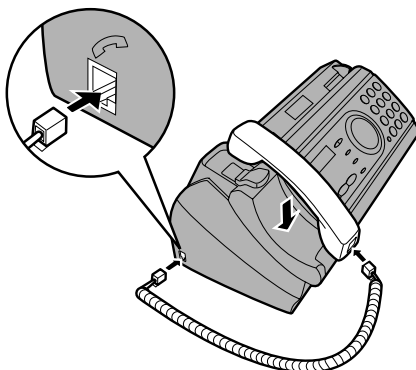
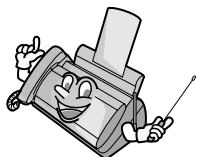

Use the handset to make ordinary phone calls, or to transmit and receive faxes manually.

Connecting the power cord

Plug the power cord into a 120 V, 60 Hz, grounded AC (3-prong) outlet.

Caution!

Do not plug the power cord into any other kind of outlet. This will damage the machine and is not covered under the warranty.

The machine does not have a power on/off switch, so the power is turned on and off by simply plugging in or unplugging the power cord.

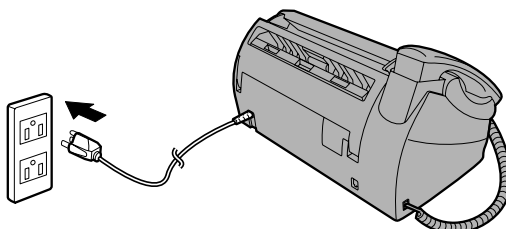

Connecting the telephone line cord

Insert one end of the line cord into the jack on the back of the machine marked **TEL. LINE**. Insert the other end into a standard (RJ11C) single-line wall telephone jack.

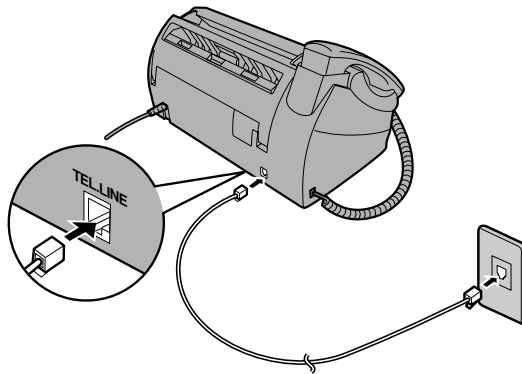

Setting the dial mode

The fax machine is set for tone dialing. If you are on a pulse dial line, you must set the fax machine for pulse dialing. Press the panel keys as follows:

1 Press **FUNCTION** once and **▲** once.

Display:

OPTION SETTING ⇄

2 Press **▶** once and **▼** twice.

DIAL MODE ⇄

3 Press **▶** once.

1=TONE, 2=PULSE

4 Select the dial mode:

TONE: (1) PULSE: (2)

The display briefly shows your selection, then:

DISTINCTIVE ⇄

5 Press **STOP** to exit.

Setting Up

Note: If your area experiences a high incidence of lightning or power surges, we recommend that you install surge protectors for the power and telephone lines. Surge protectors can be purchased at most telephone specialty stores.

About condensation

If the machine is moved from a cold to a warm place, it is possible that condensation may form on the scanning glass, preventing proper scanning of documents for transmission. To remove the condensation, turn on the power and wait approximately two hours before using the machine.

Attach the paper tray and paper tray extension

Attach the paper tray.

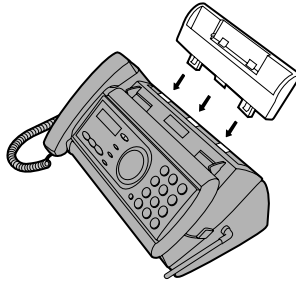

Attach the paper tray extension.

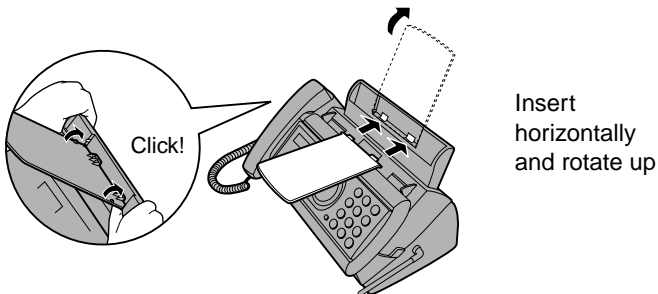

Note: The paper tray extension has a top side and a bottom side. If the tabs do not go into the holes, turn the support over.

Raising the base antenna

Raise the base antenna to ensure clear communication with the cordless handset.

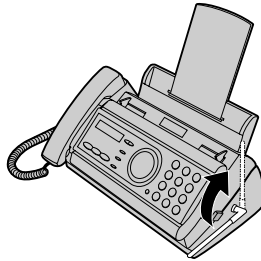

Connecting the cordless handset charger

- 1 Connect the AC adapter to the cordless handset charger.

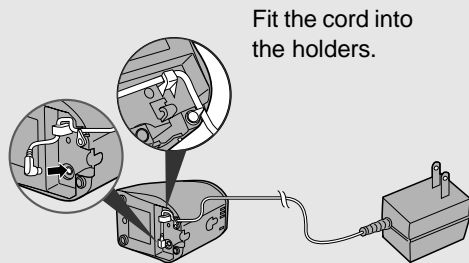

- 2 Plug the AC adapter into a standard 120 V AC outlet.

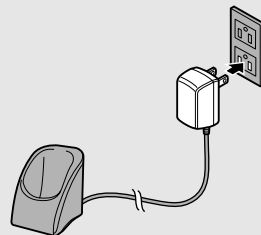

Important: Never cover the charger and AC adapter with a blanket, cloth, or other material. Excessive heating may result and cause fire.

Installing the battery and charging the cordless handset

1 Connect the battery connector ❶, and then place the battery pack in the cordless handset.

- Place the wires as shown.

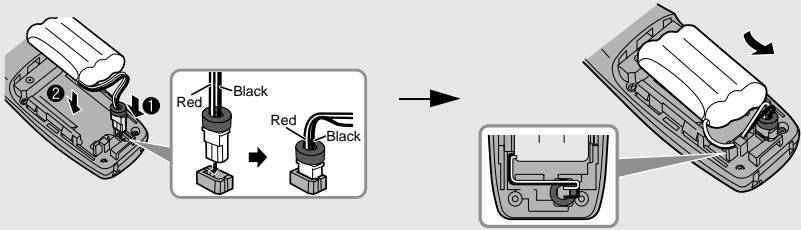

2 Place the battery cover on the cordless handset, making sure it snaps firmly into place.

- Make sure the wires are not caught or pinched by the cover.

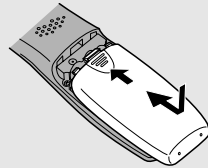

3 Place the cordless handset in the charger with the dial pad facing forward.

- **Important!** The dial pad must face forward, or the battery will not charge.
- The battery charges automatically while the cordless handset is in the charger. While charging, the display shows CHARGING. When charging is completed, the display shows IN CHARGER.
- The cordless handset and charger may feel warm while charging. This is normal.

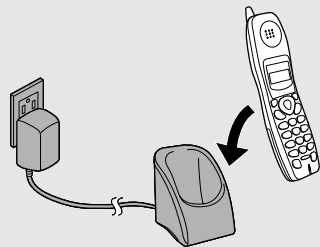

Charge the battery at least **10 hours** the first time!

The battery cannot be overcharged. When not using the cordless handset, keep it in the charger to ensure that it is always charged.

When the battery needs charging, LOW BATTERY will appear in the display and you will hear beeps during a phone conversation. If you need to continue the conversation, press  to transfer the call to the fax machine. Place the cordless handset in the charger and let it charge.

Note: If the battery is extremely low, nothing may appear in the display during the first several minutes that the cordless handset is in the charger. The battery will begin to charge normally after several minutes.

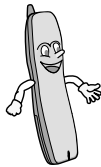

To ensure that the battery charges properly, wipe the charger contacts once a month with a cotton swab.

Talking range

The talking range of the cordless handset is approximately 1200 ft. (400 m) (line of sight). If you hear noise or interference while talking on the cordless handset, move closer to the fax machine.

- ◆ When outside the talking range, OUT OF RANGE appears in the display. If you move out of the talking range while talking on the cordless handset, the handset will beep and you may hear interference.

Large metal objects, metal structures, and thick walls reduce the talking range.

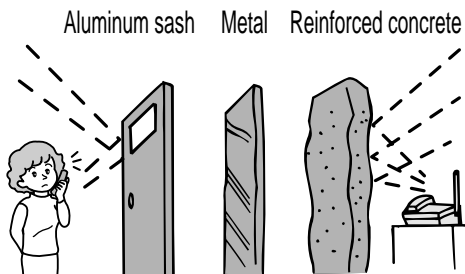

Entering a name for the cordless handset

You can enter a name for the cordless handset in the fax machine.

- ◆ The fax machine will transmit the name that you enter to your cordless handset. The name will appear in the cordless handset's display.

1 Press **FUNCTION** once and **▼** 3 times on the fax machine.

Fax machine display:

ENTRY MODE

2 Press **▶** once and **▲** once.

HS NAME SET

3 Press **▶** once.

1=SET, 2=CLEAR

4 Press **1** to select SET.

SELECT HS NO.

5 Press **1**. ("1" is the ID number of the cordless handset that came with the fax machine.)

SELECT ID NO. 1

6 Enter the name by pressing number keys for each letter as shown in the chart below. Up to 10 characters can be entered.

Example: BILL = 22 444 555 **▶** 555

SPACE = **1**

G = **4**

N = **6 6**

U = **8 8**

A = **2**

H = **4 4**

O = **6 6 6**

V = **8 8 8**

B = **2 2**

I = **4 4 4**

P = **7**

W = **9**

C = **2 2 2**

J = **5**

Q = **7 7**

X = **9 9**

D = **3**

K = **5 5**

R = **7 7 7**

Y = **9 9 9**

E = **3 3**

L = **5 5 5**

S = **7 7 7 7**

Z = **9 9 9 9**

F = **3 3 3**

M = **6**

T = **8**

- ◆ To enter two letters in succession that require the same key, press **▶** after entering the first letter.

- ◆ To clear a mistake, press **SPEAKER** .

◆ To enter a lower case letter, continue pressing the key for the letter until the lower case letter appears.

◆ To enter one of the following symbols, press **#** or ***** repeatedly:

. / ! " # \$ % & ' () * + , - . : ; < = > ? @ [¥] ^ _ ' { | } → ←

7 Press **START/MEMORY** to store the name.

Display:

OWNNUMBER SET

8 Press **STOP** to exit.

The handset number and name appear in the standby display of the cordless handset

HANDSET1
BILL

Connecting a headset

You can connect a headset (purchased separately) to the headset jack. Remove the cap and insert the connector as shown.

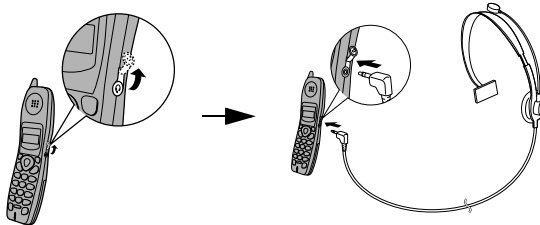

Accessory cordless handsets

You can use up to 3 additional **UX-K01** cordless handsets with the fax machine.



Please purchase accessory **UX-K01** handsets at your dealer or retailer.

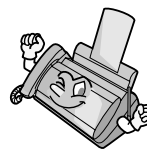

For information on setting up an accessory cordless handset for use with the fax machine, see the manual that accompanies the accessory handset.

Loading the Imaging Film

Your fax uses a roll of imaging film to create printed text and images. The print head in the fax applies heat to the imaging film to transfer ink to the paper. Follow the steps below to load or replace the film.

The initial starter roll of imaging film included with your fax can print about 30 letter-size pages.



When replacing the film, use a roll of Sharp **UX-5CR** imaging film. One roll can print about 150 letter-size pages.

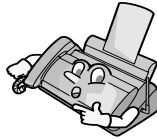

Use only Sharp Genuine Supplies with this logo:



- 1** Remove the paper from the paper tray and open the operation panel (press **1**).

If you are loading the imaging film for the first time, go to Step 4.

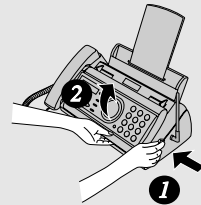

- 2** Remove the used film and empty spool.

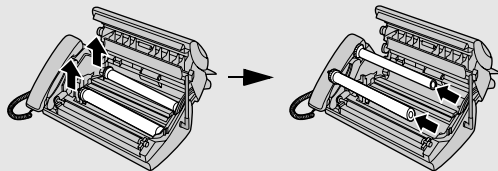

- 3** Remove the two green gears from the spools. **DO NOT DISCARD THE TWO GREEN GEARS!**

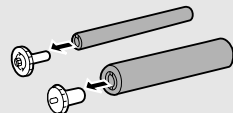

4 Remove the new roll of imaging film from its packaging.

- Cut the band that holds the rolls together.

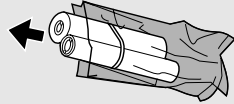

5 Insert the green gears.

Make sure the gears fit into the slots in the ends of the rolls.

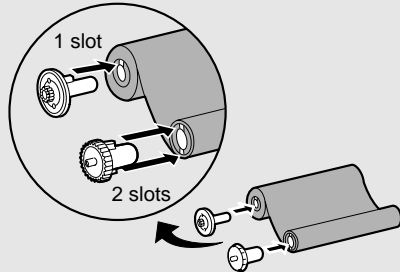

6 Insert the film into the print compartment.

Fit ends of rolls onto hubs

Thick roll to rear

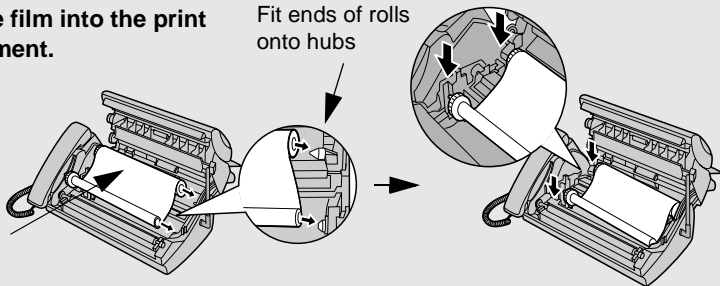

7 Rotate the front gear as shown until the film is taut.

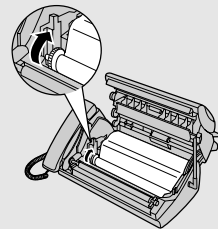

8 Close the operation panel (press down on both sides to make sure it clicks into place).

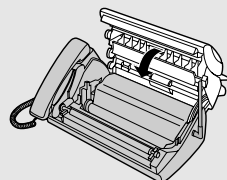

Loading Printing Paper

You can load letter or legal size paper in the paper tray. Recommended paper weight is 20-lb. Copy Bond. The maximum number of sheets is as follows:

Letter size: Approx. 50 sheets (20-lb. copier paper at room temperature; maximum stack height should not be higher than the line on the tray)

Legal size: 5 sheets

- 1 Fan the paper, and then tap the edge against a flat surface to even the stack. Make sure the stack edges are even.**

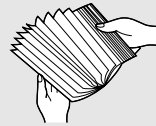

- 2 Insert the stack of paper into the tray, *PRINT SIDE DOWN*.**

- If paper remains in the tray, take it out and combine it into a single stack with the new paper.
- Be sure to load the paper so that printing takes place on the **print** side of the paper. Printing on the reverse side may result in poor print quality.
- **GENTLY LOAD PAPER INTO THE PAPER TRAY.**
- **DO NOT FORCE IT DOWN INTO THE FEED SLOT.**

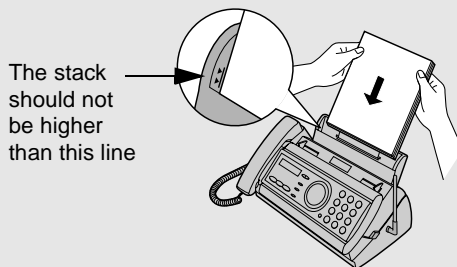

Note: Do not use paper that has already been printed on, or paper that is curled.

Note: If at any time the display shows the alternating messages at right, check the printing paper. If the tray is empty, add paper. If there is paper in the tray, take it out and then reinsert it.

When you are finished, press  .













ADD PAPER &



PRESS START KEY













Setting the paper size

The fax has been set at the factory to scale received faxes to letter size paper. If you loaded legal paper, you must change the paper size setting to LEGAL.

1	Press  once and  once.	Display: 
2	Press  once and  twice.	
3	Press  once.	
4	Select the paper size: LETTER:  LEGAL: 	The display briefly shows your selection, then: 
5	Press  to return to the date and time display.	

Print contrast setting

Your fax has been set at the factory to print at normal contrast. If desired, you can change the print contrast setting to LIGHT.

1	Press  once and  once.	Display: 
2	Press  once and  3 times.	
3	Press  once.	
4	Select the print contrast: NORMAL:  LIGHT: 	The display briefly shows your selection, then: 
5	Press  to return to the date and time display.	

Entering Your Name and Fax Number

Before you can begin sending faxes, you must enter your name and fax (telephone) number. You also need to set the date and time.



Once you enter this information, it will automatically appear at the top of each fax page you send.



Important!

FCC regulations require that your name, telephone/fax number, and the date and time appear on each fax message you send. Enter your name and fax number here and set the date and time as explained in the following section to have the fax machine include this information automatically at the top of your fax messages.

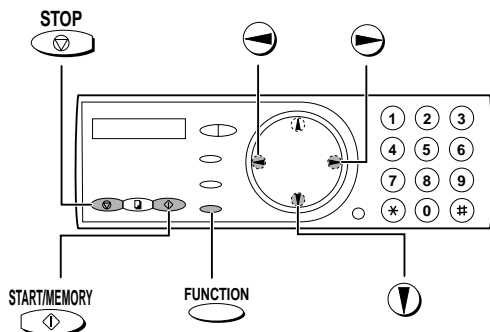

1 Press **FUNCTION** once and **STOP** 3 times.

Display:

ENTRY MODE

2 Press **FUNCTION** once.

OWN NUMBER SET

3 Press **FUNCTION** once.

ENTER FAX #

4 Enter your fax number by pressing the number keys (max. 20 digits).

- To insert a space between digits, press **#**.
- To clear a mistake, press **SPEAKER**.

5 Press **START/MEMORY to enter the fax number in memory.**

6 Enter your name by pressing number keys for each letter as shown in the chart below. Up to 24 characters can be entered.

Example: SHARP = 7777 44 2 777 **▶** 7

SPACE = 1	G = 4	N = 6 6	U = 8 8
A = 2	H = 4 4	O = 6 6 6	V = 8 8 8
B = 2 2	I = 4 4 4	P = 7	W = 9
C = 2 2 2	J = 5	Q = 7 7	X = 9 9
D = 3	K = 5 5	R = 7 7 7	Y = 9 9 9
E = 3 3	L = 5 5 5	S = 7 7 7 7	Z = 9 9 9 9
F = 3 3 3	M = 6	T = 8	

- ◆ To enter two letters in succession that require the same key, press **▶** after entering the first letter.
- ◆ To clear a mistake, press **SPEAKER**.
- ◆ To enter a lower case letter, continue pressing the key for the letter until the lower case letter appears. To enter one of the following symbols, press **#** or ***** repeatedly: . / ! " # \$ % & ' () * + , - : ; < = > ? @ [¥] ^ _ ' { | } → ←

7 Press **START/MEMORY.**

Display:

DATE&TIME SET **▶▶**

8 Press **STOP to return to the date and time display.**

Setting the Date and Time

The date and time appear in the display and are printed at the top of every page you fax. Set the date and time as shown below.

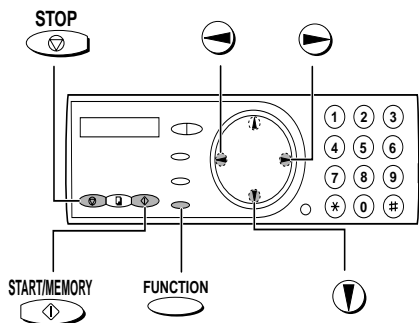
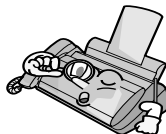

1 Press **FUNCTION** once and **STOP** 3 times. Display: **ENTRY MODE**

2 Press **RIGHT** once and **STOP** once. **DATE&TIME SET**

3 Press **RIGHT**. The currently set date appears (example): **DATE 08-15-2002**





4 Enter a two-digit number for the month ("01" for January, "02" for February, "12" for December, etc.).





Example: January **0** **1** → **DATE 01-15-2002**

- To correct a mistake, press **LEFT** to move the cursor back to the mistake and then enter the correct number.



5 Enter a two-digit number for the day ("01" to "31").

Example: the 5th **0** **5** → **DATE 01-05-2002**

6 Enter the year (four digits). The currently set time appears (example):
 Example: 2002     → TIME 12:19 PM

7 Enter a two-digit number for the hour (“01” to “12”) and a two-digit number for the minute (“00” to “59”).
 Example: 9:25     → TIME 09:25 PM



8 Press  to select A.M. or  to select P.M.

9 Press  to start the clock. → ANTI JUNK # 

10 Press  to return to the date and time display.

Daylight Saving Time

If desired, you can set the clock to move forward and backward automatically at the beginning and end of Daylight Saving Time. Follow these steps:

1 Press  once and  once. OPTION SETTING 

2 Press  once and  5 times. DAY LIGHT SAVE 

3 Press  once. 1=YES, 2=NO

4 Press  to select YES, or  to select NO. RECEIVE RATIO 

5 Press  to return to the date and time display.

Setting the Reception Mode

Your fax has three modes for receiving incoming faxes:

FAX mode:

Select this mode when you only want to receive faxes on your line. The fax machine will automatically answer all calls on four rings and receive incoming faxes.

TEL mode:

Select this mode when you want to receive both phone calls and faxes on the line connected to the fax machine. **All calls, including faxes, must be answered by picking up the fax machine's handset** or an extension phone connected to the same line.

TAD mode:

Select this mode when you go out and want the answering system to answer all calls. Voice messages will be recorded, and fax messages will be received automatically ("TAD" stands for "Telephone Answering Device").

Setting the reception mode

Make sure a document *is not loaded in the document feeder*, and then

press  until the arrow in the display points to the desired mode.

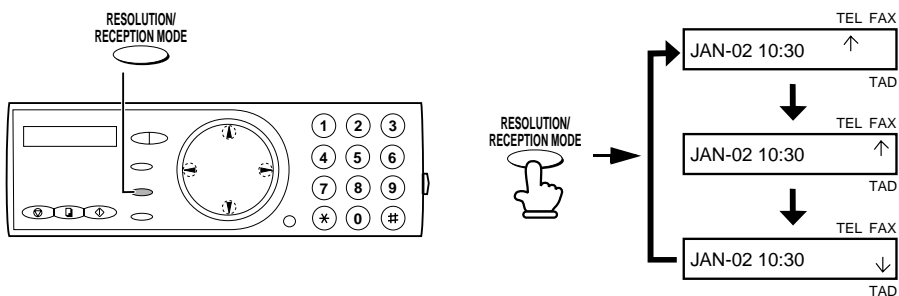

Note: TAD mode cannot be selected unless a general outgoing message has been recorded as explained on page 48.

For more information on receiving faxes in FAX and TEL modes, see Chapter 5, *Receiving Faxes*. For more information on using TAD mode, see Chapter 3, *Using the Answering System*.

Volume Adjustment - Fax Machine

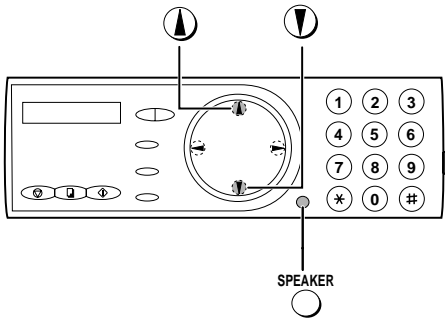

You can adjust the volume of the speaker, handset, and ringer using the up and down arrow keys.



Speaker

1 Press  .

2 Press  or  to select the desired volume level.

- Press  again to turn off the speaker.

Fax machine handset

1 When talking through the handset, press  or  to select the desired volume level.

- **Note:** The volume reverts to MIDDLE each time you replace the handset.

Display:

RECEIVER: HIGH



RECEIVER: MIDDLE



RECEIVER: LOW

Fax machine ringer

- 1** Press  or  to select the desired volume level.

(Make sure ^{SPEAKER}  has not been pressed, the handset is not lifted, and a document is not loaded in the feeder.)

- The ringer rings once at the selected level, and then the date and time reappear in the display.

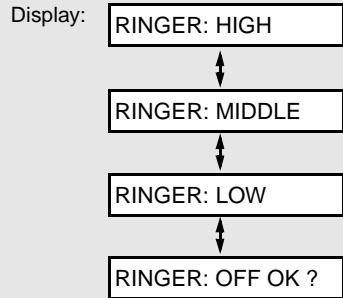

- 2** If you selected “RINGER: OFF OK ?” to turn off the ringer, press ^{START/MEMORY} .

Volume Adjustment - Cordless Handset

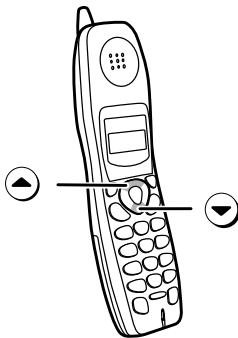

You can adjust the volume of the ringer and handset, receiver using the up and down arrow keys.

Cordless handset receiver volume

- 1** When talking on the cordless handset, press ▲ or ▼ to select the desired volume level.

- **Note:** The volume reverts to MIDDLE each time you hang up (press ).

Cordless handset display:

RECEIVER: HIGH



RECEIVER: MIDDLE



RECEIVER: LOW

Cordless handset ringer

- 1** When you are not talking on the cordless handset, press ▲ or ▼ to select the desired ringer volume level.

- The ringer will ring once at the selected level.

Cordless handset display:

RINGER: HIGH



RINGER: MIDDLE



RINGER: LOW





RINGER: OFF OK ?
OK: PRESS START

- 2** If you selected “RINGER: OFF OK ?” to turn off the ringer, press .

2. Using the Cordless Handset

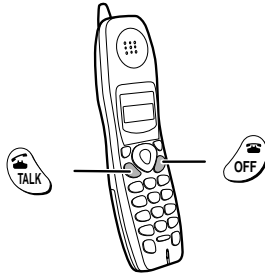
Making a Phone Call



- 1 Pick up the cordless handset and press  .

Cordless handset display:

TALK

- 2 When you hear the dial tone, dial the number.



- 3 When you are ready to end the call, press  .

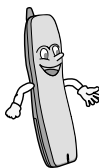

- You can also end the call by simply placing the cordless handset in the charger.



If the display shows FAX BUSY, you must wait until the fax machine is no longer in use to use the cordless handset.



You can also dial by entering the phone number first and then pressing .

Check the number in the display before pressing . If there is a mistake, press  to clear the mistake and then enter the correct digits.

Note: If a pause is needed between any of the digits to access an outside line or a special service, press . The pause will appear as a hyphen (-).

Receiving a Phone Call



1 When the cordless handset rings, pick it up and press any key (except ) to answer. Talk to the other party.

- If the cordless handset is in the charger, simply pick it up to answer (you do not need to press a key).

2 When you are ready to end the call, press .

- You can also end the call by simply placing the cordless handset in the charger.

Putting a Call on Hold

To put the other party on hold during a call, press . The cordless handset will beep while the call is on hold. When you are ready to resume the call, press  once again. Note that placing the cordless handset in the charger will not break the connection while a call is on hold, and thus phone charges may continue to apply.

Receiving a Fax Using the Cordless Handset

If you hear a fax tone after answering a call on the cordless handset, or if the other party speaks to you and then wants to send a fax, press . This signals the fax machine to begin fax reception.

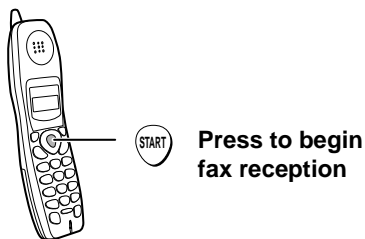

Note: If the fax machine detects a fax signal after you answer a call on the cordless handset, it will begin reception automatically.

Storing and Using Auto-Dial Numbers



You can store your most frequently dialed numbers for automatic dialing. Numbers can be stored in the Common book or the Private book.

- ◆ Up to 40 numbers can be stored in the Common book. These numbers are shared with the fax machine and other cordless handsets, and can be stored using a cordless handset as explained below, or the fax machine as explained on page 74.
- ◆ Up to 5 numbers can be stored in the Private book. Each cordless handset has its own Private book, and the numbers are stored using the cordless handset as explained below.

1 Press  SEARCH.

Cordless handset display:

SELECT SEARCH
▲: COMMON
▼: PRIVATE

2 Press  to select the Common book,
or  to select the Private book.



Example: Common book selected

COMMON DIAL
▲▼: SEARCH
FUNCTION: ENTRY

3 Press  .

ENTER TEL #

























































4 Enter the number by pressing the number keys.
(Note: A space cannot be entered.)



- To clear a mistake, press  .
- If a pause is required between any of the digits to access a special service or an outside line, press  . The pause appears as a hyphen (two seconds per pause). Several pauses can be entered in a row.

5 Press  .



6 Enter a name by pressing number keys for each letter as shown in the chart below. Up to 15 characters can be entered. (If you do not wish to enter a name, go directly to Step 7.)

Example: SHARP = 7777 44 2 777  7

SPACE = 	G = 	N =  	U =  
A = 	H =  	O =   	V =   
B =  	I =   	P = 	W = 
C =   	J = 	Q =  	X =  
D = 	K =  	R =   	Y =   
E =  	L =   	S =    	Z =    
F =   	M = 	T = 	

- ◆ To enter two letters in succession that require the same key, press  after entering the first letter.
- ◆ To clear a mistake, press  .

Storing and Using Auto-Dial Numbers

- ◆ To enter a lower case letter, continue pressing the key for the letter until the lower case letter appears.
- ◆ To enter one of the following symbols, press  or  repeatedly:
./!"#\$%&'()*+,-:;<=>?@[¥]^_`{|}~→←

7 Press .

SELECT SEARCH
▲: COMMON
▼: PRIVATE



8 Return to Step 2 to store another number, or press  to exit.

Dialing an auto-dial number

1 Press  SEARCH once.

Cordless handset display:

SELECT SEARCH
▲: COMMON
▼: PRIVATE

2 Press  to select the Common book,
or  to select the Private book.

Example: Common book selected

COMMON DIAL
▲▼: SEARCH
FUNCTION: ENTRY

3 Press  or  until the number you wish to dial appears in the display.

4 Press .

- The number is automatically dialed.



Editing an auto-dial number

If you need to make changes to a previously stored auto-dial number, follow these steps:

1 Press  **SEARCH** once.



Cordless handset display:

SELECT SEARCH
 ▲: COMMON
 ▼: PRIVATE

2 Press  to select the **Common** book,
or  to select the **Private** book.



Example: Common book selected

COMMON DIAL
 ▲▼: SEARCH
 FUNCTION: ENTRY

3 Press  or  until the number you wish to edit appears in the display.

4 Press  **once**.

5 Press the number keys to enter the new number.

- To clear a mistake, press . If a pause is required between any of the digits to access a special service or an outside line, press .
- If you do not wish to change the number, go directly to Step 6.

6 Press .

7 Press the number keys to enter the new name (see Step 6 on page 37).

- If you do not wish to change the name, go directly to Step 8.

8 Press .

SELECT SEARCH
 ▲: COMMON
 ▼: PRIVATE

9 Press  to exit.



Clearing an auto-dial number

If you need to clear an auto-dial number, follow these steps:

1 Press  SEARCH once.

Cordless handset display:

SELECT SEARCH
▲: COMMON
▼: PRIVATE

2 Press  to select the Common book,
or  to select the Private book.

Example: Common book selected

COMMON DIAL
▲▼: SEARCH
FUNCTION: ENTRY

3 Press  or  until the number you wish to clear appears in the display.

4 Press  ERASE.

ERASE?
PRESS START KEY

5 Press .

SELECT SEARCH
▲: COMMON
▼: PRIVATE

6 Press  to exit.

Redial



You can automatically redial the last number dialed on the cordless handset.

Note: The fax machine and cordless handsets each retain their own separate redial numbers. Note that the cordless handset redial numbers will be lost if the fax machine is unplugged or an interruption occurs in the power supply.

1 Press .

- Check the display to make sure the number that appears is the number you wish to dial. (If the wrong number appears, press  to clear it.)

2 Press . The number is automatically dialed.

Note: You can also redial by pressing  first and then  . Note that this method does not allow you to check the number before dialing begins.

Using the Intercom Feature



You can use the fax machine and cordless handsets as an intercom system.

- ◆ When using the Intercom feature, you will not hear your voice through the handset receiver when you speak.
- ◆ It may not be possible to page another cordless handset or the fax machine when other cordless handsets or the fax machine are already in use.

Paging the fax machine from a cordless handset

1 Press on the cordless handset.

The numbers and names of the other cordless handsets appear (even the numbers of cordless handsets that are not registered)

Cordless handset display example:

2: BILL
3: SUE
4:

- 2** Press **0** on the cordless handset to select the fax machine.

Cordless handset display:

INTERCOM
0: BASE STATION

- 3** The fax machine rings.

Fax machine display:

INTERCOM

Number and name of calling handset →

↑ ↓
1: BOB

- 4** The other person picks up the fax machine handset to answer.

- 5** Talk with the other person. When you are ready to end the conversation, press **OFF**.

Paging a cordless handset from another cordless handset (walkie-talkie feature)

The cordless handsets can be used for walkie-talkie like communication. The talking range of the cordless handsets is 1000 ft. (300 m), and there is no need to be in the talking range of the fax machine.

- 1** Press **INTERCOM** on the cordless handset.

The numbers and names of the other cordless handsets appear (even the numbers of cordless handsets that are not registered) →

Cordless handset display example:

2: BILL
3: SUE
4:

- 2** Enter the number of the cordless handset that you wish to page.

INTERCOM
2: BILL

Example: **2^{ABC}**



- To page all cordless handsets and the fax machine, press ***^{DEF}**.

3 The selected cordless handset rings.

Number and name
of calling handset

Display of paged handset:

INTERCOM
1: BOB

4 The other person presses any key (except ) on the cordless handset to answer.**5 Talk with the other person. When you are ready to end the conversation, press .*****Paging a cordless handset from the fax machine (cordless handset locator)***

You can use this procedure to page a cordless handset, or locate a handset in the event that you misplace it.

1 Pick up the fax machine handset.**2 Press  on the fax machine, and enter the number of the cordless handset that you wish to page.**

Example: 

- To page all of the cordless handsets, press .

Fax machine display:

INTERCOM

3: SUE

3 The selected cordless handset rings.

- This allows you to locate the cordless handset if you have misplaced it.

Display of selected
cordless handset:

INTERCOM
0: BASE STATION

4 The other person presses any key (except ) on the cordless handset to answer.

5 Talk with the other person. When you are ready to end the conversation, replace the handset.

If a call comes in while the Intercom feature is being used

If an outside call comes in while you are using the Intercom feature, the person who wishes to take the call should first stop the Intercom call (press



on the cordless handset or replace the fax machine handset), and then

answer the outside call (press any key except  on the cordless handset or pick up the fax machine handset).

Transferring Calls

You can transfer a call to the fax machine or to a cordless handset.

Note: It is not possible to talk to the recipient of a transfer call before transferring.

Transferring a call from a cordless handset to the fax machine or to another cordless handset

1 During the call, press  on the cordless handset.

- The call is placed on hold.

The numbers and names of the other cordless handsets appear (even the numbers of cordless handsets that are not registered)

Cordless handset display example:



2: BILL
3: SUE
4:

2 To transfer the call to the fax machine, press .

To transfer the call to a cordless handset, enter the number of the handset.

- To page the fax machine and all cordless handsets, press .



CALL TRANSFER





CALL TRANSFER

The fax machine and cordless handsets all show the above message, regardless of which is selected.

3 The selected cordless handset or fax machine rings.

4 The other person answers on the cordless handset or fax machine.

- To answer on a cordless handset other than the selected cordless handset, press  on that cordless handset. To answer on the fax machine when not selected, pick up the fax machine handset.
- If nobody answers for one minute when you page the cordless handset or fax machine, your cordless handset will ring to alert you. Press  to return to the initial caller. (Note that if you take no action after your cordless handset rings, the initial caller will be disconnected.)

Transferring a call from the fax machine to a cordless handset

1 During the call, press on the fax machine.

- The call is placed on hold.

Fax machine display:

PRESS HANDSET #

This message alternates with the numbers and names of the cordless handsets

2 Enter the number of the cordless handset to which you wish to transfer the call.

Fax machine display:

REPLACE HANDSET

Example: .

- To page all of the cordless handsets, press .

- 3** Replace the fax machine handset. The selected cordless handset rings.

Fax machine display:

CALL TRANSFER

Displays of all cordless handsets

CALL TRANSFER

- 4** The other person presses any key (except ) on the cordless handset to answer.

- To answer on a cordless handset other than the selected cordless handset, press  on the other cordless handset.
- If no one answers for one minute when you page the cordless handset, the fax machine will ring to alert you. Pick up the fax machine handset to return to the initial caller. (Note that if you take no action after the fax machine rings, the initial caller will be disconnected.)

Note: When a cordless handset is paged, it will continue ringing until the paging is answered, even if  is pressed on the cordless handset or the cordless handset is placed in the charger.

Changing the reception mode on the fax machine

- 1** Press .

Cordless handset display:

REMOTE MODE

- 2** Press  until the desired reception mode appears in the display.

Example: FAX mode

RECEPTION
FAX

- 3** Press  or  to exit REMOTE MODE.

3. Using the Answering System

The answering system allows you to receive both voice messages and faxes while you are out.

The answering system has one general box and four personal boxes for callers to leave messages.



To use the answering system, you must record a greeting for the general box, and a greeting for each personal box you wish to use.

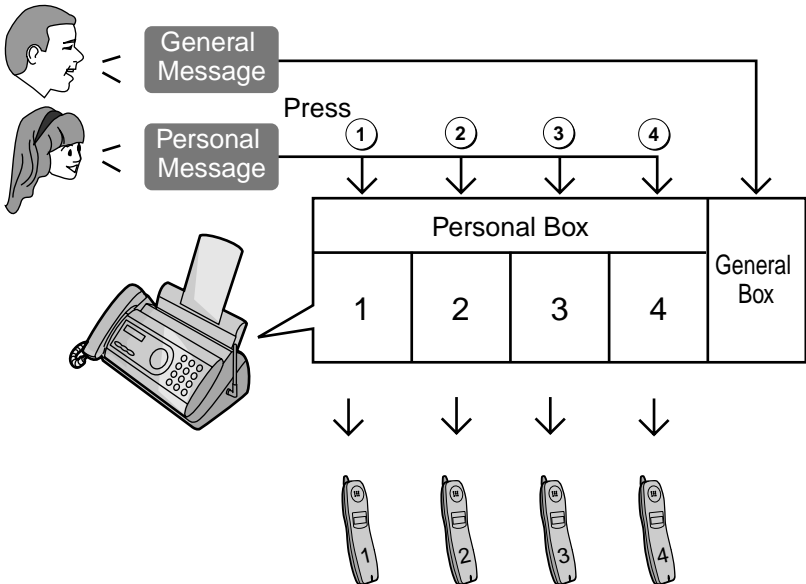
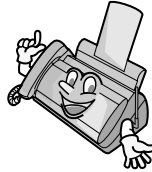

Each cordless handset can be used to listen to the messages in its corresponding personal box (the personal box with the same number as the cordless handset).
(A personal box can still be used even if you do not have the corresponding accessory cordless handset.)

Recording an Outgoing Message

The outgoing message (OGM) is the greeting that the system plays after answering a call to inform callers that they can leave a message or send a fax. Follow the steps below to record an outgoing message for the general box, and an outgoing message for each personal box that you wish to use.





Example of general outgoing message:

“Hello. You’ve reached _____. No one is available to take your call right now. If you would like to leave a general message, please speak after the beep. If you would like to leave a personal message, press **1** for Susan, **2** for Bob, **3** for George, or **4** for Ann now. To send a fax, please press your facsimile Start key now. Thank you for calling.”

Example of personal outgoing message:

“This is Susan’s personal box. Please leave a message after the beep.”

Note: Do not lift the handset until Step 3 below.

<p>1 Press .</p>	<p>Display: MEMO RECORDING ⇄</p>
<p>2 Press  until the message you wish to record appears in the display. (“OGM (GENERAL)” for the general box, “OGM (BOX 1)” for personal box 1, “OGM (BOX 2)” for personal box 2, etc.)</p>	<p>MEMO RECORDING ⇄</p> <p>↓</p> <p>OGM (GENERAL) ⇄</p> <p>↓</p> <p>OGM (BOX 1) ⇄</p> <p>↓</p> <p>OGM (BOX 4) ⇄</p> <p>↓</p> <p>OGM (TRANSFER) ⇄</p>
<p>3 Press  once.</p> <ul style="list-style-type: none"> (If you have already recorded a message and wish to check it, press .) 	<p>LIFT HANDSET OR</p> <p>↑ ↓</p> <p>PLAY: PLAYBACK</p>

4 Lift the handset.



5 Press **START/MEMORY** and speak into the handset to record the message.

- While recording, the display will show the time left to record.

6 When finished, replace the handset or press **STOP**.

To listen to an outgoing message

To listen to an outgoing message, follow Steps 1 and 2 of the above procedure and then press **▶PLAY**. Note that the general outgoing message cannot be erased. If you need to change it, simply repeat the recording procedure.

Setting a Passcode for a Personal Box

You can set a 3-digit passcode for each personal box. When this is done, the passcode must be entered to listen to messages in a personal box at the fax machine.

(Note: When listening to the messages in a personal box from its corresponding cordless handset, is not necessary to enter the passcode.)

1 Press **FUNCTION** once and **▼** once.

Display:

T.A.D. SETTING ◀▶

2 Press **▶** once and **▲** once.

BOX PASSCODE ◀▶

3 Press **▶**.

1=SET, 2=CLEAR

4 Press  to set a passcode.

ENTER BOX # (1-4)

(To clear a previously set passcode, press .)

5 Enter the number of the personal box for which you wish to set a passcode.

ENTER PASSCODE

Example:  for Box 1

(If you are clearing a passcode, enter the number of the box and go to Step 7.)

6 Enter a 3-digit number for the passcode. The first digit of the number must be 0, 5, 6, 7, 8, or 9.

7 Press .

ENTER BOX # (1-4)

8 Return to Step 5 to set another passcode, or press  to return to the date and time display.

Note: If you wish to change a passcode, clear the passcode and then enter a new passcode. If you forget a passcode, clear it and enter a new passcode.

Operating the Answering System

Activating the answering system

To turn on the answering system so that callers can leave messages, press

 until the arrow in the display points to TAD. (TAD stands for "Telephone Answering Device".)

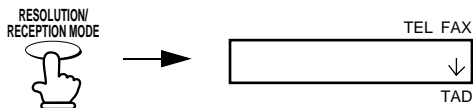

- ◆ Each outgoing message will play (to stop playback, press ).
- ◆ It will not be possible to set the reception mode to TAD if a general outgoing message has not been recorded.

Note: In TAD mode, the machine will automatically switch to fax reception if it detects 6 seconds of silence after answering a call. For this reason, if a caller pauses for this length of time while leaving a message, they will be cut off.

Number of rings in TAD mode (Toll Saver function)

The number of rings on which the machine answers incoming calls in TAD mode depends on whether the Toll Saver function is turned on, and if it is on, whether you have messages.

- ◆ The Toll Saver function is initially turned on.

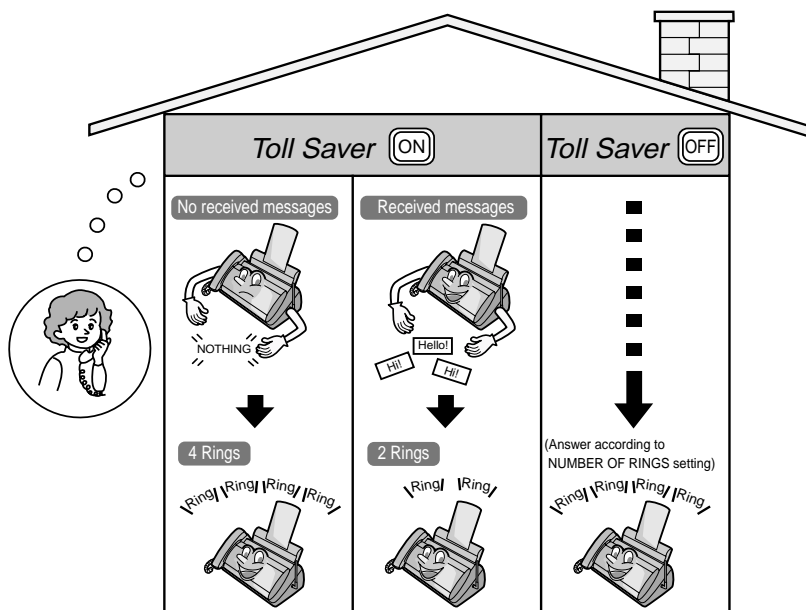

To turn off the Toll Saver function, see page 63.

To adjust the NUMBER OF RINGS setting, see page 83.

Listening to received messages (at the fax machine)

When you return, the fax machine display will show the number of messages recorded in each box. Follow the steps below to listen to your messages.

1 Press  .

- If you only want to listen to new messages (messages not previously listened to), continue to hold  down for at least two seconds.



2 If you wish to listen to the messages in a personal box, press the number of the box.

Example:  for Box 1

3 Enter the passcode of the personal box.

Example:   

4 The messages will play.







- As each message plays, the date and time of recording will appear briefly in the display. If no messages were received, NO MESSAGES will appear.
- **Repeat:** To listen to a message a second time, press  before playback of that message ends. To move back to the previous message, press  within 3 seconds of the beginning of the current message.
- **Skip:** To skip forward to the next message, press  .

Note: Playback will stop if you receive a call, lift the handset, or press  .

- ◆ You can print out a list of your received messages that shows the date and time that each was received. See page 99.





Erasing received messages

It is important to erase received messages after you listen to them to ensure that the memory does not become full.



- ◆ **Erasing all messages in the general box:** To erase all messages in the general box, press ,  **DELETE**, and then .
- ◆ **Erasing all messages in a personal box:** To erase all messages in a personal box, press ,  **DELETE**, enter the number of the box, enter the passcode, and then press .
- ◆ **Erasing a single message:** To erase a single message, press  **DELETE** while the message is being played.

Recording memos

You can record memos for yourself and other users of the machine. These are recorded in the general box, and will be played back together with incoming messages when the  key is pressed.

- 1 Press  once and  once.
- 2 Pick up the handset, press , and speak into the handset.
- 3 When you have finished speaking, replace the handset or press .

Recording phone conversations

To record a phone conversation, hold down the  key during the conversation you want to record. When you are finished, release the key. The conversation is recorded in the general box, and will be played back when the  key is pressed.

Listening to messages from a cordless handset

You can use your cordless handset to listen to messages received in your personal box (the personal box with the same number as your cordless handset), or messages received in the general box.

- ◆ When you have received new messages in your personal box, NEW MESSAGES appears in your cordless handset display.

1 Press .



Cordless handset display:

REMOTE MODE

2 If you wish to listen to messages in the general box, press  .
(Otherwise, go directly to Step 3.)

3 Press  to listen to all messages in the box, or  to listen to only new messages.

4 While listening to your messages, you can do any of the following:

- **Repeat:** To repeat a message, press .
- **Skip:** To skip forward, press .
- **Delete:** To delete the message you are currently listening to, press .

- **Stop:** To stop playback, press  .

5 To return to the STAND-BY display, press  **or**  .

- If a call comes in while you are listening to your messages, playback will stop automatically. Press any key to answer.
- If you take no action for 60 seconds in REMOTE MODE, the cordless handset will automatically return to the STAND-BY display.

Deleting all messages from a cordless handset

You can use your cordless handset to delete all messages in your personal box, or all messages in the general box.

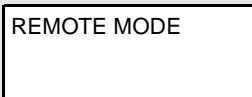

1 Press  .
 (Note: This step is not necessary if you are already in REMOTE MODE.)

Cordless handset display:

2 If you wish to delete all messages in the general box, press  .
 (Otherwise, go directly to Step 3.)

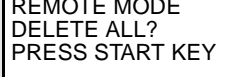
3 Press  .



4 Press  **to delete the messages, and then**  **or**  **to return to the STAND-BY display.**

- To cancel, press  ,  , or  .

Optional Answering System Settings

Setting ICM time

Incoming messages (ICMs) are the messages which callers leave for you in the answering system. The answering system is set at the factory to allow each caller a maximum of 4 minutes to leave a message. If desired, you can change this setting to 15, 30, or 60 seconds.

1 Press **FUNCTION** once and **▼** once.

Display:

T.A.D. SETTING 

2 Press **▶** once and **▼** once.

RECORDINGTIME 

3 Press **▶**.

4 Press a number from 1 to 4 to select the desired ICM recording time.

1 15 seconds

3 60 seconds

2 30 seconds

4 4 minutes

The display briefly shows your selection, then:

REMOTE CODE 

5 Press **STOP** to return to the date and time display.











Fax reception on TAD failure

If the memory for recording incoming messages becomes full while you are out, the answering system will no longer be able to record messages. The ON TAD FAILURE setting is used to choose the response of the machine to incoming calls when this happens:

- ◆ Automatic fax reception NO: The machine will answer after 20 rings, after which it will wait to receive a remote command. Most callers will hang up before it answers; however, when you call the machine from a remote location, you can wait until it answers, listen to your messages, and then erase them (see *Remote Operations* on page 62).







- ◆ Automatic fax reception YES: The reception mode will switch to FAX mode, allowing the machine to continue to receive faxes automatically. With this setting, you can still use the remote commands to listen to your messages and then erase them (see *Remote Operations* on page 62).

Automatic fax reception is set to NO at the factory before shipping. If you want to set it to YES, press the panel keys as follows:

1 Press  once and  once.	Display: <div style="border: 1px solid black; padding: 2px; display: inline-block;">T.A.D. SETTING </div>
2 Press  once and  4 times.	<div style="border: 1px solid black; padding: 2px; display: inline-block;">ON TAD FAILURE </div>
3 Press  .	<div style="border: 1px solid black; padding: 2px; display: inline-block;">1=YES, 2=NO</div>
4 Press  to turn on automatic fax reception, or  to turn it off.	The display briefly shows your selection, then: <div style="border: 1px solid black; padding: 2px; display: inline-block;">OGM ONLY MODE </div>
5 Press  to return to the date and time display.	



OGM only mode

If needed, you can turn off recording of incoming messages. In this case, your outgoing message will play, but callers will not be able to leave a message (this applies to all boxes). The machine will still receive faxes sent by automatic dialing.

1 Press  once and  once.	Display: <div style="border: 1px solid black; padding: 2px; display: inline-block;">T.A.D. SETTING </div>
2 Press  once and  3 times.	<div style="border: 1px solid black; padding: 2px; display: inline-block;">OGM ONLY MODE </div>

3 Press .

1=YES, 2=NO

4 Press  to turn on OGM only mode,
or  to turn it off.

The display briefly shows
your selection, then:

CPC DETECTION 

5 Press  to return to the date and time display.

CPC Detection



When a caller hangs up, the central telephone exchange issues a CPC (Calling Party Control) signal. When the answering system detects this signal, it stops recording so that periods of silence are not recorded.

However, if you subscribe to special services such as Call Waiting or Call Forwarding, signals used by these services may be mistaken for a CPC signal, causing the answering system to hang up during a call. If you experience this problem, follow these steps to turn off CPC Detection.

1 Press  once and  once.

Display:



T.A.D. SETTING 

2 Press  once and  twice.

CPC DETECTION 

3 Press .

1=YES, 2=NO

4 Press  to turn on CPC Detection,
or  to turn it off.

The display briefly shows
your selection, then:

BOX PASSCODE# 

5 Press  to return to the date and time display.

Transfer Function



The Transfer function is used to have the machine automatically call you at a specified number every time it receives an incoming message in a specified box. This lets you hear your messages immediately after they come in, even when you are at a remote location.

To use the Transfer function, you must first program the number that you wish the machine to call (the transfer number), and record the transfer message that plays when you answer the phone at the remote location.

When you go out and wish to use the transfer function, turn it on. When you return and no longer wish to use the transfer function, turn it off.



Programming the transfer number

To use the Transfer function, you must first give the machine the number to call (the transfer number).

1 Press  once and  once.

Display:

T.A.D. SETTING 

2 Press  once and  3 times.

TRANSFER TEL # 

3 Press .

ENTER TEL #

4 Press the number keys to enter the transfer number.

- To insert a pause between any two digits of the number, press .

5 Press .



6 Press  to return to the date and time display.



Recording the transfer message

The transfer message plays when you answer the telephone, and informs you that the call is a transfer call. The following is an example:

“Hello. This is a transfer call for (YOUR NAME). Enter your remote code number now.”

Note: Do not lift the handset until Step 3 below.

- 1** Press  once and  once. Display: OGM (TRANSFER) 



- 2** Press  once.
 - If you have already recorded a message, you can press  to listen to the message, or press  to delete the message.
DELETE

- 3** Lift the handset. 

- 4** Press  and speak into the handset to record the message.
 - The transfer message can be up to 15 seconds long. While recording, the display will show the time left to record.



- 5** When finished, replace the handset or press .

Checking or erasing the transfer message

To check or erase the transfer message, follow Steps 1 and 2 of the above procedure, and then press  to check the message, or  to erase the message.
DELETE



Turning the Transfer function on and off

When you go out and wish to use the Transfer function, turn it on as follows:

- 1** Press  once and  once.

Display:



T.A.D. SETTING 

- 2** Press  once and  4 times.

TRANSFER FUNC 

- 3** Press .

1=YES, 2=NO



- 4** Press  to turn on the Transfer function.
(Press  to turn the function off.)

The display briefly shows your selection, then:





ON TAD FAILURE 

- 5** Press the number of the box for which you want the Transfer function to operate (for the general box, press .

- 6** Press  to return to the date and time display.

- 7** Each time the machine receives an incoming message, it will call your programmed transfer number. When you answer, you will hear your recorded message telling you that the call is a transfer call. On the dial pad of your phone, enter , your remote code number (see page 62) if the general box was selected in Step 5, or the box passcode number if a personal box was selected, and then . Your messages will play.

- You can also perform any of the remote operations described in *Remote Operations* later in this chapter (see page 62).

Note: When you hang up after a transfer call, the machine will not immediately resume normal operation. If you want the machine to accept calls immediately after a transfer call, enter  twice before hanging up (if hanging up during message playback, first enter  and  to stop playback, then enter  twice).

Remote Operations

When you are out, you can call the machine from any touch-tone telephone and play back your messages using the remote commands. You can also use these commands to change the reception mode and other settings.

Remote code number



After calling the machine, you must enter your remote code number to listen to messages in the general box, or to messages in a personal box that does not have a passcode.

The remote code number has been set to "001" at the factory. To change the number, follow the steps below.

1 Press  once and  once.

Display:

T.A.D. SETTING 

2 Press  once and  twice.

REMOTE CODE 

3 Press .

4 Press the number keys to enter a 3-digit remote code number.

5 Press  to store the remote number.

TRANSFER TEL # 

6 Press  to return to the date and time display.

Toll Saver

When you call the machine to listen to your messages, it will answer after two rings if it has received at least one message in any of the boxes, or after four rings if it has not received any messages.

This allows you to save money on telephone charges, particularly if you are calling long distance. If the machine does not answer after the second ring, you can simply hang up before it answers, saving yourself the cost of that call.

If you do not want to use the Toll Saver function, you can turn it off by following the steps below. In this case, the machine will answer after the number of rings set with the NUMBER OF RINGS setting (see *Changing the number of rings* on page 83).

1 Press **FUNCTION** once and **▼** once.

Display:

T.A.D. SETTING 

2 Press **▶** once.

TOLL SAVER 

3 Press **▶** once.

1=YES, 2=NO

4 Press **1** to turn on the Toll Saver function, or **2** to turn it off.

The display briefly shows your selection, then:

RECORDINGTIME 

5 Press **STOP** to return to the date and time display.

Retrieving your messages

Note: You can only access one box per call. If you wish to access more than one box, you must make a separate call for each box.

1 Call the machine from a touch-tone telephone. When the general outgoing message begins, press **#** on the telephone.

- You will hear a short beep, and the outgoing message will stop.

2 If you wish to listen to the messages in a personal box, enter the number of that box (otherwise, go directly to Step 3).

Example: **1** for Box 1

3 If you are accessing the general box, enter your remote code. If you are accessing a personal box, enter the passcode of the box (if the box does not have a passcode, enter your remote code).

When finished, press **#**.

- You will hear a series of beeps equal to the number of messages recorded in the box, or one long beep if four or more messages have been received. The machine will then play back the messages, beeping once at the end of each message. When all messages have been played back, you will hear a long beep.
- If no messages have been received, you will hear a short beep. You can either hang up, or perform any of the operations described in the following section, *Other remote operations*.

4 While the messages are playing, you can do any of the following:

- **Repeat:** To listen to a message a second time, press **2** and **#** on the telephone before that message ends. To move back to the previous message, press **2** and **#** during the first 3 seconds of the current message.
- **Skip forward:** To skip forward to the next message, press **5** and **#** on the telephone.
- **Stop:** To stop playback, press **0** and **#** on the telephone. After this, you can enter any of the commands described in the following section, *Other remote operations*.
- **Play new messages:** To listen to only your new messages, first stop playback by pressing **0** and **#**, and then press **6** and **#**.
- **Erase a message:** To erase the message you are currently listening to, press **3** and **#** before it ends.

5 When you have finished listening to your messages, you can do any of the following:

- **Erase all messages:** Press **3**, **3**, and **#**.
- **Repeat playback:** Press **7** and **#**.
- **Perform other operations:** You can enter any of the commands described in the following section, *Other remote operations*.
- **Hang up:** If you do not erase your messages first, they will be saved and any new messages will be recorded after them. If you want the machine to resume normal operation immediately, press ***** twice before hanging up (in some cases, particularly when the Transfer function is used, the machine may not accept new calls for one or two minutes after you hang up unless you press ***** twice).

Note: You can also call the machine and perform remote operations when the reception mode is set to FAX. In this case, when you call the machine, press

Ⓜ immediately after it answers (before you hear the fax tone), and then continue from Step 2 above.

Comments:

- ◆ When a remote command is accepted by the machine, you will hear one beep. If an incorrect command is entered, you will hear four beeps. In the latter case, re-enter the correct command.
- ◆ When entering a command, do not pause longer than 10 seconds between each digit. If you do, you will hear a 4-beep error signal and the digits entered up to that point will be cleared. In this case, re-enter the command from the beginning.
- ◆ If you pause for longer than 10 seconds before entering a command, or make two errors while entering your remote code number, the line will be disconnected. (This prevents unauthorized people from attempting to guess your remote code number.)

Other remote operations

After listening to your messages, you can perform any of the following operations by pressing the appropriate keys on the telephone.

Note: The following commands cannot be entered while messages are being played back. If you do not want to wait until playback ends to enter a command, first stop playback by pressing Ⓜ and Ⓜ, and then enter the command.

Changing the fax reception mode

Select a new reception mode by pressing the keys as follows:

◆ **TAD mode:** Ⓜ, Ⓜ, and Ⓜ.

◆ **FAX mode:** Ⓜ, Ⓜ, and Ⓜ.

◆ **TEL mode:** Ⓜ, Ⓜ, and Ⓜ.

Caution: If you select TEL mode, you will not be able to change the reception mode again.

Recording a new outgoing message

Note: You can only record a new outgoing message for the box you accessed at the beginning of the call.

1 Press **4** and ***** on the telephone.

2 When you hear a short beep, speak into the telephone to record the new message.

- The message can be up to 15 seconds long. After 15 seconds (or earlier if the machine detects silence after you finish speaking), you will hear a beep, and the new message will be played back.

Turning the Transfer function on or off

To turn Transfer on: Press **9**, **1**, and **#** on the telephone, followed by the number of the box for which you want the Transfer function to operate (press **0** for the general box) and **#**.

To turn Transfer off: Press **9**, **2**, and **#** on the telephone.

Changing the transfer telephone number

1 Press **9**, **0**, and **#** on the telephone.

2 After you hear a short beep, enter the new telephone number. When finished, press **#**.

- To insert a pause between any two digits of the number, press *****.

Recording a new transfer message

- 1** Press **9**, **3**, and **#** on the telephone.

- 2** When you hear a short beep, speak into the telephone to record the new message.
 - The time for the transfer message is fixed at 15 seconds. After 15 seconds (or earlier if the machine detects silence after you finish speaking), you will hear a beep, and the new message will be played back automatically.

Recording a memo

You can record a memo for yourself or other users of the machine. The memo will be recorded in the general box.

- 1** Press ***** and **#** on the telephone.

- 2** When you hear a short beep, speak into the telephone to record the memo.

- 3** When you are finished, press **0** and **#** on the telephone.
 - If the machine detects silence, it will stop recording automatically.

OGM only mode

To turn on OGM only mode: Press **1**, **1**, and **#** on the telephone.
(Outgoing messages will play, but callers will not be able to record a message. Faxes sent by automatic dialling will be received)

To turn off OGM only mode: Press **1**, **2**, and **#** on the telephone.

4. Sending Faxes

Transmittable Documents

Size and weight

The size and weight of documents that you can load in the document feeder depend on whether you load one page at a time or several pages at once.

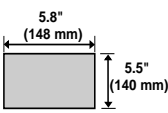
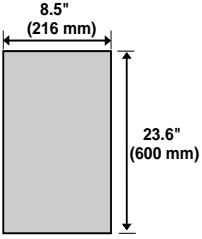
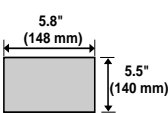
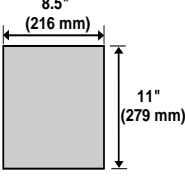
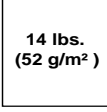
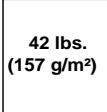
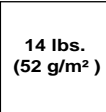
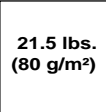
Loading one page at a time:		Loading up to 10 pages at once:	
Minimum size	Maximum size	Minimum size	Maximum size
			
Minimum weight	Maximum weight	Minimum weight	Maximum weight
			

Note: Letters or graphics on the edges of a document will not be scanned.

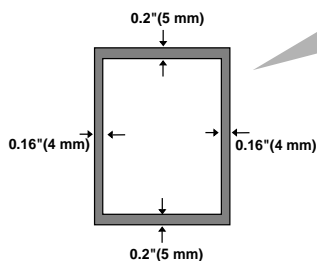

Letters in the shaded area will not be scanned.

The illustration shows the scanning margins for letter-size documents. The scanning width is 8.3" (210 mm). The horizontal margins decrease for smaller-width documents.

Other restrictions

- ◆ The scanner cannot recognize yellow, greenish yellow, or light blue ink.
- ◆ Ink, glue, and correcting fluid on documents must be dry before they pass through the document feeder.
- ◆ All clips, staples, and pins must be removed from documents before loading in the feeder. If these are not removed, they may damage the machine.
- ◆ Documents which are patched, taped, torn, smaller than the minimum size, carbon backed, easily smudged, or have a slick coated surface should be photocopied, and the copy loaded in the feeder.

Loading the Document

Up to 10 pages can be placed in the feeder at one time. The pages will automatically feed into the machine starting from the bottom page.

- ◆ If you need to send or copy more than 10 pages, place the additional pages gently and carefully in the feeder just before the last page is scanned. Do not try to force them in, as this may cause double-feeding or jamming.
- ◆ If your document consists of several large or thick pages which must be loaded one at a time, insert each page into the feeder as the previous page is being scanned. Insert gently to prevent double-feeding.

-
- 1** Adjust the document guides to the width of your document.

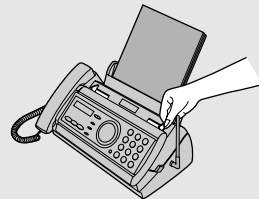

-
- 2** Insert the document face down in the document feeder. The top edge of the document should enter the feeder first.

- READY TO SEND will appear in the display.

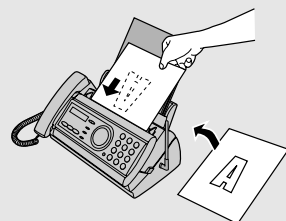

- 3** Adjust the resolution and/or contrast settings as explained in *Resolution and Contrast* below, then dial the receiving machine as explained on page 72.

Adjusting the Resolution and Contrast

If desired, you can adjust the resolution and contrast before sending a document.

The default resolution setting is STANDARD and the default contrast setting is AUTO.



You must adjust the settings each time you don't want to use the default settings.



Note: The resolution and contrast settings are only effective for sending a document. They are not effective for receiving a document.

Resolution settings

STANDARD	Use STANDARD for ordinary documents. This setting gives you the fastest and most economical transmission.
FINE	Use FINE for documents containing small letters or fine drawings.
SUPER FINE	Use SUPER FINE for documents containing very small letters or very fine drawings.
HALF TONE	Use HALF TONE for photographs and illustrations. The original will be reproduced in 64 shades of gray.

Contrast settings

AUTO

Use AUTO for normal documents.

DARK

Use DARK for faint documents.

1 Load the document(s).

- The document must be loaded before the resolution and contrast can be adjusted.

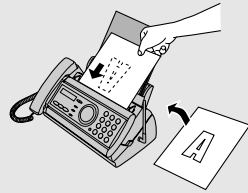

2 Press one or more times until the desired resolution and contrast settings appear in the display.

- The first time you move through the list of resolution settings, the contrast setting AUTO will appear next to each resolution setting. The second time you move through the list, the contrast setting DARK will appear.

Display:

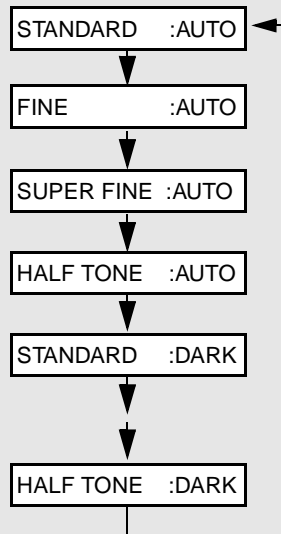

Note: In order to transmit in SUPER FINE resolution, the receiving fax machine must also have that resolution. If it doesn't, your machine will automatically step down to the next best available setting.

Sending a Fax by Normal Dialing

With Normal Dialing, you pick up the handset (or press ) and dial by pressing the number keys.

- ◆ If a person answers, you can talk with them through the handset before sending the fax. (If you pressed , you must pick up the handset to talk.)
- ◆ Normal Dialing allows you to listen to the line and make sure the other fax machine is responding.

1 Load the document(s).

- If desired, press  to set the resolution and/or contrast.

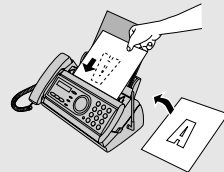

READY TO SEND

2 Pick up the handset or press . Listen for the dial tone.

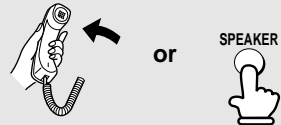

3 Dial the number of the receiving machine by pressing the number keys.



4 Wait for the connection. Depending on the setting of the receiving machine, you will either hear a fax tone or the other person will answer.

- If the other party answers, ask them to press their Start key (if you pressed , pick up the handset to speak with them). This causes the receiving machine to issue a fax tone.

5 When you hear the fax tone, press  . Replace the handset.

- If the transmission is completed successfully, the fax will beep once.
- If an error occurs, the fax will beep three times and print a Transaction Report to inform you of the problem (see page 101).

Note: If the transmission is unsuccessful and DOCUMENT JAMMED appears in the display, remove the document as explained on page 119. (This may occur if the other fax machine doesn't respond properly when you attempt to send the document.)

Sending a Fax by Automatic Dialing

You can store your most frequently dialed fax or phone numbers in the machine for automatic dialing.

- ◆ Auto-dial numbers can be stored using either the fax machine or the cordless handset (to store a number using the cordless handset, see page 36).
- ◆ Numbers stored using the fax machine are stored in the Common book. A total of 40 numbers can be stored.

Storing fax and phone numbers for automatic dialing

1 Press  once and  once.



Display:

<NEW NUMBER> 

2 Press  once.

ENTER FAX #

























































3 Enter the fax or voice number by pressing the number keys.
(Note: A space cannot be entered.)

- To clear a mistake, press  .
- If a pause is required between any of the digits to access a special service or an outside line, press  . The pause appears as a hyphen (two seconds per pause). Several pauses can be entered in a row.

4 Press  .



5 Enter a name by pressing number keys for each letter as shown in the chart below. Up to 15 characters can be entered. (If you do not wish to enter a name, go directly to Step 6.)

Example: SHARP = 7777 44 2 777  7

SPACE = 	G = 	N =  	U =  
A = 	H =  	O =   	V =   
B =  	I =   	P = 	W = 
C =   	J = 	Q =  	X =  
D = 	K =  	R =   	Y =   
E =  	L =   	S =    	Z =    
F =   	M = 	T = 	

◆ To enter two letters in succession that require the same key, press  after entering the first letter.

◆ To enter a lower case letter, continue pressing the key for the letter until the lower case letter appears.

◆ To enter one of the following symbols, press  or  repeatedly:
 . / ! " # \$ % & ' () + , - . : ; < = > ? @ [\] ^ _ ' { | } → ←

6 Press  .

Display:

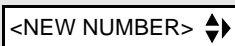

7 Return to Step 2 to store another number, or press  to return to the date and time display.

Note: The fax machine uses a lithium battery to keep automatic dialing numbers and other programmed information in memory when the power is turned off. Battery power is consumed primarily when the power is off. With the power kept continuously off, the life of the battery is about 5 years. If the battery dies, have your dealer or retailer replace it. Do not try to replace it yourself.



Editing and clearing auto-dial numbers

If you need to make changes to a previously stored auto-dial number, or clear a number, follow these steps:

1 Press  once and  once.

Display:



2 Press  or  until the number you wish to edit or clear appears in the display.

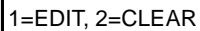

3 Press .



4 Press  for EDIT or  for CLEAR.



- If you selected CLEAR, go to Step 8.

5 If you selected EDIT, make the desired changes to the number.

- Press  or  to move the cursor to the digit or digits you wish to change, and then enter the new digit. The new digit will replace the old digit.
- If you do not wish to change the number, go directly to Step 6.

6 Press .

7 Make the desired changes to the name.

- Press  or  to move the cursor to the letter or letters you wish to change, and then press the appropriate number key repeatedly until the desired letter appears (see Step 5 on page 75). The new letter will replace the old letter.
- If you do not wish to change the name, go directly to Step 8.

8 Press **START/MEMORY** .

9 Return to Step 2 to edit or clear another number, or press **STOP**  to return to the date and time display.



Using an auto-dial number

Once you have stored a fax or phone number, you can use it to send a fax or make a phone call.

1 If you are sending a fax, load the document(s).

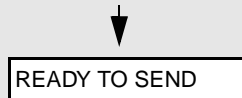
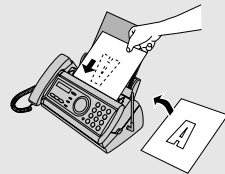
- If desired, press **RESOLUTION/RECEPTION MODE**  to set the resolution and/or contrast.



2 Press  (or ) until the name of the other party appears in the display (if no name was stored, the number will appear).

3 If you are sending a fax, press **START/MEMORY** . Dialing and transmission begins.

- If the transmission is completed successfully, the fax will beep once.
- If an error occurs, the fax will beep three times and print a Transaction Report to inform you of the problem (see page 101).

If you are making a phone call, lift the handset. Dialing begins.

Sending a fax by Direct Keypad Dialing

You can also enter a full number with the number keys and then press the **START/MEMORY**  key to begin dialing. You can use this method to dial a full number when you don't need to speak to the other party before faxing.

1 Load the document(s).

- If desired, press **RESOLUTION/RECEPTION MODE**  to set the resolution and/or contrast.

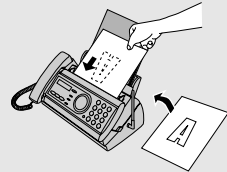

READY TO SEND

2 Enter the number of the receiving machine by pressing the number keys.

- If a pause is required between any of the digits to access a special service or an outside line, press **FUNCTION** . The pause will appear as a hyphen (two seconds per pause). Several pauses can be entered in a row.

3 Check the display. If the number of the receiving machine shown is correct, press **START/MEMORY .**

- If the number is not correct, press **STOP**  to backspace and clear one digit at a time, and then re-enter the correct digit(s).

Redial

You can automatically redial the last number dialed on the fax machine. This procedure can be used to send a fax or make a phone call.

Note: The fax machine and the cordless handset each retain their own separate redial numbers.

1 If you are sending a fax, load the document(s).

- If desired, press  to set the resolution and/or contrast.

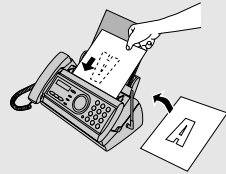

2 Press once. <REDIAL> appears in the display, followed by the last number dialed. Make sure the number that appears is the number you wish to dial.

3 If you are sending a fax, press . Dialing begins.

If you are making a phone call, lift the handset. Dialing begins.

Note: If a fax transmission is unsuccessful and DOCUMENT JAMMED appears in the display, remove the document as explained on page 119. (This may occur if the other fax machine doesn't respond properly when you attempt to send the document.)

Automatic redialing

If you use automatic dialing (including Direct Keypad Dialing) to send a fax and the line is busy, the fax machine will automatically redial the number. The fax machine will make three redial attempts at intervals of five minutes. During this time, RECALLING will appear in the display, followed by a two-digit number assigned to the fax job. You will not be able to dial any other locations while the message appears.

Sending a Fax by Automatic Dialing

- ◆ You can press  to clear the message and stop automatic redialing.
- ◆ Under certain conditions (for example if a person answers the call on a telephone), automatic redialing may stop before three redialing attempts are made.



Error Correction Mode

The fax machine is set to automatically correct any distortions in a transmission due to noise on the telephone line before printing at the receiving end. This function is called Error Correction Mode (ECM). ECM is effective for both transmissions and receptions, and is only effective when the other fax machine has ECM as well.

If desired, you can turn ECM off. This will increase slightly the amount of memory available for memory transmission and reception.

1 Press  once and  once.



OPTION SETTING 

2 Press  once and  6 times.

ECM MODE 

3 Press  once.

1=YES, 2=NO

4 Press  to select YES, or  to select NO.

The display briefly shows your selection, then:

DAY LIGHT SAVE 

5 Press  to return to the date and time display.

Sending a Fax From Memory

You can scan a document into the fax's memory and send the document from memory. This increases transmission speed and allows you to send a fax to multiple destinations in a single operation. After transmission, the document is automatically cleared from memory.

Note: If a power failure occurs while sending a fax from memory, you will need to repeat the operation.

Broadcasting (sending a fax to multiple destinations)

This function allows you to send the same fax to as many as 20 different destinations in just one operation.

- ◆ When sending to multiple destinations, only auto-dial numbers can be used to dial the numbers of the receiving machines.

1 Load the document(s).

- If desired, press **RESOLUTION/RECEPTION MODE** to set the resolution and/or contrast.

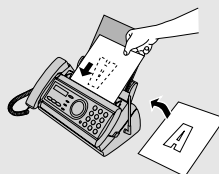

2 Press **START/MEMORY**.

3 Press **▶** (or **◀**) until the name of the destination appears in the display (if no name was stored, the number will appear).

4 Press **▼** to select the destination.

5 Repeat Steps 3 and 4 for each of the other destinations to which you wish to send the fax (maximum of 20).

- To check your selected destinations, press **▲** to scroll through them. To delete a destination, scroll to the destination and then press **STOP**.





6 When you are ready to begin transmission, press .

- A Transaction Report is automatically printed out after Broadcasting is completed. Check the "Note" column of the report to see if any of the destinations are marked "Busy" or have a communication error code. If so, send the document to those destinations again.

Memory transmission



You can also send a fax through memory when sending to a single destination. This is convenient when sending to destinations where the line is often busy, as it saves you from waiting to pick up the original document and frees the feeder for other operations.

To send a fax through memory, load the document, press  , and then dial using one of the following methods:

- ◆ Press the number keys to enter the fax number and then press  .
- ◆ Press  repeatedly to select an auto-dial number and press  .
- ◆ Press  once to select the last number dialed and press  .

If the memory becomes full...

If the memory becomes full while the document is being scanned, MEMORY IS FULL and SEE MANUAL will alternately appear in the display.

- ◆ Press  if you want to transmit the pages which have been stored up to that point in memory. The remaining pages will be ejected from the feeder. After transmission, the memory will be cleared and you can transmit the remaining pages. You will also need to transmit the page which was being scanned when the memory filled up.
- ◆ Press  if you want to cancel the entire transmission.

5. Receiving Faxes

Using FAX Mode

To select FAX mode, press **RESOLUTION/RECEPTION MODE** until the arrow in the display points to FAX.

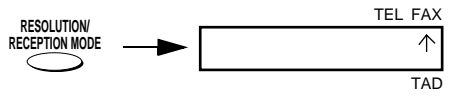
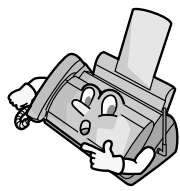

When the reception mode is set to FAX, the fax machine will automatically answer all calls on four rings and receive incoming faxes.

- ◆ If you pick up the handset before the machine answers, you can talk to the other party and/or receive a fax as explained in *Using TEL Mode* on page 84.

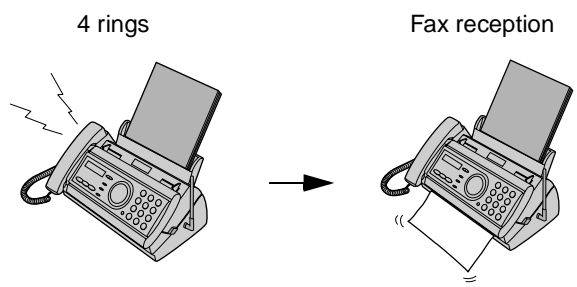

Changing the number of rings

If desired, you can change the number of rings on which the fax machine answers incoming calls in FAX mode. Any number from 2 to 5 can be selected.

1 Press **FUNCTION** once and **▲** once.

Display: **OPTION SETTING** ⬅➡

5. Receiving Faxes

2 Press  once.

NUMBER OF RING 

3 Press  once.

ENTER (2-5) (4)

4 Enter the desired number of rings (any number from 2 to 5).

The display briefly shows your selection, then:

Example: 3 rings 

TRANSACTION 

5 Press  to return to the date and time display.

Note: If you are using Distinctive Ring, the fax machine will answer calls after two rings regardless of the above setting.

Using TEL Mode



To select TEL mode, press

RESOLUTION/
RECEPTION MODE



until the arrow in

the display points to TEL.

RESOLUTION/
RECEPTION MODE



TEL FAX
↑
TAD

When the reception mode is set to TEL, you must answer all calls by picking up the fax machine's handset or an extension phone connected to the same line.

Answering with the fax's handset

- 1** When the fax machine rings, pick up the handset.

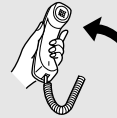

- 2** If you hear a fax tone, wait until the display shows **RECEIVING** and then replace the handset.



RECEIVING

Note: If you have set the Fax Signal Receive setting to NO, press **START/MEMORY** to begin reception.



- 3** If the other party first speaks with you and then wants to send a fax, press **START/MEMORY** after speaking. (Press before the sender presses their Start key.)



RECEIVING

- When **RECEIVING** appears in the display, hang up.





Answering on an extension phone connected to the same line

- 1** Answer the extension phone when it rings.

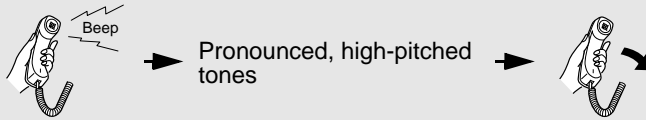

- 2** If you hear a soft fax tone, wait until your fax responds (you will hear pronounced, high-pitched tones), then hang up.





- 3** If the fax doesn't respond, or if the other party first talks to you and then wants to send a fax, set the phone down (do not hang up), walk over to the fax, lift the fax's handset, and press  .

- The above step is necessary if you have set the Fax Signal Receive setting to NO.

Optional Reception Settings



Fax Signal Receive

Your fax will automatically begin reception if you hear a soft fax tone after answering a call on your fax or an extension phone. If you use a computer fax modem to send documents on the same line, you must turn this function off in order to prevent your fax from mistakenly attempting to receive documents from the computer fax modem. Follow the steps below to change the setting.

- 1** Press  once and  once.

Display:



OPTION SETTING 

- 2** Press  once and  4 times.

FAX SIGNAL RX 

- 3** Press  once.

1=YES, 2=NO

- 4** Press  to turn on the function, or
 to turn it off.

The display briefly shows your selection, then:



CALLER-ID 

- 5** Press  to return to the date and time display.

Reception Ratio



The fax has been set at the factory to automatically reduce the size of received documents to fit the size of the printing paper. This ensures that data on the edges of the document are not cut off. If desired, you can turn this function off and have received documents printed at full size.

- ◆ If a document is too long to fit on the printing paper, the remainder will be printed on a second page. In this case, the cut-off point may occur in the middle of a line.
- ◆ Automatic reduction may not be possible if the received document is too large, contains too many fine graphics or images, or is sent at high resolution. In this case, the remainder of the document will be printed on a second page.

- 1** Press  once and  once.

Display:



OPTION SETTING 

- 2** Press  once and  4 times.

RECEIVE RATIO 

- 3** Press  once.

1=AUTO, 2=100%

- 4** Press  to select AUTO, or  to select 100%.

The display briefly shows your selection, then:

PRINT CONTRAST 

5 Press  to return to the date and time display.

Substitute Reception to Memory

In situations where printing is not possible, such as when your fax runs out of paper, the imaging film needs replacement, or the paper jams, incoming faxes will be received to memory.

When you have received a document in memory, FAX RX IN MEMORY will appear in the display, alternating with ADD PAPER & PRESS START KEY or CHECK FILM / CHECK COVER / CHECK PAPER JAM. When you add paper (and press ) , replace the imaging film, or clear the jam, the stored documents will automatically print out.

- ◆ If you received documents in memory because the fax ran out of paper, be sure to add paper which is the same size as the paper previously used. If not, the document print-out size may not match the size of the printing paper.

6. Making Copies

Your fax machine can also be used to make copies. Single and multiple copies (up to 99 per original) can be made, enabling your fax to double as a convenience office copier.

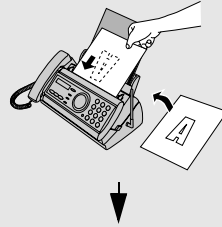

1 Load the document(s) face down. (Maximum of 10 pages.)

- If desired, press  to set the resolution and/or contrast. (The default resolution setting for copying is FINE.)



READY TO SEND

2 If desired, select an enlarge/reduce setting, and/or select the number of copies per original:

- ENLARGE/REDUCE: Press  or  until the desired setting appears in the display. Settings are 100%, 125%, 135%, 50%, 73%, 88%, 94%, and AUTO (auto size adjustment to match the size of the paper). The default setting is 100%.

Example: Press  twice →

- Number of copies per original: Press the number keys to enter a number from 1 to 99. The default setting is 1.

Example: Press  for five copies →

3 When you are ready to begin copying, press .

If MEMORY IS FULL appears...

If the memory becomes full while a document is being scanned, MEMORY IS FULL and SEE MANUAL will alternately appear in the display and the document will automatically feed out. This may happen if the resolution is set to SUPER FINE, or if you selected an enlarge/reduce setting, or if you are making more than one copy per original. To avoid using memory, use STANDARD or FINE for the resolution, 100% for the enlarge/reduce setting, and make only one copy per original.



Copy Cut-off

When making a copy of a document that is longer than the printing paper, use the copy cut-off setting to select whether the remaining part of the document will be cut off or printed on a second page. The initial setting is YES (cut off the remainder). To change the setting, follow the steps below.

1 Press **FUNCTION** once and  once.

Display:



OPTION SETTING 

2 Press  once and  once.

COPY CUT-OFF 

3 Press  once.

1=YES, 2=NO

4 Press  to set copy cut-off to YES (the remaining part of the document will not be printed), or  to set copy cut-off to NO (the remaining part will be printed on a second page).

The display briefly shows your selection, then:

NUMBER OF RING 

5 Press  to return to the date and time display.

7. Special Functions

Caller ID (Requires Subscription to Service)

If you subscribe to a caller identification service from your telephone company, you can have the fax machine and the cordless handset display the name and number of the caller when you receive a call.

Important:

- ◆ To use this function, you must subscribe to a caller identification service from your telephone company. Note that your fax may not be compatible with some caller identification services.

◆ **Area Code mode:** This step is needed if your telephone exchange cannot dial a local phone number (within your calling area code) when the area code is dialed with the phone number (see Step 5).

1 Press FUNCTION once and ▲ once on the fax machine.	Display: OPTION SETTING ↕
2 Press ▶ once and ▼ 5 times.	CALLER-ID ↕
3 Press ▶ once.	1=YES, 2=NO
4 Press ① (YES) to turn on Caller ID. (To turn off Caller ID, press ② and go to Step 8.)	AREA CODE # MODE ▲ ▼ 1=SET, 2=CLEAR
5 Press ① to select SET. (To clear a previously set area code, press ② and go to Step 8.)	ENTER AREA CODE

Note: Entering your area code in this step causes it to be automatically removed from local numbers in the Caller ID list (page 93). This is only required if you need to eliminate dialing of the area code when dialing a local number from the list. Example (using the area code "123"): If Step 5 is skipped, the Caller ID display will show 123-444-1234, and the number that will dial from the Caller ID list is 123-444-1234. If the area code 123 is entered in Step 5, the Caller ID display will show 444-1234, and the number that will dial from the Caller ID list is 444-1234.

6 Enter the three digits of your area code.

7 Press  to store your area code.

ECM MODE 

8 Press  to return to the date and time display.

How Caller ID operates

When you receive a call, the name and phone number of the caller will appear in the fax machine display and cordless handset display, beginning just before the second ring. The information will continue to be displayed until the line is disconnected.

Display example (fax machine display)

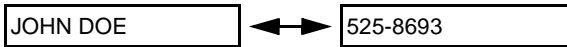

Caller's name

Caller's number

Note: Some caller ID services may not provide the name of the caller. In this case, only the phone number will appear.

Display messages

One of the following messages will appear while the fax rings if caller information is not available.

NO SERVICE	No caller information was received from your telephone company. Make sure that the telephone company has activated your service.
CALLER-ID ERROR	Noise on the telephone line prevented reception of caller information.
OUT OF AREA	The call was made from an area which does not have a caller identification service, or the caller's service is not compatible with that of your local phone company.
PRIVATE CALL	Caller information was not provided by the telephone company at the caller's request.

Viewing the Caller ID list



If you subscribe to a Caller ID service and have turned on the Caller ID function, your fax machine will keep information on the most recent 30 calls and faxes you have received. You can view this information, which consists of the name and number of each caller, in the Caller ID List.

- ◆ After you have received 30 calls, each new call will delete the oldest call.
- ◆ All calls will be erased if you unplug the fax or a power failure occurs.

Follow the steps below to view the Caller ID List in the fax machine display. If desired, you can immediately dial a number when it appears.

1 Press  twice.

<REVIEW CALLS> 



2 Press  or  to scroll through the list.

3 If you wish to dial one of the numbers in the list, scroll through the list until the number appears in the display.

- **Fax:** If you wish to send a fax, load the document and then press . Dialing and transmission begin.

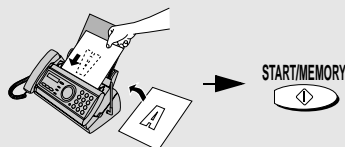
Fax:





- **Voice call:** If you wish to make a voice call, pick up the handset (or press ). Dialing begins automatically. (If you pressed , pick up the handset when the other party answers.)

Voice call:



4 Press  when you have finished viewing the list.

To delete calls from the Caller ID list

If you want to delete a single call from the caller list, press  while the call appears in the display. If you want to delete all calls from the list, hold  down for at least 3 seconds while you are viewing any number in the list.



Viewing the Caller ID list from the cordless handset

You can also view the Caller ID list in the cordless handset display, and automatically dial a number from the list. (Note that the cordless handset and the fax machine share the same list.)



1 Press REVIEW .

Cordless handset display:

REVIEW CALLS
▲▼: REVIEW

2 Press  or  to scroll through the numbers in the list.





3 While viewing the list, you can do the following:

- **Dial a number:** Scroll to the desired number and then press . (Note: You can only make a phone call from the cordless handset; you cannot start a fax transmission.)
- **Erase a call:** Scroll to the call you wish to erase, press , and then press .

4 Press  when you have finished viewing the list.

Erasing all calls using the cordless handset







Follow these steps to erase all calls from the Caller ID list using the cordless handset.

1 Press REVIEW  .	Cordless handset display:
	<div style="border: 1px solid black; padding: 5px;"> REVIEW CALLS ▲▼: REVIEW </div>
2 Press  ERASE .	<div style="border: 1px solid black; padding: 5px;"> ERASE ALL? PRESS START KEY </div>
3 Press  .	
<ul style="list-style-type: none"> To cancel, press  . 	

Priority Call

If you have turned on Caller ID, you can set the machine to make a special ringing sound when you receive a call from a designated phone number. This lets you know immediately who is calling without having to look at the display.

To use this function, enter the desired phone number by following the steps below (only one phone number can be entered).

1 Press FUNCTION  once and  3 times.	Display: <div style="border: 1px solid black; padding: 2px;">ENTRY MODE </div>
2 Press  once and  twice.	<div style="border: 1px solid black; padding: 2px;">PRIORITY # </div>
3 Press  once.	<div style="border: 1px solid black; padding: 2px;">1=SET, 2=CLEAR</div>

4 Press  to store a number.

(To clear a previously stored number, press  and go to Step 6.)

5 Enter the number by pressing the number keys (max. 20 digits).

6 Press  to store (or clear) the number.

HS NAME SET 

7 Press  to return to the date and time display.

Blocking voice calls

If you have turned on Caller ID, you can use the Anti Junk Fax function described in *Blocking Reception of Unwanted Faxes* in this chapter to block voice calls as well as faxes from your specified Anti Junk Number.

In this case, when a voice call or a fax transmission comes in from the number you have specified as a "Junk Number", your fax will break the connection as soon as it receives the calling phone number from the caller ID service (before the second ring).

To use this function, enter the number that you wish to block as explained in *Blocking Reception of Unwanted Faxes* (see page 98). Only one number can be blocked.

Note: This function cannot be used if you are using the Distinctive Ring function.



Distinctive Ring (Requires Subscription to Service)

Important:

- ◆ **To use distinctive ring, you must subscribe to a distinctive ring service from your local phone company.**
- ◆ Your fax machine may not be compatible with some distinctive ring services.



Distinctive ring is a service offered by some local telephone companies whereby they assign an additional second number to your regular single line. The second number rings differently from your normal number.

If you subscribe to a distinctive ring service, you can set the fax machine to automatically answer when your second number is called. This allows you to use the second number as an exclusive fax number. To have your fax automatically answer when your second number is called, follow the steps below:

1 Press  once and  once.

Display:





OPTION SETTING 

2 Press  once and  3 times.

DISTINCTIVE 

3 Press  once.

4 Press a number from 1 to 3 to select the ring pattern below that matches your second number's ring pattern. Or, press 4 to have your fax automatically answer your normal telephone number. Press 5 to turn off the distinctive ring function.

- | | | |
|---|----------------|---|
|  | RING PATTERN 1 | Two short rings |
|  | RING PATTERN 2 | One short, one long, and one short ring |
|  | RING PATTERN 3 | Two short rings and one long ring |
|  | STANDARD RING | Your standard (normal) ring pattern |
|  | OFF SETTING | Turn distinctive ring off |

Blocking Reception of Unwanted Faxes

The display briefly shows your selection, then:

FAX SIGNAL RX 

5 Press  to return to the date and time display.



6 Set the reception mode to FAX.

RESOLUTION/RECEPTION MODE  TEL FAX 
TAD



- ◆ When using distinctive ring, you must set the reception mode of your fax machine to FAX. When your designated fax number is dialed, your fax will automatically answer and begin reception after two rings. Note that other devices on the same line will also ring until your fax answers. If one of your other numbers is dialed, the fax will ring; however, it will not answer.

Blocking Reception of Unwanted Faxes

The Anti Junk Fax function allows you to block reception of faxes from a party that you specify. This saves paper by not printing out unwanted "junk" faxes. To use this function, follow the steps below to enter the fax number from which you do not wish to receive faxes. One fax number can be entered.

1 Press  once and  3 times.



Display: ENTRY MODE 

2 Press  once and  twice.

ANTI JUNK # 

3 Press  once.

1=SET, 2=CLEAR

4 Press  to store an Anti Junk number, or  to clear a previously stored number (if you are clearing a number, go to Step 6).

5 Enter the fax number by pressing the number keys (max. 20 digits).

6 Press  and then press  to return to the date and time display.

8. Printing Lists

You can print lists showing settings and information entered in the fax machine. The lists are described below. To print a list, follow these steps.

1 Press **FUNCTION** once and **▼** twice.

Display:

LISTING MODE 

2 Press **▶** once.

TEL # LIST 

3 Press **▲** or **▼** until the desired list appears in the display.

4 Press **▶** once.

PRESS START KEY

5 Press **START/MEMORY**  to print the list.

Telephone Number List

This list shows the fax and phone numbers that have been stored in the Common book for automatic dialing.

Setup List

This list shows your current selections for the **FUNCTION** key settings. The list also shows your name and fax/telephone number as entered in the machine, and a sample of the header printed at the top of every page you transmit (**HEADER PRINT**).

```

                                     P.01
                SETUP LIST
FOR: SHARP-SHOP                      APR-15-2002 03:15 AM
                                     794 0675
-----
***T.A.B. SETTING***
TOLL SAVER                          YES
RECORDING TIME                       4 MIN.
REMOTE CODE #                        001
TRANSFER TELEPHONE #
TRANSFER TELEPHONE CALLING          NO
ON T.A.D. FAILURE                   NO
UNIT SETS TO AUTO FAX RCV.1
OCM ONLY MODE                       NO
CPC DETECTION                       YES
BOX PASSCODE #                      BOX-1: NOT STORED
                                         BOX-2: NOT STORED
                                         BOX-3: NOT STORED
                                         BOX-4: NOT STORED
-----
***ENTRY MODE***
ANS: JUNK #
PRIORITY CALL #
SENDER'S NAME                       SHARP-SHOP
SENDER'S TELEPHONE #                794 0675
MS NAME SET                         HANDBET-1: BOB
                                         HANDBET-2: SUE
                                         HANDBET-3: TOM
                                         HANDBET-4: GALLY
-----
HEADER PRINT
APR-15-2002 03:15 AM SHARP-SHOP      794 0675      P.01
-----
***OPTION SETTING***
NUMBER OF RINGS IN AUTO ANSWER MODE  4 RINGS
TRANSACTION PRINT SELECT              ERROR ONLY
DIAL MODE                             TONE
DISTINCTIVE RINGING                  OFF
FAX SIGNAL RECEIVE                   YES
CALLER-ID                            NO
ECH MODE                              YES
DAY LIGHT SAVING TIME                NO
RECEPTION RATIO                      AUTO
PRINT CONTRAST                       NORMAL
PAPER SIZE SET                       LETTER
COPY CUT OFF                         YES
    
```

Message List

This list shows information about the messages currently recorded in the answering machine, including the date and time each messages was recorded, the length, and the type.

Caller-ID List

This list shows information about your 30 most recent calls. (This list is only available if you are using the Caller ID function.)

Transaction Report

This report is printed out automatically after an operation is completed to allow you to check the result. Your fax machine is set at the factory to print out the report only when an error occurs.

- ◆ The Transaction report cannot be printed on demand.

Headings in Transaction Report

SENDER/ RECEIVER	The name or fax number of the other machine involved in the transaction. If that machine does not have an ID function, the communication mode will appear (for example, "G3").
START	The time at which transmission/reception started.
TX/RX TIME	Total time taken for transmission/reception.
PAGES	Number of pages transmitted/received.
NOTE	(One of the following notes will appear under NOTE in the report to indicate whether the transaction was successful, and if not, the reason for the failure.) OK - Transmission/reception was successful. P.FAIL - A power failure prevented the transaction. JAM - The printing paper or document jammed, preventing the transaction. BUSY - The fax was not sent because the line was busy. COM.E-X - (Where "X" is a number.) A telephone line error prevented the transaction. See <i>Line error</i> on page 108. CANCEL - The transaction was cancelled because the STOP key was pressed, no document was in the feeder, or the other machine requested transmission using a function which your fax machine does not have. If you were attempting to fax, make sure a document is in the feeder. If you were receiving, contact the faxing party to see how they are trying to send to you.

Transaction Report print condition

You can change the condition under which a Transaction Report is printed out. Follow the steps below.

1 Press **FUNCTION** once and **▲** once.

Display:

OPTION SETTING 

2 Press **▶** once and **▼** once.

TRANSACTION 

3 Press **▶** once.

1:ALWAYS PRINT

(Selections appear alternately)

4 Press a number from **①** to **⑤** to select the condition for printing.

- | | |
|-----------------------|--|
| ① ALWAYS PRINT | A report will be printed after each transmission, reception, or error. |
| ② ERROR/MEMORY | A report will be printed after an error or a memory operation. |
| ③ SEND ONLY | A report will be printed after each transmission. |
| ④ ERROR ONLY | A report will be printed only when an error occurs. |
| ⑤ NEVER PRINT | A report will never be printed. |

The display briefly shows your selection, then:

DIAL MODE 

5 Press **STOP** to return to the date and time display.

9. Maintenance

Print head

Clean the print head frequently to ensure optimum printing performance.

Note: Remove the paper from the paper tray before cleaning the print head.

- 1 Unplug the power cord, and open the operation panel (press 1).

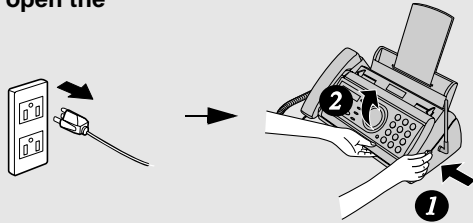

- 2 Take the imaging film out of the print compartment and place it on a sheet of paper.

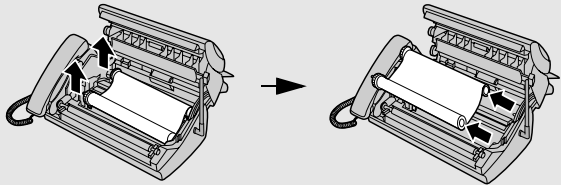

- 3 Wipe the print head with isopropyl alcohol or denatured alcohol.

Caution!

- Do not use benzene or thinner. Avoid touching the print head with hard objects.
- The print head may be hot if your fax machine has just received a large number of documents. If this is the case, allow the print head to cool prior to cleaning.

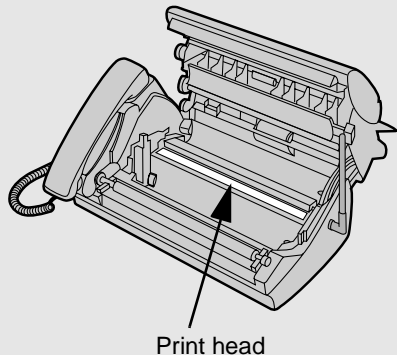

- 4** Place the imaging film back in the print compartment.

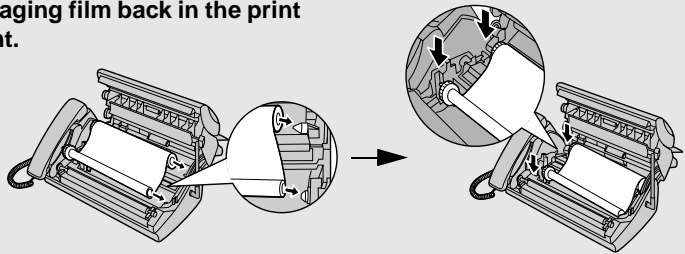

- 5** Rotate the front gear until the film is taut, and then close the operation panel (press down on both sides to make sure it clicks into place).

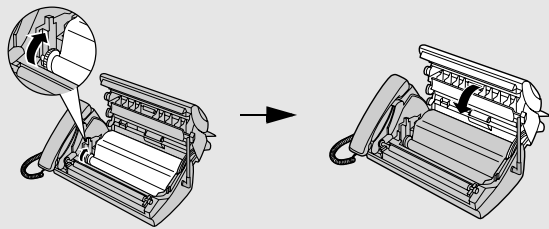

Scanning glass and rollers

Clean the scanning glass and rollers frequently to ensure the quality of transmitted images and copies.

Note: Remove the paper from the paper tray before cleaning the scanning glass and rollers.

- 1** Open the operation panel (press **1**).

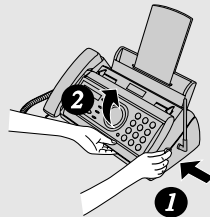

- 2** Flip up the green levers on each side of the white roller.

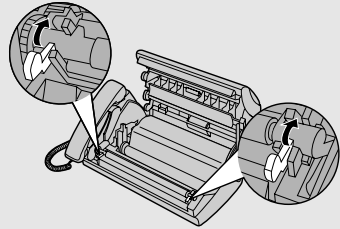

- 3** Wipe the scanning glass (under the white roller) and rollers with a cotton swab.

- Make sure that all dirt and stains (such as correcting fluid) are removed. Dirt and stains will cause vertical lines on transmitted images and copies.

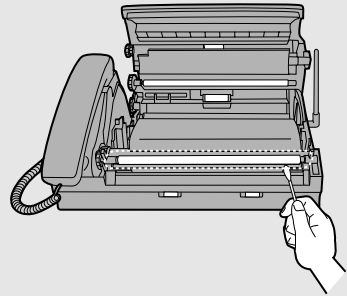

If the scanning glass is difficult to clean

If you find it difficult to remove dirt from the scanning glass, you can try moistening the swab with isopropyl alcohol or denatured alcohol. Take care that no alcohol gets on the rollers.

- 4** Flip down the green levers on each side of the white roller. Rotate the front gear until the film is taut, and then close the operation panel (press down on both sides to make sure it clicks into place).

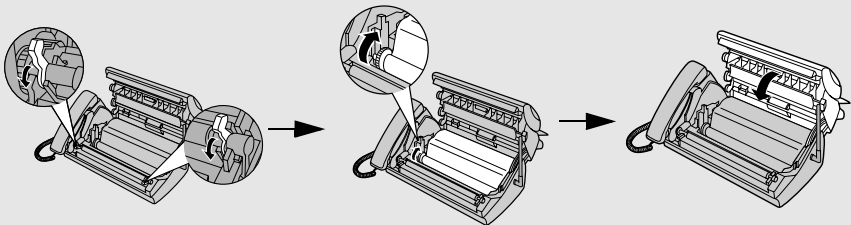

The housing

Wipe the external parts and surface of the machine with a dry cloth.

Caution!

Do not use benzene or thinner. These solvents may damage or discolor the machine.

Replacing the Cordless Handset Battery

Like any other battery, the rechargeable battery will eventually wear out. The battery can normally be used for about two years, although this will vary depending on the conditions of use.

If LOW BATTERY continues to appear in the cordless handset display after the battery has been charged for 10 hours, replace it with the following battery:

Replacement battery: Use only a **Sharp UX-BA01** battery (3.6 V Ni-MH battery, capacity: 850 mAh)

Caution:

Danger of explosion if battery is incorrectly replaced. Replace only with the same or equivalent type recommended by the manufacturer.

Dispose of used batteries according to the manufacturer's instructions.

- 1 Remove the battery cover by pressing on the indentation as shown.**

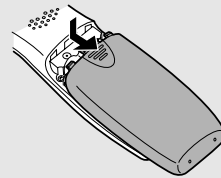

- 2 Unplug the battery connector and remove the old battery.**

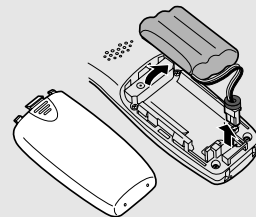

- 3 Connect the battery connector ❶ of the new battery, and then place the battery in the cordless handset, placing the wires as shown.**

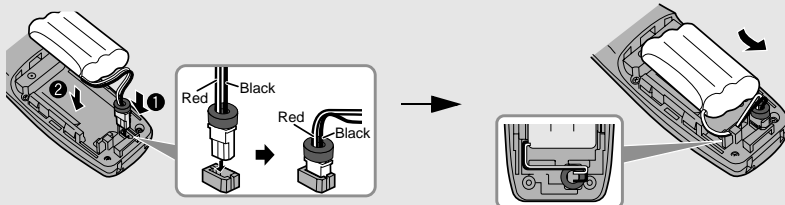

- 4** Place the battery cover on the cordless handset, making sure it snaps firmly into place.

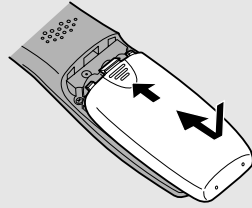

- 5** Place the cordless handset in the charger with the dial pad facing forward.

- Let the new battery charge for at least **10** hours.

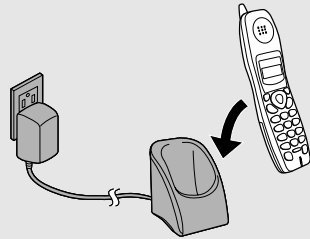

Battery disposal

The battery pack contains a Nickel Metal Hydride battery. The battery must be disposed of properly. Contact local agencies for information on recycling and disposal plans in your area.

Wiping the charger contacts

To ensure that the battery charges properly, wipe the charger contacts once a month with a cotton swab.

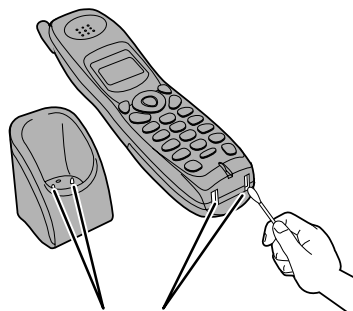

Charger contacts

10. Troubleshooting

Problems and Solutions

If you have any problems with your fax, first refer to the following troubleshooting guide. If you cannot solve the problem, call Sharp's Customer Assistance Center at 1-877-794-8675.

Line error

Problem	Solution
LINE ERROR appears in the display.	<p>Try the transaction again. If the error persists, check the following:</p> <ul style="list-style-type: none">• Check the connection. The cord from the TEL. LINE jack to the wall jack should be no longer than six feet.• Make sure there are no modem devices sharing the same telephone line.• Check with the other party to make sure their fax machine is functioning properly.• Have your telephone line checked for line noise.• Try connecting the fax machine to a different telephone line.• If the problem still occurs, your fax machine may need service.

Dialing and transmission problems

Problem	Solution
No dial tone when you pick up the handset or press the SPEAKER key.	<ul style="list-style-type: none"> • Make sure the handset cord is connected to the correct jack. See <i>Connecting the handset</i> on page 14.
Dialing is not possible.	<ul style="list-style-type: none"> • Make sure the power cord is properly plugged into a power outlet. • Make sure that the telephone line is properly connected to both the TEL. LINE jack and the wall jack (see page 15). • Make sure that the fax machine is set to the correct dialing mode for your telephone line. See <i>Dial mode</i> on page 15.
The power is on, but no transmission takes place.	<ul style="list-style-type: none"> • Make sure that the receiving machine has paper. • If the receiving machine is in manual mode with no attendant, reception will not be possible. • Check the display for error messages. • Pick up the handset and check for a dial tone.
Nothing is printed at the receiving end.	<ul style="list-style-type: none"> • Make sure that the document for transmission is placed face down in the feeder.
A distorted image is received at the other end.	<ul style="list-style-type: none"> • Noise on the telephone line may cause distortion. Try sending the document again. • Make a copy of the document on your fax machine. If the copy is also distorted, your fax machine may need service.

Reception and copying problems

Problem	Solution
<p>The fax machine doesn't receive documents automatically.</p>	<ul style="list-style-type: none"> • Make sure that the reception mode is set to FAX. If you subscribe to a distinctive ring service, make sure that the Distinctive Ring function is set to the correct ring pattern. If you do not subscribe to a distinctive ring service, make sure that Distinctive Ring is set to OFF SETTING. (See <i>Distinctive Ring</i> on page 97.)
<p>The printing paper comes out blank when you try to receive a document.</p>	<ul style="list-style-type: none"> • Make sure that the document is loaded properly in the feeder of the transmitting machine. Make a copy or print a report to confirm the printing ability of your machine.
<p>General print quality is poor.</p>	<ul style="list-style-type: none"> • It is important to select a paper that is appropriate for the thermal transfer printer in your fax. We recommend using laser quality paper that has a very smooth finish. Copier paper will work, but it sometimes tends to yield a lighter print quality.
<p>The received document is faint.</p>	<ul style="list-style-type: none"> • Ask the other party to send higher contrast documents. If the contrast is still too low, your fax machine may need service. Make a copy or print a report to check your machine's printing ability.
<p>Received images are distorted.</p>	<ul style="list-style-type: none"> • Noise on the telephone line may cause distortion. Have the other party try sending the document again. • The print head may be dirty. See <i>Print head</i> on page 103. • Make a copy or print a report on your fax machine. If the copy or report is also distorted, your fax machine may need service.
<p>A received document or copy prints out in strips.</p>	<ul style="list-style-type: none"> • Make sure the operation panel is completely closed (press down on both sides of the panel).

The quality of copies is poor and/or dark vertical lines appear.	<ul style="list-style-type: none"> Any dirt or material on the scanning glass will cause spots to appear on copies and transmitted faxes. Clean the scanning glass as explained on page 104.
Reception/copying is interrupted.	<ul style="list-style-type: none"> If reception or copying takes place continuously for a long time, the print head may overheat. Turn off the power and let it cool down. If overheating frequently occurs, try changing the print contrast setting to LIGHT (see page 25).
Dark vertical lines appear on copies and received faxes.	<ul style="list-style-type: none"> Try changing the print contrast setting to LIGHT (see page 25).

General problems

Problem	Solution
Auto-dial numbers cannot be stored in the fax.	<ul style="list-style-type: none"> Make sure the fax is plugged in and the imaging film has been loaded. (Auto-dial numbers cannot be stored if the imaging film has not been loaded.) See <i>Loading the Imaging Film</i> in Chapter 1.
Nothing appears in the display.	<ul style="list-style-type: none"> Make sure the power cord is properly plugged into a power outlet. Connect another electrical appliance to the outlet to see if it has power.
The machine does not respond when you press any of its keys.	<ul style="list-style-type: none"> If a beep sound is not made when you press the keys, unplug the power cord and then plug it in again several seconds later.
Automatic document feeding does not work for transmission or copying.	<ul style="list-style-type: none"> Check the size and weight of the document (see <i>Transmittable Documents</i> on page 69).

Cordless handset problems

Problem	Solution
The cordless handset does not operate and nothing appears in the display.	<ul style="list-style-type: none">• Make sure the battery is properly connected inside the cordless handset (see page 18).• The battery may be low. Place the cordless handset in the charger and let it charge.
Calls cannot be made or received on the cordless handset.	<ul style="list-style-type: none">• Make sure the fax machine is plugged into a power outlet and has power.• Make sure the telephone line is properly connected to both the TEL. LINE jack on the fax machine and the wall jack (see page 15). (If the telephone line is connected correctly, you should hear a dial tone when you pick up the fax machine handset.)• The battery may be low. Place the cordless handset in the charger and let it charge.• Calls cannot be made or received while the fax machine is being used (while FAX BUSY appears in the cordless handset display). Wait until the fax machine is no longer being used.• Calls cannot be made or received during a power failure.• You may be outside of the talking range. Move closer to the fax machine.

<p>The battery does not charge.</p>	<ul style="list-style-type: none"> • Make sure the cordless handset is placed in the charger with the dial pad facing forward. • Make sure the AC adapter is connected correctly to the charger and the power outlet (see page 17). • Wipe the charger contacts with a cotton swab. • Make sure the battery is properly connected inside the cordless handset (see page 18). • The battery may need replacement (see page 106).
<p>You hear noise or interference during a call.</p>	<ul style="list-style-type: none"> • Make sure the base antenna is fully upright on the fax machine (see page 17). • Other electrical appliances may cause interference. Move away from any electrical appliances. • Move closer to the fax machine. Note that large metal objects, metal structures, and thick walls between the fax machine and cordless handset will reduce the talking range. If needed, try moving the fax machine to a different location.
<p>You hear beeps during a call.</p>	<ul style="list-style-type: none"> • You will hear beeps during a call and LOW BATTERY will appear in the display if the battery is low. Place the cordless handset in the charger and let it recharge. If you hear beeps during a call and need to continue the call, press the INTERCOM key to transfer the call to the fax machine. • You will hear beeps during a call and OUT OF RANGE will appear in the display if you are outside of the talking range. Move closer to the fax machine.
<p>When you press the INTERCOM key, the name of one of the other cordless handsets does not appear in the list (only the number appears), even though a name has been programmed for that cordless handset.</p>	<ul style="list-style-type: none"> • The name was not transmitted to your cordless handset when it was entered (probably because your cordless handset was in use). To retransmit the name, repeat the name entry procedure on page 20. The name will automatically appear in the display in Step 6, so simply press STARTMEMORY  to transmit the name then exit the procedure with Step 8.

Messages and Signals

Display messages (fax machine)

Note: If you have turned on the Caller ID function, see page 92 for display messages related to Caller ID.

<p>ADD PAPER & / PRESS START KEY (alternating messages)</p>	<p>Check the printing paper. If the tray is empty, add paper and then press the START/MEMORY key. If there is paper in the tray, make sure it is inserted correctly (take out the stack, align the edges evenly, and then reinsert it in the tray) and then press the START/MEMORY key.</p>
<p>BUSY</p>	<p>The system is busy, or the cordless handset that you attempted to page is busy and cannot respond.</p>
<p>CALL TRANSFER</p>	<p>A call is being transferred.</p>
<p>CHECK FILM/ CHECK COVER/ CHECK PAPER JAM (alternating messages)</p>	<p>These alternating messages appear when there is a problem in the print compartment that prevents printing. Check to see if the imaging film is not loaded properly or if it has been used up and needs replacement. Make sure the operation panel is completely closed (press down on both sides). If a paper jam has occurred, clear the jam as explained in the following section, <i>Clearing Paper Jams</i>.</p>
<p>CHECK PAPER SIZE</p>	<p>The paper size setting is incorrect. Change the paper size setting as explained on page 25.</p>
<p>CORDLESS IN USE</p>	<p>The cordless handset is in use. Wait until this message no longer appears to send a fax or make a phone call.</p>
<p>DOCUMENT JAMMED</p>	<p>The original document is jammed. See the following section, <i>Clearing Paper Jams</i>. Document jams will occur if you load more than 10 pages at once or load documents that are too thick (see page 69). The document may also jam if the receiving machine doesn't respond properly when you attempt to send a fax.</p>

FAX RX IN MEMORY	A fax has been received in memory because the imaging film needs replacement, you have run out of printing paper, or the paper is jammed. The fax will print out automatically when the problem is fixed.
FUNCTION MODE	The FUNCTION key has been pressed.
INTERCOM	A cordless handset is paging the fax machine (lift the handset to talk), or the fax machine is paging a cordless handset. The name and number of the cordless handset appear alternately with INTERCOM.
LINE ERROR	Transmission or reception was not successful. Press the STOP key to clear the message and then try again. If the error persists, see <i>Line Error</i> on page 108.
MEMORY IS FULL/ SEE MANUAL (alternating messages)	The memory is full. You may have too many messages recorded in the answering system. To erase messages, see page 53. This message may also occur during fax reception if too much data is received before the pages can be printed out. If faxes have been received to memory because printing is not possible (an additional message will indicate the problem), resolve the problem so that printing can continue (see <i>Substitute Reception to Memory</i> on page 88). If you are attempting to transmit from memory, see <i>If the memory becomes full</i> on page 82. If you are copying, see <i>If MEMORY IS FULL appears</i> on page 89.
MEMORY PRINTING	The fax is preparing to or printing out a document from memory.
NO DATA	This appears if you attempt to search for an auto-dial number when none have been stored.
OFF HOOK	This appears if you forgot to replace the handset after using it to dial and send a fax. Replace the handset or press the STOP key to clear the message.
ON HOOK DIAL	The SPEAKER key has been pressed and the fax machine is waiting for you to dial.

Messages and Signals

OVER HEAT	The print head has overheated. Operation can be continued after it cools. If overheating frequently occurs, try changing the print contrast setting to LIGHT (see page 25).
PRINT HEAD FAIL/ YOU NEED SERVICE (alternating messages)	The print head has failed and requires service.
READY TO SEND	A document has been loaded and the fax machine is waiting for you to begin faxing or copying.
RECALLING	This appears if you attempt to send a fax by automatic dialing and the line is busy or the receiving fax machine does not answer. Your fax machine will automatically reattempt the call. (See <i>Automatic redialing</i> on page 79.)
REPLACE HANDSET	This appears if an outside call comes in while you are paging or talking to the cordless handset using the Intercom feature. Replace the fax machine handset to stop the Intercom call, and then pick it up again to answer the outside call. This also appears after you transfer a call to the cordless handset.
T.A.D. TRANSFER	The answering system's transfer function has been turned on (see page 59).
TOTAL MSGS:XX	This indicates that you have received messages in the answering system. "XX" is the number of messages.
TOTAL PAGE(S) 01	Number of pages transmitted, received, or copied.

Display messages (cordless handset)

BUSY	The system is busy, or the fax machine or other cordless handset that you attempted to page is busy and cannot respond.
CALL TRANSFER	A call is being transferred.
CHARGING	The cordless handset is in the charger and the battery is charging.
FAX BUSY	The fax machine is in use. Wait until the fax machine is no longer being used to use the cordless handset.
HOLD	A call has been placed on hold by pressing the HOLD key. To resume the call, press the HOLD key again.
IN CHARGER	The cordless handset is in the charger and is fully charged (the cordless handset can be left in the charger without damaging the battery).
INTERCOM	Your cordless handset is being paged (press the TALK key to talk), or your cordless handset is paging the fax machine or another cordless handset. The number and name of the other handset appear alternately with INTERCOM.
LOW BATTERY	The cordless handset battery is low. Place the cordless handset in the charger and let it recharge. If this message continues to appear after recharging, the battery may need replacement (see page 106). If this message appears during a phone call (you will also hear beeps) and you wish to continue the call, press the INTERCOM key to transfer the call to the fax machine.
NEW MESSAGES	New messages have been received in your personal box (the box corresponding to your cordless handset) in the answering system. You can either listen to the messages using the cordless handset (see page 54), or using the fax machine (see page 52).

Messages and Signals

OUT OF RANGE	The cordless handset is outside of the talking range of the fax machine. When talking on the cordless handset, the handset will beep and you may hear interference. Move closer to the fax machine.
PLEASE REGISTER	This appears in the display of an accessory cordless handset the first time it is charged. The handset must be registered in order to use it (see the manual for the accessory cordless handset).
REMOTE MODE	The REMOTE/FLASH key has been pressed.
TALK	The TALK key has been pressed to make a phone call.

Audible signals

Continuous tone	3 seconds	Indicates the end of transmission, reception, or copying.
Intermittent tone (3 beeps)	5 seconds (1 second on, 1 second off)	Indicates incomplete transmission, reception, or copying.
Rapid intermittent tone	35 seconds (0.7 seconds on, 0.3 seconds off)	Indicates that the handset is off hook.

Clearing Paper Jams

Clearing a jammed document

If the original document doesn't feed properly during transmission or copying, or DOCUMENT JAMMED appears in the display, first try pressing . If the document doesn't feed out, remove it as explained below.

Important:

Do not try to remove a jammed document without releasing it as explained below. This may damage the feeder mechanism.

- 1 Press **1** and slowly open the operation panel until it is half open.

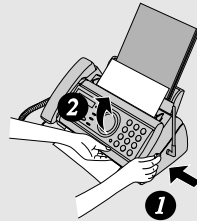

- 2 Flip up the green levers on each side of the white roller.

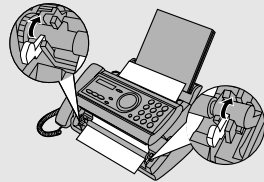

- 3 Gently remove the document.

- Be careful not to tear the document.

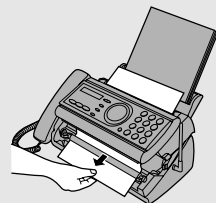

- 4** Flip down the green levers on each side of the white roller. Rotate the front gear until the film is taut, and then close the operation panel (press down on both sides to make sure it clicks into place).

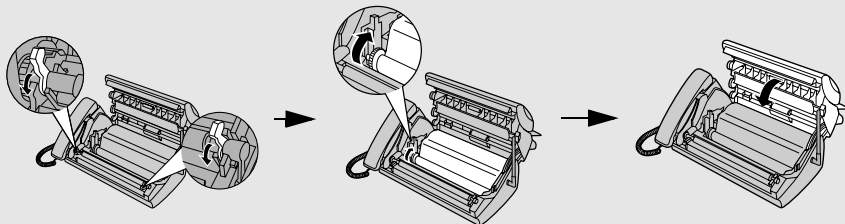

Clearing jammed printing paper

- 1** Open the operation panel (press **1**).

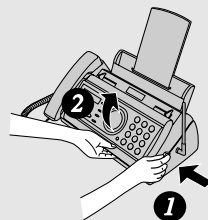

- 2** Gently pull the jammed paper out of the machine, making sure no torn pieces of paper remain in the print compartment or rollers.

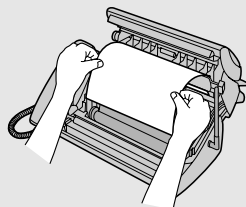

- 3** Rotate the front gear until the film is taut, and then close the operation panel (press down on both sides to make sure it clicks into place).

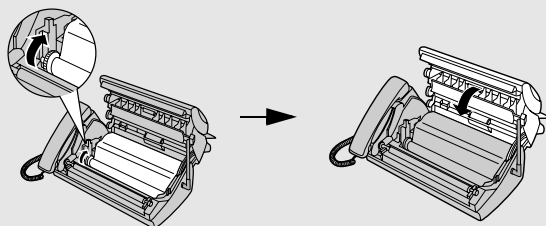

Ordering Parts

To order parts, contact the parts distribution center located nearest you. When ordering a part, use the part order number shown below.

Operation manual	TINSE4273XHTZ
Setup Guide	TCADZ3323XHZA
Handset cord	QCNWG209BXHGY
Telephone line cord	QCNWG208BXHZZ
Handset	DUNTK468BXHGY
Paper tray	CPLTP3183XHR7
Paper tray extension	LPLTP3184XHZZ
Gears	CGERH2566XH01 NGERH2568XHZZ
AC adapter	RADPA2027XHZZ
Cordless handset charger	RUNTZ2100XHE2

Part distribution centers

Tritronics, Inc. 1306 Continental Drive Abingdon, MD 21009	Tel: 1-800-638-3328 Fax: 1-800-888-FAXD
--	--

Tritronics, Inc. 1015 NW 52nd Street Ft. Lauderdale, FL 33309	Tel: 1-800-365-8030 Fax: 1-800-999-FAXD
---	--

Fox International, Ltd. 23600 Aurora Road Bedford Heights, OH 44146	Tel: 1-800-321-6993 Fax: 1-800-445-7991
---	--

Andrews Electronics 25158 Avenue Stanford Santa Clarita, CA 91355	Tel: 1-800-274-4666 Fax: 1-805-295-5126
---	--

Sharp Accessories and Supply Center 2130 Townline Road Peoria, IL 61615	Tel: 1-800-642-2122
--	---------------------

FCC Regulatory Information

This equipment complies with Part 68 of the FCC rules and the requirements adopted by the ACTA. On the rear of this equipment is a label that contains, among other information, a product identifier in the format US:AAAEQ##TXXXX. If requested, this number must be provided to the telephone company.

A plug and jack used to connect this equipment to the premises wiring and telephone network must comply with the applicable FCC Part 68 rules and requirements adopted by the ACTA. A compliant telephone cord and modular plug is provided with this product. It is designed to be connected to a compatible modular jack that is also compliant. See installation instructions for details. This equipment connects to the telephone network through a standard USOC RJ-11C network interface jack.

The REN is used to determine the number of devices that may be connected to a telephone line. Excessive RENs on a telephone line may result in the devices not ringing in response to an incoming call. In most but not all areas, the sum of RENs should not exceed five (5.0). To be certain of the number of devices that may be connected to a line, as determined by the total RENs, contact the local telephone company. For products approved after July 23, 2001, the REN for this product is part of the product identifier that has the format US:AAAEQ##TXXXX. The digits represented by ## are the REN without a decimal point (e.g., 03 is a REN of 0.3). For earlier products, the REN is separately shown on the label.

If this equipment causes harm to the telephone network, the telephone company will notify you in advance that temporary discontinuance of service may be required. But if advance notice isn't practical, the telephone company will notify the customer as soon as possible. Also, you will be advised of your right to file a complaint with the FCC if you believe it is necessary.

The telephone company may make changes in its facilities, equipment, operations or procedures that could affect the operation of the equipment. If this happens the telephone company will provide advance notice in order for you to make necessary modifications to maintain uninterrupted service.

If trouble is experienced with this equipment, or for repair or warranty information, please contact Sharp's Customer Assistance Center. The number is 1-877-794-8675. If the equipment is causing harm to the telephone network, the telephone company may request that you disconnect the equipment until the problem is resolved.

This equipment may not be used on coin service provided by the telephone company. Connection to party line service is subject to state tariffs. Contact the state public utility commission, public service commission or corporation commission for information.

If your home has specially wired alarm equipment connected to the telephone line, ensure the installation of this equipment ID does not disable your alarm equipment. If you have questions about what will disable alarm equipment, consult your telephone company or a qualified installer.

This equipment is hearing-aid compatible.

When programming and/or making test calls to emergency numbers:

- ◆ Remain on the line and briefly explain to the dispatcher the reason for the call.
- ◆ Perform such activities in the off-peak hours, such as early morning or late evening.

S H A R P

Date Revised: _____

Date Issued : July. 3. 2001

MATERIAL SAFETY DATA SHEET (1/2)

MSDS No. B-1026

Section 1. Product and Company Identification

Product Name : IMAGING FILM UX-5CR**Supplier Identification :** Sharp Corporation

22-22 Nagaïke-cho, Abeno-ku, Osaka, Japan

Manufacturer : DAINIPPON PRINTING CO. LTD.

591-2, Kamihirose, Higashikubo, Sayamashi, Saitama, 350-1321 JAPAN

Emergency telephone number : +81-42-952-9666

Local suppliers are listed below. Please contact the nearest supplier for additional information.

(Country)	(Name and Telephone Number)
U.S.A.	Sharp Electronics Corporation Telephone number for information: 1-800-237-4277
Canada	Sharp Electronics of Canada Ltd. Telephone number for information : 905-890-2100 Emergency telephone number : 1-800-255-3924

Section 2. Ingredients

Ingredients	CAS No.	Proportion	OSHA PEL	ACGIH TLV	Other
Polyethylene terephthalate film	25038-59-9	47 ~ 52%	-	-	None
Coating layer substances					
Carbon Black	1333-86-4	7 ~ 10%	3.5 mg/m ³	3.5 mg/m ³	None
Ester wax	8015-86-9	2 ~ 7%	-	-	None
Paraffin Wax	8002-74-2	10 ~ 14%	-	2.0 mg/m ³	None
Microcrystalline wax	63231-60-7	16 ~ 22%	-	-	None
Ethylene Vinyl Acetate Copolymer	24937-78-8	1 ~ 5%	-	-	None
Others		1 ~ 6%	-	-	None

Section 3. Hazardous Identification

Route(s) of Entry:	Inhalation?	Skin?	Ingestion?
	NO	NO	Possible but very unusual

Signs and Symptoms of Exposure: None**Medical Conditions Aggravated by Exposure:** None**POTENTIAL HEALTH EFFECTS:****Inhalation:** None**Skin Contact:** None**Eye Contact:** None**Ingestion:** None

Section 4. First-Aid Measures

Inhalation: No applicable

Skin Contact: In case of contact, usually special care is not necessary. If it dirties skin, clear with water and soap.

Eye Contact: In case of contact, immediately flush eyes with plenty of water. If necessary, then care for medical attention.

Ingestion: Immediately make vomit it and rinse mouth with water. If necessary, then care for medical attention.

Section 5. Fire-Fighting Measures

Flash Point: about 250°C for ink**Autoignition:** None**Flammability Limits:** Not applicable**Extinguishing Media:** CO₂, Water, Dry chemicals, Foam**Firefighting:** None**Fire and Explosion Hazard:** None**Hazardous Combustion Products:** None

S H A R P

Date Revised: _____

Date Issued : July. 3. 2001

MATERIAL SAFETY DATA SHEET (2/2)

MSDS No. B-1026

Section 6. Accidental Release Measures

Rumpling the product may cause the wax layer to peel off. Sweep up or vacuum. When sweeping, avoid raising film or dust. If a vacuum is used, motor should be rated as dust tight. Wash any residue off skin with soap and water. Garments may be washed or dry cleaned after removal of loose film or dust.

Section 7. Handling and Storage

No special precautions for safety reason.
Store in cool, dry place, avoid direct sunlight.

Section 8. Exposure Control/Personal Protection

Ventilation: None
Eye Protection: None
Protective Clothing: None
Gloves: None

Section 9. Physical and Chemical Properties

Description: Not applicable	Freezing Point: None
Melting Point: 71°C	Boiling Point: None
Pressurized: None	Specific Gravity (H20 = 1): about 1.2
pH: None	Water Solubility: Not applicable
Evaporation Rate: Negligible	
Volatility: None	

Section 10. Stability and Reactivity

Stability:	Stable
Conditions to Avoid:	None
Incompatibility (Materials to Avoid):	None
Hazardous Decomposition or Byproducts:	CO, CO ₂ , NO _x and H ₂ O
Hazardous Polymerization:	Will not occur

Section 11. Toxicological Information

Acute Toxicity: None
Chronic Toxicity: None

Section 12. Ecological Information

No environmental effect at normal use.

Section 13. Disposal Consideration

Dispose by the same method of ordinary plastic products in accordance with all applicable regulations. Any disposal practice must be in compliance with local, state and federal laws and regulations. If necessary, contact government office and ensure conformity with disposal regulations.

Section 14. Transport Information

No specific precautionary transport measure for safety reasons.
As to storage conditions, see section 7.

Section 15. Regulatory Information

None

Section 16. Other Information

The information herein is given in good faith, but no warranty, if used any process. Final determination of suitability of any material is the sole responsibility of the user. Although certain information are described herein, we cannot guarantee, that these are the only hazard, which exist. Information on this data sheet represents our current data and best opinion as to the proper use in handling of this product under normal conditions.
Restrictions: This information relates only to the specific material designated as supplied by the manufacturer. This information is supplied to us by the manufacturer and Sharp offers no warranties as to its accuracy and accepts no responsibilities for any typographical errors which may appear on these sheets. It is the responsibility of the user to determine the suitability of this product for each particular use.

Quick Reference Guide

Sending Faxes

Place your document (up to 10 pages) face down in the document feeder.

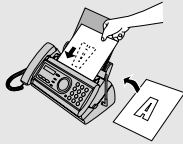

Normal Dialing

1. Lift the handset or press .
2. Dial the fax number.
3. Wait for the reception tone (if a person answers, ask them to press their Start key).

4. Press .

Automatic Dialing

1. Press or until the desired destination appears in the display.

2. Press .

Direct Keypad Dialing

1. Dial the fax number.

2. Press .

Recording an OGM

1. Press , press until desired OGM is displayed, and then once.

2. Lift the handset, press , and speak into the handset.

3. When finished, press .

Receiving Faxes

Press until the arrow in the display points to the desired reception mode.

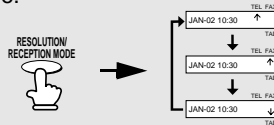

FAX mode: The fax machine automatically answers and receives faxes.

TEL mode: Answer all calls (even faxes) by picking up the handset. To begin fax reception, press .

TAD mode: Select this mode when you go out to receive both voice messages and faxes.

Storing Auto Dial Numbers

1. Press once and twice.
2. Enter the full fax/phone number.

3. Press .

4. Enter a name by pressing number keys. (To enter two letters in succession that require the same key, press after entering the first letter.)

SPACE = 1	G = 4	N = 6 6	U = 8 8
A = 2	H = 4 4	O = 6 6 6	V = 8 8 8
B = 2 2	I = 4 4 4	P = 7	W = 9
C = 2 2 2	J = 5	Q = 7 7	X = 9 9
D = 3	K = 5 5	R = 7 7 7	Y = 9 9 9
E = 3 3	L = 5 5 5	S = 7 7 7 7	Z = 9 9 9 9
F = 3 3 3	M = 6	T = 8	

5. Press and then .

Using the Cordless Phone

Making a phone call

1. Pick up the cordless handset and press



2. When you hear the dial tone, dial the number.

3. When you are ready to end the call,



Making a phone call using automatic dialing

1. Press once.

2. Press or to select the book.

3. Press or until the number you wish to dial appears in the display.

4. Press .

Receiving a phone call

1. When the cordless handset rings, pick it up and press any key to answer.

2. When you are ready to end the call,

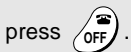

Receiving a fax using the cordless handset

If you hear a fax tone after answering a call on the cordless handset, or if the other party speaks to you and then

wants to send a fax, press .

Storing auto dial numbers

1. Press **SEARCH**, or to select

the book, and then .

2. Enter the full fax/phone number.

To clear a mistake, press .

To insert a pause, press .

3. Press .

4. Enter a name by pressing number keys. (To enter two letters in succession that require the same key, press after entering the first letter.)

SPACE = 1	G = 4	N = 6	U = 8
A = 2	H = 4	O = 6	V = 8
B = 2	I = 4	P = 7	W = 8
C = 2	J = 5	Q = 7	X = 9
D = 3	K = 5	R = 7	Y = 9
E = 3	L = 5	S = 7	Z = 9
F = 3	M = 6	T = 8	

5. Press and then .

Listening to messages

1. Press .

(For the general box, press .

2. Press to listen to all your

messages, or to listen to only your new messages.

3. While listening, you can press

REPEAT, SKIP, DELETE, or STOP.

4. When finished, press .

Guía de referencia rápida

Transmisión de mensajes telefax

Coloque el original (hasta 10 páginas) cara abajo en el alimentador de documentos.

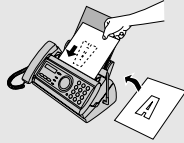

Marcación normal

1. Levante el auricular u oprima: .
2. Marque el número de telefax.
3. Espere hasta escuchar el tono de recepción (si contestara una persona, pídale oprimir su tecla Start).
4. Oprima: .

Marcación automática

1. Oprima la tecla de flecha o hasta que en el visor aparezca el destino deseado.

2. Oprima: .

Marcación directa por teclado

1. Marque el número de fax.
2. Oprima: .

Grabación de un mensaje de bienvenida

1. Oprima la tecla , oprima hasta que en el visor aparezca el mensaje de bienvenida deseado y, a continuación, oprima una vez.
2. Levante el auricular, oprima la tecla y hable en el microteléfono.
3. Oprima la tecla cuando haya finalizado.

Recepción de mensajes telefax

Oprima hasta que la flecha que hay en el display señale hacia el número de recepción deseado

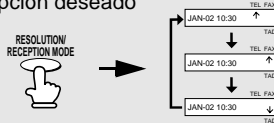

Modo FAX: El aparato telefax contesta y transmite automáticamente mensajes telefax.

Modo TEL: Responda a todas las llamadas (incluso mensajes de fax), levantando el auricular. Para iniciar la recepción de fax,

oprime .

Modo TAD: Seleccione este modo cuando salga para recibir tanto mensajes hablados como telefax.

Memorizar números marc. automática



1. Oprima una vez y dos veces.
2. Introduzca el número de telefax/teléfono completo.
3. Oprima: .
4. Ingrese el nombre oprimiendo las teclas numéricas. (Para ingresar sucesivamente dos letras que requieren la misma tecla, oprima después de ingresar la primera letra).

SPACE = 1	G = 4	N = 6 8	U = 8 8
A = 2	H = 4 4	O = 6 6 6	V = 8 8 8
B = 2 2	I = 4 4 4	P = 7	W = 9
C = 2 2 2	J = 5	Q = 7 7	X = 9 9
D = 3	K = 5 5	R = 7 7 7	Y = 9 9 9
E = 3 3	L = 5 5 5	S = 7 7 7 7	Z = 9 9 9 9
F = 3 3 3	M = 6	T = 8	







5. Oprima y luego .

Uso del teléfono inalámbrico

Hacer una llamada

1. Descuelgue el teléfono inalámbrico y oprima .
2. Marque los números cuando escuche el tono de línea.
3. Oprima  cuando esté listo para finalizar la llamada.

Hacer una llamada usando la función de marcación automática

1. Oprima una vez .
2. Oprima  o  para seleccionar el listín.
3. Oprima  o  hasta que en el display aparezca el número que desea llamar.
4. Oprima .

Recibir una llamada

1. Cuando suene el timbre del teléfono inalámbrico, descuélguelo y oprima una tecla cualquiera para contestar.
2. Oprima  cuando esté listo para finalizar la llamada.

Recibir un mensaje telefax usando el teléfono inalámbrico

Si después de atender una llamada con el teléfono inalámbrico escucha el tono de telefax o si el interlocutor desea remitirle un mensaje telefax, oprima .

Memorizar números para marcación automática

1. Oprima la tecla ,  o  para seleccionar el listín y, a continuación,

FUNCTION
/PAUSE

























































2. Introduzca el número de teléfono/telefax completo.



Para borrar un error, oprima .

Para introducir una pausa, oprima .

3. Oprima .

4. Introduzca un nombre mediante pulsación de las teclas numéricas. (Para introducir dos letras consecutivas que requieran el mismo código, oprima  después de introducir la primera letra.



SPACE = 	G = 	N =  	U =  
A = 	H =  	O =   	V =   
B =  	I =   	P = 	W = 
C =   	J = 	Q =  	X =  
D = 	K =  	R =   	Y =   
E =  	L =   	S =   	Z =   
F =   	M = 	T = 	

5. Oprima  y, a continuación, .

Escuchar los mensajes

1. Oprima .

(Para el buzón general, oprima ).

2. Oprima  para escuchar todos sus mensajes o  para escuchar sólo los mensajes nuevos.

3. Mientras hace la escucha puede pulsar

 , , o .

4. Pulse  cuando haya terminado.

Index

A

- Answering system, activating, 50
- Anti Junk Fax, 98
- Audible signals, 118
- Auto-dial numbers
 - Storing, 36, 74
 - Using, 38, 77

B

- Battery
 - Disposing of, 107
 - Installing, 18
 - Replacing, 106

C

- Caller ID, 91-96
- Caller ID List, 100
- Contrast, 72
- Copies, 89
- Copy cut-off setting, 90
- Cordless handset
 - Auto-dial numbers, storing, 36
 - Auto-dial numbers, using, 38
 - Faxes, receiving, 36
 - Hold, 35
 - Listening to messages, 54
 - Making a call, 34
 - Name, 20
 - Receiver volume, 33
 - Receiving a call, 35
 - Reception mode, changing, 46
 - Redialing, 41
 - Ringer volume, 33
 - Talking range, 19
- CPC Detection, 58

D

- Date, setting, 28-29
- Daylight Saving Time, 29
- Dial mode, 15

Dialing

- Automatic, 38, 77
- Direct Keypad, 78
- Normal, 34, 73
- Direct Keypad Dialing, 78
- Display messages, 92, 114-117
- Distinctive ring, 97
- Document feeder, 70
- Document guides, 70
- Document restrictions, 70
- Document sizes, 69
- Document, maximum scanning size, 69

E

- ECM (Error Correction Mode), 80
- Extension telephone, using, 85

F

- FAX reception mode, 30, 83
- Fax reception on TAD failure, 56
- Fax Signal Receive, 86

H

- Halftone setting, 71
- Handset, 14
- Handset receiver volume (fax machine), 31
- Headset jack, 21
- Housing, cleaning, 105

I

- Imaging film, replacing, 22
- Intercom, 41

J

- Jams, clearing, 119-120

L

- Letters, entering, 20, 27, 37, 75

Index

Line error, 108
Loading paper, 24
Loading the document, 70

M

Memory transmission, 82
Memory, substitute reception to, 88
Message List, 100
Messages
 Erasing, 53, 54
 Listening to, 52
 Listening to on cordless handset, 54
 Listening to remotely, 64
 Setting allowed time, 56

N

Normal dialing, 34, 73
Number of rings in FAX reception mode, 83
Number of rings in TAD mode, 51

O

OGM only mode, 57
Ordering parts, 121
Outgoing message, 48

P

Paper jams, clearing, 119-120
Paper size setting, 25
Paper tray extension, 16
Paper, loading, 24
Personal box, setting passcode, 49
Power cord, 14
Print contrast setting, 25
Print head, cleaning, 103-104

Priority Call, 95

R

Reception mode
 FAX mode, 30, 83
 TAD mode, 30, 50
 TEL mode, 30, 84
Reception Ratio setting, 87
Redialing, 41, 79
Remote code number, 62
Remote operations, 62
Resolution, 71
Ringer volume
 Cordless handset, 33
 Fax machine, 32

S

Scanning glass, cleaning, 104
Sender's name and number, entering, 26-27
Setup List, 100
Speaker volume, 31

T

TAD reception mode, 30, 50
TEL reception mode, 30, 84
TEL. LINE jack, 15
Telephone line cord, 15
Telephone Number List, 100
Time, setting, 28-29
Toll Saver function, 51, 63
Transaction Report, 101
 Setting print condition, 102
Transfer Function, 59
Transferring calls, 44

REMOTE OPERATION CARD

The card below is provided as a quick guide to remote operation. Cut it out and carry it with you when you go out.

Remote Operation Guide

SHARP®

1. Call your fax from a touch-tone telephone, and press when the outgoing message begins.
2. If you want to listen to a personal box, enter its number.
3. Enter your passcode or remote code:
4. Press .
5. After listening to your messages, you can either hang up to save them, or enter one of the commands on the reverse side.

REMOTE COMMANDS

- **PLAYBACK**

Play messages **7** **#**
 Move backward/repeat..... **2** **#**
 Skip forward..... **5** **#**
 Stop **0** **#**
 Play new messages only .. **6** **#**
 (first stop playback)

- **ERASING MESSAGES**

Erase single message **3** **#**
 Erase all messages **3** **3** **#**

- **RECORDING A MEMO**

Start **✕** **#**
 End **0** **#**

- **RECORDING A NEW OGM**

Start **4** **✕**

- **FAX RECEPTION MODES**

TAD mode..... **8** **1** **#**
 FAX mode..... **8** **2** **#**
 TEL mode..... **8** **3** **#**

- **TRANSFER FUNCTION**

Turn on **9** **1** **#**
 → (Box#)
 → **#**
 Turn off **9** **2** **#**
 New transfer number **9** **0** **#**
 → (Tel. #)
 → **#**
 Record transfer OGM **9** **3** **#**
 To quickly disconnect..... **✕** **✕**

- **OGM ONLY MODE**

Turn on **1** **1** **#**
 Turn off **1** **2** **#**

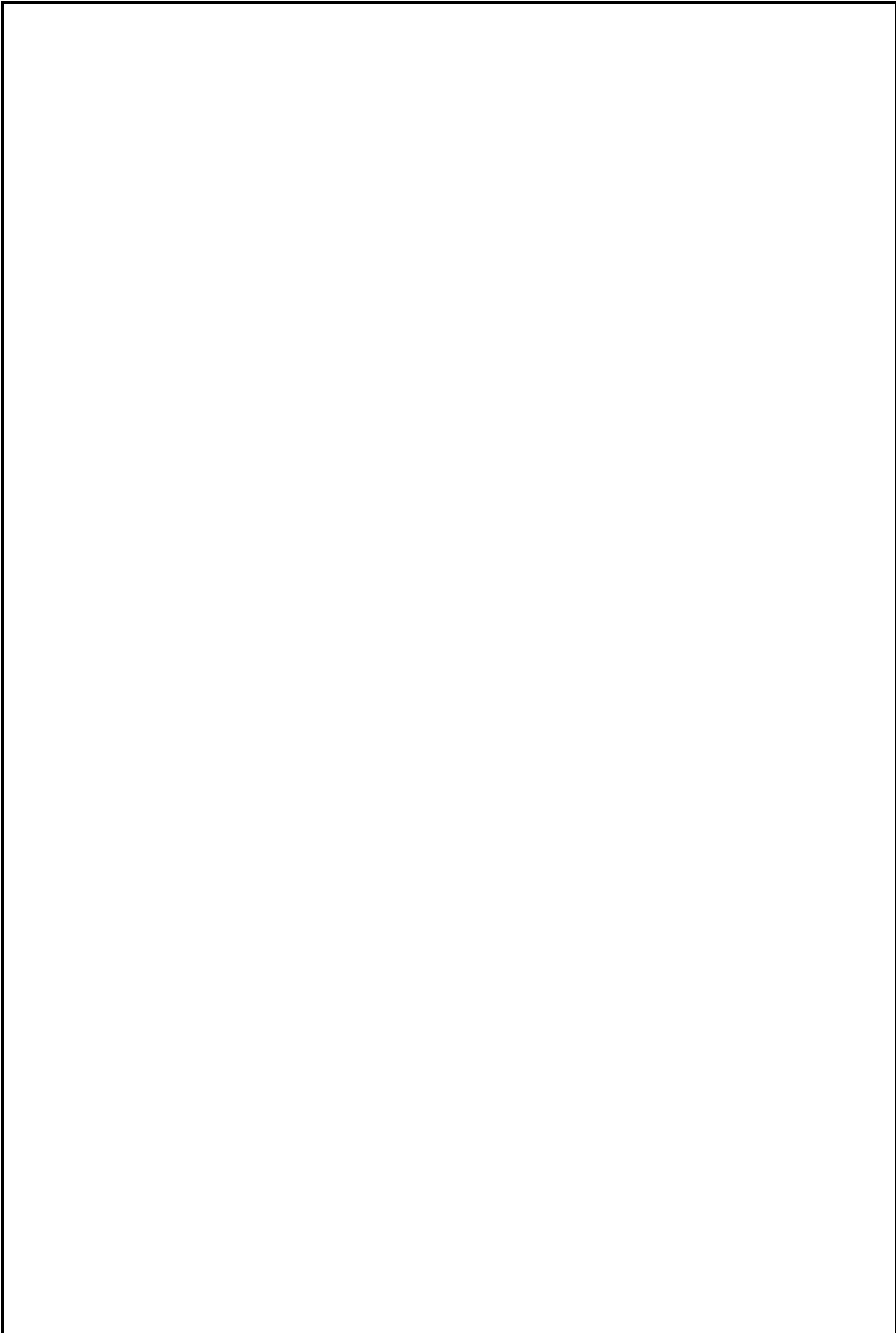

END USER LIMITED WARRANTY

SHARP ELECTRONICS CORPORATION warrants to the first end user purchaser that this Sharp brand product (the "Product"), when shipped in its original container, will be free from defective workmanship and materials, and agrees that it will, at its option, either repair the defect or replace the defective Product or part thereof with a new or remanufactured equivalent at no charge to the purchaser for parts or labor for the period(s) set forth below.

This warranty does not apply to any appearance items of the Product nor to the additional excluded item(s) set forth below nor to any product the exterior of which has been damaged or defaced, which has been subjected to misuse, abnormal service or handling, or which has been altered or modified in design or construction.

In order to enforce the rights under this limited warranty, the purchaser should follow the steps set forth below and provided proof of purchase to the servicer.

To the extent permitted by applicable state law, the warranties set forth herein are in lieu of, and exclusive of, all other warranties, express or implied. Specifically, ALL OTHER WARRANTIES OTHER THAN THOSE SET FORTH ABOVE ARE EXCLUDED. ALL EXPRESS AND IMPLIED WARRANTIES INCLUDING THE WARRANTIES OF MERCHANTABILITY, FITNESS FOR USE, AND FITNESS FOR A PARTICULAR PURPOSE ARE SPECIFICALLY EXCLUDED. If, under applicable state law, implied warranties may not validly be disclaimed or excluded, the duration of such implied warranties is limited to the period(s) from the date of purchase set forth below.

Neither the sales personnel of the seller nor any other person is authorized to make any warranties other than those described above, or to extend the duration of any warranties beyond the time period described above on behalf of Sharp.

The warranties described herein shall be the sole and exclusive warranties granted by Sharp and shall be the sole and exclusive remedy available to the purchaser. Correction of defects, in the manner and for the period of time described herein, shall constitute complete fulfillment of all liabilities and responsibilities of Sharp to the purchaser with respect to the Product, and shall constitute full satisfaction of all claims, whether based on contract, negligence, strict liability or otherwise. In no event shall Sharp be liable, or in any way responsible, for any damages or defects in the Product which were caused by repairs or attempted repairs performed by anyone other than an authorized servicer. Nor shall Sharp be liable or in any way responsible for any incidental or consequential economic or property damage. Some states do not allow limits on warranties or on remedies for breach in certain transactions; in such state the limits herein may not apply.

Your Product:

Personal Facsimile UX-CC500

Warranty Period for this Product:

Ninety (90) days parts and labor from date of purchase.

Additional items excluded from warranty coverage:

Any consumable items such as paper or Imaging Film supplied with the Product.

What to do to obtain service:

Call Sharp at 1-877-794-8675 to obtain a Return Authorization Number and shipping instructions. A technician will troubleshoot your problem with you on the phone and if it is determined that your Product needs service, you will have your choice of having your unit repaired or replaced to any U.S. location. Be sure to have Proof of Purchase available.

For product information or customer assistance, please visit <http://www.sharpusa.com> on the World Wide Web or call **1-877-794-8675**.

SHARP ELECTRONICS CORPORATION

Sharp Plaza,

Mahwah, New Jersey 07430-2135

IMPORTANT SERVICE INFORMATION

If a Problem Occurs

Most operational questions can be answered by referring to this "Setup Guide and Operation Manual". Also, for your convenience, you will find answers to most frequently asked questions on our website at www.sharpusa.com/, or by sending e-mail to faxsupport@sharpsec.com. Should you require further assistance, call 1-877-794-8675; a Customer Relations Specialist will assist you. Before your call, please be ready to provide the model number of your product, serial number, date of purchase, description of the problem, and a valid credit card number (should it be required).

How Exchange is Obtained

A replacement unit in exchange for your fax is provided by Sharp to any U.S. location. You will be required to provide consent for acceptance of an exchange unit and provide credit card authorization. At that time, Sharp will ship to you, at no cost, an exchange for your defective product. The exchange unit we ship to you will be new or remanufactured. Upon your receipt of the exchange unit, packaging and shipping instructions will be enclosed for you to return the defective unit. Upon Sharp's receipt of the defective unit, your credit card hold will be released.

How Warranty Repair Service is Obtained

If you prefer that we repair your unit instead of replacing it, our Customer Relations Specialists at 1-877-794-8675 will explain how to obtain warranty repair service. **Please be sure to retain the original packaging materials in order to facilitate shipment.** Upon repair of your unit, Sharp will promptly return it at no cost to you at any U.S. location.

What You Must Do

Your Product is designed to perform with a minimum amount of user maintenance. However, you are responsible for the required user maintenance described in the "Operation Manual". This requires user maintenance including replacement of the imaging film and battery, cleaning of the unit and removal of dust and foreign matter, clearing of paper misfeeds, and proper routine and preventive maintenance.

Service After Expiration of Warranty Coverage

Should you require service repair after warranty coverage has expired, contact Sharp at 1-877-794-8675 for information.

To Purchase Consumables From Sharp

Visit www.sharpplace.com/ or call Sharp at 1-877-794-8675 to order replacement Sharp Thermal Ribbons & Accesories. Before your call, please be ready to provide the model number of your product, and a valid credit card number. Consumables may also be obtained through your reseller.

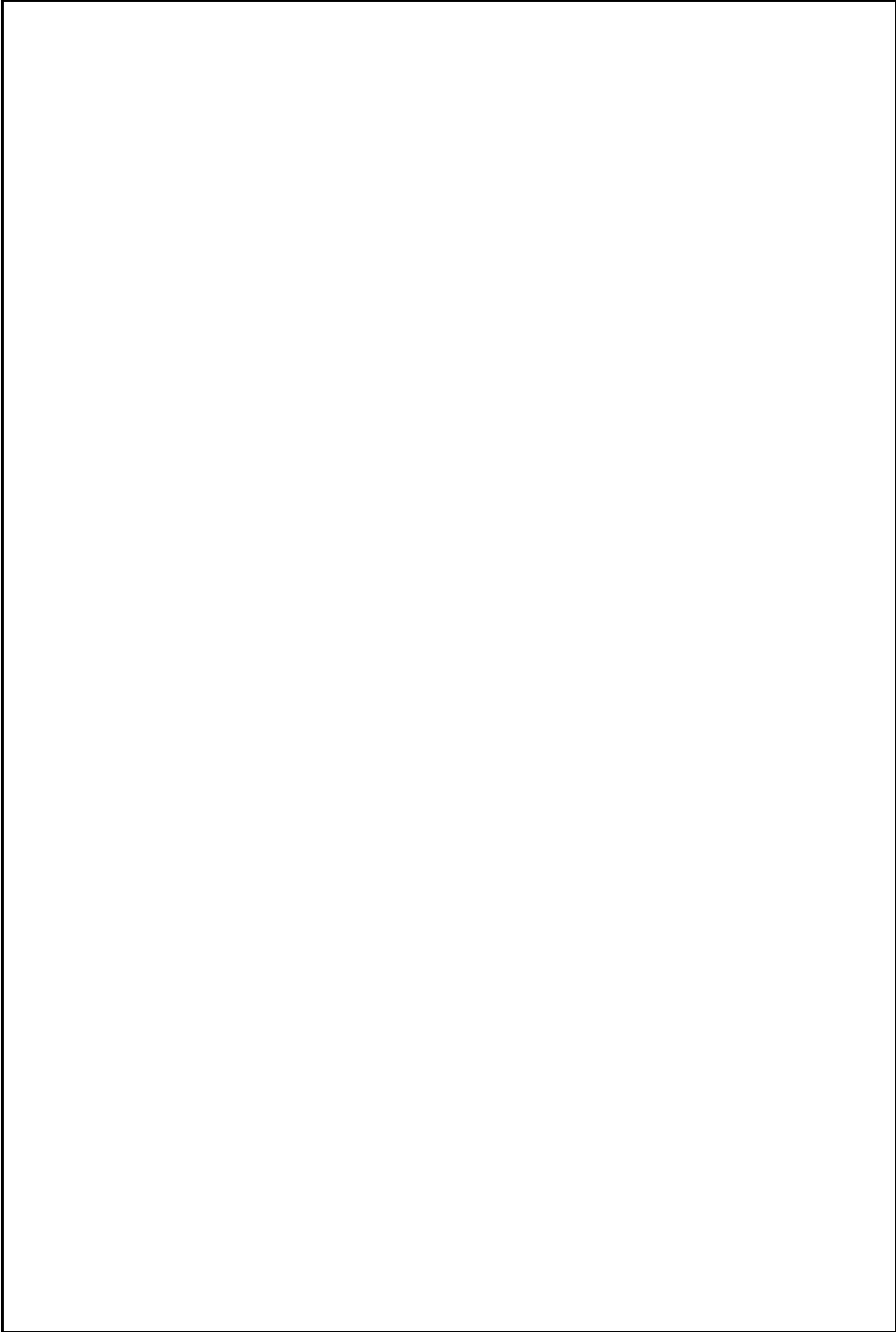

SHARP®

SHARP ELECTRONICS CORPORATION

Sharp Plaza, Mahwah, New Jersey 07430-2135

<http://www.sharpusa.com>

SHARP CORPORATION

FOR YOUR RECORDS

Please record the model number and serial number below, for easy reference, in case of loss or theft. These numbers are located on the rear side of the unit. Space is also provided for other relevant information.

Model Number UX-CC500

Serial Number _____

Date of Purchase _____

Place of Purchase _____

PRINTED IN THAILAND

(TINSE4273XHTZ)

Free Manuals Download Website

<http://myh66.com>

<http://usermanuals.us>

<http://www.somanuals.com>

<http://www.4manuals.cc>

<http://www.manual-lib.com>

<http://www.404manual.com>

<http://www.luxmanual.com>

<http://aubethermostatmanual.com>

Golf course search by state

<http://golfingnear.com>

Email search by domain

<http://emailbydomain.com>

Auto manuals search

<http://auto.somanuals.com>

TV manuals search

<http://tv.somanuals.com>