

# PlasmaView™

## HIGH DEFINITION PLASMA DISPLAYS

Models VP-5000VHD, VP-5000VHDa,

VP-6500VHD, VP-6500VHDa

and VP-103VHD



---

# THREE YEAR LIMITED WARRANTY

## For Plasma Displays

### from Vidikron, a business of Runco International, LLC (“Vidikron”)

Congratulations on your purchase of a Vidikron video product and welcome to the Vidikron family! With proper installation, setup and care, you should enjoy many years of unparalleled video performance.

This is a LIMITED WARRANTY as defined in the Magnuson-Moss Warranty Act. Please read it carefully and retain it with your other important documents.

#### **WHAT IS COVERED UNDER THE TERMS OF THIS LIMITED WARRANTY:**

The following Vidikron plasma display models are covered under this Limited Warranty:

VP-5000VHD, VP-5000VHDa, VP-6500VHD, VP-6500VHDa and VP-103VHD (“Product” individually and “Products” collectively).

**SERVICE LABOR:** Vidikron will pay for service labor at an Authorized Service Center when needed as a result of manufacturing defect for a period of three (3) years from the date of delivery to the initial end user (excluding the plasma glass panel).

**PARTS** (not including plasma glass panel): Vidikron will provide new or rebuilt replacement parts for the parts that fail due to defects in materials or workmanship for a period of three (3) years from the effective date of delivery to the initial end user. Such replacement parts are then subsequently warranted for the remaining portion (if any) of the original warranty period.

**PLASMA GLASS PANEL:** Vidikron will pay for service labor at an Authorized Service Center when needed as a result of a manufacturing defect for a period of one (1) year from the effective date of delivery to the initial end user. In addition, Vidikron will provide new or rebuilt replacement parts for the parts that fail due to defects in materials or workmanship for a period of one (1) year from the effective date of delivery to the initial end user. Such replacement parts are then subsequently warranted for the remaining portion (if any) of the original warranty period.

#### **WHAT IS NOT COVERED UNDER THE TERMS OF THIS LIMITED WARRANTY:**

Image burn-in on plasma display panels is specifically excluded from coverage under this Limited Warranty. Image burn-in is the result of misuse of the Product and therefore cannot be repaired under the terms of this Limited Warranty.

Normal viewing material such as television/satellite broadcasts, videotape or DVDs (not put into pause for extended periods of time) will not cause damage to your display under normal conditions. Many DVD players are also equipped with screen savers for this reason.

**TO AVOID IMAGE RETENTION (Burn-in):** Please ensure that still images are left on your plasma display panel for no more than a few minutes. Also ensure that images displayed in the 4:3 aspect ratio mode (black or gray stripes, but no picture information is present on the left and right edges of the screen) are used as infrequently as possible. This will prevent permanent image burns on your plasma display panel, which can be seen permanently under certain conditions once burn-in has occurred.

The types of images to avoid include video games, still images and computer screens with stationary tool bars and icons. (This is why computers are equipped with screen savers – to prevent still images from burning into the monitor’s phosphors after being displayed continuously for an extended period of time).

This Limited Warranty only covers failure due to defects in materials and workmanship that occur during normal use and does not cover normal wear and tear nor any Product on which the serial number has been defaced, modified, or removed. This Limited Warranty does not cover: cabinets or any appearance items; failure resulting from accident, misuse, abuse, neglect, mishandling, misapplication, or faulty or improper installation or setup adjustments; improper maintenance; alteration; improper use of any input signal; damage due to lightning or power line surges, spikes and brownouts; damage that occurs during shipping or transit; damage that is attributed to acts of God; customer caused defects; or rental costs incurred due to Product failure. In the case of remote control units, damage resulting from leaking, old, damaged or improper batteries is also excluded from coverage under this Limited Warranty.

---

CAUTION: THIS LIMITED WARRANTY ONLY COVERS VIDIKRON PRODUCTS PURCHASED FROM AUTHORIZED VIDIKRON DEALERS. ALL OTHER PRODUCTS ARE SPECIFICALLY EXCLUDED FROM COVERAGE UNDER THIS WARRANTY. MOREOVER, DAMAGE RESULTING DIRECTLY OR INDIRECTLY FROM IMPROPER INSTALLATION OR SETUP IS SPECIFICALLY EXCLUDED FROM COVERAGE UNDER THIS LIMITED WARRANTY. IT IS IMPERATIVE THAT INSTALLATION AND SETUP WORK BE PERFORMED ONLY BY AN AUTHORIZED VIDIKRON DEALER TO PROTECT YOUR RIGHTS UNDER THIS WARRANTY. THIS WILL ALSO ENSURE THAT YOU ENJOY THE FINE PERFORMANCE OF WHICH YOUR VIDIKRON PRODUCT IS CAPABLE WHEN INSTALLED AND CALIBRATED BY AN AUTHORIZED VIDIKRON DEALER.

#### **RIGHTS, LIMITS AND EXCLUSIONS:**

THE FOREGOING DESCRIBED WARRANTIES ARE THE ONLY WARRANTIES THAT APPLY TO THE PRODUCTS. VIDIKRON MAKES NO OTHER WARRANTY OR REPRESENTATION AND HEREBY DISCLAIMS ALL OTHER WARRANTIES, EXPRESS OR IMPLIED, INCLUDING, BUT NOT LIMITED TO, THE IMPLIED WARRANTIES OF MERCHANTABILITY AND FITNESS FOR A PARTICULAR PURPOSE. VIDIKRON'S LIABILITY RELATED TO THE PRODUCT IS LIMITED TO THE COST OF THE APPLICABLE REMEDY AS NOTED ABOVE. IN NO EVENT SHALL VIDIKRON BE LIABLE FOR:

- DAMAGE TO OTHER PROPERTY CAUSED BY ANY DEFECTS IN THE PRODUCT, DAMAGES BASED UPON INCONVENIENCE, LOSS OF USE OF THE PRODUCT, LOSS OF TIME, LOSS OF PROFITS, LOSS OF BUSINESS OPPORTUNITY, LOSS OF GOODWILL, INTERFERENCE WITH BUSINESS RELATIONSHIPS, OR OTHER COMMERCIAL LOSS, EVEN IF ADVISED OF THE POSSIBILITY OF SUCH DAMAGES;
- ANY OTHER DAMAGES, WHETHER INCIDENTAL, CONSEQUENTIAL OR OTHERWISE;
- ANY CLAIM AGAINST THE CUSTOMER BY ANY OTHER PARTY; OR
- ANY VERBAL WARRANTY ASSURANCES MADE BY A VIDIKRON EMPLOYEE OR A VIDIKRON AUTHORIZED DEALER THAT CONFLICTS WITH OR ENHANCES THE WRITTEN WARRANTY INCLUDED HEREIN.

#### **EFFECTIVE WARRANTY DATE:**

This Limited Warranty begins on the date of delivery to the end user. For your convenience, keep the original bill of sale as evidence of the purchase date.

#### **CONTACT AN AUTHORIZED SERVICE CENTER TO OBTAIN SERVICE:**

Repairs made under the terms of this Limited Warranty covering your Vidikron Product will be performed at the location of the Product, during usual working hours, provided that the location of the Product is within normal operating distance from an Authorized Vidikron Service Center. In some instances it may be necessary for the Product to be returned to the Vidikron factory for repairs. If, solely in Vidikron's judgment, location of Product to be repaired is beyond normal operating distance of the closest Authorized Vidikron Service Center, or the repair requires the unit be returned to the Vidikron factory, it is the owner's responsibility to arrange for shipment of the Product for repair. These arrangements must be made through the selling Vidikron Dealer. If this is not possible, contact Vidikron directly for a Return Authorization number and shipping instructions. Vidikron will return Product with transportation prepaid in the United States, unless no Product defect is discovered. In that instance, shipping costs will be the responsibility of the Product owner.

---

**COPYRIGHT AND TRADEMARKS:**

© Copyright 2008 Runco International, LLC ("Runco"). This document contains proprietary information protected by copyright, trademark and other intellectual property laws. All rights are reserved. No part of this manual may be reproduced by any mechanical, electronic or other means, in any form, without prior written permission of Runco.

The trademarks reproduced in this Vidikron Owner's Manual and used on the Vidikron Products are either owned by Runco or are licensed by Runco. You may not reproduce or use the trademarks without the prior written consent of Runco.

THX and the THX logo are trademarks of THX Ltd. which may be registered in some jurisdictions. All rights reserved.

Vidikron Products are manufactured under one or more of the following patents: US. Patent 6755540 and Other Patents Pending.

**ADDITIONAL INFORMATION:**

To locate the name and address of the nearest Authorized Vidikron Service Center, or for additional information about this Limited Warranty, please call or write:

**VIDIKRON, c/o RUNCO INTERNATIONAL, LLC**  
**1195 NW Compton Drive**  
**Beaverton, OR 97006-1992**  
**Ph: (503) 748-5799**  
**Fax: (503) 748-8161**  
**Toll Free: (888) 4VIDIKRON (888-484-3457)**

---

**PRODUCT INFORMATION**  
**RETAIN FOR YOUR RECORDS**

_____		_____	
Model Purchased		Date	
_____			
Serial Number			
_____			
Vidikron Authorized Dealer Name			
_____			
Address			
_____			
_____	_____	_____	
City	State/Province	Postal Code	
_____			
Phone	Fax		

# Important Safety Instructions

Thank you for your purchase of this quality Vidikron video product! It has been designed to provide you with the quality of video that is expected in a home theater. For the best performance, please read this manual carefully as it is your guide through the menus and operation.

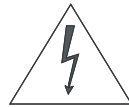
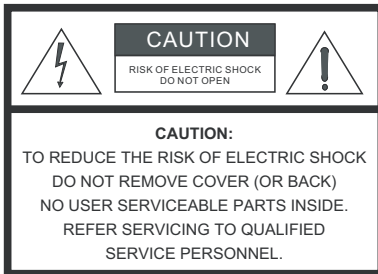

## WARNING

This symbol is intended to alert the user to the presence of uninsulated "dangerous voltage" within the product's enclosure that may be of sufficient magnitude to constitute a risk of electric shock.



This symbol is intended to alert the user to the presence of important operating and maintenance (servicing) instructions in the literature accompanying the appliance.

1. Read these instructions.
2. Keep these instructions.
3. Heed all warnings.
4. Follow all instructions.
5. Do not use this apparatus near water.
6. Clean only with a dry cloth.
7. Do not block any of the ventilation openings. Install in accordance with the manufacturer's instructions.
8. Do not install near any heat sources such as radiators, heat registers, stoves, or other apparatus (including amplifiers) that produce heat.
9. Do not defeat the safety purpose of the polarized or grounding type plug. A polarized plug has two blades with one wider than the other. A grounding type plug has two blades and a third grounding prong. The wide blade or the third prong is provided for your safety. When the provided plug does not fit into your outlet, consult an electrician for the replacement of the obsolete outlet.
10. Protect the power cord from being walked on or pinched particularly at plugs, convenience receptacles and the point where they exit from the apparatus.
11. Only use the attachments/accessories specified by the manufacturer.
12. Use only with a cart, stand, tripod, bracket or table specified by the manufacturer or sold with the apparatus. When a cart is used, use caution when moving the cart/apparatus to avoid injury from tip-over.
13. Unplug this apparatus during lightning storms or when unused for long periods of time.
14. Refer all servicing to qualified service personnel. Servicing is required when the apparatus has been damaged in any way, such as power supply cord or plug is damaged, liquid has been spilled or objects have fallen into the apparatus, the apparatus has been exposed to rain or moisture, does not operate normally, or has been dropped.
15. Keep the packing material in case the equipment should ever need to be shipped.



---

## Compliance Information

### DECLARATION OF CONFORMITY:

Manufacturer's Name: Runco International, LLC

Manufacturer's Address: 1195 NW Compton Drive, Beaverton, OR 97006-1992

hereby declares that the Products' Model Numbers:

VP-5000VHD, VP-5000VHDa, VP-6500VHD, VP-6500VHDa and VP-103VHD

conform with the provisions of:

Council Directive 2004/108/EC on Electromagnetic Compatibility;

EN 55022 "Limits and methods of measurements of radio interference characteristics of information technology equipment" 1998;

EN 55024 "Limits and methods of measurements of immunity characteristics of information technology equipment" 1998;

Including:

- EN 61000-4-2 "Electromagnetic compatibility (EMC) Part 4: Testing and measurement techniques Section 2: Electrostatic discharge immunity test"
- EN 61000-4-3 "Electromagnetic compatibility (EMC) Part 4: Testing and measurement techniques Section 3: Radiated, Radio-Frequency, Electromagnetic Field Immunity Test"
- EN 61000-4-4 "Electromagnetic compatibility (EMC) Part 4: Testing and measurement techniques Section 4: Electrical fast transient/burst immunity test"
- EN 61000-4-5 "Electromagnetic compatibility (EMC) Part 4: Testing and measurement techniques Section 5: Surge immunity test"
- EN 61000-4-6 "Electromagnetic compatibility (EMC) Part 4: Testing and measurement techniques Section 6: Conducted disturbances induced by radio-frequency fields immunity test"
- EN 61000-4-8 "Electromagnetic compatibility (EMC) Part 4: Testing and measurement techniques Section 8: Conducted disturbances induced by power frequency magnetic fields immunity test"
- EN 61000-4-11 "Electromagnetic compatibility (EMC) Part 4: Testing and measurement techniques Section 11: Voltage dips, short interruptions and voltage variations immunity tests"

And:

- EN 61000-3-2 "Electromagnetic compatibility (EMC) Part 3, Section 2: Limits for harmonic current emissions (equipment input current up to and including 16 A per phase)" 2000;
- EN 61000-3-3 "Electromagnetic compatibility (EMC) Part 3, Section 3: Limitations of voltage changes, voltage fluctuations and flicker in public low-voltage supply systems, for equipment with rated current up to and including 16 A and not subject to conditional connection" 1995;

Council Directive 2006/95/EC and amended by M1 and C1 on Low Voltage Equipment Safety;

EN 60950 "Safety of information technology equipment, including electrical business equipment"

The Technical Construction file required by this Directive is maintained at the corporate headquarters of Runco International, LLC, located at 1195 NW Compton Drive, Beaverton, OR 97006-1992.

Date of Declaration: March 2008

## FCC PART 15:

NOTE: This equipment has been tested and found to comply with the limits for a Class B digital device, pursuant to Part 15 of the FCC Rules. These limits are designed to provide reasonable protection against harmful interference in a residential installation.

This equipment generates, uses and can radiate radio frequency energy and, if not installed and used in accordance with the instructions, may cause harmful interference to radio communications. However, there is no guarantee that interference will not occur in a particular installation. If this equipment does cause harmful interference to radio or television reception, which can be determined by turning the equipment off and on, the user is encouraged to try to correct the interference by one or more of the following measures:

- Reorient or relocate the receiving antenna.
- Increase the separation between the equipment and receiver.
- Connect the equipment into an outlet on a circuit different from that to which the receiver is connected.
- Consult the dealer or an experienced radio/TV technician for help.

## INDUSTRY CANADA (ICES-003):

This Class B digital apparatus complies with Canadian ICES-003.

Cet appareil numérique de la classe B est conforme à la norme NMB-003 du Canada.

## PRODUCT DISPOSAL:

The Product contains small amounts of tin, lead and/or mercury. Disposal of these materials may be regulated due to environmental considerations.

## IMPORTANT RECYCLE INSTRUCTIONS



This product may contain mercury or other electronic waste that can be hazardous if not disposed of properly. Recycle or dispose in accordance with local, state, or federal Laws.

For more information, contact the Electronic Industries Alliance at [WWW.EIAE.ORG](http://WWW.EIAE.ORG).

For lamp specific disposal information check [WWW.LAMPRECYCLE.ORG](http://WWW.LAMPRECYCLE.ORG).

## DISPOSAL OF OLD ELECTRICAL AND ELECTRONIC EQUIPMENT (Applicable throughout the European Union and other European countries with separate collection programs)



This symbol found on your product or on its packaging, indicates that this product should not be treated as household waste when you wish to dispose of it. Instead, it should be handed over to an applicable collection point for the recycling of electrical and electronic equipment. By ensuring this product is disposed of correctly, you will help prevent potential negative consequences to the environment and human health, which could otherwise be caused by inappropriate disposal of this product. The recycling of materials will help to conserve natural resources. This symbol is only valid in the European Union. If you wish to discard this product, please contact your local authorities or dealer and ask for the correct method of disposal.



# Table of Contents

<b>THREE YEAR LIMITED WARRANTY .....</b>	<b>iii</b>
<b>Important Safety Instructions .....</b>	<b>vi</b>
<b>Compliance Information .....</b>	<b>vii</b>
<b>1. Introduction .....</b>	<b>1</b>
About This Manual .....	1
Target Audience.....	1
If You Have Comments About This Manual.....	1
Textual and Graphic Conventions .....	1
Using This Manual .....	2
Description, Features and Benefits .....	3
Key Features and Benefits.....	3
Parts List .....	4
<b>2. Controls and Functions .....</b>	<b>5</b>
PlasmaView VHD at a Glance .....	5
Controls and Indicators .....	5
Connectors.....	7
VHD Controller Front Panel .....	8
VHD Controller Rear Panel .....	9
Outputs.....	9
Inputs .....	9
VHD Controller Remote Control .....	11
<b>3. Installation .....</b>	<b>15</b>
Remote Control .....	15
Notes on Batteries .....	15
Notes on Remote Control Operation.....	15
Quick Setup .....	17
Installation Considerations .....	18
Special Requirements for the VP-103VHD.....	18
High-Altitude Operation .....	18
Mounting the PlasmaView VHD on a Wall or Table Stand/Floor Pedestal .....	18
Ambient Light.....	19
Ventilation.....	19
Other Considerations .....	21

---

Connections to the PlasmaView VHD and VHD Controller .....	22
Connecting the PlasmaView VHD to the VHD Controller .....	22
Connecting Source Components to the VHD Controller .....	24
RS-232 Controller Connection .....	28
Connecting 12-Volt Trigger Outputs to External Equipment.....	28
Connecting an External IR Receiver to the VHD Controller .....	29
Connecting AC Power .....	30
Cable Management.....	31
<b>4. Operation .....</b>	<b>33</b>
Turning on the Power .....	33
Setting the Computer Display Properties .....	33
Using the VHD Controller Menus .....	35
Main Menu .....	37
Input Source .....	37
Aspect Ratio .....	37
Picture .....	39
Input Position.....	42
Memory Presets.....	43
Information .....	43
Calibration.....	44
Service.....	46
<b>5. Maintenance and Troubleshooting .....</b>	<b>51</b>
Cleaning .....	51
Cleaning the Display Panel Body and Remote Control.....	51
Cleaning the Screen.....	51
Cleaning the Vents .....	51
Troubleshooting Tips .....	52
<b>6. Serial Communications .....</b>	<b>55</b>
RS-232 Connection and Port Configuration .....	55
Serial Command Syntax .....	55
<b>7. Specifications .....</b>	<b>61</b>
PlasmaView VHD Specifications .....	61
VHD Controller Specifications .....	62
PlasmaView VHD Dimensions .....	63
Supported Timings .....	66

## List of Figures

2-1. PlasmaView VP-5000VHD Front-Panel Controls and Indicators.....	5
2-2. PlasmaView VP-6500VHD Front-Panel Controls and Indicators.....	5
2-3. PlasmaView VP-103VHD Front-Panel Controls and Indicators.....	6
2-4. PlasmaView VHD Rear Panel.....	7
2-5. VHD Controller Front Panel .....	8
2-6. VHD Controller Rear Panel .....	9
2-7. VHD Controller Remote Control .....	11
3-1. Available Range of the Remote Control .....	15
3-2. Ventilation Requirements for Enclosure Mounting (VP-5000VHD and VP-6500VHD) .....	20
3-3. Ventilation Requirements for Enclosure Mounting (VP-103VHD) .....	20
3-4. Connecting the PlasmaView VHD to the VHD Controller.....	22
3-5. RS-232 Connection from the VHD Controller to the PlasmaView VHD .....	23
3-6. HDMI Source Connections .....	24
3-7. Digital (DTV) RGB Connections .....	25
3-8. Analog RGB Connections.....	26
3-9. Composite, S-Video and Component Video Connections.....	27
3-10. RS-232 Control System Connection .....	28
3-11. Connecting 12-Volt Trigger Outputs .....	28
3-12. External IR Receiver Connection.....	29
3-13. AC Power Connection .....	30
3-14. Cable Management.....	31
4-1. VHD Controller OSD Menu Structure for PlasmaView VHD.....	36
4-2. Typical PLUGE Pattern for Adjusting Brightness.....	39
4-3. Typical Gray Bar Pattern for Adjusting Contrast .....	40
4-4. Typical Color Bar Pattern for Adjusting Color Saturation and Tint .....	41
4-5. Typical Test Pattern for Adjusting Sharpness.....	42
7-1. PlasmaView VHD Model VP-5000VHD Dimensions (with Optional Table Stand) .....	63
7-2. PlasmaView VHD Model VP-6500VHD Dimensions (with Optional Table Stand) .....	64
7-3. PlasmaView VHD Model VP-103VHD Dimensions (with Floor Stand) .....	65

**Notes:**

# Introduction

This Owner's Manual describes how to install, set up and operate a Vidikron PlasmaView VHD High-Definition Plasma Display (Model VP-5000VHD, VP-5000VHDa, VP-6500VHD, VP-6500VHDa or VP-103VHD).

Throughout this manual, the Vidikron PlasmaView VHD High-Definition Plasma Display is referred to simply as the "PlasmaView VHD." Except where otherwise indicated, the information in this manual applies to all PlasmaView VHD models.

Vidikron has prepared this manual to help home theater installers and end users get the most out of the PlasmaView VHD.

Vidikron has made every effort to ensure that this manual is accurate as of the date it was printed. However, because of ongoing product improvements and customer feedback, it may require updating from time to time. You can always find the latest version of this and other Vidikron product manuals on-line, at [www.Vidikron.com](http://www.Vidikron.com).

Vidikron welcomes your comments about this manual. Send them to [info@Vidikron.com](mailto:info@Vidikron.com).

**Text Conventions:** The following conventions are used in this manual, in order to clarify the information and instructions provided:

- Remote control button identifiers are set in upper-case bold type; for example, "Press **EXIT** to return to the previous menu."
- Computer input (commands you type) and output (responses that appear on-screen) is shown in monospace (fixed-width) type; for example: "To change the aspect ratio to 16:9, type 16:9 <Enter>."
- All keys with functional names are initial-capped, set in bold type and enclosed in angle brackets. These keys are the following: <Enter>, <Spacebar>, <Control>, <Esc> and <Tab>.
- <Enter> indicates that you may press either the RETURN or ENTER key on your computer keyboard if it has both keys.

In addition to these conventions, underlining, boldface and/or italics are occasionally used to highlight important information, as in this example:



## Note

*A carriage return **must** be used after each command or string.*

## 1.1 About This Manual

### ◀ Target Audience

### ◀ If You Have Comments About This Manual...

### ◀ Textual and Graphic Conventions

**Graphic Conventions:** These symbols appear in numerous places throughout the manual, to emphasize points that you must keep in mind to avoid problems with your equipment or injury:



**Tip**

*TIPS highlight time-saving short cuts and helpful guidelines for using certain features.*



**Note**

*NOTES emphasize text with unusual importance or special significance. They also provide supplemental information.*



**Caution**

*CAUTIONS alert users that a given action or omitted action can degrade performance or cause a malfunction.*



**WARNING**

*WARNINGS appear when a given action or omitted action can result in damage to the equipment, or possible non-fatal injury to the user.*



**DANGER!**

*DANGER appears when a given action can cause severe injury or death.*

## 1.2 Using This Manual

Use the following table to locate the specific information you need in this manual.

<b>If you need...</b>	<b>... Turn to page:</b>
Information about obtaining service	iv
General information about the PlasmaView VHD High-Definition Plasma Display	3
Installation instructions	15
First-time configuration instructions	33
Advanced configuration instructions	44
Troubleshooting tips	52
Specifications for the PlasmaView VHD High-Definition Plasma Display	61

The PlasmaView VHD High-Definition Plasma Display establishes a higher threshold for flat panel display products. The PlasmaView VHD is available in three sizes, including our largest and highest-resolution plasma ever, at 103 inches diagonal and 1920 x 1080 (1080p) native resolution.

The PlasmaView VHD takes picture quality to a whole new level, boasting our brightest picture, best contrast ratio, deepest black levels and most spot-on high definition colorimetry ever! In addition, sophisticated 16-bit digital video processing, a new milestone, results in 4096 steps of gradation for seamless images, completely devoid of the primitive "solarization" and "stair stepping" characteristics previously plaguing digital flat panel displays.

Discrete, multiple aspect ratio control includes IntelliWide™ for viewing 4:3 content in widescreen without appreciable picture degradation, as well as ISF(ccc) calibration modes to easily maintain ISF standards. The automation interface includes RS-232 control with discrete aspect ratio, input and power on/off selection.

The included VHD Digital Video Controller/Processor provides a pure digital signal path from input to output as well as a broad array of video input choices, all available from its position in the equipment rack, with only digital video and control cables running to the display itself.

The PlasmaView VHD not only represents a leap forward in high definition flat-panel technology, but our engineering advances in plasma design ensure that it will enjoy a long life in any installation, with operation extending to as much as 60,000 hours. At less than 5-3/4 inches thin, the PlasmaView VHD provides unlimited installation flexibility as well.

For high-altitude installations, Vidikron also offers the VP-5000VHDa and VP-6500VHDa with industry-leading high-altitude compliance to over 9,000 feet mean sea level (MSL). The VP-5000VHDa and VP-6500VHDa share all other features and specifications with the VP-5000VHD and VP-6500VHD.

The PlasmaView VHD offers these key features and benefits:

- 16:9 Native Resolution: 1920 x 1080
- Multiple Aspect Ratios with IntelliWide™ Mode
- Includes the new VHD video controller/processor
- Less than 5-3/4 inches thin
- Models VP-5000VHDa and VP-6500VHDa are high-altitude compliant to over 9,000 feet
- Exceptional detail and artifact-free video enhancement
- Imagix™ video processing with 3:2 film detection circuitry

## 1.3 Description, Features and Benefits

### ◀ Key Features and Benefits

**Parts List** ➤ Your PlasmaView VHD is shipped with the following items. If any items are missing or damaged, please contact your Vidikron dealer or Vidikron Customer Service at (888) 4VIDIKRON (484-3457).

- PlasmaView VHD High-Definition Plasma Display
- AC Power Cords (2)
- Remote Control Unit and two (2), AAA-size batteries
- RJ-11 Telephone Cable, 50 feet (15.24 meters)
- Serial Port Adapter, RJ-11 Female to DB-9 Female
- Rack-mount hardware for the VHD Controller
- Cable Ties (2)
- Warranty information and registration card
- Vidikron PlasmaView VHD Installation/Operation Manual (this document)

**Optional Accessories – Models VP-5000VHD and VP-5000VHDa:**

- Wall Mount Kit (part number 956-0273-00)
- Table Stand (part number 956-0266-00)

**Optional Accessories – Models VP-6500VHD and VP-6500VHDa:**

- Wall Mount Kit (part number 956-0253-00)
- Table Stand (part number 956-0254-00)

**Optional Accessories – Models VP-103VHD:**

- Wall Mount Kit (part number 997-5371-00)
- Floor Stand (part number 997-5269-00)



# Controls and Functions

## 2.1 PlasmaView VHD at a Glance

◀ **Controls and Indicators**

Figure 2-1, Figure 2-2 and Figure 2-3 show the PlasmaView VHD front-panel controls and indicators.

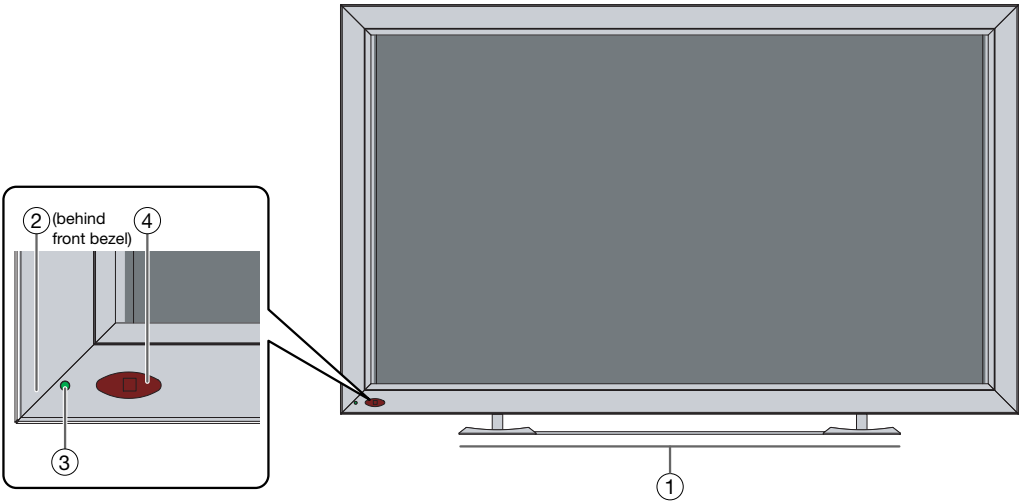

**Figure 2-1. PlasmaView VP-5000VHD Front-Panel Controls and Indicators**

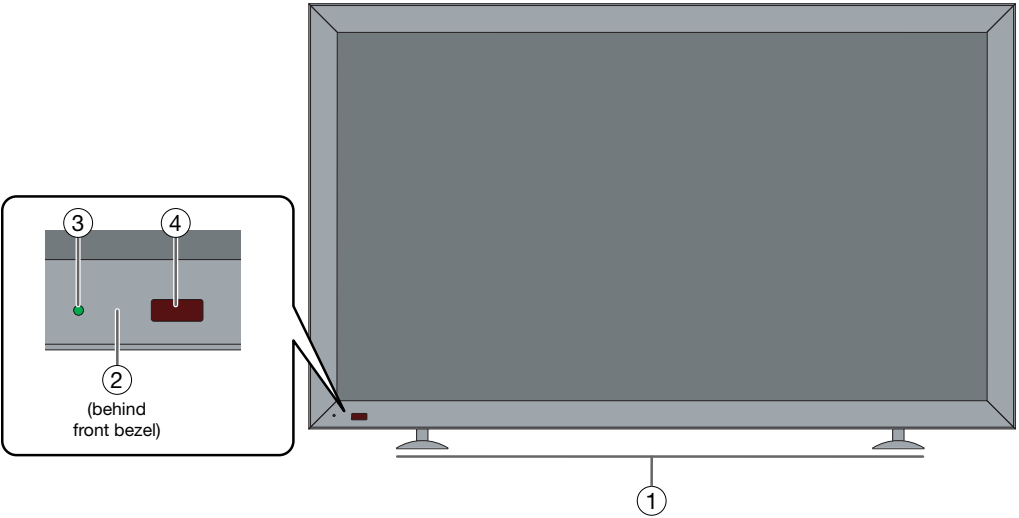

**Figure 2-2. PlasmaView VP-6500VHD Front-Panel Controls and Indicators**

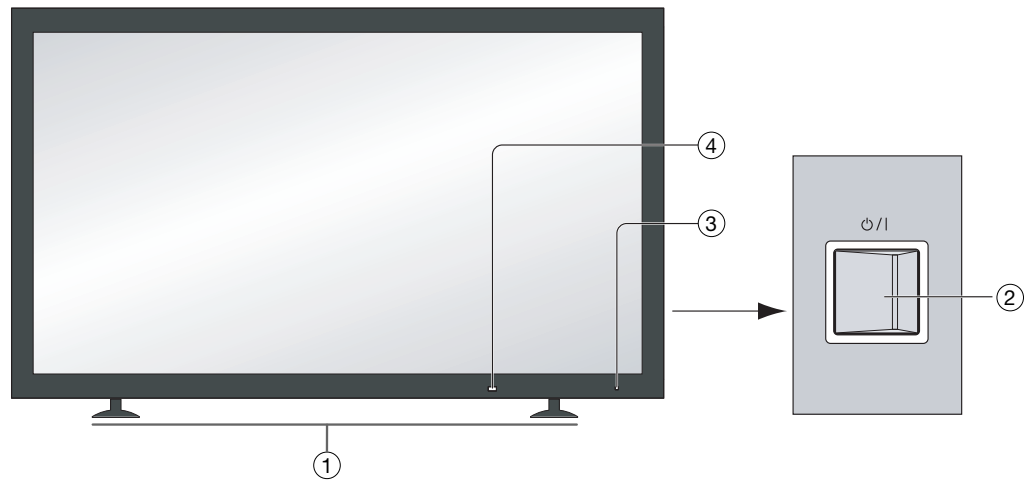
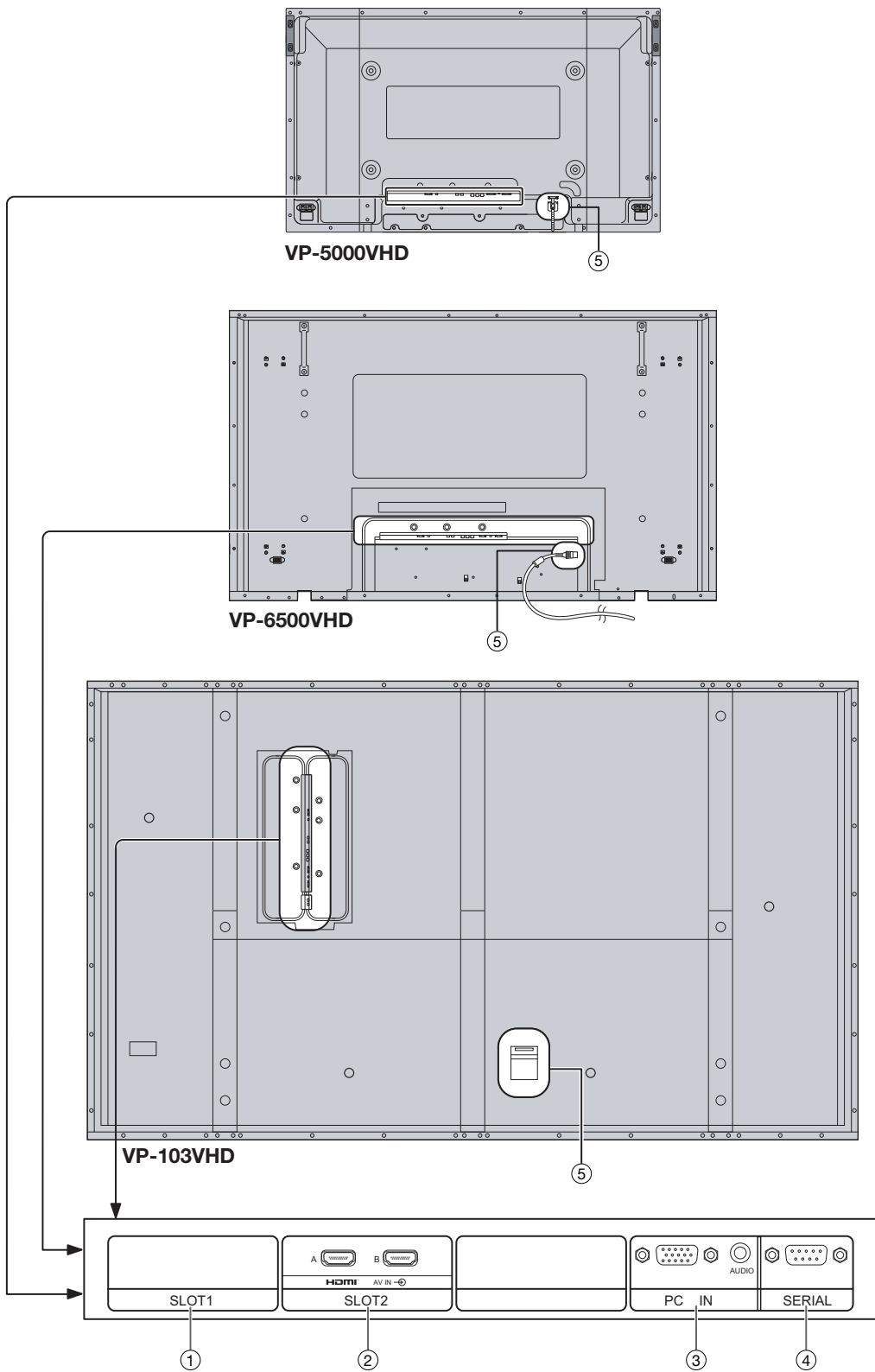

**Figure 2-3. PlasmaView VP-103VHD Front-Panel Controls and Indicators**

1. **DISPLAY STAND**  
Optional accessory for table-top installations.
2. **POWER BUTTON**  
Connects or disconnects the display panel from the AC power source.
3. **STANDBY/ON INDICATOR**
  - Lights green to indicate normal operation;
  - Lights red to indicate that the PlasmaView VHD is in standby mode.
4. **REMOTE CONTROL SENSOR**  
Receives the signals from the remote control.

Figure 2-4 shows the rear-panel connector locations on the PlasmaView VHD.

◀ **Connectors**

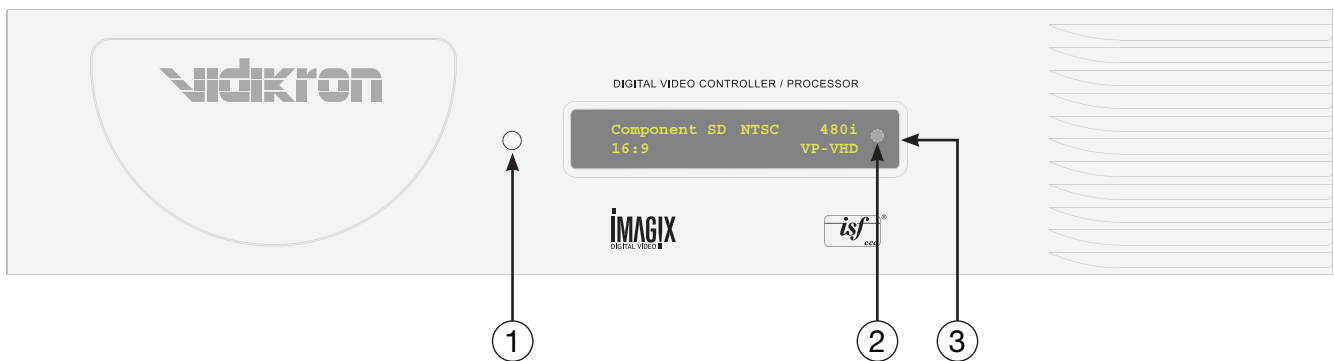

**Figure 2-4. PlasmaView VHD Rear Panel**

1. **SLOT 1**  
Not used.
2. **SLOT 2 (Dual HDMI input)**  
HDCP-compliant digital video inputs. **Connect the HDMI output from the VHD Controller to input "A" in this slot.**
3. **PC IN**  
Not used.
4. **RS-232C (9-pin, male D-Sub)**  
Connect the RS-232 OUT port on the VHD Controller to this input.
5. **POWER INPUT**  
Connect the PlasmaView VHD to AC power here.

## 2.2 VHD Controller Front Panel

Figure 2-5 shows the controls and indicators on the VHD Controller front panel; the paragraphs that follow describe them.

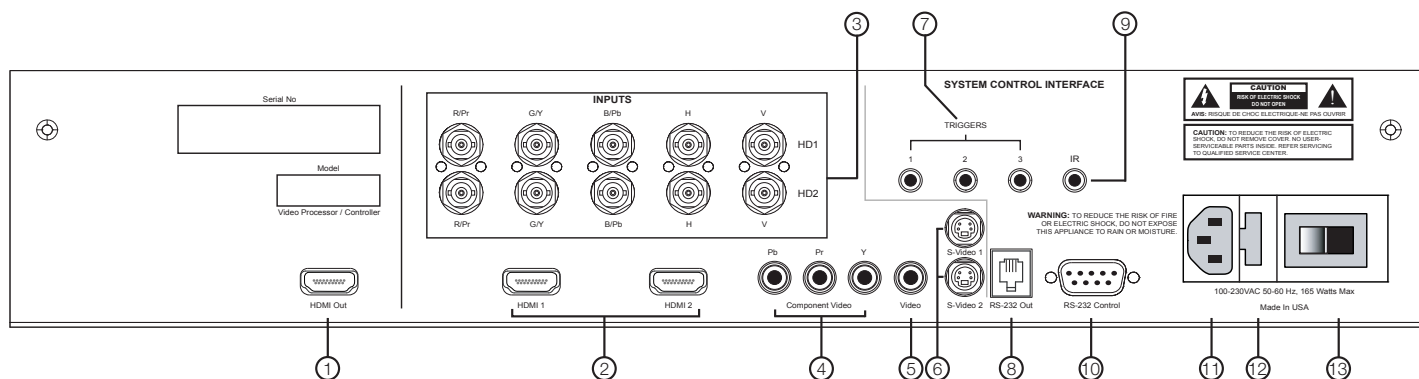

**Figure 2-5. VHD Controller Front Panel**

1. **POWER BUTTON**  
Press once to toggle from standby mode to on mode. Press it again to return to standby mode. For a discrete on or off command, you can use the direct access buttons on the remote control.
2. **IR SENSOR**  
Receives IR commands from the remote.
3. **VACUUM FLUORESCENT DISPLAY**  
Can be used instead of the On-Screen Display (OSD). Displays currently-selected menu or – if no menu is selected – the current source, signal format (NTSC or PAL), input resolution and aspect ratio.

Figure 2-6 shows the rear connector panel on the VHD Controller.

## 2.3 VHD Controller Rear Panel



**Figure 2-6. VHD Controller Rear Panel**

### 1. **HDMI OUT**

Connect this to the **SLOT 2** input on the PlasmaView VHD (see Figure 2-4).

← **Outputs**

### 2. **HDMI 1 / HDMI 2 (Digital)**

Two, HDCP-compliant digital video inputs for connecting a DVD player or HD tuner with a DVI or HDMI output.

← **Inputs**

### 3. **HD1 / HD2 (5 x Analog BNCs)**

Two inputs (five BNCs per input) for connecting either RGB or component high-definition television signals. The VHD Controller automatically detects the signal format: RGB(HV) or YPrPb, 480p, 720p, 480i, 576i or 1080i.

### 4. **COMPONENT VIDEO (RCA connectors)**

Standard Definition (480i/576i) Component (YPrPb) input. This is the input for component video from sources such as DVD players.



**Tip**

*For best results, do not run your DVD player in progressive mode.*

### 5. **COMPOSITE VIDEO INPUT**

Standard composite video input for connecting a VCR, laser disc player or other composite video source.

### 6. **S-VIDEO 1 / S-VIDEO 2**

Two, standard S-Video inputs for connecting a DVD player, satellite receiver or Super VHS (S-VHS) VCR.

### 7. **12-VOLT (750 mA) TRIGGER OUTPUTS**

Connection for up to three (3), 12-volt trigger-controlled devices such as retractable screens or screen masks.

### 8. **ComLink (RS-232) OUTPUT**

Connect this to the ComLink (RS-232) input on the projector, using the provided communication cable.

9. **IR**

Wired input from a wired remote control or infrared receiver. It is a 3.5-mm, mini phono jack, wired as follows:

Ring = +5V

Tip = IR Input

Sleeve = Ground



**Note**

*When an external remote control or infrared receiver is connected to the wired IR input, the IR sensor on the front of the VHD Controller is disabled.*

10. **RS-232 CONTROL PORT**

A female, 9-pin D-sub connector for interfacing with a PC or home theater automation/control system.

11. **POWER INPUT (100 to 240 VAC)**

Connect the VHD Controller to power here.

12. **MAIN AC FUSE**

This is the main AC input fuse (5mm x 20mm, 500 mA, 250V slow-blow).

13. **MAIN POWER SWITCH**

Disconnects or applies power to the VHD Controller.

Figure 2-7 shows the VHD Controller remote control, and the paragraphs that follow describe its functionality.

## 2.4 VHD Controller Remote Control

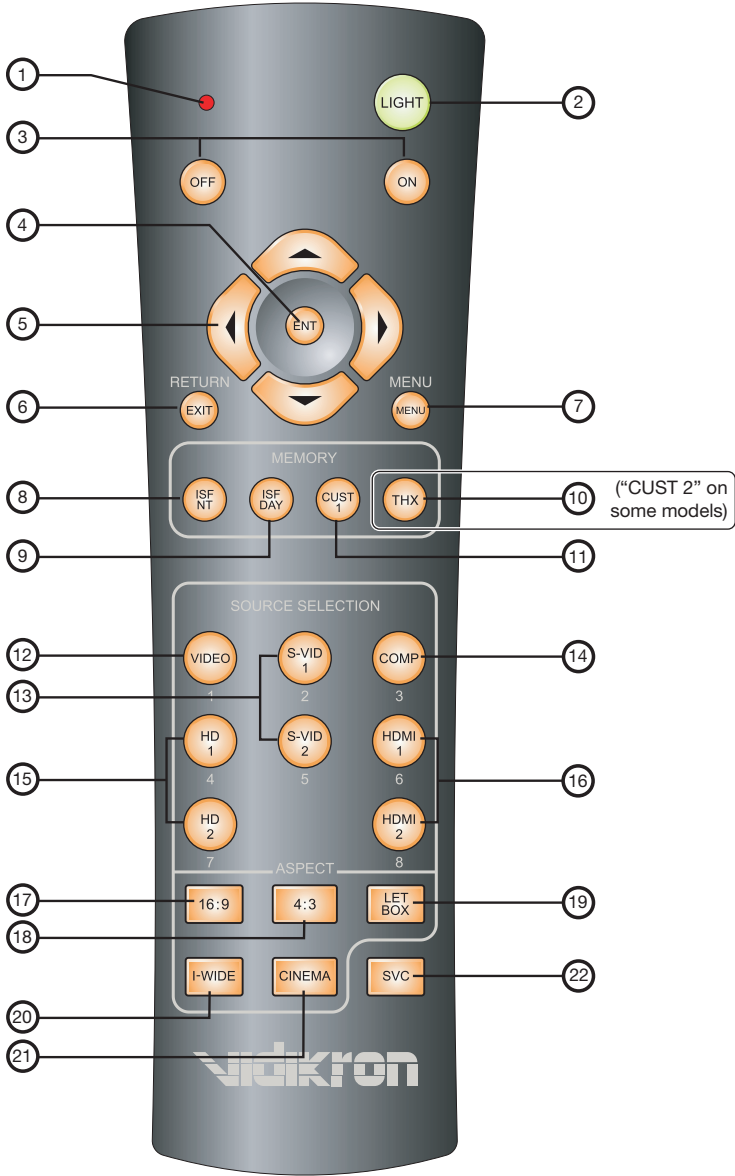

Figure 2-7. VHD Controller Remote Control

1. **IR OUTPUT INDICATOR**  
Lights when a button is pressed to indicate that an IR signal is being transmitted.
2. **LIGHT**  
Press to illuminate the buttons.
3. **ON / OFF**  
Press to turn the projector on or off.
4. **ENT (Enter)**  
Press to select a highlighted menu item or confirm a changed setting.



**Note**

*On some remote control units, this button is where the **RETURN/EXIT** button (item #6) appears here.*

5. **Cursor Buttons (▲, ◀, ▼, ▶)**  
Use these buttons to select items or settings, adjust settings or switch display patterns.

When no menu is present on-screen, the **UP** and **DOWN** buttons toggle through the available aspect ratios, in this order:

**UP** Button = 16:9 - 4:3 - Letterbox - IntelliWide - Cinema

**DOWN** Button = Cinema - IntelliWide - Letterbox - 4:3 - 16:9

Likewise, the **LEFT** and **RIGHT** buttons toggle through the different source inputs, in this order:

**LEFT** Button = HDMI 2 - HDMI 1 - HD/RGB2 - HD/RGB 1 - Component SD - S-Video 2 - S-Video 1 - Composite

**RIGHT** Button = Composite - S-Video 1 - S-Video 2 - Component SD - HD/RGB 1 - HD/RGB 2 - HDMI 1 - HDMI 2

6. **RETURN/EXIT**  
Press this button to exit the current menu and return to the previous one, or to cancel an operation.



**Note**

*On some remote control units, the **ENT (Enter)** button (item #4) is in this location.*

7. **MENU**  
Press this button to access the OSD controls.



---

**Memory Preset Buttons:**

8. **ISF NT (Night)**  
Press to recall settings for the current input from the "ISF Night" memory preset.
9. **ISF DAY**  
Press to recall settings for the current input from the "ISF Day" memory preset.
10. **THX (VP-6500VHD) / CUST 2 (all other models)**  
Press to recall settings for the current input from the "Custom 2" or "THX" memory preset.
11. **CUST 1**  
Press to recall settings for the current input from the "Custom 1" memory preset.
12. **VIDEO (1)**  
Press to select Composite video input as the source or to enter the numeric character "1."
13. **S-VID 1 (2) / S-VID 2 (5) (S-Video)**  
Press to select an S-Video input or to enter the numeric character "2" or "5."
14. **COMP (Component) (3)**  
Press to select Component SD (480i/576i) video input as the source or to enter the numeric character "3."
15. **HD 1 (4) / HD 2 (7)**  
Press to select a HD (RGBHV or YPbPr component) input or to enter the numeric character "4" or "7."
16. **HDMI 1 (6) / HDMI 2 (8)**  
Press to select a Digital Video input or to enter the numeric character "6" or "8."

**Aspect Ratio Selection Buttons:**

Use these buttons to select an aspect ratio directly or to enter numeric characters, as follows:

17. **16:9 (9)**  
For viewing 16:9 DVDs or HDTV programs in their native aspect ratio.
18. **4:3 (0)**  
Scales the input signal to fit 4:3 display mode in the center of the screen.
19. **LETBOX (Letterbox)**  
For viewing LaserDisc movies or non-anamorphic DVDs on a 16:9 screen.
20. **I-WIDE (IntelliWide)**  
Enlarges a 4:3 image horizontally in a NON-linear fashion to fit 16:9 full screen display.
21. **CINEMA**  
For viewing 2.35:1 source material.
22. **SVC**  
Not used.

**Notes:**

# Installation

To install batteries in the remote control:

1. Press down the tab on the cover and pull the cover in the direction of the arrow.
2. Insert the included batteries. Ensure that the polarities correctly match the  $\oplus$  and  $\ominus$  markings inside the battery compartment.
3. Insert the lower tab of the cover into the opening, and press down the cover until it clicks in place.

- When installing batteries, make sure that the battery polarities are correct.
- Do not mix an old battery with a new one or different types of batteries.
- If you will not use the remote control for a long time, remove the batteries to avoid damage from battery leakage.

The remote control can be used to control the PlasmaView VHD within the ranges shown in Figure 3-1.

## 3.1 Remote Control

### ◀ Notes on Batteries

### ◀ Notes on Remote Control Operation



**Figure 3-1. Available Range of the Remote Control**

- Do not drop the remote control or expose it to moisture or high temperature.
- The remote control may malfunction under a fluorescent lamp. If that occurs, move the plasma display away from the fluorescent lamp.
- Make sure that there is nothing obstructing the infrared beam between the remote control and the IR receiver on the plasma display.



**Note**

*The signal from the remote control can be reflected by walls or other surfaces.*

- If the effective range of the remote control decreases, or it stops working, replace the batteries with new ones.
- Ambient conditions may possibly impede the operation of the remote control. If this happens, point the remote control at the plasma display and repeat the operation.

Table 3-1 gives a quick overview of the PlasmaView VHD installation process. The sections following this one provide detailed instructions.

## 3.2 Quick Setup



### Note

*Installation should be performed by a qualified custom video installation specialist.*

**Table 3-1. Installation Overview**

Step	Procedure	For Details, refer to page...
1	Mount the PlasmaView VHD on a wall or table stand	18
2	Connect the VHD Controller to the PlasmaView VHD	22
3	Connect signal sources to the VHD Controller	24
4	Connect external controller to VHD Controller RS-232 port (optional)	28
5	Apply power to the PlasmaView VHD	33
6	If using the PlasmaView VHD with a computer, adjust computer display properties	33
7	Display calibration: adjust the following for <b>analog</b> inputs; save settings when finished: <ul style="list-style-type: none"> <li>• Aspect ratio</li> <li>• Brightness</li> <li>• Contrast</li> <li>• Color level</li> <li>• Tint</li> <li>• Sharpness</li> <li>• White Balance</li> </ul>	37
8	Repeat Step 7 for <b>digital</b> inputs	47

### 3.3 Installation Considerations

Proper installation of your PlasmaView VHD will ensure the highest possible picture quality, protect your investment and prevent personal injury. Whether you are installing the PlasmaView VHD temporarily or permanently, you should take the following into account to ensure that it performs optimally.

#### **Special Requirements for the VP-103VHD** ➤

The extremely large size and high power consumption of the VP-103VHD place unique demands upon both the installation personnel and the installation site, over and above those of the 50-inch and 65-inch PlasmaView VHD models.

Installing the VP-103VHD requires the following:

- **Several** people familiar with complex mechanical installations.
- Specialized equipment.
- A dedicated 220VAC circuit.
- A “carry-in” path with sufficient clearances.
- An installation location that can support the weight of both the plasma panel and mounting hardware (floor pedestal or wall mount).

Before proceeding with a VP-103VHD installation, make sure you understand these requirements and have confirmed that the site can meet them.

#### **High-Altitude Operation** ➤

Due to inherent limitations of plasma technology, and the interaction between ambient air pressure and the plasma gases contained inside of the panel, reliable operation of your plasma display cannot be assured during operation at certain high-altitude locations.

Vidikron has found the VP-5000VHD and VP-6500VHD to operate reliably at altitudes of up to 7,800 feet MSL (mean sea level). The VP-5000VHDa and VP-6500VHDa have been found to operate reliably at altitudes of up to 9,100 feet MSL.

At higher elevations, each panel may react differently, depending upon the altitude, air pressure, humidity and other meteorological factors. If you are planning to use this product at a location above 9,000 feet, please contact Vidikron technical support for further information.

#### **Mounting the PlasmaView VHD on a Wall or Table Stand/Floor Pedestal** ➤

To install the PlasmaView VHD, you will need either an optional table stand, floor pedestal or wall-mounting kit. (The VP-103VHD must be either wall-mounted or attached to a floor pedestal.)

If you do decide to wall-mount the PlasmaView VHD, ensure that the wall-mount bracket is installed according to the instructions included with it. The wall must be capable of supporting a redundant weight factor five (5) times the weight of the display, or be reinforced.

Vidikron recommends that this be done by a custom installation specialist.



#### **Note**

*Use only a Vidikron-approved wall-mount kit, table stand or floor pedestal that is specifically designed for your display. Refer to **Parts List** on page 4 for ordering information.*

---

You can attach your optional mounts or stand to the PlasmaView VHD in either of two ways:

- While it is upright.

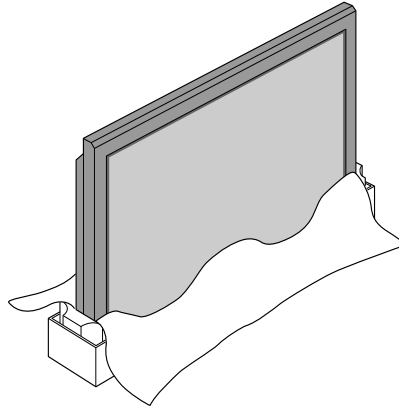

- As it lies flat with the screen face down. Place the protective sheet, which was wrapped around the plasma monitor when it was packaged, between the screen and your work surface to avoid scratching or otherwise damaging the screen surface.

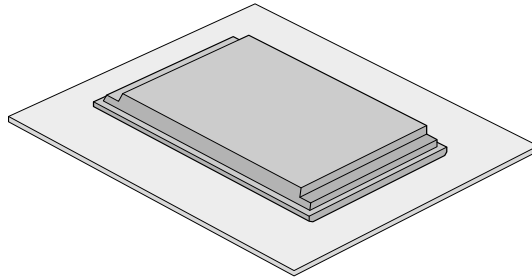

In general, minimize or eliminate light sources directed at the display. Contrast ratio in your images will be noticeably reduced if light directly strikes the display, such as when a shaft of light from a window or floodlight falls on the image. Images may then appear washed out and less vibrant.

◀ **Ambient Light**

If you are mounting the PlasmaView VHD in an enclosure, leave sufficient space on all sides between it and surrounding objects, as shown in Figure 3-2 or Figure 3-3. This allows heat to disperse, maintaining the proper operating temperature.

◀ **Ventilation**

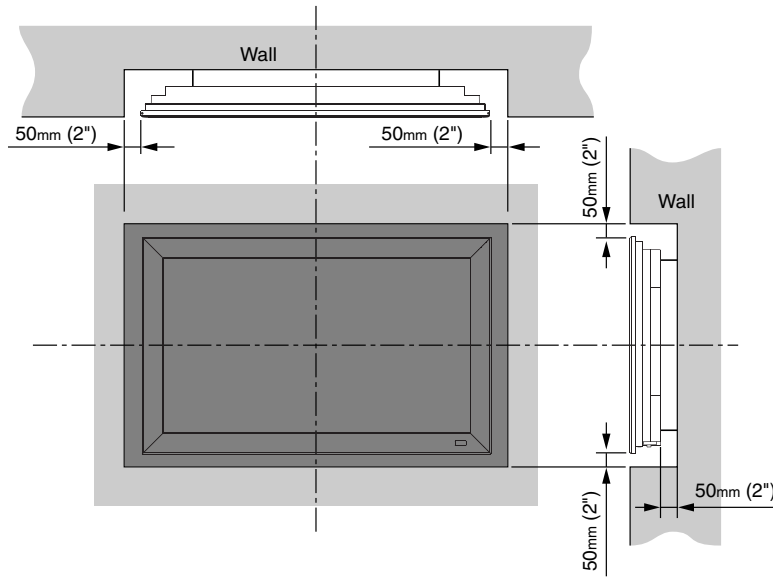

**Figure 3-2. Ventilation Requirements for Enclosure Mounting (VP-5000VHD and VP-6500VHD)**

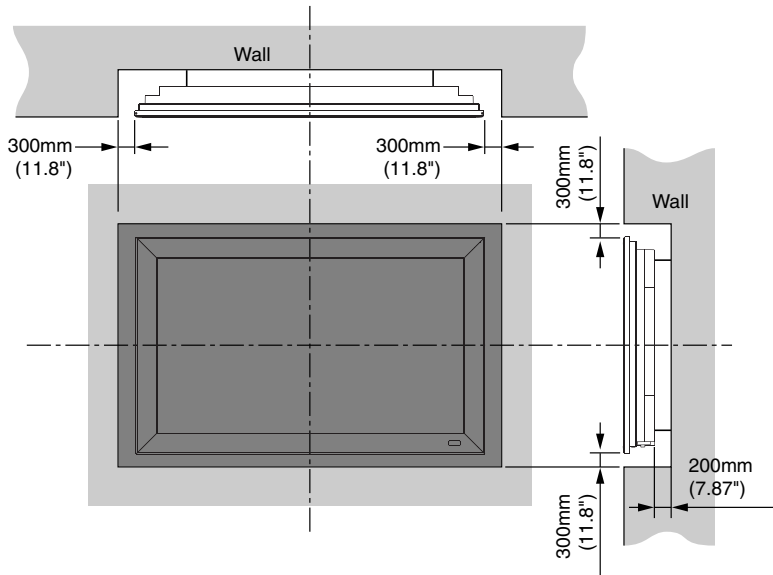

**Figure 3-3. Ventilation Requirements for Enclosure Mounting (VP-103VHD)**



---

Other considerations and tips that can help improve your installation, avoid damage and prolong operating life:

- Keep the ambient temperature constant and below 35°C (95°F). Keep the display away from heating and/or air conditioning vents. Changes in temperature may cause drifts in the display circuitry, which may affect performance.
- Keep the PlasmaView VHD away from devices that radiate electromagnetic energy such as motors and transformers. Common sources of these include slide projectors, speakers, power amplifiers and elevators.
- Handle the unit carefully when installing or carrying it. Use the built-in handles; DO NOT touch or hold the screen face.
- Set the unit away from heat, excessive dust, and direct sunlight.
- Protect the inside of the unit from liquids and small metal objects. In case of accident, unplug the power cord and have it serviced by an authorized Service Center.
- Do not hit or scratch the panel surface as this causes flaws on the surface of the screen.
- For correct installation and mounting it is strongly recommended to use a trained, authorized dealer.
- To avoid sulfurization, it is strongly recommended not to place the unit in a dressing room in a public bath or hot spring bath.

◀ **Other Considerations**

### 3.4 Connections to the PlasmaView VHD and VHD Controller

Proceed as follows to connect the PlasmaView VHD to the VHD Controller, your video sources, external controller(s) – if present – and AC power.

When connecting your equipment:

- Turn off all equipment before making any connections.
- Use the correct signal cables for each source.
- Ensure that the cables are securely connected. Tighten the thumbscrews on connectors that have them.

#### Connecting the PlasmaView VHD to the VHD Controller

Connect the VHD Controller to the PlasmaView VHD as shown in Figure 3-4 and described in the sections that follow.

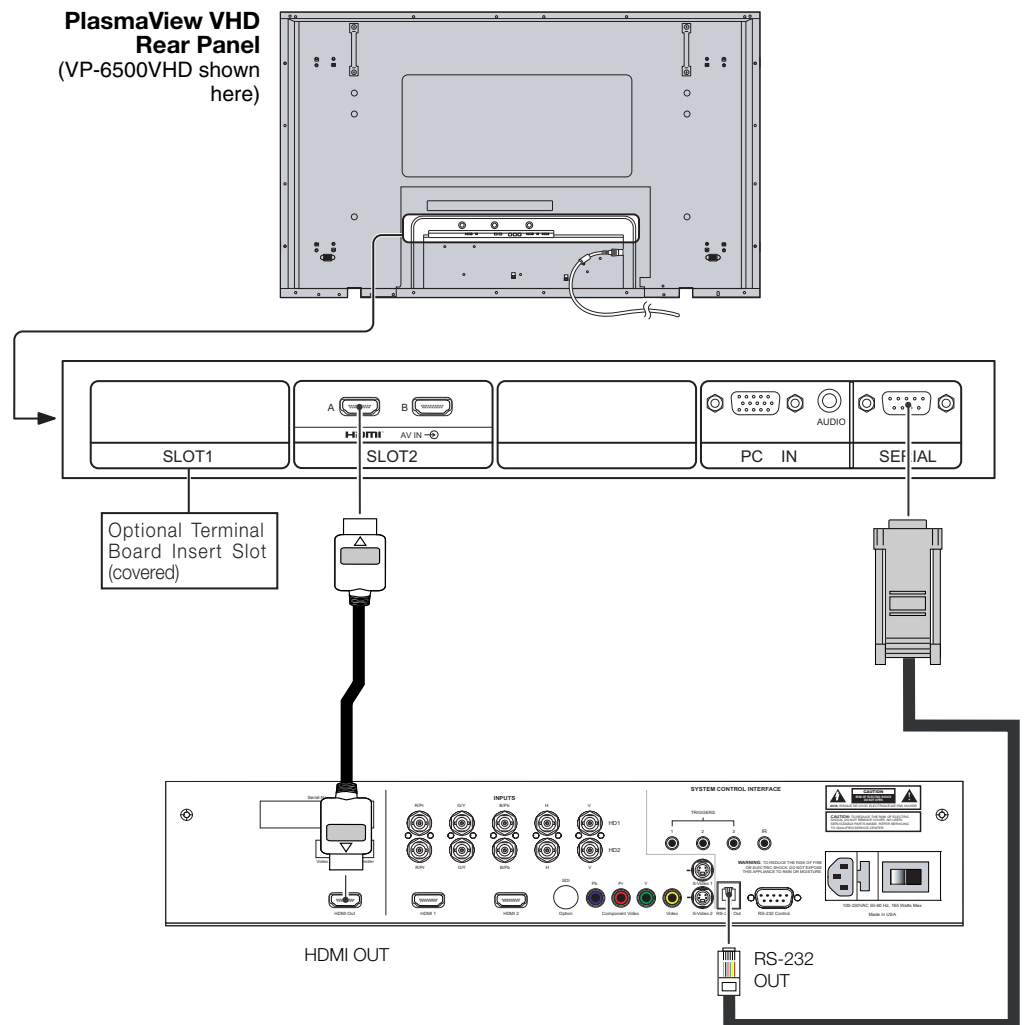

**Figure 3-4. Connecting the PlasmaView VHD to the VHD Controller**

**Digital Video Connection:** The PlasmaView VHD has a dual HDMI input board, labeled **HDMI (SLOT 2)**. Connect the HDMI output from the VHD Controller to input “A” on this board, using an HDMI-to-HDMI cable.

**RS-232 Connection:** Connect the RS-232 output from the VHD Controller to the **SERIAL** input on the PlasmaView VHD. Use a standard, modular telephone cable with RJ11 plugs at both ends. On the PlasmaView VHD end, use the provided RJ11-to-DB9 adapter. This adapter is wired as shown in Figure 3-5.

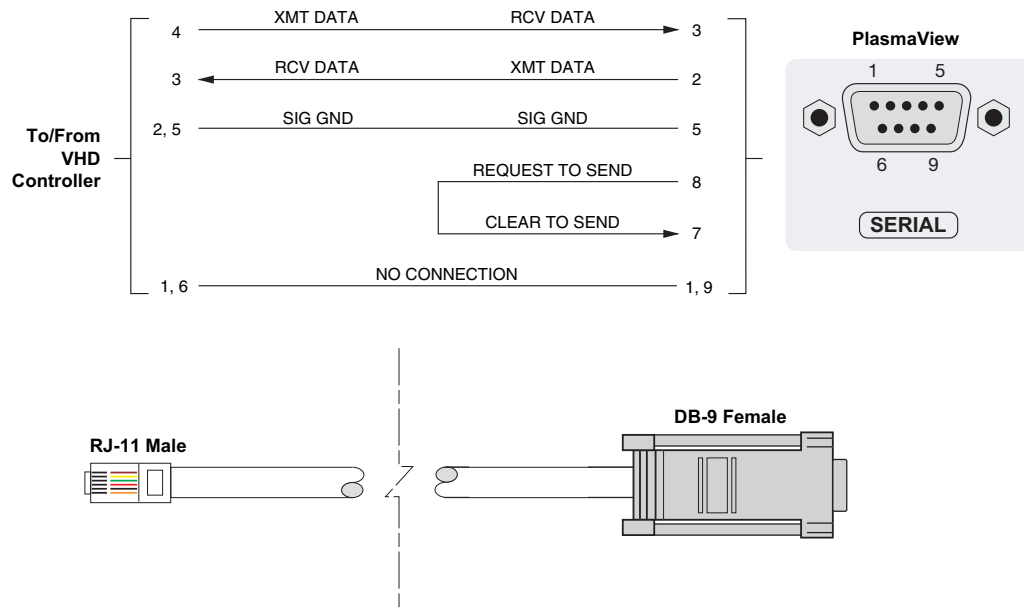

Figure 3-5. RS-232 Connection from the VHD Controller to the PlasmaView VHD

**Connecting Source Components to the VHD Controller**

Connect your video sources to the VHD Controller as shown and described in the sections that follow.

**HDMI Connections:** See Figure 3-6.



**Tip**

Use the HDMI inputs whenever possible. This ensures the highest video quality because the signal is carried in the digital domain throughout the entire signal path, from source component output into the projector.

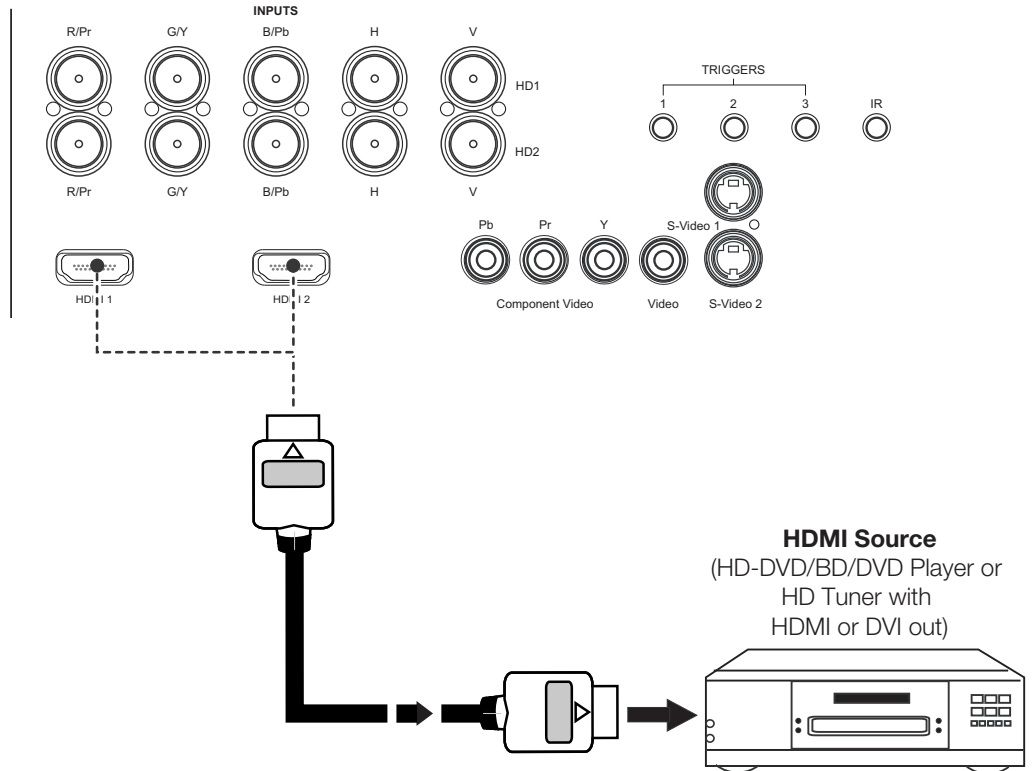

**Figure 3-6. HDMI Source Connections**

**Digital (DTV) RGB Connections:** See Figure 3-7.

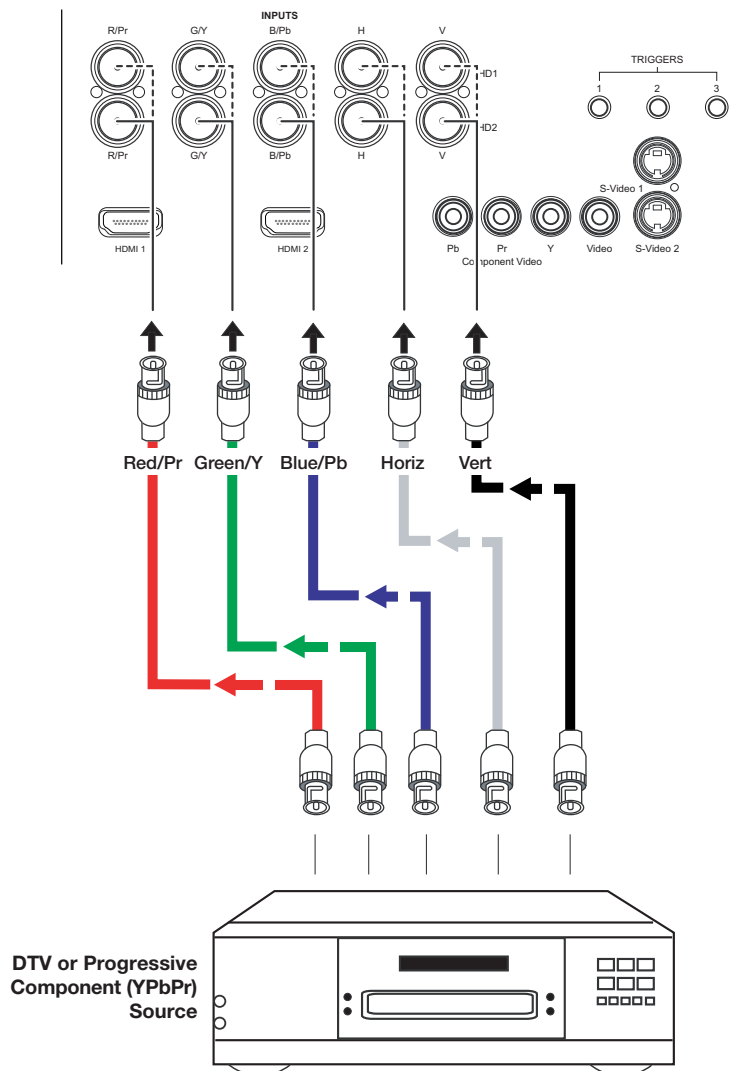

**Figure 3-7. Digital (DTV) RGB Connections**

**Analog (Computer) RGB Connections:** See Figure 3-8.



**Note**

1. Refer to **PlasmaView VHD Specifications** on page 61 for a list of computer signals compatible with the PlasmaView VHD. Use with signals other than those listed may cause some functions not to work.
2. Some Macintosh computers may require a Macintosh video adapter. Contact your nearest authorized service center or dealer.

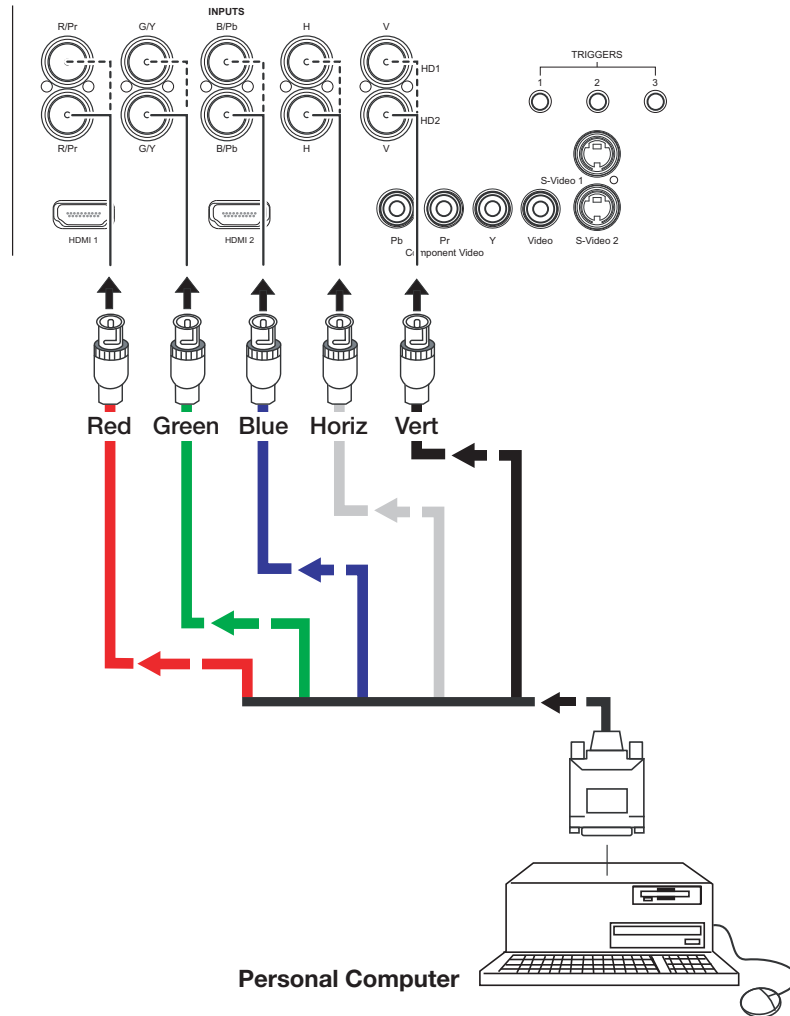

**Figure 3-8. Analog RGB Connections**

**Composite/S-Video/Component Video Connections:** See Figure 3-9.

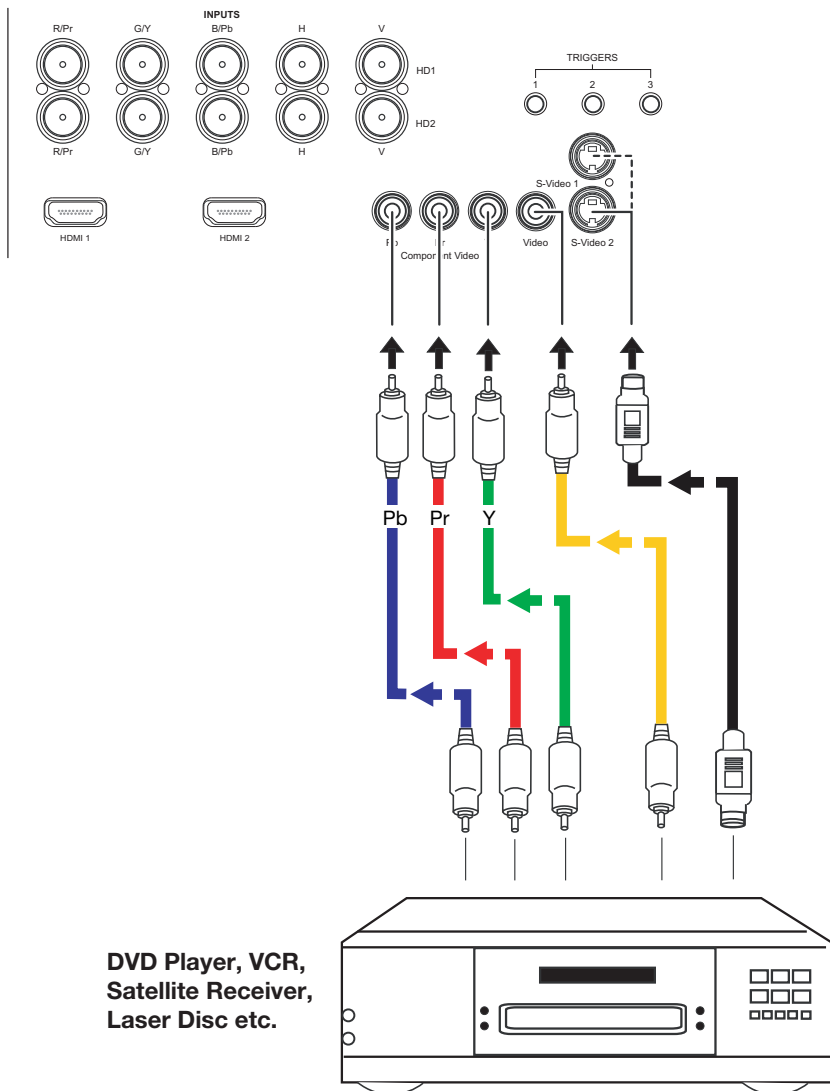
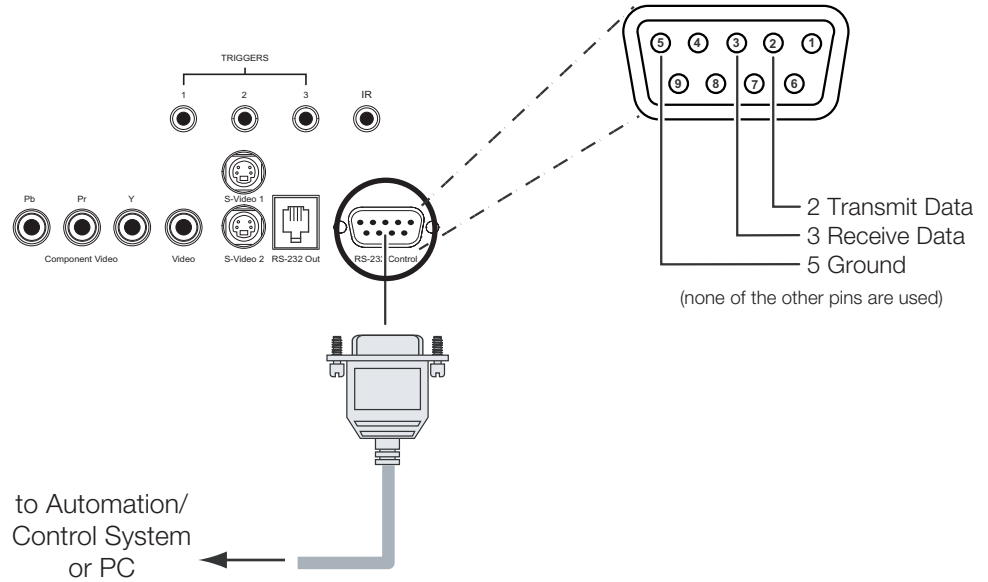

**Figure 3-9. Composite, S-Video and Component Video Connections**

**RS-232 Controller Connection**

Use a standard, 9-pin RS-232 cable to connect a PC or home theater control/automation system (if present) to the RS-232 Control port on the VHD Controller; see Figure 3-10.

For more information about using this connection, refer to **Serial Communications** on page 55.



**Figure 3-10. RS-232 Control System Connection**

**Connecting 12-Volt Trigger Outputs to External Equipment**

If your home theater contains equipment that responds to 12-Volt triggers, connect it to the 12-Volt trigger outputs as shown in Figure 3-11.

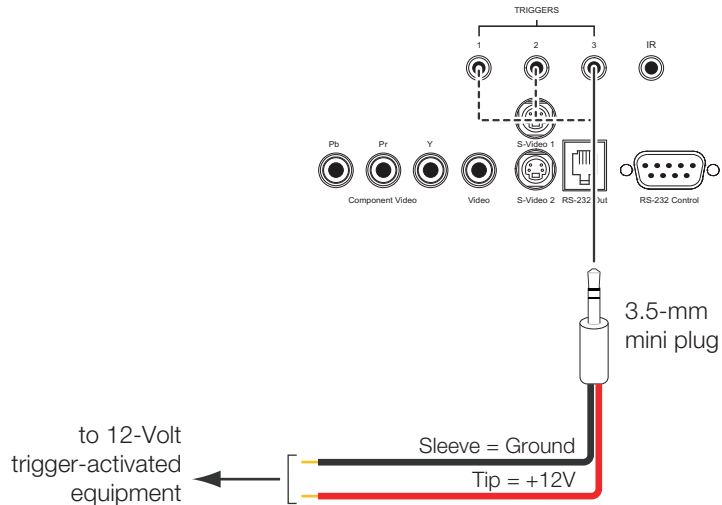
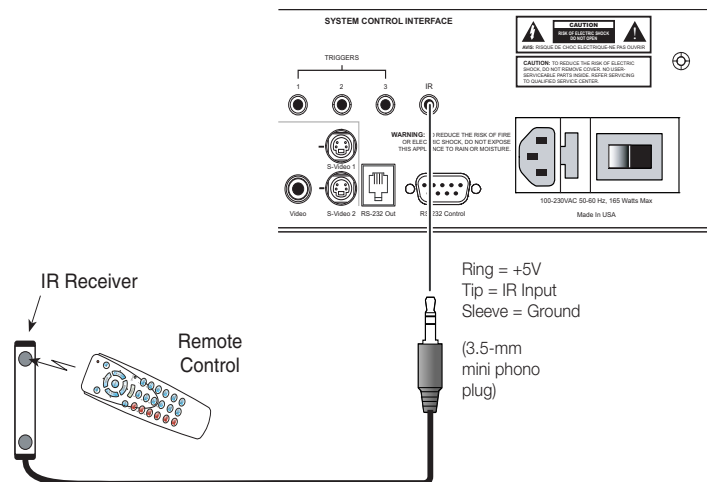

**Figure 3-11. Connecting 12-Volt Trigger Outputs**



If infrared signals from the remote control cannot reach the VHD Controller due to excessive distance or obstructions such as walls or cabinet doors, you can connect an external IR receiver to the VHD Controller to extend the range of the remote control. See Figure 3-12.

◀ **Connecting an External IR Receiver to the VHD Controller**



**Figure 3-12. External IR Receiver Connection**



**Note**

*When an external IR receiver is connected to the wired IR input, the built-in IR sensor on the VHD Controller is disabled.*

**Connecting AC Power** ➤ Plug the female end of the power cord into the AC receptacle on the rear of the PlasmaView VHD. Connect the other end to your AC power source. (The VP-103VHD requires 200 – 240 VAC.)

VP-5000VHD

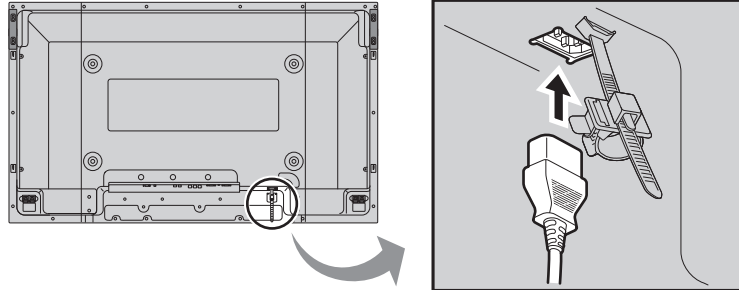

VP-6500VHD

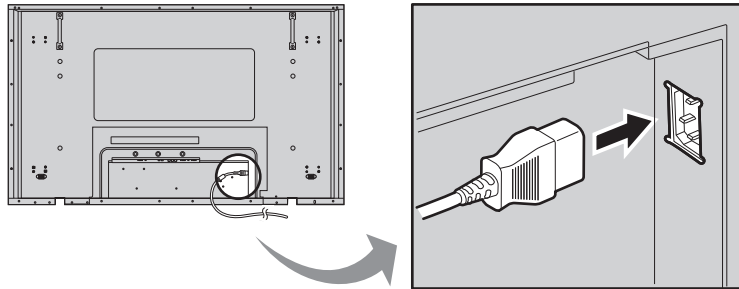

VP-103VHD (NOTE: The VP-103VHD requires 200 - 240 VAC)

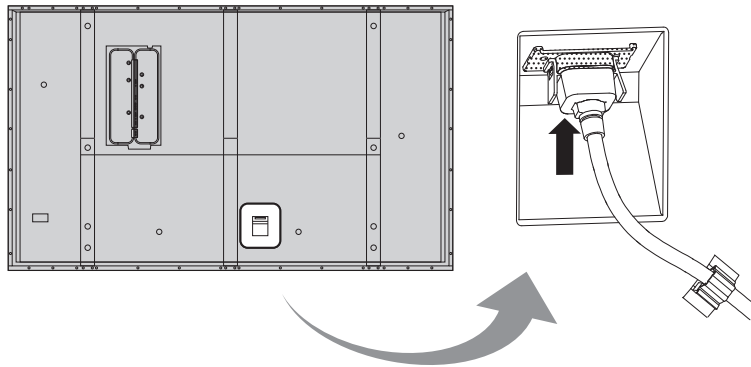

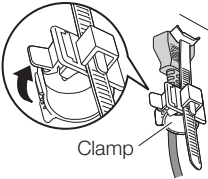
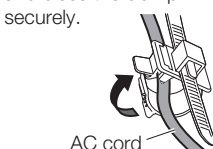
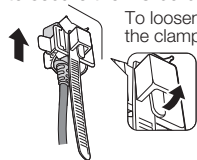

**Figure 3-13. AC Power Connection**

Similarly connect the VHD Controller to a nearby AC outlet.



To reduce cable clutter, use the cable clamps provided with the PlasmaView VHD to bundle the video, audio and control cables at the back of the display. Install the clamps as shown in Figure 3-14.

◀ **Cable Management**

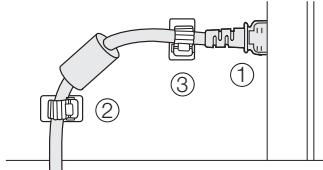

**Securing the AC cord to the rear of the panel (VP-5000VHD)**

<p><b>1.</b> Open the clamp.</p>  <p>Clamp</p>	<p><b>2.</b> Insert the AC cord and close the clamp securely.</p>  <p>AC cord</p>	<p><b>3.</b> Slide the clamp upward to secure the AC cord.</p> <p>To loosen the clamp:</p> 	<p><b>4.</b> Insert the end of the clamp band into the small hole on the lower right of the back cover.</p> 
<p><b>Note:</b> The power plug provided with your panel may differ from the one shown here.</p>			

**Securing the AC cord to the rear of the panel (VP-6500VHD)**

	<p>① Connect the AC cord plug to the panel. ② Attach the left clamp. ③ Attach the right clamp.</p>	<p><b>To close:</b></p>  <p>Push until the hook clicks.</p> <hr/> <p><b>To open:</b></p>  <p>Squeeze the tabs together and pull out.</p>
<p><b>Note:</b> The power plug provided with your panel may differ from the one shown here.</p>		

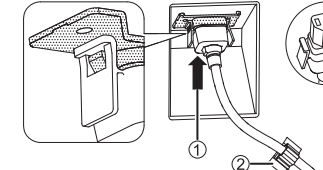
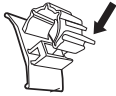
**Securing the AC cord to the rear of the panel (VP-103VHD)**

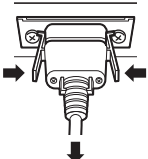
 <p>① Plug the AC cord into the power inlet on the panel until it clicks. ② Attach the clamp.</p> <p><b>Note:</b> Make sure that the AC cord is locked.</p>	<p><b>To close:</b></p>  <p>Push until the hook clicks.</p> <hr/> <p><b>To open:</b></p>  <p>Squeeze the tabs together and pull out.</p>	<p><b>Unplug the AC cord</b></p>  <p>Press the two tabs together and pull out.</p>
--	--	--

**Using Cable Ties**

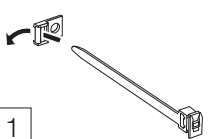
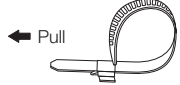
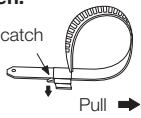
<p>Pass the cable fixing band through the clip as shown.</p>  <p>1</p>	<p>To secure cables connected to the panel, wrap the cable tie around them. Then, pass the pointed end through the locking block as shown. Ensure that there is sufficient slack in the cables to minimize stress, especially in the power cord.</p>	<p><b>To tighten:</b></p>  <p>← Pull</p>	<p><b>To loosen:</b></p>  <p>Push the catch Pull →</p>
---	--	---	--

**Figure 3-14. Cable Management**

**Notes:**

1. Turn on your source components.
2. Press the main power switch at the front of the PlasmaView VHD (see Figure 2-1). The standby/on indicator lights green.
3. Set the main power switch at the rear of the VHD Controller (see Figure 2-6) to the “on” position.
4. Press the **ON** button on the remote control to turn on the VHD Controller and PlasmaView VHD (or press the power button on the front of the VHD Controller). The power indicator on the VHD Controller lights solid blue.
5. After a brief warm-up period (approximately 10 seconds), the PlasmaView VHD will display an image.

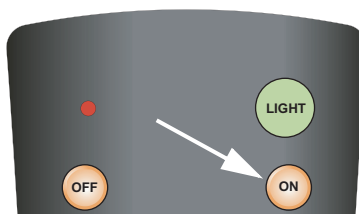

## 4.1 Turning on the Power

To maximize image quality when using the PlasmaView VHD with a personal computer, you may need to adjust the display properties of your computer's video card. To do this on a Microsoft® Windows®-based PC:

1. Choose Settings from the Windows Start Menu and click on “Control Panel.”

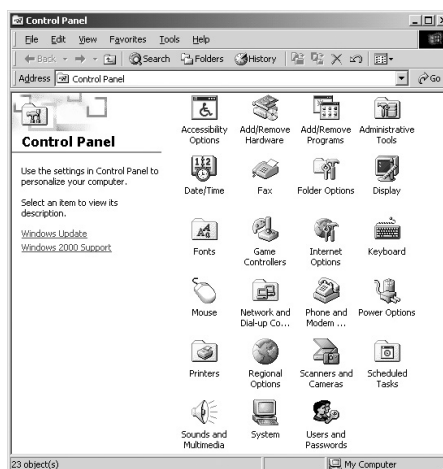

## 4.2 Setting the Computer Display Properties

2. Double click on the **Display** icon.
3. Click the **Settings** tab on the display dialog box.
4. Set the **Screen area** to 1024x768 pixels.

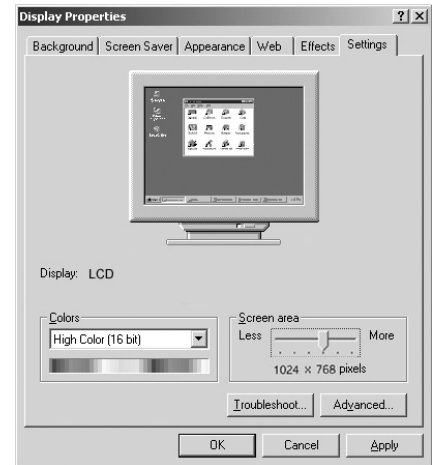

5. Click the **Advanced** button and click the **Monitor** tab on the dialog box. Set the **Refresh Frequency** to 60Hz and click **OK**.

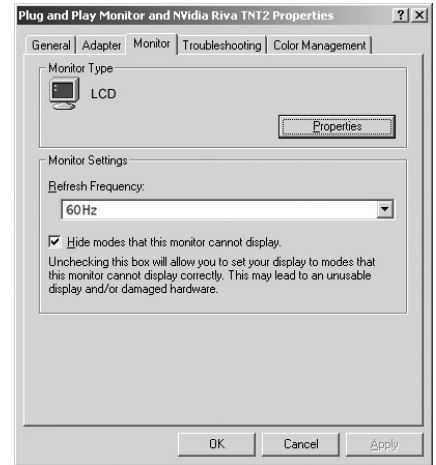

**Note**

1. The native resolution of the PlasmaView VHD is 1920 x 1080. Other horizontal or vertical resolutions may be scaled upward or downward to fit the display.
2. With most computers, you can get the best picture at 1024 x 768 @ 60Hz.



**WARNING**

To prevent image retention (burn) on your display, **ALWAYS** use a screen saver and set it to the shortest possible time.

Press the **MENU** button on either the remote control or the VHD Controller front panel to display the Main Menu. To select a menu item, use the UP ( ▲ ) and DOWN ( ▼ ) buttons on either the remote control or the VHD Controller front panel to highlight it. Press **ENTER** to confirm your selection.

The PlasmaView VHD OSD menus are arranged hierarchically, as shown in Figure 4-1. Depending on the selected input source and signal characteristics, some menu options may not be available.

### 4.3 Using the VHD Controller Menus



#### Note

*When the input signal resolution is 1080i **analog** (via the HD1 or HD2 input) or lower, the menus appear both on-screen and on the front-panel display of the VHD Controller as you navigate them:*

Input Source	↑
Aspect Ratio	↓

*When the input signal resolution is 1080i **digital** or 1080p (via the HDMI1 or HDMI2 input), the menus appear on the front-panel display only.*

<b>Input Source</b>	Composite
	S Video 1
	S Video 2
	Component SD
	HD/RGB 1
	HD/RGB 2
	HDMI 1
HDMI 2	
<b>Aspect Ratio</b>	16:9
	4:3
	Letterbox
	IntelliWide
	Cinema
<b>Picture</b>	Brightness
	Contrast
	Color
	Tint
	Sharpness
<b>Input Position</b>	Left/Right
	Up/Down
	Width
	Height
	Overscan
<b>Memory Presets</b>	Recall ISF Night
	Recall ISF Day
	Recall or Save Custom 1
	Recall or Save THX/Custom 2
	Reset Custom 1 and THX/Custom 2 to Factory Default
<b>Information</b> (read-only)	Serial Number
	Hardware
	Firmware
	Date

<b>Calibration</b> (1080i analog and lower-resolution sources)	ISF Night - Display Color	Gain
		Offset
		Gamma
		Color Temp.
		AGC
	ISF Night - Input Image	Input Level
		Brightness
		Contrast
		Color
	ISF Night - Input Color	Tint
		Sharpness
		Gain
		Offset
	ISF Day - Display Color	Chroma Delay
		Phase
		Noise Filter
		Gain
	ISF Day - Input Image	Offset
		Gamma
		Color Temp.
AGC		
ISF Day - Input Color	Input Level	
	Brightness	
	Contrast	
	Color	
ISF Day - Input Color	Tint	
	Sharpness	
	Gain	
	Offset	
Save ISF Settings	Chroma Delay	
	Phase	
	Noise Filter	
	Back / Confirm	
Output Shift	Left/Right	
	Up/Down	
	Width	
	Height	
Splash Configure	Save	
	Owner Name	
	ISF Calibrated	
	ISF Other	
OSD Position	Vidikron/ISF Logo Splash Screen Timers (2 ... 60 sec.)	
	Vert./Horiz., Normal/Wide, Height	

<b>Service</b>	Test Video	Grey Bars 1	
		Grey Bars 2	
		Color Bars 1	
		Color Bars 2	
	Input Names	Rename, Restore or Save	
	Remote Control	Primary	
		Secondary	
	Display Device	Display Position	Left/Right, Up/Down, Width, Height
			Pix By Pix (Enable/Disable; 1080i/p sources only)
		Display Image (1080i digital or 1080p sources only)	Brightness, Contrast, Color, Tint
			Sharpness, Color Temp.
			AGC, Input Level
			Red Gain, Blue Gain, Green Gain
			Red Offset, Blue Offset, Green Offset
Gamma			
HD Format	HD/RGB 1	Auto, RGB or YUV	
	HD/RGB 2		
	ADC Bandwidth	Auto, 75 MHz, 150 MHz or 300 MHz	
	YPbPr Input Resolution	Auto, 480i/p, 576i/p, 720p or 1080i	
Triggers	1 / 2 / 3 / Save		
Miscellaneous	Language	(currently, English only)	
	Menu Mode		
	Timeout		
	Side Bar Color		
System Reset	Film Mode (SD src. only)		
	Restore Saved Settings		

Figure 4-1. VHD Controller OSD Menu Structure for PlasmaView VHD



The Main Menu is the starting point for accessing all display functions.

(The Calibration and Service menus are hidden and not accessible until you enter a passcode.)

◀ **Main Menu**

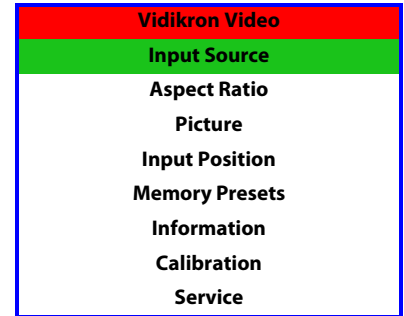

From the Main Menu, select Input Source to choose a video signal source.

The active source is indicated by an arrow (>) to its left; in this example, Composite is the active source.

◀ **Input Source**

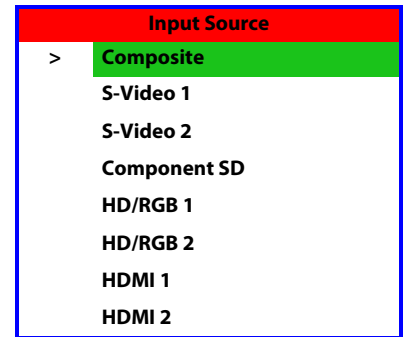

To change the aspect ratio (size and shape) of the projected image, select Aspect Ratio from the Main Menu and press **ENTER**. Select the appropriate aspect ratio for your screen size and the type of program material being viewed; refer to Table 4-1.

The currently-selected aspect ratio is indicated by a "☒" to its left; in this example, 16:9 is selected.

◀ **Aspect Ratio**

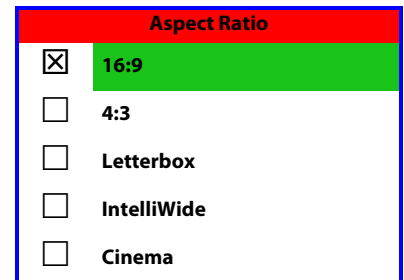

**Note**

*The aspect ratio selection is automatically saved for each input and resolution.*

**Table 4-1. Aspect Ratio Settings**

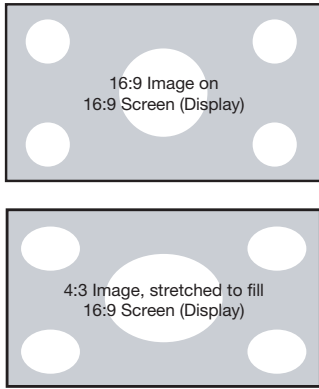
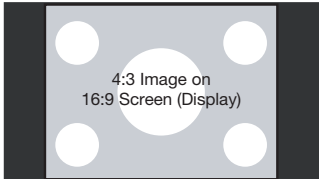
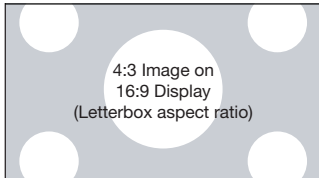
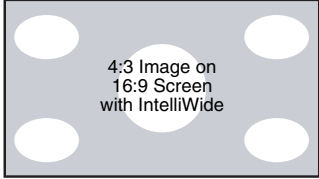
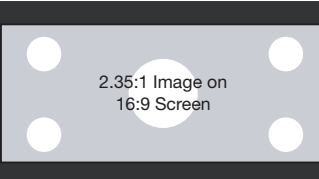
Aspect Ratio	Remote Control Key	Description	
16:9	16:9	 <p>16:9 Image on 16:9 Screen (Display)</p> <p>4:3 Image, stretched to fill 16:9 Screen (Display)</p>	<p>Select 16:9 to view 16:9 DVDs and HDTV programs in their native aspect ratio.</p> <p>4:3 images are stretched horizontally to fit a 16:9 screen.</p>
4:3	4:3	 <p>4:3 Image on 16:9 Screen (Display)</p>	<p>4:3 scales the input signal to fit in the center of the 16:9 screen. 4:3 is the aspect ratio used by computer monitors, standard television programming and most VHS video cassettes.</p>
Letterbox	LET BOX	 <p>4:3 Image on 16:9 Display (Letterbox aspect ratio)</p>	<p>Letterbox mode scales (zooms in on) a 4:3 image linearly (by the same amount on all sides) to fill a 16:9 display. Letterbox is best suited for viewing LaserDisc movies or non-anamorphic DVDs on a 16:9 screen.</p>
IntelliWide	I-WIDE	 <p>4:3 Image on 16:9 Screen with IntelliWide</p>	<p>IntelliWide scales a 4:3 image NON-linearly (more on the sides than in the center) to fit a 16:9 screen.</p>
Cinema	CINEMA	 <p>2.35:1 Image on 16:9 Screen</p>	<p>Select Cinema to view 2.35:1 source material on a 16:9 screen. The upper and lower portions of the screen are masked, but the geometry of the active image area is not changed.</p>

Use the controls in the Picture Menu to calibrate the **analog** inputs on the PlasmaView VHD for optimum picture quality.

◀ **Picture**

<b>Picture</b>
<b>Brightness</b>
<b>Contrast</b>
<b>Color</b>
<b>Tint</b>
<b>Sharpness</b>



**Note**

To calibrate the digital (HDMI 1 and HDMI 2) inputs, use the Display Image controls in the Service menu. For more information, refer to **Display Device** on page 47.

The PlasmaView VHD has been designed to incorporate setup and calibration standards established by the Imaging Science Foundation (ISF). The ISF has developed carefully crafted, industry-recognized standards for optimal video performance and has implemented a training program for technicians and installers to use these standards to obtain optimal picture quality from Vidikron video display devices. Accordingly, Vidikron recommends that setup and calibration be performed by an ISF-certified installation technician.

All signal types require separate processing. Therefore, you need to calibrate each VHD Controller input separately.



**Note**

When you change a picture quality setting, save the change to a preset afterwards. Otherwise, the change will be lost when a different input is selected. (Picture quality settings are saved for each input separately.) For information about saving settings, refer to **Memory Presets** on page 43.

Although it may be possible to obtain satisfactory picture quality using the naked eye and regular program material, Vidikron recommends using the following calibration tools for best results:

- External test pattern source – Ovation Multimedia, Video Essentials or AVIA test DVD (or equivalent).
- A blue filter (provided with many test DVDs), for color level and tint adjustments.

Connect your test pattern source to the input that you are calibrating and proceed as follows. **Perform the adjustments in the order listed here.**

**Brightness:** On your external test pattern source, select a PLUGE pattern. (PLUGE is an acronym for “Picture Line-Up Generation Equipment.”) Figure 4-2 shows a typical PLUGE pattern.

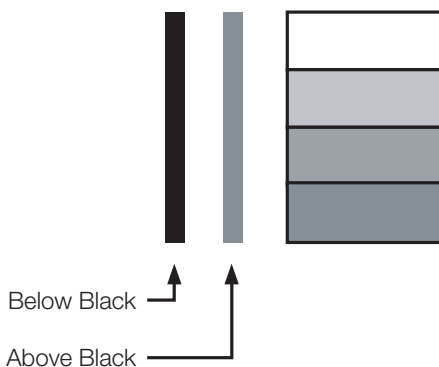

**Figure 4-2. Typical PLUGE Pattern for Adjusting Brightness**

PLUGE patterns vary but generally consist of some combination of black, white and gray areas against a black background. The example above includes two vertical bars and four shaded boxes.

Select Brightness from the Picture menu and press **ENTER**. Adjust the brightness so that:

- The darkest black bars disappear into the background.
- The dark gray areas are barely visible.
- The lighter gray areas are clearly visible.
- The white areas are a comfortable level of true white.
- The image contains only black, gray and white (no color).

**Contrast:** On your external test pattern source, select a stepped, gray-bar pattern like the one shown in Figure 4-3.



**Figure 4-3. Typical Gray Bar Pattern for Adjusting Contrast**

Select Contrast and press **ENTER**. Adjust the contrast to a point just below which the white rectangle starts to increase in size.



**Note**

*Brightness and contrast controls are interactive. A change to one may require a subtle change to the other in order to achieve the optimum setting.*

**Color Saturation:** On your external test pattern source, select a color bar pattern like the one shown in Figure 4-4.

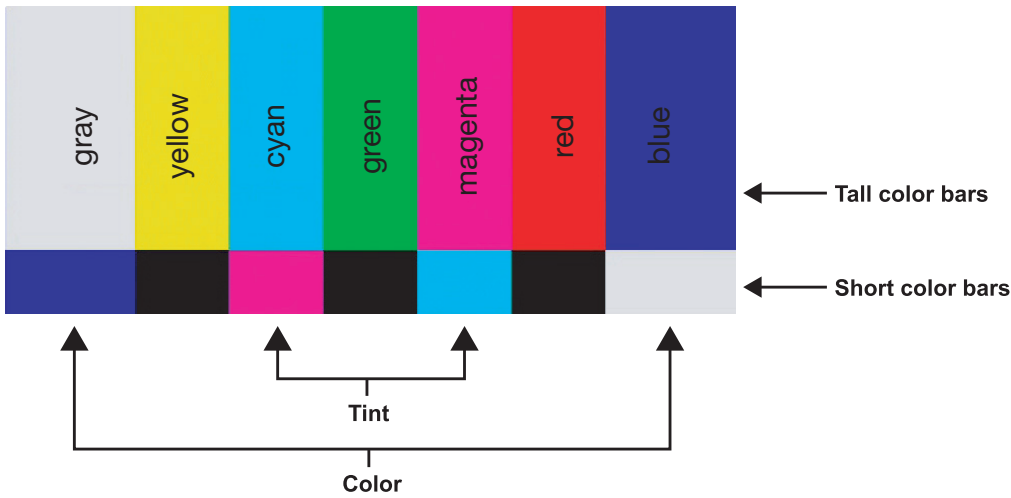

**Figure 4-4. Typical Color Bar Pattern for Adjusting Color Saturation and Tint**

Select Color and press **ENTER**. While looking at the color bar pattern through a blue filter, adjust the color saturation level until the outermost (gray and blue) color bars appear to be a single shade of blue:

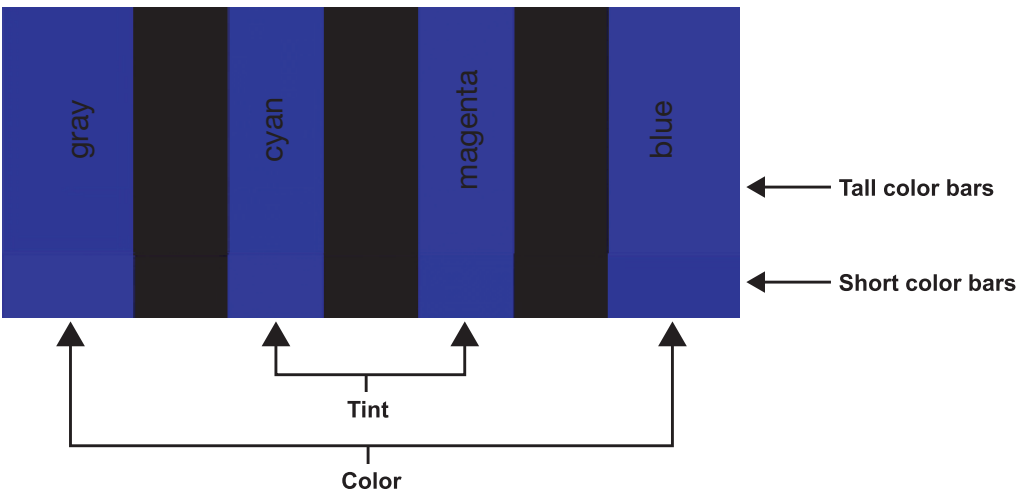

**Tint:** Tint or “hue” is essentially the ratio of red to green in the color portion of the image. When tint is decreased, the image appears redder; when it is increased the image appears greener. To set the tint, select Tint and press **ENTER**. While looking at the color bar pattern through a blue filter, adjust the tint level until the cyan and magenta color bars (on either side of the green bar) appear to be a single shade of blue.



**Note**

*Like the brightness and contrast controls, the color and tint controls are interactive. A change to one may require a subtle change to the other in order to achieve the optimum setting.*

**Sharpness:** “Sharpness” is the amount of high-frequency detail in the image. To adjust sharpness, select Sharpness from the Picture menu and press **ENTER**. On your external test pattern source, select a pattern like the one shown in Figure 4-5. Adjust as needed, looking for white edges around the transitions from black to gray and differently-sized lines in the “sweep” patterns at the top and bottom. Lower the sharpness setting to eliminate them.

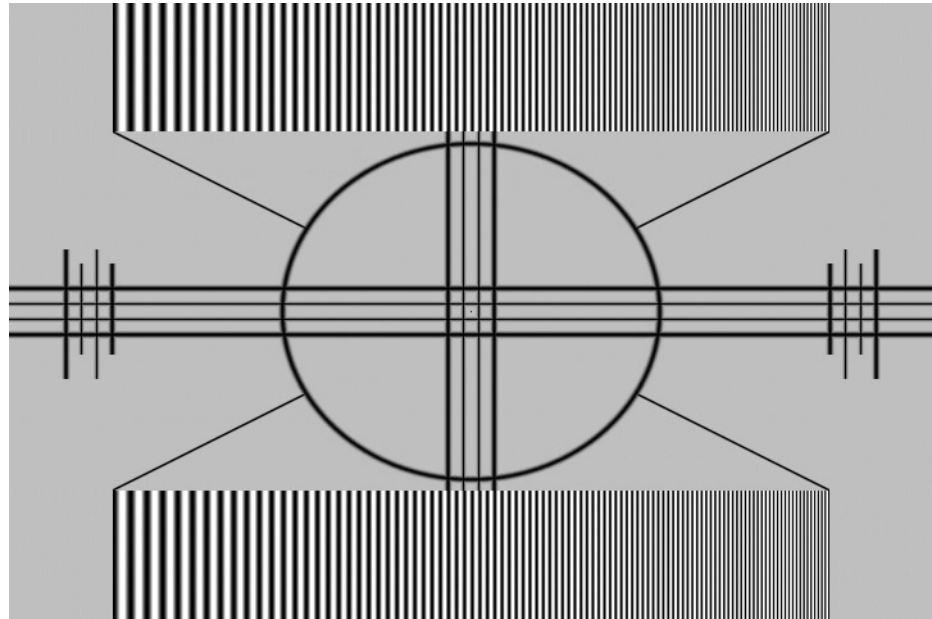

**Figure 4-5. Typical Test Pattern for Adjusting Sharpness**

**Input Position** ➤

Use the controls in the Input Position Menu to fine-tune the aspect ratio and image position for the current source.

<b>Input Position</b>
<b>Left/Right</b>
Up/Down
Width
Height
Overscan



**Note**

*The input position settings are automatically saved for each input and resolution.*

**Left/Right:** Select Left/Right from the Input Position menu to shift the projected image horizontally. Use the right or up cursor button to shift the image to the right; use the left or down button to shift it to the left.

**Up/Down:** Select Up/Down from the Input Position menu to shift the projected image vertically. Use the right or up cursor button to shift the image upward; use the left or down button to shift it downward.

**Width:** Select Width from the Input Position menu to change the projected image width. Use the right or up cursor button to increase the width; use the left or down button to decrease it.

**Height:** Select Height from the Input Position menu to change the projected image height. Use the right or up cursor button to increase the height; use the left or down button to decrease it.

**Overscan:** Image Overscan pushes the outside edge of the active picture area of the video signal out beyond the edge of the display area.

Some television programs are produced based on the assumption that older television sets may not display the outer edges of the broadcast picture area. Over scan effectively trims away these inactive, outer edges and enlarges the remaining portion of the image to fill the display area.

Select from 1% to 10% of Overscan, as desired.

For HDTV, DVDs and other video sources, Overscan is generally not necessary or desirable.

For each input, the PlasmaView VHD lets you save image quality settings as presets that you can recall at a later time. You can create up to four presets per input and resolution. Use the Memory Presets menu to recall saved image presets, or to save image settings in the "Custom 1" or "Custom 2" memory location.



**Note**

*On the VP-6500VHD, "Custom 2" is labeled "THX."*

The currently-selected preset is indicated by a "☒" to its left; in the example shown here, ISF Night is selected.

You should save changes to any of the following settings to a preset; otherwise they will be lost when a new input source or resolution is selected:

- Brightness
- Contrast
- Color saturation
- Tint
- Sharpness

To reset the Custom 1 and Custom 2/THX image presets to their factory defaults, select Factory Default and press **ENTER**.

Select Information from the Main Menu to see information that uniquely identifies your display: its serial number, the installed hardware and firmware versions and the firmware version build date. Should you ever need to contact Vidikron Technical Support, this information will help them answer your questions or resolve product performance issues.

◀ **Memory Presets**

Memory Presets	
<input checked="" type="checkbox"/>	ISF Night
<input type="checkbox"/>	ISF Day
<input type="checkbox"/>	Custom 1 <span style="float: right;">Save</span>
<input type="checkbox"/>	Custom 2 / THX <span style="float: right;">Save</span>
<b>Factory Default</b>	

◀ **Information**

Information	
<b>Serial Number</b>	
<b>Hardware</b>	0
<b>Firmware</b>	0100.0922
<b>Date</b>	Feb 29 2008

**Calibration** ➤

Use the Calibration menu to perform advanced picture quality adjustments on the **analog** inputs. **This menu should be used by ISF-certified technicians only.**

Calibration
<b>ISF Night</b>
Display Color
Input Image
Input Color
<b>ISF Day</b>
Display Color
Input Image
Input Color
Save ISF Settings
Output Shift
Splash Configure
OSD Position



**Note**

To calibrate the digital (HDMI 1 and HDMI 2) inputs, use the Display Image controls in the Service menu. For more information, refer to **Display Device** on page 47.



**Note**

You must enter a passcode to access the Calibration menu.

To recall the ISF Night or ISF Day settings, select “ISF Night” or “ISF Day” from the ISF Presets menu (see above). Or, use the corresponding buttons on the remote control.

**ISF Night - Display Color:** Use the Display Color settings to adjust the color balance at the display device (as opposed to the VHD Controller) for **analog** sources (up to 1080i). These settings are saved independently for each input.

- **Gain:** Use the Gain controls to correct color imbalances in the bright areas of the image. A good way to do this is to use a test pattern consisting mostly of solid white areas, such as an 80 IRE “window” pattern. If the white areas contain traces of red, green or blue, decrease the Gain for that color.
- **Offset:** Use the Offset controls in the White Balance sub-menu to correct color imbalances in the dark areas of the image. A good way to do this is to use a test pattern consisting mostly of dark gray areas, such as a 30 IRE “window” pattern. If the gray areas contain traces of red, green or blue, decrease the Offset for that color.
- **Gamma:** The default gamma setting (**1**) is correct for almost all signals and conditions. If excess ambient light washes out the image and it becomes difficult or impossible to see details in dark areas, lower the gamma setting to compensate. This will improve contrast while maintaining good details for blacks. Conversely, if the image is washed out and unnatural, with excessive detail in black areas, increase the setting. Again, good gamma improves contrast while maintaining good details for blacks and whites.
- **Color Temp.:** Select Color Temp from the Display Color menu to adjust the color temperature. For most situations, the appropriate setting is (**1**). The higher setting (**2**) produces a “bluer” picture; the lower one (**0**) a “warmer” picture with more pronounced red and orange hues.
- **AGC (Automatic Gain Control):** AGC increases the brightness of dark signals automatically. To enable AGC, set it to **1** (on). To disable it, set it to **0** (off).
- **Input Level:** The Input Level control allows you to adjust parts which are extremely bright and hard to see. (This cannot be adjusted when the input signal is digital.)

**ISF Night - Input Image:** The Input Image controls are similar to those in the Picture menu, but are accessible only by entering the Calibration menu passcode. This makes it possible to restore the picture quality settings to what they were when the display was installed, simply by recalling the “ISF Night” preset.



**ISF Night - Input Color:** The Input Color controls are similar to those in the Display Color menu (see above), but adjust the color balance at the VHD Controller (as opposed to the display device). These settings are also saved independently for each input.

- **Gain/Offset:** These controls operate similarly to those in the *ISF Night - Display Color* menu (see above), but affect the Y, Pb and Pr signal components rather than the red and blue channels.
- **Chroma Delay:** use the Chroma Delay control to correct a mis-aligned image from a Composite, S-Video or Component video source. Chroma delay in an image causes color shifts to occur to the left of the vertical edge transitions, producing artificial shadows or a “halo” effect. If necessary, adjust this setting to eliminate them.
- **Phase:** Adjust the phase if the image (usually from an RGB source) shows shimmer or “noise.” Pixel phase adjusts the phase of the pixel sampling clock relative to the incoming signal. The effect of this control is similar to that of a tracking control on a VCR.

For best results, use a good test pattern such as a smooth gray consisting of a clear pattern of black and white pixels, or a similar “half on, half off” graphic image. (You may notice that you can stabilize the image at more than one point. Use either setting in this case.)

- **Noise Filter:** To apply noise filtering to the input signal, select Noise Filter from the Input Color menu. The Noise Filter is useful for clearing up noisy images from 480i video sources.

Use the left- or right-arrow buttons to select the desired amount of noise reduction, keeping in mind that higher settings (which reduce high frequencies) may also “soften” the image.

**ISF Day - Display Color:** Refer to *ISF Night - Display Color*.

**ISF Day - Input Image:** Refer to *ISF Night - Input Image*.

**ISF Day - Input Color:** Refer to *ISF Night - Input Color*.

**Save ISF Settings:** Whenever you make a change to the ISF settings, you should always save it. Select Save ISF Settings from the ISF Calibration menu to do this. In the event you ever have to perform a System Reset, you can restore the saved ISF settings by selecting Restore Saved Settings in the Service menu. (System Reset and Restore Saved Settings are described on page 49.)

**Output Shift:** The controls in the Output Shift menu are similar to those in the Input Position menu, except that they change the characteristics of the output signal. These settings are saved independently **for each aspect ratio**.

**Splash Configure:** Use the Splash Configure menu to customize the appearance of the start-up message that appears on the vacuum fluorescent display upon power-up.

- **Owner Name/ISF Calibrated/ISF Other:** You can have the PlasmaView VHD display the owner’s name, your name, the phrase “ISF Calibrated” and/or any other string, up to 20 characters in length.

Use the up or down cursor button to select a character. Use the right and left cursor buttons to change the cursor position. Press **MENU** when you have finished entering text. Then, check the “Splash Enable” box to have the PlasmaView VHD display the information you enter here when it is turned on.

- **Vidikron/ISF Logo Splash Screen Timers:** When you turn on the PlasmaView VHD, it projects a welcome screen with the Vidikron logo followed by one with the ISF logo. Select Splash Timer from the Splash Configure menu to set the amount of time that these two images appear. The range is from 2 to 60 seconds, in one-second increments.

Use the up or down cursor button to select a timer value to adjust. Use the right or left cursor button to change the timer value. Press **MENU** when you have finished configuring both timers.

**OSD Position:** Select OSD Position, press **ENTER** and use the arrow buttons to change the size and position of the OSD controls.

**Service** ➤ Use the Service menu to access advanced display configuration settings. **This menu should be used by ISF-certified technicians only.**

<b>Service</b>
<b>Test Video</b>
Input Names
Remote Control
Display Device
HD Format
Triggers
Miscellaneous
System Reset
Restore Saved Settings



**Note**

You must enter a passcode to access the Service menu.

**Test Video:** Select Test Video from the Service Menu to access the internal test patterns on the PlasmaView VHD. Four patterns are available, consisting of white/gray or colored bars. These are useful for calibrating other theater source components (DVD player, HD tuner etc.) that have their own picture controls.

Press **MENU** to exit test pattern mode.

<b>Input Names</b>	
	Restore
<b>Composite</b>	Composite
S-Video 1	S-Video 1
S-Video 2	S-Video 2
Component SD	Component SD
HD/RGB 1	HD/RGB 1
HD/RGB 2	HD/RGB 2
HDMI 1	HDMI 1
HDMI 2	HDMI 2
	Save

**Input Names:** You can give each VHD Controller input a descriptive name. For example, you may want to change the default input name to the type of source component connected to it: "VCR," "DVD," "Laptop" et cetera. Composite, S-Video and Component SD input names can be up to 12 characters long; the others can be up to eight characters long.

To edit an input name, select Input Names from the Service menu. Press ▲ or ▼ to select an input and press **ENTER**. Use the ▲ or ▼ buttons to change a character; press ◀ or ▶ to select a character to change. When you have finished editing the input name, press **MENU**.

To restore the default input name, press ▼ repeatedly to highlight that input name in the "Restore" column. Then, press **ENTER**.

To save input names so that they can be restored after a System Reset (described on page 49), press ▼ repeatedly to highlight "Save." Then, press **ENTER**.



**Note**

The ▼ button takes you from top to bottom in the left column, then from top to bottom in the right column. To highlight "Save," scroll through both columns.

**Remote Control:** The Remote Control menu shows you the primary and secondary infrared (IR) codes to which the VHD Controller will respond. By default, both are set to 17. You can change these codes if either:

- Another device in the theater (a DVD player, for example) is responding to commands from the VHD Controller remote control (Figure 2-7) in ways that are unpredictable or undesirable.

- You have multiple VHD Controllers and want to control them independently, as opposed to broadcasting commands from a single remote to all of them. In this scenario, you can use multiple remotes programmed to use different IR codes. Or, you can use a single remote and change the IR code as needed to address a specific device.

**Tip**

Use the VHD Controller front-panel keypad to change its IR code. Then, change the code sent by the remote to match as described below.

**Note**

Do not change the "Type" setting in this menu.

When you change a remote code on the VHD Controller, you must re-program your remote control to send that same code. To do this:

- Using a straightened paper clip or similar object, press and hold the **CODE** button on the remote control for approximately three seconds, or until the LED on the remote lights solid red.

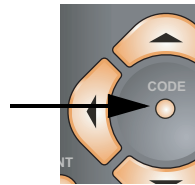

– OR –

If your remote control unit does not have a **CODE** button, press and hold the **LIGHT** button on the remote control for approximately three seconds, or until the LED on the remote lights solid red.

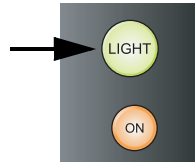

- Enter a new two-digit code between 00 and 31 inclusive. Use the **16:9** button for "9" and the **4:3** button for "0." Include a leading zero for single-digit codes; for example, enter 9 as "09."
- The LED turns off to confirm the code change. If you enter an invalid code, the LED flashes for three or four seconds. Try again, entering a valid code.

**Display Device:** The options in the Display Device menu allow you to perform certain adjustments at the plasma display.

- Display Position:** Select Display Position from the Display Device menu to perform the following display device adjustments (these are global, independent of any input):
  - Select **Left/Right** or **Up/Down** and use the ◀ or ▶ buttons to fine-tune the displayed image position.
  - Select **Width** or **Height** and use the ◀ or ▶ buttons to fine-tune the display device aspect ratio.
  - Select **Pix By Pix** from the Display Position menu and set it to **Enable** to have the PlasmaView VHD map a 1920x1080 input signal to 1080p HD panel pixels, displaying 100% of the original content. By skipping the scaling process, the PlasmaView VHD can produce high-definition images in their original, 1:1 pixel form.

When Pix By Pix mode is disabled, the picture source is scaled for over-scanning and 97% of the original is displayed. Use this setting to minimize or eliminate image flicker.

**Note**

- Pix By Pix is available only when the input signal is 1080i or 1080p.*
- You cannot adjust the Width or Height when Pix By Pix is enabled.*

- **Display Image (1080i digital and 1080p signals ONLY):** Select Display Image from the Display Device menu to perform the following display device adjustments.
  - Brightness
  - Contrast
  - Color
  - Tint
  - Sharpness
  - Color Temperature
  - AGC
  - Input Level
  - Red/Green/Blue Gain
  - Red/Green/Blue Offset
  - Gamma

For detailed instructions for making these adjustments, refer to **Picture** on page 39 or **Calibration** on page 44.



**Note**

*The PlasmaView VHD stores any changes you make to these settings in the currently-selected ISF preset (ISF Day or ISF Night). After calibrating the display for one ISF preset, save your settings, select the other ISF preset and repeat the process.*

**HD Format:** If the characteristics of the incoming signal on the HD1 or HD2 inputs are known, select HD Format from the Service menu and set them as described below. Doing so can reduce the time it takes the VHD Controller to switch from HD to 480i signals or vice versa.

This is generally not necessary unless the VHD Controller – for whatever reason – has difficulty determining the color space (RGB or YUV), bandwidth or resolution of the incoming HD signal. In most situations, the **Auto** settings work well.

- **HD/RGB 1 and HD/RGB 2 (Color Space):** Select Auto, RGB or YUV.
- **ADC Bandwidth:** Select Auto, 75 MHz, 150 MHz or 300 MHz.
- **YPbPr Input Resolution:** Select Auto or specify the input resolution, if known: 480i, 480p, 576i, 576p, 720p or 1080i.

**Triggers:** Select Triggers from the Service menu to configure the 12-volt trigger outputs. You can assign one or more trigger outputs to each aspect ratio. Those triggers are then activated by selecting that aspect ratio.

To save the trigger settings so that they can be restored after a System Reset (described below), press ▼ repeatedly to highlight “Save.” Then, press **ENTER**.

**Miscellaneous:** Select Miscellaneous from the Service menu to set the following options:

- **Language:** Select Language from the Miscellaneous menu and press the up- or down-arrows to select the OSD language. (Currently, only English is supported.)
- **Menu Mode:** This is the manner in which the OSD menus appear and disappear when you press **MENU**. Choose one of the following:
  - 0 = No transition; menus abruptly appear and disappear.
  - 1 = Menus fade in and out.
  - 2 = "Checkerboard" dissolve; menus appear and disappear in sections.
  - 3 = "Window shade" effect; menus are drawn on a diagonal from top left to bottom right, and retract in the opposite direction.
- **Timeout - Short/Long:** These settings control how long the OSD menus stay on screen. Select a time-out period of from 2 to 60 seconds.
- **Side Bar Color:** This controls the color of the inactive image area. The range is from -100 (black) to 100 (white).

The inactive image area is on either side of the active image area when using the Standard 4:3 aspect ratio (or the entire screen when no incoming video signal is present).

- **Film Mode:** Enable Film Mode to smooth out moving images from interlaced, standard-definition (SD) sources. In most cases, the PlasmaView VHD detects the proper "pull-down" rate and vertical frequency. However, if your source is jittery and/or tearing you may wish to enable Film Mode to ensure stable processing for that source.

**System Reset:** To reset ALL VHD Controller settings (including image settings) back to their factory defaults, choose System Reset from the Service menu.

A confirmation message appears, reminding you to save your settings before you perform the reset, so that you can restore them afterwards. If you have done this, select Confirm to continue with the reset. Otherwise, click Back to cancel.



**Caution**

***This action is not undoable. Proceed with caution!*** Before you perform a System Reset, save ALL settings, including "Custom" ISF Presets (page 43), ISF Day/Night presets (page 43), Output Shift settings (page 45), Input Names (page 46) and Trigger settings (page 48).

**Restore Saved Settings:** Following a System Reset, select Restore Saved Settings to apply all previously-saved settings to the PlasmaView VHD and VHD Controller.

**Notes:**

# Maintenance and Troubleshooting

Regular cleaning will extend the life and performance of the PlasmaView VHD. Before cleaning, be sure to unplug the power cord from the power outlet.

Do not under any circumstances use solvents such as benzene or thinner to clean the PlasmaView VHD. Doing so may cause deterioration or peeling of paint from the display or remote control unit.

Wipe the display and remote control gently with a soft cloth. In the case of excessive dirt buildup, dampen a soft cloth with a diluted neutral cleaning detergent and after wringing the cloth thoroughly, wipe the component and then dry it with a dry soft cloth.

After dusting, wipe the screen gently using the supplied cleaning cloth or another soft cloth (cotton, flannel etc.). Do not use tissue or a rough cloth. The screen surface is easily scratched; do not rub it or hit it with a hard object.

If you clean the surface of the screen with a wet cloth, water droplets on the surface may enter into the product and cause a malfunction.

As a general rule, use a vacuum cleaner about once a month to clean the vents on the rear panel of the display of dust buildup (set the vacuum cleaner to its weakest setting when doing this). If not removed, accumulated dust can cause the internal temperature to increase, resulting in possible breakdown or fire.

---

## 5.1 Cleaning

### ◀ *Cleaning the Display Panel Body and Remote Control*

### ◀ *Cleaning the Screen*

### ◀ *Cleaning the Vents*

## 5.2 Troubleshooting Tips

Table 5-1 provides some general guidelines for troubleshooting problems you may encounter with the PlasmaView VHD. If the suggested solutions fail to resolve the problem or if you encounter an issue not described here, please contact your Vidikron dealer or Vidikron Technical Support.

**Table 5-1. Troubleshooting Chart**

Symptom	Possible Cause(s)	Solution
The display does not turn on after initial installation.	<ul style="list-style-type: none"> <li>The PlasmaView VHD is not plugged in or the AC outlet is not active.</li> <li>The VHD Controller is not plugged in or the AC outlet is not active.</li> <li>The remote control batteries have run out.</li> <li>The serial connection from the VHD Controller to the PlasmaView VHD is incorrect.</li> </ul>	<ul style="list-style-type: none"> <li>Ensure that the PlasmaView VHD is plugged in and that the AC outlet is active.</li> <li>Ensure that the VHD Controller is plugged in and that the AC outlet is active.</li> <li>Replace the batteries.</li> <li>Ensure that the RS-232 output from the VHD Controller is properly connected to the RS-232C input on the PlasmaView VHD (see Figure 3-5).</li> </ul>
The PlasmaView VHD and VHD Controller are both on, but there is no picture and on-screen menus do not appear.	<ul style="list-style-type: none"> <li>Faulty or incorrect video connection between the VHD Controller and the PlasmaView VHD.</li> </ul>	<ul style="list-style-type: none"> <li>Ensure that the HDMI output from the VHD Controller is properly connected to the <b>SLOT 2</b> input on the PlasmaView VHD (see Figure 3-4).</li> </ul>
The display is on and menus appear, but there is no picture.	<ul style="list-style-type: none"> <li>Incorrect source selection.</li> <li>Source component is not turned on.</li> <li>Source component is connected incorrectly or not at all.</li> </ul>	<ul style="list-style-type: none"> <li>Select the correct source.</li> <li>Turn on the source component.</li> <li>Check connections from source component to VHD Controller.</li> </ul>
Image is too bright and/or lacks definition in the bright areas of the image.	<ul style="list-style-type: none"> <li>Contrast is set too high.</li> </ul>	<ul style="list-style-type: none"> <li>Lower the contrast setting.</li> </ul>
Image appears "washed out" and/or dark areas appear too bright.	<ul style="list-style-type: none"> <li>Brightness is set too high.</li> </ul>	<ul style="list-style-type: none"> <li>Lower the brightness setting.</li> </ul>
Colors in the image are swapped; for example, reds appear blue or vice versa.	<ul style="list-style-type: none"> <li>The Red/Pr, Green/Y or Blue/Pb outputs from the source are connected to the wrong inputs on the VHD Controller.</li> <li>The Red, Green or Blue (analog) outputs from the VHD Controller are connected to the wrong inputs on the PlasmaView VHD.</li> </ul>	<ul style="list-style-type: none"> <li>Ensure that the source outputs are connected to the correct VHD Controller input.</li> <li>Ensure that the VHD Controller outputs are connected to the correct inputs on the PlasmaView VHD.</li> </ul>



**Table 5-1. Troubleshooting Chart (continued)**

<b>Symptom</b>	<b>Possible Cause(s)</b>	<b>Solution</b>
RGB-HD images appear "noisy."	<ul style="list-style-type: none"> <li>• Clock and Phase settings need adjustment.</li> </ul>	<ul style="list-style-type: none"> <li>• Adjust Clock and Phase settings (refer to <b>ISF Night - Input Color</b> on page 45).</li> </ul>
Computer images do not display correctly.	<ul style="list-style-type: none"> <li>• The resolution and frequency of the video card in the computer are not compatible with the PlasmaView VHD.</li> </ul>	<ul style="list-style-type: none"> <li>• Select a compatible resolution and vertical frequency (refer to <b>Supported Timings</b> on page 66).</li> </ul>
The image is too large or too small.	<ul style="list-style-type: none"> <li>• Image size needs adjusting.</li> </ul>	<ul style="list-style-type: none"> <li>• Adjust the image size (refer to <b>Input Position</b> on page 42 or <b>Display Device - Display Position</b> on page 47).</li> </ul>

**Notes:**

## Serial Communications

To interface the PlasmaView VHD with a home theater automation/control system or a PC running terminal emulation software, connect it to the RS-232 output of the VHD Controller as shown in Figure 3-5. Connect your control system or PC to the RS-232 input of the VHD Controller as shown in Figure 3-10.

Configure the RS-232 controller or PC serial port as follows: no parity, eight (8) data bits, one (1) stop bit and no flow control. Set the baud rate to 19200, to match that of the VHD Controller RS-232 port.

Serial commands to the VHD Controller take the following form:

- Commands are not case-sensitive.
- For a single command that takes no parameters, type the command followed by a carriage return; for example, to set the aspect ratio to Letterbox, type `LETTERBOX <Enter>`.
- For a single command that takes a parameter, type the command, a space or a comma and the desired value followed by a carriage return; for example, to set the brightness to -10, type `BRIGHTNESS -10 <Enter>` or `BRIGHTNESS, -10 <Enter>`.
- You can also send a string of multiple commands on a single line, separated by commas. For example, `COMPOSITE, BRIGHTNESS 100, 16:9 <Enter>` switches to the Composite video input, sets the brightness to 100 and sets the aspect ratio to 16:9. Command strings can be up to 255 characters long.



### Note

Avoid combining the `ON` or `POWER 1` commands with other commands on a single line. After sending `ON` or `POWER 1`, allow at least five (5) seconds for the VHD Controller to power up. If you have enabled the ISF splash screen (refer to **Splash Configure** on page 45), allow 15 seconds for the VHD Controller to power up.

Once it does, it will accept and properly execute multiple serial commands.

### 6.1 RS-232 Connection and Port Configuration

### 6.2 Serial Command Syntax

Table 6-1 lists the RS-232 command set. The “Parameter (min/max)” column shows the valid parameter ranges, or “NA” for commands that take no parameters.

When you enter a valid command, the VHD Controller executes it and acknowledges it with a plus sign on the command line (+ >). When you enter an invalid command – one that is misspelled or followed by values outside the valid range for that command – the VHD Controller ignores it and returns a minus sign (- >).

**Table 6-1. Serial Commands**

Command	Parameter (min/max)	Value Stored?	Description
<b>Power On/Off Commands</b>			
OFF	NA	NA	Turns system off
ON	NA	NA	Turns system on
POWER	0/1	NA	Turns system on or off (toggles on/off state)
POWER?	NA	NA	Returns power status
<b>Input Selection Commands</b>			
COMPONENT	NA	YES	Selects the Component input
COMPOSITE	NA	YES	Selects the Composite video input
HDMI1	NA	YES	Selects the HDMI 1 input
HDMI2	NA	YES	Selects the HDMI 2 input
HD1	NA	YES	Selects the RGB/HD 1 input
HD2	NA	YES	Selects the RGB/HD 2 input
INPUT?	NA	NA	Returns active input
SVIDEO1	NA	YES	Selects the S-Video 1 input
SVIDEO2	NA	YES	Selects the S-Video 2 input
<b>Aspect Ratio Commands (not available on HDMI 1 or HDMI 2 inputs)</b>			
16:9	NA	YES	Selects the 16:9 aspect ratio
ASPECT?	NA	NA	Returns current aspect ratio
CINEMA	NA	YES	Selects the Cinema aspect ratio
LETTERBOX	NA	YES	Selects the Letterbox aspect ratio
4:3	NA	YES	Selects the 4:3 aspect ratio
INTELLIWIDE	NA	YES	Selects the IntelliWide aspect ratio

**Table 6-1. Serial Commands (continued)**

Command	Parameter (min/max)	Value Stored?	Description
<b>Picture Adjust Commands (not available on HDMI 1 or HDMI 2 inputs)</b>			
BRIGHTNESS	-100/100	YES	Sets a value for brightness
BRIGHTNESS?	NA	NA	Returns brightness setting value
CHROMADELAY	-12/12	YES	Sets a value for input color chroma delay
CHROMADELAY?	NA	NA	Returns input color chroma delay setting
COLOR	-100/100	YES	Sets a value for color
COLOR?	NA	NA	Returns color setting value
CONTRAST	-100/100	YES	Sets a value for contrast
CONTRAST?	NA	NA	Returns contrast setting value
FILMMODE	0/1	YES	Sets Film Mode off (0) or on (1)
FILMMODE?	NA	NA	Returns Film Mode setting (0 = off; 1 = on)
FILTER	0/15	YES	Sets a value for input color noise filter
FILTER?	NA	NA	Returns input color noise filter setting
PHASE	0/3	YES	Adjusts phase
PHASE?	NA	NA	Returns phase setting value
SHARPNESS	-6/6	YES	Sets a value for sharpness
SHARPNESS?	NA	NA	Returns sharpness setting value
TINT	-100/100	YES	Sets a value for tint
TINT?	NA	NA	Returns tint setting value
<b>Memory Preset Commands</b>			
CUSTOM1	NA	YES	Loads "Custom 1" image preset
CUSTOM2	NA	YES	Loads "THX" ("Custom 2") image preset
PRESET?	NA	NA	Returns currently-selected preset (ISF Day, ISF Night, Custom 1 or THX/Custom 2)
DAY	NA	YES	Loads "ISF Day" image preset
NIGHT	NA	YES	Loads "ISF Night" image preset

**Table 6-1. Serial Commands (continued)**

Command	Parameter (min/max)	Value Stored?	Description
<b>Input Position Commands (not available on HDMI 1 or HDMI 2 inputs)</b>			
IHEIGHT	-100/100	YES	Sets the value for input height
IHEIGHT?	NA	NA	Returns input height value
IHPOS	-100/100	YES	Sets a value for horizontal input position
IHPOS?	NA	NA	Returns input horizontal position value
IVPOS	-100/100	YES	Sets a value for vertical input position
IVPOS?	NA	NA	Returns input vertical position value
IWIDTH	-100/100	YES	Sets the value for input width
IWIDTH?	NA	NA	Returns input horizontal width value
OVERSCAN	0/10	YES	Sets the overscan percentage
OVERSCAN?	NA	NA	Returns overscan percentage
<b>Output Shift Commands (not available on HDMI 1 or HDMI 2 inputs)</b>			
OHEIGHT	-100/100	YES	Sets the value for output height
OHEIGHT?	NA	NA	Returns output height value
OHPOS	-100/100	YES	Sets the value for output horizontal position
OHPOS?	NA	NA	Returns output horizontal position value
OVPOS	-100/100	YES	Sets the value for output vertical position
OVPOS?	NA	NA	Returns output vertical position value
OWIDTH	-100/100	YES	Sets the value for output width
OWIDTH?	NA	NA	Returns output horizontal width value

**Table 6-1. Serial Commands (continued)**

Command	Parameter (min/max)	Value Stored?	Description
<b>Miscellaneous Commands (not available on HDMI 1 or HDMI 2 inputs)</b>			
BKGND	-100/100	YES	Sets the background color for 4:3 aspect ratio (-100 = black; 100 = white)
BKGND?	NA	NA	Returns background setting value
DATE?	NA	NA	Returns product manufacture date
HDINPUTRES	NA	YES	Sets YPbPr input resolution and refresh rate for HD1/HD2, as follows: 0 = 480i 1 = 480p 2 = 576i 3 = 576p 4 = 720p / 60 Hz 5 = 1080i / 60 Hz 6 = 720p / 50 Hz 7 = 1080i / 25 Hz Any other value = Auto
HWVER?	NA	NA	Returns hardware version number
INRES?	NA	NA	Returns input resolution
<b>Miscellaneous Commands (available on all inputs)</b>			
SWVER?	NA	NA	Returns software version number
TRIGGER	1/3	YES	Assigns trigger to currently-selected aspect ratio

**Table 6-1. Serial Commands (continued)**

Command	Parameter (min/max)	Value Stored?	Description
The following serial commands are meant to emulate buttons on the remote control or VHD Controller front panel. Each button has its own serial command, so effectively it is as if you were using the IR remote only you'll be doing so via serial commands. These commands provide active OSD responses just like the IR remote.			
DOWN	NA	NA	Down-Arrow (▼) key
ENTER	NA	NA	<b>ENTER</b> key
LEFT	NA	NA	Left-Arrow (◀) key
MENU	NA	NA	<b>MENU</b>
RIGHT	NA	NA	Right-Arrow (▶) key
UP	NA	NA	Up-Arrow (▲) key



# Specifications

Table 7-1 lists the PlasmaView VHD specifications.

**Table 7-1. PlasmaView VHD Specifications**

<b>Native Resolution:</b>	1920 x 1080
<b>Screen Size:</b>	<p><b>VP-5000VHD / VP-5000VHDa:</b> 43.50 in. W x 24.50 in. H (1104.9 x 622.3 mm) 50 in. (1270.0 mm) diagonal</p> <p><b>VP-6500VHD / VP-6500VHDa:</b> 56.50 in. W x 31.80 in. H (1434.0 x 807.0 mm) 65 in. (1646.0 mm) diagonal</p> <p><b>VP-103VHD:</b> 89.30 in. W x 50.30 in. H (2268.2 x 1277.6 mm) 103 in. (2616.2 mm) diagonal</p>
<b>Screen Aspect Ratio:</b>	16:9
<b>Available Aspect Ratios:</b>	Refer to Table 7-2
<b>DTV Compatibility:</b>	480p, 720p, 1080i, 1080p
<b>Contrast Ratio:</b>	400:1 (measured at 100 lux); 5,000:1 maximum
<b>Data/Graphics Compatibility:</b>	VGA, SVGA, XGA, SXGA, UXGA (compressed) Horiz. scan frequency = 15 to 110 kHz Vert. scan frequency = 48 to 120 Hz
<b>Inputs (from VHD Controller):</b>	(1) Digital Video (HDMI 1.2A with HDCP) (1) RS-232 (9-pin, D-sub male)
<b>Power Requirements:</b>	<p><b>VP-5000VHD / VP-5000VHDa / VP-6500VHD / VP-6500VHDa:</b> 100 to 240 VAC, 50/60Hz</p> <p><b>VP-103VHD:</b> 200 to 240 VAC, 50/60Hz</p>
<b>Power Consumption:</b>	<p><b>VP-5000VHD / VP-5000VHDa:</b> 650 W/2218.4 BTUs/hour (1.0 W in standby), maximum</p> <p><b>VP-6500VHD / VP-6500VHDa:</b> 790 W/2696.3 BTUs/hour (1.0 W in standby), maximum</p> <p><b>VP-103VHD:</b> 1500 W/5119.5 BTUs/hour (1.5 W in standby), maximum</p>
<b>Operating Environment:</b>	<p>40°F to 95°F (5°C to 35°C); 20% to 80% humidity (non-condensing) Altitude – Model VP-5000VHDa / VP-6500VHDa = up to 9,100 feet (2,774m) Altitude – Model VP-5000VHD / VP-6500VHD / VP-103VHD = up to 7,800 feet (2,377m)</p>
<b>Dimensions:</b>	<p><b>VP-5000VHD / VP-5000VHDa:</b> See Figure 7-1</p> <p><b>VP-6500VHD / VP-6500VHDa:</b> See Figure 7-2</p> <p><b>VP-103VHD:</b> See Figure 7-3</p>
<b>Weight (panel only, without stand):</b>	<p><b>VP-5000VHD / VP-5000VHDa:</b> 93.0 lbs. (42.18 kg)</p> <p><b>VP-6500VHD / VP-6500VHDa:</b> 163.1 lbs. (73.98 kg)</p> <p><b>VP-103VHD:</b> 485.0 lbs. (220.0 kg)</p>

## 7.1 PlasmaView VHD Specifications

**Table 7-1. PlasmaView VHD Specifications (continued)**

<b>Limited Warranty:</b>	Three (3) years parts and labor from the date of delivery to the end user (except for plasma glass panel). Plasma Glass Panel: One (1) year parts and labor from the date of delivery to the end user.
--------------------------	---

<b>Regulatory Approvals:</b>	Complies with FCC Part 15 Class B, ICES-003, UL6500 Ver.2
------------------------------	---

**Specifications are subject to change without notice.**

## 7.2 VHD Controller Specifications

Table 7-2 lists the VHD Controller specifications.

**Table 7-2. VHD Controller Specifications**

<b>Aspect Ratios:</b>	4:3, Letterbox, 16:9, IntelliWide, Cinema
<b>Video Standards:</b>	NTSC, PAL
<b>Inputs:</b>	(1) Composite (2) S-Video (1) Component (2) HD-R (Pr), G (Y), B (Pb), H, V (2) HDMI with HDCP
<b>Outputs:</b>	HDMI with HDCP
<b>Control Options:</b>	- Discrete infrared remote - Serial commands via RS-232 - Front-panel controls
<b>RS-232 Communication Parameters:</b>	19200 bps, no parity, 8 data bits, 1 stop bit, no flow control
<b>Trigger Outputs:</b>	(3) +12 VDC, each rated at 750 mA and thermal fuse-protected
<b>Bandwidth:</b>	150 Mega Samples per Second (MSPS)
<b>Power Requirements:</b>	100 to 240 VAC (auto-sensing), 50/60 Hz, 160 Watts
<b>Operating Environment:</b>	41°F to 95°F (5°C to 35°C), 0% to 90% humidity (non-condensing)
<b>Dimensions:</b>	Width = 17.50 inches (444.5 mm) Depth = 11.19 inches (284.1 mm) Height = 3.75 inches (95.3 mm)
<b>Weight:</b>	13.0 lbs. (5.90 kg)
<b>Regulatory Approvals:</b>	Complies with FCC, CE C-Tick
<b>Limited Warranty:</b>	Two (2) years parts and labor from the date of delivery to the end user.
<b>Specifications are subject to change without notice.</b>	

Figure 7-1, Figure 7-2 and Figure 7-3 show the PlasmaView VHD dimensions (all dimensions are in inches).

### 7.3 PlasmaView VHD Dimensions

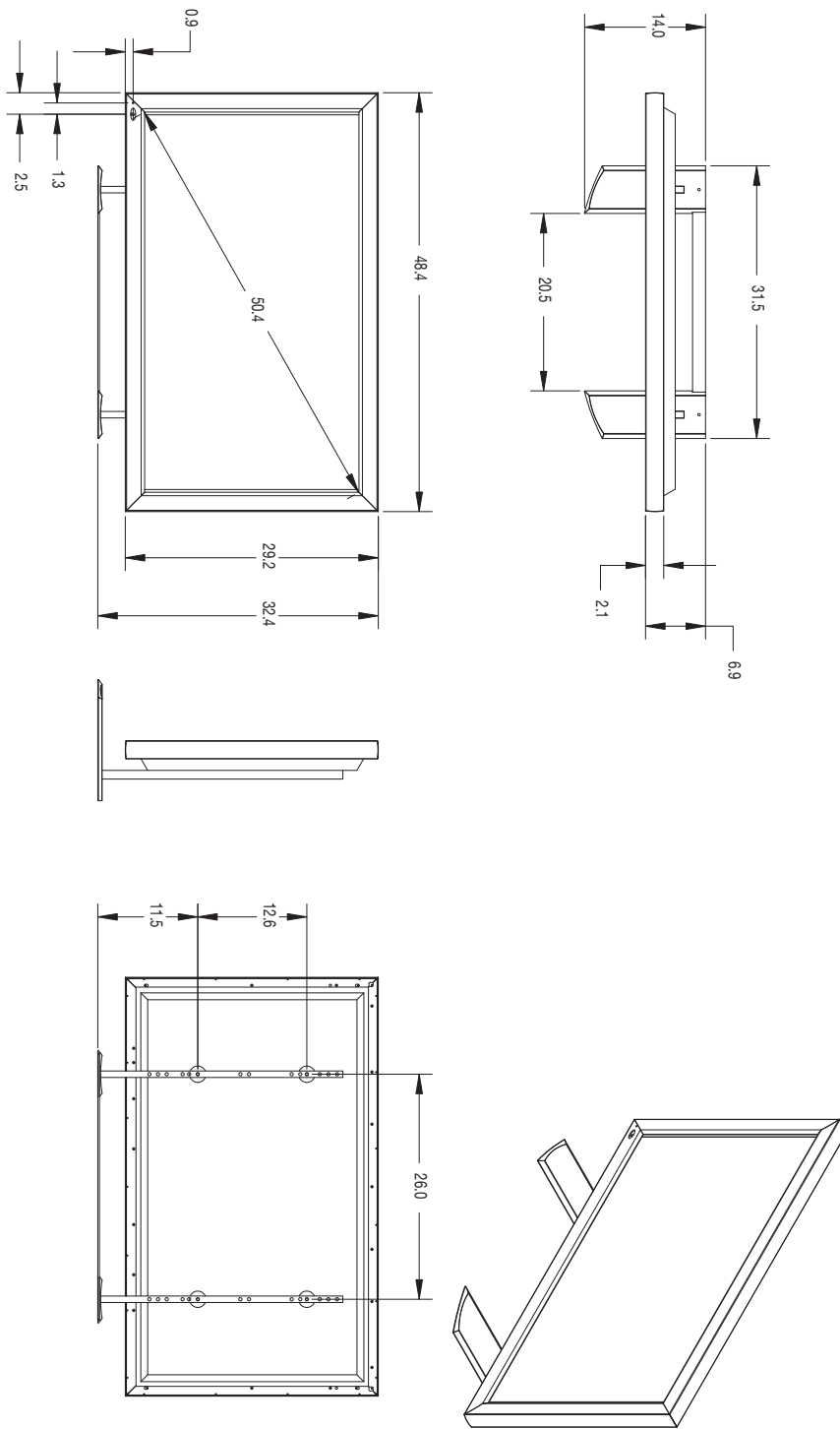

**Figure 7-1. PlasmaView VHD Model VP-500VHD Dimensions (with Optional Table Stand)**

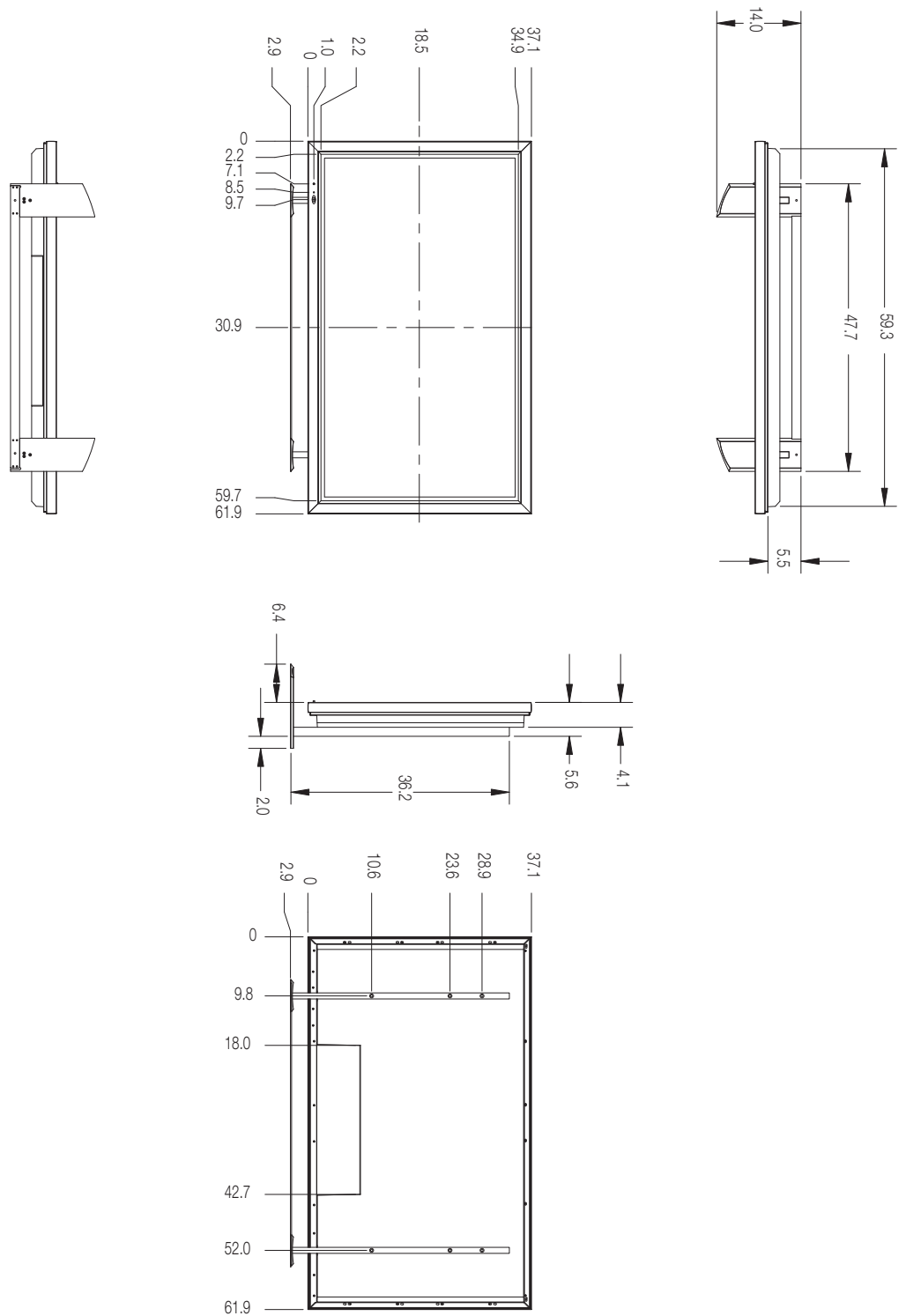

**Figure 7-2. PlasmaView VHD Model VP-6500VHD Dimensions (with Optional Table Stand)**

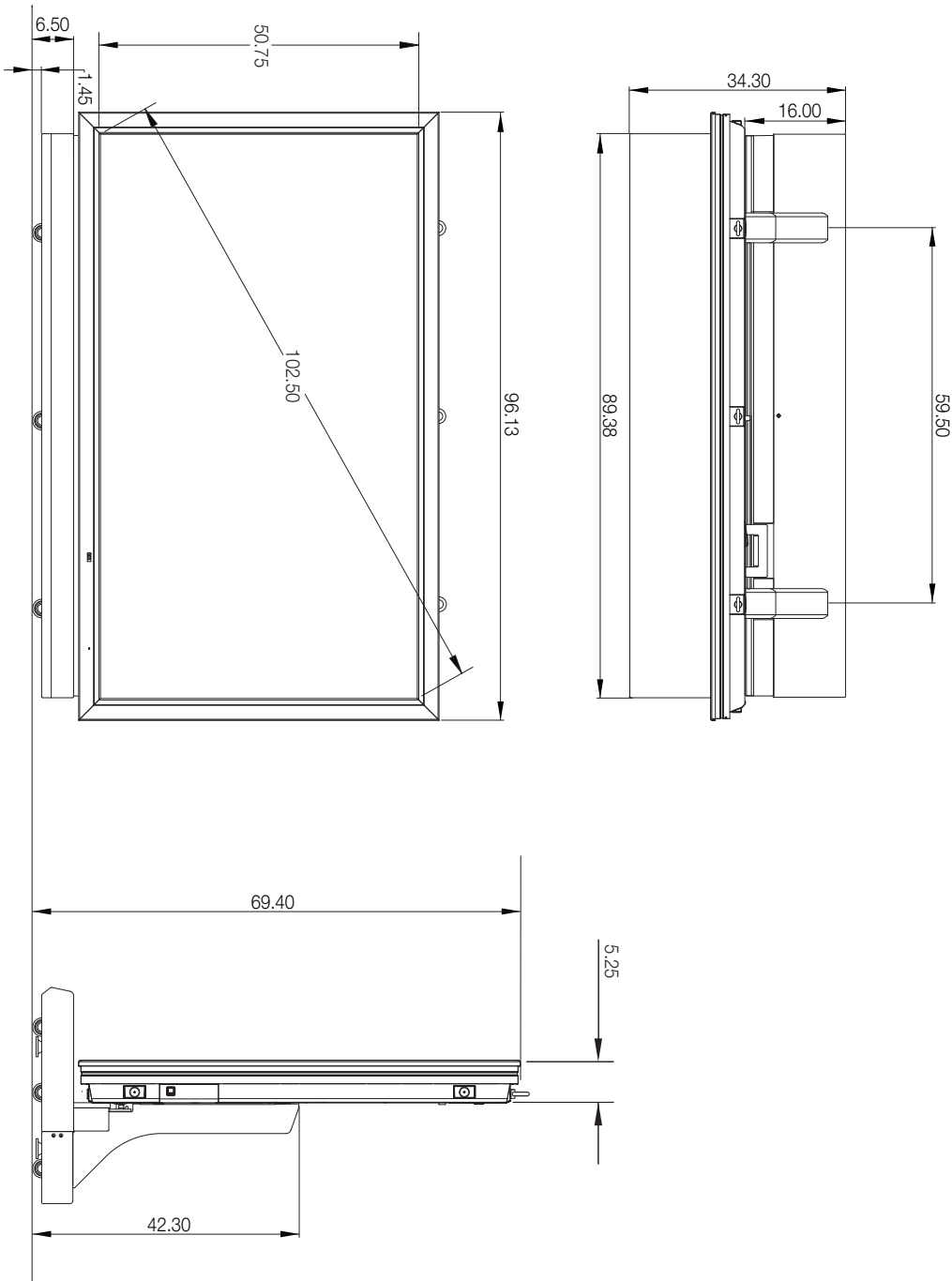

**Figure 7-3. PlasmaView VHD Model VP-103VHD Dimensions (with Floor Stand)**

## 7.4 Supported Timings

Table 7-3 lists the signal types supported by each input on the VHD Controller.

**Table 7-3. Supported Signal Timings by Input**

Format	Resolution	Refresh Rate (Hz)	Horizontal Frequency (kHz)	Pixel Frequency (MHz)	Supported? (√ = Yes, – = No)				
					HD/RGB 1 HD/RGB 2	HDMI 1 HDMI 2	Component	S-Video 1 S-Video 2	Video
640x480	640x480	60.00	31.469	25.175	√	–	–	–	–
		72.00	37.861	31.500	√	–	–	–	–
		75.00	37.500	31.500	√	–	–	–	–
		85.00	43.269	36.000	√	–	–	–	–
800x600	800x600	56.00	35.156	36.000	√	–	–	–	–
		60.00	37.879	40.000	√	√	–	–	–
		72.00	48.077	50.000	√	√	–	–	–
		75.00	46.875	49.500	–	√	–	–	–
		85.00	53.674	56.250	√	√	–	–	–
1024x768	1024x768	60.00	48.363	65.000	√	√	–	–	–
		70.00	56.476	75.000	√	√	–	–	–
		75.00	60.023	78.750	√	–	–	–	–
1280x1024	1280x1024	60.00	63.981	108.000	√	–	–	–	–
1920x1080	1920x1080	60.00	74.038	154.000	–	√	–	–	–
480/60i	720x487	59.94	15.734	13.500	√	–	√	√	√
480/60p	720x483	59.94	31.469	27.000	√	√	–	–	–
576/50i	720x576	50.00	15.625	14.750	√	–	√	√	√
576/50p	720x576	50.00	31.250	29.000	√	√	–	–	–
720/50p	1280x720	50.00	37.500	75.250	√	√	–	–	–
720/60p	1280x720	60.00	45.000	74.250	√	√	–	–	–
1080/50i	1920x1080	50.00	28.125/31.250	74.250/72.000	√	√	–	–	–
1080/60i	1920x1080	59.94/60.00	33.716/33.750	74.175/74.250	√	√	–	–	–
1080/24p	1920x1080	23.98/24.00	26.978/27.000	74.175/74.250	–	√	–	–	–
1080/50p	1920x1080	50.00	56.250	148.500	–	√	–	–	–
1080/60p	1920x1080	59.94/60.00	67.433/67.500	148.350/148.500	–	√	–	–	–
NTSC 3.58	–	59.94/60.00	15.734/15.750	3.580	√	–	√	√	√
NTSC 4.43	–	59.94/60.00	15.734/15.750	4.430	√	–	√	√	√
PAL-B/G	–	50.00	15.625	4.430	√	–	√	√	√
PAL-M	–	59.94/60.00	15.734/15.750	3.580	√	–	√	√	√

**Table 7-3. Supported Signal Timings by Input (continued)**

Format	Resolution	Refresh Rate (Hz)	Horizontal Frequency (kHz)	Pixel Frequency (MHz)	Supported? (√ = Yes, – = No)				
					HD/RGB 1 HD/RGB 2	HDMI 1 HDMI 2	Component	S-Video 1 S-Video 2	Video
PAL-N	–	50.00	15.625	3.580	√	–	√	√	√
PAL-60	–	59.94/60.00	15.734/15.750	4.430	√	–	√	√	√

**Notes:**





020-0781-01 Rev. A  
March 2008



1-888-4-VIDIKRON  
Fax 503-748-8161  
[www.vidikron.com](http://www.vidikron.com)



SERIAL NUMBER

## Free Manuals Download Website

<http://myh66.com>

<http://usermanuals.us>

<http://www.somanuals.com>

<http://www.4manuals.cc>

<http://www.manual-lib.com>

<http://www.404manual.com>

<http://www.luxmanual.com>

<http://aubethermostatmanual.com>

Golf course search by state

<http://golfingnear.com>

Email search by domain

<http://emailbydomain.com>

Auto manuals search

<http://auto.somanuals.com>

TV manuals search

<http://tv.somanuals.com>