The logo for Vidikon, featuring the brand name in a bold, black, stylized font. The letters are thick and blocky, with a distinctive design where the 'V' and 'I' are connected to the 'D'. A registered trademark symbol (®) is located at the top right of the 'N'. The logo is set against a background of large, light gray geometric shapes, including triangles and rectangles, some of which are partially overlapping the text.

Vision Model 40
Vision Model 40ET
Owner's Manual

Table of Contents

Table of Contents	1
Warning	4
Two Year Limited Warranty	6
Overview	8
Features	8
Projector Exterior View	10
Front / Upper Side	10
Rear / Bottom Side	11
Controls and Functions	12
Control Panel	12
Connector Panel	14
Remote Control	15
Installation	17
Remote Control	17
Projector	18
Connect the Power Cord	18
Adjust the Lens Zoom/Focus ring	18
Adjust the height	19
Installation For Vision Model 40 (With 1.38 - 1.63 Lens)	20
Throw Distance Chart For Vision Model 40 (With 1.38 - 1.63 Lens)	21

Installation For Vision Model 40ET (With 1.83 - 2.40 Lens)	22
Throw Distance Chart For Vision Model 40ET (With 1.83 - 2.40 Lens)	23
Connecting	24
Connecting Video Inputs	25
Video / S-Video / Component (Interlaced Video)	25
Progressive Component (DTV Y/PB/PR)	26
RGBHV (DTV RGB)	27
Connecting a Computer or HDCP Compatible Video Device With DVI-I Output	28
Basic Operation	29
Turning on the Power	29
Zoom/ Focusing	30
Selecting Video Memory	30
Selecting Input Source	31
Setting Menu	31
Selecting "ASPECT RATIO"	32
PIP/ POP function	32
Turning off the Power	33
Menu	34
Using the Menu	34
Main Menu	35
Picture Quality Adjustments	35

Image Options 1	36
Input Select	36
Aspect Ratio	37
Image Option 2	38
Projector Status	39
Install	40
Service	41
White Balance	41
Blue Enable	42
Reset Lamp Timer	42
Additional Information	43
Replace the Lamp (Contact your Vidikron Dealer)	43
Troubleshooting	44
Specifications	46
Dimensions	48
RS-232 Setup	49
RS-232C Control Codes	49
PC Out Adapter	50

Vidikron Vision Model 40/ Vision Model 40ET Owner's Manual

Thank you for your purchase of this quality Vidikron video projector. It has been designed to provide you with the quality of video that is expected in a high performance home theater. For the best results, please read this manual carefully as it is your guide through the menus and operation.

Warning

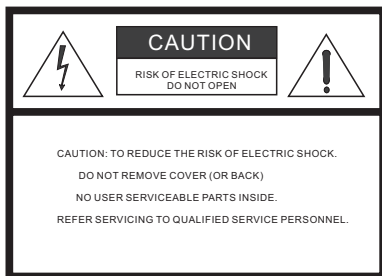

This symbol is intended to alert the user to the presence of uninsulated "dangerous voltage" within the product's enclosure that may be of sufficient magnitude to constitute a risk of electric shock.



This symbol is intended to alert the user to the presence of important operating and maintenance (servicing) instructions in the literature accompanying the appliance.

This equipment has been tested and found to comply with the limits for a Class B digital device, pursuant to Part 15 of the FCC Rules. These limits are designed to provide reasonable protection against harmful interference in a residential installation.

1. Read these instructions.
2. Keep these instructions.
3. Heed all warnings.
4. Do not use this projector near water, outdoors or otherwise exposed to the elements.
5. Clean only with a dry cloth.

6. Do not block any ventilation openings.
7. Do not install near any heat sources such as radiators, heat registers, stoves, or other apparatus (including amplifiers) that produce heat.
8. Do not defeat the safety feature of the polarized or grounding type plug. A polarized type plug has two blades with one wider than the other. A grounding type plug has two blades and a third grounding prong. The third prong is provided for your safety. If the provided plug does not fit into your outlet, consult an electrician for the replacement of the obsolete outlet.
9. Do not connect the RJ-11, RS-232 jack to a telephone line connection.
10. The 12V trigger outputs 12V DC for triggering. Do not connect to any other power input or output. This could cause damage to this unit.
11. Only use accessories specified by Vidikron.
12. Keep the packing material in case the projector should ever need to be shipped.
13. Unplug this projector during lightning storms or when it will not be used for an extended period of time.
14. The lamp becomes extremely hot during operation. Allow the projector to cool down for approximately 45 minutes prior to removing the lamp assembly for replacement. Do not operate lamps beyond the rated lamp life. Excessive operation of lamps beyond rated life could cause them to explode in rare occasions.

Refer all servicing to qualified service personnel. Servicing is required when the projector has been damaged in any way, objects have fallen or spilled into the projector, the projector has been exposed to rain or moisture, does not operate normally, or has been dropped.

Two Year Limited Warranty

Congratulations on your purchase of a Vidikron video product and welcome to the Vidikron family! With proper installation, setup and care, you should enjoy many years of unparalleled video performance.

This is a LIMITED WARRANTY as defined in the Magnuson-Moss Warranty Act. Please read it carefully and retain it with your other important documents.

WHAT IS COVERED UNDER THE TERMS OF THIS LIMITED WARRANTY:

SERVICE LABOR: Vidikron will pay for service labor by a Vidikron Authorized Service Center when needed as a result of a manufacturing defect for a period of two (2) years from the effective date of delivery to the end user (excluding the lamp).

PARTS: (Not including the lamp) Vidikron will provide new or rebuilt replacement parts for the parts that fail due to defects in materials or workmanship for a period of two (2) years from the effective date of delivery to the end user. Such replacement parts are then subsequently warranted for the remaining portion (if any) of the original warranty period.

PROJECTOR LAMP: Vidikron will pay for service labor by a Vidikron Authorized Service Center when needed as a result of a manufacturing defect for a period of six (6) months or 1000 hours, whichever comes first, from the effective date of delivery to the end user. In addition, Vidikron will provide a new or rebuilt replacement lamp for the lamp that fails due to defects in materials or workmanship for a period of six (6) months or 1000 hours, whichever comes first, from the effective date of delivery to the end user. Such replacement lamps are then subsequently warranted for the remaining portion (if any) of the original warranty period.

WHAT IS NOT COVERED UNDER THE TERMS OF THIS LIMITED WARRANTY:

This Limited Warranty only covers failure due to defects in materials and workmanship that occur during normal use and does not cover normal maintenance. This Limited Warranty does not cover cabinets or any appearance items; failure resulting from accident, misuse, abuse, neglect, mishandling, misapplication, faulty or improper installation or setup adjustments; improper maintenance, alteration, improper use of any input signal; damage due to lightning or power line surges, spikes and brownouts; damage that occurs during shipping or transit; or damage that is attributed to acts of God. In the case of remote control units, damage resulting from leaking, old, damaged or improper batteries is also excluded from coverage under this Limited Warranty.

CAUTION: THIS LIMITED WARRANTY ONLY COVERS VIDIKRON PRODUCTS PURCHASED FROM VIDIKRON AUTHORIZED DEALERS. ALL OTHER PRODUCTS ARE SPECIFICALLY EXCLUDED FROM COVERAGE UNDER THIS LIMITED WARRANTY. MOREOVER, DAMAGE RESULTING DIRECTLY OR INDIRECTLY FROM IMPROPER INSTALLATION OR SETUP IS SPECIFICALLY EXCLUDED FROM COVERAGE UNDER THIS LIMITED WARRANTY.

RIGHTS, LIMITS AND EXCLUSIONS:

Vidikron limits its obligations under any implied warranties under state laws to a period not to exceed the warranty period. There are no express warranties. Vidikron also excludes any obligation on its part for incidental or consequential damages related to the failure of this product to function properly. Some states do not allow limitations on how long an implied warranty lasts, and some states do not allow the exclusion or limitation of incidental or consequential damages. So the above limitations or exclusions may not apply to you. This warranty gives you specific legal rights, and you may also have other rights that vary from state to state.

EFFECTIVE WARRANTY DATE:

This warranty begins on the effective date of delivery to the end user. For your convenience, keep the original bill of sale as evidence of the purchase date.

IMPORTANT: WARRANTY REGISTRATION:

Please fill out and mail your warranty registration card. It is imperative that Vidikron knows how to reach you promptly if we should discover a safety problem or product update for which you must be notified.

CONTACT A VIDIKRON AUTHORIZED SERVICE CENTER TO OBTAIN SERVICE

Repairs made under the terms of this Limited Warranty covering your Vidikron video product will be performed at the location of the product, during usual working hours, providing location of product is within normal operating distance from a Vidikron Authorized Service Center. In some instances it may be necessary for the product to be returned to the Vidikron factory for repairs. If, solely in Vidikron's judgment, location of product to be repaired is beyond normal operating distance of the closest Vidikron Authorized Service Center, or the repair requires the unit be returned to the Vidikron factory, it is the owner's responsibility to arrange for shipment of the product for repair. These arrangements must be made through the selling Vidikron dealer. If this is not possible, contact Vidikron directly to locate an authorized Vidikron representative who will assist you in getting a return authorization. Vidikron will return product transportation prepaid in the United States, unless no product defect is discovered. In that instance, shipping costs will be the responsibility of the owner.

ADDITIONAL INFORMATION:

To locate the name and address of the nearest VIDIKRON authorized service location, or for additional information about this warranty, please call or write:

VIDIKRON
Attn: Customer Service Department
2900 Faber Street
Union City, CA 94587
Ph: (510) 324-5900
Fax: (510) 324-5905

1 Overview

Features

- **1280 x 720 Widescreen Native 16:9 Resolution HD-2 DMD™ Display Device**
- **Integrated Video Processing With 3:2 Pulldown**
- **950 ANSI Lumens/ 1600:1 Contrast Ratio**
- **Multiple Aspect Ratios with Intelliwide Mode**
- **HDTV Ready**

480P, 1080i and 720P (576P PAL Version) formats are all compatible with this unit (via an external DTV decoder, not provided).

- **DVI-I Input with HDCP**
- **9-Point White Balance System for Excellent Gray Scale Tracking**
- **Direct IR and RS-232 Control**
- **'Cat's Eye' Optical System for Enhanced Contrast and Black Levels**
- **Two Lens Options with Variable Throw Distances for Versatile Installation Convenience**
- **De-interlacing with 3:2 Pull-down**

Using Vidikron's proprietary de-interlacing technology, this projector provides exceptional scaling and film to video (3:2 pulldown) conversion for the most artifact-free images possible.

■ PIP/ PBP function

Picture in picture/ Picture by picture functions allow you to display two inputs on the screen at the same time.

■ Video Memory

This projector allows the user to store up to three different settings per input.

Projector Exterior View

Front / Upper Side

1. Front Lamp Cover

Remove this cover when replacing the lamp. (See page 43.)

2. Projection Lens

3. Front IR Sensor

4. Ventilation Holes (intake)

5. Ventilation Holes (exhaust)

6. Focus Ring and Zoom Ring Access

Adjusts the focus and zoom of image.

7. Control Panel

Shows lamp status and whether the projector is on or off.
For more details, see "Control Panel" on page 12.

8. Kensington Lock

This lock can withstand 150 N of force.

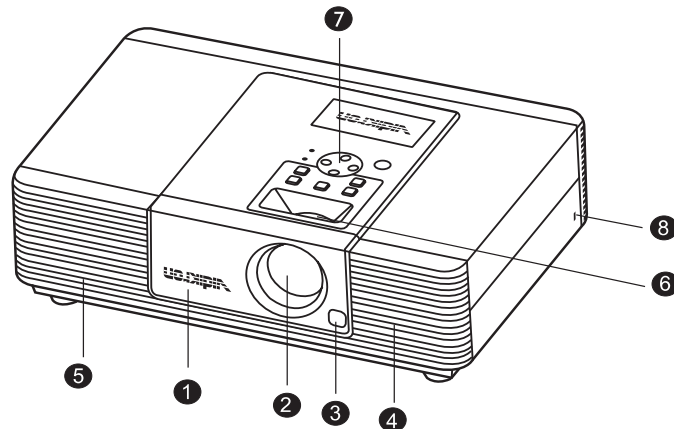

Rear / Bottom Side

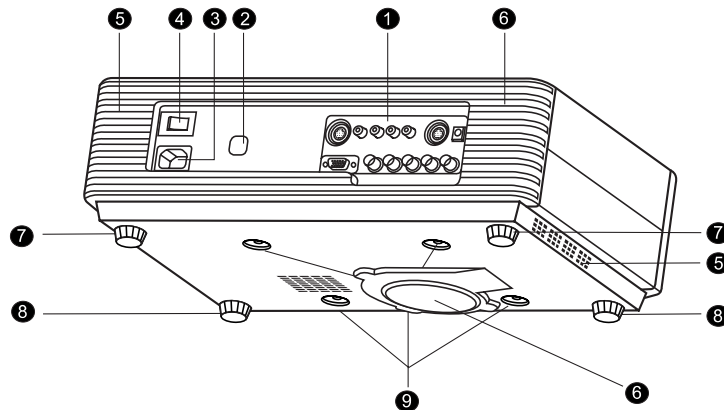
**1. Connector Panel**

For more details, see "Connector Panel" on page 14.

2. Back IR Sensor**3. AC Power IN Socket****4. AC Power Switch**

AC main power switch.

5. Ventilation Holes (exhaust)**6. Ventilation Holes (intake)****7. Rear Adjusters**

Adjusts the height or projection angle.

8. Front Adjusters

Adjusts the height or projection angle.

9. Ceiling Mount Holes

The connecting holes for ceiling mount device.

Controls and Functions

Control Panel

English

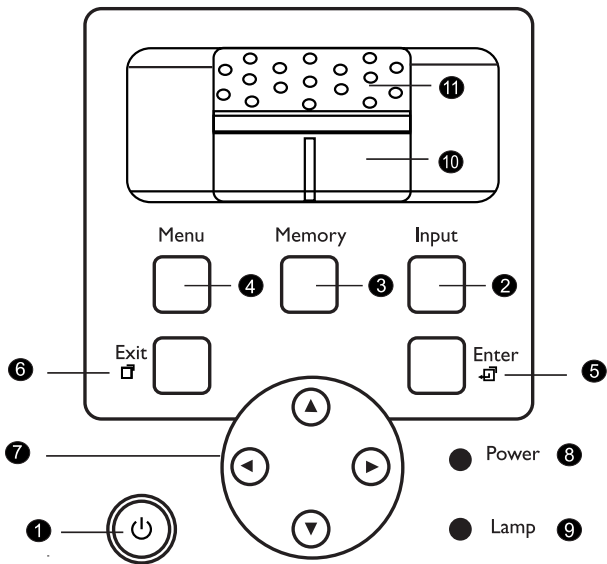

1. STANDBY/ON

Press this key for ONE second to turn on the unit when it is in the standby mode. Or press this key to turn off this unit when it is on.

2. INPUT

Switches input sources sequentially.

3. MEMORY

Sequentially recalls settings 1 ~ 3 saved to memory. (Please see "Selecting Video Memory" on page 30.)

4. MENU

Turns the on-screen display control menu on or off.

5. ENTER

Enters settings for items shown in the menu.

6. EXIT

Exits and saves the setting(s) of items in the menu.

7. ARROW (▲/◀/▼/▶)

Use to select the menu or to make various adjustments.

8. POWER LED

Indicates power status

- Lit orange when the AC power cord is plugged into the wall outlet (standby mode). Once in the standby mode, you can press the STANDBY/ON key on the projector or the ON key on the remote control for ONE second to turn on the projector.
- Lit green when the power is turned on (operational mode).
- Flashes orange for the first 30 seconds after powering up, indicating that the lamp is warming up.
- Flashes green for one minute after the projector is turned off to indicate that the lamp is cooling down.

9. LAMP LED

Indicates the status of lamp.

- Lit red when the lamp has developed a problem. Please contact your Vidikron dealer for assistance.

10. Zoom Ring

Adjusts the size of image

- Rotate clockwise to enlarge the image or rotate counterwise to make the image smaller.

11. Focus Ring

Adjust the focus of the projected images.

Connector Panel

1. Video (RCA Jack)

Composite video signal input.

2. S-Video (mini DIN 4-pin)

Y/C (S-video) signal input

3. Component (RCA Jacks)

480i Component (Y/CB/CR) video signal input

4. RGB/ HDTV (BNC) or Progressive Scan DVD players

DTV Y/PB/PR or DTV RGB video signal input.

5. DVI-I

Digital/ Analog signal input.

6. RS-232C (RJ-11 Jack)

RS-232C control signal input.

7. 12v Trigger (mini jack with the diameter of 5.5 mm outside and 2.5 mm inside)

+12V output, active when the projector is turned on.

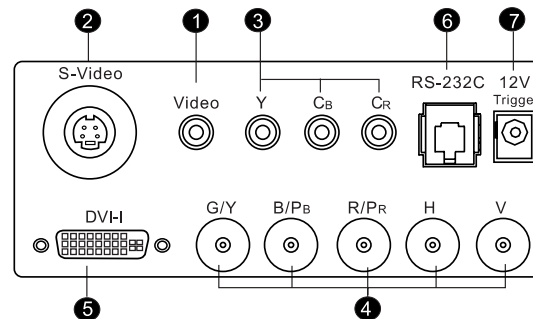

Remote Control

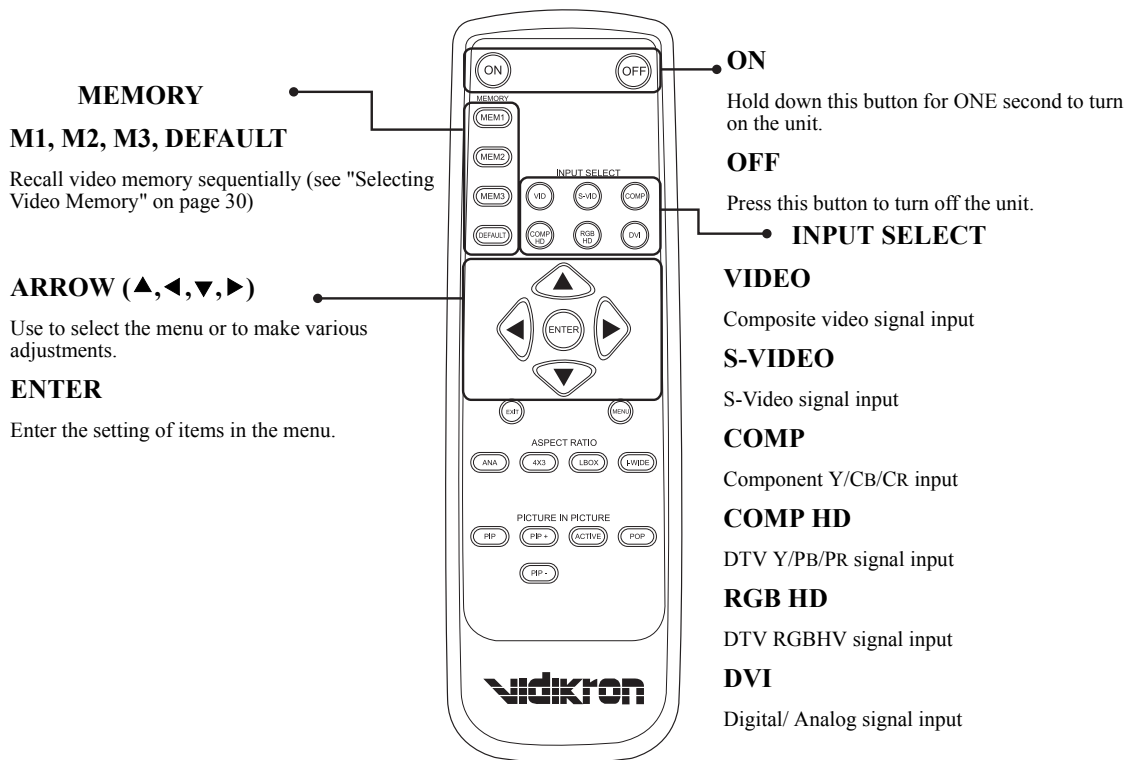

ASPECT RATIO ANAMORPHIC

For 16: 9 DVDs.

4 X 3

The input signal will be scaled to fit 4: 3 display mode in the center of screen.

LETTERBOX

Letterbox mode. Image in letter- box format is enlarged to fit 16:9 full screen display and the upper/lower portion are "blanked off".

I-WIDE (IntelliWide)

4:3 image is enlarged nonlinearly in horizontal direction to fit 16: 9 full screen display.

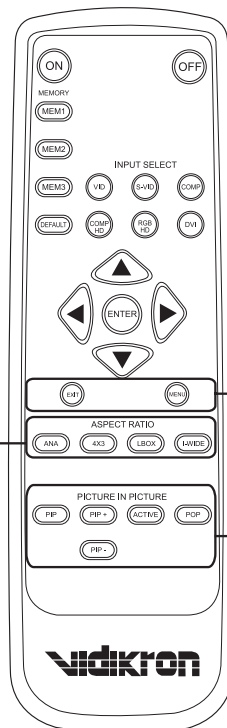

EXIT

Exit and save the setting(s) of items in the menu.

MENU

Turns on/off the on-screen display menu.

PICTURE IN PICTURE

PIP (Picture in Picture)

Enable the PIP function. Use ARROW keys to adjust the position of the PIP window (see "PIP/POP function" on page 32)

PIP+

Enlarge the size of PIP window.

PIP-

Shrink the size of PIP window.

ACTIVE

Switch to the active window in PIP display mode.

POP (Picture On Picture)

Enable the POP function.

2 Installation

Remote Control

Push down on the tab and lift to open the cover. Install the two AAA batteries with the correct polarity, then close the cover.

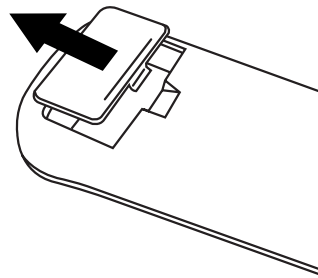

Notes on Batteries

- Make sure that the battery polarities are correct when installing the batteries.
- Do not mix an old battery with a new one or different types of batteries.
- If you will not use the remote control for a long time, remove the batteries to avoid damage from battery leakage.

Notes on Remote Control Operation

- Make sure that there is nothing obstructing the infrared beam between the remote control and the IR receiver on the projector.
- The useable range is between 3m/ 9.8 feet (from the front of the projector) and 4m/ 13.1 feet (from the top of the projector) within a 30 degree horizontal angle and 15 degree vertical angle.

Projector

Connect the Power Cord

Plug the supplied power cord into the AC inlet in the rear of this unit. (AC 100V ~ 240V)

Turn on the main power switch on the rear of this unit (next to the AC inlet). The POWER LED will light up in orange. Press ON key on the remote control for ONE second to turn on the unit.

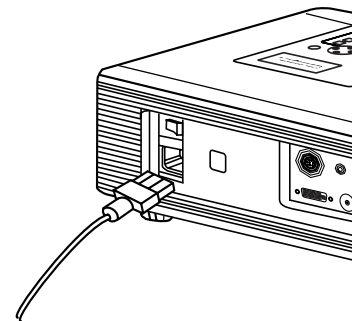

Adjust the Lens Zoom/Focus ring

Adjust the projected image size you need with the zoom ring on the lens.

To focus the image, rotate the focus ring on the lens.

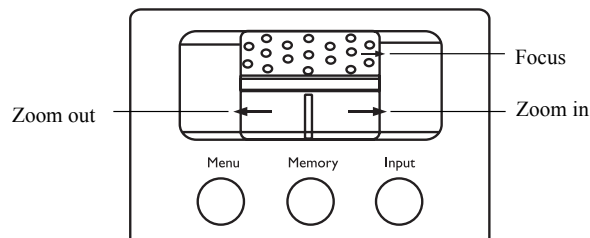

Adjust the height

There are 4 screw adjusters on the bottom of this unit. You can adjust the height or projection angle of this unit by using these adjusters.

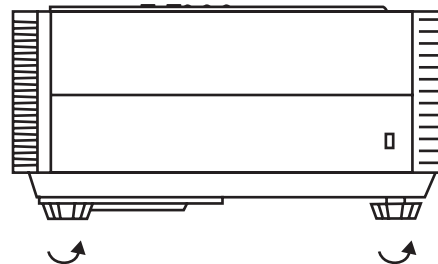

Installation For Vision Model 40 (With 1.38 - 1.63 Lens)

English

Ceiling

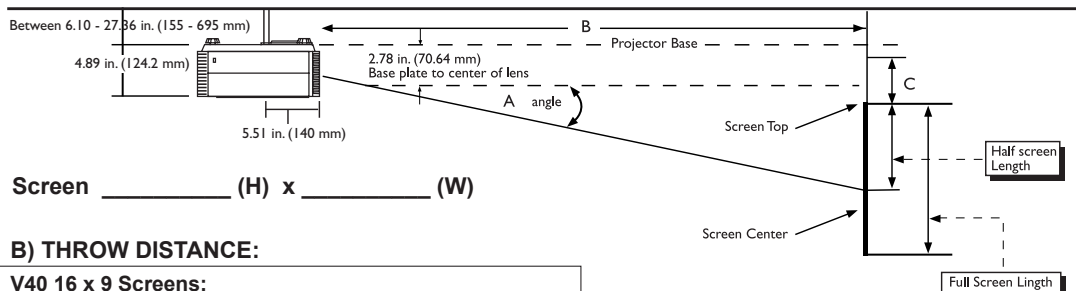

Screen _____ (H) x _____ (W)

B) THROW DISTANCE:

V40 16 x 9 Screens:

Minimum: (screen width x 1.38) = _____ inches

Maximum: (screen width x 1.63) = _____ inches

C) VERTICAL OFFSET:

Screen width x 0.052 = _____ inches from the center of the lens.

Floor

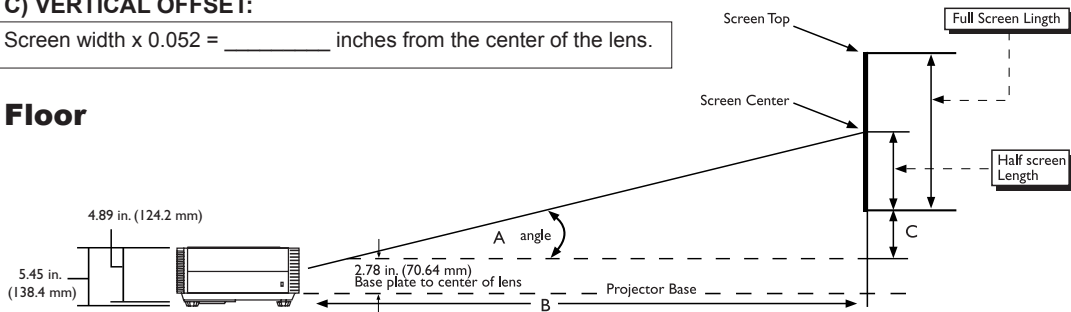

Throw Distance Chart For Vision Model 40 (With 1.38 - 1.63 Lens)

Vision Model 40 @ 1280 x 720

Screen Height	Screen Width	Min Throw Distance	Max Throw Distance	Vertical Offset Position
40.5	72	99.36	117.36	3.74
43	77	106.26	125.51	4.00
45	80	110.40	130.40	4.16
47	84	115.45	136.37	4.35
49	87	120.06	141.81	4.52
50	89	122.82	145.07	4.63
51.5	92	126.96	149.96	4.78
52	93	128.34	151.59	4.84
54	96	132.48	156.48	4.99
56	100	138.00	163.00	5.20
58	103	142.14	167.89	5.36
58.5	104	143.52	169.52	5.41
60	107	147.66	174.41	5.56
61	109	150.42	177.67	5.67
63	112	154.56	182.56	5.82
65	116	160.08	189.08	6.03
67.5	120	165.60	195.60	6.24
72	128	176.64	208.64	6.66
80	142	195.96	231.46	7.38
82	146	201.48	237.98	7.59
90	160	220.80	260.80	8.32
Screen Hight	Screen Width	Min TD	Max TD	Vertical Offset
		(SWx1.38)	(SWx1.63)	Screen Width x 0.052

Installation For Vision Model 40ET (With 1.83 - 2.40 Lens)

Ceiling

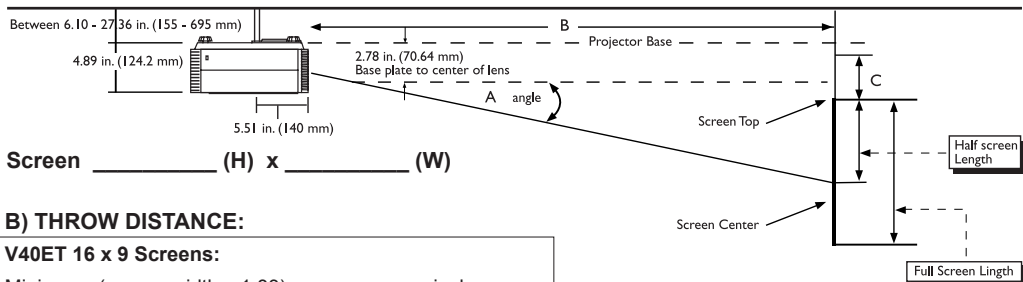

Screen _____ (H) x _____ (W)

B) THROW DISTANCE:

V40ET 16 x 9 Screens:

Minimum: (screen width x 1.83) = _____ inches

Maximum: (screen width x 2.40) = _____ inches

C) VERTICAL OFFSET:

Two inches offset means that the center of the projection lens is 2" above the top of the screen (inverted ceiling) or 2" below the bottom of the screen (upright floor mount).

Floor

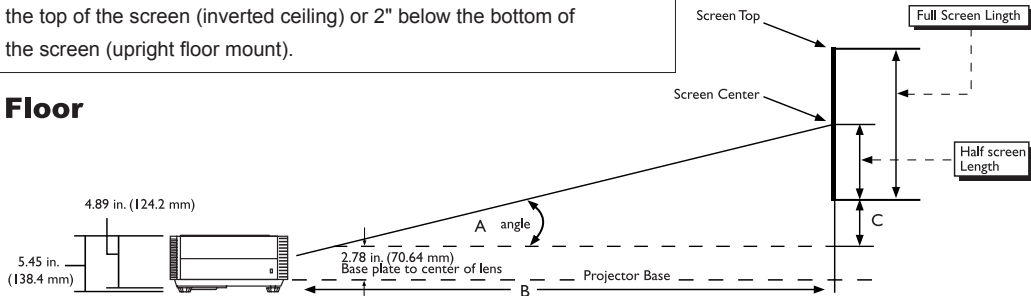

Throw Distance Chart For Vision Model 40ET (With 1.83 - 2.40 Lens)

Vision Model 40ET @ 1280 x 720

Screen Height	Screen Width	Min Throw Distance	Max Throw Distance	Vertical Offset Position
40.5	72	131.76	172.80	2.0"
43	77	140.91	184.80	2.0"
45	80	146.40	192.00	2.0"
47	84	153.10	200.78	2.0"
49	87	159.21	208.80	2.0"
50	89	162.87	213.60	2.0"
51.5	92	168.36	220.80	2.0"
52	93	170.19	223.20	2.0"
54	96	175.68	230.40	2.0"
56	100	183.00	240.00	2.0"
58	103	188.49	247.20	2.0"
58.5	104	190.32	249.60	2.0"
60	107	195.81	256.80	2.0"
61	109	199.47	261.60	2.0"
63	112	204.96	268.80	2.0"
65	116	212.28	278.40	2.0"
67.5	120	219.60	288.00	2.0"
72	128	234.24	307.20	2.0"
80	142	259.86	340.80	2.0"
82	146	267.18	350.40	2.0"
90	160	292.80	384.00	2.0"
Screen Hight	Screen Width	Min TD	Max TD	Vertical Offset
		(SWx1.83)	(SWx2.40)	2.00"

 Two inches offset means that the center of the projection lens is 2" above the top of the screen (inverted ceiling) or 2" below the bottom of the screen (upright floor mount).

3 Connecting

When connecting, make sure to:

1. Turn off all equipment before making any connections.
2. Use the correct signal cables for each source.
3. Ensure the cables are firmly connected.

Connecting Video Inputs

Video / S-Video / Component (Interlaced Video)

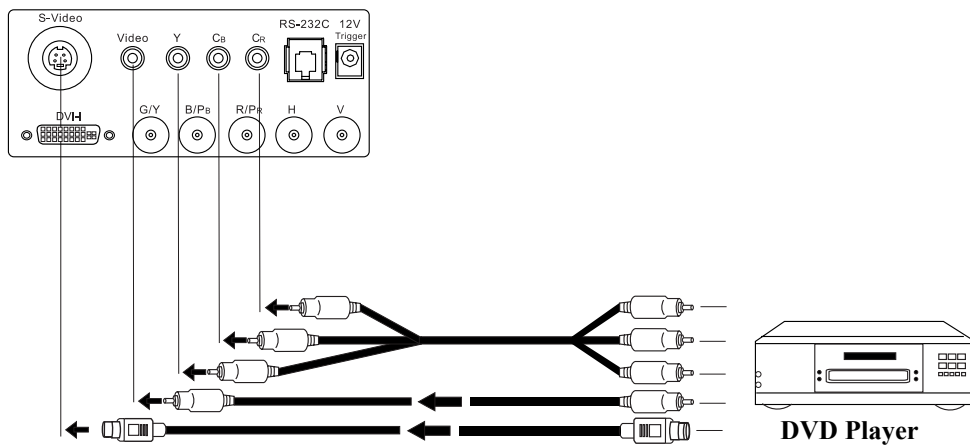

Progressive Component (DTV Y/PB/PR)

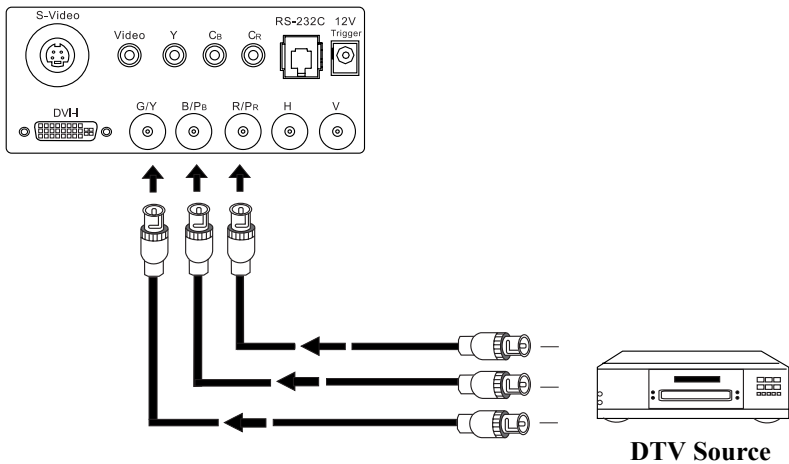

RGBHV (DTV RGB)

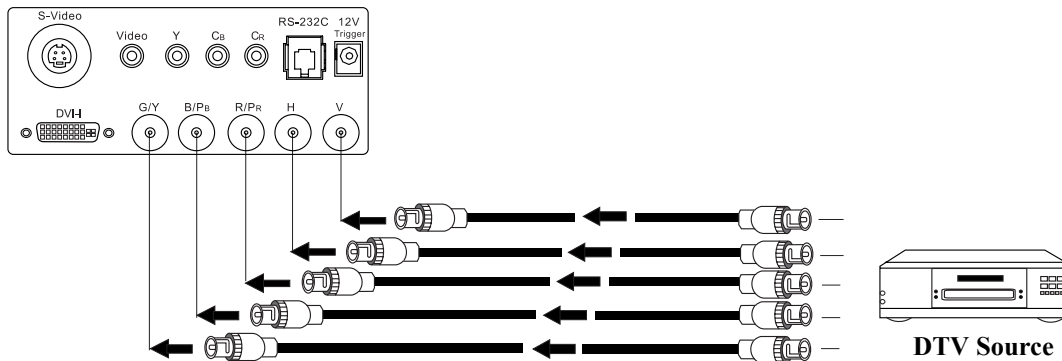

The RGB BNC input supports two kinds of HDTV formats: Progressive component (DTV Y/Pb/Pr) and DTV RGB. The unit will detect the resolution automatically.

Connecting a Computer or HDCP Compatible Video Device With DVI-I Output

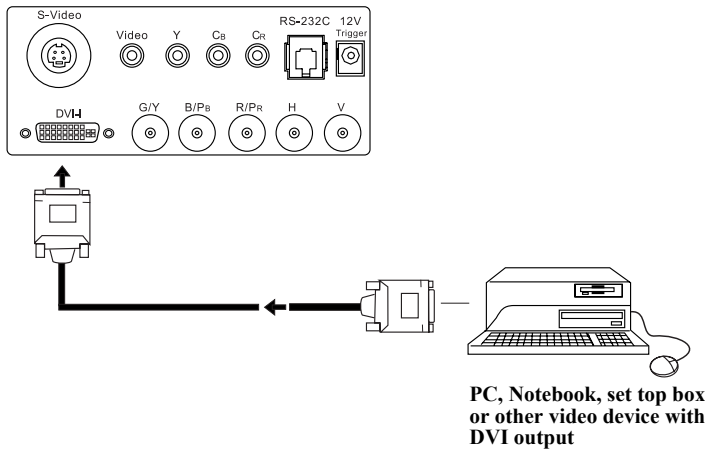

This unit is compatible with the following computer resolutions: 1280x720, 1024x768, 800x600, 640x480.

4 Basic Operation

Turning on the Power

- The Power LED lights orange when power is applied and the power switch is turned on.
- Press and hold the **ON** key on the remote control or the Power key on the projector for **ONE** second to turn on the unit. The POWER LED will blink orange during warm up period, then light solid green.
- " Searching...." will be displayed on the screen before the projector identifies the input signal. This message will remain on the screen until a valid signal is detected.
- If an incompatible input signal exceeds the range of the projector a "Not supportive timing" message will be displayed on the screen. This message will remain on the screen until you change the input signal.

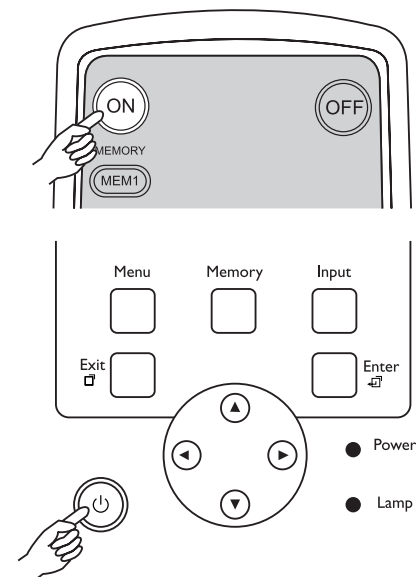

Zoom/ Focusing

- Adjust the projection image size you need with the zoom ring on the lens. To focus the image, rotate the focus ring on the lens.

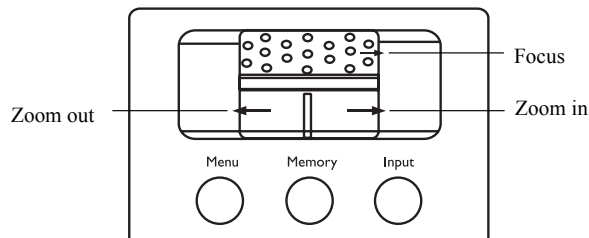

Selecting Video Memory

- Press **MEM1**, **MEM2**, **MEM3** buttons to recall settings in the memory.
- Press **DEFAULT** to select the default setting.

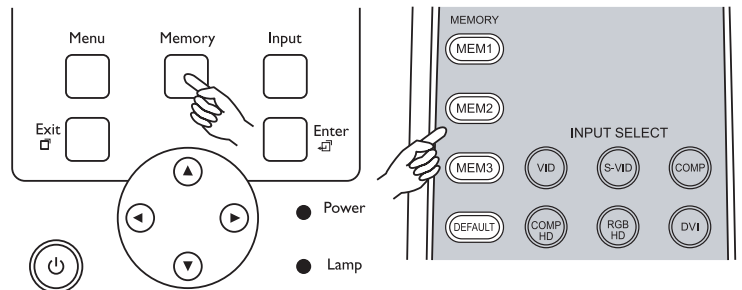

Selecting Input Source

- When this unit is turned on, it will search for the input source you last selected.
- You may select the input source directly on the remote control.

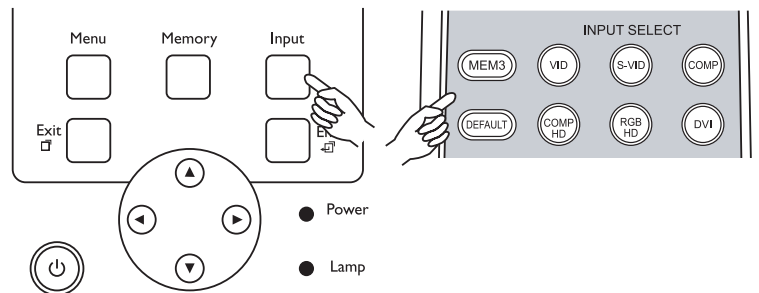

Setting Menu

- Press the **Menu** button to turn on /off the on-screen menu.
- Use the ARROW buttons (▲, ◀, ▼, ▶) to select the menu or to make various adjustments.
- Press the **Enter** or ▶ button to enter the setting of items in the menu, or press the **Exit** button to leave and save the setting of items in the menu.
- For more detailed settings, see Chapter 5 Menu on page 34.
- Press **Picture** to access the picture setting menu.

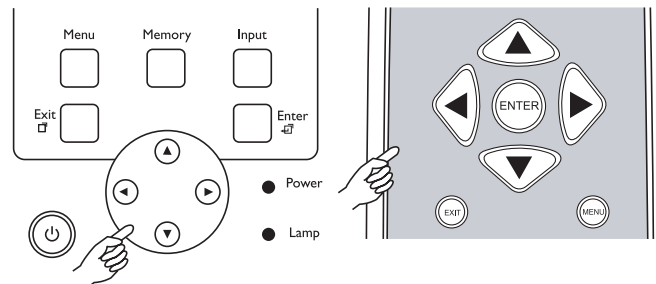

Selecting "ASPECT RATIO"

- Select the proper aspect ratio according to the content being used. There are four aspect ratios for choice.
 - **ANAMORPHIC**: The image is compressed vertically, but anamorphic software will appear properly proportioned. This is best suited for use with 16:9 DVD's.
 - **4 X 3**: The input signal will be scaled to fit 4 : 3 display mode in the center screen.
 - **LETTERBOX**: Image in letterbox format is enlarged to fit 16:9 full screen display and the upper/lower portion are cropped.
 - **I-WIDE**: This transforms a 4x3 image to a 16x9 image.

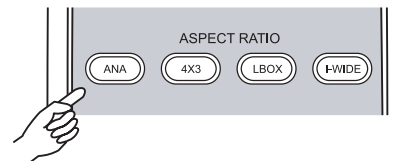

PIP/ POP function

- Press the **PIP** button to enable the PIP function.
- For PIP purposes, there are two groups of inputs separated by their display modes:
 - Video Group: Video, S-Video and Component Y/CB/CR inputs
 - Graphic Group: HDTV input and Computer input.
- The PIP can show one input from the Graphic Group within one input from the Video Group, or show one input from Video Group within one input from the Graphic Group.
- Press the **PIP** button to switch to the main window or turn off PIP function.
- Select the input source of the main window by pressing the INPUT button.
- Press the **ACTIVE** button to switch to the active window. You can change the input signal setting in the active window.
- Press **PIP+** or **PIP-** to adjust the size of PIP window.
- Adjust the position of the PIP window with the ARROW keys (▲, ◀, ▼, ▶).
- Press **POP** to enable the POP function.

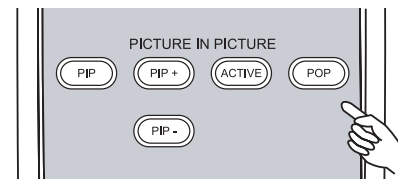

Turning off the Power

- Press the **OFF** key on the remote control to turn off the unit.
- The **POWER LED** will blink green and the fans will speed up for a quick cool down. The projector will not respond to any command for 90 seconds.
- The **POWER LED** will light solid orange once the cooling down cycle has completed.
- Fans will run for three minutes to cool.
- You may turn the projector back on after the first 90 seconds.

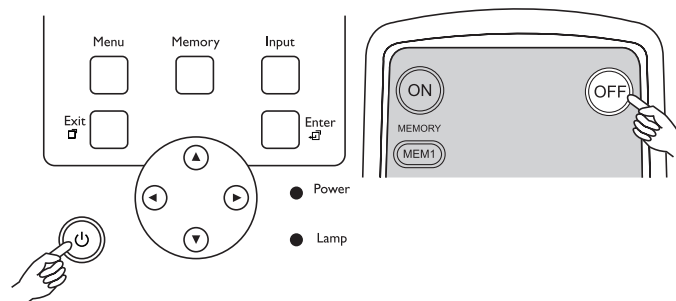

5 Menu

Using the Menu

This unit is equipped with an on-screen display (OSD) menu for making various adjustments and settings.

There are five different menu languages; see page 40 Language setting for more details.

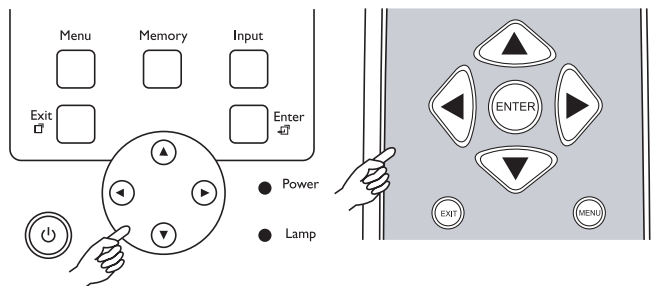

- Press the **Menu** button to turn on /off the on-screen display menu.
- Use the **ARROW** buttons (▲, ◀, ▼, ▶) to select the menu or to make various adjustments.
- Press the **Enter** or ▶ button to enter the setting of items in the menu, or press the **Exit** button to leave and save the setting of items in the menu.

Main Menu

When the **Menu** button is pressed on the remote control, the main menu will appear on-screen. An example of the main menu is shown right. Use **▲** or **▼** button to move the item you want to choose and then press the **Enter** or **▶** button.

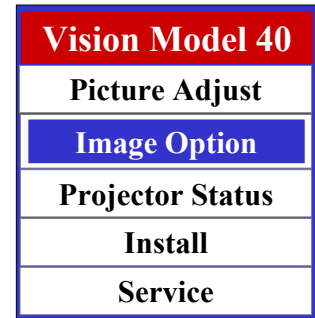

Picture Quality Adjustments

To access the picture quality adjustments, press **Menu**, highlight **Picture Adjust** and press **Enter** or **▶**. The picture adjust sub-menu will then appear (see above).

To make an adjustment to a particular function, highlight the function with the **▲** or **▼** arrow button and press **Enter** or **▶** to activate a scroll bar for that adjustment. When all the settings are done, press **Exit** to leave the current submenu and then go to **Image options** --> **Memory Store** for saving the values as Memory 1, Memory 2 or Memory 3.

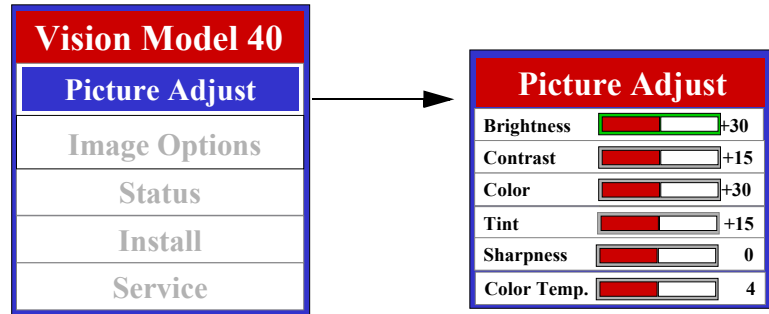
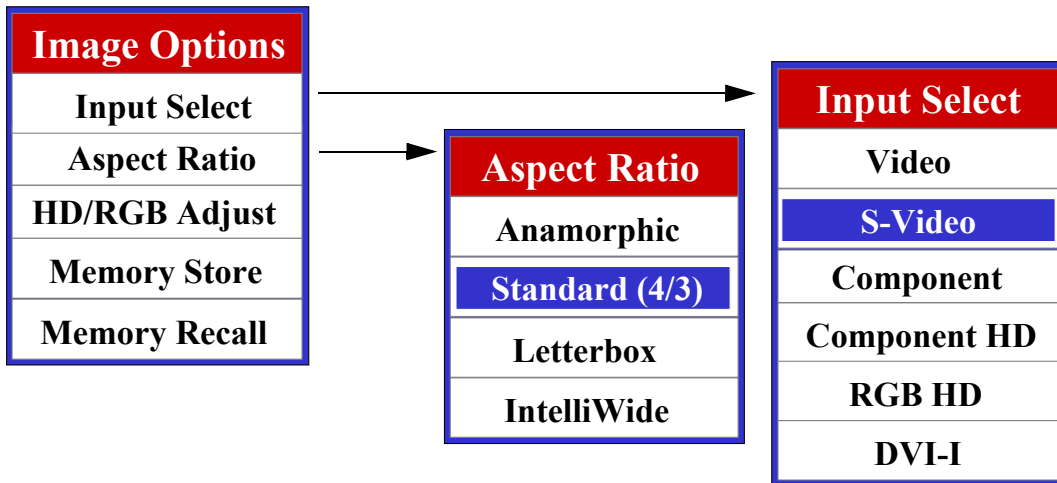

Image Options 1



Input Select

From **Input Select** submenu, you are free to choose one of the 6 input sources as long as you are sure the projector is connected with the correct signal cables. In the example above, S-Video is the current source.

Aspect Ratio

There are four aspect ratios available that can be selected for video signal inputs.

16:9 Screens:

- Anamorphic: The image is compressed vertically, but anamorphic software will appear properly proportioned. This is best suited for use with 16:9 DVD's.
- Standard (4/3): The input signal will be scaled to fit in the center of the 16:9 screen.
- Letterbox: The image in the Letterbox mode will be zoomed in, and the top and bottom portion 'blanked off'. This ratio is best suited for LaserDisc movies or non-anamorphic DVD's.
- I-WIDE: A 4:3 image is transformed into a 16:9 image.

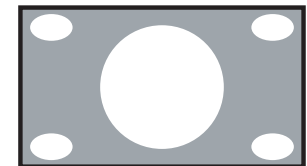
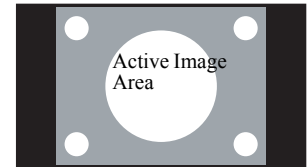
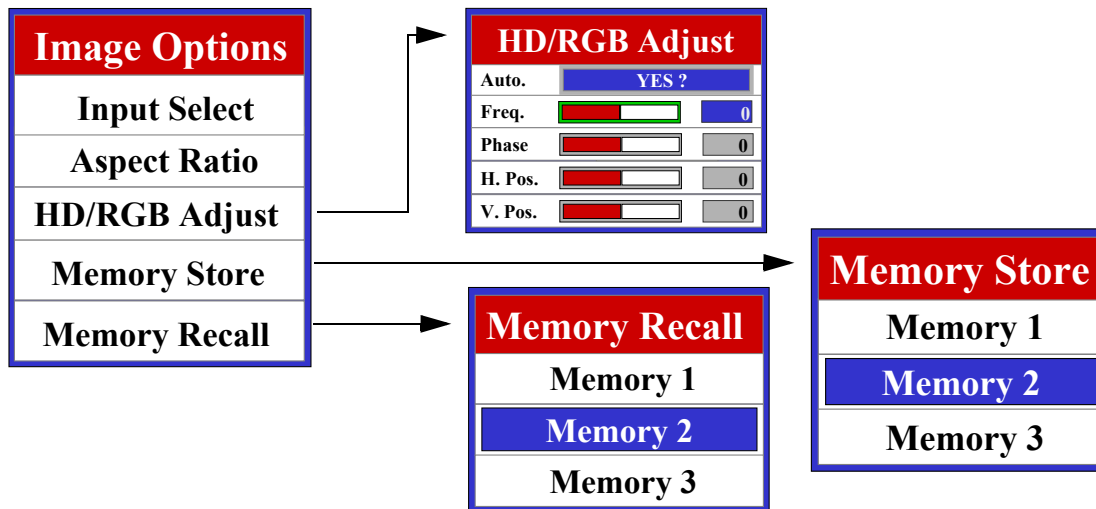

Image Option 2



HD/RGB Adjust.: The following settings are only available with a PC or DTV RGB signal. There is no position adjustment when using DVI-D signal.

- **AUTO:** Adjusts the phase, frequency and position automatically.
- **Freq.:** Adjusts the frequency of the signal.
- **Phase:** Adjusts the phase of the input signal.
- **H. Pos.:** Adjusts the horizontal position of the image.
- **V. Pos.:** Adjusts the vertical position of the image.

To enter into the memory selection menus, use **Memory Store** and **Memory Recall** menus to save and load up to three different memories. There are three memories: Memory 1, Memory 2 and Memory 3.

Projector Status

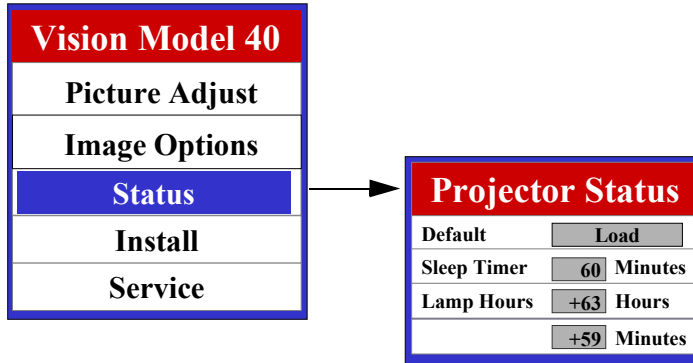

Default: Use this function to reset all values of the current source back to factory default.

Sleep Timer: To setup auto off timer. The setting timer is from 10 minutes to 3 hours.

Lamp Hours: To check for total time of lamp usage.

Install

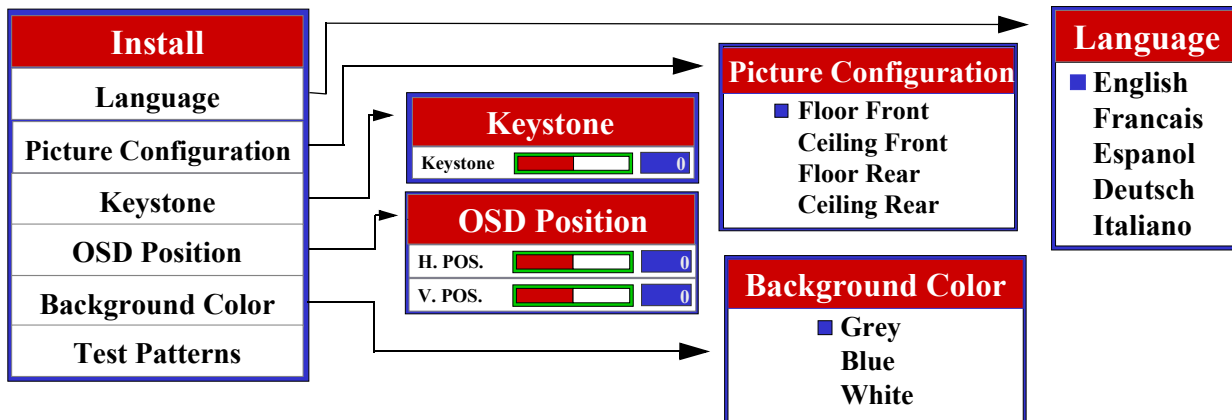

Press **Enter** on selected feature to open the **Install** menu.

Language: There are 5 different menu languages available: English, French, Spanish, German and Italian.

Picture Orientation: The projector can be installed on a ceiling or in a rear screen configuration with one or more mirrors. There are four settings: FLOOR FRONT, CEILING FRONT, FLOOR REAR, and CEILING REAR.

Keystone: Corrects the trapezoidal distortion as a result of the angle of projection ($-12^{\circ} \sim +12^{\circ}$). This can correct for up to ± 12 degrees of offset.

OSD Position: To adjust horizontal and vertical positions of the OSD.

Background Color: To select the background color while there is no input signal detected.

Test Patterns: Highlight and press **Enter** or the right arrow key to display the cross-coarse pattern.

Service

The **Service** menu is passcode protected and for use by Vidikron personnel only. Many of the adjustments available in this section are intended for use by trained service personnel only. If you are having difficulty with one of these items, please contact your Vidikron Dealer for service.

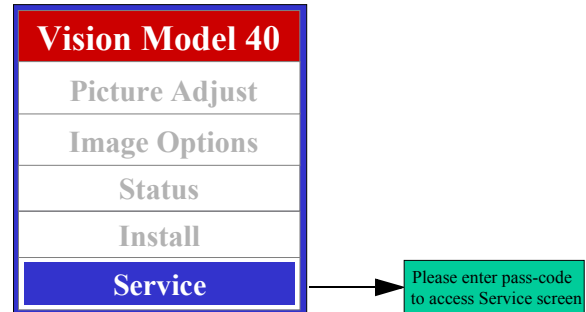

White Balance

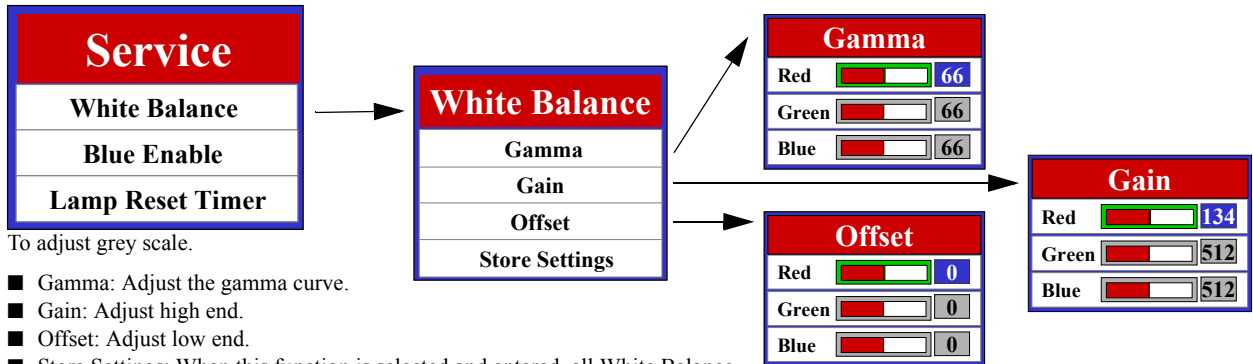

To adjust grey scale.

- Gamma: Adjust the gamma curve.
- Gain: Adjust high end.
- Offset: Adjust low end.
- Store Settings: When this function is selected and entered, all White Balance settings will automatically be stored in Color Temp. 4 (Custom Temperature).

Blue Enable

This mutes the red and green image.

Use this function in combination with the external color bar pattern to adjust for proper color and tint settings without using a blue filter.

 To quickly exit this function, select any other color temperature in the same adjustment window and return to the original temperature setting or simply select another input source from the remote control and then return to the original selected source.

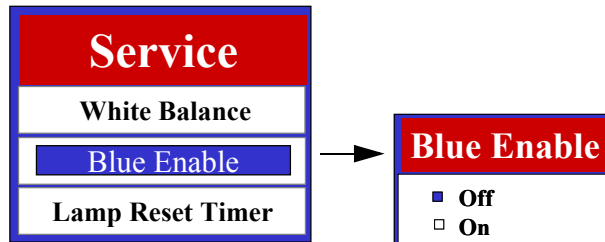

Reset Lamp Timer

Use this function to reset lamp usage counter. Reset only if you replace the lamp.

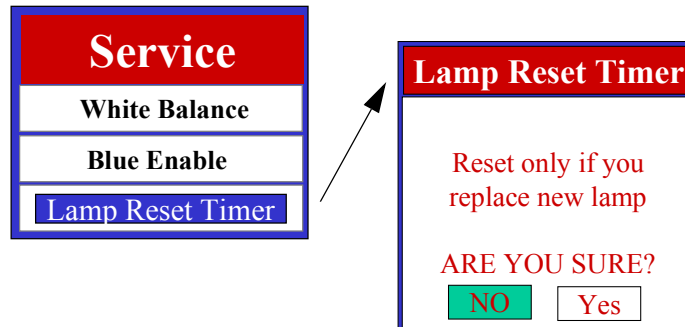

6 Additional Information

Replace the Lamp (Contact your Vidikron Dealer)

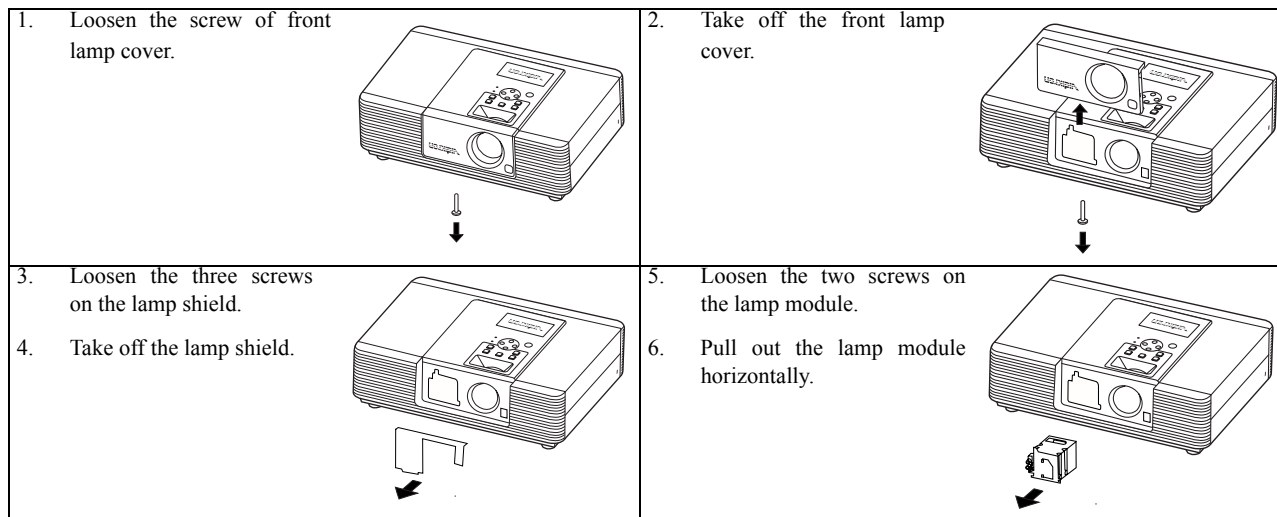

<p>7. Insert the new lamp module into the projector horizontally until it is securely in place.</p> <p>8. Tighten the two screws on the lamp module.</p>	<p>9. Put on the lamp shield.</p> <p>10. Tighten the three screws on the lamp shield.</p>
<p>11. Put on the front lamp cover.</p> <p>12. Tighten the screw of front lamp cover.</p>	<p>13. Turn on the power and go into the Service menu, select Lamp Reset Timer item to reset lamp usage counter.</p>

Troubleshooting

Problem	Possible Cause	Remedy
<p>This unit does not turn on.</p>	<p>There is no power from power cable.</p>	<p>Plug the power cord into the AC inlet on the rear of this unit, and plug the power cord into to the power outlet.</p>
	<p>The power switch is not turned on.</p>	<p>Turn on the power switch.</p>
	<p>Turned on this unit again while still in the cooling down procedure.</p>	<p>Wait until this unit completes the cooling down procedure.</p>
	<p>The front lamp cover is not correctly attached.</p>	<p>Correctly attach the front lamp cover.</p>

No picture	This unit is not correctly connected to the input source device.	Check the connection.
	The input signal has not been correctly selected.	Select the correct input signal with the input keys: Video, S-Video, Component, Component HD, RGB HD and DVI-I on the remote control.
	POWER LED or LAMP LED blinking.	Please contact your Vidikron dealer for assistance.
Image is unstable	The connection cables are not connected to this unit.	Correctly connect the cables to the appropriate terminals.
Picture is blurred	The projection lens is not correctly focused.	Adjust the focus of projection lens with the focus ring.
	This unit and the screen are not aligned squarely.	Adjust the projection angle and direction, and the height of this unit.
Remote control does not work correctly	The batteries are exhausted.	Replace both batteries with new ones.
LAMP LED blinks in red	The front lamp cover is not correctly attached.	Correctly attach the front lamp cover.
	The cooling fan does not work properly.	Please contact your Vidikron dealer for assistance.
	The temperature inside this unit is extremely high.	Check that the ventilation holes are not blocked.
POWER LED blinks in orange and green sequentially	The lamp has exceeded its estimated life.	Replace the lamp with a new one.
	The lamp has burned out.	Replace the lamp with a new one.

Specifications

Vision Model 40/ Vision Model 40ET Specifications

Projector Type

Digital Light Processing™ (DLP™), Single HD-2 DMD™ Chip

Native Resolution

1280 x 720, (16:9)

Aspect Ratios

4:3, Letterbox, 16:9, Anamorphic, IntelliWide

Video Standards

NTSC, PAL

Throw Distance

V40: 1.38 to 1.63 / V40ET: 1.83 to 2.40

(Factor x Screen Width): Please refer to page 20 to page 23.

Light Output

CSMS** Specifications:

Home Theater Calibration:

480 ANSI Lumens, 17.9 Foot-Lamberts (fL)

850 ANSI Lumens*

Contrast Ratio

CSMS** Contrast Ratio: 148:1

1600:1 ANSI

Lamp

210W

Estimated Lamp Life

2000 hours @ 6500° Kelvin

DTV Compatibility

480p, 720p, 1080i

Memories

21 memories

Inputs

(1) Composite Video, (1) S-Video,

(1) RGB/Component (via BNC),

(1) RCA Component Video,

(1) DVI-I w/ HDCP, (1) RS-232

Scan Frequency:

Horizontal 15-80 kHz, Vertical: 50-100 Hz

Picture Size (16:9 Screen)

Recommended Width: 72-96 in., Maximum Width: 200 in.

12V Output

Max. 250 Amp, active when the projector is on

Power Requirements

100-240V AC, 50/60 Hz, 320 watts

Operating Environment

40°- 95° F, (5°- 35° C), 20%-80% Humidity (non-condensing)

Dimensions (w/out feet)

Width: 15.8 in. (400 mm),

Depth: 11 in. (280 mm),

Height: Without feet 4.9 in. (125.41 mm)

with feet 5.18 in. (131.5 mm)

Weight: 17.5 lbs. (7.8 kg) (includes lens)

Regulatory Approvals

UL, FCC, CE, C-Tick

Limited Warranty:

Projector: (2) Two year parts and labor from the date of delivery to the end user

Lamp Warranty: (6) six months or 1000 hours

***ANSI Lumen specification:**

This is the typical projector luminosity (brightness) specification found in most sales literature. This measurement is included in Vidikron literature to allow for direct comparison with other manufacturer's projectors. These measurements can be taken at 9,000 to 13,000 degree Kelvin to get expected performance data when the projector is used in professional, commercial, and industrial displays.

****CSMS Home Theater Calibration ANSI Lumen Specification:**

These measurements are taken from the projector as setup in a home theater environment. The projector is calibrated to ISF specifications including setting the color temperature to 6500 degree Kelvin, the standard for reproducing video.

****CSMS Home Theater Calibration foot-Lambert (fL) Specification:**

This is the unit of measurement used in commercial movie theaters to express image brightness. The Society of Motion Picture and Television Engineers (SMPTE) specifies 16 fL as the target image brightness for film-based projectors using an open gate (without film in the projector). More importantly, today SMPTE specifies 12 fL as the target image brightness in Digital Cinema theaters using DLP™ technology. The foot-Lambert is dependant on screen size, screen gain, and projector light output.

All measurements are made at Vidikron to ANSI/NAPM IT7.228-1997 specifications using the Photo Research PR-650 SpectraColorimeter and Minolta LS-100 Light Meter, *Video Essentials* test DVD, and a Stewart Filmscreen StudioTech 130, 1.3 gain, 72-inch wide screen. The projector is calibrated to a color temperature of 6500° Kelvin and has a minimum of 150 hours of usage.

Dimensions

English

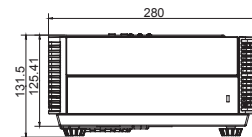
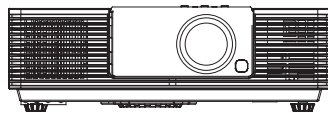
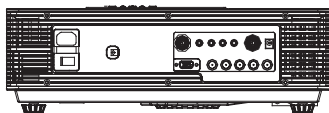
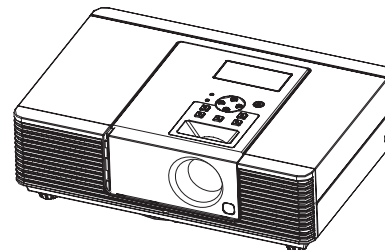
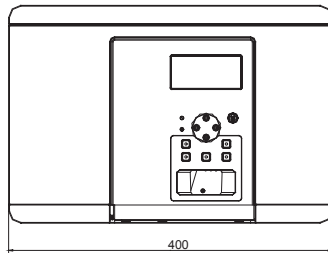
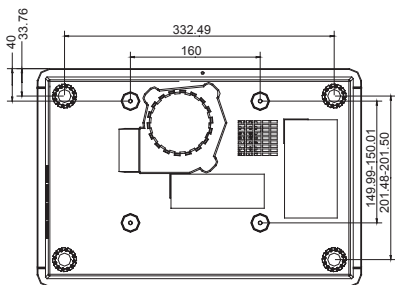

Unit: mm

RS-232 Setup

Baud Rate: 115200 or 9600

Parity: None

Data Bits: 8 Bits

Stop Bits: 1 Bit

Flow Control: None

RS-232C Control Codes

Code	Function	X23	Switch to DVI_PC input	X56	Picture in picture display
X01	Power On	X24	Switch to YPBPR input	X57	Picture by picture display
X02	Power Off	X25	Switch to BNC_PC input	X60	Switch language - English
X03	Message On	X35	Anamorphic	X61	Switch language - French
X04	Message Off	X36	Standard	X62	Switch language - Spanish
X10	Menu (arrow key)	X37	Letter box	X63	Switch language - German
X11	Enter (arrow key)	X38	I-WIDE	X64	Switch language - Italian
X12	Exit (arrow key)	X40	Load memory 1 settings	X85	Graphic Input - auto
X13	Up (arrow key)	X41	Load memory 2 settings	X90	Image orientation - floor front
X14	Down (arrow key)	X42	Load memory 3 settings	X91	Image orientation - ceiling front
X15	Left (arrow key)	X46	Load default of current source	X92	Image orientation - floor rear
X16	Right (arrow key)	X47	Save memory 1 settings	X93	Image orientation - ceiling rear
X20	Switch to Composite input	X48	Save memory 2 settings	X94	Back light on
X21	Switch to S-Video input	X49	Save memory 3 settings	X95	Back light off
X22	Switch to Component input	X55	Switch active source		

PC Out Adapter

1. 1. Connect D-Sub 9-pin female to RJ-11 adapter (not included) to Com port on PC.
2. 2. Connect RJ-11 to Projector.

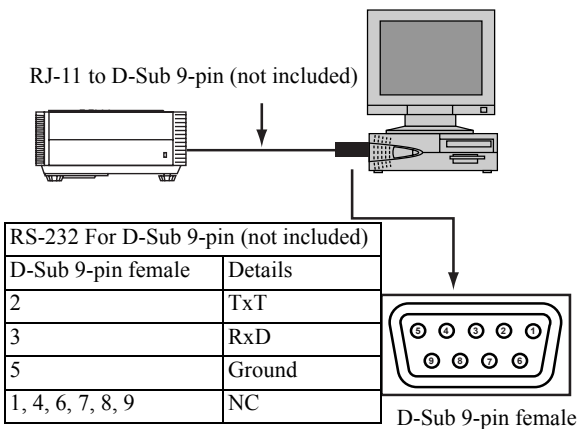

RS-232 For RJ-11 (not included)	
4-pin RJ-11	Details
2	TxT
3	RxD
1, 4	Ground

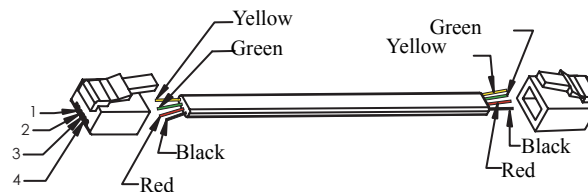

NOTE:

1. All codes are in the ASCII format.
2. A carriage return is required after each command.

Warning: During initial turn on and turn off of the projector, this unit will not accept RS-232 codes for 20 seconds.

Free Manuals Download Website

<http://myh66.com>

<http://usermanuals.us>

<http://www.somanuals.com>

<http://www.4manuals.cc>

<http://www.manual-lib.com>

<http://www.404manual.com>

<http://www.luxmanual.com>

<http://aubethermostatmanual.com>

Golf course search by state

<http://golfingnear.com>

Email search by domain

<http://emailbydomain.com>

Auto manuals search

<http://auto.somanuals.com>

TV manuals search

<http://tv.somanuals.com>