

VISION MODEL 140/150



1080p LightAmp™ Digital Projector

Vision 140

Vision 140/CineWide™

Vision 140/CineWide™ with AutoScope™

Vision 150

Vision 150/CineWide™

Vision 150/CineWide™ with AutoScope™

TWO YEAR LIMITED WARRANTY

For Projectors, Video Processors and Controllers

from Vidikron, a business of Runco International, LLC (“Vidikron”)

Congratulations on your purchase of a Vidikron video product and welcome to the Vidikron family! With proper installation, setup and care, you should enjoy many years of unparalleled video performance.

This is a LIMITED WARRANTY as defined in the Magnuson-Moss Warranty Act. Please read it carefully and retain it with your other important documents.

WHAT IS COVERED UNDER THE TERMS OF THIS LIMITED WARRANTY:

The following Vidikron product models are covered under this Limited Warranty:

Vision 140, Vision 140/CineWide, Vision 140/CineWide with AutoScope, Vision 150, Vision 150/CineWide and Vision 150/CineWide with AutoScope (“Product” individually and “Products” collectively).

SERVICE LABOR: Vidikron will pay for service labor at an Authorized Service Center when needed as a result of manufacturing defect for a period of two (2) years from the date of delivery to the initial end user (excluding the lamp).

PARTS (not including the lamp): Vidikron will provide new or rebuilt replacement parts for the parts that fail due to defects in materials or workmanship for a period of two (2) years from the effective date of delivery to the initial end user. Such replacement parts are then subsequently warranted for the remaining portion (if any) of the original warranty period.

PROJECTOR LAMP: Vidikron will pay for service labor at an Authorized Service Center when needed as a result of a manufacturing defect for a period of six (6) months or 1000 hours, whichever comes first, from the effective date of delivery to the initial end user. In addition, Vidikron will provide a new or rebuilt replacement lamp for the lamp that fails due to defects in materials or workmanship for a period of six (6) months or 1000 hours, whichever comes first, from the effective date of delivery to the initial end user. Such replacement parts are then subsequently warranted for the remaining portion (if any) of the original warranty period.

WHAT IS NOT COVERED UNDER THE TERMS OF THIS LIMITED WARRANTY:

This Limited Warranty only covers failure due to defects in materials and workmanship that occur during normal use and does not cover normal wear and tear nor any Product on which the serial number has been defaced, modified, or removed. This Limited Warranty does not cover: cabinets or any appearance items; failure resulting from accident, misuse, abuse, neglect, mishandling, misapplication, or faulty or improper installation or setup adjustments; improper maintenance; alteration; improper use of any input signal; damage due to lightning or power line surges, spikes and brownouts; damage that occurs during shipping or transit; damage that is attributed to acts of God; customer caused defects; or rental costs incurred due to Product failure. In the case of remote control units, damage resulting from leaking, old, damaged or improper batteries is also excluded from coverage under this Limited Warranty.

CAUTION: THIS LIMITED WARRANTY ONLY COVERS VIDIKRON PRODUCTS PURCHASED FROM AUTHORIZED VIDIKRON DEALERS. ALL OTHER PRODUCTS ARE SPECIFICALLY EXCLUDED FROM COVERAGE UNDER THIS WARRANTY. MOREOVER, DAMAGE RESULTING DIRECTLY OR INDIRECTLY FROM IMPROPER INSTALLATION OR SETUP IS SPECIFICALLY EXCLUDED FROM COVERAGE UNDER THIS LIMITED WARRANTY. IT IS IMPERATIVE THAT INSTALLATION AND SETUP WORK BE PERFORMED ONLY BY AN AUTHORIZED VIDIKRON DEALER TO PROTECT YOUR RIGHTS UNDER THIS WARRANTY. THIS WILL ALSO ENSURE THAT YOU ENJOY THE FINE PERFORMANCE OF WHICH YOUR VIDIKRON PRODUCT IS CAPABLE WHEN INSTALLED AND CALIBRATED BY AN AUTHORIZED VIDIKRON DEALER.

RIGHTS, LIMITS AND EXCLUSIONS:

THE FOREGOING DESCRIBED WARRANTIES ARE THE ONLY WARRANTIES THAT APPLY TO THE PRODUCTS. VIDIKRON MAKES NO OTHER WARRANTY OR REPRESENTATION AND HEREBY DISCLAIMS ALL OTHER WARRANTIES, EXPRESS OR IMPLIED, INCLUDING, BUT NOT LIMITED TO, THE IMPLIED WARRANTIES OF MERCHANTABILITY AND FITNESS FOR A PARTICULAR PURPOSE. VIDIKRON'S LIABILITY RELATED TO THE PRODUCT IS LIMITED TO THE COST OF THE APPLICABLE REMEDY AS NOTED ABOVE. IN NO EVENT SHALL VIDIKRON BE LIABLE FOR:

- DAMAGE TO OTHER PROPERTY CAUSED BY ANY DEFECTS IN THE PRODUCT, DAMAGES BASED UPON INCONVENIENCE, LOSS OF USE OF THE PRODUCT, LOSS OF TIME, LOSS OF PROFITS, LOSS OF BUSINESS OPPORTUNITY, LOSS OF GOODWILL, INTERFERENCE WITH BUSINESS RELATIONSHIPS, OR OTHER COMMERCIAL LOSS, EVEN IF ADVISED OF THE POSSIBILITY OF SUCH DAMAGES;
- ANY OTHER DAMAGES, WHETHER INCIDENTAL, CONSEQUENTIAL OR OTHERWISE;
- ANY CLAIM AGAINST THE CUSTOMER BY ANY OTHER PARTY; OR
- ANY VERBAL WARRANTY ASSURANCES MADE BY A VIDIKRON EMPLOYEE OR A VIDIKRON AUTHORIZED DEALER THAT CONFLICTS WITH OR ENHANCES THE WRITTEN WARRANTY INCLUDED HEREIN.

EFFECTIVE WARRANTY DATE:

This Limited Warranty begins on the date of delivery to the end user. For your convenience, keep the original bill of sale as evidence of the purchase date.

CONTACT AN AUTHORIZED SERVICE CENTER TO OBTAIN SERVICE:

Repairs made under the terms of this Limited Warranty covering your Vision 140/150 Product will be performed at the location of the Product, during usual working hours, provided that the location of the Product is within normal operating distance from an Authorized Vidikron Service Center. In some instances it may be necessary for the Product to be returned to the Vidikron factory for repairs. If, solely in Vidikron's judgment, location of Product to be repaired is beyond normal operating distance of the closest Authorized Vidikron Service Center, or the repair requires the unit be returned to the Vidikron factory, it is the owner's responsibility to arrange for shipment of the Product for repair. These arrangements must be made through the selling Vidikron Dealer. If this is not possible, contact Vidikron directly for a Return Authorization number and shipping instructions. Vidikron will return Product with transportation prepaid in the United States, unless no Product defect is discovered. In that instance, shipping costs will be the responsibility of the Product owner.

COPYRIGHT AND TRADEMARKS:

© Copyright 2008 Runco International, LLC ("Runco"). This document contains proprietary information protected by copyright, trademark and other intellectual property laws. All rights are reserved. No part of this manual may be reproduced by any mechanical, electronic or other means, in any form, without prior written permission of Runco.

The trademarks reproduced in this Vidikron Owner's Manual and used on the Vidikron Products are either owned by Runco or are licensed by Runco. You may not reproduce or use the trademarks without the prior written consent of Runco.

Vidikron Products are manufactured under one or more of the following patents: US. Patent 6755540 and Other Patents Pending.

ADDITIONAL INFORMATION:

To locate the name and address of the nearest Authorized Vidikron Service Center, or for additional information about this Limited Warranty, please call or write:

VIDIKRON, c/o RUNCO INTERNATIONAL, LLC
1195 NW Compton Drive
Beaverton, OR 97006-1992
Ph: (503) 748-5799
Fax: (503) 748-8161
Toll Free: (888) 4VIDIKRON (888-484-3457)

**PRODUCT INFORMATION
RETAIN FOR YOUR RECORDS**

Model Purchased		Date
<hr/>		
Serial Number		
<hr/>		
Vidikron Authorized Dealer Name		
<hr/>		
Address		
<hr/>		
City	State/Province	Postal Code
<hr/>	<hr/>	<hr/>
Phone	Fax	
<hr/>	<hr/>	

Important Safety Instructions

Thank you for your purchase of this quality Vidikron video product! It has been designed to provide you with the quality of video that is expected in a home theater. For the best performance, please read this manual carefully as it is your guide through the menus and operation.

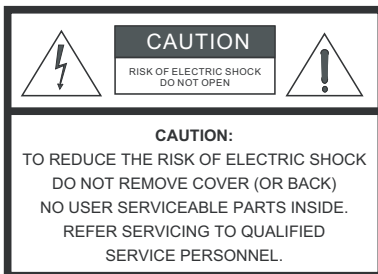

WARNING

This symbol is intended to alert the user to the presence of uninsulated "dangerous voltage" within the product's enclosure that may be of sufficient magnitude to constitute a risk of electric shock.



This symbol is intended to alert the user to the presence of important operating and maintenance (servicing) instructions in the literature accompanying the appliance.

1. Read these instructions.
2. Keep these instructions.
3. Heed all warnings.
4. Follow all instructions.
5. Do not use this apparatus near water.
6. Clean only with a dry cloth.
7. Do not block any of the ventilation openings. Install in accordance with the manufacturer's instructions.
8. Do not install near any heat sources such as radiators, heat registers, stoves, or other apparatus (including amplifiers) that produce heat.
9. Do not defeat the safety purpose of the polarized or grounding type plug. A polarized plug has two blades with one wider than the other. A grounding type plug has two blades and a third grounding prong. The wide blade or the third prong is provided for your safety. When the provided plug does not fit into your outlet, consult an electrician for the replacement of the obsolete outlet.
10. Protect the power cord from being walked on or pinched particularly at plugs, convenience receptacles and the point where they exit from the apparatus.
11. Only use the attachments/accessories specified by the manufacturer.
12. Use only with a cart, stand, tripod, bracket or table specified by the manufacturer or sold with the apparatus. When a cart is used, use caution when moving the cart/apparatus to avoid injury from tip-over.
13. Unplug this apparatus during lightning storms or when unused for long periods of time.
14. Refer all servicing to qualified service personnel. Servicing is required when the apparatus has been damaged in any way, such as power supply cord or plug is damaged, liquid has been spilled or objects have fallen into the apparatus, the apparatus has been exposed to rain or moisture, does not operate normally, or has been dropped.
15. The +12V trigger only outputs 12Vdc signal for triggering. Do not connect to any other power input or output. This could cause damage to this unit.
16. Keep the packing material in case the equipment should ever need to be shipped.
17. The lamp becomes extremely hot during operation. Allow the projector to cool down for approximately 45 minutes prior to removing the lamp assembly for replacement.
18. Do not operate lamps beyond the rated lamp life. Excessive operation of lamps beyond rated life could cause them to explode in rare occasions.



19. Never look directly into the lens when the lamp is on.

Compliance Information

DECLARATION OF CONFORMITY:

Manufacturer's Name: Runco International, LLC

Manufacturer's Address: 1195 NW Compton Drive, Beaverton, OR 97006-1992

hereby declares that the Products' Model Numbers:

Vision 140, Vision 140/CineWide, Vision 140/CineWide with AutoScope, Vision 150, Vision 150/CineWide and Vision 150/CineWide with AutoScope

conform with the provisions of:

Council Directive 2004/108/EC on Electromagnetic Compatibility;

EN 55022 "Limits and methods of measurements of radio interference characteristics of information technology equipment" 1998;

EN 55024 "Limits and methods of measurements of immunity characteristics of information technology equipment" 1998;

Including:

- EN 61000-4-2 "Electromagnetic compatibility (EMC) Part 4: Testing and measurement techniques Section 2: Electrostatic discharge immunity test"
- EN 61000-4-3 "Electromagnetic compatibility (EMC) Part 4: Testing and measurement techniques Section 3: Radiated, Radio-Frequency, Electromagnetic Field Immunity Test"
- EN 61000-4-4 "Electromagnetic compatibility (EMC) Part 4: Testing and measurement techniques Section 4: Electrical fast transient/burst immunity test"
- EN 61000-4-5 "Electromagnetic compatibility (EMC) Part 4: Testing and measurement techniques Section 5: Surge immunity test"
- EN 61000-4-6 "Electromagnetic compatibility (EMC) Part 4: Testing and measurement techniques Section 6: Conducted disturbances induced by radio-frequency fields immunity test"
- EN 61000-4-8 "Electromagnetic compatibility (EMC) Part 4: Testing and measurement techniques Section 8: Conducted disturbances induced by power frequency magnetic fields immunity test"
- EN 61000-4-11 "Electromagnetic compatibility (EMC) Part 4: Testing and measurement techniques Section 11: Voltage dips, short interruptions and voltage variations immunity tests"

And:

- EN 61000-3-2 "Electromagnetic compatibility (EMC) Part 3, Section 2: Limits for harmonic current emissions (equipment input current up to and including 16 A per phase)" 2000;
- EN 61000-3-3 "Electromagnetic compatibility (EMC) Part 3, Section 3: Limitations of voltage changes, voltage fluctuations and flicker in public low-voltage supply systems, for equipment with rated current up to and including 16 A and not subject to conditional connection" 1995;

Council Directive 2006/95/EC and amended by M1 and C1 on Low Voltage Equipment Safety;

EN 60950 "Safety of information technology equipment, including electrical business equipment"

The Technical Construction file required by this Directive is maintained at the corporate headquarters of Runco International, LLC, located at 1195 NW Compton Drive, Beaverton, OR 97006-1992.

Date of Declaration: March 2008

FCC PART 15:

NOTE: This equipment has been tested and found to comply with the limits for a Class B digital device, pursuant to Part 15 of the FCC Rules. These limits are designed to provide reasonable protection against harmful interference in a residential installation.

This equipment generates, uses and can radiate radio frequency energy and, if not installed and used in accordance with the instructions, may cause harmful interference to radio communications. However, there is no guarantee that interference will not occur in a particular installation. If this equipment does cause harmful interference to radio or television reception, which can be determined by turning the equipment off and on, the user is encouraged to try to correct the interference by one or more of the following measures:

- Reorient or relocate the receiving antenna.
- Increase the separation between the equipment and receiver.
- Connect the equipment into an outlet on a circuit different from that to which the receiver is connected.
- Consult the dealer or an experienced radio/TV technician for help.

INDUSTRY CANADA (ICES-003):

This Class B digital apparatus complies with Canadian ICES-003.

Cet appareil numérique de la classe B est conforme à la norme NMB-003 du Canada.

PRODUCT DISPOSAL:

The Product contains small amounts of tin, lead and/or mercury. Disposal of these materials may be regulated due to environmental considerations.

IMPORTANT RECYCLE INSTRUCTIONS



Lamp(s) inside this product contain mercury. This product may contain other electronic waste that can be hazardous if not disposed of properly. Recycle or dispose in accordance with local, state, or federal Laws.

For more information, contact the Electronic Industries Alliance at WWW.EIAE.ORG.

For lamp specific disposal information check WWW.LAMPRECYCLE.ORG.

DISPOSAL OF OLD ELECTRICAL AND ELECTRONIC EQUIPMENT (Applicable throughout the European Union and other European countries with separate collection programs)



This symbol found on your product or on its packaging, indicates that this product should not be treated as household waste when you wish to dispose of it. Instead, it should be handed over to an applicable collection point for the recycling of electrical and electronic equipment. By ensuring this product is disposed of correctly, you will help prevent potential negative consequences to the environment and human health, which could otherwise be caused by inappropriate disposal of this product. The recycling of materials will help to conserve natural resources. This symbol is only valid in the European Union. If you wish to discard this product, please contact your local authorities or dealer and ask for the correct method of disposal.

Table of Contents

TWO YEAR LIMITED WARRANTY	iii
Important Safety Instructions	vi
Compliance Information	vii
1. Introduction	1
About This Manual	1
Target Audience.....	1
If You Have Comments About This Manual.....	1
Textual and Graphic Conventions	1
Using This Manual	2
Description, Features and Benefits	3
Key Features and Benefits.....	4
Parts List	4
2. Controls and Functions	5
Vision 140/150 at a Glance	5
Vision 140/150 Input Panel	7
Vision 140/150 Rear-Panel Keypad	8
VHD Controller Front Panel	10
VHD Controller Rear Panel	11
Outputs.....	11
Inputs	11
Vision 140/150 Remote Control Unit	13
3. Installation	17
Remote Control	17
Battery Installation	17
Notes on Remote Control Operation.....	17
Quick Setup	19
Installation Considerations	20
Installation Type.....	20
Ambient Light	20
Throw Distance.....	21
Vertical and Horizontal Position	22
Vertical and Horizontal Lens Shift.....	22
Folded Optics	25
Other Considerations	25

Installing the Projection Lens	26
Installing the Optional CineWide Lens Mount	27
Remove Projector Front Feet (CineWide with AutoScope)	27
Install Anamorphic Lens Motor (CineWide with AutoScope) or Base Plate (fixed CineWide)	27
Install Projector Stand (CineWide with AutoScope, Floor-Mount)	28
Mounting the Vision 140/150	29
Floor Mounting (Upright)	29
Ceiling Mounting (Inverted)	29
Adjusting the Projection Angle	29
Connections to the Vision 140/150 and VHD Controller	30
Connector Panel Access	30
Connecting the VHD Controller to the Vision 140/150.....	30
Connecting Source Components to the VHD Controller	31
RS-232 Controller Connection	35
Connecting 12-Volt Trigger Outputs to External Theater Equipment	36
Connecting an External IR Receiver to the VHD Controller	37
Connecting to AC Power.....	37
Turning on the Power	38
Adjusting the Picture Orientation	39
Primary Lens Adjustments	39
Focus	39
Zoom	39
Vertical and Horizontal Lens Shift.....	39
Installing and Adjusting the CineWide Anamorphic Lens	40
Attach Lens Mounting Assembly to Lens Motor Carriage Plate (CineWide with AutoScope) or Base Plate (fixed CineWide).....	40
Configure Lens Motor Trigger (CineWide with AutoScope)	41
Adjust the Anamorphic Lens.....	41
Calibrating Projector Input 2 (DVI)	45
TheaterMaster Remote Control Functions	47
Navigating the Projector Menus	48
Channel Setup.....	48
Auto Setup	50
Size and Position Menu	51
Picture Quality Menu	53
Installation Menu	57
Working With the Lamp	59

4. Operation	63
Using the On-Screen Menus	63
Main Menu	65
Input Source	65
Aspect Ratio	65
Picture	68
Input Position	72
ISF Presets.....	73
Information	73
Calibration.....	74
Service.....	76
5. Maintenance and Troubleshooting	81
Lamp and Filter Replacement	81
Filter Replacement	83
Lens Replacement	84
Troubleshooting Tips	85
Error Codes.....	87
6. Serial Communications	91
RS-232 Connection and Port Configuration	91
Serial Command Syntax	91
7. Specifications	97
Vision 140/150 Specifications	97
VHD Controller Specifications	99
Vision 140/150 Dimensions	100

Notes:

List of Figures

2-1. Vision 140/150 Top/Rear/Front View.....	5
2-2. Vision 140/150 Input Panel.....	7
2-3. Vision 140/150 Rear-Panel Keypad.....	8
2-4. VHD Controller Front Panel.....	10
2-5. VHD Controller Rear Panel.....	11
2-6. VHD Controller/Vision 140/150 Remote Control.....	13
3-1. Available Range of the Remote Control.....	17
3-2. Estimating Throw Distance.....	21
3-3. Projector Placement.....	22
3-4. Vertical Lens Shift (EXAMPLE ONLY).....	22
3-5. Horizontal Lens Shift (EXAMPLE ONLY).....	23
3-6. Folded Optics.....	25
3-7. Lens Assembly (Front View).....	26
3-8. Mounting Angle Ranges (Front-to-Back and Side-to-Side).....	29
3-9. Connecting the Vision 140/150 to the VHD Controller.....	30
3-10. HDMI Source Connections.....	31
3-11. Digital (DTV) RGB or Component Video Connections.....	32
3-12. Analog RGB Connections.....	33
3-13. Composite, S-Video and Component Video Connections.....	34
3-14. RS-232 Control System Connection.....	35
3-15. Connecting 12-Volt Trigger Outputs.....	36
3-16. External IR Receiver Connection.....	37
3-17. TheaterMaster Remote Control for Vision 140/150.....	46
3-18. Channel Setup Menu.....	49
3-19. Unlocking a Channel.....	50
3-20. Resize Presets: No Resizing.....	51
3-21. Adjusting Black Levels and White Levels Using the Clipping Detector.....	56
4-1. VHD Controller OSD Menu Structure for Vision 140/150.....	64
4-2. Typical PLUGE Pattern for Adjusting Brightness.....	69
4-3. Typical Gray Bar Pattern for Adjusting Contrast.....	70
4-4. Typical Color Bar Pattern for Adjusting Color Saturation and Tint.....	70
4-5. Typical Test Pattern for Adjusting Sharpness.....	72

4-6. Keystone Correction	77
5-1. Removing the Lamp Door	81
5-2. Unlocking the Lamp	81
5-3. Removing the Lamp	82
5-4. Installing A New Lamp	82
5-5. Recording the Serial Number of a New Lamp	83
5-6. Removing the Primary Lens	84
7-1. Vision 140/150 Dimensions	100

Introduction

This Owner's Manual describes how to install, set up and operate a Vidikron Vision Model 140 or Model 150 LightAmp™ Projector and VHD Controller.

Throughout this manual, the Vidikron Vision Model 140/150 LightAmp™ Projector and VHD Controller are referred to as the "Vision 140/150." The information in this manual applies to both projector models except where otherwise indicated.

Vidikron has prepared this manual to help home theater installers and end users get the most out of the Vision 140/150.

Vidikron has made every effort to ensure that this manual is accurate as of the date it was printed. However, because of ongoing product improvements and customer feedback, it may require updating from time to time. You can always find the latest version of this and other Vidikron product manuals on-line, at www.Vidikron.com.

Vidikron welcomes your comments about this manual. Send them to info@Vidikron.com.

Text Conventions: The following conventions are used in this manual, in order to clarify the information and instructions provided:

- Remote and built-in keypad button identifiers are set in upper-case bold type; for example, "Press **EXIT** to return to the previous menu."
- Computer input (commands you type) and output (responses that appear on-screen) is shown in monospace (fixed-width) type; for example: "To change the aspect ratio to Letterbox, type `LETTERBOX <Enter>`."
- All keys with functional names are initial-capped, set in bold type and enclosed in angle brackets. These keys are the following: `<Enter>`, `<Spacebar>`, `<Control>`, `<Esc>` and `<Tab>`.
- `<Enter>` indicates that you may press either the RETURN or ENTER key on your keyboard if it has both keys.

In addition to these conventions, underlining, boldface and/or italics are occasionally used to highlight important information, as in this example:



Note

*A carriage return **must** be used after each command or string.*

1.1 About This Manual

◀ Target Audience

◀ If You Have Comments About This Manual...

◀ Textual and Graphic Conventions

Graphic Conventions: These symbols appear in numerous places throughout the manual, to emphasize points that you must keep in mind to avoid problems with your equipment or injury:

TIPS highlight time-saving short cuts and helpful guidelines for using certain features.



Note

NOTES emphasize text with unusual importance or special significance. They also provide supplemental information.



Caution

CAUTIONS alert users that a given action or omitted action can degrade performance or cause a malfunction.



WARNING

WARNINGS appear when a given action or omitted action can result in damage to the equipment, or possible non-fatal injury to the user.



DANGER!

DANGER appears when a given action can cause severe injury or death.

1.2 Using This Manual

Use the following table to locate the specific information you need in this manual.

If you need...	... Turn to page:
Information about obtaining service	iv
General information about the Vision Model 140/150 LightAmp™ Projector and VHD Controller	3
Installation instructions	17
First-time configuration instructions	39
Advanced configuration instructions	74
Troubleshooting tips	85
Product specifications	97

Vidikron's Vision Model 140 and Model 150 bring our most advanced technology, 1080p resolution and the world's first THX® Certified home video products together in truly awesome fashion.

The Vision 140/150 uses a new, ingeniously engineered 3-chip DLP™ light engine, combined with an advanced Xenon LightAmp™ lamp illumination system to bring astoundingly high performance and ultra-high resolution to the very best home theaters on the planet.

The Vision 140 features a 1000W Xenon lamp, while the Vision 150 uses a 1.2-kW Xenon lamp to produce our brightest 1080p pictures ever. Four, high-precision zoom lenses are available with broad motorized horizontal and vertical lens shift capability. Vidikron engineers have ensured that light is efficiently culminated through the implementation of our advanced V2™ technology and have also engineered ISF™ calibration standards into these projectors.

The Vision 140/150 is furnished with Vidikron's newest, next-generation, all-digital VHD Controller, featuring advanced Imagix™ processing, superb scaling, and the industry's most advanced aspect ratio control system.

For uncompromising widescreen reproduction of movies originally filmed in the "scope" (2.35:1) format, the Vision 140/150 can be equipped with Vidikron's patent-pending CineWide™ technology, a combination of software, electronics and high-quality anamorphic optics. CineWide maintains constant vertical height on the screen just as in a movie theater. When a viewer transitions from 1.78:1 (16:9) program material to 2.35:1, the image simply gets wider while full height is maintained. Also available with the Vision 140/150 is CineWide with AutoScope™, an enhanced, remote-controlled motorized version of CineWide.

**Note**

CineWide requires the use of a 2.35:1 or similar aspect ratio superwide format screen.

Discrete IR and RS-232 control make custom installation seamless, while discrete source and aspect ratio selection accommodate any automation control system.

1.3 Description, Features and Benefits

- Key Features and Benefits** ➤ The Vision 140/150 offers these key features and benefits:
- Native Resolution: 1920 x 1080
 - Three-chip Digital Light Processing (DLP) system
 - Two HDMI Inputs (on VHD Controller) with High-bandwidth Digital Content Protection (HDCP)
 - HDTV Compatible
 - Multiple lens options for stunning sharpness and throw distance flexibility

Parts List ➤ Your Vision 140/150 is shipped with the following items. If any items are missing or damaged, please contact your Vidikron dealer or Vidikron Customer Service at (888) 4VIDIKRON.

- Vision Model 140/150 LightAmp™ Projector and VHD Controller
- Remote Control Unit and two (2), AAA-size batteries
- TheaterMaster Remote Control Unit and four (4), AAA-size batteries
- Two (2), 110-VAC power cords (Vision 140)

– OR –

- One 110-VAC and one 220-VAC power cord (Vision 150)
- RJ-11 Telephone Cable, 50 feet (15.24 meters)
- Serial Port Adapter, RJ-11 Female to DB-9 Male
- Rack-mounting brackets and hardware for the VHD Controller
- Warranty information and registration card
- Vision Model 140/150 Installation/Operation Manual (this document)

Optional Accessories:

- CineWide™ technology (fixed, secondary anamorphic lens)
- CineWide™ with AutoScope™ system (secondary anamorphic lens and motorized mount)
- Ceiling mount kit (part number 956-0096-00)

Controls and Functions

Figure 2-1 shows the key Vision 140/150 components.

2.1 Vision 140/150 at a Glance

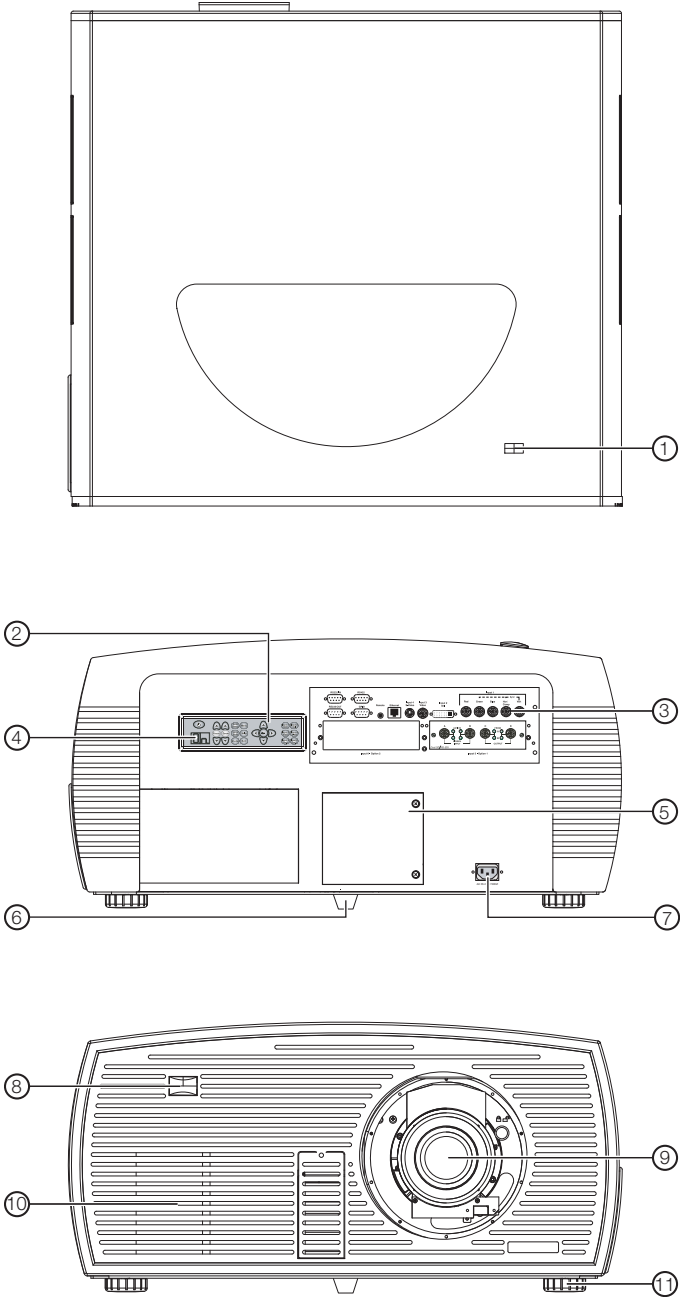
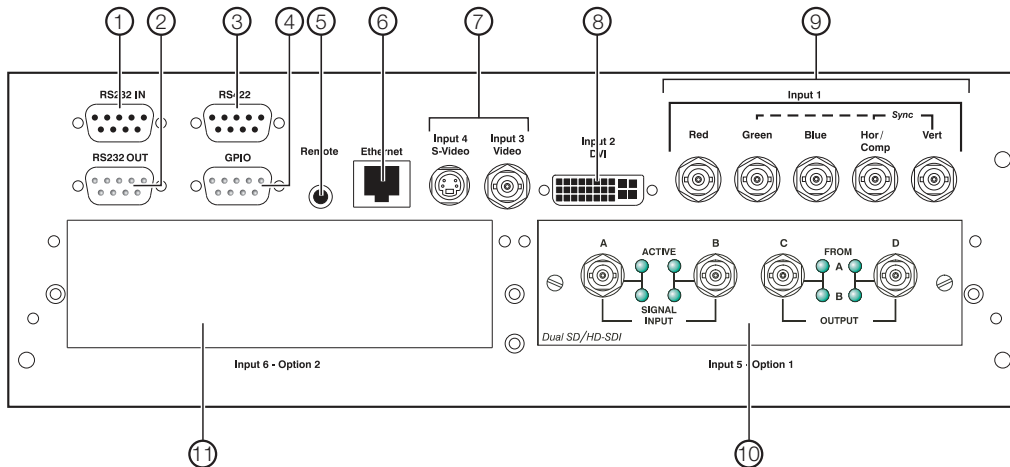

Figure 2-1. Vision 140/150 Top/Rear/Front View

1. **TOP IR SENSOR**
2. **BUILT-IN KEYPAD**
The built-in keypad is located at the back of the projector, beside the input panel. Use it similarly to the TheaterMaster Remote Control to perform service-related tasks on the projector.
3. **INPUT PANEL**
Connect the VHD Controller outputs here.
4. **LED STATUS DISPLAY**
Indicates current operating status of the projector.
5. **LAMP COVER**
Remove this cover to access the lamp compartment.
6. **REAR FOOT (Stationary)**
7. **POWER INPUT (200 to 240 VAC)**
Connect the Vision 140/150 to power here. (The Vision 140 requires 100 to 240 VAC; the Vision 150 requires 200 to 240 VAC.)
8. **FRONT IR SENSOR**
9. **PROJECTION LENS**
10. **INTAKE VENT**
Allows cool air to enter the projector, to help maintain proper operating temperature.
11. **ADJUSTABLE FEET (2)**
Located on the underside of the projector are two adjustable feet. Raise or lower these feet when positioning the projector to ensure it is level on all sides so the displayed image will appear rectangular without any keystone.

Figure 2-2 shows the Vision 140/150 rear input panel.



2.2 Vision 140/150 Input Panel

Figure 2-2. Vision 140/150 Input Panel

1. **RS232 IN**
Connect the RS-232 output from the VHD Controller here, using the provided RJ11-to-DB9 adapter and communication cable.
2. **RS232 OUT**
Not used.
3. **RS422**
Not used.
4. **GPIO**
Not used.
5. **REMOTE**
Wired input from an external remote control or infrared receiver.
6. **ETHERNET**
Reserved for future use.
7. **INPUT 3 (Video) / INPUT 4 (S-Video)**
Not used. Connect all video sources to the VHD Controller.
8. **INPUT 2 (DVI)**
HDCP-compliant digital video input. Connect the HDMI output from the VHD Controller to this input.
9. **INPUT 1 (RGBHV)**
Not used. Connect all video sources to the VHD Controller.
10. **INPUT 5 (Option 1)**
Reserved for future use.
11. **INPUT 6 (Option 2)**
Reserved for future use.

2.3 Vision 140/150 Rear-Panel Keypad

Figure 2-3 shows the Vision 140/150 rear-panel keypad.

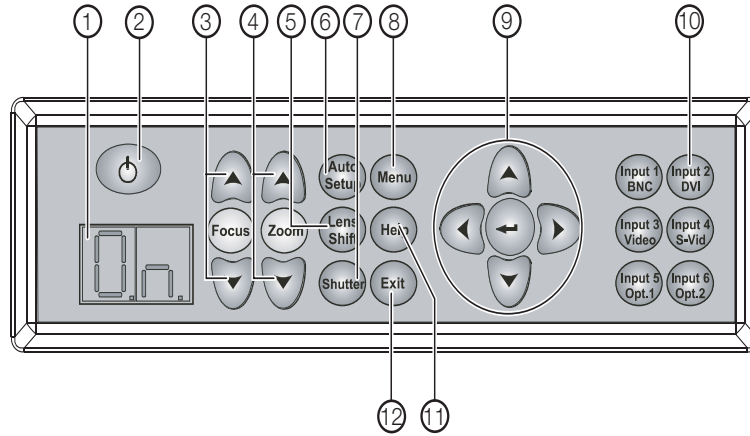

Figure 2-3. Vision 140/150 Rear-Panel Keypad

1. **LED STATUS DISPLAY**
The LED status window displays an active pattern of segments to indicate the projector is changing its state from powered down to powered up. The message "On" appears in the display when the projector has completed its initialization and is ready for use.
2. **POWER BUTTON**
Not used. Use the VHD Controller to turn the projector on or off.
3. **FOCUS (▲ / ▼)**
Use these buttons to focus the projected image.
4. **ZOOM (▲ / ▼)**
Use these buttons to increase or decrease the projected image size.
5. **LENS SHIFT**
Press this button to access the motorized lens shift controls.
6. **AUTO SETUP**
Press this button to initiate an automated process in which the projector optimizes critical display parameters for the current source.
7. **SHUTTER**
Press and hold this button for two seconds to toggle the internal mechanical shutter blade closed or open. A closed shutter blanks the display (turns it to black). Close the shutter to mute all display while maintaining access to projector functions. Opening the shutter restores the image.
8. **MENU**
Press this button to show or hide the projector menus.



Note

The Vision 140/150 has its own internal menu system, separate from that of the VHD Controller. However, it is intended for use by trained service personnel only.

9. Menu Navigation Buttons:

UP BUTTON (▲)

Used to move the menu cursor up in the Vision 140/150 menu system.

LEFT BUTTON (◀)

Used to move the menu cursor left in the Vision 140/150 menu system.

DOWN BUTTON (▼)

Used to move the menu cursor down in the Vision 140/150 menu system.

RIGHT BUTTON (▶)

Used to move the menu cursor right in the Vision 140/150 menu system.

ENTER BUTTON

When an item is highlighted on the On-Screen Display, the **ENTER** button selects the item.

10. **INPUT 2 (DVI)**

Press this button to select projector Input 2 (HDMI output from the VHD Controller).

11. **HELP**

Press **HELP** to display on-screen help text. Press **HELP** again (or **EXIT**) to hide it.

12. **EXIT**

When in the menu structure, the **EXIT** button brings the menu back one page or cancels the current function.

2.4 VHD Controller Front Panel

Figure 2-4 shows the controls and indicators on the VHD Controller front panel; the paragraphs that follow describe them.

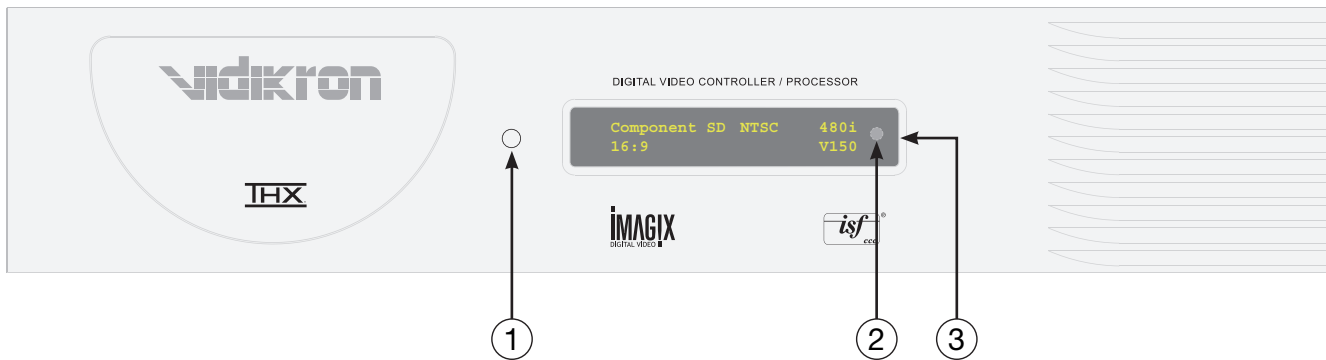

Figure 2-4. VHD Controller Front Panel

1. **POWER BUTTON**
Press once to toggle from standby mode to on mode. Press it again to return to standby mode. For a discrete on or off command, you can use the direct access buttons on the remote control.
2. **IR SENSOR**
Receives IR commands from the remote.
3. **VACUUM FLUORESCENT DISPLAY**
Can be used instead of the On-Screen Display (OSD). Displays currently-selected menu or – if no menu is selected – the current source, signal format (NTSC or PAL), input resolution and aspect ratio.

Figure 2-5 shows the rear connector panel on the VHD Controller.

2.5 VHD Controller Rear Panel

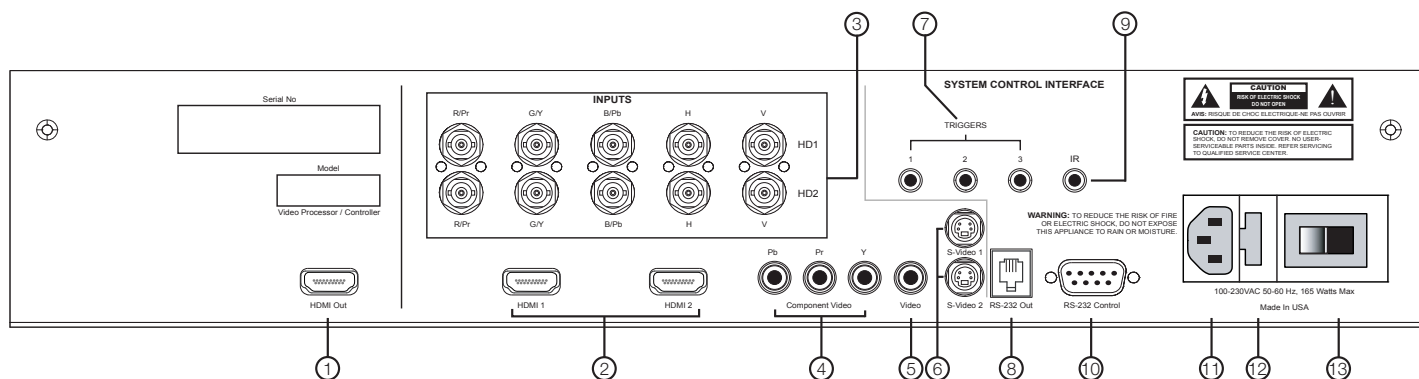

Figure 2-5. VHD Controller Rear Panel

1. **HDMI OUT**

Connect this to **Input 2 (DVI)** on the Vision 140/150 (see Figure 2-2).

◀ **Outputs**

2. **HDMI 1 / HDMI 2 (Digital)**

Two, HDCP-compliant digital video inputs for connecting a DVD player or HD tuner with a DVI or HDMI output.

◀ **Inputs**

3. **HD1 / HD2 (5 x Analog BNCs)**

Two inputs (five BNCs per input) for connecting either RGB or component high-definition television signals. The VHD Controller automatically detects the signal format: RGB(HV) or YPrPb, 480p, 720p, 480i, 576i or 1080i.

4. **COMPONENT VIDEO (RCA connectors)**

Standard Definition (480i/576i) Component (YPrPb) input. This is the input for component video from sources such as DVD players.

For best results, do not run your DVD player in progressive mode.

5. **COMPOSITE VIDEO INPUT**

Standard composite video input for connecting a VCR, laser disc player or other composite video source.

6. **S-VIDEO 1 / S-VIDEO 2**

Two, standard S-Video inputs for connecting a DVD player, satellite receiver or Super VHS (S-VHS) VCR.

7. **12-VOLT (750 mA) TRIGGER OUTPUTS**

Connection for up to three (3), 12-volt trigger-controlled devices such as retractable screens or screen masks.

8. **RS-232 OUTPUT**

Connect this to the **RS232 IN** input on the projector, using the provided communication cable.

9. **IR**

Wired input from a wired remote control or infrared receiver. It is a 3.5-mm, mini phono jack, wired as follows:

Ring = +5V

Tip = IR Input

Sleeve = Ground



Note

When an external remote control or infrared receiver is connected to the wired IR input, the IR sensor on the front of the VHD is disabled.

10. **RS-232 CONTROL PORT**

A female, 9-pin D-sub connector for interfacing with a PC or home theater automation/control system.

11. **POWER INPUT (100 to 240 VAC)**

Connect the VHD Controller to power here.

12. **MAIN AC FUSE**

This is the main AC input fuse (5mm x 20mm, 500 mA, 250V slow-blow).

13. **MAIN POWER SWITCH**

Disconnects or applies power to the VHD Controller.

Figure 2-6 shows the Vision 140/150 remote control, and the paragraphs that follow describe its functionality.

2.6 Vision 140/150 Remote Control Unit

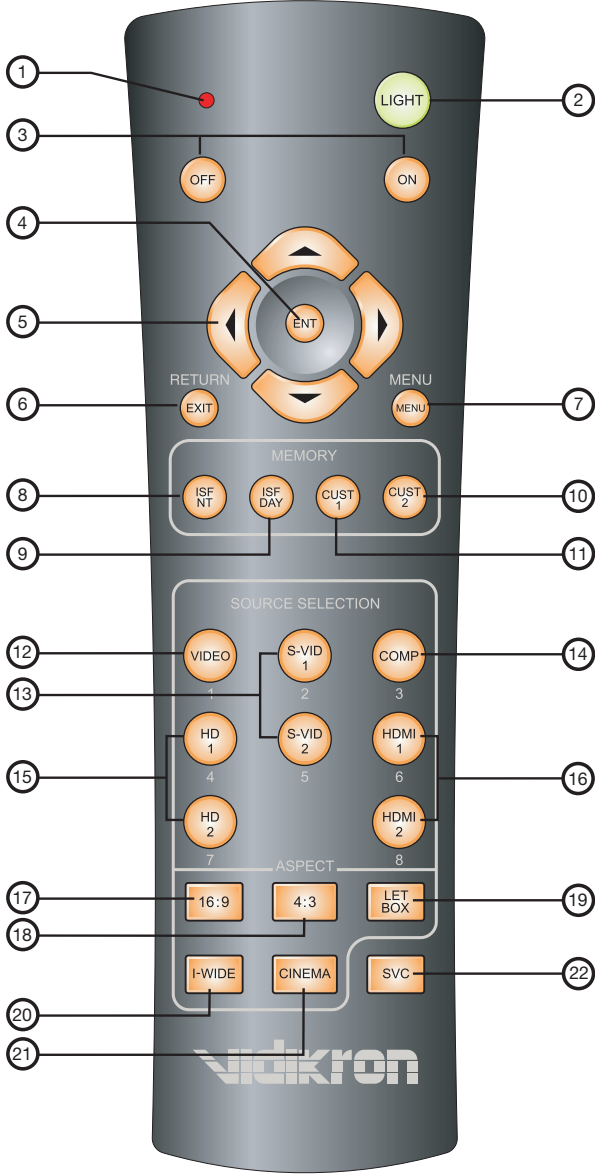

Figure 2-6. VHD Controller/Vision 140/150 Remote Control

1. **IR OUTPUT INDICATOR**
Lights when a button is pressed to indicate that an IR signal is being transmitted.
2. **LIGHT**
Press to illuminate the buttons.
3. **ON / OFF**
Press to turn the projector on or off.
4. **ENT (Enter)**
Press to select a highlighted menu item or confirm a changed setting.



Note

*On some remote control units, this button is where the **RETURN/EXIT** button (item #6) appears here.*

5. **Cursor Buttons (▲, ◀, ▼, ▶)**
Use these buttons to select items or settings, adjust settings or switch display patterns.

When no menu is present on-screen, the **UP** and **DOWN** buttons toggle through the available aspect ratios, in this order:

UP Button = 16:9 - Standard (4:3) - Letterbox - IntelliWide - Cinema - IntelliWide 2.35

DOWN Button = IntelliWide 2.35 - Cinema - IntelliWide - Letterbox - Standard (4:3) - 16:9



Note

Intelliwide 2.35 is available only on the Vision 140/150/CineWide. For more information about aspect ratios, refer to Table 4-1.

Likewise, the **LEFT** and **RIGHT** buttons toggle through the different source inputs, in this order:

LEFT Button = HDMI 2 - HDMI 1 - HD/RGB2 - HD/RGB 1 - Component SD - S-Video 2 - S-Video 1 - Composite

RIGHT Button = Composite - S-Video 1 - S-Video 2 - Component SD - HD/RGB 1 - HD/RGB 2 - HDMI 1 - HDMI 2



Note

*The "direct select" function of the **UP, DOWN, LEFT** and **RIGHT** buttons is available only on the analog inputs (HD/RGB, SD Component, Composite and S-Video).*

6. **RETURN/EXIT**
Press this button to exit the current menu and return to the previous one, or to cancel an operation.



Note

*On some remote control units, the **ENT (Enter)** button (item #4) is in this location.*

7. **MENU**
Press this button to access the OSD controls.

Memory Preset Buttons:

8. **ISF NT (Night)**
Press to recall settings for the current input from the "ISF Night" memory preset.
9. **ISF DAY**
Press to recall settings for the current input from the "ISF Day" memory preset.
10. **CUST 2**
Press to recall settings for the current input from the "Custom 2" memory preset.
11. **CUST 1**
Press to recall settings for the current input from the "Custom 1" memory preset.
12. **VIDEO (1)**
Press to select Composite video input as the source or to enter the numeric character "1."
13. **S-VID 1 (2) / S-VID 2 (5) (S-Video)**
Press to select an S-Video input or to enter the numeric character "2" or "5."
14. **COMP (Component) (3)**
Press to select Component SD (480i/576i) video input as the source or to enter the numeric character "3."
15. **HD 1 (4) / HD 2 (7)**
Press to select a HD (RGBHV or YPbPr component) input or to enter the numeric character "4" or "7."
16. **HDMI 1 (6) / HDMI 2 (8)**
Press to select a Digital Video input or to enter the numeric character "6" or "8."

Aspect Ratio Selection Buttons:

Use these buttons to select an aspect ratio directly or to enter numeric characters, as follows:

17. **16:9 (9)**
For viewing 16:9 DVDs or HDTV programs in their native aspect ratio.
18. **4:3 (0)**
Scales the input signal to fit 4:3 display mode in the center of the screen.
19. **LETBOX (Letterbox)**
For viewing LaserDisc movies or non-anamorphic DVDs on a 16:9 screen.
20. **I-WIDE (IntelliWide)**
Enlarges a 4:3 image horizontally in a NON-linear fashion to fit 16:9 full screen display.
21. **CINEMA**
For viewing 2.35:1 source material.
22. **SVC (CineWide-equipped projectors only)**
Selects the IntelliWide 2.35 aspect ratio, used for viewing 16:9 source material on a 2.35:1 screen.

Notes:

Installation

3.1 Remote Control

◀ Battery Installation

To install batteries in the remote control:

1. Remove the battery cover from the back of the remote control.
2. Insert the batteries included with the remote control. Ensure that the polarities correctly match the \oplus and \ominus markings inside the battery compartment.
3. Replace the battery cover.



Note

1. Do not mix an old battery with a new one or different types of batteries.
2. If you will not use the remote control for a long time, remove the batteries to avoid damage from battery leakage.

The remote control can be used to control the Vision 140/150 within the ranges shown in Figure 3-1.

◀ Notes on Remote Control Operation

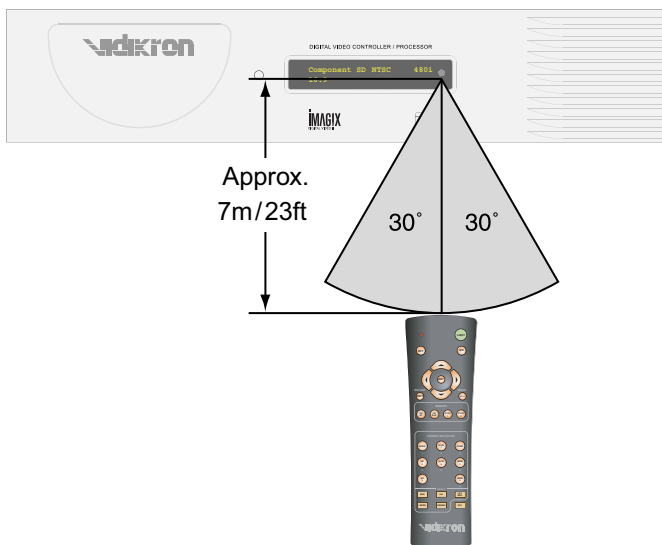

Figure 3-1. Available Range of the Remote Control

- Do not drop the remote control or expose it to moisture or high temperature.
- The remote control may malfunction under a fluorescent lamp. If that occurs, move the VHD Controller away from the fluorescent lamp.
- Make sure that there is nothing obstructing the infrared beam between the remote control and the IR receiver on the VHD Controller or projector.
- If the effective range of the remote control decreases, or it stops working, replace the batteries with new ones.
- The remote control may fail to operate if the infrared remote sensor is exposed to bright sunlight or fluorescent lighting.
- Ambient conditions may possibly impede the operation of the remote control. If this happens, point the remote control at the VHD Controller, and repeat the operation.

Table 3-1 gives a quick overview of the Vision 140/150 installation process. The sections following this one provide detailed instructions.

3.2 Quick Setup



Note

Installation should be performed by a qualified custom video installation specialist.

Table 3-1. Installation Overview

Step	Procedure	For Details, Refer to page...
1	Choose a location for the projector	20
2	Install primary projection lens	26
3	Install CineWide lens mounting assembly (stationary base plate or AutoScope lens motor – optional)	27
4	Mount the projector	29
5	Connect the VHD Controller to the projector	30
6	Connect signal sources to the VHD Controller	31
7	Connect external controller to RS-232 port (optional)	35
8	Connect other home theater components to 12-volt trigger outputs (optional)	36
9	Apply power to the projector	37, 38
10	For rear-screen and/or ceiling-mount installations, select the proper picture orientation	39
11	Primary lens adjustments: projected image size (zoom), position (shift) and focus	22, 39
12	Install CineWide anamorphic lens (optional)	40
13	CineWide lens adjustments: projected image size (zoom), position (shift) and focus	41
14	Calibrate projector input 2 (DVI): perform Auto Setup, then adjust size/position, input levels, brightness/contrast etc., as needed for each channel	45
15	Adjust lamp output and optical aperture, as needed	59
16	VHD Controller input calibration: adjust the following for each VHD Controller input ; save settings when finished: <ul style="list-style-type: none"> • Aspect ratio • Brightness • Contrast • Color level • Tint • Input position 	65 through 73

3.3 Installation Considerations

Proper installation of your projector will ensure the quality of your display. Whether you are installing a projector temporarily or permanently, you should take the following into account to ensure your projector performs optimally.

Installation Type ➤ Choose the installation type that best suits your needs: front or rear screen, floor mount or inverted mount. Table 3-2 compares these various installation methods.

Table 3-2. Projector Installation Options

Advantages	Considerations
Front Screen, Floor Mount Installation	
<ul style="list-style-type: none"> • Easy to set up • Can be moved or changed quickly • Easy to access 	<ul style="list-style-type: none"> • Shares floor space with audience
Front Screen, Inverted Mount (ceiling) Installation	
<ul style="list-style-type: none"> • Does not take up audience space • Projector is unobtrusive • Projector cannot be accidentally moved 	<ul style="list-style-type: none"> • Installation is more permanent • Projector access is more difficult
Rear Screen, Floor Mount Installation	
<ul style="list-style-type: none"> • Projector is completely hidden • Projector is easily accessed • Usually good ambient light rejection 	<ul style="list-style-type: none"> • Requires separate room • Installation cost is usually higher
Rear Screen, Inverted Mount (ceiling) Installation	
<ul style="list-style-type: none"> • Projector is completely hidden • Usually good ambient light rejection 	<ul style="list-style-type: none"> • Requires separate room • Installation cost is usually higher
Rear Screen, Floor Mount with Mirror	
<ul style="list-style-type: none"> • Projector is completely hidden • Usually good ambient light rejection • Requires less space behind screen than other rear screen installations 	<ul style="list-style-type: none"> • Requires separate room • Installation cost is usually higher

Ambient Light ➤ In general, minimize or eliminate light sources directed at the screen. Contrast ratio in your images will be noticeably reduced if light directly strikes the screen, such as when a shaft of light from a window or floodlight falls on the image. Images may then appear washed out and less vibrant.

Throw distance is the distance measured from the front of the projector to the screen. This is an important calculation in any projector installation as it determines whether or not you have enough room to install your projector with a desired screen size and if your image will be the right size for your screen.

◀ **Throw Distance**

You can quickly estimate the throw distance by taking the width of the screen and multiplying it by the lens throw ratio; see Figure 3-2. The result of this calculation tells you roughly how far back the projector should be positioned from the screen in order to project a focused image large enough to fill the screen.

Estimating Throw Distance

Throw Distance (TD) = Screen Width (w) x Lens Throw Ratio

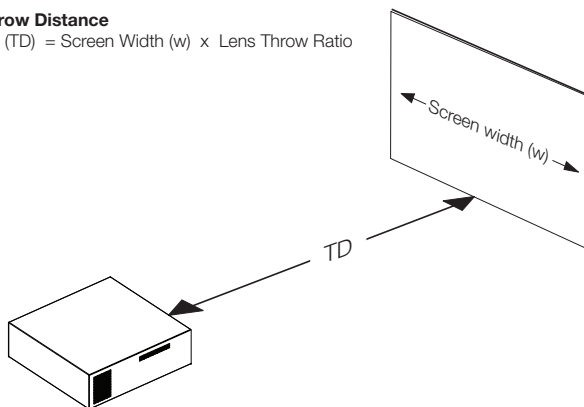

Figure 3-2. Estimating Throw Distance

Table 3-3 lists the available lens options for the Vision 140/150 and their associated throw ratios.

Table 3-3. Vision 140/150 Lens Options and Throw Ratios

Lens Option (Note 2)	Throw Ratio with Primary Lens Only	Throw Range in inches, with 96x54-inch (1.78:1) Screen		Throw Ratio with Primary Lens and Anamorphic Lens	Throw Range in inches, with 126.9x54-inch (2.35:1) Screen	
		Minimum	Maximum		Minimum	Maximum
B	1.40 - 1.60	134.40	153.60	Not Applicable (Note 2)		
C	1.70 - 2.25	163.20	216.00			
D	2.40 - 3.97	230.40	381.12	1.81 - 3.05	229.69	387.04
E	4.20 - 6.57	403.20	630.72	3.20 - 5.04	406.08	639.58

Notes:

1. Throw distance does not affect image quality, provided these ranges are taken into account.
2. Only lens options D and E can be used with the optional CineWide (secondary anamorphic) lens. Doing so affects the throw distances as shown here.

Vertical and Horizontal Position

Proper placement of the projector relative to the screen will yield a rectangular, perfectly-centered image that completely fills the screen.

Ideally, the projector should be positioned perpendicular to the screen and in such a way that the lens center and screen center are aligned with each other, as shown in Figure 3-3.

Ceiling Installation

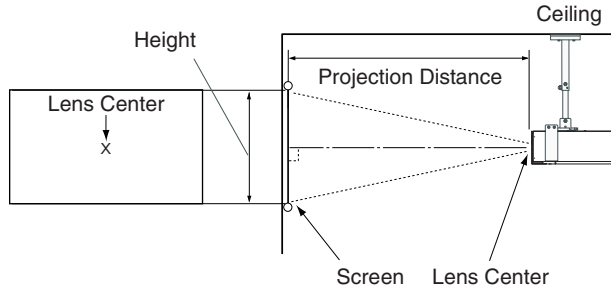

Floor Installation

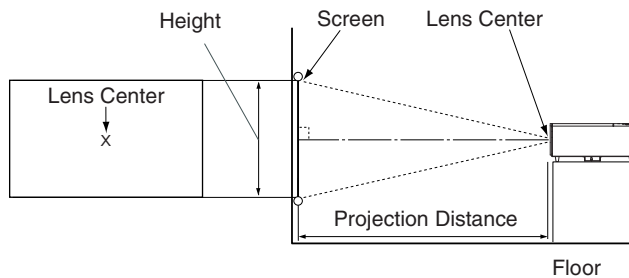
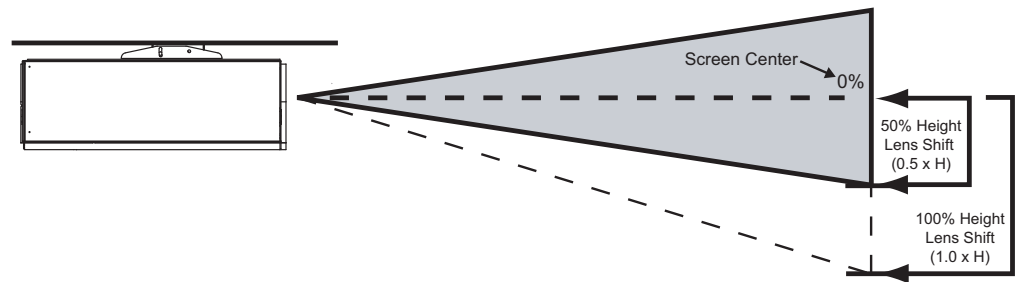

Figure 3-3. Projector Placement

Vertical and Horizontal Lens Shift

If it is not possible to align the projector and screen as shown in Figure 3-3, you can use the lens shift controls to center the image on the screen. Lens shift is generally expressed as a percentage of the screen height or width, as shown in Figure 3-4 and Figure 3-5.



Note: This is a general example of lens shift. Lenses vary in their shift capabilities. **No particular lens or projector is used in this example.**

Figure 3-4. Vertical Lens Shift (EXAMPLE ONLY)

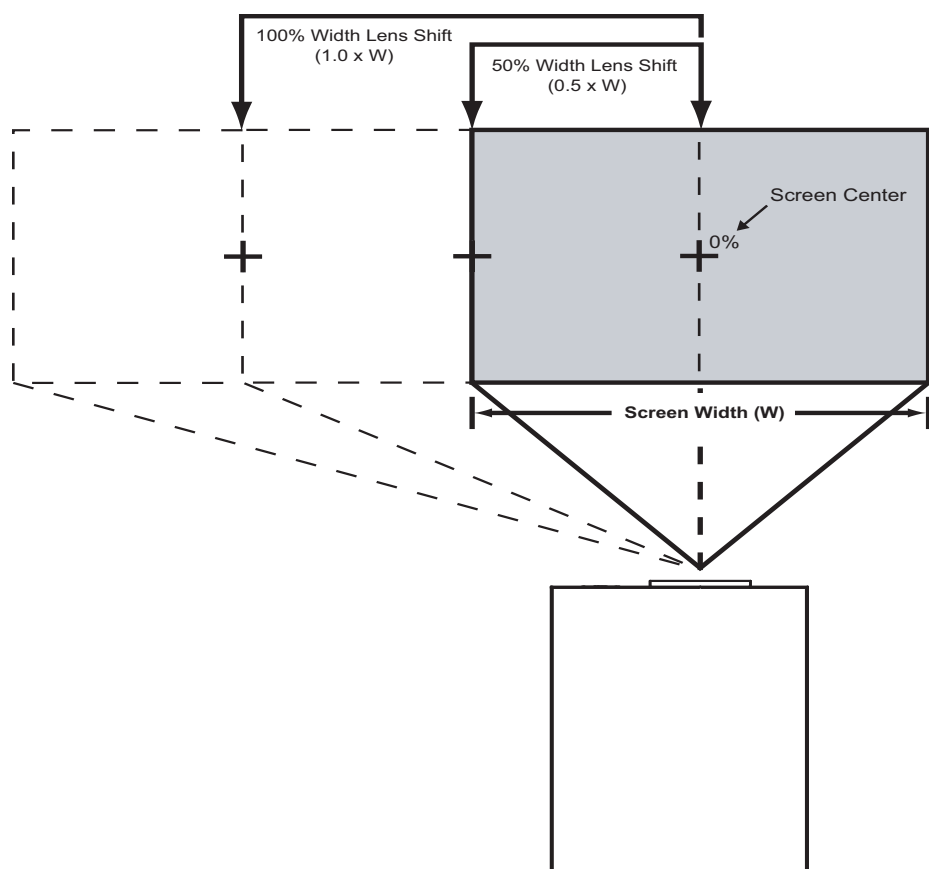

Note: This is a general example of lens shift. Lenses vary in their shift capabilities. **No particular lens or projector is used in this example.**

Figure 3-5. Horizontal Lens Shift (EXAMPLE ONLY)

Table 3-4 lists the lens shift limits for each available Vision 140/150 lens, as percentages and absolute measurements with a 100 x 56 inch (1.78:1) screen.

Table 3-4. Vertical and Horizontal Lens Shift Limits

		Lens Option		
		B or C	D	E
Lens Shift Limits, as Percentages of Screen Height or Width (Notes 1, 2 and 3)				
Vertical (Notes 2 and 3)	Up	60%		
	Down	60%		
Horizontal (Note 2)	Left	22%	20%	21%
	Right	22%	20%	21%
Lens Shift Limits in Inches, with a 100-by-56 inch (1.78:1) Screen				
Vertical	Up	33.60		
	Down	33.60		
Horizontal	Left	22.00	20.00	21.00
	Right	22.00	20.00	21.00
Notes:				
1. With no vertical or horizontal lens shift, the lens center and screen center are aligned with each other.				
2. Vertical shift limits are percentages of the screen height. Horizontal shift limits are percentages of the screen width.				
3. Vertical lens shift figures are for ceiling mount configurations. For floor installations (where the projector is upright), reverse the up/down vertical lens shift percentages.				

In rear screen applications where space behind the projector is limited, a mirror may be used to fold the optical path, as shown in Figure 3-6. The position of the projector and mirror must be accurately set. If you are considering this type of installation, contact your dealer for assistance.

◀ **Folded Optics**

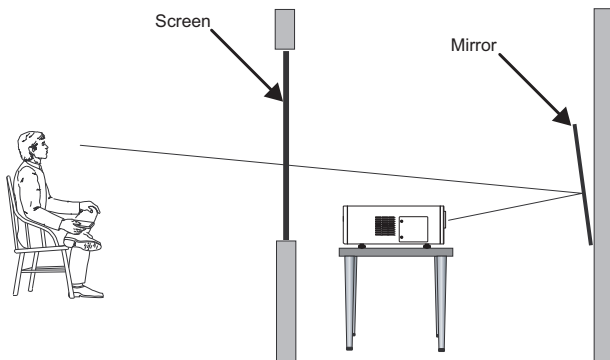

Figure 3-6. Folded Optics

Other considerations and tips that can help improve your installation:

◀ **Other Considerations**

- Keep the ambient temperature constant and below 35°C (95°F). Keep the projector away from heating and/or air conditioning vents. Changes in temperature may cause drifts in the projector circuitry, which may affect performance.
- Keep the projector away from devices that radiate electromagnetic energy such as motors and transformers. Common sources of these include slide projectors, speakers, power amplifiers and elevators.

3.4 Installing the Projection Lens

The projection lens is shipped separately from the projector. Proceed as follows to install the projection lens:

1. Remove the lens plug from the lens opening in the projector.
2. Place the lens cap on the projection lens to protect it from being damaged during the installation process.
3. Remove the rear cap from the lens. This protective cap is only used during shipping to protect the lens from damage.
4. Slide the new lens into the lens opening of the projector. Make sure to align the connector on the side of the lens with the connector assembly on the lens retaining ring; see Figure 3-7.

As you connect the lens, you may have to re-align it slightly until the tabs on the lens fit into the slots in the lens retaining ring.

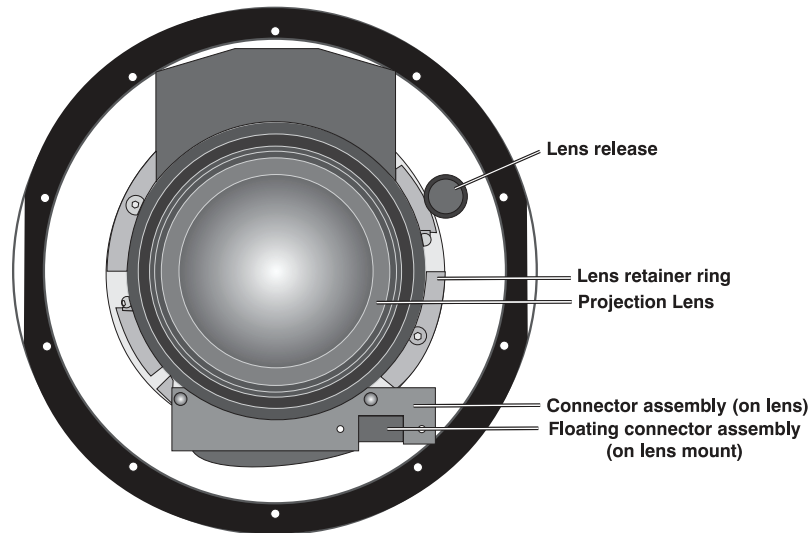

Figure 3-7. Lens Assembly (Front View)

5. With the lens fully inserted (and connected), turn it clockwise until the lens release button “pops” indicating the lens is fully inserted.

If you are installing a Vision 140/150 with the optional CineWide or CineWide with AutoScope system, proceed as follows to install the anamorphic lens mounting assembly (stationary base plate or AutoScope lens motor).

**Note**

1. Do not install the CineWide lens yet, only the mounting plate or lens motor. You will install the CineWide lens after you install the projector and adjust the primary lens.
2. Some of the following steps are necessary only for CineWide with AutoScope installations.

(Skip this step if you are installing a fixed CineWide anamorphic lens.)

Place the projector upside down on a blanket or other soft surface. Loosen and remove the two front feet on the projector.

**Note**

The anamorphic lens mounting kit is partially pre-assembled at the factory – the AutoScope lens motor and lens mounting assemblies are both fully assembled.

CineWide with AutoScope: Line up the eight mounting holes on the lens motor housing with those on the bottom of the projector.

Secure the motor to the projector with the eight screws provided for this purpose.

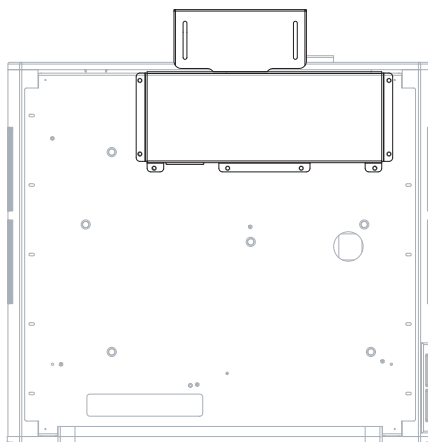

Fixed CineWide: Line up the seven mounting holes on the lens mount base plate with those on the bottom of the projector, directly below the primary lens. Secure the base plate to the projector with the screws provided for this purpose.

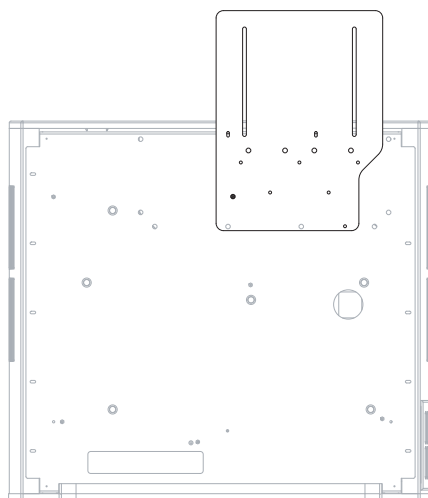

3.5 Installing the Optional CineWide Lens Mount

◀ **Remove Projector Front Feet (CineWide with AutoScope)**

◀ **Install Anamorphic Lens Motor (CineWide with AutoScope) or Base Plate (fixed CineWide)**



Caution

DO NOT OVER-TIGHTEN THE SCREWS.

**Install Projector Stand
(CineWide with AutoScope,
Floor-Mount)**

(Skip this step if you are installing a fixed CineWide anamorphic lens, or ceiling-mounting an AutoScope-equipped projector.)

If you are installing the Vision 140/150 in an upright position (not ceiling-mounted), use the supplied hardware to attach the projector stand to the bottom of the projector as shown below. This stand allows the projector to lie flat on the mounting surface with the AutoScope lens motor installed.

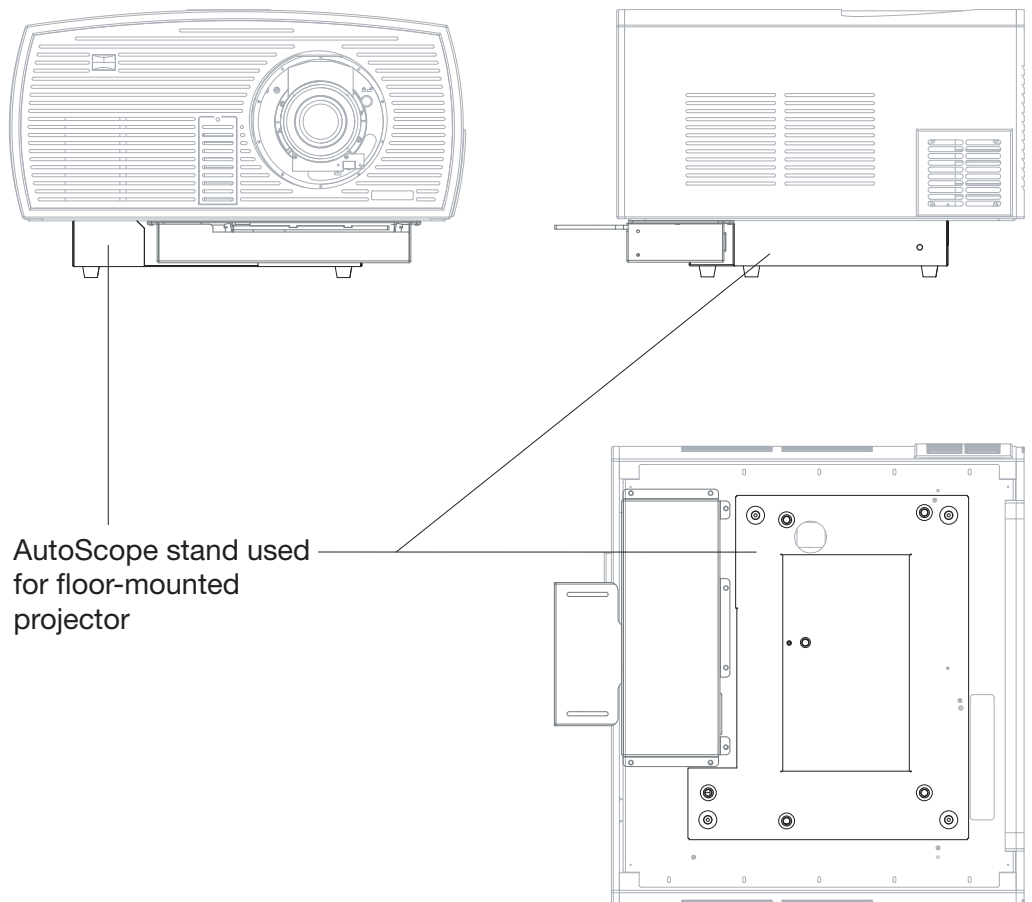

There are several methods for mounting the projector. Depending on your chosen installation, one method may be more suitable than another.

In typical front and rear screen installations, the projector can be mounted to a secure and level surface such as a table or cart. Carts are useful when moving a projector during a presentation or from site to site. If possible, lock the wheels when it's in position to prevent it from being moved during a presentation.

For fixed installations, and for those that want the projector out of sight or have a limited space for projector and audience, you can invert the Vision 140/150 and suspend it from the ceiling using a specially-designed ceiling mount fixture.



Note

Use only the Vidikron-approved ceiling mount kit (part number 956-0096-00 or equivalent) designed for your projector. Install the mount kit according to the instructions provided with it.

The projector can also be inverted and placed in an enclosure above and behind the viewing area. Install four feet on the inside bottom surface of the enclosure on which the projector can rest. A variety of materials can be used for this purpose (for example, rubber crutch tips or turntable feet).

If the Vision 140/150 is ceiling-mounted and the screen is significantly lower than the projector, you can tilt the projector at an angle by adjusting the ceiling mount.

The projector can be rotated (front-to-back) up to 360 degrees and mounted without it affecting performance. However, to ensure optimal performance of the lamp, limit the side-to-side tilt of the projector to ± 15 degrees; see Figure 3-8.

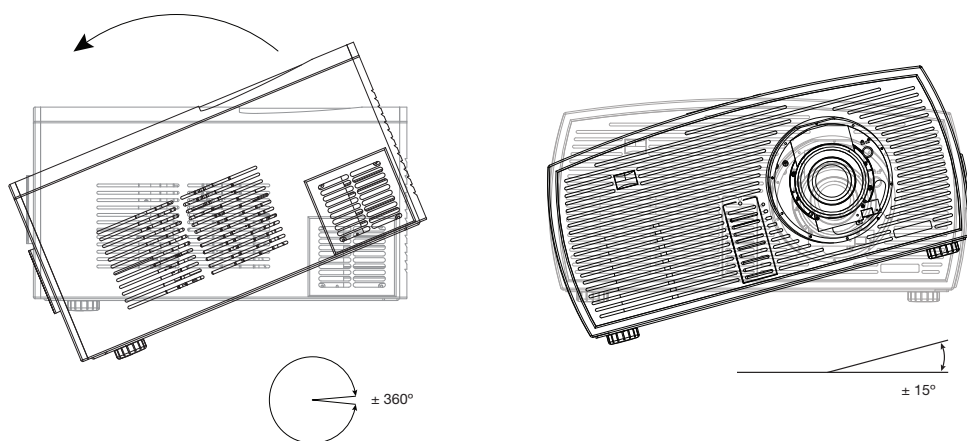

Figure 3-8. Mounting Angle Ranges (Front-to-Back and Side-to-Side)

For a floor (non-AutoScope) installation, turn the two adjustable feet on the bottom of the projector to adjust the projection angle.

If you do either of these things, you may need to make keystone adjustments or vertically shift the image using the on-screen display (OSD) controls, to compensate. For detailed instructions, refer to **Using the On-Screen Menus** on page 63.

3.6 Mounting the Vision 140/150

◀ Floor Mounting (Upright)

◀ Ceiling Mounting (Inverted)

◀ Adjusting the Projection Angle

3.7 Connections to the Vision 140/150 and VHD Controller

Proceed as follows to connect the VHD Controller to the Vision 140/150, your video sources, external controller(s) – if present – and AC power.

When connecting your equipment:

- Turn off all equipment before making any connections.
- Use the correct signal cables for each source.
- Ensure that the cables are securely connected. Tighten the thumbscrews on connectors that have them.

Connector Panel Access ➤

To access the connector panel, press the door release button so it pops out. Turn the knob clockwise or counter-clockwise and pull **gently** on it to open the door.

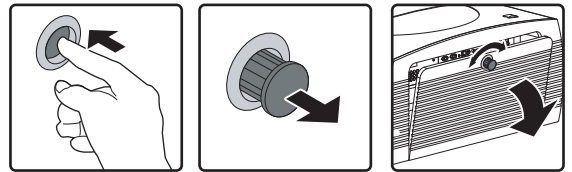

Connecting the VHD Controller to the Vision 140/150 ➤

Connect the HDMI and RS-232 outputs from the VHD Controller to the corresponding inputs on the Vision 140/150; see Figure 3-9.

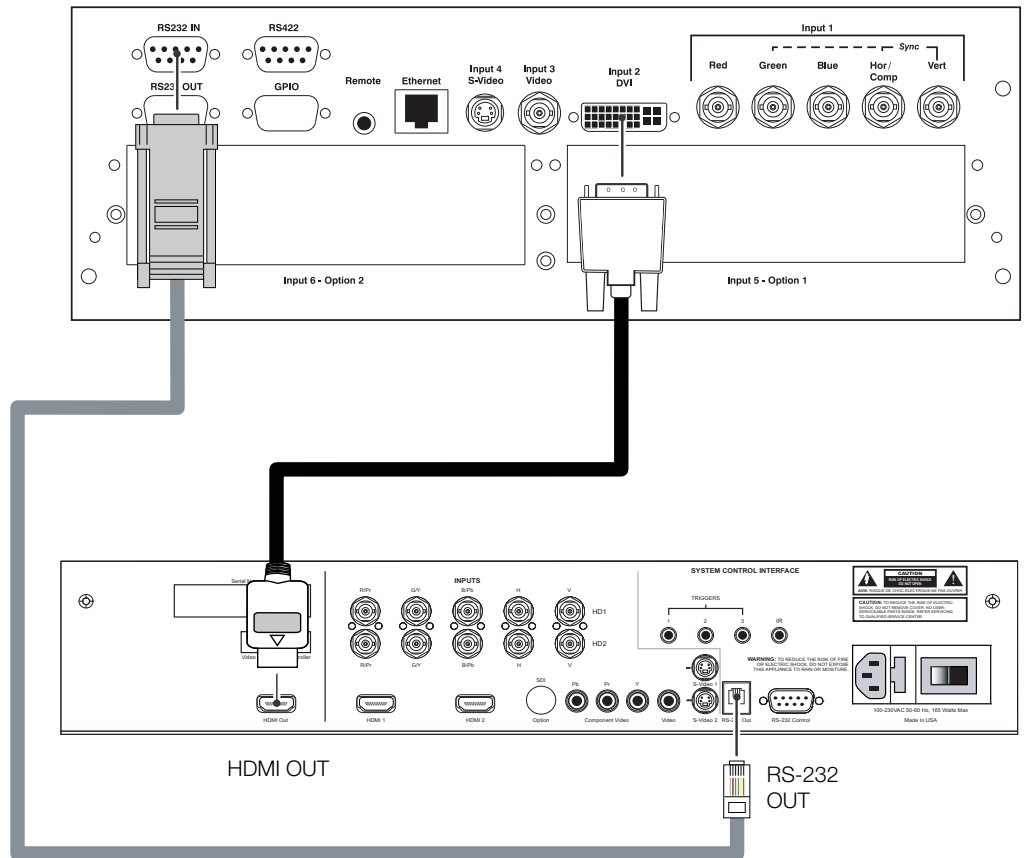

Figure 3-9. Connecting the Vision 140/150 to the VHD Controller

Connect your video sources to the VHD Controller as shown and described in the sections that follow.

◀ **Connecting Source Components to the VHD Controller**

HDMI Connections: See Figure 3-10.

Use the HDMI inputs whenever possible. This ensures the highest video quality because the signal is carried in the digital domain throughout the entire signal path, from source component output into the projector.

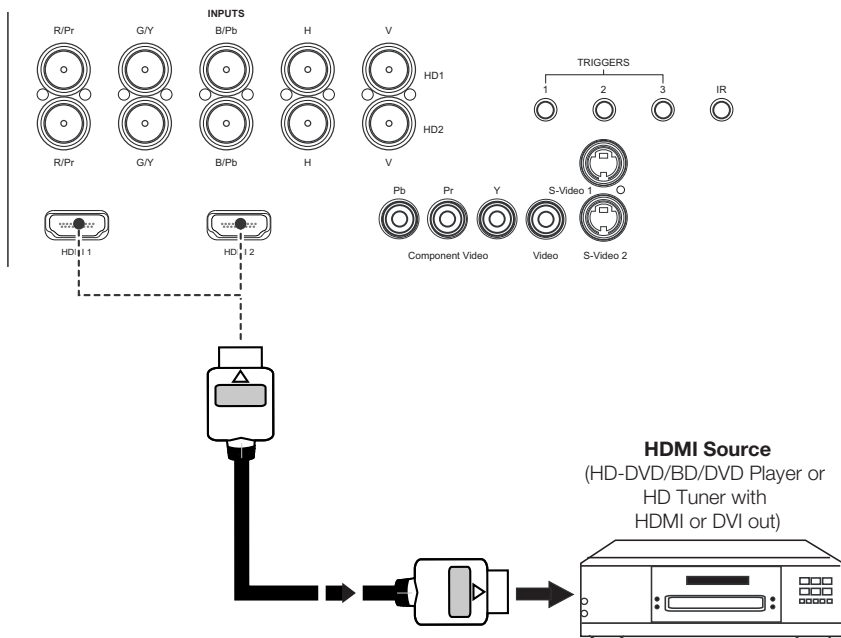

Figure 3-10. HDMI Source Connections

Digital (DTV) RGB or Component Video Connections: See Figure 3-11.

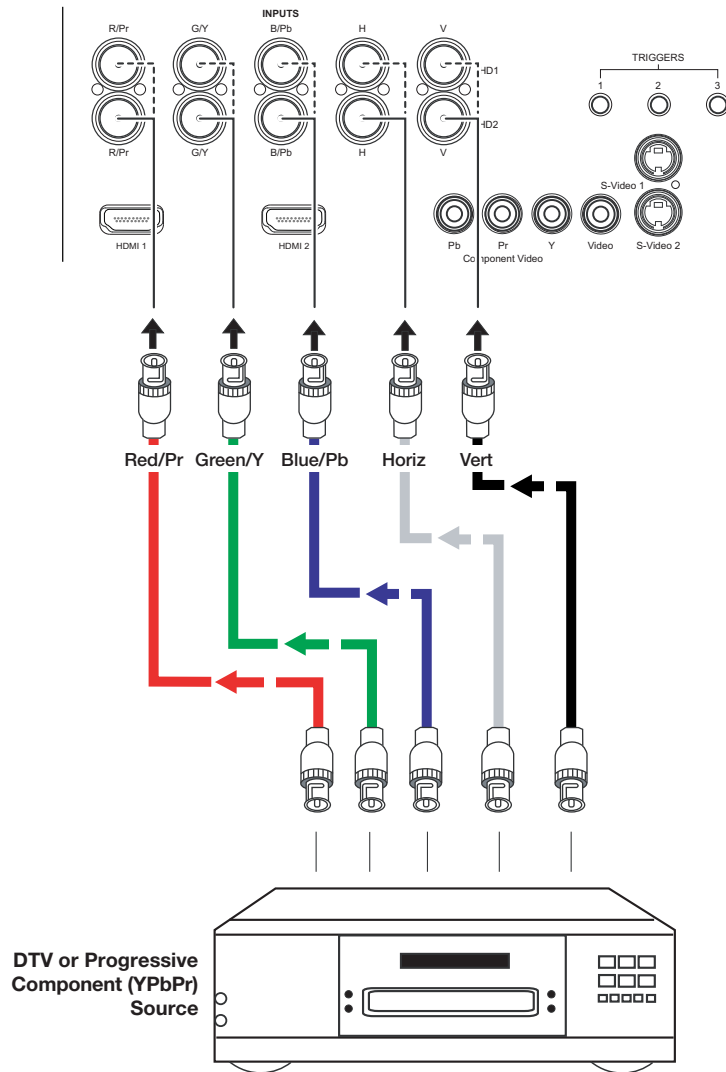

Figure 3-11. Digital (DTV) RGB or Component Video Connections

Analog (Computer) RGB Connections: See Figure 3-12.

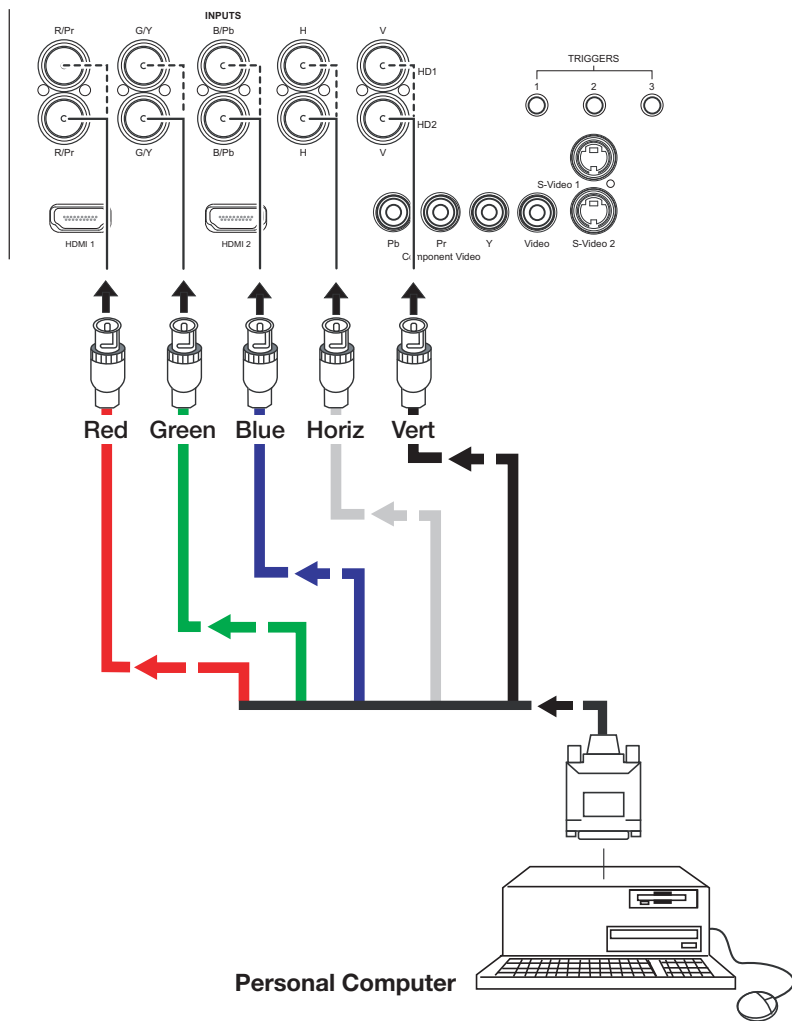

Figure 3-12. Analog RGB Connections

Composite/S-Video/Component Video Connections: See Figure 3-13.

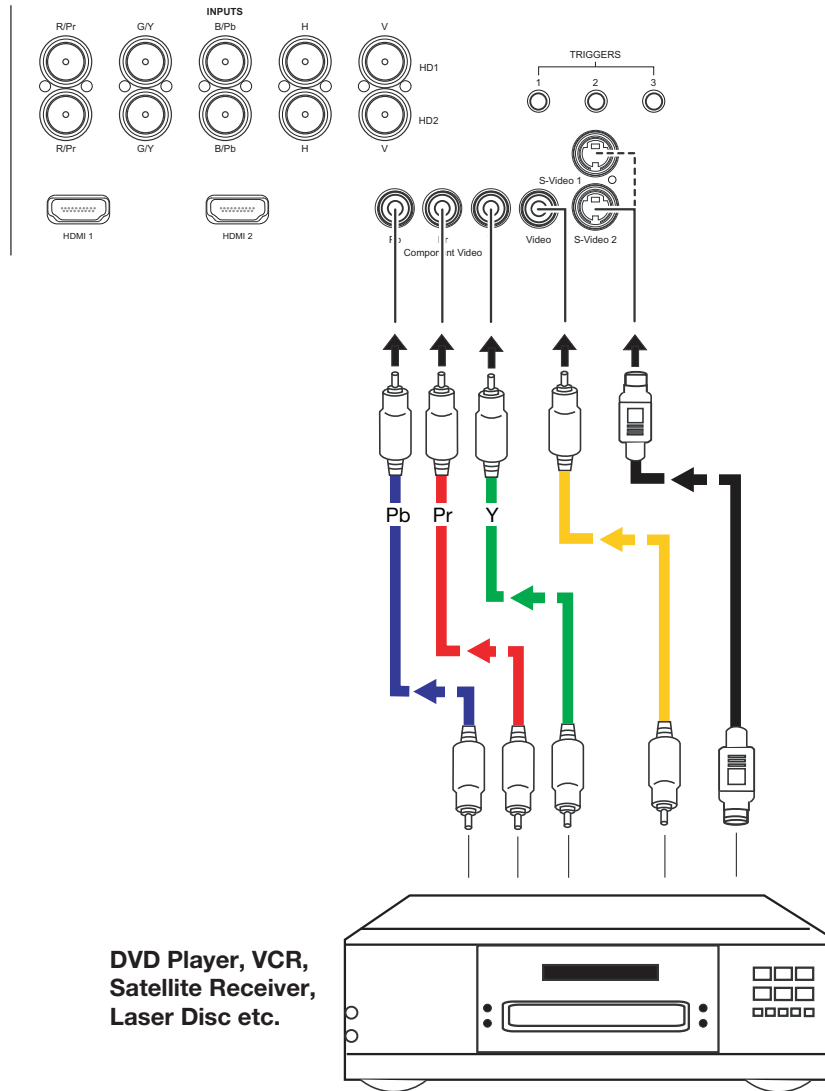

Figure 3-13. Composite, S-Video and Component Video Connections

Use a straight-through, 9-pin RS-232 cable to connect a PC or home theater control/automation system (if present) to the RS-232 Control port on the VHD Controller; see Figure 3-14.

◀ **RS-232 Controller Connection**

For more information about using this connection, refer to **Serial Communications** on page 91.

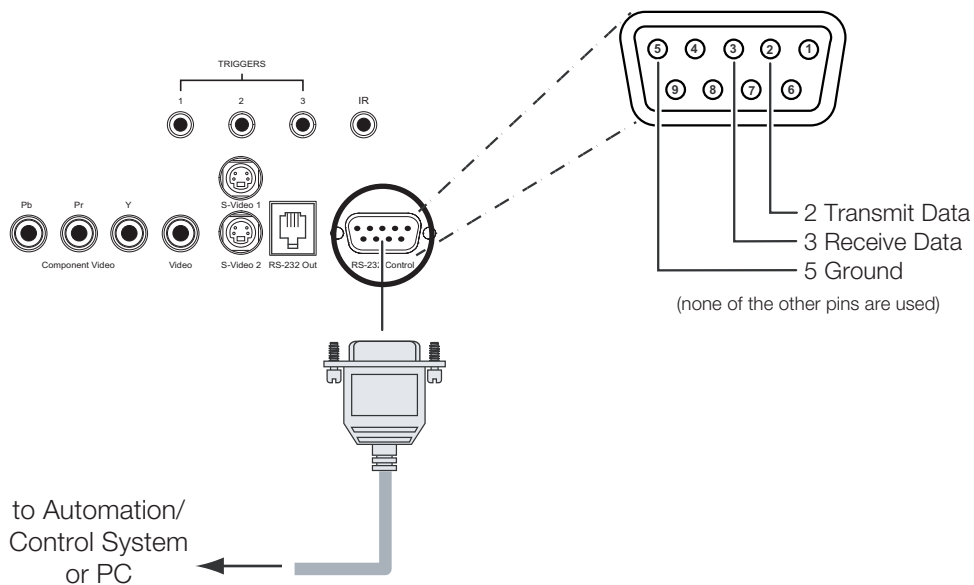

Figure 3-14. RS-232 Control System Connection

Connecting 12-Volt Trigger Outputs to External Theater Equipment

If your Vision 140/150 is equipped with a CineWide with AutoScope system, connect the AutoScope lens motor to a 12-volt trigger output on the VHD Controller; see Figure 3-15. Similarly connect other 12-volt trigger-activated equipment (such as retractable screens or screen masks) to the other trigger outputs.

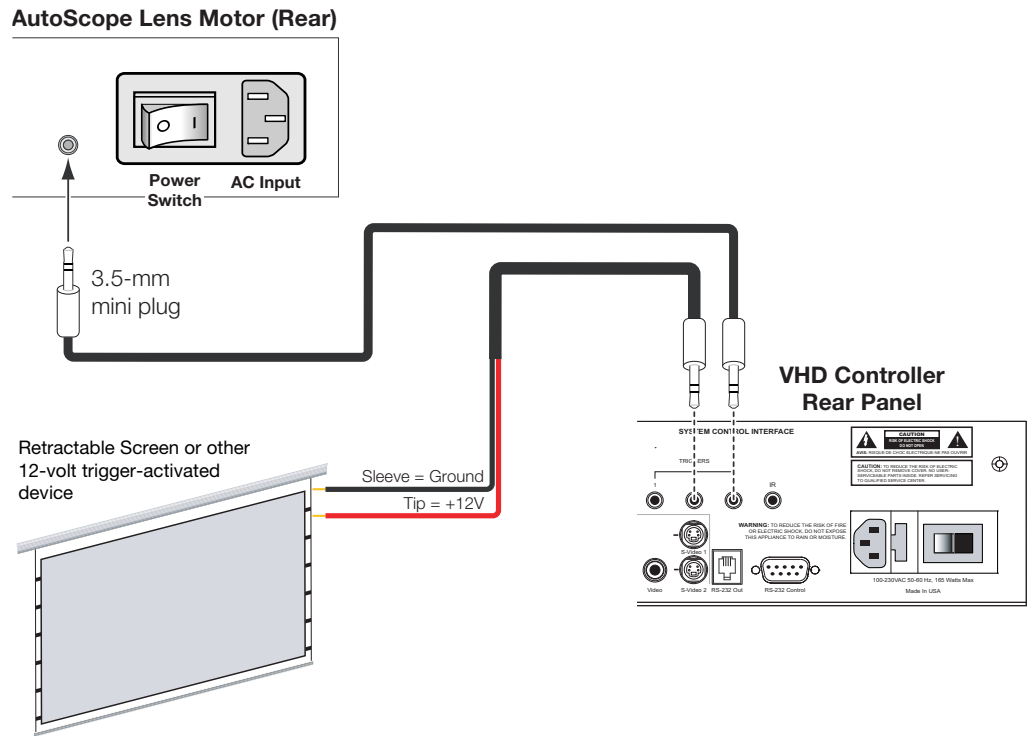

Figure 3-15. Connecting 12-Volt Trigger Outputs

If infrared signals from the remote control cannot reach the VHD Controller due to excessive distance or obstructions such as walls or cabinet doors, you can connect an external IR receiver to the VHD Controller to extend the range of the remote control. See Figure 3-16.

◀ **Connecting an External IR Receiver to the VHD Controller**

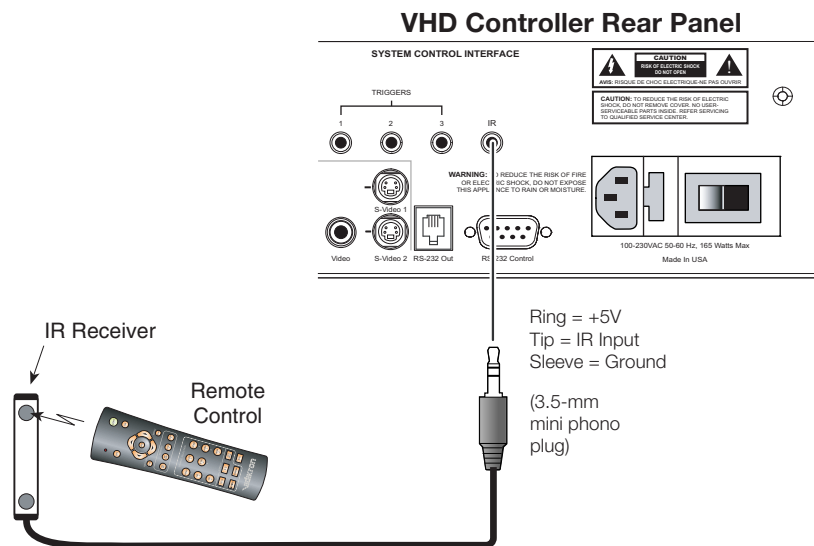

Figure 3-16. External IR Receiver Connection



Note When an external IR receiver is connected to the wired IR input, the built-in IR sensor on the VHD Controller is disabled.

The Vision 140/150 system includes two (2) AC power cords (one each for the VHD Controller and projector).

◀ **Connecting to AC Power**

VHD Controller: Plug the female end of one power cord into the AC receptacle on the rear of the VHD Controller. Connect the other end to your AC power source (100 to 240 VAC).

Projector: Similarly connect the Vision 140/150 to a nearby AC outlet. The input voltage to a Vision 140 must be between 100 and 240 VAC. The input voltage to a Vision 150 must be between 200 and 240 VAC.

The LED status window displays an active pattern of segments to indicate the projector is changing its state from powered down to powered up. “--” appears in the display when the projector is ready to be turned on.

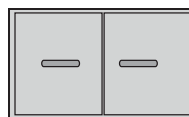

AutoScope Lens Motor: With AutoScope-equipped projectors, a third power cord is provided for the lens motor. Plug the female end of the AC power cord into the AC receptacle on the rear of the lens motor assembly. Connect the other end to a 110 VAC power source.



Caution The input voltage to the AutoScope lens motor must be between 100 and 120 VAC. **Do not connect the AutoScope lens motor to a 200-240 VAC power source!**

3.8 Turning on the Power

1. Turn on your source components.
2. Turn on the main power switch at the rear of the VHD Controller.
3. If this is an AutoScope-equipped projector, turn on the main power switch at the rear of the AutoScope lens motor. The lens motor power switch is located next to the AC input (see Figure 3-15).
4. Press the **ON** button on the remote control – or the **POWER** button on the VHD Controller front panel – to turn on the system. The vacuum fluorescent display on the VHD Controller front panel briefly displays “Starting Display.”

The LED status window at the rear of the projector displays an active pattern of segments to indicate that it is changing its state from “standby” to “on.”

5. When the projector has completed its initialization and is ready for use, “On” appears in the projector LED status window.

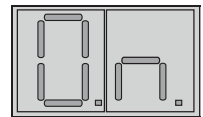

The fluorescent display on the VHD Controller indicates the active source, signal format (NTSC or PAL), input resolution and aspect ratio; for example:

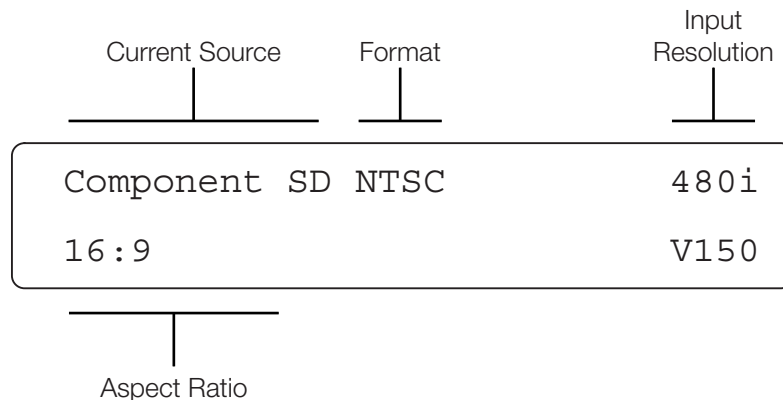

By default, the Vision 140/150 is configured for a “floor/front” installation, in which the projector is installed upright and in front of the screen. If it is installed behind the screen and/or mounted on a ceiling, you must change the picture orientation. To do this:

1. Select an input OTHER THAN HDMI 1 or HDMI 2 on the VHD Controller.
2. On the VHD Controller, press **MENU** and enter the Service Menu passcode.
3. Select **Service** from the Main Menu.
4. Select **Display Device** from the Service Menu.
5. Select **Configure** from the Display Device menu, then select **Installation**.
6. Choose Floor/Rear, Ceiling/Front or Ceiling/Rear, to match the installation method.

To access the motorized primary lens controls:

1. On the VHD Controller, press **MENU** and enter the Service Menu passcode.
2. Select **Service** from the Main Menu.
3. Select **Display Device** from the Service Menu.
4. Select **Configure** from the Display Device menu, then select **Lens**.

The Lens menu gives you a great deal of control over the picture size, position and focus:

To focus the projected image, use the cursor buttons to highlight “In” or “Out.” Then, press and hold the **ENTER** button.

To make the picture smaller (zoom out), use the cursor buttons to highlight the minus sign (-). Then, press and hold the **ENTER** button.

To enlarge the picture (zoom in), use the cursor buttons to highlight the plus sign (+). Then, press and hold the **ENTER** button.

To change the lens position, use the cursor buttons to highlight “Left,” “Right,” “Up” or “Down” in the Lens menu. Then, press and hold the **ENTER** button to shift the lens in that direction.

3.9 Adjusting the Picture Orientation

3.10 Primary Lens Adjustments

◀ **Focus**

◀ **Zoom**

◀ **Vertical and Horizontal Lens
Shift**

3.11 Installing and Adjusting the CineWide Anamorphic Lens

If you are installing a CineWide-equipped projector, proceed as follows to install and adjust the anamorphic lens. Note that some components shipped with your projector may differ slightly from what is shown in these instructions.



Note

It is extremely important that the primary lens is properly adjusted before you install the anamorphic lens. Ensure that the 16:9 or 4:3 image from the primary lens is perfectly centered on the screen.

Attach Lens Mounting Assembly to Lens Motor Carriage Plate (CineWide with AutoScope) or Base Plate (fixed CineWide) ➤

1. Remove the two Z-Adjustment Levers and 1/4-20 Fiber Washers from the bottom of the lens mounting assembly.
2. Place the Lens Mounting Assembly on top of (or under, if the projector is inverted) the Lens Motor Carriage Plate or Base Plate, so that the two threaded posts at the bottom of the Z-Adjustment Plate pass through the corresponding slots on the carriage plate or base plate.
3. Secure the Lens Mounting Assembly to the plate with the Z-Adjustment Levers and Washers that you removed in Step 1.

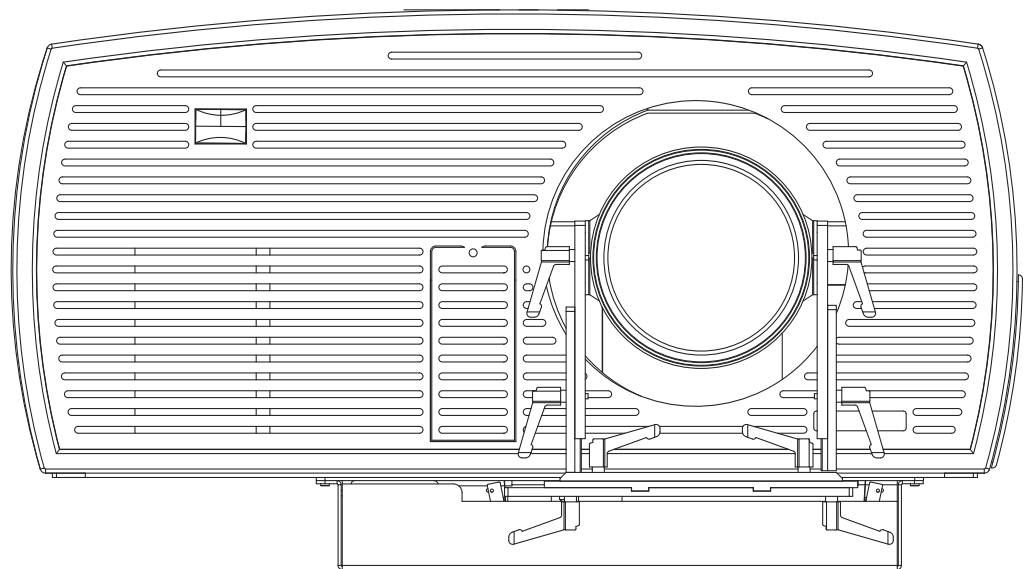

(Skip this step if you are installing a fixed CineWide anamorphic lens.)

CineWide with AutoScope maintains constant image height independent of the aspect ratio, while using the full display resolution of the projector. It accomplishes this by moving the anamorphic lens in front of the primary lens when widescreen material is being viewed. When the viewer transitions back to 16:9 or 4:3 source material, the anamorphic lens moves out of the light path.

To configure the lens motor trigger on the VHD Controller for proper AutoScope operation:

1. Press **MENU** on the remote control and enter the Service menu passcode.
2. Select **Service** from the Main menu.
3. Select **Triggers** from the Service menu.
4. Assign the trigger output to which the lens motor is connected to the Cinema and Intelliwide 2.35 aspect ratios. This enables the lens motor to move the anamorphic lens into position (in front of the primary lens) when either aspect ratio is selected.
5. To save the trigger settings, press ▼ repeatedly to highlight "Save." Then, press **ENTER**.
6. Select the Cinema or Intelliwide 2.35 aspect ratio to move the anamorphic lens into position, if it isn't already. To do this, press **CINEMA** or **SVC** on the VHD Controller remote control (Figure 2-6), or press ▲ or ▼ repeatedly with no menus visible on-screen.

◀ **Configure Lens Motor Trigger
(CineWide with AutoScope)**

Horizontal Position (X) Adjustment:

1. Project a white field on the screen.
2. Loosen the Yaw/X-Adjustment Levers underneath the lens.
3. Slowly move the anamorphic lens into place so that there are no shadows on either side of the screen:

◀ **Adjust the Anamorphic Lens**

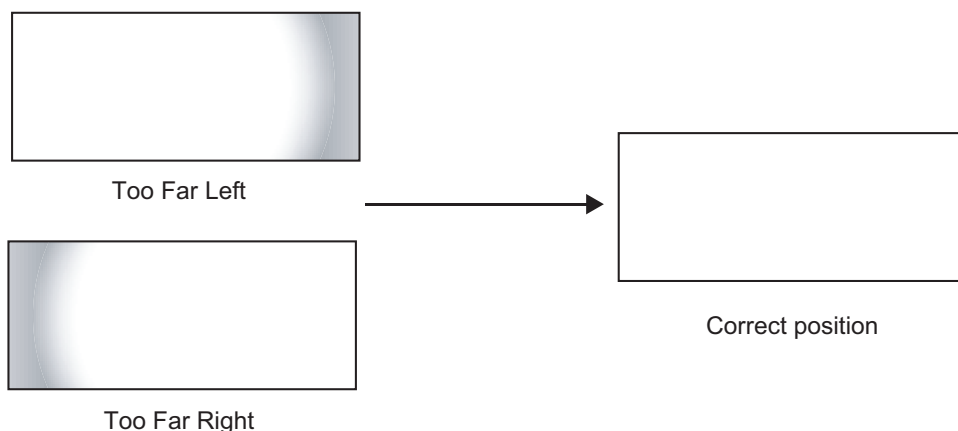

4. When the horizontal position is properly set, tighten the Yaw/X-Adjustment Levers to secure the lens in place.

Height (Y) Adjustment: With the white field still on-screen, loosen the Height Adjustment Levers on either side of the lens. Then, slowly move the anamorphic lens into place so that there are no shadows on the top or bottom of the screen:

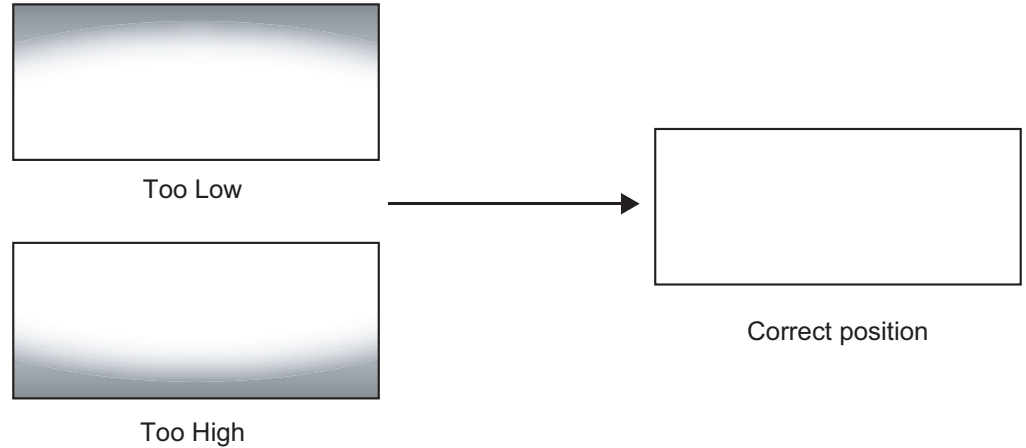

When the height is properly set, tighten the Height Adjustment Levers to secure the lens in place.

Pitch (Angle): Next, angle the lens to even out any top-to-bottom pincushion distortion. To do this, loosen the Pitch Adjustment Levers (directly above the Height Adjustment Levers) on either side of the lens to allow it to pivot freely. Then, adjust the anamorphic lens angle so that the projected image is rectangular:

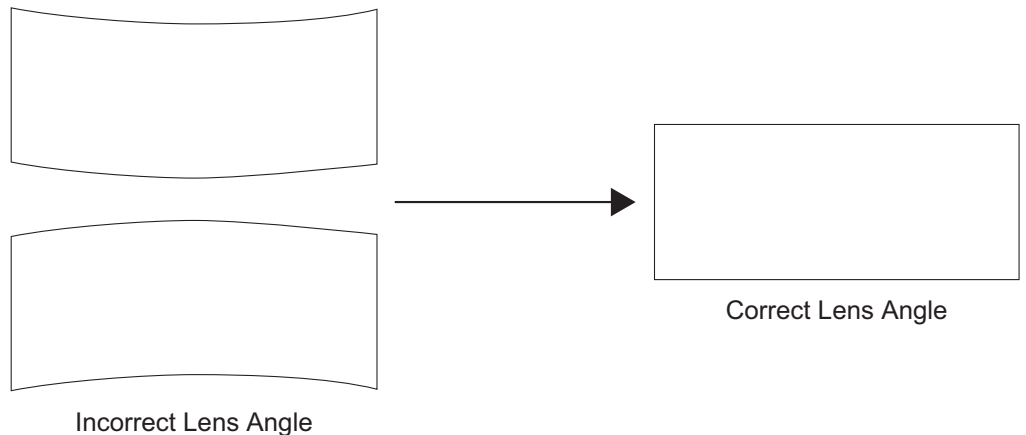

The anamorphic lens will almost always be angled with respect to the projector; this is normal.

Once the proper lens angle has been set, firmly tighten the Pitch Adjustment Levers to secure the lens in place.



Note

There may be some pincushion distortion even after the lens is properly adjusted, especially at shorter throw distances. If this is the case, Vidikron recommends that you slightly over-scan the image into the screen frame area to mask the distortion.

Yaw Adjust: Loosen the Yaw/X-Adjustment Levers to allow the lens to pivot freely from side to side. Then, angle the lens to even out any left-right pincushion distortion:

Anamorphic Lens (Top View)

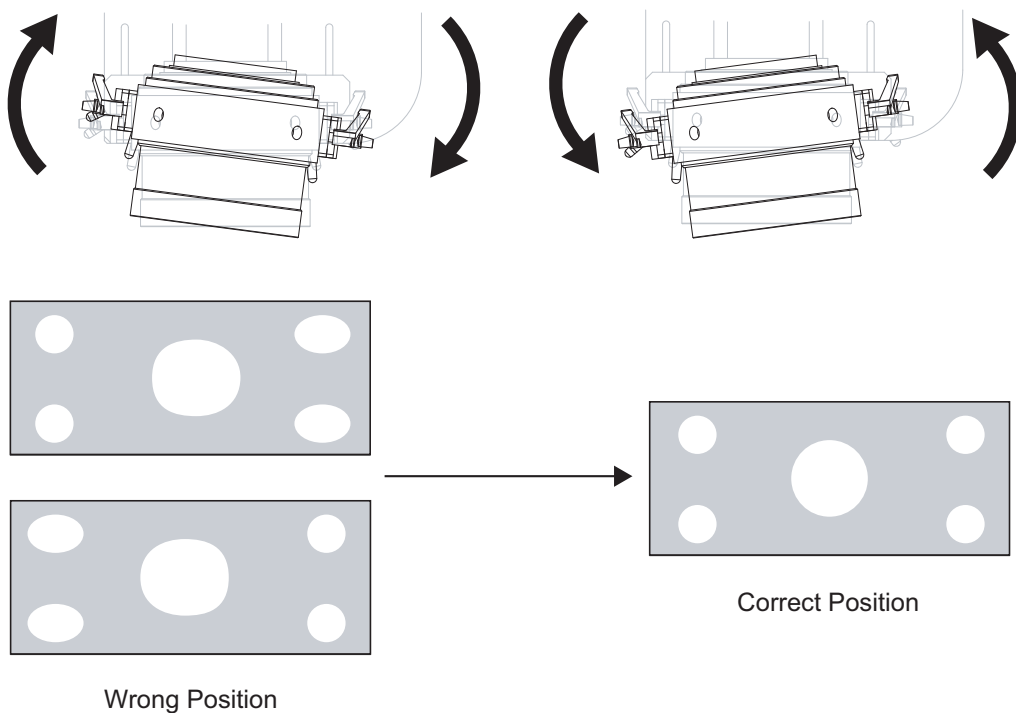

Once the proper lens angle has been set, firmly tighten the Yaw/X-Adjustment Levers to secure the lens in place.

Geometry:

1. Input an anamorphic cross-hatch test pattern to the VHD Controller.
2. Loosen the three Lens Rotation Set Screws (shown at right) on the lens adapter plate just enough to allow it to rotate freely.



3. Grasp the lens by the front ring and rotate the lens until the image is properly anamorphic:

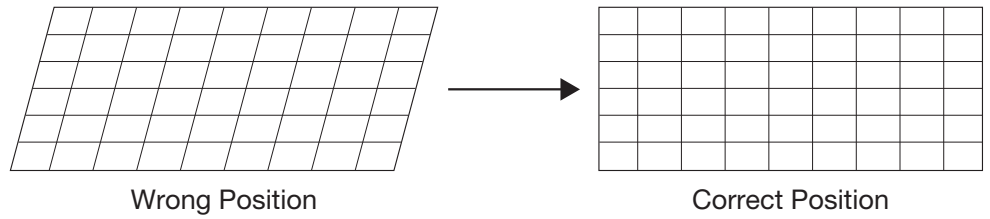

4. When the image geometry appears correct, tighten the three Lens Rotation Set Screws to secure the lens in place. (When viewed from the front, the rear opening on the anamorphic lens should appear as a tall, narrow oval.)



Focus: Finally, rotate the Focus Ring on the anamorphic lens to fine-tune the optical focus. When finished, hand-tighten the Focus Rotation Set Screw to lock the lens in position.



After you have installed and adjusted the projector and lens (or lenses), you are ready to begin calibrating the DVI input (Input 2) to the Vision 140/150.

**Note**

Vidikron calibrates both the Vision 140/150 and VHD Controller at the factory for optimum performance in most typical home cinema environments, before the system ships.

Carefully assess the displayed image quality before proceeding with calibration. In most cases, it is not necessary to calibrate the projector inputs, as the VHD Controller gives you as much control as you will need over the image quality.

Only ISF-certified installation technicians should attempt the calibration procedures described here, and ONLY if absolutely necessary to accommodate an atypical installation.

To perform the calibration, you will use the projector rear-panel keypad (Figure 2-3) or TheaterMaster Remote Control, shown in Figure 3-17 and described on the pages that follow. Once you have completed the projector input calibration, the end user can use the VHD Controller Remote Control (Figure 2-6) to adjust input image quality, change aspect ratios, switch between sources and more. (The exception to this rule is when sources are connected directly to the projector. Although this is technically possible, Vidikron advises against this.)

3.12 Calibrating Projector Input 2 (DVI)

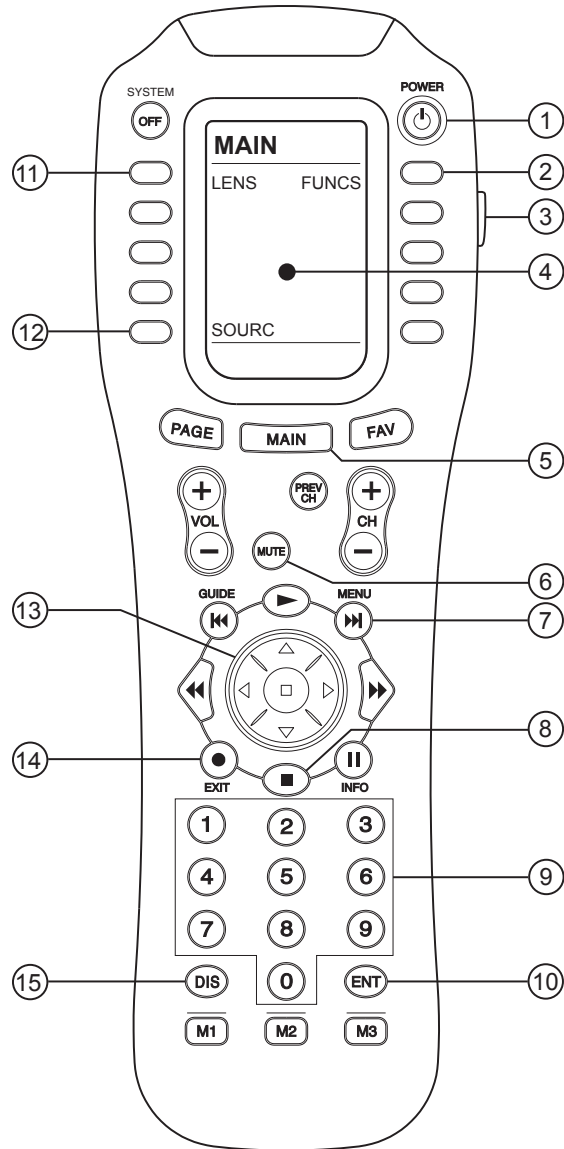
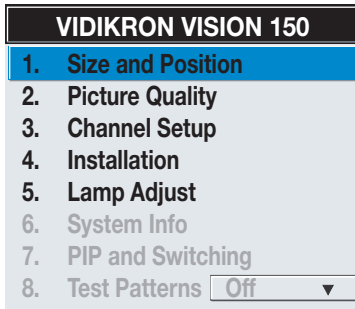

Figure 3-17. TheaterMaster Remote Control for Vision 140/150

1. **POWER Button**
Hold this button down for 1-2 seconds to turn on or off the projector.
2. **FUNCS Button**
This button brings you to a sub-page in which you can access the projector's internal test patterns, view help text, auto-calibrate the projector and perform various other functions.
3. **BACKLIGHT Button**
Lights the LCD display and buttons for use in a dark room.
4. **LCD Display**
Displays currently-selected LCD Menu page.
5. **MAIN Button**
Brings up the Main LCD Menu page.
6. **MUTE Button**
Activates the Shutter control on the projector. Press and hold for one or two seconds to activate the shutter, and press and hold again to de-activate the shutter.
7. **MENU Button**
Displays or hides the on-screen projector menu.
8. **ENTER Button**
Though it has a "stop" icon (and can be programmed as such for other sources), this button serves as an "ENTER" button for the projector when navigating through the menus.
9. **Numeric Keypad**
Used for entering numeric values or passcodes. Also allows direct selection of numbered on-screen menu items.
10. **ENTER Button**
Same as 8.
11. **LENS Button**
Brings up the lens adjustment LCD Menu for making zoom, focus and shift adjustments.
12. **SOURC Button**
Brings up the projector's source selection LCD Menu.
13. **Directional Keypad**
The directional keypad (large, black button just above the numeric keypad) behaves similarly to a joystick. Press the left or right side of this button to change a sidebar value or to select a different option within a pull-down list without having to first scroll through options. Press the top or bottom of this button to navigate within a menu, pull-down list or text box.
14. **EXIT Button**
When in the menu structure, the EXIT button brings the menu back one page or cancels the current function.
15. **FUNCTION Button**
Though labeled **DIS**, this button has been programmed as a "function" button used in several menu items. (You can also use the **FUNCN** button in the Functions LCD Menu.)

◀ **TheaterMaster Remote
Control Functions**

Navigating the Projector Menus ➤



Most of the controls for the projector are accessed from within the projector's menu system. There are several groups of related functions, with each group selectable from the Main Menu. Press **MENU** on the rear keypad or TheaterMaster remote to display this menu.

To select a sub-menu using the remote keypad, do one of the following:

- Press the number key corresponding to the function menu you wish to access, such as **2** for the Picture Quality menu.
- Press **▲** or **▼** on the directional keypad to highlight the desired option, then press **ENTER** or **▶**.

The corresponding function menu or pull-down list of further options will then appear.

You navigate the function menus in a similar manner: enter a menu option number for any numbered option, or use the **▲** and **▼** keys to highlight the desired option, then press **ENTER**. Extra long menus have a scroll bar on the right; use the arrow keys to access the remainder of the menu. Locked items or items that do not pertain to the current action or condition appear dimmed and cannot be selected.



Note

1. If there is no signal present, all source-dependent adjustments are disabled.
2. After 15 minutes of inactivity, the projector leaves the menu system and returns to the presentation.
3. The System Info menu is read-only.

When finished with a function menu, do one of the following:

- Press **EXIT** to return to the previous screen.
- Press **MENU** to leave the menu system and return to the presentation.

To set up the Vision 140/150 for use with the VHD Controller, you will use the **Channel Setup, Size and Position, Picture Quality, Installation** and **Lamp Adjust** menus.

Channel Setup ➤

The projector stores and automatically recalls up to 50 different channels (source setups) for a variety of inputs. This memory feature allows you to define and conveniently use a wide variety of customized setups rather than having to repeatedly re-configure the projector for different presentations. Each projector input can have several different channels associated with it.

All available channels are listed in the Channel Setup menu (Figure 3-18), which describes how each channel can be accessed and which serves as the gateway for editing, copying and deleting channels.

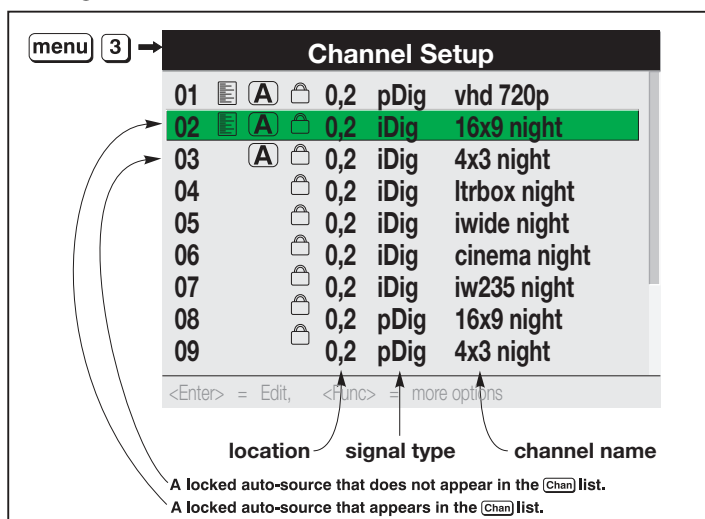
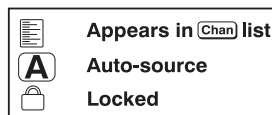

Figure 3-18. Channel Setup Menu

To display the Channel Setup menu, press **3** or highlight **Channel Setup** and press **ENTER** or **►**. The Channel Setup menu appears with the active channel highlighted.

What Appears in the Channel Setup Menu: This menu lists all channels defined so far and indicates where they are connected on the input panel.

The far-left column lists channel numbers currently defined. If a channel has been assigned a name, that name appears in the far-right column; otherwise, the horizontal and vertical frequencies of the input signal appear here instead. Remaining columns contain details pertaining to each channel setup, such as its switcher number (always 0 = projector), slot location, a variety of icons indicating access to each channel, and an abbreviated description of each signal type.



Signal Type Abbreviations: The Channel Setup menu identifies signal types in a shortened form. These descriptors indicate what signal information the projector uses to identify a match for a given channel, and are preceded by either an "i" (for interlaced signals) or "p" (for progressive signals).

When used with the VHD Controller, the HDMI output signal is either "pDig" or "iDig."

Unlocking Channels: Channels are pre-configured at the Vidikron factory for use with the VHD Controller, and are locked to prevent the factory settings from being over-written accidentally. For 1080i and 1080p digital signals, there are separate channels for each aspect ratio and "ISF" memory preset (day and night).

Before proceeding with calibration, unlock the currently-active channel so that any changes you make are stored in that channel.

To unlock a channel:

1. Select **Channel Setup** from the Main Menu to display the Channel Setup menu.
2. The active channel should be highlighted. Press **ENTER** to go to the Channel Edit submenu.

3. Select Locked from the Channel Setup menu and press **ENTER** to clear the check box.

Channel Edit			
1.	Name	16x9 night	Sync Type: Digital Encrypted
2.	Number	02	H-Sync: 26.97 kHz
3.	Input	2	V-Sync: 23.98 Hz
4.	In Menu	<input checked="" type="checkbox"/>	Interlace: No
5.	Auto Source	<input checked="" type="checkbox"/>	
6.	Locked	<input checked="" type="checkbox"/>	
7.	Previous Channel		
8.	Next Channel		

Clear this check box to unlock the channel

Figure 3-19. Unlocking a Channel

- Auto Setup** ➤ Use the Auto Setup feature of the Vision 140/150 as a convenient starting point for calibrating the projector DVI input for optimum picture quality.



Note

*You cannot use Auto Setup with a locked channel; you must unlock it first. Refer to **Unlocking Channels** on page 49.*

Auto Setup is an automated process in which the projector quickly optimizes critical display parameters such as size, position and pixel tracking, based on the type of incoming video signal. An Auto Setup allows you to quickly get the image “in the ballpark” after which you can perform further calibration, if necessary.

To perform an Auto Setup, do one of the following:

On the Theater Master Remote Control: Press **FUNCS**, then **AUTO** followed by **Enter**. When the Auto Setup completes, press **Enter** again to keep the new settings.

On the Projector Rear Keypad: Press **AUTO SETUP** followed by **Enter**. When the Auto Setup completes, press **Enter** again to keep the new settings.

On the VHD Controller Remote Control: Press **MENU**, then select **Service** from the Main menu. Select **Display Device** from the Service Menu. Finally, select **Configure** from the Display Device menu, then select **Auto Setup**.

What an “Auto Setup” Does: Auto Setup sets the following parameters to their default values:

- White Level (Contrast)
- Black Level (Brightness)
- Pre-Calibration (Auto Input Level) (off)
- Sharpness (Detail) (if video source)
- Filter
- Luma Delay

Auto Setup also optimizes the following settings, based on the characteristics of the incoming signal:

- Pixel Tracking
- Pixel Phase
- Size and Blanking
- Height
- Position
- White Balance (Input Levels)

If additional fine-tuning is necessary after performing an Auto Setup, continue with the next section.

In the Size and Position Menu, you can increase or decrease the size of your image, change its proportion (aspect ratio), move the image to a specific area of the screen, and refine other related parameters. Use Size and Position controls to match the image precisely to the screen. Changes made in the Size and Position menu take effect immediately and are saved when you exit the menu.

Size Presets: Select a Size Presets option to quickly display an image in its native resolution or to automatically resize an image to closely fill the projector’s native resolution of 1920x1080, or to optimize the display width or height.

◀ **Size and Position Menu**

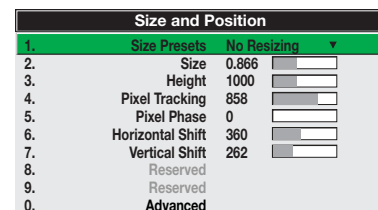

Note

The “native” aspect ratio is with the primary lens only. With an anamorphic lens in the light path, the aspect ratio is 2.35:1.

Size, Position and Blanking parameters automatically adjust accordingly. If Blanking is set first, which defines an Active Input Area, Size Preset scaling occurs in this region of interest only.

The default setting is either **No Resizing** or **Custom**, depending on the input signal resolution. **Do not change it unless specifically instructed to do so by Vidikron Technical Support.**

- **No Resizing:** Select No Resizing to display the image in its native resolution, which may or may not match the projector’s resolution. For example, for a computer display with a native resolution of 800 x 600, “No Resizing” uses the central 800 x 600 pixels and has a black border – the black border areas are unused pixels.

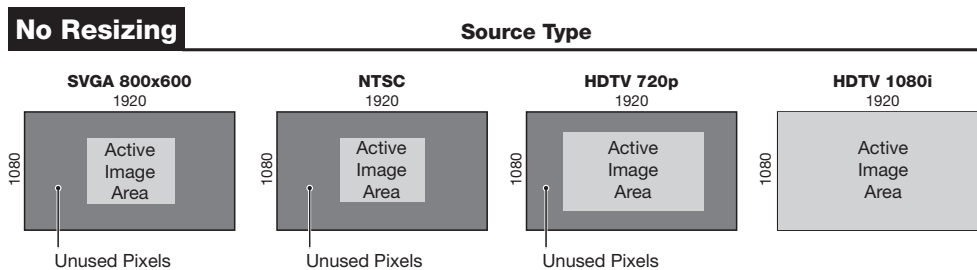

Figure 3-20. Resize Presets: No Resizing

For 1080i digital and 1080p signals, channels are pre-configured at the Vidikron factory for each aspect ratio. These channels use **Custom** size presets to achieve the selected aspect ratio.

- **“Custom” Resizing:** The “Custom” re-size descriptor automatically appears in the Size and Position menu when any of the values for Size, Height, Horizontal Shift, Vertical Shift or Blanking do not correspond to those for a preset. This option is not offered in the Size Presets pull-down list.

Other resizing options are described below, for the sake of completeness. In actual practice, though, they are rarely (if ever) used when the Vision 140/150 is used with the VHD Controller.

- **Default Resizing:** When you select a new source, the image utilizes as much of the projector’s display area as possible for the type of incoming source data, but with minimal or no changes to aspect ratio. The image will be centered and displayed as large as possible depending on the source type and projector model:
 - A video image or 4:3 graphic image is enlarged to fill the screen height, centered between black side bars.
 - A 5:4 graphic image is enlarged to fill the screen height and is centered between black side bars.
 - An anamorphic (16:9) image fills the whole screen.
- **Full Size:** Select Full Size to use all pixels for displaying the image, regardless of source or original aspect ratio. Incoming source material having a different aspect ratio than the projector will be stretched to fill the display.
- **Full Width:** Select Full Width to fill the projector’s display from left-to-right without changing the original aspect ratio of the image. Depending on the source, data at the top and bottom may be discarded (cropped), or the display may have black borders at the top and bottom (called “letterbox”).
- **Full Height:** Select Full Height to fill the display from top-to-bottom. Depending on the source, this may create borders.
- **Anamorphic:** Select Anamorphic to display an anamorphic image in its native 16:9 aspect ratio. The image will fill the whole screen.

Size: “Size” controls both the image width and height in tandem, maintaining the current aspect ratio (proportion) of the displayed signal data.

Height: “Height” adjusts the image height while keeping the width constant. Use this setting to change the aspect ratio of the display.

Pixel Tracking: Steady flickering or several soft vertical stripes or bands across the entire image indicates poor pixel tracking. Proper pixel tracking helps ensure that the image quality is consistent across the screen, that aspect ratio is maintained, and that pixel phase can be optimized (see below). Tracking determines the frequency of the pixel sampling clock, indicated by the number of incoming pixels per line, so that all pixels generated by a particular source are sampled.

By default, the projector samples at the correct frequency for most sources. For best results, use a good test pattern such as a smooth gray consisting of a clear pattern of black and white pixels, or a similar “half on, half off” graphic image. Adjust the slider until the vertical stripes broaden to the point where one large stripe fills the image. If the image still exhibits some shimmer or noise, adjust Pixel Phase (described below).

Pixel Phase: Adjust pixel phase when the image (usually from an RGB source) still shows shimmer or “noise” after pixel tracking is optimized. Pixel phase adjusts the phase of the pixel sampling clock relative to the incoming signal.

**Note**

Adjust “Pixel Tracking” before “Pixel Phase.”

For best results, use a good test pattern such as a smooth gray consisting of a clear pattern of black and white pixels, or a similar “half on, half off” graphic image. Adjust the slider until the image stabilizes and each pixel is clearly defined. You may notice that you can stabilize the image at more than one point; for example, you may find that the image appearance at “11” is identical to the image appearance at “38.” Use either setting in such cases. If some shimmer from a video or HDTV source persists, use the “Filter” control in the Image Settings menu (described later) to remove high-frequency noise from the signal.

Horizontal Shift: This option moves the image right or left within the area of available pixels.

Vertical Shift: This option moves the image up or down within the area of available pixels.

**Note**

The values shown represent where the approximate center of the image lies in relation to the total number of pixels available horizontally or vertically. This varies widely according to the signal; watch the image while adjusting.

Use options in the Picture Quality menu to alter your image without affecting its size or position. Changes made in this menu are applied immediately and saved when you exit the menu. Options not available for the projector model or source are disabled and appear dim (gray).

White Level (Contrast): “White Level” increases or decreases the perceived difference between light and dark areas of your image (0-100). For best results, keep it under 50. If the White Level is too high, the light parts of the image lose detail and clarity. If it is too low, the light areas will not be as bright as they could be and the overall image will be dim. For best results, start with a low value and increase so that whites remain bright but are not distorted or tinted and that light areas do not become white (“crushed”).

**Note**

If the environment lighting changes, an adjustment of Gamma is recommended (see below).

Black Level (Brightness): “Black Level” increases or decreases the amount of black in the image (0-100). For best results, keep close to 50. Start with a high value and decrease so that dark areas do not become black (“crushed”). Conversely, high brightness changes black to dark gray, causing washed-out images.

Gamma: “Gamma” is a global setting that determines how gray shades are displayed between minimum input (black) and maximum input (white) for all signals. The normal gamma setting of 2.2 is correct for virtually all signals and conditions. If excess ambient light washes out the image and it becomes difficult or impossible to see details in dark areas, lower the gamma setting to compensate.

← Picture Quality Menu

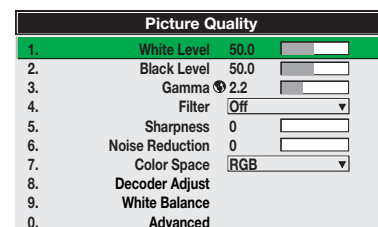

Filter: The proper filter setting is automatically set for virtually all signals, and rarely needs to be changed. It applies a low pass filter for noise reduction in the incoming input signal, particularly for HDTV or SDTV. Applied in the analog domain before sampling, this filtering removes high frequencies and thus reduces pixel phase noise (note this also reduces signal bandwidth). Override only if standard pixel tracking and phase adjustments do not adequately clear up a “noisy” video signal, or if a graphics signal appears overly “soft.” Both instances indicate that “Filter” may be set to the wrong option.

Sharpness: “Sharpness” changes the amount of high-frequency detail in a video image so that edges remain clearly defined. It can be particularly useful if a significant “Noise Reduction” adjustment has caused the image to appear too soft. Adjust until the display is as sharp as desired, keeping in mind that because “Sharpness” adds some high frequencies back into the image, it can also reintroduce a certain degree of noise.

Noise Reduction: Noise Reduction is similar to the “Filter” control, but operates in the post-sampling digital domain with a more subtle effect. Higher settings are most useful for clearing up noisy RGB images such as those from a PC. Adjust as desired, keeping in mind that reducing noise (which reduces high frequencies) may also soften the image.

Color Space: “Color Space” determines how the color components of an analog input signal are decoded for accurate color in the display. With the Vision 140/150, this should always be set to **RGB**.

Decoder Adjust: This sub-menu is not applicable to the Vision 140/150.

White Balance: Good RGB or *white balance* — that is, the white and black levels for each of the three primary colors, red, green and blue — ensure that images from analog sources other than decoded video have maximum contrast without crushing black or white.

By default (and in an “Auto Setup”), the projector automatically determines the best input levels by monitoring image content and adjusting the controls appropriately; further adjustment is typically not required to obtain proper blacks or whites.

However, for a very unusual source exhibiting one or more overly high black levels (typically caused by a noisy source causing black level spikes), an experienced technician may prefer to use the White Balance menu. These adjustments, which together serve as a calibration process compensating for differences in sources and cabling, enable an experienced technician to perfect the source image input levels and eliminate the “overshoot” and “undershoot.”

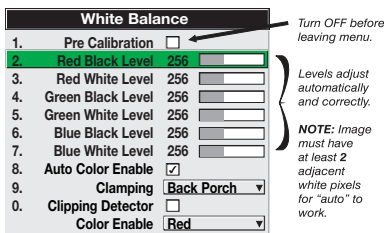

Note

1. The White Balance controls are of limited use with digital signals, but do offer some ability to tweak poorly mastered source materials.
2. Because the projector automatically optimizes input levels for all but the most unusual of sources, it is recommended that only experienced technicians use the White Balance submenu.
3. Before beginning, check that overall White Level and Black Level settings are near 50 and that color temperature is properly set using an internal grayscale test pattern.

- **Pre-Calibration:** Keep off for virtually all sources (default). Temporarily enter a check mark only if you are an experienced technician and you have an unusual source that you feel needs further color temperature and/or white balance adjustment. After entering a check mark, wait for the six sidebar values to stabilize, then clear the check mark and exit. This compensates for incoming, out-of-range white levels and black levels that would cause “crushing” of light and dark colors in the image.

**Note**

1. *There must be at least two consecutive white pixels present in the image for the “Pre-Calibration” function to work properly. Otherwise, input levels may produce skewed colors, particularly in non-video images.*

2. **Uncheck this item before exiting this menu.**

- **Black Levels and White Levels:** To check your image and adjust these controls:
 1. Make sure overall “White Level” (contrast) and “Black Level” (brightness) settings are both set to near 50. (Not required for “Pre-Calibration” adjustment.)
 2. Check the color temperature setup using an internal grayscale test pattern, making sure to obtain a neutral grayscale. (Not required for “Pre-Calibration” adjustment.)
 3. If the blacks and/or whites appear OK, input levels do not need adjustment. If black levels are too high (and/or whites are too low, which is rare), you likely have a noisy source that is producing skewed input levels. Continue with Step 4.
 4. Temporarily enable “Pre-Calibration” in the White Balance submenu. Wait for all six values to stabilize. Alternatively, do not use “Pre-Calibration” — reduce black levels manually instead. Judge by eye and change one or more of the six levels as necessary to obtain proper blacks and whites. You may want to see only a certain color while adjusting; if so, use the “Color Enable” option (described below).
 5. Clear the “Pre-Calibration” check box and exit the White Balance menu.
- **Auto Color Enable:** When a check mark is present, selecting a specific black level or drive to adjust will automatically enable the corresponding color in the display. Delete the check mark to see all colors.
- **Clamping:** This option can brighten the image produced from certain high-resolution, high-frequency graphic sources. For almost all sources, the best clamp location is automatically selected by the projector.
 - Use the normal **Back Porch** location if the image is either sufficiently bright or overly bright.
 - Select **Sync Tip** if the image appears unusually dim, if there are horizontal streaks across the image, or if there is significant color drift. This moves the clamping pulse from the normal back porch location (which is likely too short) to the tip of the horizontal sync pulse.
 - **Tri Level** is typically recommended for an HDTV source where the back porch is also short, or for video sources or any RGB source with sync information included on the video (for example, sync-on-green).

- **Clipping Detector:** The Clipping Detector is a tool to assist with defining individual input levels, enabling you to accurately set the white balance for any particular source with the appropriate image.

Enabling the Clipping Detector activates a special operating mode for detecting only pixels that are considered black or white; all other levels are displayed as a mid-level gray. When used with a smooth grayscale pattern in which black and white are known to be at opposite edges of the image, you can watch these isolated areas while adjusting individual black and white levels until both black and white edges are just visible and distinguished from neighboring pixels. Images from this source will then display correct blacks and whites without crushing.

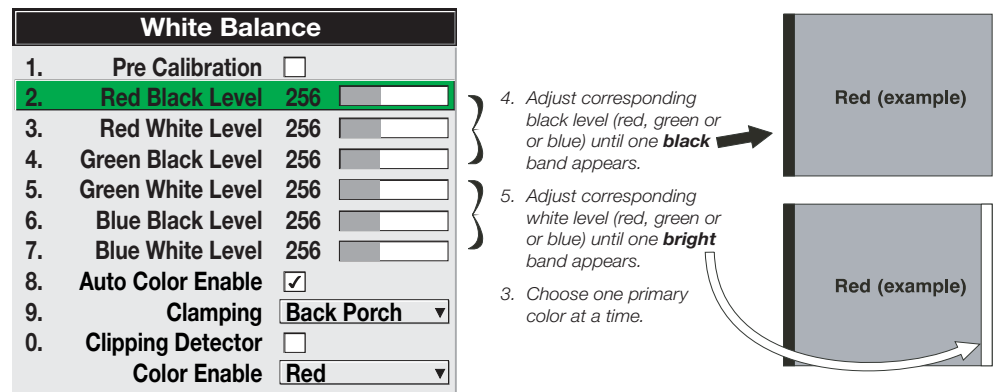

Figure 3-21. Adjusting Black Levels and White Levels Using the Clipping Detector

1. Display a 16-level grayscale test pattern from the VHD Controller.
2. Enter a checkmark in the Clipping Detector checkbox.



Note

The Clipping Detector will initially render the grayscale as a uniform gray field before adjustment or extreme crushing.

3. Display one primary color.

Selecting Auto Color Enable ensures that the correct color is displayed for each setting.

4. For the current color, adjust its corresponding "Black Level" sidebar just until a single band of black appears at one edge of the screen. This band represents the first band of the grayscale pattern, which should be 100% black. Do not adjust too far.
5. With the same color still active, adjust its corresponding "White Level" sidebar just until a single band of color appears at the opposite edge of the screen. This band represents the last band of the grayscale pattern, which should be 100% white (or the current color, if a certain color is enabled). Do not adjust too far.

- It may be advantageous to go back and check the black band. Adjust the blacklevel sidebar if necessary.



Note

Readjusting the black levels affects the gain at this point; only readjust when absolutely necessary.

- Repeat Steps 4 through 6 with the other two remaining primary colors. When each primary color shows one optimized black band and white (or colored) band, the input levels for this source are correctly set. Upon exiting the White Balance menu, the Clipping Detector checkbox will clear.

- Color Enable:** Select which color or colors you want to see in the display. This is useful when working with color temperature white levels or black levels.

When you have finished optimizing the picture quality, lock the channel that you unlocked previously (refer to **Unlocking Channels** on page 49), unlock the next channel and repeat the calibration procedure. Do this for **each** of the remaining channels.

Select **Installation** from the Vision 140/150 Main Menu to access these advanced lamp and lens configuration options:

- LumaCal™, for maintaining constant lamp brightness
- OptiCal™, to save and restore lens positions

◀ **Installation Menu**

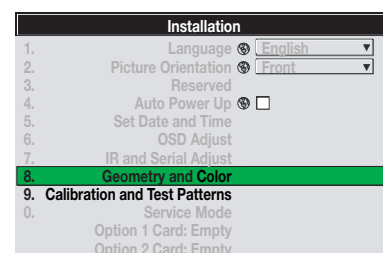

Calibration and Test Patterns – LumaCal (Lamp Calibration): LumaCal defines the range of power needed to maintain lamp brightness over time.



Note

For best results, allow the projector to warm up for 15 minutes prior to using LumaCal.

To use LumaCal:

- Select **Installation** from the Main Menu.
- Select **Calibration and Test Patterns** from the Installation Menu.
- Select **LumaCal** from the Calibration and Test Patterns Menu.
- Select **Calibrate LumaCal** to calibrate the lamp using your projector's unique specifications (recommended). Or, select **Use Default Settings** to undo the effects of a previous calibration.

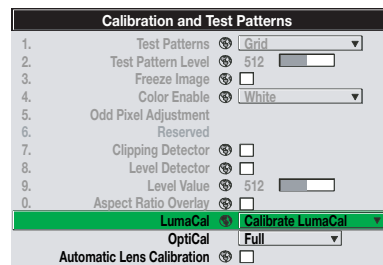

In the event of a power failure, the projector reverts to the default LumaCal settings in which case you should re-calibrate the lamp.



Note

LumaCal lamp calibration takes approximately two minutes.

OptiCal (Primary Lens Calibration): OptiCal provides the ability to store and recall focus, zoom and position settings for the primary lens.

To enable OptiCal:

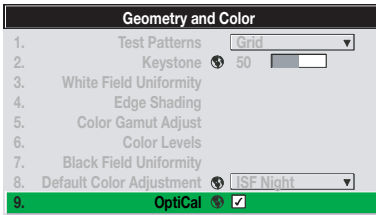

1. Select **Installation** from the Main Menu.
2. Select **Geometry and Color** from the Installation menu.
3. Select **OptiCal** from the Geometry and Color menu.
4. Press **ENTER** to check the box labeled **OptiCal**.



Note

1. *OptiCal control is a preference setting and is retained between power cycles.*
2. *OptiCal has no effect on the secondary anamorphic lens, only the primary lens.*

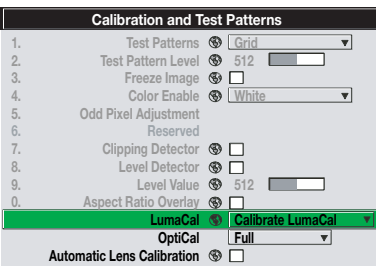

5. Press **EXIT** to exit the Geometry and Color menu.
6. Select **Calibration and Test Patterns** from the Installation Menu.
7. Select **OptiCal** from the Calibration and Test Patterns Menu.

OptiCal gives you a choice of three types of lens calibrations:

- A **Reference** calibration establishes a reference point (starting position) for measuring relative lens movement. All distances are measured from this reference point. A reference calibration is lost when power is removed from the projector and occurs on every power-up as long as OptiCal is enabled.
- A **Motion** calibration determines the characteristics of each motor and values are saved in the projector's memory. If OptiCal is enabled and a motion calibration has previously been done, the projector automatically recalls these settings from memory when it's being powered up and a motion calibration will not take place.
- A **Full** calibration performs both a Reference calibration and a Motion calibration.

If no calibration has previously been done you may be prompted to do a **Full** calibration. If a motion calibration has been done, you will be prompted to complete a reference calibration. If both calibrations have been done, the **OptiCal** checkbox is checked and OptiCal enabled.

When OptiCal is enabled, the Vision 140/150 performs a reference calibration when the projector is turned on. The lens returns to its last saved position (or actual position, if no motion calibration has been done previously). Further adjustments to the zoom, focus and position are automatically saved.

When both OptiCal and **Automatic Lens Calibration** are enabled, the Vision 140/150 performs a **Full** calibration when the projector is turned on. During calibration, the shutter closes and the status LED (see Figure 2-3) displays "LC."



Note

*If OptiCal is disabled (refer to **OptiCal (Primary Lens Calibration)** above), the Automatic Lens Calibration setting has no effect.*

Access the Lamp Adjust menu to:

- Choose a lamp mode for regulating power and light output.
- Change the optical aperture size.
- View information pertaining to past and present lamps.
- Record the lamp serial number in the projector's memory.

Lamp Hours (read-only): Lamp Hours shows the number of hours logged on the current lamp. Whenever you record a new lamp serial number, the Vision 140/150 automatically resets this value to zero and begins to log time for the new lamp.

Lamp S/N (read-only): Lamp S/N is the serial number recorded for the current lamp. When you install a new lamp and enter its serial number, the number appears here.

Lamp Message: Enter a check mark for **Lamp Message** to enable a warning message that appears upon power-up when the lamp has reached the specified lamp limit and should be replaced. Delete the check mark to prevent display of this message – instead, when your lamp expires, only the status display messages on the back of the projector will provide a visual warning to replace the lamp.



Note

1. It is recommended that the Lamp Message check box remain enabled.
2. When a lamp warning message appears, press **EXIT** to temporarily dismiss the warning. The message will continue to appear upon power-up until you install a new lamp.

Lamp Limit: Set Lamp Limit to the number of hours you expect to log on the current lamp before replacing it. This will trigger a lamp message on-screen (if enabled).



Note

1. If you change modes over the life of a lamp, the lamp limit you originally expected may no longer be possible.
2. Turning the lamp on and off reduces lamp life significantly, as do other factors.
3. It is recommended that Lamp Limit not exceed the expected lamp life, otherwise a lamp could become dangerously fragile with overuse.

3.13

Working With the Lamp

Lamp Adjust	
Lamp Hours	147
Lamp S/N	123456789
1. Lamp Message	<input checked="" type="checkbox"/>
2. Lamp Limit	1000
3. Lamp Mode	Power
4. Power	500
5. Intensity	0
6. RVR	3
7. Lamp History	
8. Change Lamp	
9. Reserved	

Lamp Mode: Select the **Lamp Mode** you want to use in order to control the light output. You can choose to run the lamp as bright as possible, you can power the lamp with a specific wattage appropriate for the installed lamp or you can set a specific intensity (brightness) to maintain. Keep in mind that higher lamp power settings can shorten lamp life.

Use the lamp mode that best suits your brightness needs:

- **Max Brightness:** The lamp will always burn as brightly as possible, driven by 100% of the power level rating for the installed lamp (1,000 Watts for the Vision 140 or 1,200 Watts for the Vision 150). Keep in mind that the “maximum brightness” for any lamp gradually diminishes with the “Intensity” option.
- **Intensity:** Brightness will remain close to a specified level for as long as possible. If you select this option, enter a number representing the intensity level (brightness) you want to maintain – the Vision 140/150 automatically adjusts power as needed to maintain this intensity as closely as possible.

Intensity  1246 

This value and slider represents the current brightness of your lamp, decreasing over time when you are operating in Max Brightness mode or at a specific Power level. When you operate in Intensity mode, this value remains at the chosen Intensity setting and cannot be adjusted.



Note

The Intensity value is not the actual lumen output, but rather a correlated value only – 1246 may represent 3500 lumens, for example.

To use “Intensity” mode, judge by eye (or use a meter) and set the level as desired for your application. Over time, the projector will automatically increase the power supplied to the lamp as needed to maintain the chosen intensity as closely as possible.

- **Power:** The power supplied to the lamp will remain at your specified wattage level. Once you select this option, enter the number of watts representing the power level you wish to maintain.

Power  941 

This slider and number indicates how many watts are applied to the lamp. You can apply anywhere from approximately 60% to 65% of the maximum power intended for the installed lamp up to 100% of the lamp rating. Set for the number of watts as desired, keeping in mind that lower power levels produce dimmer images. When in either Power or Max Brightness modes, the power level remains constant. Specifying a maximum power level here is the same as operating in Max Brightness mode.

HOW LONG CAN I MAINTAIN BRIGHTNESS? The Vision 140/150 can maintain your “Intensity” setting until the required power reaches the maximum rating for the lamp. The lower the setting, the longer it will take to reach this threshold and the longer you can maintain the desired brightness. Keep in mind that once the lamp power reaches its maximum wattage (see “Power,” above), this tracking is no longer possible. At this point, the lamp will gradually begin to dim as usual, even though your original “Intensity” value will still appear in the menu. To resume accurate tracking, reduce the intensity setting so that the resulting “Power” value is less than its maximum—the lower the intensity, the longer it can be maintained.

For example, a 1000-Watt lamp can be driven at no more than 1000 Watts. To produce desired brightness at the screen, a new lamp would likely need less than this maximum rating — perhaps 812 Watts (example only). Over time, however, the lamp requires more and more current in order to generate the desired light, until eventually the lamp wattage reaches its 1000-Watt maximum and the lamp power automatically levels off. At this point, the tracking function terminates (that is, the power level stabilizes) and the lamp begins to dim normally. Either reduce your “Intensity” setting or replace the lamp.

Do not lower the “Intensity” so much that the corresponding “Power” value reaches its minimum — the intensity setting will be inaccurate and cannot be maintained.



Note

1. Lamps become more stable over time, thus a specific intensity is more easily maintained as the lamp ages.
2. Intensity can be set only if the lamp is in “Intensity” mode
3. Intensity cannot exceed the output of Max Brightness mode.

Aperture Control: The optical aperture inside the projector controls the diameter of the light beam passing through the system. With a fully open aperture (slidebar default of “0”), the maximum amount of light passes through for maximum brightness in your images. Increase the slidebar setting to reduce the aperture diameter and maximize contrast ratio instead.

Lamp History (read-only): Lamp History shows the lamps most recently installed and recorded in the projector. The Lamp History automatically updates whenever you record a new lamp serial number; the new lamp is added to the end of the list.

Change Lamp: Select **Change Lamp** from the Lamp menu to record the serial number for a newly-installed lamp. For detailed lamp replacement instructions, refer to **Lamp and Filter Replacement** on page 81.

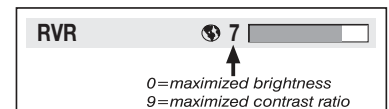

Notes:

Press the **MENU** button on either the remote control or the VHD Controller front panel to display the Main Menu.

To select a menu item, use the ▲ and ▼ buttons on either the remote control or the VHD Controller front panel to highlight it. Press **ENTER** to confirm your selection.

The Vision 140/150 OSD menus are arranged hierarchically, as shown in Figure 4-1. Depending on the selected input source and signal characteristics, some menu options may not be available.

4.1 Using the On-Screen Menus

Input Source	Composite
	S-Video 1
	S-Video 2
	Component SD
	HD/RGB 1
	HD/RGB 2
	HDMI 1
HDMI 2	
Aspect Ratio	16:9
	4:3
	Letterbox
	IntelliWide
	Cinema
	Intelliwide 2.35
Picture	Brightness
	Contrast
	Color
	Tint
	Sharpness
Input Position	Left/Right
	Up/Down
	Width
	Height
ISF Presets	Overscan
	Recall ISF Night
	Recall ISF Day
	Recall/Save Custom 1
	Recall/Save Custom 2
Reset Custom 1 & 2 to Factory Default	
Information (read-only)	Serial Number
	Hardware
	Firmware
	Date

Note: Intelliwide 2.35 is available only on Vision 140/150 projectors equipped with the CineWide option (secondary anamorphic lens).

Calibration	ISF Night - Display Color	Lamp Power
		Lamp Intensity
	ISF Night - Input Image	Brightness
		Contrast
		Color
		Tint
	ISF Night - Input Color	Sharpness
		Gain
		Offset
		Chroma Delay
		Phase
	ISF Day - Display Color	Noise Filter
		Lamp Power
		Lamp Intensity
	ISF Day - Input Image	Brightness
		Contrast
		Color
		Tint
	ISF Day - Input Color	Sharpness
		Gain
Offset		
Chroma Delay		
Phase		
Save ISF Settings	Noise Filter	
	Back / Confirm	
Output Shift	Left/Right	
	Up/Down	
	Width	
	Height	
	Save	
Splash Configure	Owner Name	
	ISF Calibrated	
	ISF Other	
	Vidikron/ISF Logo Splash Screen Timers (2 ... 60 sec.)	
OSD Position	Vert./Horiz., Normal/Wide, Height	

Service	Test Video	Grey Bars 1	
		Grey Bars 2	
		Color Bars 1	
		Color Bars 2	
	Input Names	Rename, Restore or Save	
	Remote Control	Primary	
		Secondary	
	Display Device: Configure	Installation	Picture Orientation
			Keystone
			Lamp Hours (read-only)
			Focus
	Lens	Zoom	
		Shift	
Auto Setup			
HD Format	HD/RGB 1	Auto, RGB or YUV	
	HD/RGB 2		
	ADC Bandwidth	Auto, 75 MHz, 150 MHz or 300 MHz	
	YPbPr Input Resolution	Auto, 480i/p, 576i/p, 720p or 1080i	
Triggers	1 / 2 / 3 / Save		
Miscellaneous	Language	(currently, English only)	
	Menu Mode		
	Timeout		
	Side Bar Color		
	Film Mode (SD sources only)		
System Reset			
Restore Saved Settings			

Figure 4-1. VHD Controller OSD Menu Structure for Vision 140/150

The Main Menu is the starting point for accessing all projector functions.

(The Calibration and Service menus are hidden and not accessible until you enter a passcode.)

◀ **Main Menu**

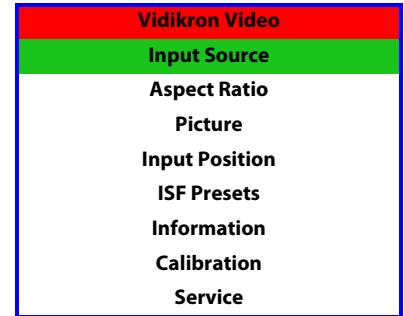

From the Main Menu, select Input Source to choose a video signal source.

The active source is indicated by an arrow (>) to its left; in this example, Composite is the active source.

◀ **Input Source**

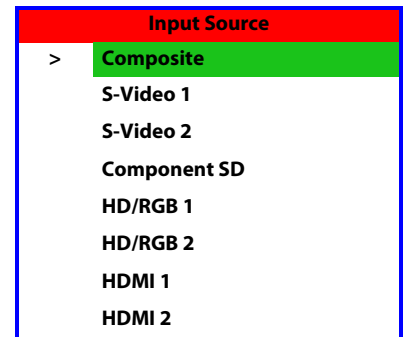

To change the aspect ratio (size and shape) of the projected image, select Aspect Ratio from the Main Menu and press **ENTER**. Select the appropriate aspect ratio for your screen size and the type of program material being viewed; refer to Table 4-1.

The currently-selected aspect ratio is indicated by a "☒" to its left; in this example, 16:9 is selected.

◀ **Aspect Ratio**

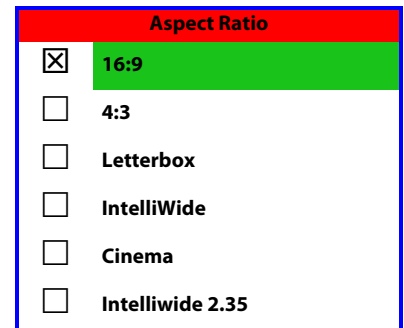

Note

The aspect ratio selection is automatically saved for each input and resolution.

Table 4-1. Aspect Ratio Settings





Aspect Ratio	Remote Control Key	Description	
16:9	16:9	 	<p>Select 16:9 to view 16:9 DVDs and HDTV programs in their native aspect ratio.</p> <p>4:3 images are stretched horizontally to fit a 16:9 screen.</p>
4:3	4:3		<p>4:3 scales the input signal to fit in the center of the 16:9 screen. 4:3 is the aspect ratio used by computer monitors, standard television programming and most VHS video cassettes.</p>
Letterbox	LET BOX		<p>Letterbox mode scales (zooms in on) a 4:3 image linearly (by the same amount on all sides) to fill a 16:9 display. Letterbox is best suited for viewing LaserDisc movies or non-anamorphic DVDs on a 16:9 screen.</p>
IntelliWide	I-WIDE	  	<p>IntelliWide scales a 4:3 image NON-linearly (more on the sides than in the center) to fit a 16:9 screen.</p> <p>On a 2.35:1 screen, the image is centered between black bars on either side.</p>

Table 4-1. Aspect Ratio Settings (continued)

Aspect Ratio	Remote Control Key	Description	
Cinema	CINEMA	 	<p>Select Cinema to view 2.35 source material in its native aspect ratio.</p> <p>With a 16:9 screen and a non-CineWide projector (no anamorphic lens), the upper and lower portions of the screen are masked, but the geometry of the active image area is unchanged.</p> <p>With a 2.35:1 screen and a CineWide-equipped projector, the VHD Controller scales the 2.35:1 image so that the active image area fills the 16:9 chip surface, eliminating the black bars. The secondary, anamorphic lens then restores the proper geometry to the 2.35:1 image.</p>
Intelliwide 2.35	SVC	 	<p>A 16:9 image is scaled NON-linearly (more on the sides than in the center) to fit a 2.35:1 screen.</p> <p>Intelliwide 2.35 is available only on CineWide-equipped Vision 140/150 projectors.</p>

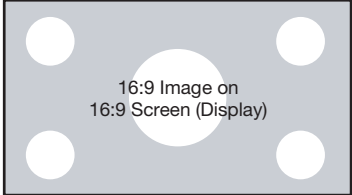
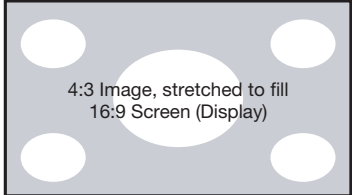
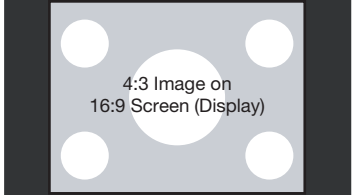
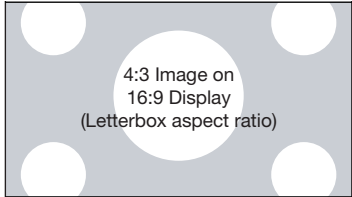
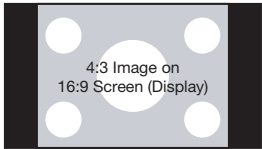
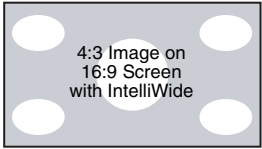
Picture ➤ Use the controls in the Picture Menu to calibrate your Vision 140/150 for optimum picture quality.

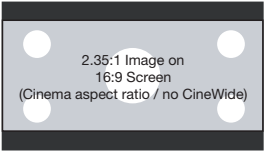
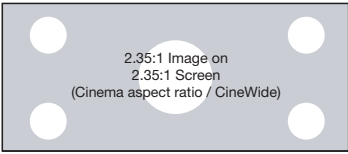
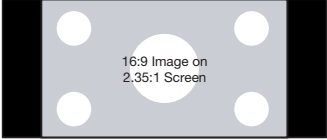
Picture
Brightness
Contrast
Color
Tint
Sharpness

The Vision 140/150 has been designed to incorporate setup and calibration standards established by the Imaging Science Foundation (ISF). The ISF has developed carefully crafted, industry-recognized standards for optimal video performance and has implemented a training program for technicians and installers to use these standards to obtain optimal picture quality from Vidikron video display devices. Accordingly, Vidikron recommends that setup and calibration be performed by an ISF certified installation technician.

All signal types require separate processing. Therefore, you need to calibrate each VHD Controller input separately.



Note

*When you change a picture quality setting, save the change to a preset afterwards. Otherwise, the change will be lost when a different input is selected. (Picture quality settings are saved for each input separately.) For information about saving settings, refer to **ISF Presets** on page 73.*

Although it may be possible to obtain satisfactory picture quality using the naked eye and regular program material, Vidikron recommends using the following calibration tools for best results:

- External test pattern source – Ovation Multimedia, Digital Video Essentials or AVIA test DVD or equivalent.
- A blue filter (provided with many test DVDs), for color level and tint adjustments.

Connect your test pattern source to the input that you are calibrating and proceed as follows. **Perform the adjustments in the order listed here.**

Brightness: On your external test pattern source, select a PLUGE pattern. (PLUGE is an acronym for "Picture Line-Up Generation Equipment.") Figure 4-2 shows a typical PLUGE pattern.

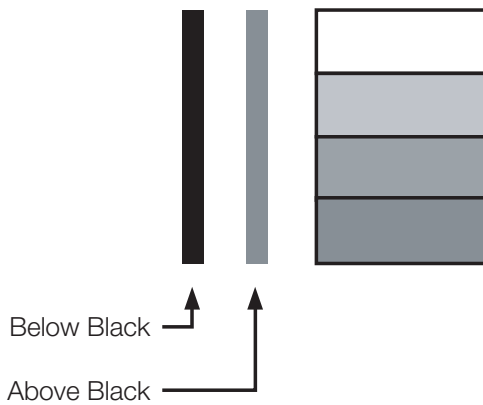

Figure 4-2. Typical PLUGE Pattern for Adjusting Brightness

PLUGE patterns vary but generally consist of some combination of black, white and gray areas against a black background. The example above includes two vertical bars and four shaded boxes.

Select Brightness from the Picture menu and press **ENTER**. Adjust the brightness so that:

- The darkest black bars disappear into the background.
- The dark gray areas are barely visible.
- The lighter gray areas are clearly visible.
- The white areas are a comfortable level of true white.
- The image contains only black, gray and white (no color).

Contrast: On your external test pattern source, select a stepped, gray-bar pattern like the one shown in Figure 4-3.

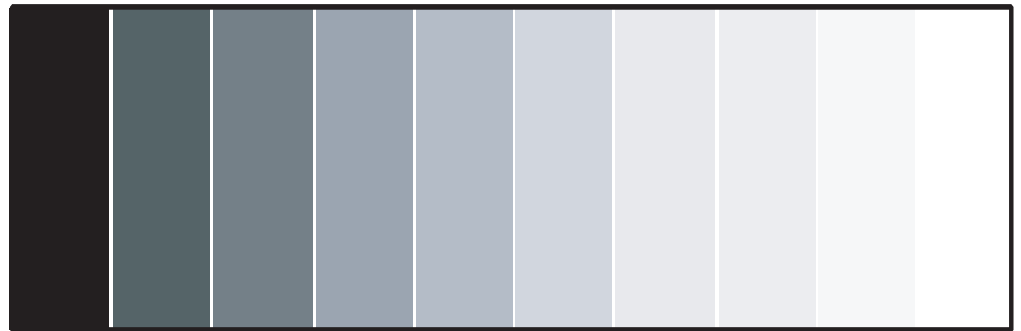

Figure 4-3. Typical Gray Bar Pattern for Adjusting Contrast

Select Contrast and press **ENTER**. Adjust the contrast to a point just below which the white rectangle starts to increase in size.



Note

Brightness and contrast controls are interactive. A change to one may require a subtle change to the other in order to achieve the optimum setting.

Color Saturation: On your external test pattern source, select a color bar pattern like the one shown in Figure 4-4.

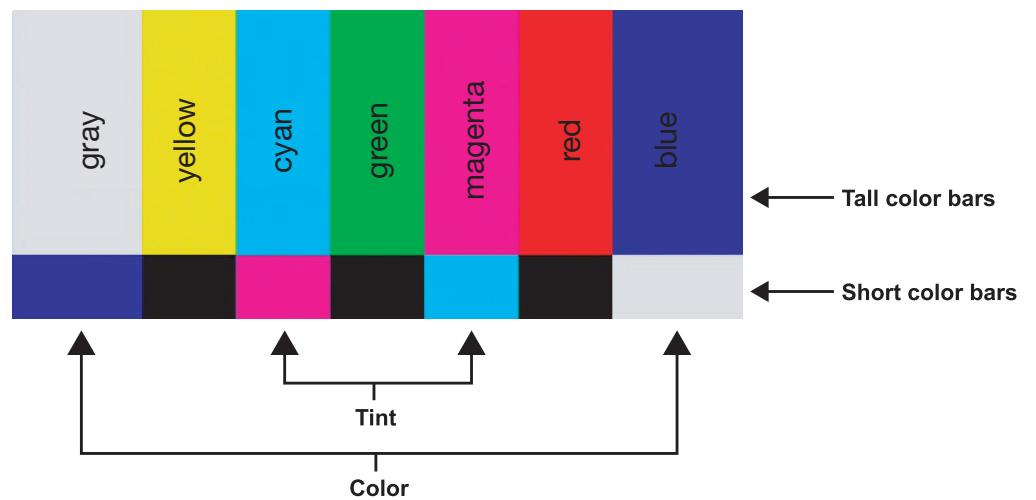
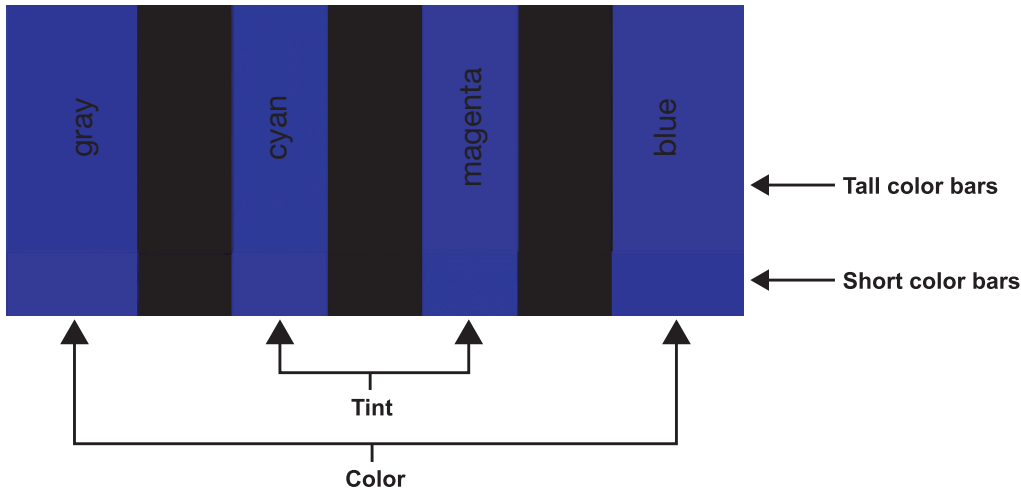

Figure 4-4. Typical Color Bar Pattern for Adjusting Color Saturation and Tint

Select Color and press **ENTER**. While looking at the color bar pattern through a blue filter, adjust the color saturation level until the outermost (gray and blue) color bars appear to be a single shade of blue:



Tint: Tint or “hue” is essentially the ratio of red to green in the color portion of the image. When tint is decreased, the image appears redder; when it is increased the image appears greener. To set the tint, select Tint and press **ENTER**. While looking at the color bar pattern through a blue filter, adjust the tint level until the cyan and magenta color bars (on either side of the green bar) appear to be a single shade of blue.



Note

Like the brightness and contrast controls, the color and tint controls are interactive. A change to one may require a subtle change to the other in order to achieve the optimum setting.

Sharpness: “Sharpness” is the amount of high-frequency detail in the image. To adjust sharpness, select Sharpness from the Picture menu and press **ENTER**. On your external test pattern source, select a pattern like the one shown in Figure 4-5. Adjust as needed, looking for white edges around the transitions from black to gray and differently-sized lines in the “sweep” patterns at the top and bottom. Lower the sharpness setting to eliminate them.

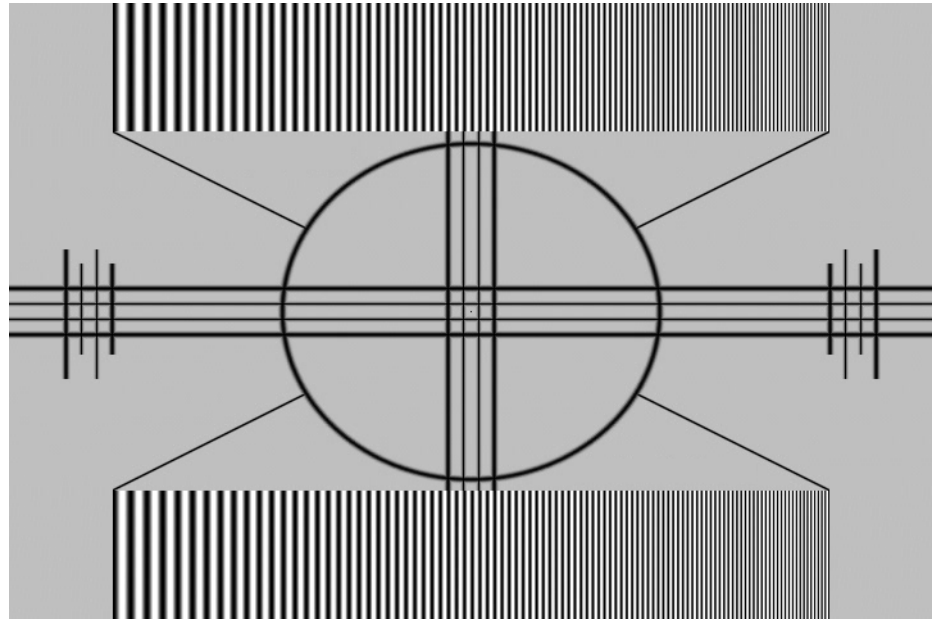

Figure 4-5. Typical Test Pattern for Adjusting Sharpness

Input Position ➤

Use the controls in the Input Position Menu to fine-tune the aspect ratio and image position for the current source.

Input Position
Left/Right
Up/Down
Width
Height
Overscan



Note

The input position settings are automatically saved for each input and resolution.

Left/Right: Select Left/Right from the Input Position menu to shift the projected image horizontally. Use the right or up cursor button to shift the image to the right; use the left or down button to shift it to the left.

Up/Down: Select Up/Down from the Input Position menu to shift the projected image vertically. Use the right or up cursor button to shift the image upward; use the left or down button to shift it downward.

Width: Select Width from the Input Position menu to change the projected image width. Use the right or up cursor button to increase the width; use the left or down button to decrease it.

Height: Select Height from the Input Position menu to change the projected image height. Use the right or up cursor button to increase the height; use the left or down button to decrease it.

Overscan: Image Overscan pushes the outside edge of the active picture area of the video signal out beyond the edge of the display area.

Some television programs are produced based on the assumption that older television sets may not display the outer edges of the broadcast picture area. Over scan effectively trims away these inactive, outer edges and enlarges the remaining portion of the image to fill the display area.

Select from 1% to 10% of Overscan, as desired.

For HDTV, DVDs and other video sources, Overscan is generally not necessary or desirable.

For each input, the Vision 140/150 lets you save image quality settings as presets that you can recall at a later time. You can create up to four presets per input and resolution. Use the ISF Presets menu to recall saved image presets, or to save image settings in the "Custom 1" or "Custom 2" memory location. The currently-selected preset is indicated by a "☒" to its left; in the example shown here, ISF Night is selected.

You should save changes to any of the following settings to a preset; otherwise they will be lost when a new input source or resolution is selected:

- Brightness
- Contrast
- Color saturation
- Tint
- Sharpness

To reset the Custom 1 and Custom 2 image presets to their factory defaults, select Factory Default and press **ENTER**.

Select Information from the Main Menu to see information that uniquely identifies your VHD Controller: its serial number, the installed hardware and firmware versions and the firmware version build date. Should you ever need to contact Vidikron Technical Support, this information will help them answer your questions or resolve product performance issues.

◀ **ISF Presets**

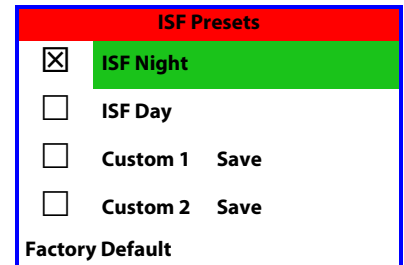

◀ **Information**

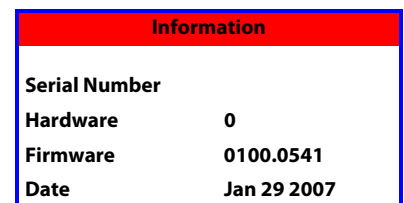

Calibration ➤ Use the Calibration menu to perform advanced picture quality adjustments. **This menu should be used by ISF-certified technicians only.**

Calibration
ISF Night
Display Color
Input Image
Input Color
ISF Day
Display Color
Input Image
Input Color
Save ISF Settings
Output Shift
Splash Configure
OSD Position



Note

You must enter a passcode to access the Calibration menu.

To recall the ISF Night or ISF Day settings, select “ISF Night” or “ISF Day” from the ISF Presets menu (see above).

ISF Night - Display Color: Use the Display Color settings to adjust the projector lamp intensity. These settings are saved independently for each input.

- **Lamp Power:** Select Lamp Power from the Display Color Menu to adjust the lamp output level. You can choose to run the lamp as bright as possible (“100”), at its lowest power level (“0,” which equates to approximately 700 watts; this is the default setting) or choose a setting in between. Generally, lower lamp output prolongs the life of the lamp, but decreases brightness.
- **Lamp Intensity:** Select Lamp Intensity from the Display Color Menu to adjust the lamp intensity level. Refer to **Intensity** on page 60.

ISF Night - Input Image: The Input Image controls are similar to those in the Picture menu, but are accessible only by entering the Calibration menu passcode. This makes it possible to restore the picture quality settings to what they were when the projector was installed, simply by recalling the “ISF Night” preset.

ISF Night - Input Color: Use the Input Color controls to adjust the color balance of the incoming signal. These settings are also saved independently for each input.

- **Gain:** Use the Gain controls to correct color imbalances in the bright areas of the image. A good way to do this is to use a test pattern consisting mostly of solid white areas, such as an 80 IRE “window” pattern. If the white areas contain traces of red, green or blue, decrease the Gain for that color.
- **Offset:** Use the Offset controls in the White Balance sub-menu to correct color imbalances in the dark areas of the image. A good way to do this is to use a test pattern consisting mostly of dark gray areas, such as a 30 IRE “window” pattern. If the gray areas contain traces of red, green or blue, decrease the Offset for that color.
- **Chroma Delay:** Use the Chroma Delay control to correct a mis-aligned image from a Composite, S-Video or Component video source. Chroma delay in an image causes color shifts to occur to the left of the vertical edge transitions, producing artificial shadows or a “halo” effect. If necessary, adjust this setting to eliminate them.
- **Phase:** Adjust the phase if the image (usually from an RGB source) shows shimmer or “noise.” Pixel phase adjusts the phase of the pixel sampling clock relative to the incoming signal. The effect of this control is similar to that of a tracking control on a VCR.

For best results, use a good test pattern such as a smooth gray consisting of a clear pattern of black and white pixels, or a similar “half on, half off” graphic image. (You may notice that you can stabilize the image at more than one point. Use either setting in this case.)

- **Noise Filter:** To apply noise filtering to the input signal, select Noise Filter from the Input Color menu. The Noise Filter is useful for clearing up noisy images from 480i video sources.

Use the left- or right-arrow buttons to select the desired amount of noise reduction, keeping in mind that higher settings (which reduce high frequencies) may also “soften” the image.

ISF Day - Display Color: Refer to *ISF Night - Display Color*.

ISF Day - Input Image: Refer to *ISF Night - Input Image*.

ISF Day - Input Color: Refer to *ISF Night - Input Color*.

Save ISF Settings: Whenever you make a change to the ISF settings, you should always save it. Select Save ISF Settings from the ISF Calibration menu to do this. In the event you ever have to perform a System Reset, you can restore the saved ISF settings by selecting Restore Saved Settings in the Service menu. (System Reset and Restore Saved Settings are described on page 79.)

Output Shift: The controls in the Output Shift menu are similar to those in the Input Position menu, except that they change the characteristics of the output signal. These settings are saved independently **for each aspect ratio**.

To save the Output Shift settings for the current aspect ratio so that they can be restored after a System Reset (described on page 79), press ▼ repeatedly to highlight “Save.” Then, press **ENTER**.

Splash Configure: Use the Splash Configure menu to customize the appearance of the start-up message that appears on the vacuum fluorescent display upon power-up.

- **Owner Name/ISF Calibrated/ISF Other:** You can have the Vision 140/150 display the owner’s name, your name, the phrase “ISF Calibrated” and/or any other string, up to 20 characters in length.

Use the up or down cursor button to select a character. Use the right and left cursor buttons to change the cursor position. Press **MENU** when you have finished entering text. Then, check the “Splash Enable” box to have the Vision 140/150 display the information you enter here when it is turned on.

- **Vidikron/ISF Logo Splash Screen Timers:** When you turn on the Vision 140/150, it projects a welcome screen with the Vidikron logo followed by one with the ISF logo. Select Splash Timer from the Splash Configure menu to set the amount of time that these two images appear. The range is from 2 to 60 seconds, in one-second increments.

Use the up or down cursor button to select a timer value to adjust. Use the right or left cursor button to change the timer value. Press **MENU** when you have finished configuring both timers.

OSD Position: Select OSD Position, press **ENTER** and use the arrow buttons to change the size and position of the OSD controls.

Service ➤ Use the Service menu to access advanced projector configuration settings. **This menu should be used by ISF-certified technicians only.**

Service
Test Video
Input Names
Remote Control
Display Device
HD Format
Triggers
Miscellaneous
System Reset
Restore Saved Settings



Note

You must enter a passcode to access the Service menu.

Test Video: Select Test Video from the Service Menu to access the internal test patterns on the Vision 140/150. Four patterns are available, consisting of white/gray or colored bars.

Press **MENU** to exit test pattern mode.

Input Names	
	Restore
Composite	Composite
S-Video 1	S-Video 1
S-Video 2	S-Video 2
Component SD	Component SD
HD/RGB 1	HD/RGB 1
HD/RGB 2	HD/RGB 2
HDMI 1	HDMI 1
HDMI 2	HDMI 2
	Save

Input Names: You can give each VHD Controller input a descriptive name. For example, you may want to change the default input name to the type of source component connected to it: "VCR," "DVD," "Laptop" et cetera. Composite, S-Video and Component SD input names can be up to 12 characters long; the others can be up to eight characters long.

To edit an input name, select Input Names from the Service menu. Press ▲ or ▼ to select an input and press **ENTER**. Use the ▲ or ▼ buttons to change a character; press ◀ or ▶ to select a character to change. When you have finished editing the input name, press **MENU**.

To restore the default input name, press ▼ repeatedly to highlight that input name in the "Restore" column. Then, press **ENTER**.

To save input names so that they can be restored after a System Reset (described on page 79), press ▼ repeatedly to highlight "Save." Then, press **ENTER**.



Note

The ▼ button takes you from top to bottom in the left column, then from top to bottom in the right column. To highlight "Save," scroll through both columns.

Remote Control: The Remote Control menu shows you the primary and secondary infrared (IR) codes to which the VHD Controller will respond. By default, both are set to 17. You can change these codes if either:

- Another device in the theater (a DVD player, for example) is responding to commands from the VHD Controller remote control (Figure 2-6) in ways that are unpredictable or undesirable.
- You have multiple VHD Controllers and want to control them independently, as opposed to broadcasting commands from a single remote to all of them. In this scenario, you can use multiple remotes programmed to use different IR codes. Or, you can use a single remote and change the IR code as needed to address a specific device.

Use the VHD Controller front-panel keypad to change its IR code. Then, change the code sent by the remote to match as described below.



Note

Do not change the "Type" setting in this menu.

When you change a remote code on the VHD Controller, you must re-program your remote control to send that same code. To do this:

1. Using a straightened paper clip or similar object, press and hold the **CODE** button on the remote control for approximately three seconds, or until the LED on the remote lights solid red.

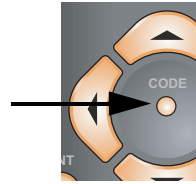

– OR –

If your remote control unit does not have a **CODE** button, press and hold the **LIGHT** button on the remote control for approximately three seconds, or until the LED on the remote lights solid red.

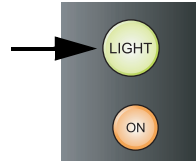

2. Enter a new two-digit code between 00 and 31 inclusive. Use the **16:9** button for "9" and the **4:3** button for "0." Include a leading zero for single-digit codes; for example, enter 9 as "09."
3. The LED turns off to confirm the code change. If you enter an invalid code, the LED flashes for three or four seconds. Try again, entering a valid code.

Display Device: The options in the Display Device menu allow you to perform various adjustments at the projector.

- **Configure:** Select Configure from the Display Device menu to change the picture orientation, correct a "keystoned" (trapezoidal) image, access the lamp timer, perform lens adjustments and quickly optimize various display settings.
- **Installation - Orientation:** Refer to *Adjusting the Picture Orientation* on page 39.
- **Installation - Keystone:** If the projector and screen are not installed perpendicular to each other, the image may become distorted in a trapezoidal shape, as shown in Figure 4-6. Select Keystone from the Configure menu to compensate for this.

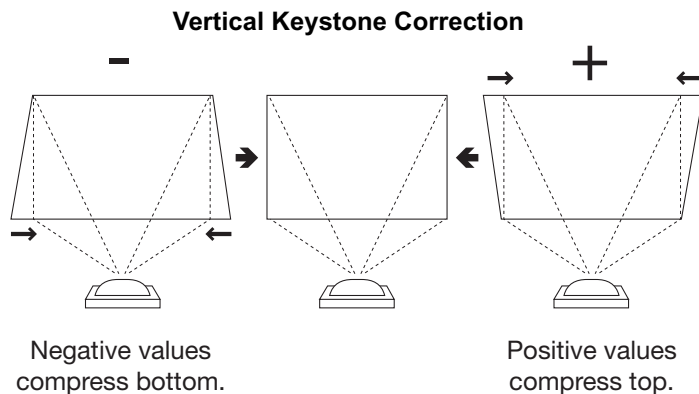

Figure 4-6. Keystone Correction

- **Installation - Lamp Hours:** This menu page also displays the number of hours that the lamp has been in service. To reset the counter (which is recommended after you replace the lamp), refer to *Lamp and Filter Replacement* on page 81.
- **Lens:** Select Lens from the Display Device menu to access the motorized lens controls. Refer to *Primary Lens Adjustments* on page 39.
- **Auto Setup:** Refer to *Auto Setup* on page 50.

HD Format	
HD/RGB 1	Auto
HD/RGB 2	Auto
ADC Bandwidth	Auto
YPbPr Input Resolution	

HD Format: If the characteristics of the incoming signal on the HD1 or HD2 inputs are known, select HD Format from the Service menu and set them as described below. Doing so can reduce the time it takes the VHD Controller to switch from HD to 480i signals or vice versa.

This is generally not necessary unless the VHD Controller – for whatever reason – has difficulty determining the color space (RGB or YUV), bandwidth or resolution of the incoming HD signal. In most situations, the **Auto** settings work well.

- **HD/RGB 1 and HD/RGB 2 (Color Space):** Select Auto, RGB or YUV.
- **ADC Bandwidth:** Select Auto, 75 MHz, 150 MHz or 300 MHz.
- **YPbPr Input Resolution:** Select Auto or specify the input resolution, if known: 480i, 480p, 576i, 576p, 720p or 1080i.

Triggers: Select Triggers from the Service menu to configure the 12-volt trigger outputs. You can assign one or more trigger outputs to each aspect ratio. Those triggers are then activated by selecting that aspect ratio.

If your projector is equipped with the Vidikron CineWide with AutoScope system, assign at least one trigger output (the same one to which the lens motor is connected) to the Cinema and Intellivide 2.35 aspect ratios.

To configure a trigger to activate when the system is turned on – for example, when using the trigger to control a retractable screen – assign that trigger to all aspect ratios.

To save the trigger settings so that they can be restored after a System Reset (described below), press ▼ repeatedly to highlight “Save.” Then, press **ENTER**.

Miscellaneous: Select Miscellaneous from the Service menu to set the following options:

- **Language:** Select Language from the Miscellaneous menu and press the up- or down-arrows to select the OSD language. (Currently, only English is supported.)
- **Menu Mode:** This is the manner in which the OSD menus appear and disappear when you press MENU. Choose one of the following:
 - 0 = No transition; menus abruptly appear and disappear.
 - 1 = Menus fade in and out.
 - 2 = “Checkerboard” dissolve; menus appear and disappear in sections.
 - 3 = “Window shade” effect; menus are drawn on a diagonal from top left to bottom right, and retract in the opposite direction.
- **Timeout - Short/Long:** These settings control how long the OSD menus stay on screen. Select a time-out period of from 2 to 60 seconds.
- **Side Bar Color:** This controls the color of the inactive image area. The range is from -100 (black) to 100 (white).

The inactive image area is on either side of the active image area when using the Standard 4:3 aspect ratio, and above and below the active image area when using the Letterbox aspect ratio.

- **Film Mode:** Enable Film Mode to smooth out moving images from interlaced, standard-definition (SD) sources. In most cases, the VHD Controller detects the proper “pull-down” rate and vertical frequency. However, if your source is jittery and/or tearing you may wish to enable Film Mode to ensure stable processing for that source.

System Reset: To reset ALL projector and controller settings (including image settings) back to their factory defaults, choose System Reset from the Service menu.

A confirmation message appears, reminding you to save your settings before you perform the reset, so that you can restore them afterwards. If you have done this, select Confirm to continue with the reset. Otherwise, click Back to cancel.



Caution

This action is not undoable. Proceed with caution! Before you perform a System Reset, save ALL settings, including "Custom" ISF Presets (page 73), ISF Day/Night presets (page 75), Output Shift settings (page 75), Input Names (page 76) and Trigger settings (page 78).

Restore Saved Settings: Following a System Reset, select Restore Saved Settings to apply all previously-saved settings to the projector and VHD Controller.

Notes:

Maintenance and Troubleshooting

The Vision 140/150 uses a Cermax® Xenon lamp to deliver its high brightness. The lamp should be replaced when it reaches the end of its life (typically 1000 hours), or sooner if a noticeable degradation in brightness occurs. When you replace a lamp, you should replace the filters as well.

Keep track of the number of hours the lamp has been in use and be aware of any changes to brightness. These indicators will help you effectively maintain operation of the projector. To find out how long the currently-installed lamp has been in service, select Lamp Hours from the VHD Controller Installation menu (available by selecting **Service -> Display Device -> Configure -> Installation**, in sequence).

For lamp or filter replacement, please contact your nearest Vidikron authorized service center or Vidikron dealer. Do not attempt to replace the lamp yourself!

1. Turn off the projector and unplug the power cord. Allow the projector to cool down for approximately 45 minutes prior to removing the lamp assembly for replacement.
2. Loosen the two rear Lamp Cover screws (see Figure 5-1) and remove the cover.

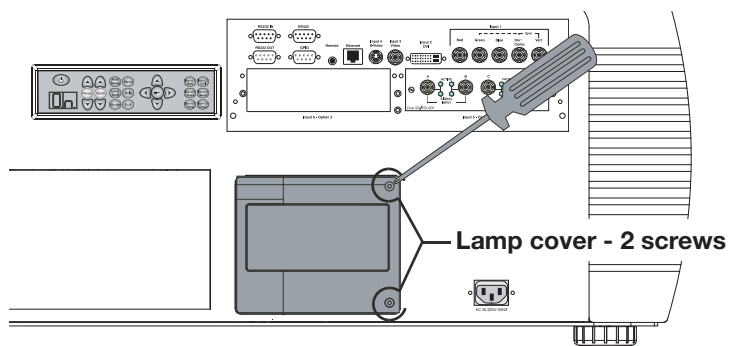

Figure 5-1. Removing the Lamp Door

3. Pull (out) and turn the lamp lock lever, which is located to the left of the lamp module, a quarter turn counterclockwise to the "unlock" position (Figure 5-2).

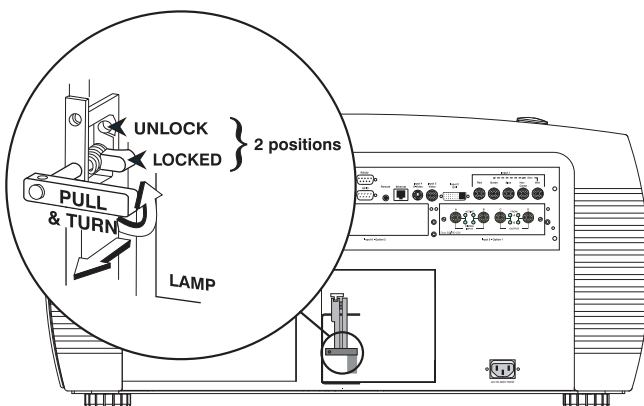

Figure 5-2. Unlocking the Lamp

5.1 Lamp and Filter Replacement

4. Grasp the lamp by its housing only and pull it straight out (lamp slides along guides) until it's free; see Figure 5-3. Discard the lamp using safe disposal/recycling practices or contact your Vidikron dealer for a possible re-lamping program.

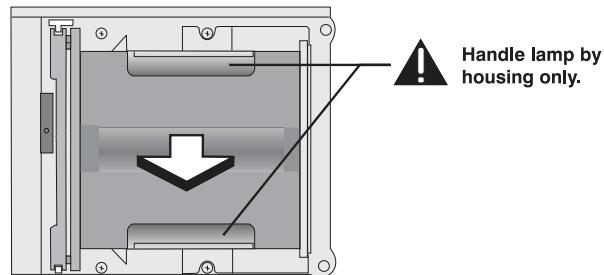

Figure 5-3. Removing the Lamp

5. Align the new lamp with the top and bottom guides on the left side of the lamp compartment; see Figure 5-4. Slide the lamp all the way in. A slightly harder push may be required right at the end to make sure it is fully seated into the terminal block. **NOTE:** The projector will not power up again if the lamp is not fully connected to the terminal block.

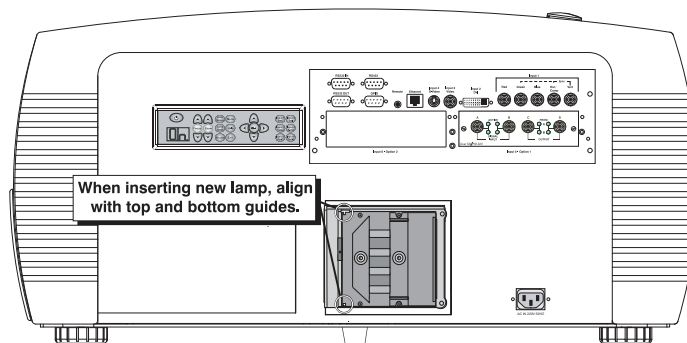

Figure 5-4. Installing A New Lamp

6. Pull (out) and turn the lamp lock lever (turned up in Step 3) a quarter turn clockwise to "lock" the lamp in place.



Note

If you can't turn the lamp lock into position, the lamp may not be fully inserted. In this case, partially remove the lamp and try pushing it back in again. Then, try switching the lock lever to the "lock" position.

7. Replace the lamp door and tighten the four screws to secure it.
8. Re-attach the power cord to the projector and power it up.
9. Press **MENU** on the projector remote control (Figure 3-17) or rear-panel keypad (Figure 2-3).
10. Select **Lamp Adjust** from the Main Menu.
11. Select **Change Lamp** from the Lamp menu.
12. Enter the serial number in the **Lamp S/N** text box using the remote numeric keypad (Figure 3-17).

13. Press **ENTER** to accept the change. This adds the new lamp serial number to the Lamp History menu and resets the Lamp Hours timer to "0." Lamp Mode and Lamp Limit remain as they were for the previous lamp and can be changed at any time.

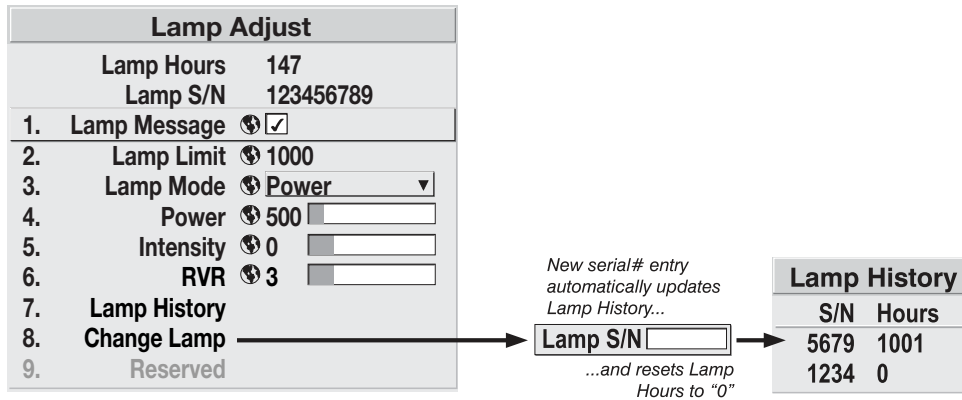

Figure 5-5. Recording the Serial Number of a New Lamp



Note

Always record the serial number of a new lamp. Do this **only** if you have just installed a new lamp. This will ensure that the lamp timer is not reset on an old lamp and that the number of hours logged on the lamp is accurate.

Whenever you replace the lamp – or more often if the projector is installed in an extremely dusty environment – you should also replace the two filters located at the front and right side of the projector.

1. Loosen the six screws holding right side filter access panel in place. Then, remove the panel.
2. Loosen the screw holding front filter access panel in place. Then, remove the panel.
3. Pull the filters out of the projector and discard. Do not reuse filters.
4. Insert the new filters with the wired side in.
5. Replace the filter access panels and tighten the screws to secure them.

◀ **Filter Replacement**

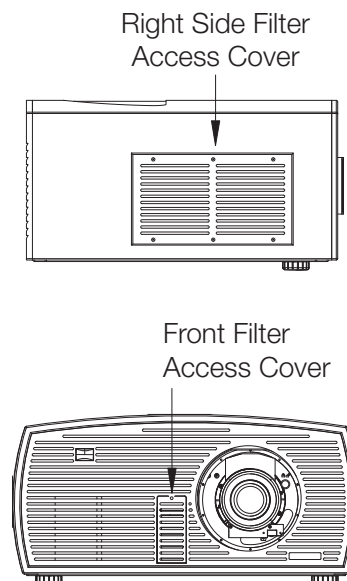

5.2 Lens Replacement

If you need to remove the lens – either to replace it or to prepare the projector for shipment – proceed as follows:

1. Power down the projector and wait five minutes to allow the lamp to cool.
2. Remove the secondary anamorphic lens, if present.
3. Place the lens cap on the installed lens to protect it from damage.
4. Press and hold the “lens release” button located in the top right corner of the lens panel.
5. Grasping the lens barrel, turn it in a counter-clockwise direction until it stops. Then, pull it forward to remove it (disconnects from the connector assembly).

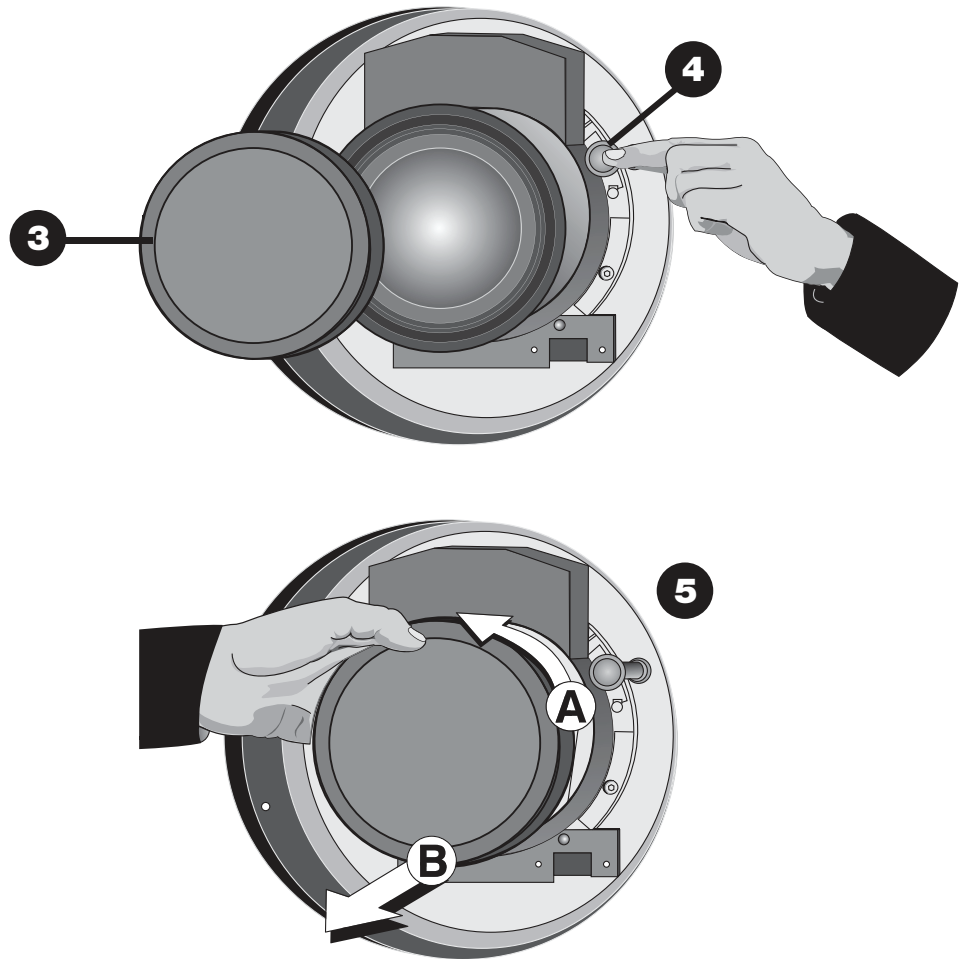

Note: The connector assembly moves as you turn the lens.

Figure 5-6. Removing the Primary Lens

Table 5-1 provides some general guidelines for troubleshooting problems you may encounter with the Vision 140/150. If the suggested solutions fail to resolve the problem or if you encounter an issue not described here, please contact Vidikron Technical Support.

5.3 Troubleshooting Tips

Table 5-1. Troubleshooting Chart

Symptom	Possible Cause(s)	Solution
The projector does not turn on after initial installation.	<ul style="list-style-type: none"> The Vision 140/150 is not plugged in or the AC outlet is not active. The VHD Controller is not plugged in or the AC outlet is not active. The remote control batteries have run out. The serial connection from the VHD Controller to the Vision 140/150 is incorrect. 	<ul style="list-style-type: none"> Ensure that the Vision 140/150 is plugged in and that the AC outlet is active. Ensure that the VHD Controller is plugged in and that the AC outlet is active. Replace the batteries. Ensure that the RS-232 output from the VHD Controller is properly connected to the RS-232C input on the Vision 140/150 (see Figure 3-9).
The projector and VHD Controller are both on, but there is no picture and on-screen menus do not appear.	<ul style="list-style-type: none"> Lens cover is on or shutter is closed. Lamp failed to ignite. Faulty or incorrect video connection between the VHD Controller and the Vision 140/150. 	<ul style="list-style-type: none"> Ensure that the lens cover is off and the shutter is open. Ensure that the lamp door is closed. If it is and the problem persists, replace the lamp. Ensure that the HDMI output from the VHD Controller is properly connected to Input 2 (DVI) on the Vision 140/150 (see Figure 3-9).
The display is on and menus appear, but there is no picture.	<ul style="list-style-type: none"> Incorrect source selection. Source component is not turned on. Source component is connected incorrectly or not at all. 	<ul style="list-style-type: none"> Select the correct source. Turn on the source component. Check connections from source component to VHD Controller.
A projected image from a DVD is split or otherwise scrambled.	<ul style="list-style-type: none"> DVD player is connected to the Component input and set to progressive scan mode. 	<ul style="list-style-type: none"> Turn off progressive scan on the DVD player. Or, connect the DVD player to the HD1 or HD2 input.
Image appears "squeezed" or vertically stretched into center of screen.	<ul style="list-style-type: none"> Incorrect aspect ratio selection. 	<ul style="list-style-type: none"> Select a different aspect ratio.

Table 5-1. Troubleshooting Chart (continued)

Symptom	Possible Cause(s)	Solution
The display is jittery or unstable.	<ul style="list-style-type: none"> Poor-quality or improperly connected source. The horizontal or vertical scan frequency of the input signal may be out of range for the projector. 	<ul style="list-style-type: none"> Ensure that the source is properly connected and of adequate quality for detection. Correct at the source.
Image is too bright and/or lacks definition in the bright areas of the image.	<ul style="list-style-type: none"> Contrast is set too high. 	<ul style="list-style-type: none"> Lower the contrast setting.
Image appears “washed out” and/or dark areas appear too bright.	<ul style="list-style-type: none"> Brightness is set too high. 	<ul style="list-style-type: none"> Lower the brightness setting.
Colors in the image are swapped; for example, reds appear blue or vice versa.	<ul style="list-style-type: none"> The Red/Pr, Green/Y or Blue/Pb outputs from the source are connected to the wrong inputs on the VHD Controller. 	<ul style="list-style-type: none"> Ensure that the source outputs are connected to the correct VHD Controller input.
The display freezes suddenly.	<ul style="list-style-type: none"> Excessive voltage noise on the AC or ground input has interrupted the projector’s ability to lock on to a signal. 	<ul style="list-style-type: none"> Power down the projector and disconnect from AC. Then, plug in again and power up as usual.
The projector will not turn back on after it was powered down, or the image disappears during operation.	<ul style="list-style-type: none"> The projector will not turn on for two minutes after power-down, to protect the lamp. The lamp has failed. 	<ul style="list-style-type: none"> Wait until the LED at the front of the VHD Controller turns red. Replace the lamp.
AutoScope lens motor does not work.	<ul style="list-style-type: none"> The motor is not plugged in or the AC outlet is not active. The motor is not connected to a trigger output on the VHD Controller. Incorrect trigger assignment. 	<ul style="list-style-type: none"> Ensure that the motor is plugged in and that the AC outlet is active. Check the trigger connection between the lens motor and VHD Controller (Figure 3-15). Correct the trigger assignment (refer to Configure Lens Motor Trigger (CineWide with AutoScope) on page 41).

If the status code display on the back of the projector shows one of the following values, you have encountered a likely system error requiring the attention of a qualified service technician. Acknowledge and clear the error by pressing **EXIT** twice on the rear-panel keypad. Try resetting the projector by powering it off, allowing it to cool and powering it on again. Refer to Table 5-2 and contact your dealer if the problem persists.

◀ **Error Codes**

The specific code number identifies the source of the error detected, and is particularly useful in cases where the projector is far away. For example, the code "27" means the lamp could not be turned on.

Table 5-2. Vision 140/150 Error Codes

Code	Description
General	
12	Software bug. Contact dealer or Vidikron Technical Support.
13	CRC error in flash ROM. Download new software.
14	Engineering-only programming is complete. Contact Vidikron, replace TIPM.
15	Attempting to download code without being in boot mode.
16	Invalid interrupt. Power off/on. If it persists, contact dealer or Vidikron Technical Support.
17	User forced system to stay in boot mode.
18	Jumper for programming boot not installed.
Lamp Failures	
20	Lamp turned on unexpectedly (fault related to ballast).
21	Lamp airflow low, overheating imminent.
23	Cannot read valid ballast ID.
26	Lamp 1 Interlock: lamp door open, lamp not installed.
27	Can't turn lamp on.
28	Lamp turned off unexpectedly.
29	Lamp ballast overheated.
<p>Note: To clear a system error, press the EXIT key (on the projector's rear-panel keypad) twice. If necessary, reset the projector by powering it off, allowing it to cool and powering it on again. Contact your Vidikron dealer or Vidikron technical support if the error persists.</p>	

Table 5-2. Vision 140/150 Error Codes (continued)

Code	Description
Power and Cooling	
46	Red DMD heat sink overheated.
47	Green DMD heat sink overheated.
48	Blue DMD heat sink overheated.
49	Prism overheated.
4C	Projector shutdown due to critical error.
C0	Lamp blower failure (lamp not turned on).
51	LVPS fan failed (Fan 1).
52	LVPS/Red cooling fan failed (Fan 2).
53	DC lamp fan failed (Vision 140; Fan 3).
54	Red DMD heatsink fan failed (Fan 4).
55	Green DMD heatsink fan failed (Fan 5).
56	Blue DMD heatsink fan failed (Fan 6).
57	TIPM fan failed (Fan 7).
58	TIPM fan failed (Fan 8).
<p>Note: To clear a system error, press the EXIT key (on the projector's rear-panel keypad) twice. If necessary, reset the projector by powering it off, allowing it to cool and powering it on again. Contact your Vidikron dealer or Vidikron technical support if the error persists.</p>	

Table 5-2. Vision 140/150 Error Codes (continued)

Code	Description
TIPM (Image Processor)	
60	Boot code CRC failed.
61	Unable to program DigMux PLD.
62	Unable to program Control PLD.
63	Unable to program Bubks PLD.
64	Unrecognized ROM type.
65	Write to flash ROM failed.
66	TIPM failure.
67	Downloaded code will not fit.
68	Scaler communication problem.
Built-In Keypad	
70	Unable to access EEPROM on the built-in keypad.
71	EEPROM memory re-initialization on the built-in keypad.
Panel Driver and Formatter	
80	Unrecognized Panel Driver.
81	Unable to program device on Panel Driver.
82	TI flash download failure.
83	TI flash download failure.
84	TI flash download failure.
85	TI-I2C write failure.
86	One or more formatters not responding; probable formatter software fault.
87	Formatter reports RDRAM failure.
88	Red modular Formatter communication failure.
89	Green modular Formatter communication failure.
8A	Blue modular Formatter communication failure.
93	Modular formatter architecture error.
94	Modular formatter DMD mismatch.
95	Modular formatter sequence mismatch.
<p>Note: To clear a system error, press the EXIT key (on the projector's rear-panel keypad) twice. If necessary, reset the projector by powering it off, allowing it to cool and powering it on again. Contact your Vidikron dealer or Vidikron technical support if the error persists.</p>	

Table 5-2. Vision 140/150 Error Codes (continued)

Code	Description
Miscellaneous	
A0	Unable to program the optional module.
A1	Unable to power the optional module.
A2	Unable to program the Dual Slot Backplane Module (DSBP).
A3	Unable to program the optional Post Processing Module (Warp module).

Note: To clear a system error, press the **EXIT** key (on the projector's rear-panel keypad) twice. If necessary, reset the projector by powering it off, allowing it to cool and powering it on again. Contact your Vidikron dealer or Vidikron technical support if the error persists.

Serial Communications

To interface the VHD Controller with a home theater automation/control system or a PC running terminal emulation software, connect it to your control system or PC as shown in Figure 3-14.

Configure the RS-232 controller or PC serial port as follows: no parity, 8 data bits, 1 stop bit and no flow control. Set the baud rate to 19200, to match that of the VHD Controller RS-232 port.

Serial commands to the VHD Controller take the following form:

- Commands are not case-sensitive.
- For a single command that takes no parameters, type the command followed by a carriage return; for example, to set the aspect ratio to Letterbox, type `LETTERBOX <Enter>`.
- For a single command that takes a parameter, type the command, a space or a comma and the desired value followed by a carriage return; for example, to set the brightness to -10, type `BRIGHTNESS -10 <Enter>` or `BRIGHTNESS, -10 <Enter>`.
- You can also send a string of multiple commands on a single line, separated by commas. For example, `COMPOSITE, BRIGHTNESS 100, ANAMORPHIC <Enter>` switches to the Composite video input, sets the brightness to 100 and sets the aspect ratio to Anamorphic. Command strings can be up to 255 characters long.



Note

Avoid combining the `ON` or `POWER 1` commands with other commands on a single line. After sending `ON` or `POWER 1`, allow at least 15 seconds for the VHD Controller to power up. Once it does, it will accept and properly execute multiple serial commands.

Table 6-1 lists the RS-232 command set. The “Parameter (min/max)” column shows the valid parameter ranges, or “NA” for commands that take no parameters.

When you enter a valid command, the VHD Controller executes it and acknowledges it with a plus sign on the command line (+ >). When you enter an invalid command – one that is misspelled or followed by values outside the valid range for that command – the VHD Controller ignores it and returns a minus sign (- >).

Table 6-1. Serial Commands

Command	Parameter (min/max)	Value Stored?	Description
Power On/Off Commands			
OFF	NA	NA	Turns projector off
ON	NA	NA	Turns projector on
POWER	0/1	NA	Turns projector on and off
POWER?	NA	NA	Returns power status

6.1 RS-232 Connection and Port Configuration

6.2 Serial Command Syntax

Table 6-1. Serial Commands (continued)

Command	Parameter (min/max)	Value Stored?	Description
Input Selection Commands			
COMPONENT	NA	YES	Selects the Component input
COMPOSITE	NA	YES	Selects the Composite video input
HDMI1	NA	YES	Selects the HDMI1 input
HDMI2	NA	YES	Selects the HDMI2 input
HD1	NA	YES	Selects the RGB HD 1 input
HD2	NA	YES	Selects the RGB HD 2 input
INPUT?	NA	NA	Returns active input
SVIDEO1	NA	YES	Selects the S-Video 1 input
SVIDEO2	NA	YES	Selects the S-Video 2 input
Aspect Ratio Commands			
16:9	NA	YES	Selects the Anamorphic aspect ratio
ASPECT?	NA	NA	Returns current aspect ratio
ASPECTIN?	NA	NA	Returns the input source aspect ratio
ASPECTOUT?	NA	NA	Returns output screen size
CINEMA	NA	YES	Selects the Cinema aspect ratio
LETTERBOX	NA	YES	Selects the Letterbox aspect ratio
OUT169	NA	YES	Sets the output screen to 1.78:1 (16:9)
OUT235	NA	YES	Sets the output screen to 2.35:1
4:3	NA	YES	Selects the Standard (4:3) aspect ratio
INTELLIWIDE	NA	YES	Selects the IntelliWide aspect ratio
INTELLI235	NA	YES	Selects the Intelliwide 2.35 aspect ratio

Table 6-1. Serial Commands (continued)

Command	Parameter (min/max)	Value Stored?	Description
Picture Adjust Commands			
BRIGHTNESS	-100/100	YES	Sets a value for brightness
BRIGHTNESS?	NA	NA	Returns brightness setting value
CHROMADELAY	-12/12	YES	Sets a value for input color chroma delay
CHROMADELAY?	NA	NA	Returns input color chroma delay setting
COLOR	-100/100	YES	Sets a value for color
COLOR?	NA	NA	Returns color setting value
CONTRAST	-100/100	YES	Sets a value for contrast
CONTRAST?	NA	NA	Returns contrast setting value
FILMMODE	0/1	YES	Sets Film Mode off (0) or on (1)
FILMMODE?	NA	NA	Returns Film Mode setting (0 = off; 1 = on)
FILTER	0/15	YES	Sets a value for input color noise filter
FILTER?	NA	NA	Returns input color noise filter setting
PHASE	0/3	YES	Adjusts phase
PHASE?	NA	NA	Returns phase setting value
SHARPNESS	-6/6	YES	Sets a value for sharpness
SHARPNESS?	NA	NA	Returns sharpness setting value
TINT	-100/100	YES	Sets a value for tint
TINT?	NA	NA	Returns tint setting value
Image Preset Commands			
CUSTOM1	NA	YES	Loads "Custom 1" image preset
CUSTOM2	NA	YES	Loads "Custom 2" image preset
DAY	NA	YES	Loads "ISF Day" image preset
NIGHT	NA	YES	Loads "ISF Night" image preset
PRESET?	NA	NA	Returns currently-selected preset (ISF Day, ISF Night, Custom 1 or Custom 2)

Table 6-1. Serial Commands (continued)

Command	Parameter (min/max)	Value Stored?	Description
Input Position Commands			
IHEIGHT	-100/100	YES	Sets the value for input height
IHEIGHT?	NA	NA	Returns input height value
IHPOS	-100/100	YES	Sets a value for horizontal input position
IHPOS?	NA	NA	Returns input horizontal position value
IVPOS	-100/100	YES	Sets a value for vertical input position
IVPOS?	NA	NA	Returns input vertical position value
IWIDTH	-100/100	YES	Sets the value for input width
IWIDTH?	NA	NA	Returns input horizontal width value
OVERSCAN	0/10	YES	Sets the overscan percentage
OVERSCAN?	NA	NA	Returns overscan percentage
Output Shift Commands			
OHEIGHT	-100/100	YES	Sets the value for output height
OHEIGHT?	NA	NA	Returns output height value
OHPOS	-100/100	YES	Sets the value for output horizontal position
OHPOS?	NA	NA	Returns output horizontal position value
OVPOS	-100/100	YES	Sets the value for output vertical position
OVPOS?	NA	NA	Returns output vertical position value
OWIDTH	-100/100	YES	Sets the value for output width
OWIDTH?	NA	NA	Returns output horizontal width value

Table 6-1. Serial Commands (continued)

Command	Parameter (min/max)	Value Stored?	Description
Miscellaneous Commands			
BKGND	-100/100	YES	Sets the background color for letterbox or 4:3 aspect ratio (-100 = black; 100 = white)
BKGND?	NA	NA	Returns background setting value
DATE?	NA	NA	Returns product manufacture date
DISPLAY?	NA	NA	Returns display device input source value
HDINPUTRES	NA	YES	Sets YPbPr input resolution and refresh rate for HD1/HD2, as follows: 0 = 480i 1 = 480p 2 = 576i 3 = 576p 4 = 720p / 60 Hz 5 = 1080i / 60 Hz 6 = 720p / 50 Hz 7 = 1080i / 25 Hz Any other value = Auto
HWVER?	NA	NA	Returns hardware version number
INRES?	NA	NA	Returns input resolution
LENS1?	NA	NA	Returns Lens 1 configuration
LENS2?	NA	NA	Returns Lens 2 configuration
SWVER?	NA	NA	Returns software version number
TRIGGER	1/3	YES	Assigns trigger to currently-selected aspect ratio
The following serial commands are meant to emulate buttons on the remote control or VHD Controller front panel. Each button has its own serial command, so effectively it is as if you were using the IR remote only you'll be doing so via serial commands. These commands provide active OSD responses just like the IR remote.			
DOWN	NA	NA	Down-Arrow (▼) key
ENTER	NA	NA	ENTER key
LEFT	NA	NA	Left-Arrow (◀) key
MENU	NA	NA	MENU
RIGHT	NA	NA	Right-Arrow (▶) key
UP	NA	NA	Up-Arrow (▲) key

Notes:

Specifications

Table 7-1 lists the Vision 140/150 specifications.

Table 7-1. Vision 140/150 Specifications

Projector Type:	Digital Light Processing (DLP), 3-chip, 16:9 LightAmp™ DMD
Native Resolution:	1920 x 1080 (16:9)
Aspect Ratios:	Refer to Table 7-2
Video Standards:	Refer to Table 7-2
DTV Compatibility:	480p, 720p, 1080i, 1080p
Scan Frequency:	Horizontal: 15 kHz to 120 kHz Vertical: 23.97 Hz to 150 Hz
Picture Size (16:9 Screen):	Vision 140: Recommended width = 72 to 192 in. Maximum width = 300 in. Vision 150: Recommended width = 72 to 240 in. Maximum width = 350 in.
Throw Distance (Factor x Screen Width):	Refer to Table 3-3
Horizontal and Vertical Offset:	Refer to Table 3-4
Lamp:	Vision 140: 1,000 Watt Xenon lamp module Vision 150: 1,200 Watt Xenon lamp module
Estimated Lamp Life:	1,000 hours
Inputs (from VHD Controller):	(1) DVI-I with HDCP (1) RS-232
Controls:	- Built-in keypad - IR remote - Serial commands via RS-232 (from VHD Controller)

7.1 Vision 140/150 Specifications

Table 7-1. Vision 140/150 Specifications (continued)**Brightness and Contrast:****Cinema Standards Measurement System (CSMS) Specifications**

- Brightness: 86.5 foot-Lamberts (fL) (Vision 140); 102.0 fL (Vision 150)
- Contrast Ratio (variable, based on lens aperture setting): 235:1 - 275:1 (Vision 140); 224:1 - 275:1 (Vision 150)

These measurements are taken from the projector in a controlled, home theater environment. All measurements are made to ANSI/NAPM IT7.228-1997 specifications using the Photo Research PR-650 SpectraColorimeter and Minolta LS-100 Luminance Meter, Video Essentials test DVD and a 1.3 gain, 72-inch wide screen. The projector is calibrated to a color temperature of 6,500K and has a minimum of 150 hours of usage.

The foot-Lambert (fL) is the unit of measurement used in commercial movie theaters to express image brightness at the screen surface. The Society of Motion Picture and Television Engineers (SMPTE) specifies 16 fL as the target image brightness for film-based projectors using an open gate (without film in the projector). More importantly, today SMPTE specifies 12 fL as the target image brightness in Digital Cinema theaters. The foot-Lambert measurement is dependent on screen size, screen gain and projector light output.

Home Theater Calibration Specifications

- Light Output: 2750 ANSI Lumens (Vision 140); 3517 ANSI Lumens (Vision 150)
- Contrast Ratio (variable, based on lens aperture setting): 235:1 - 275:1 (Vision 140); 224:1 - 275:1 (Vision 150)

These specifications are obtained by calibrating the projector as described above for CSMS measurements.

Industry-Standard Specifications

- Light Output: 4000 ANSI Lumens (Vision 140); 6000 ANSI Lumens (Vision 150)
- Contrast Ratio (variable, based on lens aperture setting): 1500:1 - 2000:1

These are typical projector brightness and contrast specifications found in most companies' sales literature. Vidikron includes these measurements in its literature to allow for direct comparison with other manufacturers' projectors. These measurements are typically taken at 9,000K to 13,000K to get expected performance data when the projector is used in professional, commercial and industrial displays.

Power Requirements:**Vision 140:**

100 to 240 VAC (auto-sensing), 50/60 Hz, 1,650 Watts

Vision 150:

200 to 240 VAC, 50/60 Hz, 2,100 Watts

Operating Environment:

41°F to 95°F (5°C to 35°C), 20% to 80% humidity (non-condensing)

Dimensions:

See Figure 7-1

Weight (without lens):

140 lbs. (63.50 kg)

Regulatory Approvals:

Complies with FCC, CE C-Tick

Limited Warranty:

Projector: Two (2) years parts and labor from the date of delivery to the end user.

Lamp: 1000 hours or six (6) months, whichever comes first.

Specifications are subject to change without notice.

Table 7-2 lists the VHD Controller specifications.

Table 7-2. VHD Controller Specifications

Aspect Ratios:	4:3, Letterbox, 16:9, IntelliWide, Cinema, Intellwide 2.35
Video Standards:	NTSC, PAL
Inputs:	(1) Composite; (2) S-Video; (1) Component; (2) HD-R (Pr), G (Y), B (Pb), H, V; (2) HDMI with HDCP
Outputs:	HDMI with HDCP
Control Options:	<ul style="list-style-type: none"> - Discrete infrared remote - Serial commands via RS-232 - Front-panel controls
RS-232 Communication Parameters:	19200 bps, no parity, 8 data bits, 1 stop bit, no flow control
Trigger Outputs:	(3) +12 VDC, each rated at 750 mA and thermal fuse-protected
Bandwidth:	150 Mega Samples per Second (MSPS)
Power Requirements:	100 to 240 VAC (auto-sensing), 50/60 Hz, 160 Watts
Operating Environment:	41°F to 95°F (5°C to 35°C), 0% to 90% humidity (non-condensing)
Dimensions:	Width = 17.50 inches (444.5 mm) Depth = 11.19 inches (284.1 mm) Height = 3.75 inches (95.3 mm)
Weight:	13.0 lbs. (5.90 kg)
Regulatory Approvals:	Complies with FCC, CE C-Tick
Limited Warranty:	Two (2) years parts and labor from the date of delivery to the end user.
Specifications are subject to change without notice.	

7.2 VHD Controller Specifications

**7.3
Vision 140/150
Dimensions**

Figure 7-1 shows the Vision 140/150 dimensions (all dimensions are in inches).

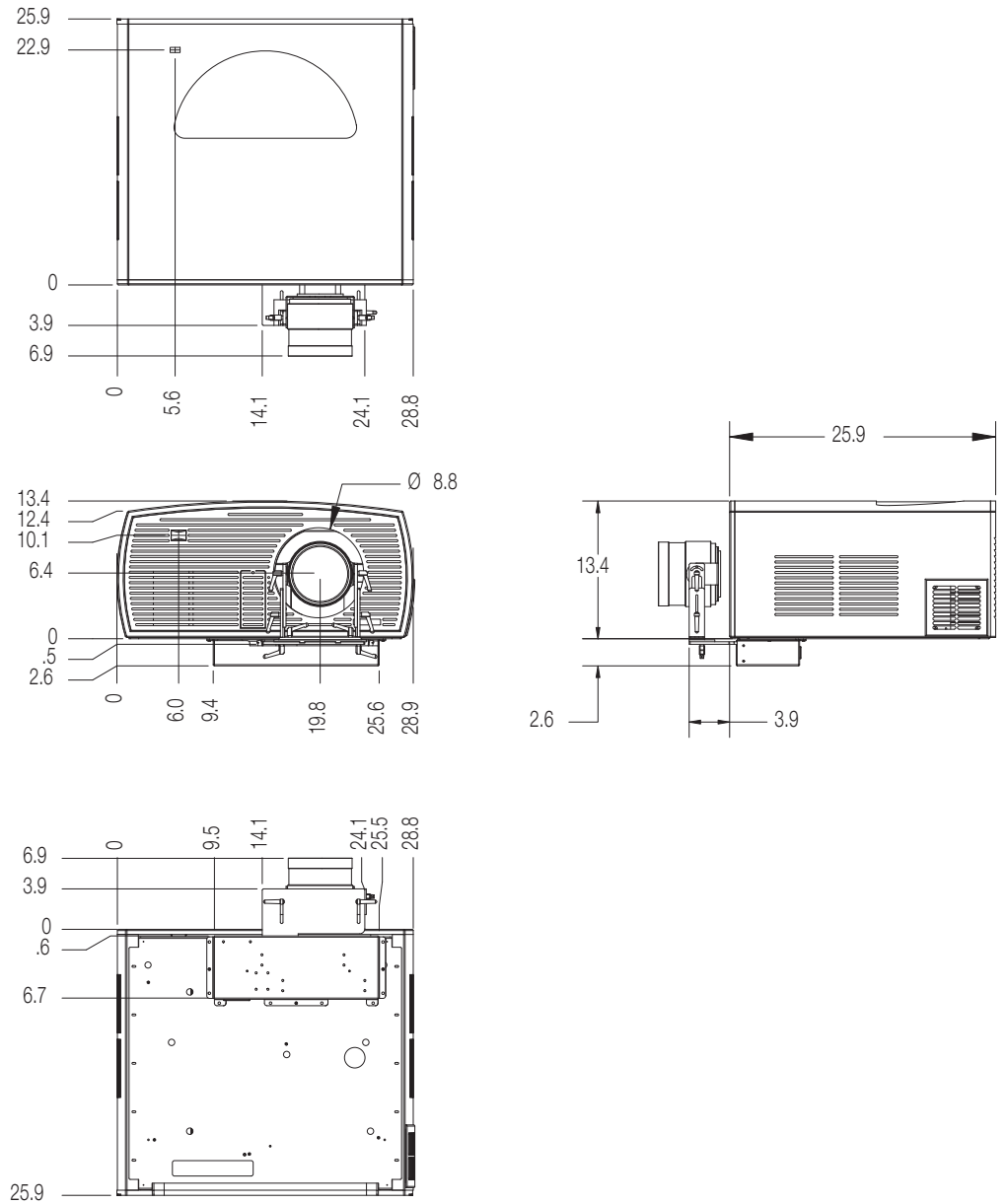

Figure 7-1. Vision 140/150 Dimensions

020-0833-01 Rev. A
March 2008



1-888-4-VIDIKRON
Fax 503-748-8161
www.vidikron.com



SERIAL NUMBER

Free Manuals Download Website

<http://myh66.com>

<http://usermanuals.us>

<http://www.somanuals.com>

<http://www.4manuals.cc>

<http://www.manual-lib.com>

<http://www.404manual.com>

<http://www.luxmanual.com>

<http://aubethermostatmanual.com>

Golf course search by state

<http://golfingnear.com>

Email search by domain

<http://emailbydomain.com>

Auto manuals search

<http://auto.somanuals.com>

TV manuals search

<http://tv.somanuals.com>