



DView™

VL-52 and VL-57

1080p HIGH-DEFINITION LCD FLAT PANEL DISPLAYS

ONE YEAR LIMITED WARRANTY

For LCD Displays

Congratulations on your purchase of a Vidikron video product and welcome to the Vidikron family! With proper installation, setup and care, you should enjoy many years of unparalleled video performance.

This is a LIMITED WARRANTY as defined in the Magnuson-Moss Warranty Act. Please read it carefully and retain it with your other important documents.

WHAT IS COVERED UNDER THE TERMS OF THIS LIMITED WARRANTY:

SERVICE LABOR: Vidikron will pay for service labor by Vidikron Authorized Service Center when needed as a result of a manufacturing defect for a period of one (1) year from the effective date of delivery to the end user.

PARTS: Vidikron will provide new or rebuilt replacement parts for the parts that fail due to defects in materials or workmanship for a period of one (1) year from the effective date of delivery to the end user. Such replacement parts are then subsequently warranted for the remaining portion (if any) of the original warranty period.

WHAT IS NOT COVERED UNDER THE TERMS OF THIS LIMITED WARRANTY:

Image retention on LCD display panels is specifically excluded from coverage under this Limited Warranty. Image retention or staining of an image is the result of misuse of the product and therefore cannot be repaired under the terms of this Limited Warranty.

Normal viewing material such as television/satellite broadcasts, videotape or DVDs (not put into pause for extended periods of time) will not cause damage to your display under normal conditions. Many DVD players are also equipped with screen savers for this reason.

TO AVOID IMAGE RETENTION (Burn-in): Please ensure that still images are not left on your LCD display panel. Also ensure that images displayed in the 4:3 aspect ratio mode (black or gray stripes, but no picture information is present on the left and right edges of the screen) are used as infrequently as possible. This will prevent permanent retention on your LCD display panel, which can be seen permanently under certain conditions once burn-in has occurred.

The types of images to avoid include video games, still images and computer screens with stationary tool bars and icons. (This is why computers are equipped with screen savers – to prevent still images from burning into the monitor's phosphors after being displayed continuously for an extended period of time).

This Limited Warranty only covers failure due to defects in materials and workmanship that occur during normal use and does not cover normal maintenance. This Limited Warranty does not cover cabinets or any appearance items; failure resulting from accident, misuse, abuse, neglect, mishandling, misapplication, faulty or improper installation or setup adjustments; improper maintenance, alteration, improper use of any input signal; damage due to lightning or power line surges, spikes and brownouts; damage that occurs during shipping or transit; or damage that is attributed to acts of God. In the case of remote control units, damage resulting from leaking, old, damaged or improper batteries is also excluded from coverage under this Limited Warranty.

CAUTION: THIS LIMITED WARRANTY ONLY COVERS VIDIKRON PRODUCTS PURCHASED FROM VIDIKRON AUTHORIZED DEALERS. ALL OTHER PRODUCTS ARE SPECIFICALLY EXCLUDED FROM COVERAGE UNDER THIS LIMITED WARRANTY. MOREOVER, DAMAGE RESULTING DIRECTLY OR INDIRECTLY FROM IMPROPER INSTALLATION OR SETUP IS SPECIFICALLY EXCLUDED FROM COVERAGE UNDER THIS LIMITED WARRANTY. IT IS IMPERATIVE THAT INSTALLATION AND SETUP WORK BE PERFORMED ONLY BY AN AUTHORIZED VIDIKRON DEALER TO PROTECT YOUR RIGHTS UNDER THIS WARRANTY. THIS WILL ALSO ENSURE THAT YOU ENJOY THE FINE PERFORMANCE OF WHICH YOUR VIDIKRON PRODUCT IS CAPABLE WHEN INSTALLED AND CALIBRATED BY VIDIKRON AUTHORIZED PERSONNEL.

RIGHTS, LIMITS AND EXCLUSIONS:

Vidikron limits its obligations under any implied warranties under state laws to a period not to exceed the warranty period. There are no express warranties. Vidikron also excludes any obligation on its part for incidental or consequential damages related to the failure of this product to function properly. Some states do not allow limitations on how long an implied warranty lasts, and some states do not allow the exclusion or limitation of incidental or consequential damages. So the above limitations or exclusions may not apply to you. This warranty gives you specific legal rights, and you may also have other rights that vary from state to state.

EFFECTIVE WARRANTY DATE:

This warranty begins on the effective date of delivery to the end user. For your convenience, keep the original bill of sale as evidence of the purchase date.

IMPORTANT -- WARRANTY REGISTRATION:

Please fill out and mail your warranty registration card. It is imperative that Vidikron knows how to reach you promptly if we should discover a safety problem or product update for which you must be notified.

CONTACT A VIDIKRON AUTHORIZED SERVICE CENTER TO OBTAIN SERVICE:

Repairs made under the terms of this Limited Warranty covering your Vidikron video product will be performed at the location of the product, during usual working hours, providing location of product is within normal operating distance from a Vidikron Authorized Service Center. In some instances it may be necessary for the product to be returned to the Vidikron factory for repairs. If, solely in Vidikron's judgment, location of product to be repaired is beyond normal operating distance of the closest Vidikron Authorized Service Center, or the repair requires the unit be returned to the Vidikron factory, it is the owner's responsibility to arrange for shipment of the product for repair. These arrangements must be made through the selling Vidikron Dealer. If this is not possible, contact Vidikron directly for a Return Authorization number and shipping instructions. Vidikron will return product transportation prepaid in the United States, unless no product defect is discovered. In that instance, shipping costs will be the responsibility of the owner.

COPYRIGHT AND TRADEMARKS:

© Copyright 2007 Vidikron, a Runco International Company. This document contains proprietary information protected by copyright, trademark and other intellectual property laws. All rights are reserved. No part of this manual may be reproduced by any mechanical, electronic or other means, in any form, without prior written permission of the manufacturer.

Vidikron, Vision, DVSI, Imagix, CineWide, AutoScope, V² Aperture Control, CSMS and IntelliWide are trademarks of Runco, LLC, licensed to Vidikron, a division of Runco International. All other trademarks and registered trademarks used in this document are the property of their respective owners.

Vidikron products are manufactured under one or more of the following patents: US. Patent 6755540 and Other Patents Pending.

ADDITIONAL INFORMATION:

To locate the name and address of the nearest Vidikron Authorized Service Center, or for additional information about this Limited Warranty, please call or write:

VIDIKRON
Attn: Customer Service Department
2900 Faber Street
Union City, CA 94587
Ph: (510) 324-5900
Fax: (510) 324-5905
Toll Free: (888) 4VIDIKRON

VIDIKRON PRODUCT INFORMATION
RETAIN THIS INFORMATION FOR YOUR RECORDS

Model Purchased

Date

Serial Number

Vidikron Authorized Dealer Name

Address

City

State/Province

Postal Code

Phone

Fax

Important Safety Instructions

Thank you for your purchase of this quality Vidikron product! For best performance, please read this manual carefully as it is your guide through the menus and operation.

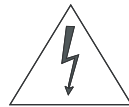
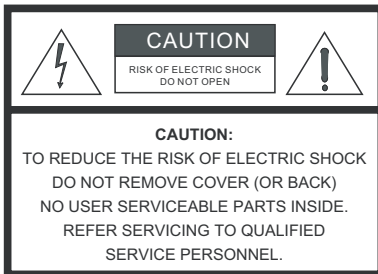

WARNING

This symbol is intended to alert the user to the presence of uninsulated "dangerous voltage" within the product's enclosure that may be of sufficient magnitude to constitute a risk of electric shock.



This symbol is intended to alert the user to the presence of important operating and maintenance (servicing) instructions in the literature accompanying the appliance.

1. Read these instructions.
2. Keep these instructions.
3. Heed all warnings.
4. Follow all instructions.
5. Do not use this apparatus near water.
6. Clean only with a dry cloth.
7. Do not block any of the ventilation openings. Install in accordance with the manufacturer's instructions.
8. Do not install near any heat sources such as radiators, heat registers, stoves, or other apparatus (including amplifiers) that produce heat.
9. Do not defeat the safety purpose of the polarized or grounding type plug. A polarized plug has two blades with one wider than the other. A grounding type plug has two blades and a third grounding prong. The wide blade or the third prong is provided for your safety. When the provided plug does not fit into your outlet, consult an electrician for the replacement of the obsolete outlet.
10. Protect the power cord from being walked on or pinched particularly at plugs, convenience receptacles and the point where they exit from the apparatus.
11. Only use the attachments/accessories specified by Vidikron.
12. Use only with a cart, stand, tripod, bracket or table specified by the manufacturer or sold with the apparatus. When a cart is used, use caution when moving the cart/apparatus to avoid injury from tip-over.
13. Unplug this apparatus during lightning storms or when unused for long periods of time.
14. Refer all servicing to qualified service personnel. Servicing is required when the apparatus has been damaged in any way, such as power supply cord or plug is damaged, liquid has been spilled or objects have fallen into the apparatus, the apparatus has been exposed to rain or moisture, does not operate normally, or has been dropped.



Compliance Information

DECLARATION OF CONFORMITY:

Manufacturer's Name: Vidikron, a subsidiary of Planar Systems, Inc.

Manufacturer's Address: 2900 Faber Street, Union City, CA 94587

hereby declares that the products Model Numbers:

VL-52, VL-57

conform with the provisions of:

Council Directive 2004/108/EC on Electromagnetic Compatibility;

EN 55022 "Limits and methods of measurements of radio interference characteristics of information technology equipment" 1998;

EN 55024 "Limits and methods of measurements of immunity characteristics of information technology equipment" 1998;

Including:

- EN 61000-4-2 "Electromagnetic compatibility (EMC) Part 4: Testing and measurement techniques Section 2: Electrostatic discharge immunity test"
- EN 61000-4-3 "Electromagnetic compatibility (EMC) Part 4: Testing and measurement techniques Section 3: Radiated, Radio-Frequency, Electromagnetic Field Immunity Test"
- EN 61000-4-4 "Electromagnetic compatibility (EMC) Part 4: Testing and measurement techniques Section 4: Electrical fast transient/burst immunity test"
- EN 61000-4-5 "Electromagnetic compatibility (EMC) Part 4: Testing and measurement techniques Section 5: Surge immunity test"
- EN 61000-4-6 "Electromagnetic compatibility (EMC) Part 4: Testing and measurement techniques Section 6: Conducted disturbances induced by radio-frequency fields immunity test"
- EN 61000-4-8 "Electromagnetic compatibility (EMC) Part 4: Testing and measurement techniques Section 8: Conducted disturbances induced by power frequency magnetic fields immunity test"
- EN 61000-4-11 "Electromagnetic compatibility (EMC) Part 4: Testing and measurement techniques Section 11: Voltage dips, short interruptions and voltage variations immunity tests"

And:

- EN 61000-3-2 "Electromagnetic compatibility (EMC) Part 3, Section 2: Limits for harmonic current emissions (equipment input current up to and including 16 A per phase)" 2000;
- EN 61000-3-3 "Electromagnetic compatibility (EMC) Part 3, Section 3: Limitations of voltage changes, voltage fluctuations and flicker in public low-voltage supply systems, for equipment with rated current up to and including 16 A and not subject to conditional connection" 1995;

Council Directive 2006/95/EC and amended by M1 and C1 on Low Voltage Equipment Safety;

EN 60950 "Safety of information technology equipment, including electrical business equipment"

The Technical Construction file required by this Directive is maintained at the corporate headquarters of Planar Systems, Inc., 1195 NW Compton Drive, Beaverton, OR 97006.

FCC PART 15:

NOTE: This equipment has been tested and found to comply with the limits for a Class B digital device, pursuant to Part 15 of the FCC Rules. These limits are designed to provide reasonable protection against harmful interference in a residential installation.

This equipment generates, uses and can radiate radio frequency energy and, if not installed and used in accordance with the instructions, may cause harmful interference to radio communications. However, there is no guarantee that interference will not occur in a particular installation. If this equipment does cause harmful interference to radio or television reception, which can be determined by turning the equipment off and on, the user is encouraged to try to correct the interference by one or more of the following measures:

- Reorient or relocate the receiving antenna.
- Increase the separation between the equipment and receiver.
- Connect the equipment into an outlet on a circuit different from that to which the receiver is connected.
- Consult the dealer or an experienced radio/TV technician for help.

INDUSTRY CANADA (ICES-003):

This Class B digital apparatus complies with Canadian ICES-003.

Cet appareil numérique de la classe B est conforme à la norme NMB-003 du Canada.

IMPORTANT RECYCLE INSTRUCTIONS



Lamp(s) inside this product contain mercury. This product may contain other electronic waste that can be hazardous if not disposed of properly. Recycle or dispose in accordance with local, state, or federal Laws.

For more information, contact the Electronic Industries Alliance at WWW.EIAE.ORG.

For lamp specific disposal information check WWW.LAMPRECYCLE.ORG.

DISPOSAL OF OLD ELECTRICAL AND ELECTRONIC EQUIPMENT (Applicable throughout the European Union and other European countries with separate collection programs)



This symbol found on your product or on its packaging, indicates that this product should not be treated as household waste when you wish to dispose of it. Instead, it should be handed over to an applicable collection point for the recycling of electrical and electronic equipment. By ensuring this product is disposed of correctly, you will help prevent potential negative consequences to the environment and human health, which could otherwise be caused by inappropriate disposal of this product. The recycling of materials will help to conserve natural resources. This symbol is only valid in the European Union. If you wish to discard this product, please contact your local authorities or dealer and ask for the correct method of disposal.

Table of Contents

ONE YEAR LIMITED WARRANTY	iii
Important Safety Instructions	vi
Compliance Information	vii
1. Introduction	1
About This Manual	1
Target Audience.....	1
If You Have Comments About This Manual.....	1
Textual and Graphic Conventions	1
Using This Manual	2
Description, Features and Benefits	3
Key Features and Benefits.....	3
Parts List	4
2. Controls and Functions	5
DView at a Glance	5
Controls and Indicators	5
DView Inputs and Outputs.....	6
DView Remote Control	9
3. Installation	13
Remote Control	13
Battery Installation	13
Notes on Remote Control Operation.....	13
Quick Setup	14
Installation Considerations	15
Wall-Mounting the DView	15
Ambient Light	15
Other Considerations	15
Connections to the DView	16
Connecting the DView to Source Components	16
AV OUT Connection	20
Connecting Headphones.....	20
Connecting External Speakers (Optional).....	21
Connecting to a Dolby Digital Amplifier	21
RS-232 Controller Connection	22

4. Operation	23
Turning on the Power	23
Changing the OSD Language	23
Setting the PC Display Properties	24
Using the On-Screen Menus	25
Main Menu	27
Source	27
Aspect Ratio	27
Picture Adjust.....	29
Audio	33
Channel (VL-52 only)	34
Timer (VL-52 only)	35
Setup	36
ISF Calibration	40
Using Picture-In-Picture (PIP)	43
Changing the PIP Position	45
Changing the PIP Size	45
Changing the PIP Aspect Ratio	45
Swapping the Main and PIP Images	46
Swapping the Main and PIP Audio Programs	46
Stereo Sound/SAP (VL-52 only)	47
5. Maintenance and Troubleshooting	49
Cleaning	49
Cleaning the Display Panel Body and Remote Control.....	49
Cleaning the Screen.....	49
Cleaning the Vents	49
Troubleshooting Tips	49
6. Serial Communications	51
RS-232 Connection and Port Configuration	51
Serial Command Syntax	51
7. Specifications	57
DView Specifications	57
DView Dimensions	59
Computer Signal Compatibility	61

List of Figures

2-1. DView Controls and Indicators	5
2-2. DView Rear-Panel Inputs and Outputs	6
2-3. DView Remote Control	9
3-1. Antenna/Cable TV Connection	16
3-2. HDMI Connections	17
3-3. Analog RGB Connections	18
3-4. Component Video Connections	19
3-5. Composite and S-Video Connections	19
3-6. AV OUT Connections	20
3-7. Connecting Headphones	20
3-8. External Speaker Connection	21
3-9. Digital Audio Connection	21
3-10. RS-232 Control System Connection	22
4-1. DView OSD Menu Structure	26
4-2. Typical PLUGE Pattern for Adjusting Brightness	29
4-3. Typical Gray Bar Pattern for Adjusting Contrast	30
4-4. Typical Color Bar Pattern for Adjusting Color Saturation and Tint	31
4-5. Typical Test Pattern for Adjusting Sharpness	32
4-6. DView Splash Screen	42
7-1. VL-52 Dimensions	59
7-2. VL-57 Dimensions	60

Notes:

Introduction

This Owner's Manual describes how to install, set up and operate the Vidikron DView™ VL-52/VL-57 Flat-Panel LCDs. Throughout this manual, the Vidikron DView™ VL-52/VL-57 Flat-Panel LCDs are referred to simply as the "DView."

Vidikron has prepared this manual to help home theater installers and end users get the most out of the DView.

Vidikron has made every effort to ensure that this manual is accurate as of the date it was printed. However, because of ongoing product improvements and customer feedback, it may require updating from time to time. You can always find the latest version of this and other Vidikron product manuals on-line, at www.Vidikron.com.

Vidikron welcomes your comments about this manual. Send them to info@Vidikron.com.

Text Conventions: The following conventions are used in this manual, in order to clarify the information and instructions provided:

- Remote control button identifiers are set in upper-case bold type; for example, "Press **EXIT** to return to the previous menu."
- Computer input (commands you type) and output (responses that appear on-screen) is shown in monospace (fixed-width) type; for example: "To change the aspect ratio to Letterbox, type [S4E0002."
- All keys with functional names are initial-capped, set in bold type and enclosed in angle brackets. These keys are the following: <Enter>, <Spacebar>, <Control>, <Esc> and <Tab>.
- <Enter> indicates that you may press either the RETURN or ENTER key on your computer keyboard if it has both keys.

In addition to these conventions, underlining, boldface and/or italics are occasionally used to highlight important information, as in this example:



Note

*A carriage return **must** be used after each command or string.*

1.1 About This Manual

◀ Target Audience

◀ If You Have Comments About This Manual...

◀ Textual and Graphic Conventions

Graphic Conventions: These symbols appear in numerous places throughout the manual, to emphasize points that you must keep in mind to avoid problems with your equipment or injury:



Tip

TIPS highlight time-saving short cuts and helpful guidelines for using certain features.



Note

NOTES emphasize text with unusual importance or special significance. They also provide supplemental information.



Caution

CAUTIONS alert users that a given action or omitted action can degrade performance or cause a malfunction.



WARNING

WARNINGS appear when a given action or omitted action can result in damage to the equipment, or possible non-fatal injury to the user.



DANGER!

DANGER appears when a given action can cause severe injury or death.

1.2 Using This Manual

Use the following table to locate the specific information you need in this manual.

If you need...	... Turn to page:
Information about obtaining service	iv
General information about the DView™ VL-52/VL-57 Flat-Panel LCDs	3
Installation instructions	13
First-time configuration instructions	23
Advanced configuration instructions	40
Troubleshooting tips	49
Specifications for the DView™ VL-52/VL-57 Flat-Panel LCDs	57

Vidikron presents the DView™ VL-52/VL-57 Flat-Panel LCDs, perfect for those who demand our award-winning flat panel performance along with advanced LCD technology and lightweight design.

The DView incorporates the superb Imagix™ digital video processing that produces outstanding picture quality with a wide range of both standard and high definition source material. In addition, the DView includes the complete Imaging Science Foundation™ (ISF) calibration suite to deliver the absolute best images possible under multiple viewing conditions.

The DView Model VL-52 also features a built-in ATSC tuner that receives terrestrial DTV broadcasts, in addition to an advanced, 185-channel, cable-ready NTSC stereo tuner. The VL-52 offers PIP, PBP, closed captioning, Parental Control (V-Chip) functionality and multi-language support. The display includes an integrated stereo audio system incorporating surround sound technology and generous power amplification.

The advanced, TFT active-matrix liquid crystal display panel offers 1920 x 1080 resolution and includes Vidikron's discrete aspect ratio control with IntelliWide™ mode to fill the 16:9 screen with standard 4:3 images without loss of picture quality. Also included are discrete source, aspect ratio and power selection and an RS-232 interface for whole-house or automated control system integration.

The DView is multimedia-ready, with simple computer connections making gaming, Internet browsing and other computing activities quick and easy.

The DView offers these key features and benefits:

- Native Resolution: 1920 x 1080 (16:9 Native aspect ratio)
- Multiple aspect ratios with IntelliWide™ mode
- Less than 5 inches deep
- Two HDMI Inputs with High-bandwidth Digital Content Protection (HDCP)
- Model VL-52 has built-in HDTV Tuner
- Exceptional detail and artifact-free video enhancement
- Vidikron video processing with 3:2 film detection circuitry

1.3 Description, Features and Benefits

◀ **Key Features and Benefits**

Parts List ➤ Your DView is shipped with the following items. If any items are missing or damaged, please contact your Vidikron dealer or Vidikron Customer Service at (888) 4VIDIKRON.

- VL-52 or VL-57 LCD Display (with Table Stand)
- Remote Control Unit and two (2), AAA-size batteries
- AC Power Cord
- Warranty information and registration card
- Vidikron VL-52 and VL-57 Owner's Operating Manual (this document)

Optional Accessories:

- Wall Mount kit

Controls and Functions

2.1 DView at a Glance

◀ Controls and Indicators

Figure 2-1 shows the locations of the DView controls and indicators.

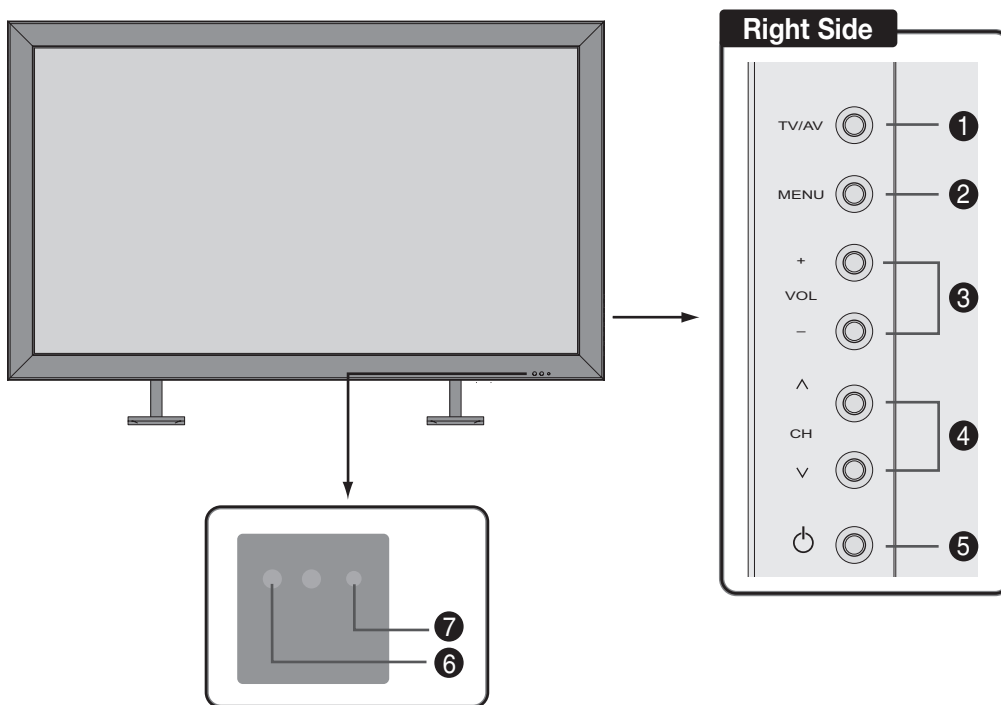

Figure 2-1. DView Controls and Indicators

1. **TV/AV Button (Input Source Selection)**

To select a source, press the **TV/AV** button (with no menus visible on-screen). Use the **CH ▲** or **CH ▼** button (see below) to highlight the desired input source and press **TV/AV** again.

When a menu is visible on-screen, this button operates identically to the **ENTER** button on the DView remote control unit (refer to **DView Remote Control** on page 9).

2. **MENU Selection Button**

Press this button to access the on-screen display (OSD) controls, or to exit the current menu and return to the previous one.

3. **Volume Adjustment Buttons (VOL - / VOL +)**

Use these buttons to adjust the sound volume. When a menu is visible on-screen, these buttons operate identically to the left- and right-arrow (◀ and ▶) buttons on the DView remote control unit.

4. **CH ▲ / CH ▼**

Use these buttons to scroll through available TV channels (VL-52 only).

When a menu is visible on-screen, these buttons operate identically to the up- and down-arrow (▲ and ▼) buttons on the DView remote control unit.

5. **Power Button**

6. **Remote Control Sensor**

7. **Status Indicator LED**

- Lights red to indicate that the DView is in standby mode;
- Lights green during power-on sequence and during normal operation;
- Flashes green when the DView receives a signal from the remote control.

DView Inputs and Outputs ►

Figure 2-2 shows the locations of the DView inputs and outputs.

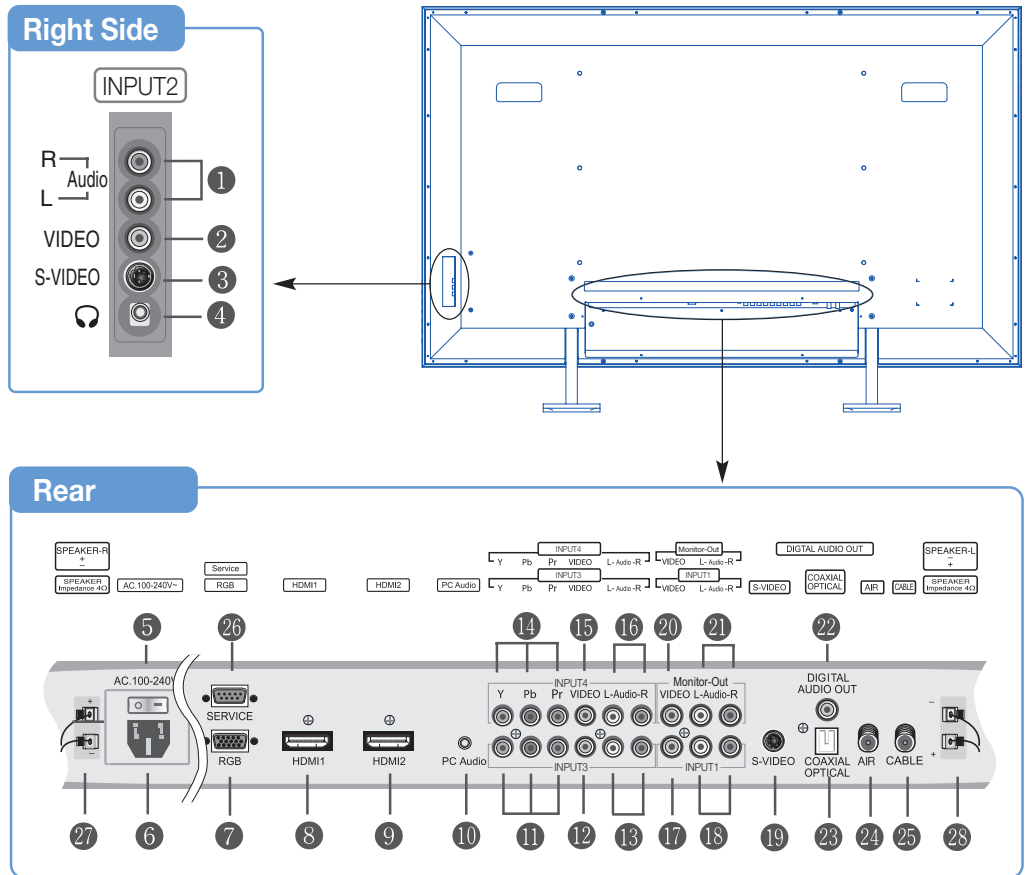

Figure 2-2. DView Rear-Panel Inputs and Outputs

1. **INPUT2 Audio Input**

2. **INPUT2 Composite Video Input**

Standard composite video input for connecting a VCR, camcorder, laser disc player or other composite video source.

3. INPUT2 S-Video Input

Standard S-Video input for connecting a DVD player, satellite receiver or Super VHS (S-VHS) VCR.

4. Headphone Jack**5. Main Power Switch****6. Power Input (100 to 240 VAC)**

Connect the DView to power here.

7. RGB

A 15-pin VGA connection to a personal computer. The DView automatically detects the signal resolution.

8. HDMI1/Computer Input (Digital)**9. HDMI2/Computer Input (Digital)**

Two, HDCP-compliant digital video inputs for connecting a DVD player, personal computer or HD tuner with a DVI or HDMI output.

*Tip*

For best results, do not run your DVD player in progressive mode.

10. PC Audio Input

Connect the audio output from a personal computer here.

11. INPUT3 Component Video (RCA connectors)

Standard-definition (480i/576i) or high-definition (720p/1080i), YPrPb component input. This is the input for component video from sources such as DVD players.

12. INPUT3 Composite Video Input**13. INPUT3 Audio Input**

Connect the audio output from your Input 3 source here.

14. INPUT4 Component Video (RCA connectors)

Standard-definition (480i/576i) or high-definition (720p/1080i), YPrPb component input. This is the input for component video from sources such as DVD players.

15. INPUT4 Composite Video Input**16. INPUT4 Audio Input**

Connect the audio output from your Input 4 source here.

17. INPUT1 Composite Video Input**18. INPUT1 Audio Input**

Connect the audio output from your Input 1 source here.

19. INPUT1 S-Video Input**20. Monitor-OUT (Composite Video)****21. Monitor-OUT (Audio)****22. DIGITAL AUDIO OUT (S/PDIF – Coaxial)****23. DIGITAL AUDIO OUT (TosLink – Optical)**

Connect either #22 or #23 to the digital audio input of an A/V amplifier with a Dolby Digital[®] decoder.

24. **AIR (Antenna) Input (VL-52 only)**

75-ohm coaxial input for connecting a TV antenna to the digital TV input.

25. **CABLE Input (VL-52 only)**

75-ohm coaxial input for connecting a CATV system to the digital TV input.

26. **RS-232 CONTROL PORT**

A female, 9-pin D-sub connector for interfacing with a PC or home theater automation/control system.

27. **SPEAKER OUTPUT (RIGHT)**

28. **SPEAKER OUTPUT (LEFT)**

For connection of the right (27) left (28) speakers. Connect a speaker with an impedance of 4 ohms.

Figure 2-3 shows the DView remote control, and the paragraphs that follow describe its functionality.

2.2 DView Remote Control

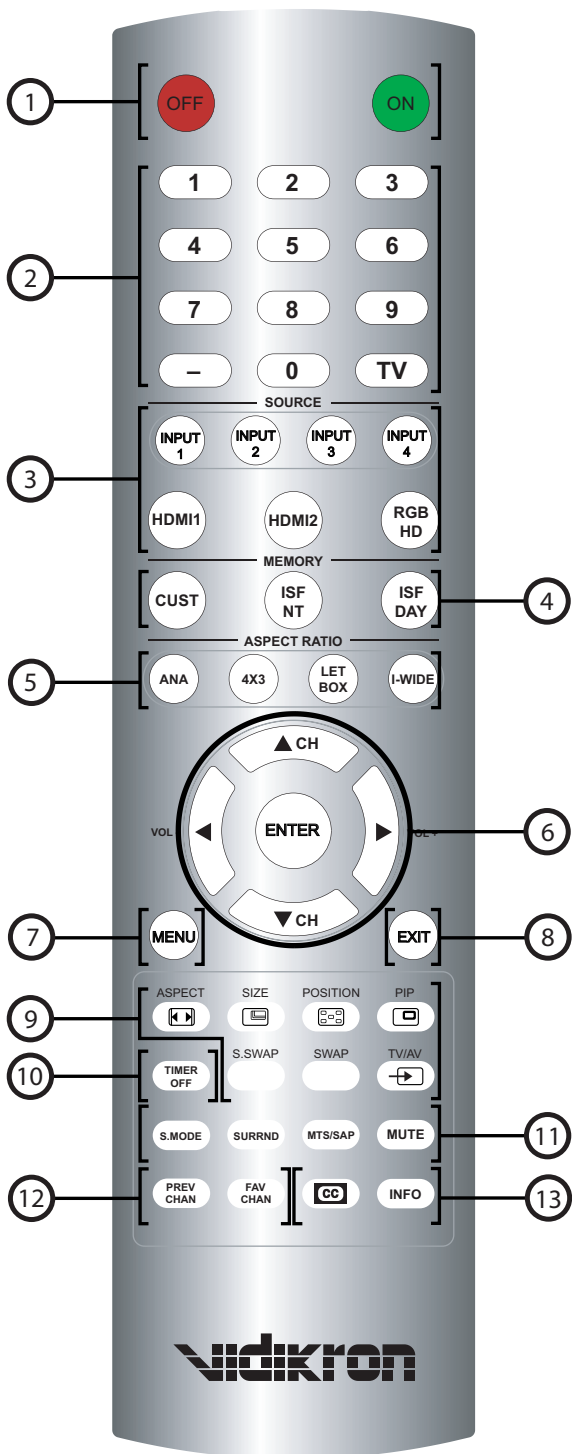

Figure 2-3. DView Remote Control

1. **OFF / ON**
Use these buttons to turn the DView on or off.
2. **Numeric Buttons**
Use these buttons to enter menu pass codes.

VL-52 only: Use the numeric buttons to enter TV channel numbers. Use the **TV** button to switch to the Antenna/DTV/CATV input. Use the **-** button to enter DTV sub-channel numbers.

3. **Source Selection Buttons**

INPUT 1

Press this button to switch to Input 1.

INPUT 2

Press this button to switch to Input 2.

INPUT 3

Press this button to switch to Input 3.

INPUT 4

Press this button to switch to Input 4.



Note

Input 1 and Input 2 have both S-Video and composite video connectors. Input 3 and Input 4 have both component and composite video connectors.

*To specify which connection type you are using – or to switch from one to the other if equipment is connected to both – use the Input Selection menu under Setup (refer to **Input Selection** on page 38).*

HDMI 1 / HDMI 2

Use these buttons to select a Digital Video input (HDMI 1 or HDMI 2).

RGB HD

Press this button to switch to the RGB HD input.

4. **Memory Preset Buttons**

CUST

Press to recall settings for the current input from the “Custom” memory preset.

ISF NT (Night)

Press to recall settings for the current input from the “ISF Night” memory preset.

ISF DAY

Press to recall settings for the current input from the “ISF Day” memory preset.

5. Aspect Ratio Selection Buttons

ANA (16:9 Anamorphic)

For 16:9 DVDs or HDTV program material.

4X3 (Standard 4:3)

The input signal is scaled to fit 4:3 display mode in the center of the screen.

LETBOX (Letterbox)

Image in letterbox format is enlarged to fit 16:9, full-screen display and the upper/lower portions are "blanked off."

I-WIDE (IntelliWide)

4:3 image is enlarged NON-linearly in horizontal direction to fit 16:9 full screen display.

6. Arrow Buttons (▲, ◀, ▼, ▶)

Use these buttons to change TV channels (VL-52 only), select items or settings, adjust settings or adjust sound volume.

ENTER

Press to select a highlighted menu item or confirm a changed setting.

7. MENU

Press this button to access the on-screen display (OSD) controls, or to exit the current menu and return to the previous one.

8. EXIT

Press this button to hide the OSD controls.

9. Picture-In-Picture (PIP) Function Buttons

ASPECT

Press to change the aspect ratio of the PIP window from 4:3 to 16:9 or vice versa.

SIZE

Press to choose from three PIP window sizes.

POSITION

Press to choose the PIP window position (top left, top right, bottom left or bottom right corner).

PIP

Press to change the PIP mode (picture-in-picture, picture-by-picture or off).

P.MODE

Press to recall settings for the PIP input from either the "ISF Night" or "ISF Day" memory preset.

S.SWAP

Press to switch between the main and PIP audio programs.

SWAP

Press to swap the main and PIP windows.

TV/AV

Press to switch to a different PIP video source.

10. **TIMER OFF Button**

Press this button to set the sleep timer. Press it repeatedly to scroll through the available options (Off, 10, 30, 60, 120 or 180 minutes).

11. **Sound Control Buttons**

S.MODE

Press this button repeatedly to scroll through the available Equalizer presets (CUSTOM, STANDARD, MUSIC, FILM or SPEECH).

SURRND (Surround)

Press this button to turn Surround Mode on or off.

MTS/SAP (Multichannel Television Sound/Second Audio Program) (VL-52 only)

Press this button repeatedly to scroll through the available MTS settings (MONO, STEREO, SAP or Mono+SAP).

MUTE

Press this button to mute the audio output to the speakers and headphones.

12. **Channel Selection Short-Cuts (VL-52 only)**

PREV CHAN

Press this button to return to the previously-selected channel.

FAV CHAN

Press this button repeatedly to select a stored, "favorite" channel. You can store up to five favorite channels. To store favorite channels, select Favorite Channel from the Channel (VL-52 only) menu (described in Section 4).

13. **Miscellaneous Functions**

CLOSED CAPTIONING  (VL-52 only)

Press this button to turn Closed Captioning on or off.

INFO

Press this button to view program information (if available) when viewing DTV channels (VL-52 only) or input signal information (source and resolution).

3.1 Remote Control

◀ Battery Installation

To install batteries in the remote control:

1. Slide the battery cover in the direction of the arrow and remove it.
2. Insert the included batteries. Ensure that the polarities correctly match the ⊕ and ⊖ markings inside the battery compartment.
3. Slide the battery cover back on until it snaps into place.



Note

1. Do not mix an old battery with a new one or different types of batteries.
2. If you will not use the remote control for a long time, remove the batteries to avoid damage from battery leakage.

- Do not drop the remote control or expose it to moisture or high temperature.
- The remote control may malfunction under a fluorescent lamp. If that occurs, move the LCD display away from the fluorescent lamp.
- Make sure that there is nothing obstructing the infrared beam between the remote control and the IR receiver on the LCD display.



Note

The signal from the remote control can be reflected by walls or other surfaces.

- If the effective range of the remote control decreases, or it stops working, replace the batteries with new ones.
- Ambient conditions may possibly impede the operation of the remote control. If this happens, point the remote control at the LCD display and repeat the operation.

◀ Notes on Remote Control Operation

3.2 Quick Setup

Table 3-1 gives a quick overview of the DView installation process. The sections following this one provide detailed instructions.



Note

Installation should be performed by a qualified custom video installation specialist.

Table 3-1. Installation Overview

Step	Procedure	For Details, refer to page...
1	Mount the DView on a wall (optional)	15
2	Connect signal sources to the DView	16
3	Connect external controller to RS-232 port (optional)	22
4	Apply power to the DView	23
5	Change the OSD language	23
6	If using the DView with a PC, adjust PC display properties	24
7	Display calibration: adjust the following for each input ; save settings when finished: <ul style="list-style-type: none"> • Brightness • Contrast • Color level • Tint • Input position 	27 through 39

Proper installation of your DView will ensure the highest possible picture quality. Whether you are installing the DView temporarily or permanently, you should take the following into account to ensure that it performs optimally.

You can either place the DView on a table or in an entertainment center, or mount it on a wall.

If you do decide to wall-mount the DView, ensure that the wall-mount bracket is installed according to the instructions included with it. The wall must be capable of supporting a redundant weight factor three (3) times the weight of the display, or be reinforced.

Vidikron recommends that this be done by a custom installation specialist.

**Note**

Use only the Vidikron-approved wall-mount kit designed for your display.

In general, minimize or eliminate light sources directed at the display. Contrast ratio in your images will be noticeably reduced if light directly strikes the display, such as when a shaft of light from a window or floodlight falls on the image. Images may then appear washed out and less vibrant.

Other considerations and tips that can help improve your installation:

- Keep the ambient temperature constant and below 35°C (95°F). Keep the display away from heating and/or air conditioning vents. Changes in temperature may cause drifts in the display circuitry, which may affect performance.
- Keep the DView away from devices that radiate electromagnetic energy such as motors and transformers. Common sources of these include slide projectors, speakers, power amplifiers and elevators.

3.3 Installation Considerations

◀ *Wall-Mounting the DView*

◀ *Ambient Light*

◀ *Other Considerations*

3.4 Connections to the DView

Proceed as follows to connect the DView to your video sources, external controller(s) – if present – and AC power.

When connecting your equipment:

- Turn off all equipment before making any connections.
- Use the correct signal cables for each source.
- Ensure that the cables are securely connected. Tighten the thumbscrews on connectors that have them.
- Use the left audio input when connecting mono audio sources.

Connecting the DView to Source Components

Connect your video sources to the DView as shown and described in the sections that follow.

Antenna/Cable TV Connection (VL-52 only): Connect your antenna or cable television source to the AIR or CABLE jacks on the rear of the DView; see Figure 3-1.

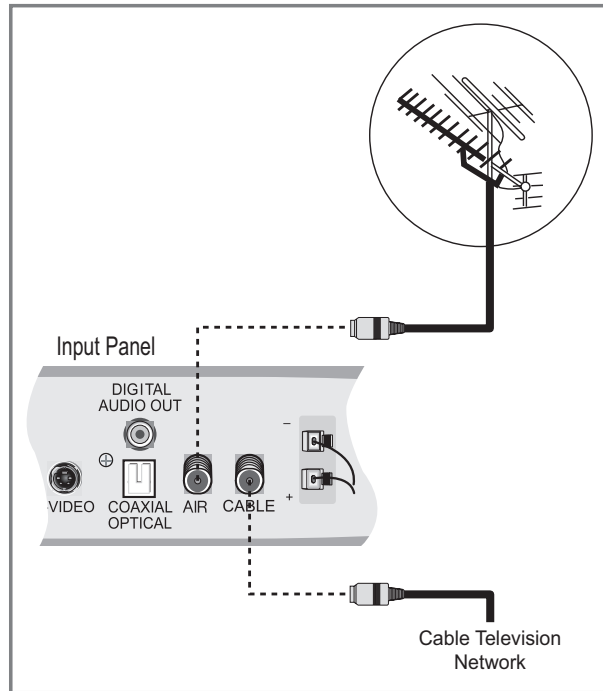

Figure 3-1. Antenna/Cable TV Connection

HDMI Connections: The DView has two HDMI inputs for connecting a BD/HD-DVD/DVD player, DTV decoder, personal computer or any other device with an HDMI or DVI output. Connect such devices as shown in Figure 3-2.



Tip

Use the HDMI inputs whenever possible. This ensures the highest video quality because the signal is carried in the digital domain throughout the entire signal path, from source component output into the display.



Note

This DView supports the VESA Display Data Channel (DDC) standard. This standard provides “Plug and Play” capability; the display and a VESA DDC-compatible computer communicate their setting requirements, allowing for quick and easy setup.

In order for Plug and Play to work correctly, you must turn on the display before you turn on the connected computer.

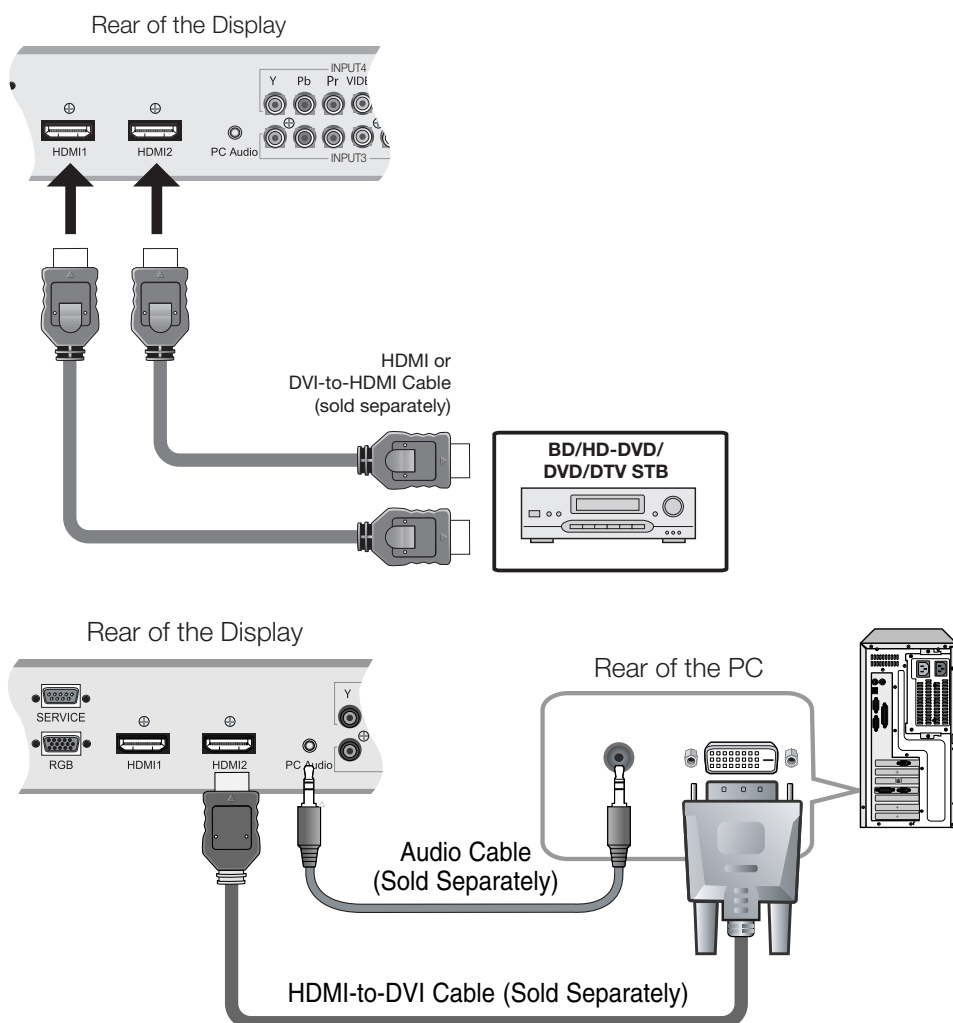

Figure 3-2. HDMI Connections

RGB Connections: The DView has an RGB input for connecting a personal computer; see Figure 3-3.

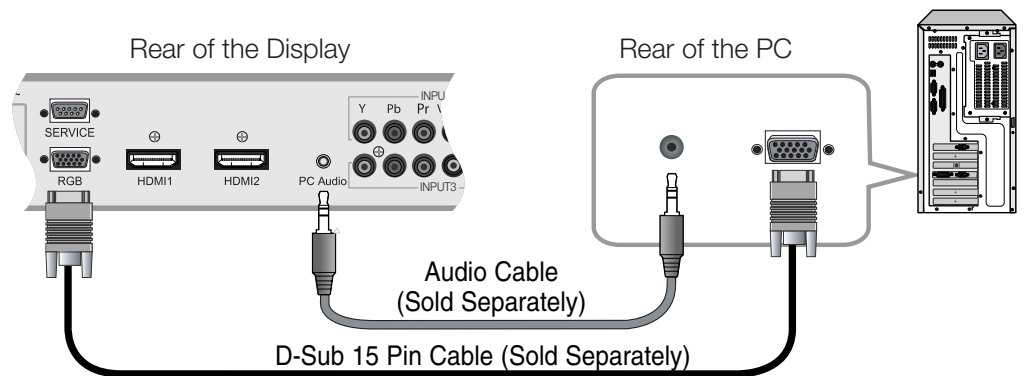

Figure 3-3. Analog RGB Connections



Note

1. Refer to **Computer Signal Compatibility** on page 61 for a list of computer signals compatible with the DView. Use with signals other than those listed may cause some functions not to work.
2. Some Macintosh computers may require a Macintosh video adapter. Contact your nearest authorized service center or dealer.
3. This DView may not be able to display images from notebook computers in simultaneous (CRT/LCD) mode. Should this occur, switch the notebook computer to "CRT only" mode. If you are unsure how to do this, refer to your notebook computer's user manual.

Component Video Connections: If you have a DVD player or DTV decoder with a component (YPbPr) output, connect it to INPUT 3 or INPUT 4 of the DView as shown in Figure 3-4.

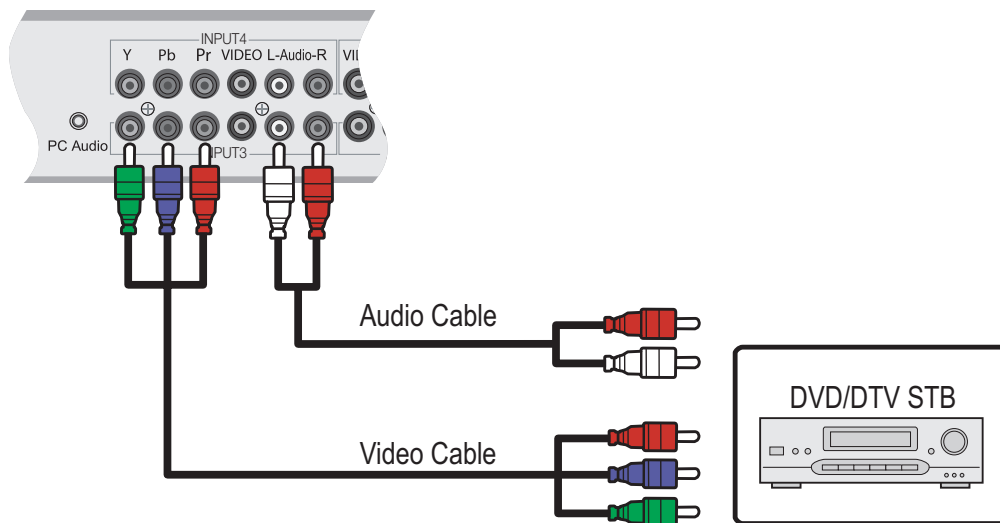

Figure 3-4. Component Video Connections

Composite/S-Video Connections: The DView has two (2) S-Video and four (4) composite video inputs for connecting a VCR, camcorder, laser disc player or DVD player; see Figure 3-5.

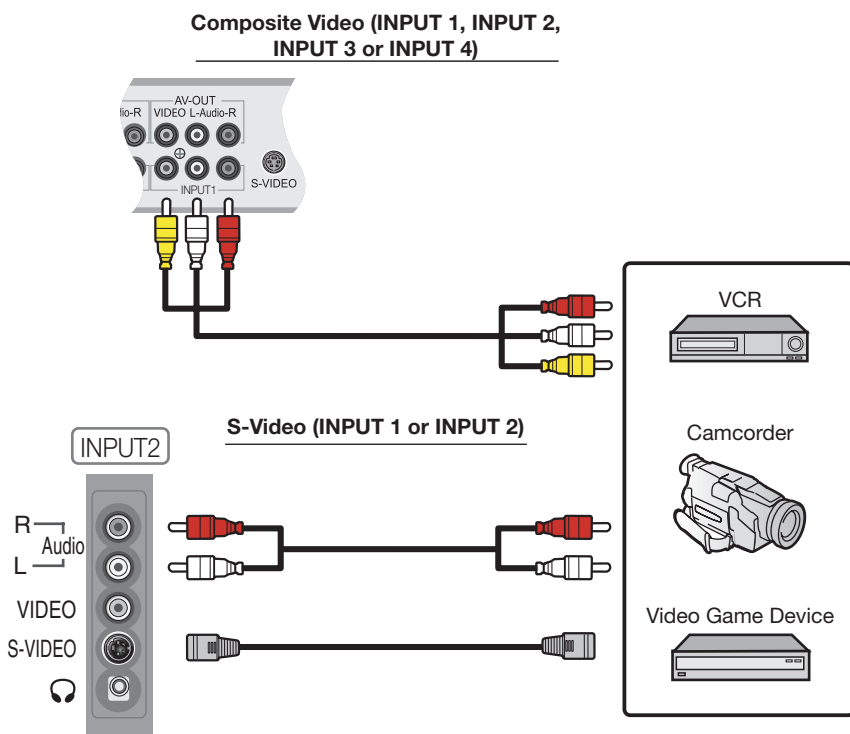

Figure 3-5. Composite and S-Video Connections

AV OUT Connection ➤ The DView has stereo audio and Composite video outputs for connecting to a second VCR or other auxiliary equipment. Connect the AV OUT audio and video jacks to the audio and video inputs of the VCR or other equipment as shown in Figure 3-6.

You can route either the main or picture-in-picture (PIP) source signal to the AV output. For more information, refer to **Monitor Out** on page 38.



Note

The audio output level is fixed. (The volume and mute controls affect only the speaker and headphone outputs.)

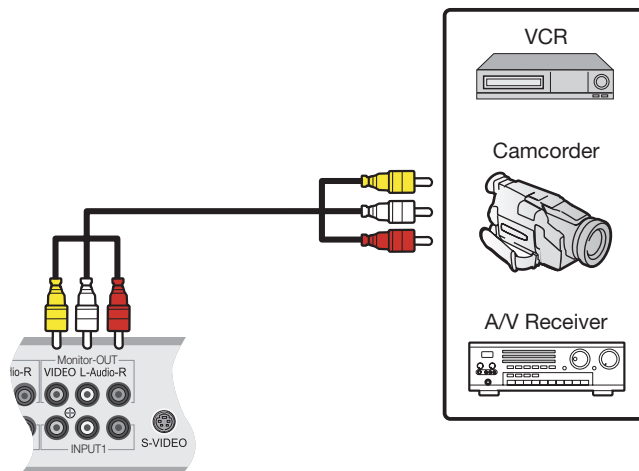

Figure 3-6. AV OUT Connections

Connecting Headphones ➤ You can connect a set of headphones to the DView to watch a program without disturbing others. Connect them to the headphone output located at INPUT2; see Figure 3-7.

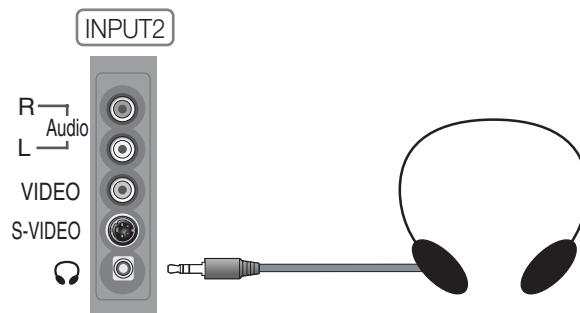

Figure 3-7. Connecting Headphones

Connect the ⊕ (positive) and ⊖ (negative) speaker wires to the rear-panel SPEAKER-R and SPEAKER-L terminals; see Figure 3-8. **Maintain the correct polarity.** For more information, refer to the owner's manual for your speakers.

◀ **Connecting External Speakers (Optional)**

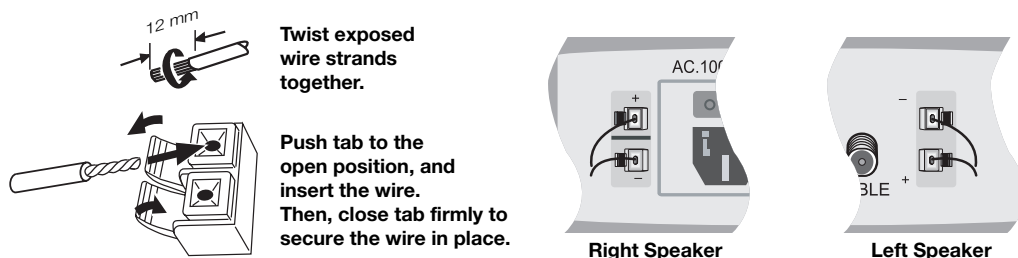

Figure 3-8. External Speaker Connection

If your home theater has a Dolby Digital amplifier or receiver, connect the digital audio output from the DView to the digital audio input of the amplifier/receiver as shown in Figure 3-9. The DView supports both coaxial (S/PDIF) and optical (TosLink) digital audio connections.

◀ **Connecting to a Dolby Digital Amplifier**



Note

The audio output level is fixed. (The volume and mute controls affect only the speaker and headphone outputs.)

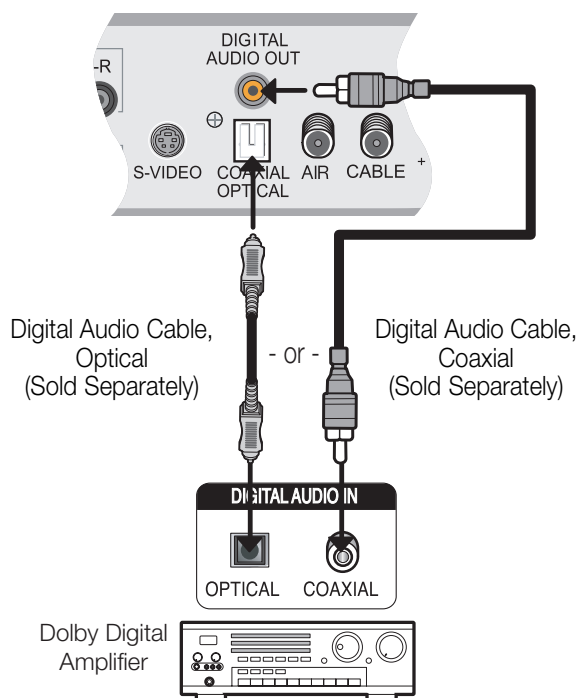

Figure 3-9. Digital Audio Connection

RS-232 Controller Connection ➤

Use a straight-through RS-232 cable with a 9-pin male connector to connect a PC or home theater control/automation system (if present) to the RS-232 port on the DView; see Figure 3-10.

For more information about using this connection, refer to **Serial Communications** on page 51.

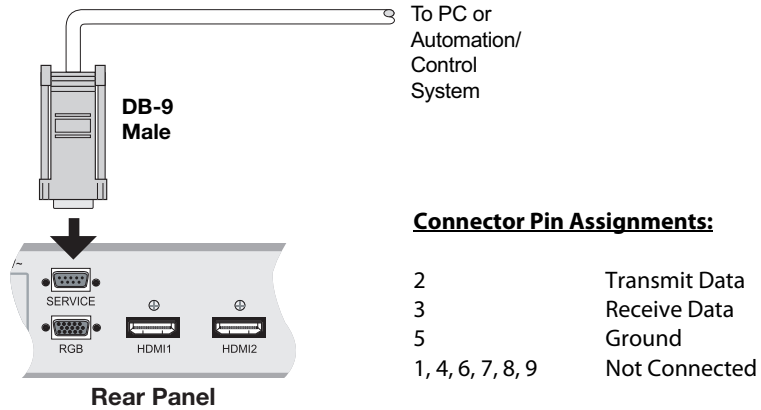
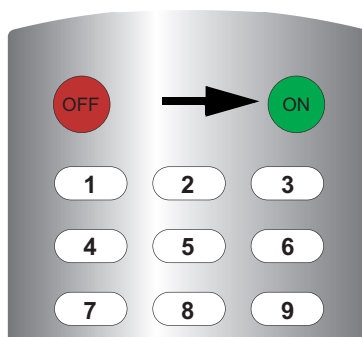

Figure 3-10. RS-232 Control System Connection

1. Turn on your source components.
2. Plug the female end of the supplied power cord into the AC receptacle on the rear of the DView (AC 100V ~ 240V). See Figure 2-2.
3. Connect the other end to your AC power source.
4. Turn on the main power switch at the rear of the display. The power indicator lights red to indicate that the DView is in "standby" mode.
5. Press the **ON** button on the remote control to turn on the display (or press the power button on the side of the display). The power indicator lights solid green.
6. After a brief warm-up period (approximately 10 seconds), the DView will display an image.



4.1 Turning on the Power

The DView OSD language is initially set to English, but can also display the menus in French, Spanish, Portuguese or German. To change the OSD language:

1. Press **MENU**.
2. Select **Setup** from the Main Menu.
3. Select **OSD Language** from the Setup Menu.
4. Press **▲** or **▼** to highlight the desired language and press **ENTER**. The change takes effect immediately.

4.2 Changing the OSD Language

4.3 Setting the PC Display Properties

To maximize image quality when using the DView with a personal computer, you may need to adjust the display properties of your PC video card. To do this:

1. Choose Settings from the Windows Start menu and click on "Control Panel."
2. Double click on the **Display** icon.
3. Click the **Settings** tab on the display dialog box.
4. Set the Screen area to 1920x1080 pixels.
5. Click the **Advanced** button and click the **Monitor** tab on the dialog box. Set the Refresh frequency to 60Hz and click **OK**.

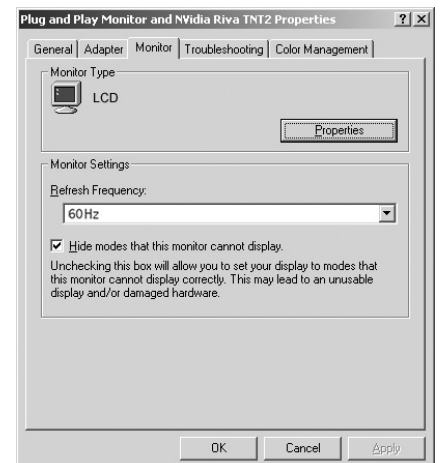
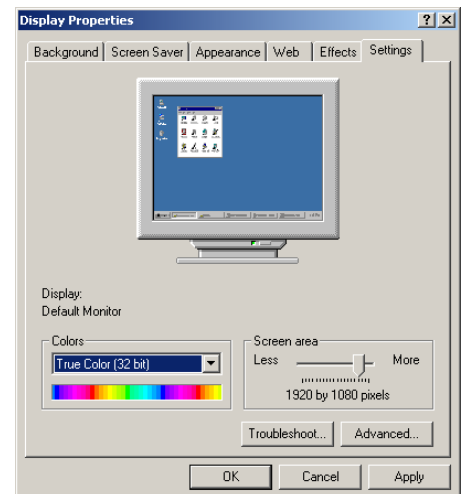
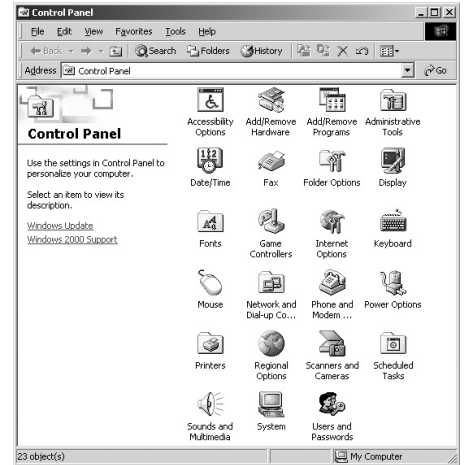

**Note**

1. The maximum available resolution and vertical frequency is 1920x1080/60Hz or the maximum supported by your video card, whichever is lower. You can get the best picture at 1920x1080/60Hz.
2. The DView supports 24-bit color (16,777,216 possible colors).

To use the on-screen menus:

1. Press **MENU** to display the Main Menu.
2. To select a menu item, use the up- or down-arrow buttons (▲, ▼) on the remote control to highlight it.
3. Press **ENTER** or the right-arrow button (▶) to access that menu.
4. Use the up- or down-arrow buttons (▲, ▼) to select the setting you want to change. Then, press **ENTER** or the right-arrow button (▶).
5. Press the right- or left-arrow button (◀, ▶) to change that setting.
6. To return to the previous menu, press **MENU** or (◀).

The DView OSD menus are arranged hierarchically, as shown in Figure 4-1. Depending on the selected input source and/or signal characteristics, some menu options may not be available.

4.4 Using the On-Screen Menus

Source	TV (VL-52 only)		
	Input1		
	Input2		
	Input3		
	Input4		
	RGB		
	HDMI1		
	HDMI2		
Aspect Ratio	16:9		
	4:3		
	Letterbox		
	IntelliWide		
Picture Adjust	Brightness	0, 1, 2, 3 ... 100	
	Contrast		
	Color		
	Tint		
	Sharpness	0, 5, 10, ... 100	
	DNR	0, 10, 20, ... 100	
	MPEG NR	0, 1, 2, 3 ... 63	
	Backlight	0, 5, 10, 15, 20, ... 100	
	Color Temp.	5400, 6500, 8500 or Custom	
	Gamma	2.00, 2.02, 2.04 ... 2.40	
	Save Settings	Custom	
Restore Settings	Custom, ISF Day, ISF Night		
Audio	Balance	L10, L9, L8 ... 0 ... R8, R9, R10	
	Equalizer	Standard, Music, Film, Speech or Custom	
	Surround	(On/Off)	
	Audio Language (VL-52 only)	English, Français, Español or Português	
	Digital Audio Out	PCM or Dolby Digital	
	TV Speaker	(On/Off)	
	Audio Delay	0, 1, 2 ... 40 msecs.	
Channel (VL-52 only)	Auto Tuning	STD	
		HRC	
		IRC	
		Return	
	Add/Erase		
Favorite Channel			
Timer (VL-52 only)	Time	12:00 AM - 11:59 PM or Auto Setup	
	On Timer	Enable/Disable, Time, Channel, Volume	
	Off Timer	Enable/Disable, Time	
	Sleep Timer	Off, 10, 30, 60, 120 or 180 minutes	
	Time Zone	Eastern, Central, Mountain, Pacific, Alaska or Hawaii	
	Daylight Saving	On / Off or Automatic	
Setup	OSD Language	English, Français, Español, Português or Deutsch	
	PC Mode Adjust	Auto Adjust	
		Clock	
		Phase	
		H. Position	
		V. Position	
		Factory Reset	
	Caption	Display	On / Off
		Digital (VL-52 only)	Service1, Service2, Service3 ... Service6
		Analog	CC1, CC2, CC3 or CC4 Text1, Text2, Text3 or Text4
		CC On Mute	Yes / No
		Digital Font Option (VL-52 only)	Control
			Font Size
			Font Style
			FG Color
			BG Color
			Edge Color
FG Opacity			
BG Opacity			
Edge Style			
Parental Control (VL-52 only)	Parental Lock (On/Off), TV Rating, Movie Rating, Unrated (Allow/Block), Change PIN (default is 0000)		
Letterbox Mode	Letterbox or Cinema Fill		
Input Selection	Input 1/Input 2	Automatic, Video or S-Video	
	Input 3/Input 4	Automatic, Video or Component	
Monitor Out	Main or PIP: Video		
Overscan (not available with PC signals)	H. Overscan, H. Shift, V. Overscan, V. Shift		
Input Label			
HDMI Audio	HDMI or PC		
RGB Signal	Video or PC		
Film Mode	Off, 2:3, 2:2 or Auto		
Auto Backlight	Off / On		
OSD Timer	0, 10, 20 ... 60 sec.		
Auto Off	0, 30, 60 or 120 min.		
ISF Calibration	Picture Adjust	Brightness	0, 1, 2, 3 ... 100
		Contrast	
		Color	
		Tint	
		Sharpness	0, 5, 10, ... 100
		ADC Phase Adj.	0, 1, 2, 3 ... 63
		DNR	0, 10, 20, ... 100
		MPEG NR	0, 1, 2, 3 ... 63
		Backlight	0, 5, 10, 15, 20, ... 100
		Color Temp.	5400, 6500, 8500 or Custom
		Gamma	2.00, 2.02, 2.04 ... 2.40
	Black Level	0, 1, 2, 3 ... 64	
	Save Settings	Custom, ISF Day, ISF Night	
	White Balance	R/G/B Gain	
		R/G/B Offset	
	Blue Enable	(Enable/Disable)	
	Baud Rate	115200, 19200, 9600 or 2400	
Serial Link	On / Off		
Factory Reset			
Splash Duration	0, 1, 2, 3, ... 60 secs.		

Figure 4-1. DView OSD Menu Structure

The Main Menu is the starting point for accessing all DView functions.
 (The ISF Calibration menu is not accessible until you enter a passcode.)

◀ **Main Menu**

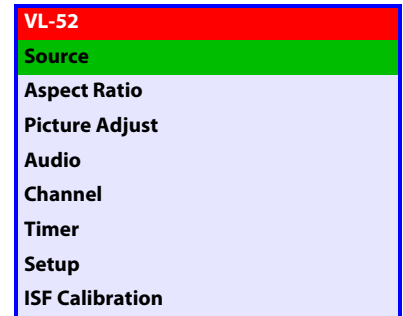

From the Main Menu, select Source to choose a video signal source.

The active source is indicated by an arrow (>) to its left; in the example at right, TV is the active source.

◀ **Source**

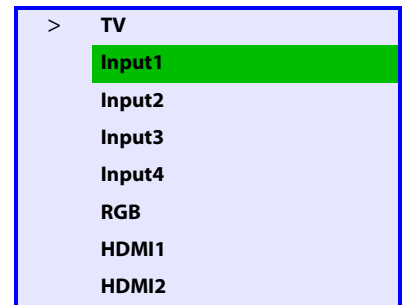

To change the aspect ratio (size and shape) of the projected image, select Aspect Ratio from the Main Menu and press **ENTER**. Select the appropriate aspect ratio for the type of program material being viewed; refer to Table 4-1.

The currently-selected aspect ratio is indicated by an arrow (>) to its left; in the example at right, Anamorphic is selected.

◀ **Aspect Ratio**

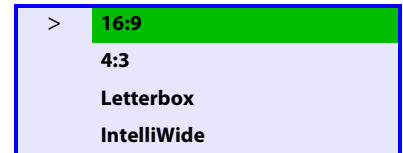

Note

The aspect ratio selection persists until you change it. (It is not saved independently for each input.)

Table 4-1. Aspect Ratio Settings

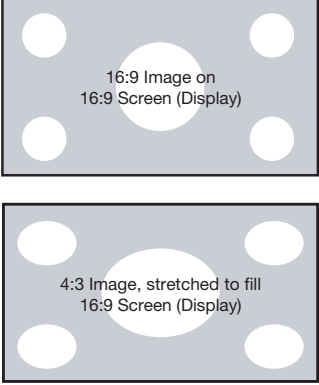
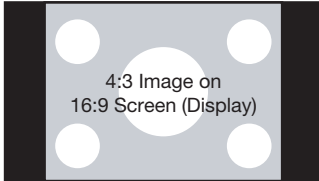
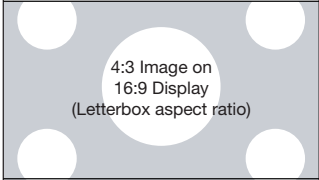
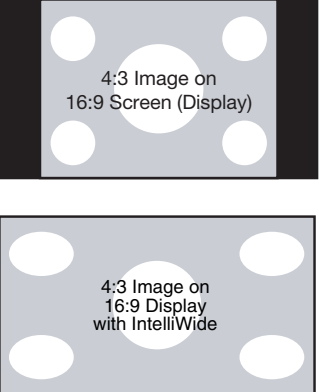
Aspect Ratio	Remote Control Key	Description	
16:9	ANA	 <p>16:9 Image on 16:9 Screen (Display)</p> <p>4:3 Image, stretched to fill 16:9 Screen (Display)</p>	<p>Select 16:9 to view 16:9 DVDs and HDTV programs in their native aspect ratio.</p> <p>4:3 images are stretched horizontally to fit a 16:9 display.</p>
4:3	4X3	 <p>4:3 Image on 16:9 Screen (Display)</p>	<p>4:3 scales the input signal to fit in the center of a 16:9 display. 4:3 is the aspect ratio used by computer monitors, standard television programming and most VHS video cassettes.</p>
Letterbox	LET BOX	 <p>4:3 Image on 16:9 Display (Letterbox aspect ratio)</p>	<p>Letterbox mode scales (zooms in on) a 4:3 image linearly (by the same amount on all sides) to fill a 16:9 display. Letterbox is best suited for viewing LaserDisc movies or non-anamorphic DVDs on a 16:9 screen.</p>
IntelliWide	I-WIDE	 <p>4:3 Image on 16:9 Screen (Display)</p> <p>4:3 Image on 16:9 Display with IntelliWide</p>	<p>IntelliWide scales a 4:3 image NON-linearly (more on the sides than in the center) to fit a 16:9 screen.</p>

Use the controls in the Picture Adjust menu to calibrate your DView for optimum picture quality.

The DView has been designed to incorporate setup and calibration standards established by the Imaging Science Foundation (ISF). The ISF has developed carefully crafted, industry-recognized standards for optimal video performance and has implemented a training program for technicians and installers to use these standards to obtain optimal picture quality from Vidikron video display devices. Accordingly, Vidikron recommends that setup and calibration be performed by an ISF-certified installation technician.

All signal types require separate processing. Therefore, you need to calibrate each input separately.



Note

*When you change a picture quality setting, save the change to a preset afterwards. Otherwise, the change will be lost when a different input is selected. (Picture quality settings are saved for each input and resolution separately.) For information about saving settings, refer to **Save Settings** on page 33.*

Although it may be possible to obtain satisfactory picture quality using the naked eye and regular program material, Vidikron recommends using the following calibration tools for best results:

- External test pattern source – Ovation Multimedia, Digital Video Essentials or AVIA test DVD or equivalent.
- A blue filter (provided with many test DVDs), for color level and tint adjustments.

Connect your test pattern source to the input that you are calibrating and proceed as follows. **Perform the adjustments in the order listed here.**

Brightness: On your external test pattern source, select a PLUGE pattern. (PLUGE is an acronym for “Picture Line-Up Generation Equipment.”) Figure 4-2 shows a typical PLUGE pattern.

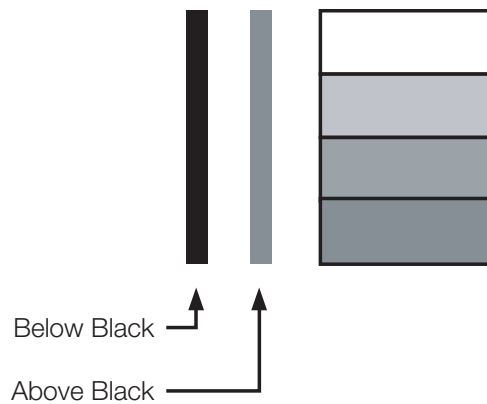

Figure 4-2. Typical PLUGE Pattern for Adjusting Brightness

◀ **Picture Adjust**

Picture Adjust
Brightness
Contrast
Color
Tint
Sharpness
DNR
MPEG NR
Backlight
Color Temp.
Gamma
Save Settings
Restore Settings

PLUGE patterns vary but generally consist of some combination of black, white and gray areas against a black background. The example above includes two vertical bars and four shaded boxes.

Select Brightness from the Picture Adjust menu. Using the left- and right-arrow (◀ ▶) buttons, adjust the brightness so that:

- The darkest black bars disappear into the background.
- The dark gray areas are barely visible.
- The lighter gray areas are clearly visible.
- The white areas are a comfortable level of true white.
- The image contains only black, gray and white (no color).

Contrast: On your external test pattern source, select a stepped, gray-bar pattern like the one shown in Figure 4-3.



Figure 4-3. Typical Gray Bar Pattern for Adjusting Contrast

Select Contrast from the Picture Adjust menu. Using the left- and right-arrow (◀ ▶) buttons, adjust the contrast to a point just below which the white rectangle starts to increase in size.



Note

Brightness and contrast controls are interactive. A change to one may require a subtle change to the other in order to achieve the optimum setting.

Color Saturation: On your external test pattern source, select a color bar pattern like the one shown in Figure 4-4.

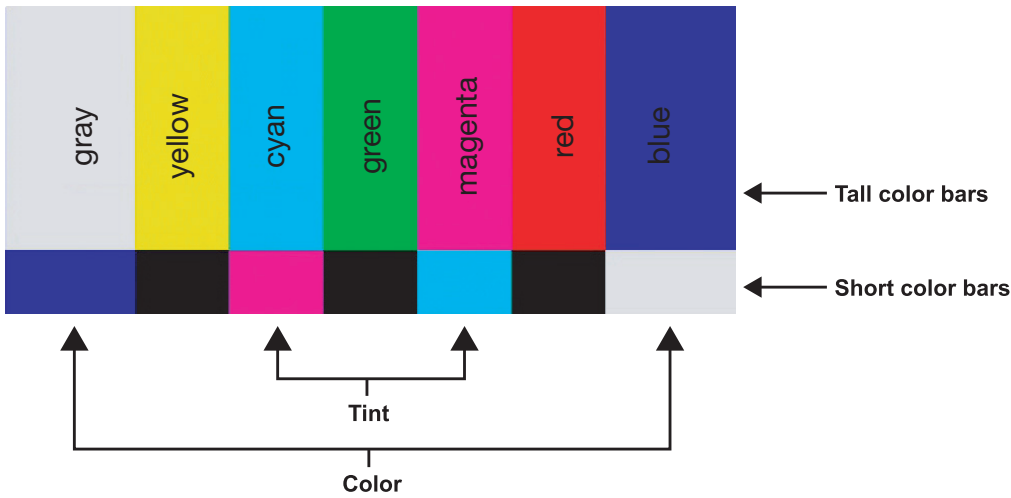
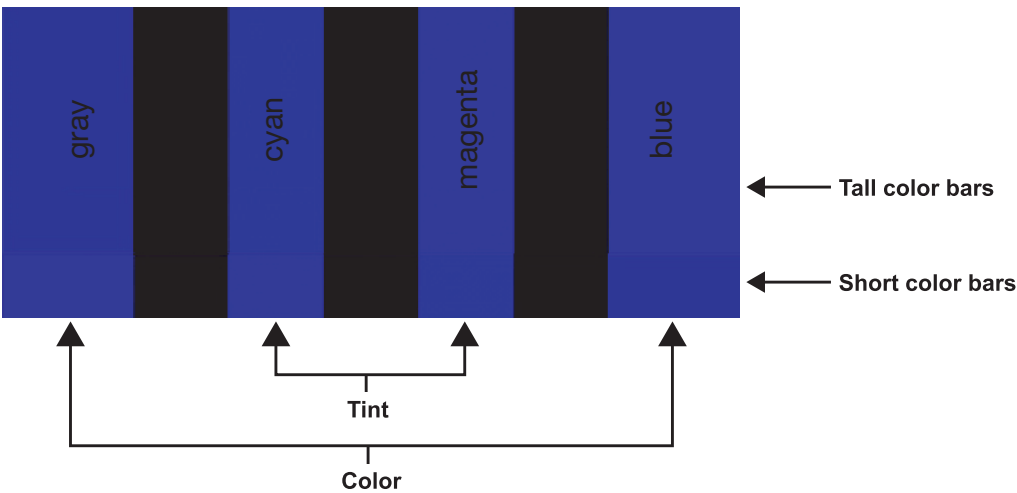

Figure 4-4. Typical Color Bar Pattern for Adjusting Color Saturation and Tint

Select Color from the Picture Adjust menu. While looking at the color bar pattern through a blue filter, adjust the color saturation level until the outermost (gray and blue) color bars appear to be a single shade of blue:



Tint: Tint or “hue” is essentially the ratio of red to green in the color portion of the image. When tint is decreased, the image appears redder; when it is increased the image appears greener. To set the tint, select Tint from the Picture Adjust menu. While looking at the color bar pattern through a blue filter, adjust the tint level until the cyan and magenta color bars (on either side of the green bar) appear to be a single shade of blue.



Note

Like the brightness and contrast controls, the color and tint controls are interactive. A change to one may require a subtle change to the other in order to achieve the optimum setting.

Sharpness: “Sharpness” is the amount of high-frequency detail in the image. To adjust sharpness, select Sharpness from the Picture Adjust menu and press **ENTER**. On your external test pattern source, select a pattern like the one shown in Figure 4-5. Adjust as needed, looking for white edges around the transitions from black to gray and different sized lines in the “sweep” patterns at the top and bottom. Lower the sharpness setting to eliminate them.

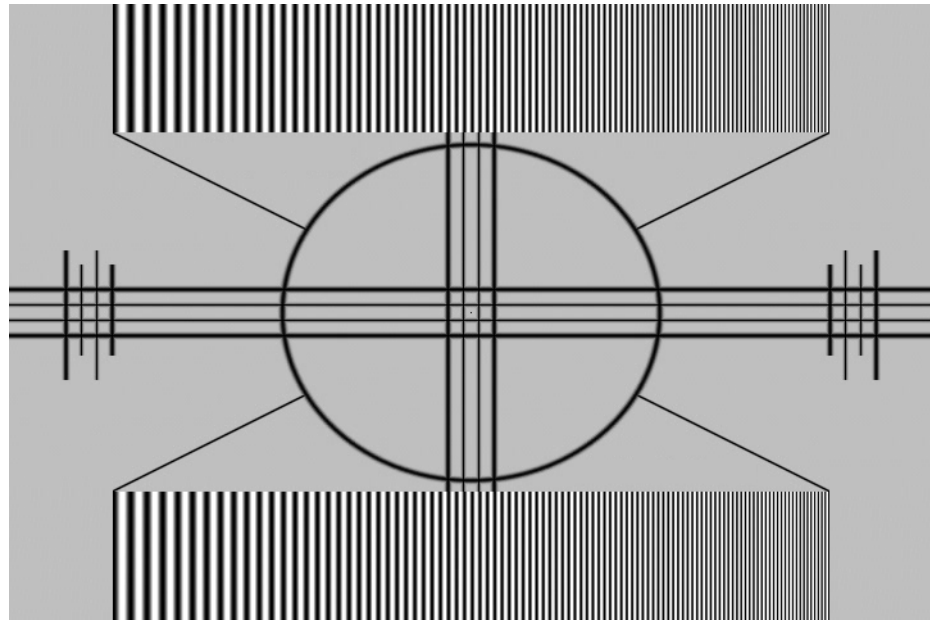

Figure 4-5. Typical Test Pattern for Adjusting Sharpness

DNR: To apply Digital Noise Reduction (DNR) to the input signal, select DNR from the Picture Adjust menu. Noise reduction is useful for clearing up noisy RGB images such as those from a PC. Adjust as desired using the left- or right-arrow buttons, keeping in mind that reducing noise (which reduces high frequencies) may also “soften” the image.

MPEG NR: Use the MPEG Filter to reduce or eliminate so-called “mosquito noise” in MPEG-compressed video signals (digital broadcasts or DVDs). Adjust as needed to minimize distortion around the edges of moving objects, moving artifacts around edges and/or blotchy noise patterns superimposed over the objects.

Backlight: The Backlight control changes the apparent brightness of the displayed image. Its effect is similar to that of a lamp intensity control on a projector.



Note

The Backlight control is disabled when Auto Backlight (described on page 39) is set to On.

Color Temperature: To choose a color temperature setting, select Color Temp. from the Picture Adjust menu and press **ENTER**. (Color temperature defines the “color of gray.”) The choices are 5400K, 6500K, 8500K and Custom. The default setting, 6500K, is appropriate for most situations. Higher settings produce a “bluer” picture; lower ones impart a reddish hue to the image.

Each color temperature setting has six (6) "white balance" parameters associated with it (two each for red, green and blue). These are described later in this section; refer to **White Balance** on page 41.

Gamma: The Gamma control determines how gray shades are displayed between minimum input (black) and maximum input (white) for all signals. A good gamma setting helps to optimize blacks and whites while ensuring smooth transitions for the "in-between" values utilized in other grays.

Unlike brightness and contrast controls, Gamma allows you to lighten or darken the overall tone of your images without changing the extremes. All images will be more vibrant while still showing good detail in dark areas.

The default Gamma setting of 2.20 is appropriate for most typical home theater environments.

Save Settings: The DView lets you save image quality settings for each input and supported resolution to a preset. You can recall this preset at a later time by simply pressing a button on the remote control or using the Restore Settings menu command (see below).

You should save changes to any of the following settings to a preset; otherwise they will be lost when a new input source or resolution is selected:

- Brightness
- Contrast
- Color saturation
- Tint
- Sharpness
- Gamma
- Color temperature selection (5400, 6500, 8500 or Custom)

Restore Settings: To recall a preset, choose Restore Settings from the Picture Adjust menu and select "Custom," "ISF Day" or "ISF Night." Or, use the corresponding buttons on the remote control.

To adjust the DView audio settings, select Audio from the Main Menu and press **ENTER**.

Balance: To adjust the left/right speaker balance, select Balance from the Audio Menu and press **ENTER**. Use the left- and/or right-arrow buttons to make one channel louder than the other.

Equalizer: The DView has a five-band graphic equalizer that you can use to boost or cut certain audio frequencies. To use it, select Equalizer from the Audio menu and press **ENTER**. Select one of four equalizer presets – Standard (flat), Music, Film or Speech – or select Custom to create your own according to taste. The five frequency bands are 100, 300, 1000, 3000 and 10,000 Hertz (Hz).

Surround: The DView has a "surround sound" mode that simulates a multi-channel sound system. To use the surround mode, select Surround from the Audio menu and set it to On.



Note

When Surround is set to On, the graphic equalizer is disabled.

◀ Audio

Audio
Balance
Equalizer
Surround
Audio Language (VL-52 only)
Digital Audio Out
TV Speaker
Audio Delay

Audio Language (VL-52 only): Some digital TV broadcasts provide audio soundtracks in multiple languages. If you are watching such a program, select Audio Language from the Audio menu to choose a soundtrack language: English, Français, Español or Português.

Digital Audio Out: The DView can output either two or six channels of digital audio. Select **Dolby Digital** if your A/V receiver can decode a Dolby Digital-encoded, 5.1-channel bitstream. Otherwise, select **PCM** to have the DView output PCM-encoded, stereo audio.

TV Speaker: To disable the speakers, select TV Speaker from the Audio menu, set it to Off and press **ENTER**. The effect is similar to using the **MUTE** button, except that the DView “remembers” this setting if you turn off the display, then turn it back on.

Audio Delay: Use the Audio Delay control to correct audio/video synchronization issues with DTV broadcasts. Select from 0 to 40 milliseconds of delay, as needed.

Channel (VL-52 only) ➤

Channel
Auto Tuning
Add/Erase
Favorite Channel

To set up the DView channel tuner, select TV as the source. Then, select Channel from the Main Menu and press **ENTER**.

Auto Tuning: To have the DView automatically detect available TV or CATV channels, select Auto Tuning and press **ENTER**. Then, select STD and press **ENTER** again.

The DView searches all channel frequencies and adds a channel to its memory when it detects a signal on that channel frequency. (This may take a few minutes.) If Auto Tuning fails to detect any CATV channels, select HRC or IRC and try again. (STD, HRC and IRC refer to different sets of frequencies used by cable television providers. IRC stands for “Incrementally Related Carrier;” HRC stands for “Harmonically Related Carrier.”)

Add/Erase: If Auto Tuning fails to detect a channel, select Add/Erase from the Channel menu and press ▲ or ▼ to select it. Then, select Add to add it to the channel list. To erase the currently-selected channel from the available channel list, select Add/Erase from the Channel menu, then select Erase.

Favorite Channel: You can specify up to five channels as “favorite” channels that can be accessed by pressing a single button on the remote, instead of manually entering the channel number. To do this, select Favorite Channel from the Channel menu and press **ENTER**.

Use the up- or down-arrow button to select the memory location in which you want to store the favorite channel. Then, use the left- or right-arrow button to specify the channel number.

To erase a favorite channel selection, press **ENTER**.

Press **EXIT** when you have finished programming favorite channels.

To recall a favorite channel, press the **FAV CHAN** button repeatedly on the remote control.

To set the DView's internal clock or configure the on/off timers, select Timer from the Main Menu and press **ENTER**.

Time: To set the DView internal clock, select Time from the Timer menu and press **ENTER**. Then, do either of the following:

- To synchronize the internal clock with time codes sent by the local Public Broadcasting Service (PBS) member station, select **Auto Setup**. The display must be connected to an off-air antenna or CATV system in order for this to work.
- To manually set the clock, use the up- or down-arrow button to select the hour of the day, AM/PM or the minute of the hour to set. Then, use the left- or right-arrow buttons to set that component of the time.

When finished, press **MENU** or **EXIT**.

On Timer: Use the On Timer to turn the DView on at a specific time of day. You can also specify a channel and a volume level.

Off Timer: Use the Off Timer to turn the DView off at a specific time of day.

Sleep Timer: Use the Sleep Timer to turn off the DView after a specified interval.

To set the Sleep Timer:

- Select Sleep Timer from the Timer menu and press **ENTER**. Use the right- or left-arrow button to select 10, 30, 60, 120 or 180 minutes. Then, press **MENU**.
- OR –
- Press the **TIMER OFF** button on the remote control repeatedly to select the desired timer interval.

Time Zone: To set the local (North American) time zone, select Time Zone from the Timer menu and press **ENTER**. Use the up- or down-arrow button to select Eastern, Central, Mountain, Pacific, Alaska or Hawaii. Press **ENTER** to confirm your selection.

Daylight Saving: If you are in a region that observes Daylight Saving Time (DST), select Daylight Saving from the Timer menu and set it to Automatic to have the DView automatically adjust the time (one hour ahead on the first Sunday in April; one hour back on the last Sunday in October). The display must be connected to an off-air antenna or CATV system in order for this to work.

You can also manually adjust the time to reflect DST. Set Daylight Saving to On if DST is currently in effect. Set it to Off if DST is not currently in effect or not observed in your region at all.

◀ **Timer (VL-52 only)**

Timer
Time
On Timer
Off Timer
Sleep Timer
Time Zone
Daylight Saving

Setup ➤

Setup
OSD Language
PC Mode Adjust
Caption
Parental Control (VL-52 only)
Letterbox Mode
Input Selection
Monitor Out
Overscan
Input Label
HDMI Audio
RGB Signal
Film Mode
Auto Backlight
OSD Timer
Auto Off

Use the controls in the Setup menu to perform advanced image quality adjustments and access various other DView features.

OSD Language: Select OSD Language from the Setup menu and press **ENTER**. Then, use the up- or down-arrow buttons to select the OSD language (English, French, Spanish, Portuguese or German). Press **ENTER** again to confirm your selection.

PC Mode Adjust: To improve the quality of displayed images from a computer or other VESA-compliant, RGB (480p or higher) source, select PC Mode Adjust and press **ENTER**.

- **Auto Adjust:** Auto Adjust automatically adjusts settings to optimize computer images. To execute Auto Adjust on command, select Auto Adjust and press **ENTER**.

**Note**

Auto Adjust may take some time to complete, depending on the characteristics of the incoming signal.

- **Clock:** Use the up- or down-arrow buttons (▲, ▼) to highlight Clock. Then, use the right-arrow button (▶) to increase the pixel clock rate; use the left-arrow button (◀) to decrease it.
- **Phase:** Adjust the phase if the image shows shimmer or “horizontal noise.” Pixel phase adjusts the phase of the pixel sampling clock relative to the incoming signal. The effect of this control is similar to that of a tracking control on a VCR.

For best results, use a good test pattern such as a smooth gray consisting of a clear pattern of black and white pixels, or a similar “half on, half off” graphic image. (You may notice that you can stabilize the image at more than one point. Use either setting in this case.)

- **H Position:** Use the up- or down-arrow buttons (▲, ▼) to highlight H Position. Then, use the right-arrow button (▶) to shift the image to the right; use the left-arrow button (◀) to shift the image to the left.
- **V Position:** Use the up- or down-arrow buttons (▲, ▼) to highlight V Position. Then, use the right-arrow button (▶) to shift the image up; use the left-arrow button (◀) to shift the image down.

To restore the factory-default Clock, Phase and Position settings, select Factory Reset and press **ENTER**.

Caption: Select Caption from the Setup menu to control the display of closed captions when watching programs that contain them.

- **Display:** Select On or Off to control the display of closed captions.
- **Digital (VL-52 only):** For digital TV broadcasts, select one of six captioning modes (Service1, Service2 ... Service6). Service1 usually contains the native-language captions; if a program is captioned in more than one language, those captions are carried on Service2 through Service6.
- **Analog:** Select one of four captioning modes: CC1, CC2, CC3 or CC4. CC1 usually contains the native-language captions; if a program is captioned in more than one language, those captions are carried on CC2, CC3 or CC4.

The DView also supports “text mode” captioning; to use this feature, select Text1, Text2, Text3 or Text4. The text modes, instead of displaying a few lines of captions somewhere on the picture, take over all or half of the screen to display scrolling text information. (The text modes are seldom used today, so most of the time there is no information there to see.) The text field is sometimes used for embedding Internet data (called Interactive TV Links, or ITV Links) in the captions.

- **CC On Mute:** To have the DView show captions when the audio output is muted, set this option to Yes.
- **Digital Font Option (VL-52 only):** Select Digital Font Option (VL-52 only) from the Caption menu to customize the appearance of closed captions in digital TV broadcasts.
 - **Control:** Select Program to view the closed captions as presented by the broadcaster. Or, select User to override the program’s closed caption formatting.
 - **Font Size/Font Style:** These settings alter the size and typeface of closed captions.
 - **FG Color/BG Color/Edge Color:** These settings alter the text color, background color and text border color respectively.
 - **FG Opacity/BG Opacity:** These settings alter the degree to which the program “shows through” the captions.
 - **Edge Style:** This setting alters the text border style.

Parental Control (VL-52 only): To block the display of television programs or movies based on their ratings, select Parental Control from the Setup menu and press **ENTER**. Enter the default Personal Identification Number (PIN) – **0000** – and press **ENTER** again.

- **Parental Lock:** This is the “master switch” for the parental controls. Set it to On or Off.
- **TV Rating:** Select TV Rating from the Parental Control menu to block television programs carrying a given rating, to prevent children from watching programs that are deemed inappropriate. These ratings and content labels have been established by the United States Federal Communications Commission (FCC) to help parents and other caregivers determine if a program is suitable for young viewers.

To block programs carrying a given rating, use the up- or down-arrow to select a rating. Then, press the right-arrow button to require the PIN code to be entered to view a program with that rating. A lock icon  appears to indicate that the restriction is active.

Table 4-2 describes the TV ratings and content categories. For more information, visit http://www.fcc.gov/parents/parent_guide.html.

Table 4-2. FCC Ratings and Content Categories

Rating/Category	Description
TV-MA	Mature Audience Only - graphic violence, explicit sexual content and/or offensive language
TV-14	Parents strongly cautioned - intense violence, sexual situations, coarse language and/or suggestive dialogue
TV-PG	Parental guidance suggested - violence, sexual situations, coarse language and/or suggestive dialogue
TV-G	General audience – suitable for children and adults
TV-Y7	Children 7 and up
TV-Y	Suitable for all children
FV	Fantasy violence or cartoon violence
D	Sexual dialogue
L	Offensive language
S	Sexual content
V	Violence

- **Movie Rating:** Select Movie Rating from the Parental Control menu to block movies carrying a given rating, to prevent children from watching movies that are deemed inappropriate. These ratings have been established by the Motion Picture Association of America (MPAA) to help parents and other caregivers determine if a movie is suitable for young viewers.

To block movies carrying a given rating, press the right-arrow button to require the PIN code to be entered to view a movie with that rating. A lock icon (🔒) appears to indicate that the restriction is active.

For more information on movie ratings, please visit <http://www.mpa.org/movieratings/>.

- **Unrated:** To allow or block access to unrated content, select Unrated from the Parental Control menu and select Allow or Block. Press **ENTER** to confirm your choice.
- **Change PIN:** The default PIN for accessing the parental controls or bypassing content restrictions is **0000**. Vidikron recommends changing this to something less obvious.

Letterbox Mode: Select Letterbox Mode from the Setup menu to change the zoom factor that takes effect when you select the Letterbox aspect ratio (refer to Table 4-1).

When you select Letterbox, the image is enlarged (zoomed in) by a factor of approximately 1.33.

When you select Cinema Fill, the zoom factor is approximately 1.77 (1.33 x 1.33).

Letterbox Mode = Letterbox

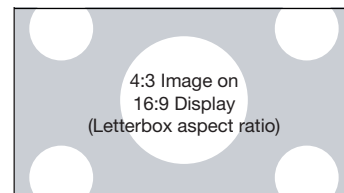

Letterbox Mode = Cinema Fill

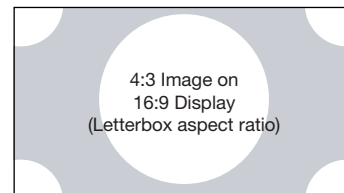

Input Selection: Input 1 and Input 2 have both S-Video and Composite video connectors. Input 3 and Input 4 have both Component and Composite video connectors. To specify which connection type you are using – or to switch from one to the other if equipment is connected to both – select Input Selection from the Setup menu and press **ENTER**.

The default setting for all four AV inputs is **Automatic**. With this setting, the DView searches for an active source on both connectors and displays the first one it detects. If equipment is connected to both, Automatic input selection triggers a switch when a source component is disconnected or powered off.

Monitor Out: If you have equipment connected to the AV OUT, select Monitor Out from the Setup menu to route either the main or PIP audio/video signals to that output.

Overscan (not available with PC signals): Overscan pushes the outside edge of the active picture area of the video signal out beyond the edge of the display area.

Some television programs are produced based on the assumption that older television sets may not display the outer edges of the broadcast picture area. Overscan effectively trims away these inactive, outer edges and enlarges the remaining portion of the image to fill the display area.

Use the on-screen slidebars to set the desired amount of horizontal and vertical overscan, as well as horizontal and vertical image shift.

These settings only affect 480i source material. For HDTV, DVDs and other video sources, Overscan is generally not necessary or desirable.

Input Label: You can give each DView input a descriptive name. To do this, select Input Label from the Setup menu and choose one from the list.

HDMI Audio: If the HDMI source is a PC or other device that does not support audio output via HDMI, set HDMI Audio to PC.

If the source does support audio output via HDMI, set this option to HDMI to route the HDMI (digital) audio signal to the speakers when HDMI1 or HDMI2 is selected.

RGB Signal: The RGB input supports both DTV and VESA (computer) resolutions and signal timings. If the RGB source is a computer, select PC. If it is a DTV set-top box or other equipment with an RGB output, select Video.

Film Mode: To smooth out moving images from interlaced, standard-definition (SD) sources, select Film Mode and set it to Automatic.

In most cases, the DView detects the proper "pull-down" rate and vertical frequency. However, if your source is jittery and/or tearing you may wish to specify the pull-down rate (2:2 or 3:2) to ensure stable processing for that source.

Auto Backlight: Select Auto Backlight from the Setup menu and set it to On to have the DView adjust the Backlight setting automatically, according to the ambient light level in the viewing area.

OSD Timer: Use the ◀ or ▶ button to set the OSD Timer. This timer controls how long the menus remain on-screen after selecting them. Select from 0 to 60 seconds, in 10-second increments. When you set the OSD to 0, the menus remain on-screen until you hide them by pressing **EXIT**.

Auto Off: Set **Auto Off** to 30, 60 or 120 minutes to have the DView go into standby mode when no source signal is present for the selected amount of time.

When **Auto Off** is set to zero (0) minutes (disabled), the DView remains in normal operating mode, regardless of the presence or absence of an input sync signal.

ISF Calibration ➤

ISF Calibration
Picture Adjust
White Balance
Blue Enable
Baud Rate
Factory Reset
Splash Duration

Use the ISF Calibration menu to perform advanced picture quality adjustments. **This menu should be used by ISF-certified technicians only.**

**Note**

You must enter a passcode to access the ISF Calibration menu.

Picture Adjust: The controls in this menu are identical to those in the main Picture Adjust menu, but are accessible only by entering the ISF Calibration menu passcode. This makes it possible to restore the picture quality settings to what they were when the DView was installed, simply by recalling the "ISF Night" or "ISF Day" preset.

- **Brightness:** Refer to **Brightness** on page 29.
- **Contrast:** Refer to **Contrast** on page 30.
- **Color:** Refer to **Color Saturation** on page 31.
- **Tint:** Refer to **Tint** on page 31.
- **Sharpness:** Refer to **Sharpness** on page 32.
- **ADC Phase Adj.:** This control works similarly to the Phase adjustment for RGB signals (refer to **Phase** on page 36). Use it to improve the apparent sharpness of 720p and lower-resolution Component, S-Video or Composite sources. For best results, adjust ADC Phase while displaying a "Sharpness" pattern (Figure 4-5).
- **DNR:** Refer to **DNR** on page 32.
- **MPEG NR:** Refer to **MPEG NR** on page 32.
- **Backlight:** Refer to **Backlight** on page 32.
- **Color Temp.:** To choose a color temperature setting, select Color Temp. from the Picture Adjust menu and press **ENTER**. (Color temperature defines the "color of gray.") The choices are 5400K, 6500K, 8500K and Custom. The default setting, 6500K, is appropriate for most situations. Higher settings produce a "bluer" picture; lower ones impart a reddish hue to the image.

Each color temperature setting has six (6) "white balance" parameters associated with it (two each for red, green and blue). (The White Balance settings for the 5400K, 6500K and 8500K color temperatures are factory-set and cannot be changed.)

**Tip**

*To create a "Custom" color temperature, select Custom from the Color Temp. menu and press **ENTER**. Then, press **ENTER** a second time to go directly to the White Balance menu. (This shortcut is available only from the ISF Calibration menu.)*

- **Gamma:** Refer to **Gamma** on page 33.
- **Black Level:** This control compensates for incoming elevated black levels present in certain video signals. The default setting (32) results in a minimum black level of approximately 0 IRE. Adjust as needed to match the dynamic range of the source; increase the value if blacks appear elevated (dark gray). If blacks appear "crushed" (too dark), use a lower setting.

- **Save Settings:** For each input and supported resolution, the DView lets you save image quality settings as presets that you can recall at a later time. You can create up to three presets – designated “Custom,” “ISF Day” and “ISF Night” – per input and resolution.

You should save changes to any of the following settings to a preset; otherwise they will be lost when a new input source or resolution is selected:

- Brightness
- Contrast
- Color saturation
- Tint
- Sharpness
- Gamma
- Color temperature selection (5400, 6500, 8500 or Custom)

To save image settings to a preset, select Save Settings from the Picture Adjust menu and select “Custom,” “ISF Day” or “ISF Night.”

White Balance: To remove any trace of color from the white areas of the displayed image, set the Color Temp. to Custom. Then, choose White Balance from the ISF Calibration menu and press **ENTER**.

- **Gain:** Use the Gain controls to correct color imbalances in the bright areas of the image. A good way to do this is to use a test pattern consisting mostly of solid white areas, such as an 80 IRE “window” pattern. If the white areas contain traces of red, green or blue, decrease the Gain for that color.
- **Offset:** Use the Offset controls in the White Balance sub-menu to correct color imbalances in the dark areas of the image. A good way to do this is to use a test pattern consisting mostly of dark gray areas, such as a 30 IRE “window” pattern. If the gray areas contain traces of red, green or blue, decrease the Offset for that color.

White Balance	
R Gain	100
G Gain	100
B Gain	100
R Offset	50
G Offset	50
B Offset	50



Note

*Any white balance adjustments you make here are automatically stored as a “Custom” color temperature. The White Balance settings for the 5400K, 6500K and 8500K color temperatures are factory-set and cannot be changed. **Always set the Color Temp. to Custom before making any white balance adjustments, so you can see how those adjustments affect the image.***

Blue Enable: Blue Enable removes all red and green color information from the image, simulating a blue filter. You can use it instead of a blue filter when performing color and tint adjustments.

Baud Rate: Select Baud Rate from the ISF Calibration menu to set the data transfer rate of the DView’s RS-232 SERVICE port. (This setting must match the data rate of the device connected to the RS-232 input.)

Serial Link: Select Serial Link from the ISF Calibration menu to configure the RS-232 Service port (see Figure 3-10) for normal operation (On) or for software upgrades (Off).

Factory Reset: To reset all DView settings to their factory defaults, select Factory Reset from the ISF Calibration menu and press **ENTER**. **This command is not undoable. Use it with caution!**

Splash Duration: Use Splash Duration to control how long the DView splash screen remains on-screen after power-up; see Figure 4-6. To prevent this screen from appearing, set the Splash Duration to 0.

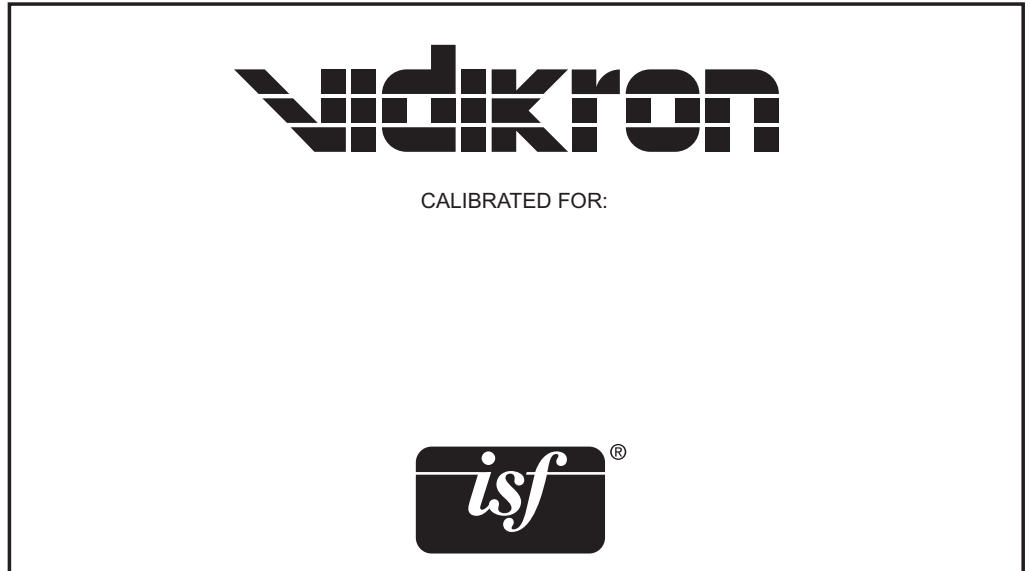
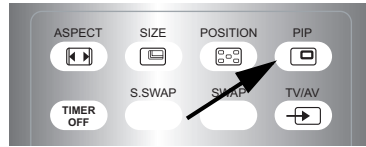

Figure 4-6. DView Splash Screen

To use PIP, press the **PIP** () button.



4.5 Using Picture-In-Picture (PIP)

The PIP window appears inside the main image window.

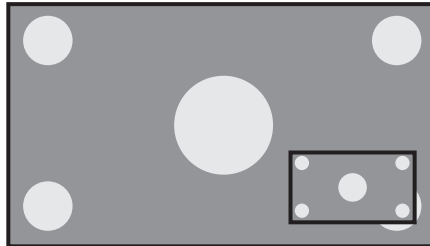

Press **PIP** again to switch to side-by-side PIP mode.

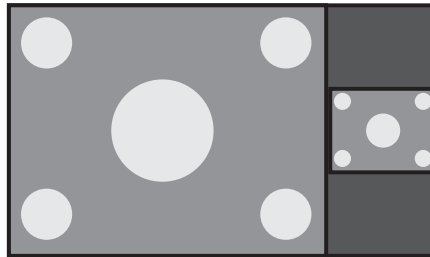

Press **PIP** again to turn PIP off.



Press the **TV/AV** button () to select a PIP signal source. For each source, Table 4-3 shows which of the other sources are available as a PIP source.

Table 4-3. Available Main and PIP Source Combinations

		PIP Input Source										
		TV	INPUT 1	INPUT 2	INPUT3		INPUT4		RGB	HDMI1	HDMI2	
					VIDEO	COMP	VIDEO	COMP				
Main Input Source	TV	-	✓	✓	✓	✓	✓	✓	✓	✓	✓	
	INPUT1	✓	-	✓	✓	✓	✓	✓	✓	✓	✓	
	INPUT2	✓	✓	-	✓	✓	✓	✓	✓	✓	✓	
	INPUT3	VIDEO	✓	✓	✓	-	-	✓	✓	✓	✓	✓
		COMP.	✓	✓	✓	-	-	✓	✓	✓	✓	✓
	INPUT4	VIDEO	✓	✓	✓	✓	✓	-	-	✓	✓	✓
		COMP.	✓	✓	✓	✓	✓	-	-	✓	✓	✓
	RGB	✓	✓	✓	✓	✓	✓	✓	-	-	-	
	HDMI1	✓	✓	✓	✓	✓	✓	✓	-	-	-	
	HDMI2	✓	✓	✓	✓	✓	✓	✓	-	-	-	

Notes:

1. "✓" means that that source is available as a PIP source when that input is selected; "-" means that it is not.
2. The DView cannot display the same source in both the main and PIP windows, nor can it display RGB and HDMI (digital) signals simultaneously.

To change the PIP window position, press the **POSITION** () button on the remote control repeatedly until the window is in the desired position.

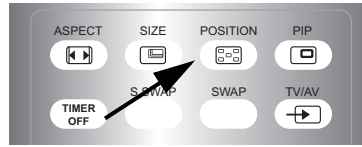
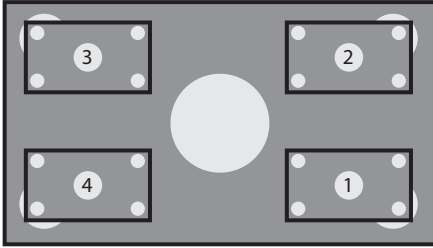

◀ **Changing the PIP Position**

To change the PIP window size, press the **SIZE** () button on the remote control repeatedly to achieve the desired window size.

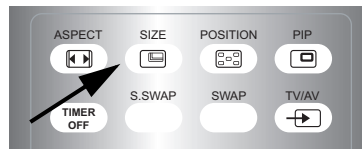
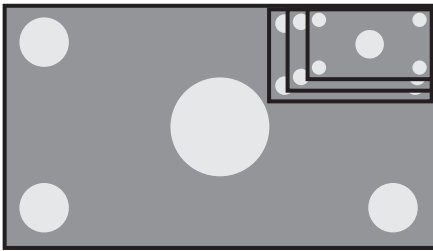

◀ **Changing the PIP Size**

To change the aspect ratio of the PIP window from 4:3 to 16:9 or vice versa, press the **ASPECT** () button on the remote control.

Refer to Table 4-1 for more information about aspect ratios.

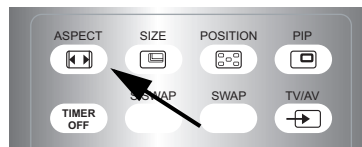

◀ **Changing the PIP Aspect Ratio**

Swapping the Main and PIP Images

➤ To swap the main and PIP images, press the **SWAP** button on the remote control.

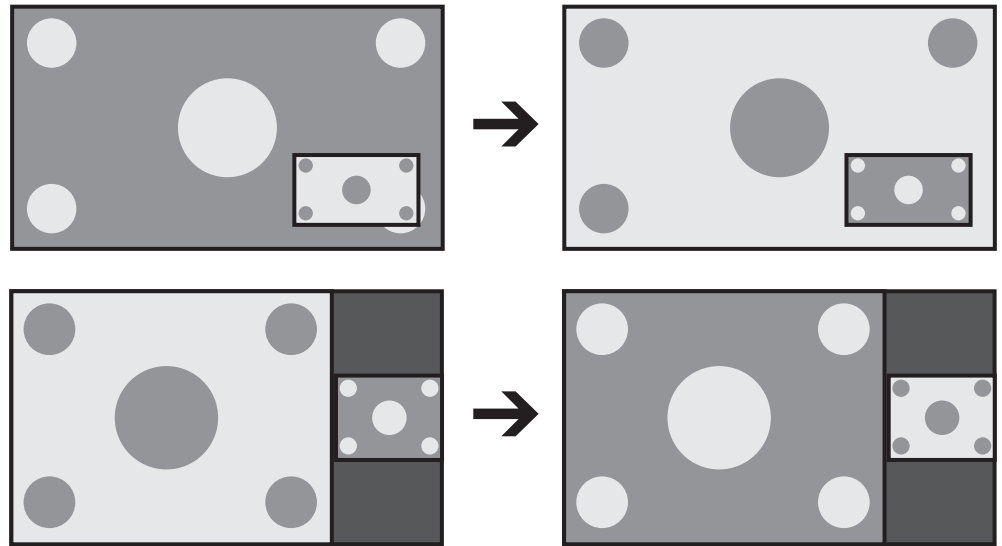
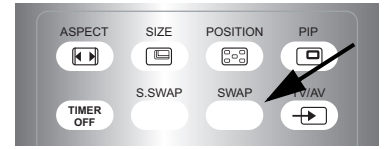

Swapping the Main and PIP Audio Programs

➤ To swap the main and PIP audio programs, press the **S.SWAP** button on the remote control.

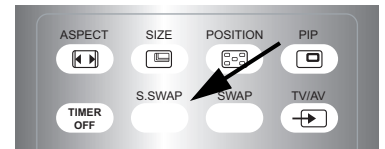

The DView supports Multichannel Television Sound (MTS), the broadcast audio standard that allows transmission of both stereo and Secondary Audio Program (SAP) content.

The SAP is usually a foreign-language translation. However, it can also be used for other purposes such as Described Video Services (DVS), which provide descriptive narration of key visual elements in programs for the benefit of the visually impaired.

You can select sound options (Mono, Stereo, SAP or Mono+SAP) depending on the broadcast signal by pressing the **MTS/SAP** button on the remote control.

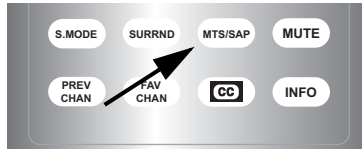

- Choose Stereo for channels that are broadcasting in stereo.
- Choose Mono for channels that are broadcasting in mono, or if you are having difficulty receiving a stereo signal.
- Choose SAP to listen to the Secondary Audio Program.
- Choose **Mono+SAP** to listen to both the primary and secondary audio programs (for example, when a program has a DVS audio track).

Table 4-4 summarizes the audio broadcast modes supported by the DView.

Table 4-4. Compatibility with Stereo and SAP Audio Broadcasts

Broadcast Mode	Receive Mode			
	Mono	Stereo	SAP	Mono+SAP
Mono	Mono	Mono	Mono	Mono
Stereo	Mono	Stereo	Mono	Stereo
Mono+SAP	Mono	Mono	SAP	Mono+SAP
Stereo+SAP	Mono	Stereo	SAP	Mono+SAP

4.6 Stereo Sound/SAP (VL-52 only)

Notes:

Maintenance and Troubleshooting

Regular cleaning will extend the life and performance of the DView. Before cleaning, be sure to unplug the power cord from the power outlet.

Do not under any circumstances use solvents such as benzene or thinner to clean the DView. Doing so may cause deterioration or peeling of paint from the display or remote control unit.

Wipe the display and remote control gently with a soft cloth. In case of excessive dirt buildup, dampen a soft cloth with a diluted neutral cleaning detergent. Wring the cloth thoroughly, then wipe the component and dry it with a dry soft cloth.

After dusting, wipe the screen gently using a soft cloth (cotton, flannel etc.). Do not use tissue or coarse fabric. The screen surface is easily scratched; do not rub it or hit it with a hard object.

If you clean the surface of the screen with a wet cloth, do not allow water droplets on the surface to enter into the product; this may cause a malfunction.

As a general rule, use a vacuum cleaner about once a month to clean the vents on the rear panel of the display of dust buildup (set the vacuum cleaner to its weakest setting when doing this). If not removed, accumulated dust can cause the internal temperature to increase, resulting in possible breakdown or fire.

Table 5-1 provides some general guidelines for troubleshooting problems you may encounter with the DView. If the suggested solutions fail to resolve the problem or if you encounter an issue not described here, please contact your Vidikron dealer or Vidikron Technical Support.

Table 5-1. Troubleshooting Chart

Symptom	Possible Cause(s)	Solution
The display does not turn on after initial installation.	<ul style="list-style-type: none">The DView is not plugged in or the AC outlet is not active.The remote control batteries have run out.	<ul style="list-style-type: none">Ensure that the DView is plugged in and that the AC outlet is active.Replace the batteries.
The display is on, but there is no picture.	<ul style="list-style-type: none">Incorrect source selection.Source component is not turned on.Source component is connected incorrectly or not at all.	<ul style="list-style-type: none">Select the correct source.Turn on the source component.Check video connections to source component.

5.1 Cleaning

◀ *Cleaning the Display Panel Body and Remote Control*

◀ *Cleaning the Screen*

◀ *Cleaning the Vents*

5.2 Troubleshooting Tips

Table 5-1. Troubleshooting Chart (continued)

Symptom	Possible Cause(s)	Solution
Picture is okay, but there is no sound.	<ul style="list-style-type: none"> • Audio output is muted. • Volume setting is too low. • Source component is connected incorrectly or not at all. • Speakers are connected incorrectly or not at all. • Audio settings are incorrect. 	<ul style="list-style-type: none"> • Press the MUTE button on the remote control. • Turn up the volume. • Check audio connections to source component. • Check speaker connections (Figure 3-8). • Check the following settings: Digital Audio Out (page 34), TV Speaker (page 34) and HDMI Audio (page 39).
Image is too bright and/or lacks definition in the bright areas of the image.	<ul style="list-style-type: none"> • Contrast is set too high. 	<ul style="list-style-type: none"> • Lower the contrast setting.
Image appears "washed out" and/or dark areas appear too bright.	<ul style="list-style-type: none"> • Brightness is set too high. 	<ul style="list-style-type: none"> • Lower the brightness setting.
Black or white dots appear on all channels or a specific channel.	<ul style="list-style-type: none"> • Antenna or cable TV source is connected incorrectly or not at all. • Broadcast signal is weak. 	<ul style="list-style-type: none"> • Check the antenna or cable TV connection. • If using an off-air antenna, adjust its position or location.
Colors in the image are swapped; for example, reds appear blue or vice versa.	<ul style="list-style-type: none"> • The Red/Pr, Green/Y or Blue/Pb outputs from the source are connected to the wrong inputs on the DView. 	<ul style="list-style-type: none"> • Ensure that the source outputs are connected to the correct DView input.
RGB-HD images appear "noisy."	<ul style="list-style-type: none"> • Clock and Phase settings need adjustment. 	<ul style="list-style-type: none"> • Manually adjust Clock and Phase settings, or perform an Auto-Adjust (refer to PC Mode Adjust on page 36).
"Invalid mode" appears on-screen.	<ul style="list-style-type: none"> • The resolution and frequency of the video card in the computer are not compatible with the DView. 	<ul style="list-style-type: none"> • Select a compatible resolution and vertical frequency (refer to Computer Signal Compatibility on page 61).
The image is too large or too small.	<ul style="list-style-type: none"> • Image size needs adjusting. 	<ul style="list-style-type: none"> • Adjust the image size (refer to PC Mode Adjust on page 36).
Poor broadcast sound quality.	<ul style="list-style-type: none"> • The sound quality of a stereo broadcast may be unstable in an area with a weak signal. 	<ul style="list-style-type: none"> • Use the MTS/SAP button on the remote control to select mono.

Serial Communications

To interface the DView with a home theater automation/control system or a PC running terminal emulation software, connect it to your control system or PC as shown in Figure 3-10. (Use a straight-through cable.)

Configure the RS-232 controller or PC serial port as follows: no parity, 8 data bits, 1 stop bit and no flow control. Set the baud rate to match that of the DView RS-232 port. To check the baud rate setting, select Baud Rate from the ISF Calibration menu (refer to page 41).

- Commands are in ASCII format and are not case-sensitive.
- A carriage return is not required after a command.
- When you send a valid command, the DView executes it and acknowledges it with a right-bracket character (]) followed by the four-digit numeric code you sent; for example,] 0002.
- When you send an invalid command (one followed by values outside the valid range for that command), the DView ignores it and returns >MAX or <MIN instead of the four-digit code.
- When you send an unrecognized/misspelled command, the DView ignores it and returns -N/A instead of the four-digit code.

Table 6-1 lists the RS-232 command set.

Table 6-1. Serial Commands

Command			Description
[S3A	0###	Set audio volume to ### (= 000-100)
<i>Example:</i> [S3A0075 sets volume to 75			
[+3A		Audio volume up
[-3A		Audio volume down
[S3E	000#	Audio mute (speakers/headphones) 0 = not muted, 1 = muted
<i>Example:</i> [S3E0001 mutes the audio output			
[S4A	000#	Main input selection 0 = TV 1 = Input1 2 = Input2 3 = Input3 4 = Input4 6 = RGB 8 = HDMI1 9 = HDMI2
<i>Example:</i> [S4A0006 selects RGB			
[+4A		Select "next" Main AV input

6.1 RS-232 Connection and Port Configuration

6.2 Serial Command Syntax

Table 6-1. Serial Commands

Command			Description
[S4E	000#	Aspect ratio selection 0 = 4:3 (Standard) 1 = IntelliWide 2 = Letterbox 3 = 16:9 (Anamorphic)
<i>Example:</i> [S4E0002 selects Letterbox			
[S4G	000#	PIP Input selection 0 = TV 1 = Input1 2 = Input2 3 = Input3 4 = Input4 6 = RGB 8 = HDMI1 9 = HDMI2
<i>Example:</i> [S4G0003 selects PIP Input3			
[+4G		Select "next" PIP AV input
[SAB	000#	Power on/off control 0 = standby, 1 = on
<i>Example:</i> [SAB0001 turns unit on			
[SCA	000#	Caption on/off 0 = off 1 = on
<i>Example:</i> [SCA0000 turns caption off			
[SCB	00##	Set major channel (AIR); ## = 01 - 99
<i>Example:</i> [SCB0002 selects off-air channel 2			
[SCB	1###	Set major channel (CABLE); ### = 001 - 125
<i>Example:</i> [SCB1102 selects cable channel 102			
[SCD	####	Set minor channel; #### = 0000 - 9999 <i>(Note: You must send a "Set major channel" command first.)</i>
<i>Example:</i> [SCD0001 selects minor channel 1			
[+CB		TV channel up
[-CB		TV channel down
[SDA	000#	Set PIP mode 0 = OFF 1 = PIP 2 = PBP
<i>Example:</i> [SDA0002 selects PBP			

Table 6-1. Serial Commands

Command			Description
[SDB	000#	Set PIP size 0 = small 1 = medium 2 = large
<i>Example:</i> [SDB0001 selects medium PIP size			
[SDE	000#	Set PIP aspect ratio 0 = 4:3 1 = 16:9
<i>Example:</i> [SDE0001 selects 16:9 aspect ratio PIP window			
[SDF	000#	Set PIP window position 0 = Top/Left 1 = Top/Right 2 = Bottom/Left 3 = Bottom/Right
<i>Example:</i> [SDF0001 positions PIP window in upper-right corner of display area			
<p>The following serial commands are meant to emulate buttons on the remote control. Each button has its own serial command, so effectively it is as if you were using the IR remote only you'll be doing so via serial commands. These commands provide active OSD responses just like the IR remote.</p> <p>Each command begins with [key followed by the four-digit number of the button. No carriage return is necessary. The response you receive from the unit if the command is valid will be a right-bracket (]) followed by the four-digit numeric code you sent. (For example, the 'ON' command is [key0015; the response will be])0015). All commands are in ASCII.</p>			
[key	0002	OFF
		0015	ON
[key	0004	Number 1
		0005	Number 2
		0006	Number 3
		0008	Number 4
		0009	Number 5
		0010	Number 6
		0012	Number 7
		0013	Number 8
		0014	Number 9
		0035	Number "--"
		0017	Number 0
		0023	TV
[key	0105	INPUT1

Table 6-1. Serial Commands

Command			Description
		0027	INPUT2
		0028	INPUT3
		0001	INPUT4
		0102	HDMI1
		0101	HDMI2
		0019	RGB HD
[key	0003	CUSTOM
		0062	ISF NIGHT
		0031	ISF DAY
[key	0040	16:9 (ANA)
		0043	4:3
		0039	LETTERBOX
		0126	INTELLIWIDE
[key	0007	Right-Arrow key
		0016	Down-Arrow key
		0018	Up-Arrow key
		0011	Left-Arrow key
		0046	ENTER
[key	0026	MENU
[key	0100	EXIT
[key	0063	PIP ASPECT RATIO
		0047	PIP SIZE
		0034	PIP POSITION
		0032	PIP
		0037	TIMER OFF
		0052	S.SWAP
		0033	SWAP
		0036	TV/AV
[key	0053	S.MODE
		0054	SURROUND

Table 6-1. Serial Commands

Command		Description	
		0024	MTS/SAP
		0091	MUTE
[key	0057	PREVIOUS CHANNEL
		0045	FAVORITE CHANNEL
		0044	CLOSED CAPTION (on/off)
		0055	INFO

Notes:

Specifications

Table 7-1 lists the DView specifications.

7.1 DView Specifications

Table 7-1. DView Specifications

Native Resolution:	1920 x 1080
Screen Size:	VL-52 = 52 in. (diagonal) VL-57 = 57 in. (diagonal)
Screen Aspect Ratio:	16:9
Available Aspect Ratios:	4:3, Letterbox, 16:9, IntelliWide™
DTV Compatibility:	480i/p, 576i/p, 720p, 1080i, 1080p
ISF Settings:	Yes
Contrast Ratio:	VL-52 = 2000:1 VL-57 = 1200:1
Data/Graphics Compatibility:	Refer to Table 7-2
Imagix Processing:	3:2 or 2:2 pull down
Inputs:	Multiple input combinations with up to (4) Composite Video (2) S-Video (2) Component Video (2) HDMI w/HDCP (1) RGB (15-pin D-sub) (1) RS-232 Control (5) Analog Audio (4 stereo RCA pairs + 3.5-mm stereo mini jack) (1) RF Antenna (VL-52 only) (1) CATV (75-ohm coaxial) (VL-52 only)
Outputs:	(1) Composite Video (1) Analog Audio (stereo RCA pair) (1) Stereo headphone (3.5-mm stereo mini jack) (1) Digital Audio (S/PDIF, RCA coaxial) (1) Digital Audio (TosLink optical)
Audio System:	10W RMS x 2 Stereo Amplifier
Tuner (VL-52 only):	NTSC/ATSC Stereo (PAL as monitor only), HDTV, PIP/PBP, Parental Control (V-Chip), Closed Caption
Discrete IR Control:	Source, power and aspect ratios
Power Requirements:	100 to 240 VAC, 50/60Hz
Power Consumption:	VL-52 = 350 watts VL-57 = 400 watts
Operating Environment:	40°F to 95°F (5°C to 35°C); 20% to 80% humidity (non-condensing)
Dimensions:	VL-52 = see Figure 7-1 VL-57 = see Figure 7-2

Table 7-1. DView Specifications (continued)

Weight (including stand):	VL-52 = 89.5 lbs. (40.60 kg) VL-57 = 118.0 lbs. (53.52 kg)
Regulatory Approvals:	Complies with FCC, CE, C-Tick, NRTL, GOST, MIC, SABS, RoHS, China RoHS
Limited Warranty:	One (1) year parts and labor from the date of delivery to the end user.

Specifications are subject to change without notice.

Figure 7-1 and Figure 7-2 show the DView dimensions (all dimensions are in inches).

7.2 DView Dimensions

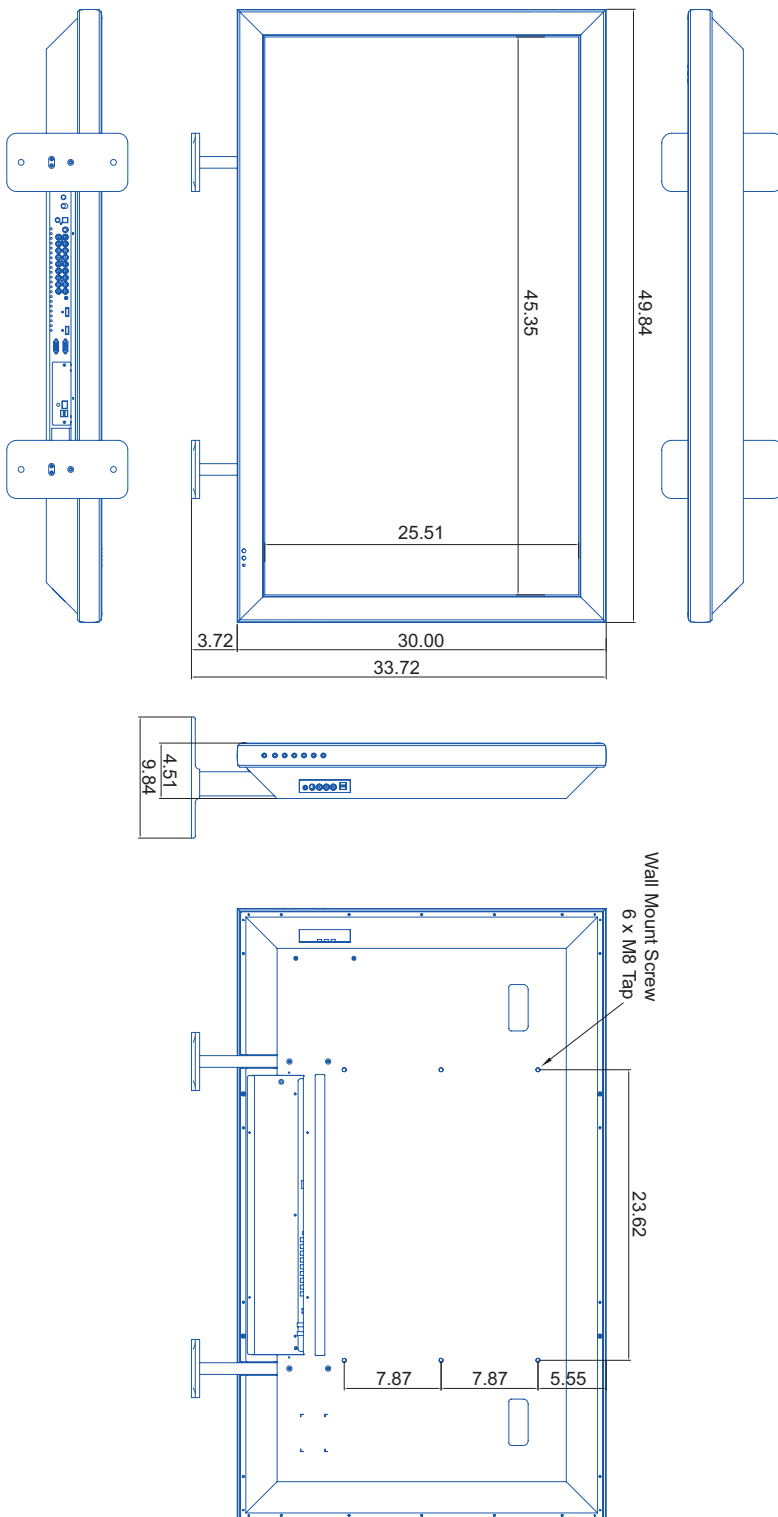

Figure 7-1. VL-52 Dimensions

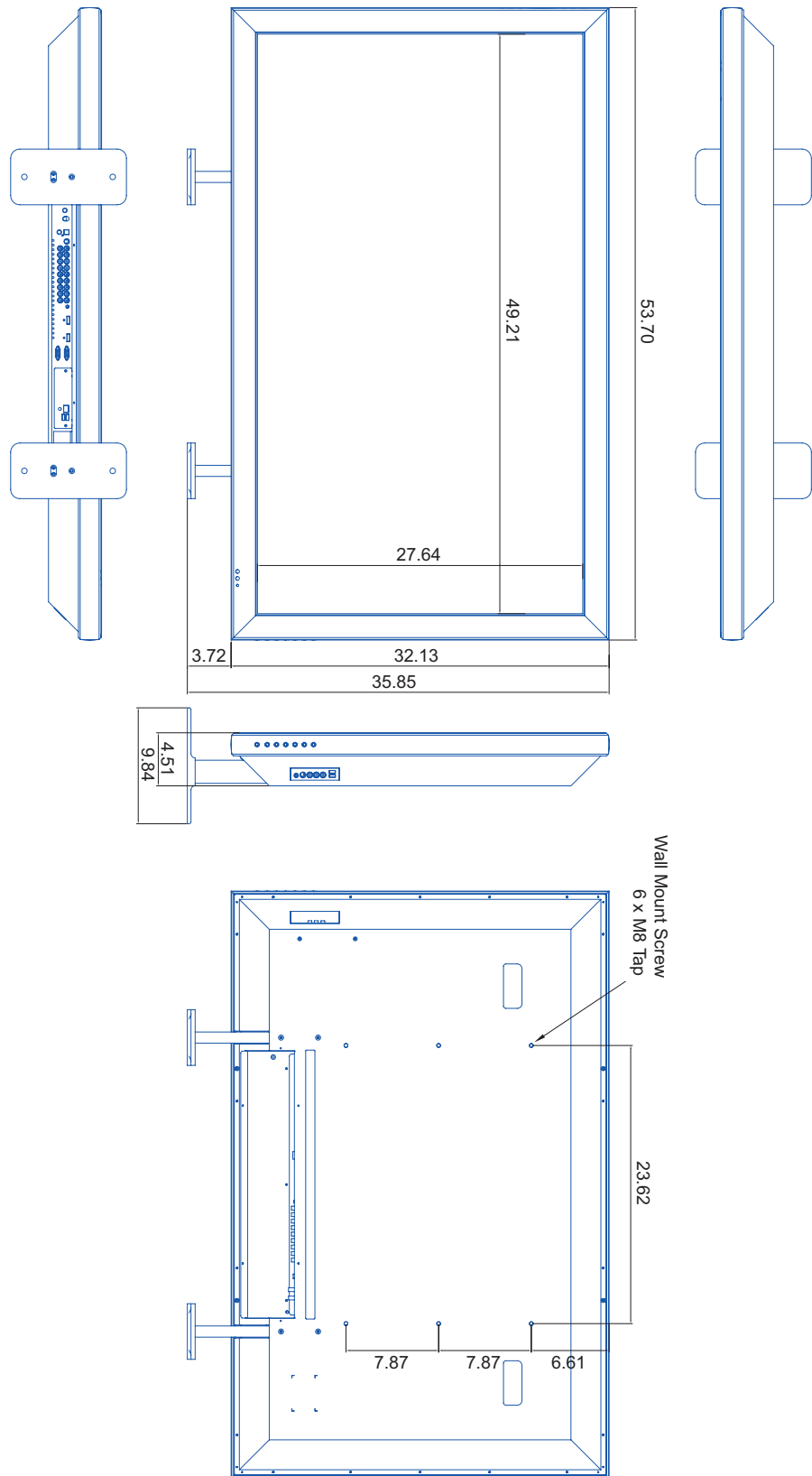

Figure 7-2. VL-57 Dimensions

The DView can display video signals from a variety of computer sources via its RGB-HD and HDMI inputs.

Table 7-2 lists the signal types that are compatible with the DView, and indicates which of those are VESA standards.

Table 7-2. Computer/Video Signal Compatibility Chart

Signal Type	Mode		Vertical Frequency (Hz)	Horizontal Frequency (kHz)	RGB	HDMI
VESA	640x350	85	85.00	31.28	✓	–
VESA	640x400	85	85.00	35.78	✓	–
VESA	640x480	60	60.00	29.82	✓	✓
MAC	640x480	67	66.70	35.00	✓	✓
MAC	640x480	72	72.80	37.90	✓	✓
MAC	640x480	75	75.00	37.50	✓	✓
VESA	800x600	56	56.00	35.20	✓	✓
VESA	800x600	60	60.30	37.90	✓	✓
VESA	800x600	72	72.20	48.70	✓	✓
VESA	800x600	75	75.00	46.90	✓	✓
VESA	1024x768	60	60.00	48.40	✓	✓
VESA	1024x768	70	70.10	56.50	✓	✓
VESA	1024x768	75	75.00	60.00	✓	✓
VESA	1280x768	60	60.00	47.70	✓	–
VESA	1280x1024	75	75.00	80.17	✓	✓
VESA	1600x1200	60	60.00	74.52	✓	✓
VESA	1920x1080	60	60.00	67.50	✓	✓

Note: The DView may not be able to display images from notebook computers in simultaneous (CRT/LCD) mode. Should this occur, switch the notebook computer to "CRT only" mode. If you are unsure how to do this, refer to your notebook computer's user manual.

7.3 Computer Signal Compatibility

Notes:

020-0714-00 Rev. A
October 2007



Vidikron
2900 Faber Street
Union City, CA 94587
510-324-5900
Fax 510-324-5905
1-888-4-VIDIKRON
www.vidikron.com



SERIAL NUMBER

Free Manuals Download Website

<http://myh66.com>

<http://usermanuals.us>

<http://www.somanuals.com>

<http://www.4manuals.cc>

<http://www.manual-lib.com>

<http://www.404manual.com>

<http://www.luxmanual.com>

<http://aubethermostatmanual.com>

Golf course search by state

<http://golfingnear.com>

Email search by domain

<http://emailbydomain.com>

Auto manuals search

<http://auto.somanuals.com>

TV manuals search

<http://tv.somanuals.com>