

MAJESTIC **VERMONT** *Castings*



Electric Fireplace **Model** ***DEF33CE***

Installation Instructions & Homeowner's Manual

WARNING! IF THE INFORMATION IN THIS MANUAL IS NOT FOLLOWED EXACTLY, AN ELECTRICAL SHOCK OR FIRE MAY RESULT CAUSING PROPERTY DAMAGE, PERSONAL INJURY OR LOSS OF LIFE.



FOR YOUR SAFETY

**DO NOT STORE OR USE GASOLINE OR OTHER
FLAMMABLE VAPOURS AND LIQUIDS IN THE
VICINITY OF THIS OR ANY OTHER APPLIANCE.**



The Vermont Castings,
Majestic Products Company

410 Admiral Blvd. • Mississauga, Ontario • Canada L5T 2N6
www.vermontcastings.com • www.majesticproducts.com



INSTALLER: DO NOT DISCARD THIS MANUAL - LEAVE FOR HOMEOWNER

10003014
11/00 Rev. 0

TABLE OF CONTENTS

Please read the Installation & Operating Instructions before using this appliance.

Thank you and congratulations on your purchase of a Majestic fireplace.

IMPORTANT: Read all instructions and warnings carefully before starting installation. Failure to follow these instructions may result in a possible electric shock, fire hazard and/or injury and will void the warranty.

Installation Instructions	3
General Information	3
Locating your Fireplace	3
Fireplace Dimensions	4
Electrical Specifications	4
Mantels	5
Clearance to Combustibles	5
Framing & Finishing	5
Final Finishing	5
Hearth	5
Cabinet Installation	6
Electrical Connection	6
Installation of Logs	6
Service Instructions	7
Louvre Removal	7
Glass Frame Removal	7
Glass Information	7
Replacing Light Bulbs	7
Maintenance of Motors	8
Cleaning Brass Trim	8
Electrical Diagram	8
Operating Instructions	9
On/Off Switch	9
Heater Control	9
Log Illumination Control	9
Flame Speed Control	9
Control Panel	9
Replacement Parts Pictorial	10
Replacement Parts List	11
Options	12

INSTALLATION INSTRUCTIONS

GENERAL

1. Read all instructions before using this appliance.
2. This appliance is hot when in use. To avoid burns, do not let bare skin touch hot surfaces. If provided, use handles when moving this appliance. Keep combustible materials, such as furniture, pillows, bedding, papers, clothes and curtains at least 3 feet (1m) from the front of this appliance.
3. **CAUTION: Extreme caution is necessary when any heater is used by or near children or invalids and whenever the heater is left operating and unattended.**
4. If possible, always unplug this appliance when not in use.
5. Do not operate any heater with a damaged cord or plug or after the appliance malfunctions, or if it has been dropped or damaged in any manner.
6. Any repairs to this fireplace should be carried out by a qualified service person.
7. Under no circumstances should this fireplace be modified. Parts having to be removed for servicing must be replaced prior to operating this fireplace again.
8. Do not use outdoors.
9. This heater is not intended for use in bathrooms, laundry areas and similar indoor locations. Never locate this appliance where it may fall into a bathtub or other water container.
10. Do not run cord under carpeting. Do not cover cord with throw rugs, runners or the like. Arrange cord away from traffic areas and where it will not be tripped over.
11. To disconnect this appliance, turn controls to the off position, then remove plug from outlet.
12. Connect to properly grounded outlets only.
13. This appliance, when installed must be electrically grounded in accordance with local codes.
14. Do not insert or allow foreign objects to enter any ventilation or exhaust opening as this may cause an electric shock or fire, or damage the appliance.
15. To prevent a possible fire, do not block air intakes or exhaust in any manner. Do not use on soft surfaces, like a bed, where openings may become blocked.
16. This appliance has hot and arcing or sparking parts inside. Do not use it in areas where gasoline, paint or flammable liquids are used or stored. This fireplace should not be used as a drying rack for clothing, nor should Christmas stockings or decorations be hung in the area of it.
17. Use this appliance only as described in this manual. Any other use not recommended by the manufacturer may cause fire, electric shock or injury to persons.
18. Avoid the use of an extension cord because the extension cord may overheat and cause a risk of fire. However, if you have to use an extension cord, the cord shall be No. 16 AWG minimum size and rated not less than 2500 Watts. The extension cord must be a three wire cord with grounding type plug and cord connection.
19. This appliance must not be located immediately below a socket-outlet.
20. **SAVE THESE INSTRUCTIONS.**

LOCATING YOUR MAJESTIC ELECTRIC FIREPLACE

Your new fireplace may be installed into an existing masonry or zero clearance fireplace. It may also be installed using a prefabricated cabinet available from your dealer or be built into a wall.

When choosing a location for your new fireplace, ensure that the general instructions are followed. Also, for best effect install the fireplace out of direct sunlight.

FIREPLACE DIMENSIONS

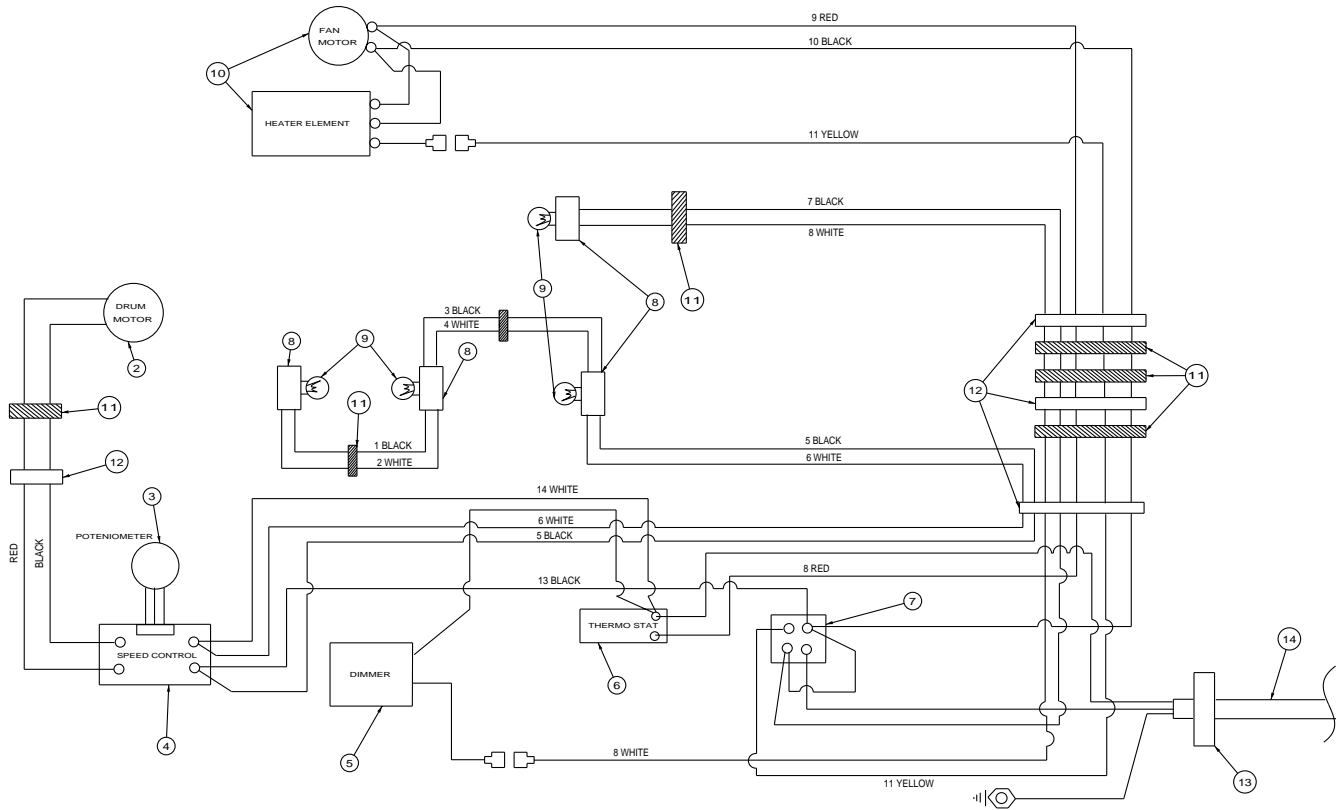

A	33"	838mm
B	28 ⁷ / ₈ "	733mm
C	16 ³ / ₈ "	416mm
D	31"	787mm
E	17"	430mm
F	11 ¹ / ₂ "	292mm
G	3"	76mm
M	36"	914mm
N	51"	1295mm
O	25 ¹ / ₂ "	648mm
ROD	12"	305mm
ROW	33 ¹ / ₂ "	851mm
ROH	29 ⁵ / ₈ "	752mm

ELECTRICAL SPECIFICATIONS

Voltage: 240VAC, 50Hz
 Total Amps: 9.5 Amps
 Total Watts: 2250 Watts
 Heater Rating: 2000 Watts

Fig. 1

MANTELS

Depending on the width of the mantel it may be installed higher or lower from the top of the louvre opening. See drawing and chart below for proper installation height of your combustible mantel piece. Non-combustible mantels may be installed at any height above the appliance opening.



When using paint or lacquer to finish the mantel, such paint or lacquer must be heat resistant to prevent discolouration.

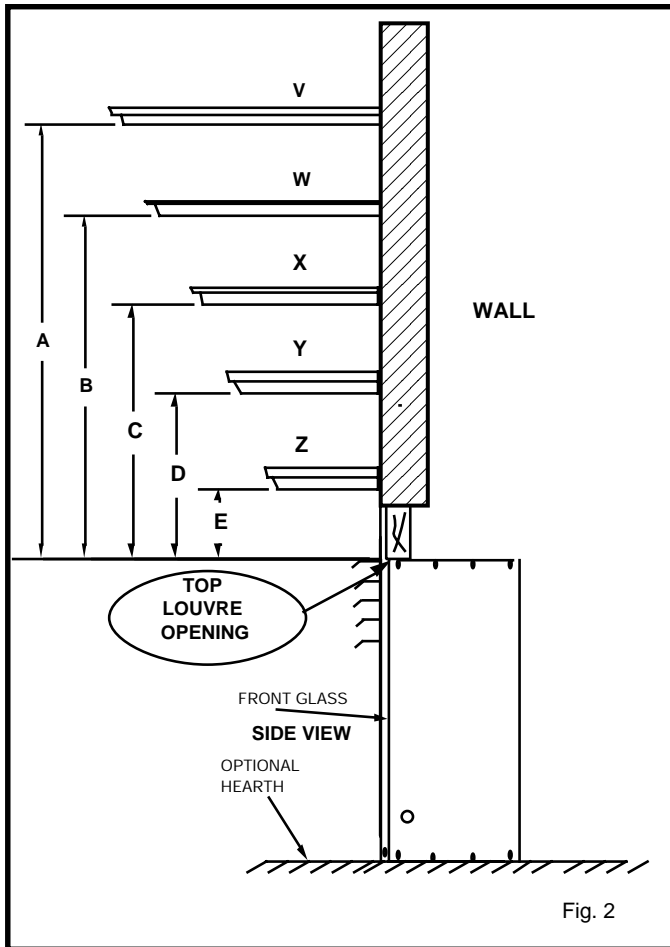

MANTEL CHART

Ref.	Mantel & Leg Depth (Maximum)	Ref.	Mantel From Top Louvre (Minimum)	Mantel Leg from Fireplace Side (Minimum)
V	10" (254 mm)	A	12" (305 mm)	10" (254mm)
W	8" (203 mm)	B	10" (254 mm)	8" (203mm)
X	6" (152 mm)	C	8" (203 mm)	6" (152mm)
Y	4" (101 mm)	D	6" (152 mm)	4" (101mm)
Z	2" (51 mm)	E	4" (101 mm)	2" (51mm)

CLEARANCE TO COMBUSTIBLES

Sides 0 mm/0 inches
 Sides 0mm/0 inches
 Floor 0 mm/0 inches
 Top 0 mm/0 inches

FRAMING AND FINISHING

1. Choose fireplace location.
2. Place fireplace into position.
3. Frame in fireplace with a header across the top. It is important to allow for finished face when setting the depth of the frame.

FINAL FINISHING

Non-combustible materials such as brick and tile can be extended over the face of the unit (**Do not cover louvres or glass door**). If a Trim Kit is going to be installed, brick and tile will have to be installed flush with the side of this appliance.

HEARTH

A hearth is not mandatory but it is recommended for aesthetic purposes. We recommend a non-combustible hearth which does not obstruct louvre opening.



Cold climate installation recommendation:
When installing this unit against a non-insulated exterior wall or chase, it is mandatory that the outer walls be insulated to conform to applicable insulation codes.

CABINET INSTALLATIONS

Cabinets are available from your dealer which allow for fast, convenient installation of your fireplace against existing walls.

ELECTRICAL CONNECTION

A 15 AMP, 240 Volt, 50 Hz circuit with a properly grounded outlet is required. Preferably, the fireplace will be on a dedicated circuit as other appliances on the same circuit may cause the circuit breaker to trip or the fuse to blow when the heater is in operation. The unit comes standard with a 7 ft. (2134 mm) long three wire cord, exiting the right side of the fireplace. Plan the installation to avoid the use of an extension cord. If an extension cord must be used, it must be a minimum 16AWG, three wire with grounding type plug and connector and rated not less than 2500 Watts.

A new electrical outlet can be installed inside the frame construction, if permitted by local codes.



Electrical outlet wiring must comply with local building codes and other applicable regulations to reduce the risk of fire, electrical shock and injury to persons.



Do not use this fireplace if any part of it has been under water. Immediately call a qualified service technician to inspect the fireplace and replace any part of the electrical system which has been under water.

Hard (Direct) Wire Connection

If desired, a qualified electrician may remove the cord connection and wire this unit directly to the household wiring.



Any electrical re-wiring of this appliance must be done by a qualified electrician.



WARNING: Safe use plug must be accessible after installation.



WARNING: This appliance is fitted with a non-rewireable plug. If it's necessary to change the fuse in a plug. The fuse cover must be refitted. If the fuse cover is lost or damaged, the plug must not be used until it is replaced. It is important that the colour of the replacement fuse cover corresponds with the colour markings on the base of the plug. An ASTA approved BS1362 fuse rated at 13A should be used.

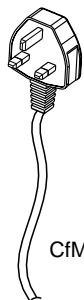

CfM125

INSTALLATION OF LOGS

1. Turn off power to the unit.
2. Remove front glass (See "Glass Removal" section).
3. Remove logs from packaging.
4. The ember bed is shipped in place. No adjustment is necessary.
5. Install rear left log (A15). Use notches to have a proper location.
6. Install rear right log (A16). Use notches to have a proper location.
7. Install front left log (A13). Use notches to have a proper location.
8. Install front right log (A14). Use notches to have a proper location.

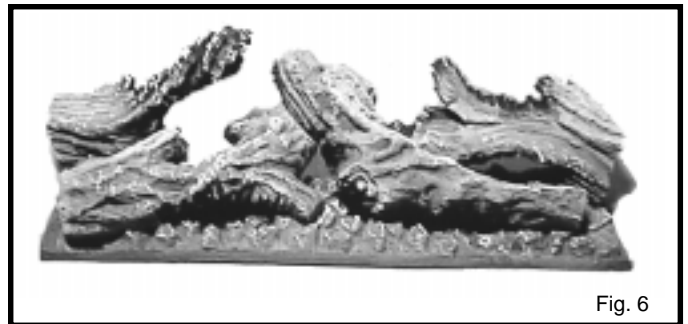

Fig. 6

SERVICE INSTRUCTIONS



Disconnect power before attempting any maintenance or cleaning to reduce the risk of fire, electrical shock or personal injury.

LOUVRE REMOVAL

To remove top louvre pull louvre up and then lift out. See Figure 7.

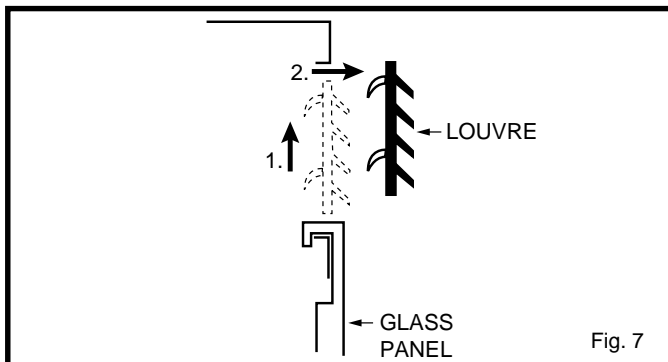

GLASS FRAME REMOVAL

1. Turn off electrical supply to unit.
2. Let fireplace cool if it has been operating.
3. Remove top louvre. (See Louvre Removal).
4. Open lower louvre assembly.
5. Remove two door retention screws along lower edge of door frame.
6. Swing lower portion of door out from the fireplace and gently lift up to disengage top of door from fireplace. See Fig. 8.
7. To reinstall glass door, follow the above procedure in reverse.

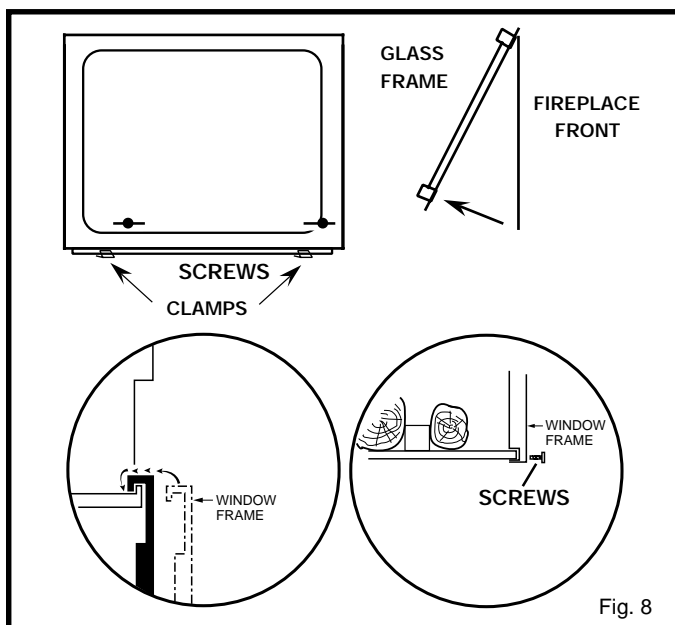

GLASS INFORMATION

1. Under no circumstances should this product be operated with missing or broken glass.
2. Do not strike or slam the glass.
3. Do not use abrasive cleaners to clean the glass.
4. This product uses tempered glass. Replacement of the glass with gasket as supplied by the manufacturer should be done by a qualified service person.

REPLACING LIGHT BULBS

This fireplace uses four clear 240 Volt, 50 Hz, 60 Watts, E-14 socket base light bulbs (chandelier candle type). Three of the lights are located under the ember bed of the unit. The fourth light is found at the top of the firebox above the log set. For convenience, if one of the bulbs burns out, it may be a good idea to replace all of the light bulbs.



Do not exceed 60 Watts per bulb. Use of higher rated bulbs may result in a fire, causing property damage, personal injury or loss of life.

1. Turn off power to the unit.
2. Let fireplace cool if it has been operating.
3. Remove top louvre. (See Louvre Removal).
4. Remove glass door. (See Glass Frame Removal).
5. Gently remove log set.
6. Remove the two screws securing the ember bed in position. One screw is located on either side of the ember bed near the front.
7. Examine the bulbs to determine which bulbs need to be replaced.
8. While holding the socket, unscrew the defective bulb(s).
9. Install the new light bulb(s) by screwing in while holding the socket.
10. Reinstall ember bed, log set, glass door and top louvre.

MAINTENANCE OF MOTORS

The motors used on the fan and the drum assembly are prelubricated for extended bearing life and require no further lubrication. However, periodic cleaning/vacuuming of the fan/heater is recommended.



Make sure that the power is turned off before proceeding.

CLEANING BRASS TRIM

Clean the brass trim using a soft cloth, slightly dampened with lemon oil and buff with a clean soft cloth. Do NOT use brass polish or household cleaners as these products will damage the brass trim. Lemon oil can be obtained at supermarkets or hardware stores.

ELECTRIC DIAGRAM

Any electrical repairs or rewiring of this unit should be carried out by a licensed electrician in accordance with national and local codes



If repairing or replacing any electrical component or wiring the original wire routing, colour coding and securing locations must be followed.

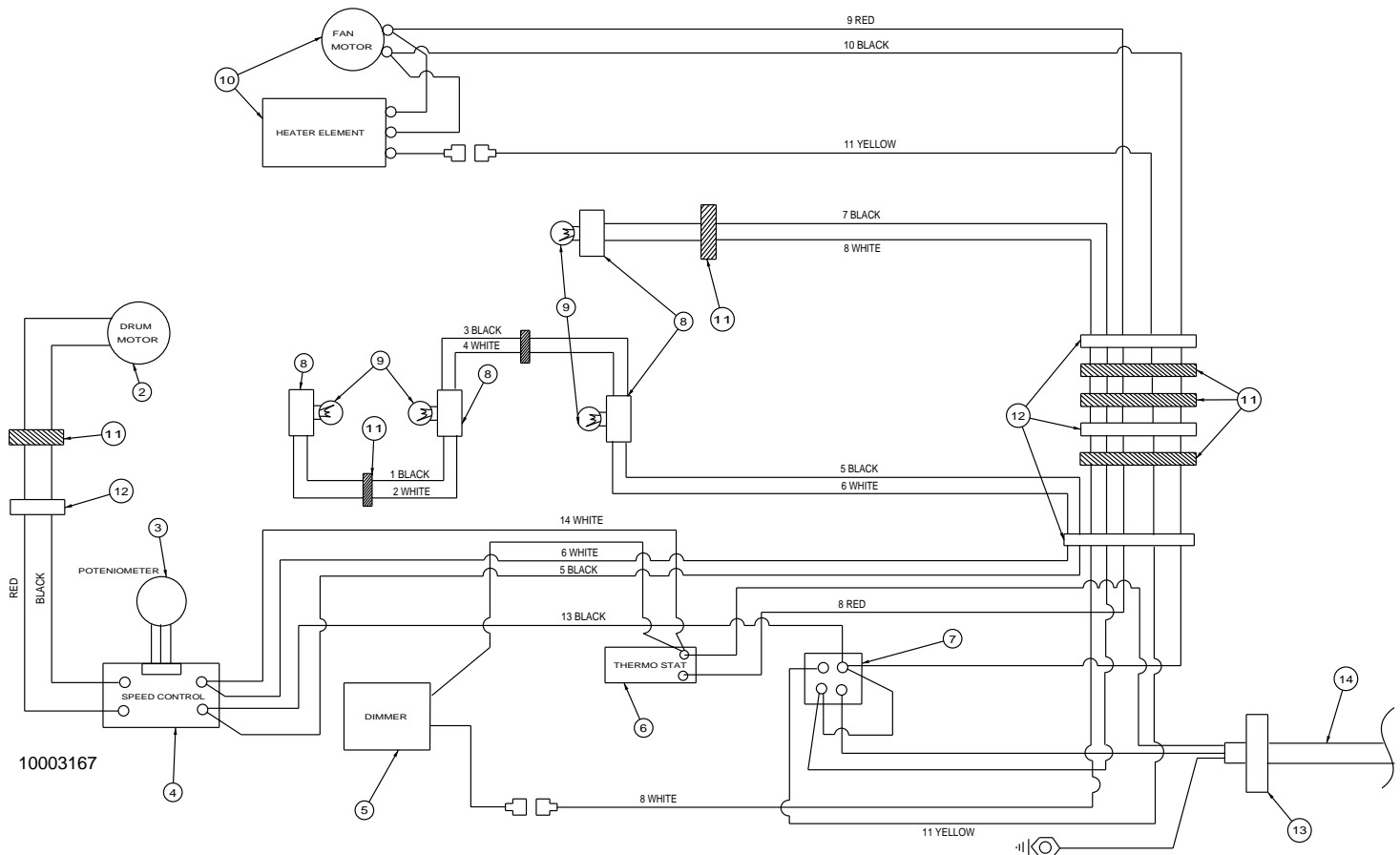

CFM Majestic Factory Wire Req'd

2. Motor Variable Speed (12V/DC)
3. potentiometer
4. Speed Control
5. Dimmer Switch Rotary
6. Thermostat
7. On / Off Switch
8. Light Socket
9. Light Bulb
10. Fan/Heater
11. Nylon Cable Tie
12. Grommet 7/8

Wiring Colour Code:

- WH = White
 BL = Black
 RE = Red

OPERATING INSTRUCTIONS

The control compartment is located behind the lower louvre panel. To access the controls, simply flip down the lower louvre panel. To locate the position of each control described below, refer to Fig. 9.

1. MAIN ON/OFF SWITCH

The On/Off switch supplies power to all of the functions of the fireplace. This is an illuminated switch which normally will light up when in the "on" position.



During any service of this appliance, the power to the unit must be turned off. It is not acceptable to use the "On/Off" switch to meet this requirement.

2. HEATER CONTROL

The Heater Control acts to turn the heater on and off as well as setting the comfort level in the room. Turning the knob clockwise from the off position will place the heater into operation. The further the knob is rotated clockwise, the higher the set point temperature. Turning the knob counterclockwise will lower the set point temperature. Turning it all the way counterclockwise will turn the heater function off.

The Heat Hi/Lo Switch is located beside the On/Off switch. When the Heat Hi/Lo Switch indicates the Off position the heat is on Low (single state heat). When the Heat Hi/Lo Switch indicates the On position the Heat is on High (full state heat)

3. LOG ILLUMINATION CONTROL

This control varies the brightness of the light located above the log set. Turn the knob to increase, decrease or turn off the light as desired.

4. FLAME SPEED CONTROL

Turn the flame speed control knob to increase or decrease the flame speed as desired.

CONTROL PANEL

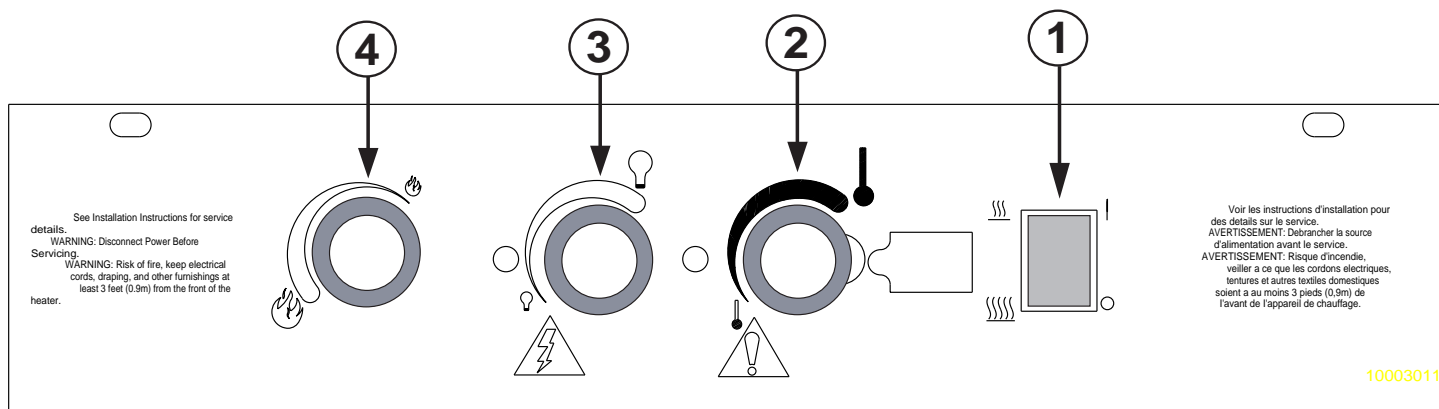
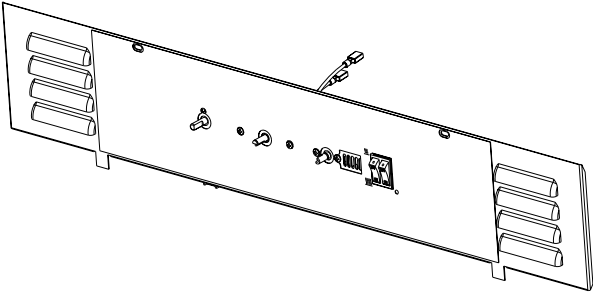

Fig. 9

REPLACEMENT PARTS - ELECTRIC FIREPLACE



REPLACEMENT PARTS LIST - ELECTRIC FIREPLACE

DESCRIPTION		PART No.
1.	Log Set Complete	10001682
1a.	Log Ember Bed	A12
1b.	Log Front Left	A13
1c.	Log Front Right	A14
1d.	Log Rear Left	A15
1e.	Log Rear Right	A16
2.	Fan/Heater Assembly w/bracket	10003009
3.	Motor 12VDC - Flame genertor	10001978
4.	Electrical Cord 8 ft. Assembly	10003144
5.	On/Off Switch	10002998
6.	Thermostat - Heater Control	10002987
7.	Switch - Log Illumination Dimmer Assembly	10003143
8.	Potentiometer - Flame Speed Control	10001168
9.	Circuit Board - Flame Speed Control	10002983
10.	Knob - Flame Speed, Heater Controls & Potentiometer	10001639
11.	Top Louvre Assembly	10000292
12.	Bottom Louvre Assembly	10000293
13.	Hinge Access Door	52356
14.	Trim-Frame Window (PB) (w/2 magnets)	55005
15.	Light Filter - Ember Bed (Not Shown)	10001259
16.	Light Diffuser Screen (Not Shown)	10001157
17.	Screen Tinted Plastic (Not Shown)	10001263
18.	Glass with Gasket	10001883
19.	Gasket Glass	10001881
20.	Frame Window	10001729
21.	Light Diffuser - ember Bed (not shown)	10001536
22.	Flame Generator Assembly	10001223
23.	Light Diffuser - Ember Bed (Not Shown)	10001536
24.	Light Socket	10003003
25.	Facial Control Assembly	10003034

OPTIONS

Description	Order Part Number
Trim Kit - Polished Brass	DV33TKP (Fitting instructions included in kit)
Medium Trim Kit - Polished Brass	DV33TKMP (Fitting instructions included in kit)
Wide Trim Kit - Polished Brass	DV33TKWP (Fitting instructions included in kit)
Bay Window Trim Kit - Polished Brass	DV33BTKP (Fitting instructions included in kit)
Ceramic Refractory Kit	DEF33CR (see below for fitting instructions)

CERAMIC REFRACTORY INSTALLATION

1. Remove glass door assembly.
2. Slide refractory panels on either side of the firebox between firebox side and the upper lintel baffle.
3. Push panels against firebox side. If desired, secure the panels to the sides of the firebox with some adhesive, such as silicone.
4. Replace glass frame and upper louvre panel.

Free Manuals Download Website

<http://myh66.com>

<http://usermanuals.us>

<http://www.somanuals.com>

<http://www.4manuals.cc>

<http://www.manual-lib.com>

<http://www.404manual.com>

<http://www.luxmanual.com>

<http://aubethermostatmanual.com>

Golf course search by state

<http://golfingnear.com>

Email search by domain

<http://emailbydomain.com>

Auto manuals search

<http://auto.somanuals.com>

TV manuals search

<http://tv.somanuals.com>