

1. Front Panel Description

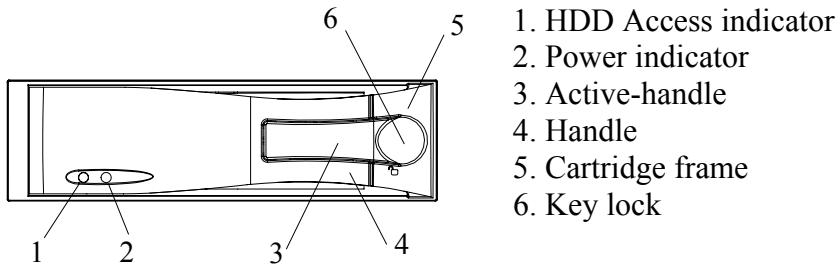

2. Function Settings and Operation

2-1 Power Indicator and HDD Access indicator

When power is turned on, the indicator will displays the following

Item	Indicator
Power Indicator	Green LED
HDD Access Indicator	Amber LED

2-2 Key lock

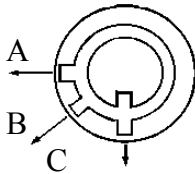

Status Segment	Power status	Security status
A	ON	Locked (Irremovable)
B	OFF	Locked (Irremovable)
C	OFF	Unlocked (Removable)

3. Installing Hard Drive into Cartridge

Step 1

1-1. Pull the active-handle outwards and use the miniature key provided and insert into the key hole, turning the key anti-clockwise, then the handle will auto-eject for pulling out. (Fig.1)

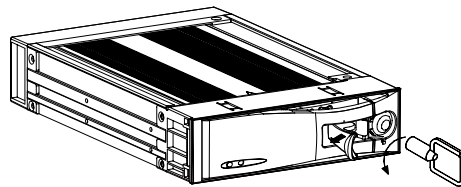

Fig. 1

1-2. Pull the handle outwards to remove the carrier body away from the cartridge frame. (Fig.2)

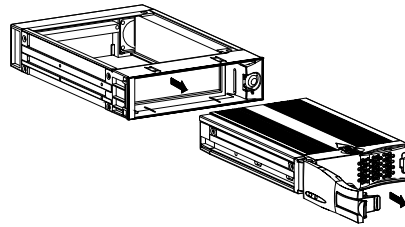

Fig. 2

Step 2

2-1. Push the release latch to slide the top cover backwards and remove. (Fig.3)

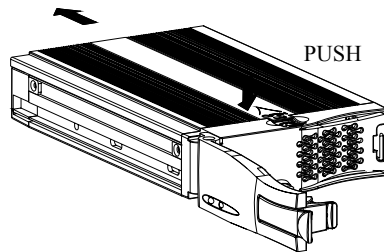

Fig. 3

Step 3

3-1. Insert the DC power cable and IDE cable on the HDD. (Fig.4)

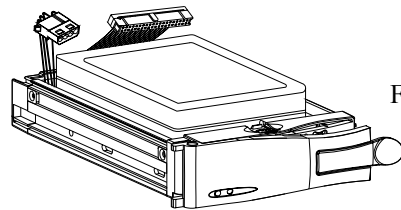

Fig. 4

3-2. Position the HDD into carrier body and secure the HDD using the four 6#-32 screws provided. (Fig.5)

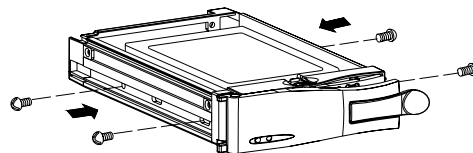

Fig. 5

Step 4

4-1. Slide the top cover back to the carrier body by sliding forward to secure. (Fig.6)

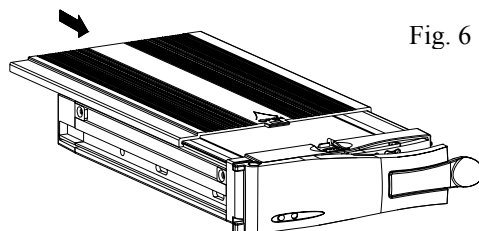

Fig. 6

Step 5

5-1. Slide the carrier body back into the cartridge frame. (Fig.7)

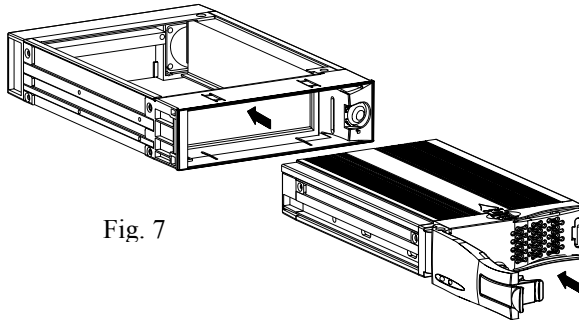

Fig. 7

5-2. Push carrier body further into cartridge frame until fully inserted. (Fig. 8)

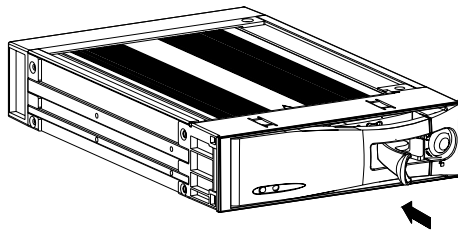

Fig. 8

Step 6

6-1. Install the module into a 5.25" half-height expansion bay. Insert the DC power cable and the IDE cable of the user's chassis to connectors located at the back plane of the cartridge frame. Then, fully secure the module to the chassis by using the four M3x6 screws provided. (Fig.9)

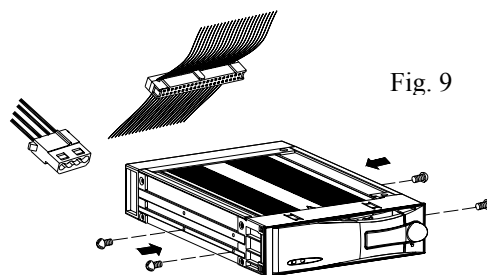

Fig. 9

6-2. Pull the active-handle outwards and use the miniature key provided and insert into the key hole, turning the key clockwise to secure the handle. (Refer to **section 2-2 Key lock**)

Free Manuals Download Website

<http://myh66.com>

<http://usermanuals.us>

<http://www.somanuals.com>

<http://www.4manuals.cc>

<http://www.manual-lib.com>

<http://www.404manual.com>

<http://www.luxmanual.com>

<http://aubethermostatmanual.com>

Golf course search by state

<http://golfingnear.com>

Email search by domain

<http://emailbydomain.com>

Auto manuals search

<http://auto.somanuals.com>

TV manuals search

<http://tv.somanuals.com>