

# VANGUARD<sup>®</sup>

## VENT-FREE NATURAL GAS HEATER OWNER'S OPERATION AND INSTALLATION MANUAL

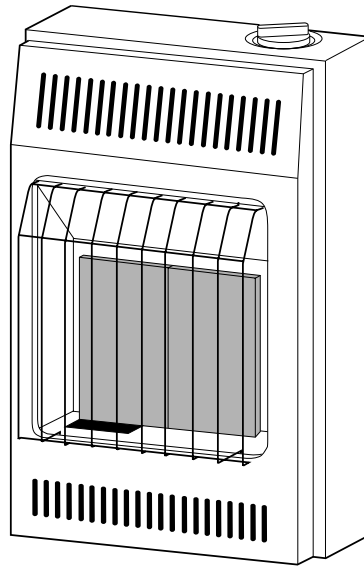

### Models: VN6A and VN12

**WARNING:** If the information in this manual is not followed exactly, a fire or explosion may result causing property damage, personal injury, or loss of life.

- Do not store or use gasoline or other flammable vapors and liquids in the vicinity of this or any other appliance.
- **WHAT TO DO IF YOU SMELL GAS**
  - Do not try to light any appliance.
  - Do not touch any electrical switch; do not use any phone in your building.
  - Immediately call your gas supplier from a neighbor's phone. Follow the gas supplier's instructions.
  - If you cannot reach your gas supplier, call the fire department.
- Installation and service must be performed by a qualified installer, service agency, or the gas supplier.

**WARNING:** Improper installation, adjustment, alteration, service, or maintenance can cause injury or property damage. Refer to this manual for correct installation and operational procedures. For assistance or additional information consult a qualified installer, service agency, or the gas supplier.

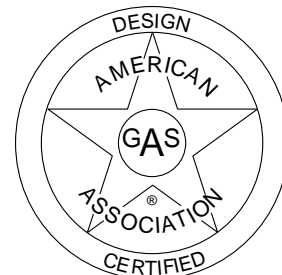

**Save this manual for future reference.**

# CONTENTS

SECTION	PAGE
Safety Information .....	2
Product Identification .....	4
Local Codes .....	4
Unpacking .....	4
Product Features .....	4
Installing To Wall .....	5
Connecting To Gas Supply .....	9
Checking Gas Connections .....	10
Operating Heater .....	12
Inspecting Burner .....	15
Cleaning And Maintenance .....	16
Troubleshooting .....	17
Technical Service .....	20
Specifications .....	20
Service Hints .....	21
Replacement Parts .....	21
Service Publications .....	21
Accessory .....	21
Parts List (Model VN6A) .....	22
Illustrated Parts Breakdown (Model VN6A) .....	22
Parts List (Model VN12) .....	23
Illustrated Parts Breakdown (Model VN12) .....	23
Warranty Information .....	Back Cover

# SAFETY INFORMATION

## WARNINGS

**IMPORTANT:** Read this Owner's Manual carefully and completely before trying to assemble, operate, or service this heater. Improper use of this heater can cause serious injury or death from burns, fire, explosion, and carbon monoxide poisoning.

## DANGER

**Carbon monoxide poisoning may lead to death!**

**Carbon Monoxide Poisoning:** Early signs of carbon monoxide poisoning resemble the flu, with headaches, dizziness, or nausea. If you have these signs, the heater may not be working properly. **Get fresh air at once!** Have heater serviced. Some people are more affected by carbon monoxide than others. These include pregnant women, persons with heart or lung disease or anemia, those under the influence of alcohol, and those at high altitudes.

**Natural Gas:** Natural gas is odorless. An odor-making agent is added to natural gas. The odor helps you detect a natural gas leak. However, the odor added to natural gas can fade. Natural gas may be present even though no odor exists.

Make certain you read and understand all Warnings. Keep this manual for reference. It is your guide to safe and proper operation of this heater.

*Safety Information continued on next page*

## **SAFETY INFORMATION**

*Continued*

## **⚠ WARNINGS** *Continued*

1. Use only natural gas. Do not convert heater to use different fuel type.
2. If you smell gas
  - shut off gas supply
  - do not try to light any appliance
  - do not touch any electrical switch; do not use any phone in your building
  - immediately call your gas supplier from a neighbor's phone. Follow the gas supplier's instructions
  - if you cannot reach your gas supplier, call the fire department
3. Never install the heater
  - in sleeping quarters or a recreational vehicle
  - where curtains, furniture, clothing, or other flammable objects are less than 36 inches from the front, top, or sides of the heater
  - as a fireplace insert
  - in high traffic areas
  - in windy or drafty areas
4. Always run heater with control knob at **LOW** or **HIGH** locked positions (VN12) or **ON** position (VN6A). Never set control knob between locked positions. Poor combustion and higher levels of carbon monoxide may result.
5. Open window to admit fresh, outside air when using heater. Open window one or two inches. When used without fresh, outside air, heater may give off carbon monoxide gas.
6. Never run heater in small, closed room. Open door into next room to help ventilate.
7. Keep all air openings in front and bottom of heater clear and free of debris. This will insure enough air for proper combustion.
8. If heater shuts off, do not relight until you provide fresh, outside air. If heater keeps shutting off, have it serviced.
9. Do not run heater
  - where flammable liquids or vapors are used or stored
  - under dusty conditions
10. Never place any objects on the heater.
11. Surface of heater becomes very hot when running heater. Keep children and adults away from hot surface to avoid burns or clothing ignition. Heater will remain hot for a time after shut-down. Allow surface to cool before touching.
12. Make sure grill guard is in place before running heater.
13. Do not alter heater or its controls. Any change may create a safety hazard.
14. Do not use heater if any part of heater has been under water.
15. Turn off heater and let cool before servicing. Only a qualified service person should service and repair heater.
16. Do not operate heater above elevations of 4,500 feet.

## PRODUCT IDENTIFICATION

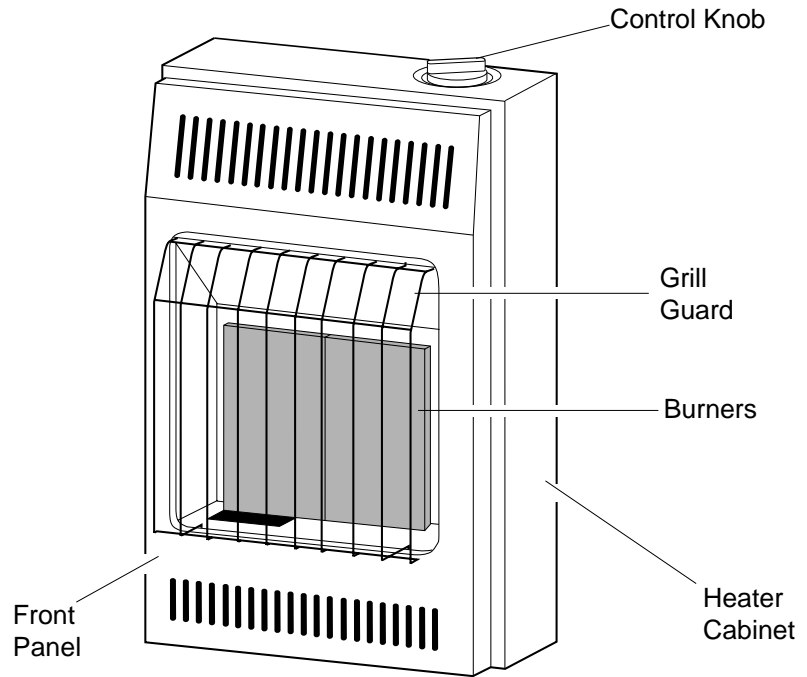

*Figure 1 - Vent-Free Natural Gas Heater (Model VN12 Shown)*

## LOCAL CODES

Install and use heater with care. Follow all local codes. In the absence of local codes, use the latest edition of National Gas Code ANSI Z223.1, also known as NFPA 54\*.

\*Available from:

American National Standards Institute, Inc.  
1430 Broadway  
New York, NY 10018

National Fire Protection Association, Inc.  
Batterymarch Park  
Quincy, MA 02269

## UNPACKING

1. Remove heater from carton.
2. Remove all protective packaging applied to heater for shipment.
3. Check heater for any shipping damage. If heater is damaged, promptly inform dealer where you bought heater.

## PRODUCT FEATURES

### Safety Device

This heater has a pilot with an Oxygen Depletion Sensor Shutoff System (ODS). The ODS/pilot is a required feature for vent-free room heaters. The ODS/pilot shuts off the heater if there is not enough fresh air.

### Piezo Ignition System

This heater has a piezo ignitor. This system requires no matches, batteries, or other sources to light heater.

# INSTALLING TO WALL

## NOTICE

**A qualified service person must install heater. Follow all local codes.**

### CHECK GAS TYPE

Use only natural gas. If your gas supply is not natural, do not install heater. Call dealer where you bought heater for proper type heater.

### INSTALLATION ITEMS

Before installing heater, make sure you have the items listed below.

- piping (check local codes)
- sealant (resistant to propane gas)
- manual shutoff valve \*
- ground joint union
- test gauge connection \* (see Figure 10, page 10)
- sediment trap
- tee joint
- pipe wrench

\* An A.G.A. design-certified manual shutoff valve with 1/8" NPT tap is an acceptable alternative to test gauge connection. Purchase the optional A.G.A. design-certified manual shutoff valve from your dealer. See ACCESSORY, page 21.

### LOCATING HEATER

This heater is designed to be mounted on a wall.

## WARNING

**Maintain the minimum clearances shown in Figure 2 (page 6). If you can, provide greater clearances from floor, ceiling, and joining wall.**

## WARNING

### Never install the heater

- in sleeping quarters, a mobile home, or a recreational vehicle
- where curtains, furniture, clothing, or other flammable objects are less than 36 inches from the front, top, or sides of the heater
- as a fireplace insert
- in high traffic areas
- in windy or drafty areas

## CAUTION

**Operating heater where impurities in the air (such as tobacco smoke) exist, may discolor walls.**

## CAUTION

### If you install the heater in a home garage

- heater pilot and burner must be at least 18 inches above floor
- locate heater where moving vehicle will not hit it

For convenience and efficiency, install heater

- where there is easy access for operation, inspection, and service
- in coldest part of room

*Continued*

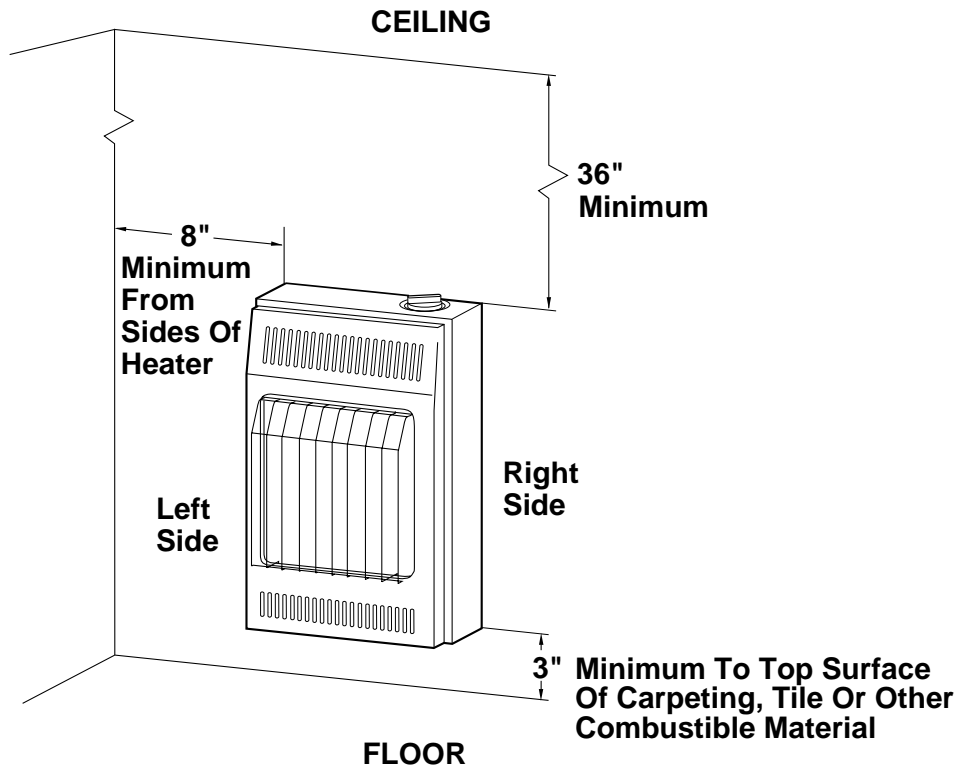

Figure 2 - Mounting Clearances As Viewed From Front of Heater

## INSTALLING HEATER TO WALL

### Marking Screw Locations

1. Determine where you will locate heater.

### **⚠ WARNING**

Maintain minimum clearances shown in Figure 3. If you can, provide greater clearances from floor and joining wall.

2. Mark two mounting screw locations on wall (see Figure 3).

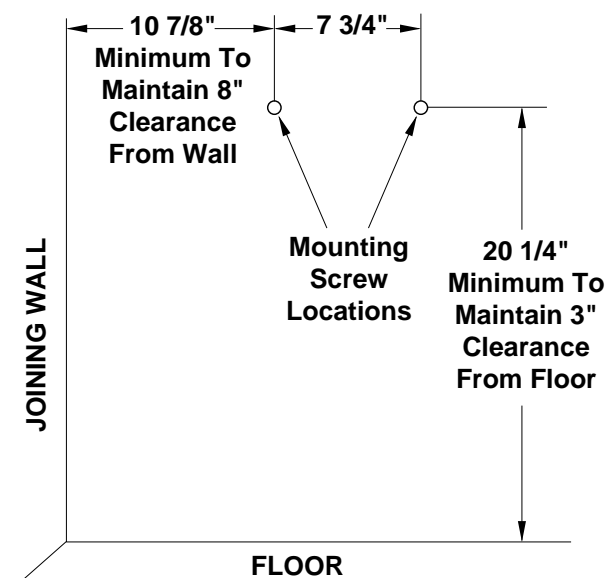

Figure 3 - Mounting Screw Locations

## Installing Two Mounting Screws

*Note:* Wall anchors and mounting screws are in hardware package. The hardware package is provided with heater.

### Attaching to wall stud method

For attaching mounting screw to wall stud

1. Drill hole at marked location using 9/64" drill bit.
2. Insert mounting screw into wall stud.
3. Tighten screw until 1/16" space (thickness of penny) is between screwhead and wall.

### Attaching to wall anchor method

Follow instructions below to attach mounting screws to hollow walls (wall areas between studs) or solid walls (concrete or masonry).

1. Drill holes at marked locations using 5/16" drill bit. For solid walls (concrete or masonry), drill at least 1 1/4" deep.
2. Fold wall anchor (see Figure 4).

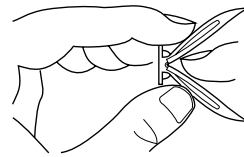

**Figure 4 - Folding Anchor**

3. Insert wall anchor (wings first) into hole. Tap anchor flush to wall.
4. For thin walls (1/2" or less), insert red key into wall anchor. Push red key to "pop" open anchor wings (see Figure 5). **IMPORTANT:** Do not hammer key! For thick walls (over 1/2" thick) or solid walls, do not pop open wings.

Thin Walls  
(1/4" to 1/2" thick)

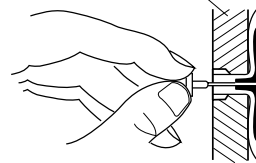

**Figure 5 - Popping Open Anchor Wings For Thin Walls**

5. Tighten two screws until 1/16" space (thickness of penny) is between screwheads and wall (see Figure 6).

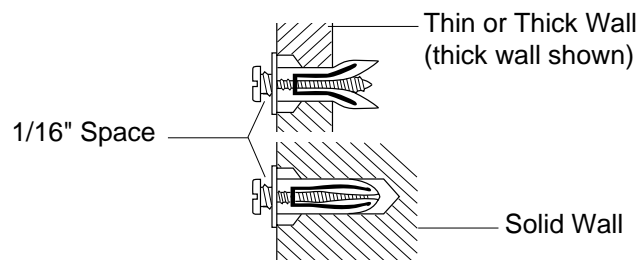

**Figure 6 - Tightening Anchors**

## Placing Heater On Mounting Screws

1. Locate two keyhole slots on back panel of heater (see Figure 7).
2. Place large openings of slots over screwheads. Slide heater down until screws are in small portion of slots.

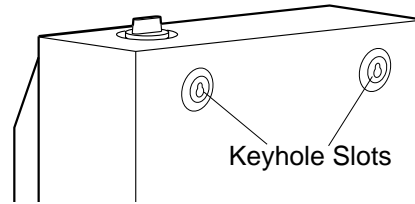

**Figure 7 - Location Of Keyhole Slots On Back Panel Of Heater**

## Removing Front Panel Of Heater

1. Remove two screws near bottom corners of front panel.
2. Lift straight up on grill guard until it stops. Grill guard will slide up about 1/4".
3. Pull bottom of front panel forward, then down.

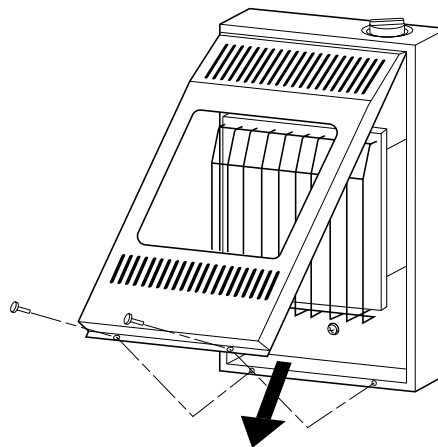

**Figure 8 - Removing Front Panel Of Heater**

## Installing Bottom Mounting Screw

1. Locate bottom mounting hole. This hole is near bottom on back panel of heater (see Figure 9).
2. Mark screw location on wall.
3. Remove heater from wall.
4. If installing bottom mounting screw into hollow or solid wall, install wall anchor. Follow steps 1 through 5 under *Attaching To Wall Anchor Method*, page 7. If installing bottom mounting screw into wall stud, drill hole at marked location using 9/64" drill bit.
5. Replace heater on wall.
6. Insert bottom anchor screw through back panel into bottom anchor or drilled hole (see Figure 9).
7. Tighten screw until heater is firmly secured to wall. Do not over tighten.  
**Note:** Do not replace front panel at this time. Replace front panel after making gas connections and checking for leaks (see pages 9-11).

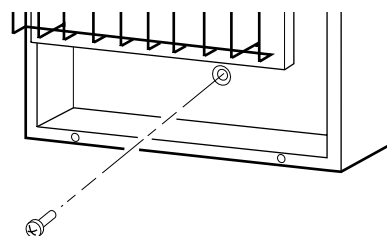

**Figure 9 - Installing Bottom Mounting Screw**



# CONNECTING TO GAS SUPPLY

## NOTICE

**A qualified service person must connect heater to gas supply. Follow all local codes.**

## WARNING

**Never connect heater to private (non-utility) gas wells. This gas is commonly known as well-head gas.**

*IMPORTANT:* Check gas line pressure before connecting heater to gas line. Gas line pressure must be no greater than 14 inches of water. If gas line pressure is higher, heater regulator damage could occur.

## CAUTION

**Use only new, black iron or steel pipe. Copper tubing may be used in certain areas. Check your local codes. Use pipe 3/8" diameter or greater to allow proper gas volume to heater. If pipe is too small, undue loss of pressure will occur.**

Installation must include a manual shutoff valve, ground joint union, and plugged 1/8" NPT tap. Locate NPT tap within reach for test gauge hook up. NPT tap must be upstream from heater (see Figure 10, page 10).

Apply pipe joint sealant lightly to male threads. This will prevent excess sealant from going into pipe. Excess sealant in pipe could result in clogged heater valves.

## CAUTION

**Use pipe joint sealant that is resistant to liquid petroleum (LP) gas.**

Install sediment trap in supply line as shown in Figure 10. Locate sediment trap where it is within reach for cleaning. Locate sediment trap where trapped matter is not likely to freeze. A sediment trap traps moisture and contaminants. This keeps them from going into heater controls. If sediment trap is not installed or is installed wrong, heater may not run properly.

*Continued*

**IMPORTANT:** Hold pressure regulator with wrench when connecting it to gas piping and/or fittings.

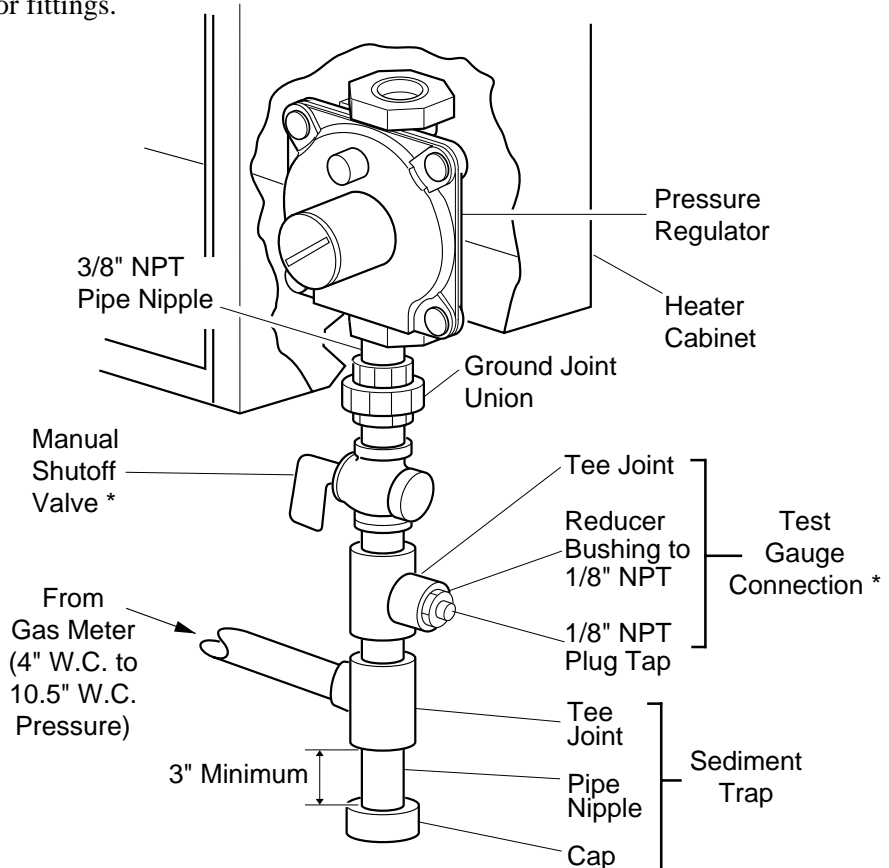

**Figure 10 - Gas Connection**

\* An A.G.A. design-certified manual shutoff valve with 1/8" NPT tap is an acceptable alternative to test gauge connection. Purchase the optional A.G.A. design-certified manual shutoff valve from your dealer. See ACCESSORY, page 21.

## CHECKING GAS CONNECTIONS

### **⚠ WARNING**

**Test all gas piping and connections for leaks after installing or servicing. Correct all leaks at once.**

### **⚠ WARNING**

**Never use an open flame to check for a leak. Apply a mixture of liquid soap and water to all joints. Bubbles forming show a leak. Correct all leaks at once.**

### **PRESSURE TESTING GAS SUPPLY PIPING SYSTEM**

#### **Test Pressures In Excess Of 1/2 PSIG**

1. Disconnect heater and its individual manual shutoff valve from gas supply piping system. Pressures in excess of 1/2 PSIG will damage heater regulator.
2. Cap off open end of gas pipe where manual shutoff valve was connected.
3. Pressurize supply piping system by either using compressed air or opening main gas valve located on or near gas meter.

*Continued*

4. Check all joints of gas supply piping system. Apply mixture of liquid soap and water to gas joints. Bubbles forming show a leak.
5. Correct all leaks at once.

#### **Test Pressures Equal To or Less Than 1/2 PSIG**

1. Close manual shutoff valve (see Figure 11).
2. Pressurize supply piping system by either using compressed air or opening main gas valve located on or near gas meter.
3. Check all joints from gas meter to manual shutoff valve (see Figure 12). Apply mixture of liquid soap and water to gas joints. Bubbles forming show a leak.
4. Correct all leaks at once.

#### **PRESSURE TESTING HEATER GAS CONNECTIONS**

1. Open manual shutoff valve (see Figure 11).
2. Open main gas valve located on or near gas meter.
3. Make sure control knob of heater is in the OFF position.
4. Check all joints from manual shutoff valve to control valve (see Figure 12). Apply mixture of liquid soap and water to gas joints. Bubbles forming show a leak.
5. Correct all leaks at once.
6. Light heater (see OPERATING HEATER, pages 12 through 15). Check the rest of the internal joints for leaks.
7. Turn off heater (see TO TURN OFF GAS TO APPLIANCE, page 15).
8. Replace front panel.

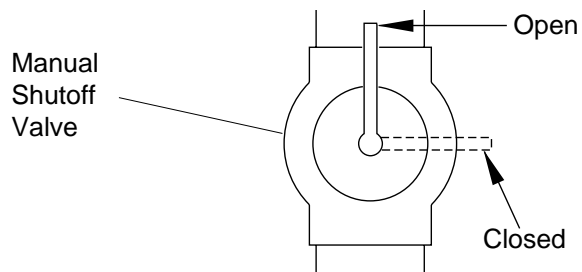

**Figure 11 - Manual Shutoff Valve**

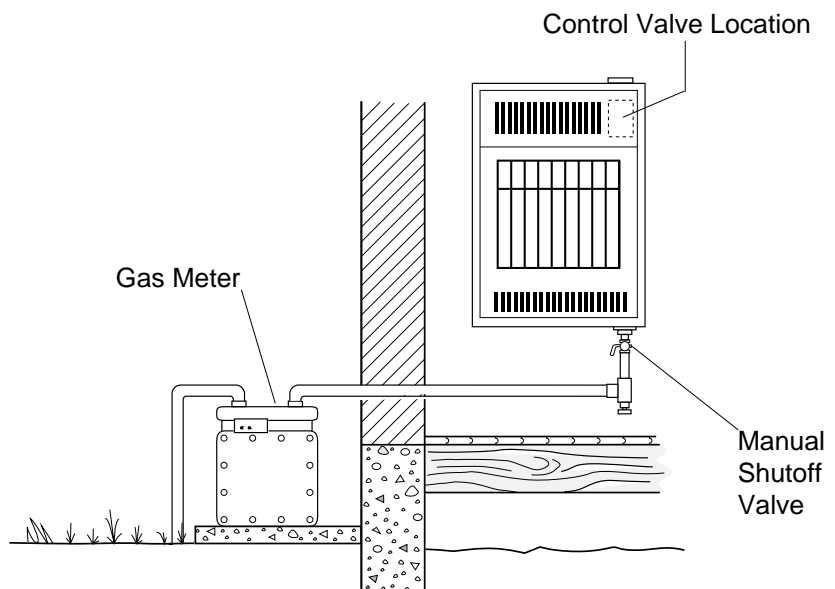

**Figure 12 - Checking Gas Joints**

# OPERATING HEATER

## FOR YOUR SAFETY READ BEFORE LIGHTING

### WARNING

**If you do not follow these instructions exactly, a fire or explosion may result causing property damage, personal injury or loss of life.**

- A. This appliance has a pilot which must be lighted by hand. When lighting the pilot, follow these instructions exactly.
- B. BEFORE LIGHTING smell all around the appliance area for gas. Be sure to smell next to the floor because some gas is heavier than air and will settle on the floor.

#### WHAT TO DO IF YOU SMELL GAS

- Do not try to light any appliance.
  - Do not touch any electric switch; do not use any phone in your building.
  - Immediately call your gas supplier from a neighbor's phone. Follow the gas supplier's instructions.
  - If you cannot reach your gas supplier, call the fire department.
- C. Use only your hand to push in or turn the gas control knob. Never use tools. If the knob will not push in or turn by hand, don't try to repair it, call a qualified service technician or gas supplier. Force or attempted repair may result in a fire or explosion.
  - D. Do not use this appliance if any part has been under water. Immediately call a qualified service technician to inspect the appliance and to replace any part of the control system and any gas control which has been under water.

## LIGHTING INSTRUCTIONS

1. STOP! Read the safety information above.
2. Make sure manual shutoff valve is fully open.
3. Turn control knob clockwise  to the OFF position.

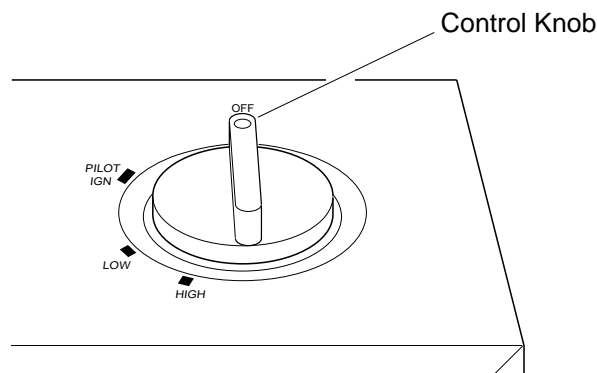

**Figure 13 - Control Knob In The OFF Position (Model VN12 Shown)**

4. Wait five (5) minutes to clear out any gas. Then smell for gas, including near the floor. If you smell gas, STOP! Follow “B” in the safety information at the top of page 12. If you don’t smell gas, go to the next step.

5. Press in control knob.

*Note:* You may be running this heater for the first time after hooking up to gas supply. If so, the control knob may need to be pressed in for 30 seconds. This will allow air to bleed from the gas system.

- If control knob does not pop up when released, contact a qualified service person or gas supplier for repairs.

6. Keep control knob pressed in and turn it counterclockwise  to the PILOT/IGN position. This will light pilot.

*Note:* You will hear a loud “click” when the control knob reaches the PILOT/IGN position.

If pilot does not light

- turn control knob clockwise  to the OFF position
- repeat steps 5 and 6

If pilot does not stay lit after several tries

- refer to TROUBLESHOOTING, pages 17 through 20
- contact a qualified service person or gas supplier

Until repairs are made, light pilot with match. To light pilot with match, see

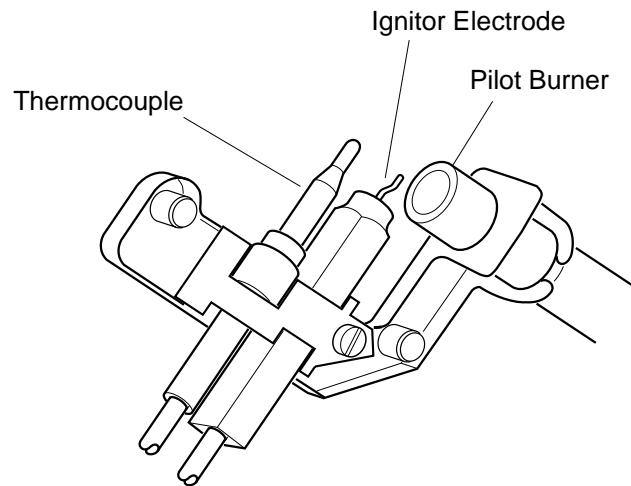

**Figure 14 - Pilot**

MANUAL LIGHTING PROCEDURE, page 15.

7. Keep control knob pressed in for 10 seconds after lighting pilot. After 10 seconds, release control knob.

*Note:* If pilot goes out, repeat steps 3 through 7.

## TO SELECT HEATING LEVEL

### ⚠ WARNING

When running heater, set control knob at LOW or HIGH locked positions (VN12) or ON position (VN6A). Never set control knob between locked positions. Poor combustion and higher levels of carbon monoxide may result.

### ⚠ CAUTION

Do not try to adjust heating levels by using the manual shutoff valve.

- Slightly press in control knob and turn counterclockwise  to the LOW or HIGH positions (VN12) or ON position (VN6A).  
*IMPORTANT:* Release downward pressure while turning control knob. Control knob will lock at the desired position.

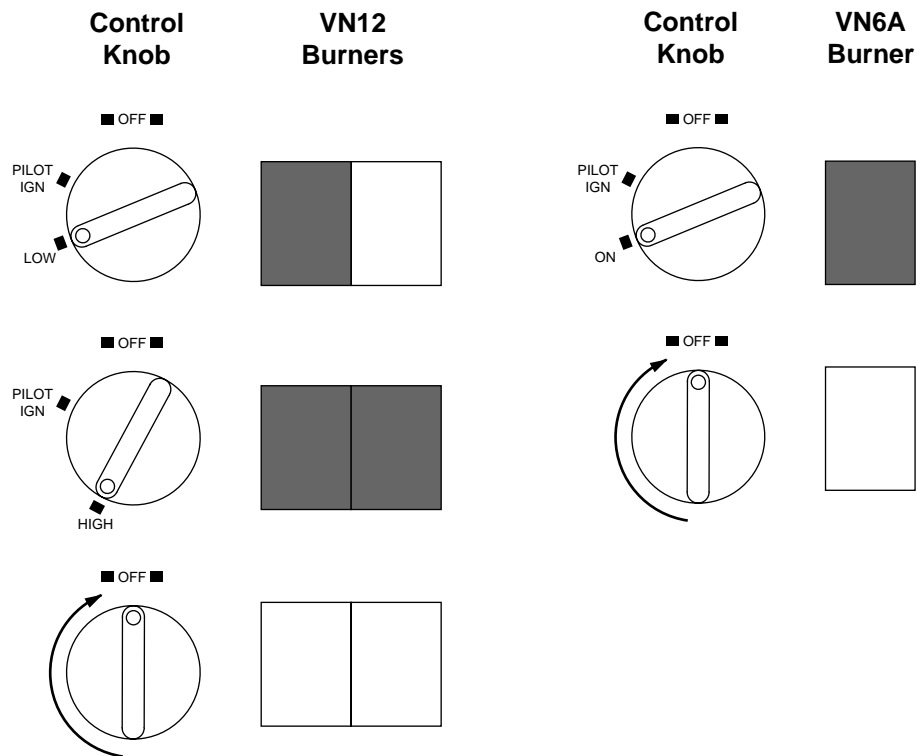

**Figure 15 - Burner Patterns**

## INSPECTING BURNER

### TO TURN OFF GAS TO APPLIANCE

#### Shutting Off Heater

1. Turn control knob clockwise  to the OFF position.

#### Shutting Off Burner Only (pilot stays lit)

1. Turn control knob clockwise  to the PILOT position.

### MANUAL LIGHTING PROCEDURE

1. Remove front panel (see Figure 8, page 8).
2. Follow steps 1 through 6 under LIGHTING INSTRUCTIONS, pages 12 and 13.
3. With control knob pressed in, strike match. Hold match to pilot until pilot lights.
4. Keep control knob pressed in for 10 seconds after pilot is lit. After 10 seconds, release control knob.
5. Replace front panel.

Check pilot flame pattern and burner flame pattern often.

#### PILOT FLAME PATTERN

Figure 16 shows a correct pilot flame pattern. Figure 17 shows an incorrect pilot flame pattern. The incorrect pilot flame is not touching the thermocouple. This will cause the thermocouple to cool. When the thermocouple cools, the heater will shut down.

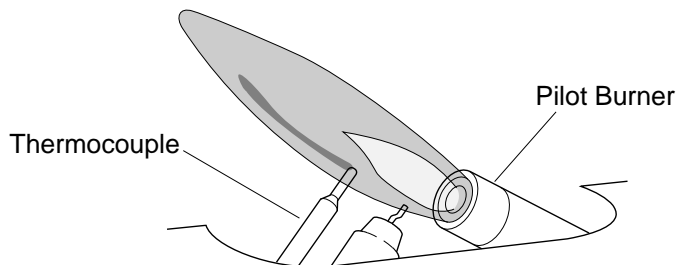

**Figure 16 - Correct Pilot Flame Pattern**

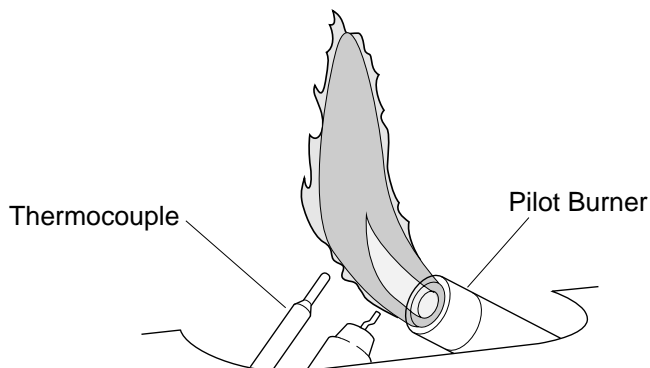

**Figure 17 - Incorrect Pilot Flame Pattern**

If pilot flame pattern is incorrect, as shown in Figure 17

- turn heater off (see TO TURN OFF GAS TO APPLIANCE, above)
- see TROUBLESHOOTING, pages 17 through 20

Continued

## CLEANING AND MAINTENANCE

### BURNER FLAME PATTERN

Figure 18 shows a correct burner flame pattern. Figure 19 shows an incorrect burner flame pattern.

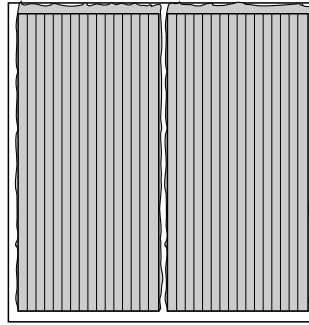

*Figure 18 - Correct Burner Flame Pattern (Model VN12 Shown)*

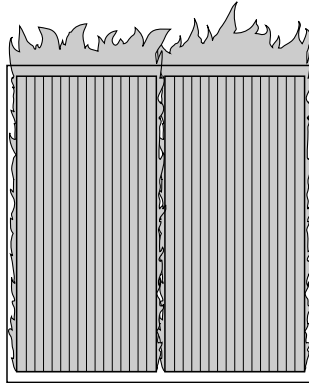

*Figure 19 - Incorrect Burner Flame Pattern (Model VN12 Shown)*

If burner flame pattern is incorrect, as shown in Figure 19

- turn heater off (see TO TURN OFF GAS TO APPLIANCE, page 15)
- see TROUBLESHOOTING, pages 17 through 20

#### **⚠ WARNING**

Turn off heater and let cool before cleaning.

#### **⚠ CAUTION**

You must keep control areas, burner, and circulating air passageways of heater clean. Inspect these areas of heater before each use. Have heater inspected yearly by a qualified service person. Heater may need more frequent cleaning due to excessive lint from carpeting, bedding material, etc.

### ODS/PILOT AND BURNER ORIFICE

- Use a vacuum cleaner, pressurized air, or small, soft bristled brush to clean.

### CABINET

#### **Air Passageways**

- Use a vacuum cleaner or pressurized air to clean.

#### **Exterior**

- Use a soft cloth dampened with a mild soap and water mixture. Wipe the cabinet to remove dust.



# TROUBLE-SHOOTING

Note: All troubleshooting items are listed in order of operation.

## WARNING

Turn off heater and let cool before servicing. Only a qualified service person should service and repair heater.

## CAUTION

Never use a wire, needle, or similar object to clean ODS/pilot. This can damage ODS/pilot unit.

OBSERVED PROBLEM	POSSIBLE CAUSE	REMEDY
When control knob is pressed in and turned to the PILOT/IGN position, there is no spark at ODS/pilot	1. Ignitor electrode positioned wrong	1. Replace ignitor
	2. Ignitor electrode broken	2. Replace ignitor
	3. Ignitor electrode not connected to ignitor cable	3. Reconnect ignitor cable
	4. Ignitor cable pinched or wet	4. Free ignitor cable if pinched by any metal or tubing. Keep ignitor cable dry
	5. Broken ignitor cable	5. Replace ignitor cable
	6. Bad piezo ignitor	6. Replace control valve (piezo is part of control valve)
When control knob is pressed in and turned to the PILOT/IGN position, there is spark at ODS/pilot but no ignition	1. Gas supply turned off or manual shutoff valve closed	1. Turn on gas supply or open manual shutoff valve
	2. Control knob not pressed in while being turned to PILOT/IGN position	2. Press in control knob while turning to PILOT/IGN position
	3. Air in gas lines when installed	3. Continue holding down control knob. Repeat igniting operation until air is removed
	4. ODS/pilot is clogged	4. Clean ODS/pilot (see CLEANING AND MAINTENANCE, page 16) or replace ODS/pilot assembly
	5. Gas regulator setting is not correct	5. Replace gas regulator

**OBSERVED  
PROBLEM****POSSIBLE  
CAUSE****REMEDY**

ODS/pilot lights but flame goes out when control knob is released

1. Control knob not fully pressed in
2. Control knob not pressed in long enough
3. Manual shutoff valve not fully open
4. Thermocouple connection loose at control valve
5. Pilot flame not touching thermocouple, which allows thermocouple to cool, causing pilot flame to go out. This problem could be caused by one or both of the following:  
A) Low gas pressure  
B) Dirty or partially clogged ODS/pilot
6. Thermocouple damaged
7. Control valve damaged

1. Press in control knob fully
2. After ODS/pilot lights, keep control knob pressed in 10 seconds
3. Fully open manual shut-off valve
4. Hand tighten until snug, then tighten 1/4 turn more
5. A) Contact local natural gas company  
  
B) Clean ODS/pilot (see **CLEANING AND MAINTENANCE**, page 16) or replace ODS/pilot assembly
6. Replace thermocouple
7. Replace control valve

Burner(s) does not light after ODS/pilot is lit

1. Burner orifice(s) is clogged
2. Burner orifice(s) diameter is too small
3. Inlet gas pressure is too low

1. Clean burner orifice(s) (see **CLEANING AND MAINTENANCE**, page 16) or replace burner orifice(s)
2. Replace burner orifice(s)
3. Contact local natural gas company

Delayed ignition of burner(s)

1. Manifold pressure is too low
2. Burner orifice(s) is clogged

1. Contact local natural gas company
2. Clean burner orifice(s) (see **CLEANING AND MAINTENANCE**, page 16) or replace burner orifice(s)

Burner backfiring during combustion

1. Burner orifice(s) is clogged or damaged
2. Burner damaged
3. Gas regulator defective

1. Clean burner orifice(s) (see **CLEANING AND MAINTENANCE**, page 16) or replace burner orifice(s)
2. Replace burner
3. Replace gas regulator

**OBSERVED PROBLEM****POSSIBLE CAUSE****REMEDY**

Burner plaque(s) does not glow

1. Plaque damaged
2. Inlet gas pressure is too low
3. Control knob set between locked positions

1. Replace burner
2. Contact local natural gas company
3. Turn control knob until it locks at desired setting

Slight smoke or odor during initial operation

1. Residues from manufacturing processes

1. Problem will stop after a few hours of operation

Heater produces a clicking/ticking noise just after burner is lit or shut off

1. Metal expanding while heating or contracting while cooling

1. This is common with most heaters. If noise is excessive, contact qualified service person

 **WARNING**

**If you smell gas**

- Shut off gas supply.
- Do not try to light any appliance.
- Do not touch any electrical switch; do not use any phone in your building.
- Immediately call your gas supplier from a neighbor's phone. Follow the gas supplier's instructions.
- If you cannot reach your gas supplier, call the fire department.

Heater produces unwanted odors

1. Heater burning vapors from paint, hair spray, glues, etc.
2. Gas leak. **See Warning statement above**

1. Ventilate room. Stop using odor-causing products while heater is running
2. Locate and correct all leaks (see CHECKING GAS CONNECTIONS, page 10)

Heater shuts off in use (ODS operates)

1. Not enough fresh air is available
2. Low line pressure
3. ODS/pilot is partially clogged

1. Open window and/or door for ventilation
2. Contact local natural gas company
3. Clean ODS/pilot (see CLEANING AND MAINTENANCE, page 16)

## ⚠ WARNING

### If you smell gas

- Shut off gas supply.
- Do not try to light any appliance.
- Do not touch any electrical switch; do not use any phone in your building.
- Immediately call your gas supplier from a neighbor's phone. Follow the gas supplier's instructions.
- If you cannot reach your gas supplier, call the fire department.

OBSERVED PROBLEM	POSSIBLE CAUSE	REMEDY
Gas odor even when control knob is in OFF position	<ol style="list-style-type: none"> <li>1. Gas leak. <b>See Warning statement at top of page</b></li> <li>2. Control valve defective</li> </ol>	<ol style="list-style-type: none"> <li>1. Locate and correct all leaks (see CHECKING GAS CONNECTIONS, page 10)</li> <li>2. Replace control valve</li> </ol>
Gas odor during combustion	<ol style="list-style-type: none"> <li>1. Foreign matter between control valve and burner</li> <li>2. Gas leak. <b>See Warning statement at top of page</b></li> </ol>	<ol style="list-style-type: none"> <li>1. Take apart gas tubing and remove foreign matter</li> <li>2. Locate and correct all leaks (see CHECKING GAS CONNECTIONS, page 10)</li> </ol>

You may have further questions about installation, operation, or troubleshooting. If so, contact DESA International's Technical Service Department at 1-800-323-5190.

## TECHNICAL SERVICE SPECIFICATIONS

	VN12	VN6A
B.T.U. (Variable)	6,000/12,000	6,000
Type Gas	Natural Only	Natural Only
Ignition	Piezo	Piezo
Pressure Regulator Setting	3" W.C.	3" W.C.
Inlet Gas Pressure (inches of water)		
Maximum	10.5"	10.5"
Minimum	4"	4"
Dimensions, Inches (H x W x D)		
Heater	20 1/2 x 13 1/2 x 5	20 1/2 x 13 1/2 x 5
Carton	25 x 16 11/16 x 7 1/2	25 x 16 11/16 x 7 1/2
Weight (pounds)		
Heater	14	13
Shipping	17	16

## SERVICE HINTS

### When gas pressure is too low

- pilot will not stay lit
- burner(s) will have delayed ignition
- heater will not produce specified heat

### When gas quality is bad

- pilot will not stay lit
- burner(s) will produce flames and soot
- heater will backfire when lit

You may feel your gas pressure is too low or gas quality is bad. If so, contact your local natural gas supplier.

## REPLACEMENT PARTS

*Note:* Use only original replacement parts. This will protect your warranty coverage for parts replaced under warranty.

### Parts Under Warranty

Contact authorized dealer from whom you purchased this product. If they cannot supply original replacement part(s), call DESA International's Technical Service Department at 1-800-323-5190 for referral information.

When contacting your dealer or DESA International, have ready:

- your name
- your address
- model number of your heater
- how heater was malfunctioning
- type of gas used (propane or natural gas)
- purchase date

Usually, we will ask you to return the defective part to the factory.

### Parts Not Under Warranty

Contact authorized dealers of this product. If they cannot supply original replacement part(s), call DESA International's Parts Department at 1-800-972-7879.

When calling DESA International, have ready:

- model number of your heater
- the replacement part number

## SERVICE PUBLICATIONS

You can purchase a service manual from the address listed on the back page of this manual. Send a check for \$5.00 payable to DESA International.

## ACCESSORY

Purchase this heater accessory from your local dealer. If they cannot supply this accessory, call DESA International's Parts Department at 1-800-972-7879. You can also write to the address listed on the back page of this manual.

### MANUAL SHUTOFF VALVE - GA5010

Manual shutoff valve with 1/8" NPT tap.

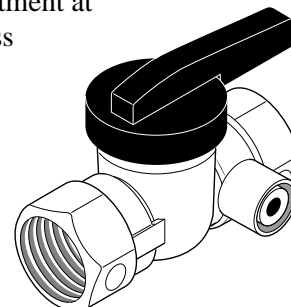

# PARTS LIST VN6A

This list contains replaceable parts used in your heater. When ordering parts, follow the instructions listed under REPLACEMENT PARTS on page 21 of this manual.

KEY NO.	PART NUMBER	DESCRIPTION	QTY.	KEY NO.	PART NUMBER	DESCRIPTION	QTY.
1	098304-01	Screw, #10 x 3/8"	2	13	099384-01	Control Valve	1
2	099467-01	Front Panel Assembly	1	14	099057-01	Pressure Tap Fitting	1
3	099318-01	Grill Guard	1	15	098276-01	1/8 Pipe Plug	1
4	098342-01	Grill Guard Clip	2	16	099468-03	Cabinet Assembly	1
5	099469-01	Reflector Assembly	1	17	099415-01	Gas Regulator	1
6	M15823-37	Screw Hex #8 x 1/4"	9	18	098303-02	Screw, #6 x 5/16"	2
7	503329	ODS/Pilot Assembly	1	19	098508-01	Valve Retainer Nut	1
7-1	098514-01	Thermocouple	1	20	099393-01	Control Knob	1
7-2	098594-01	Ignitor Electrode	1	21	M11084-26	Screw, #10 x 3/8"	2
8	099884-01	Burner Assembly	1	22	099818-01	Internal Tooth Washer	1
9	099056-04	Injector	1	<b>PARTS AVAILABLE - NOT SHOWN</b>			
10	099390-01	Tubing - Valve to burner	1		099395-01	Control Position Label	1
11	099387-05	Pilot Tubing - Valve to pilot	1				
12	099391-02	Tubing - Regulator to valve	1				

## ILLUSTRATED PARTS BREAKDOWN VN6A

HEATER EXPLODED VIEW

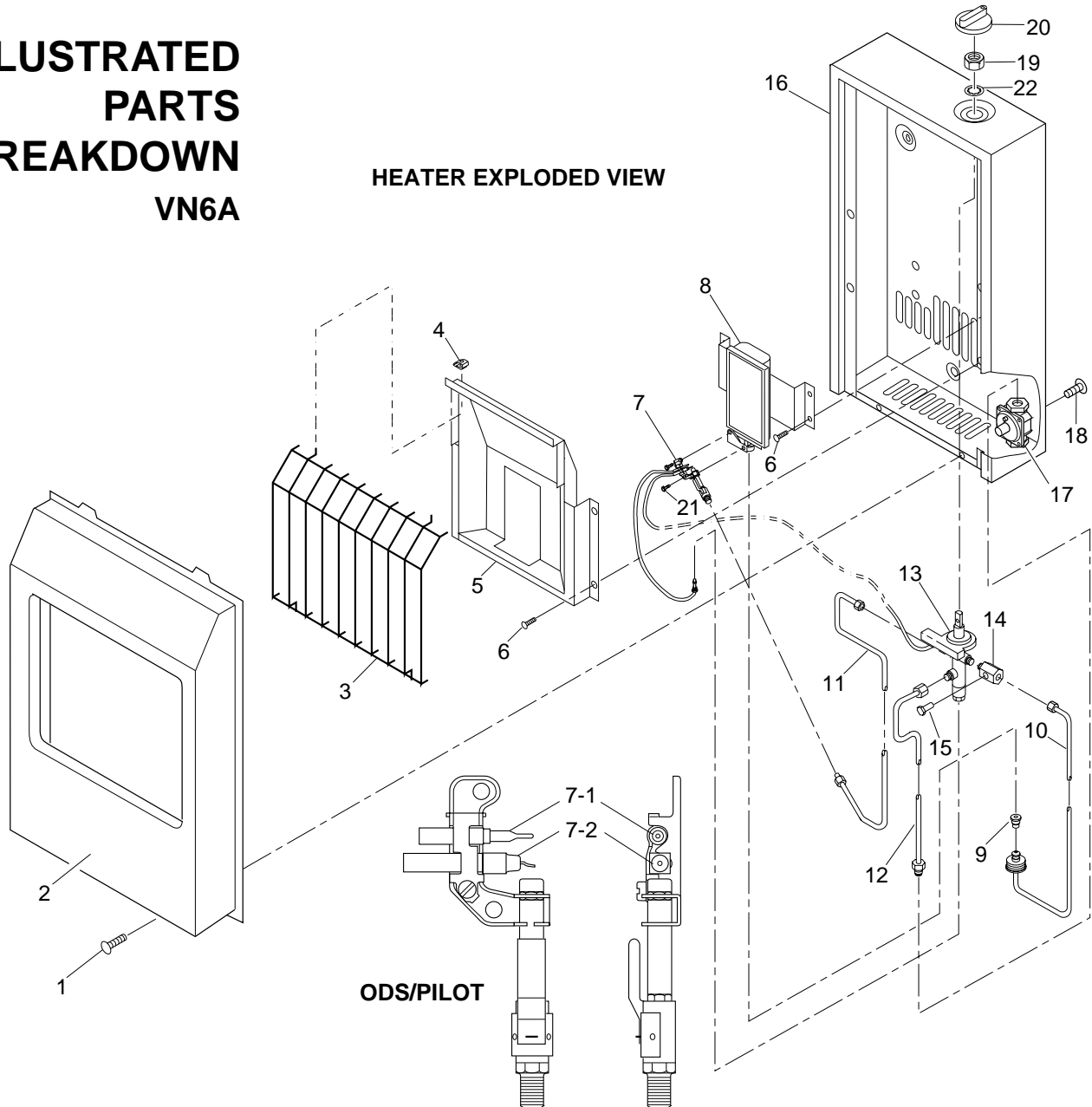

# PARTS LIST VN12

This list contains replaceable parts used in your heater. When ordering parts, follow the instructions listed under REPLACEMENT PARTS on page 21 of this manual.

KEY NO.	PART NUMBER	DESCRIPTION	QTY.	KEY NO.	PART NUMBER	DESCRIPTION	QTY.
1	098304-01	Screw, #10 x 3/8"	2	13	099391-02	Tubing - Regulator to valve	1
2	099467-01	Front Panel Assembly	1	14	099385-01	Control Valve	1
3	099318-01	Grill Guard	1	15	099057-01	Pressure Tap Fitting	1
4	098342-01	Grill Guard Clip	2	16	098276-01	1/8 Pipe Plug	1
5	099469-02	Reflector Assembly	1	17	099468-02	Cabinet Assembly	1
6	M15823-37	Screw Hex #8 x 1/4"	10	18	099415-01	Gas Regulator	1
7	503329	ODS/Pilot Assembly	1	19	098303-02	Screw, #6 x 5/16"	2
7-1	098514-01	Thermocouple	1	20	098508-01	Valve Retainer Nut	1
7-2	098594-01	Ignitor Electrode	1	21	099393-01	Control Knob	1
8	099884-02	Burner Assembly	1	22	M11084-26	Screw, #10 x 3/8"	2
9	099056-04	Injector	2	23	099818-01	Internal Tooth Washer	1
10	099390-02	Tubing - Valve to plaque A	1	<b>PARTS AVAILABLE - NOT SHOWN</b>			
11	099387-05	Pilot Tubing - Valve to pilot	1		099395-02	Control Position Label	1
12	099392-01	Tubing - Valve to plaque B	1				

## ILLUSTRATED PARTS BREAKDOWN VN12

HEATER EXPLODED VIEW

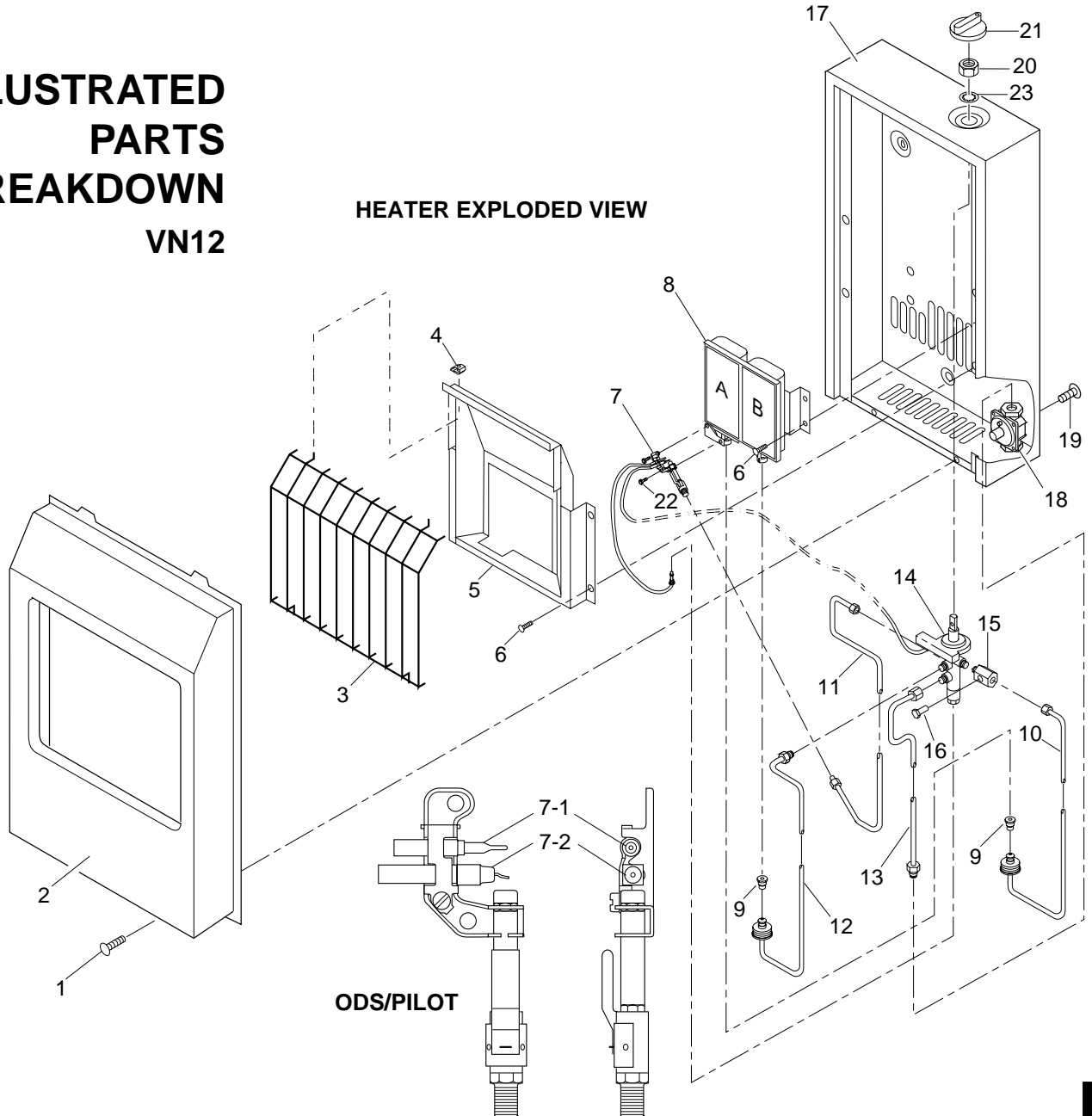

# WARRANTY INFORMATION

## KEEP THIS WARRANTY

Model \_\_\_\_\_

Serial No. \_\_\_\_\_

Date Purchased \_\_\_\_\_

Always specify model and serial numbers when communicating with the factory.

We reserve the right to amend these specifications at any time without notice. The only warranty applicable is our standard written warranty. We make no other warranty, expressed or implied.

### LIMITED WARRANTY VANGUARD VENT-FREE RESIDENTIAL GAS HEATERS

DESA International warrants this product and any parts thereof, to be free from defects in material and workmanship for two years from the date of first purchase, provided that the product has been properly installed, operated, and maintained in accordance with all applicable instructions. To make a claim under this warranty, the bill of sales or proof of purchase must be presented.

This warranty is extended only to the original retail purchaser. This warranty covers only the cost of parts and labor required to restore this heater to proper operating condition. Warranty parts must be obtained through authorized dealers of this product and/or DESA International who will provide original factory replacement parts. Failure to use original factory replacement parts voids this warranty. The heater must be installed by a qualified installer in accordance with all local codes and instructions furnished with the unit.

This warranty does not apply to parts that are not in original condition because of normal wear and tear, or parts that fail or become damaged as a result of misuse, accidents, lack of proper maintenance, alteration, tampering, contaminated fuels, or defects caused by improper installation. Travel, transportation, and incidental costs associated with warranty repairs are not reimbursable under this warranty and are the responsibility of the owner.

To the full extent allowed by the law of the jurisdiction that governs the sale of the product: this express warranty excludes any and all other expressed warranties and limits the duration of any and all implied warranties, including warranties of merchantability and fitness for a particular purpose to two years from the date of first purchase: and DESA International's liability is hereby limited to the purchase price of the product and DESA International shall not be liable for any other damages whatsoever including indirect, incidental, or consequential damages.

Some states do not allow a limitation of how long an implied warranty lasts or an exclusion or limitation of incidental or consequential damages, so the above limitation of implied warranties, or exclusion, or limitation of damages may not apply to you.

This warranty provides the original retail purchaser with specific legal rights. For specific information regarding those rights, please consult the applicable state laws.

**DESA**  
**INTERNATIONAL**  
2701 Industrial Drive  
P.O. Box 90004  
Bowling Green, KY 42102-9004

099399-01  
REV. G  
5/94



## Free Manuals Download Website

<http://myh66.com>

<http://usermanuals.us>

<http://www.somanuals.com>

<http://www.4manuals.cc>

<http://www.manual-lib.com>

<http://www.404manual.com>

<http://www.luxmanual.com>

<http://aubethermostatmanual.com>

Golf course search by state

<http://golfingnear.com>

Email search by domain

<http://emailbydomain.com>

Auto manuals search

<http://auto.somanuals.com>

TV manuals search

<http://tv.somanuals.com>