

# VANGUARD<sup>®</sup>

## VENT-FREE NATURAL GAS HEATER OWNER'S OPERATION AND INSTALLATION MANUAL

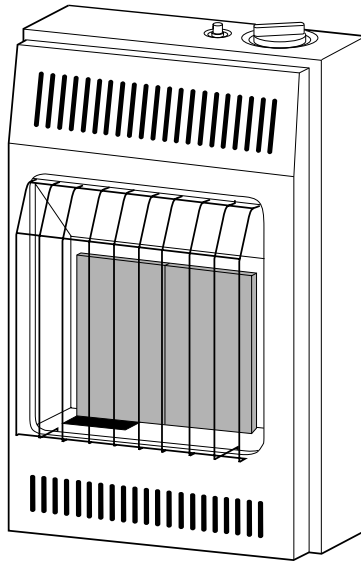

**Models: VN6B and VN12A**

**WARNING:** If the information in this manual is not followed exactly, a fire or explosion may result causing property damage, personal injury, or loss of life.

- Do not store or use gasoline or other flammable vapors and liquids in the vicinity of this or any other appliance.
- **WHAT TO DO IF YOU SMELL GAS**
  - Do not try to light any appliance.
  - Do not touch any electrical switch; do not use any phone in your building.
  - Immediately call your gas supplier from a neighbor's phone. Follow the gas supplier's instructions.
  - If you cannot reach your gas supplier, call the fire department.
- Installation and service must be performed by a qualified installer, service agency, or the gas supplier.

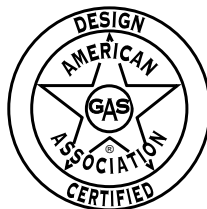

**Save this manual for future reference.**

# CONTENTS

| SECTION   | PAGE       |
|---|------------|
| Safety Information .....                        | 2          |
| Product Identification .....                    | 4          |
| Local Codes .....                               | 4          |
| Unpacking .....                                 | 4          |
| Product Features .....                          | 4          |
| Fresh Air For Combustion And Ventilation .....  | 5          |
| Installing To Wall .....                        | 9          |
| Connecting To Gas Supply .....                  | 13         |
| Checking Gas Connections .....                  | 14         |
| Operating Heater .....                          | 16         |
| Inspecting Burner .....                         | 19         |
| Cleaning And Maintenance .....                  | 20         |
| Troubleshooting .....                           | 21         |
| Technical Service .....                         | 24         |
| Specifications .....                            | 24         |
| Service Hints .....                             | 25         |
| Replacement Parts .....                         | 25         |
| Service Publications .....                      | 25         |
| Accessory .....                                 | 25         |
| Parts List (Model VN6B) .....                   | 26         |
| Illustrated Parts Breakdown (Model VN6B) .....  | 26         |
| Parts List (Model VN12A) .....                  | 27         |
| Illustrated Parts Breakdown (Model VN12A) ..... | 27         |
| Warranty Information .....                      | Back Cover |

# SAFETY INFORMATION

## WARNINGS

**IMPORTANT:** Read this Owner's Manual carefully and completely before trying to assemble, operate, or service this heater. Improper use of this heater can cause serious injury or death from burns, fire, explosion, and carbon monoxide poisoning.

## DANGER

**Carbon monoxide poisoning may lead to death!**

**Carbon Monoxide Poisoning:** Early signs of carbon monoxide poisoning resemble the flu, with headaches, dizziness, or nausea. If you have these signs, the heater may not be working properly. **Get fresh air at once!** Have heater serviced. Some people are more affected by carbon monoxide than others. These include pregnant women, persons with heart or lung disease or anemia, those under the influence of alcohol, and those at high altitudes.

**Natural Gas:** Natural gas is odorless. An odor-making agent is added to natural gas. The odor helps you detect a natural gas leak. However, the odor added to natural gas can fade. Natural gas may be present even though no odor exists.

Make certain you read and understand all Warnings. Keep this manual for reference. It is your guide to safe and proper operation of this heater.

*Safety Information continued on next page*

# SAFETY INFORMATION

*Continued*

## WARNINGS *Continued*

**WARNING:** Any change to this heater or its controls can be dangerous.

1. Use only natural gas. Do not convert heater to use different fuel type.
2. If you smell gas
  - shut off gas supply
  - do not try to light any appliance
  - do not touch any electrical switch; do not use any phone in your building
  - immediately call your gas supplier from a neighbor's phone. Follow the gas supplier's instructions
  - if you cannot reach your gas supplier, call the fire department
3. This heater shall not be installed in a bedroom or bathroom (VN12A - input 12,000 BTUs).
4. Never install the heater
  - in a recreational vehicle
  - where curtains, furniture, clothing, or other flammable objects are less than 36 inches from the front, top, or sides of the heater
  - as a fireplace insert
  - in high traffic areas
  - in windy or drafty areas
5. Always run heater with control knob at LOW or HIGH locked positions (VN12A) or ON position (VN6B). Never set control knob between locked positions. Poor combustion and higher levels of carbon monoxide may result.
6. This heater needs fresh, outside air ventilation to run properly. This heater has an oxygen depletion sensor (ODS) pilot light safety system. The ODS shuts down the heater if not enough fresh air is available. See *Fresh Air for Combustion and Ventilation*, pages 5 through 8.
7. Never run heater in small, closed room. Open door into next room to help ventilate.
8. Keep all air openings in front and bottom of heater clear and free of debris. This will insure enough air for proper combustion.
9. If heater shuts off, do not relight until you provide fresh, outside air. If heater keeps shutting off, have it serviced.
10. Do not run heater
  - where flammable liquids or vapors are used or stored
  - under dusty conditions
11. Never place any objects on the heater.
12. Surface of heater becomes very hot when running heater. Keep children and adults away from hot surface to avoid burns or clothing ignition. Heater will remain hot for a time after shut-down. Allow surface to cool before touching.
13. Carefully supervise young children when they are in same room with heater.
14. Make sure grill guard is in place before running heater.
15. Do not use heater if any part has been under water. Immediately call a qualified service technician to inspect the room heater and to replace any part of the control system and any gas control which has been under water.
16. Turn off heater and let cool before servicing. Only a qualified service person should service and repair heater.
17. Operating heater above elevations of 4,500 feet may cause pilot outage.

## PRODUCT IDENTIFICATION

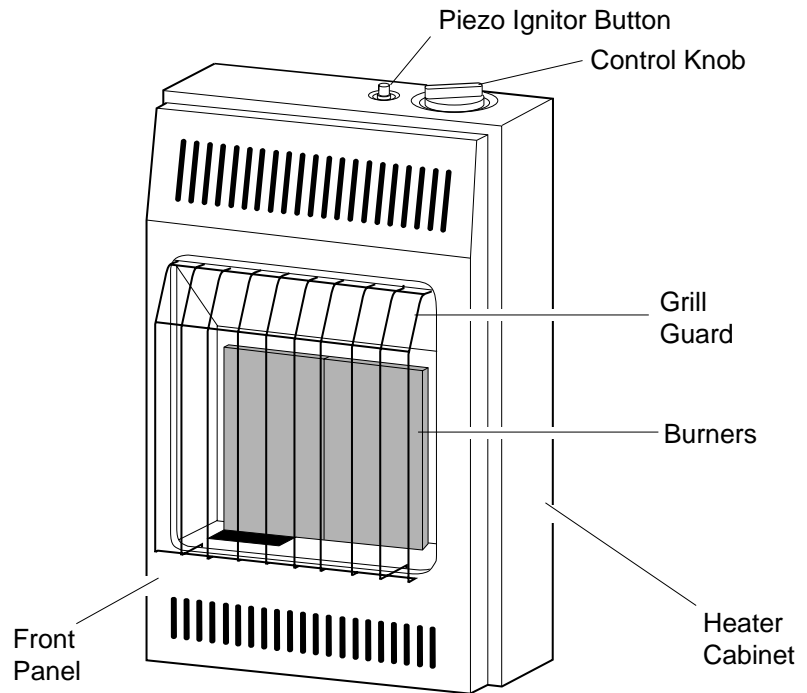

**Figure 1 - Vent-Free Natural Gas Heater (Model VN12A Shown)**

## LOCAL CODES

Install and use heater with care. Follow all local codes. In the absence of local codes, use the latest edition of National Fuel Gas Code ANSI Z223.1, also known as NFPA 54\*.

\*Available from:

American National Standards Institute, Inc.  
1430 Broadway  
New York, NY 10018

National Fire Protection Association, Inc.  
Batterymarch Park  
Quincy, MA 02269

## UNPACKING

1. Remove heater from carton.
2. Remove all protective packaging applied to heater for shipment.
3. Check heater for any shipping damage. If heater is damaged, promptly inform dealer where you bought heater.

## PRODUCT FEATURES

### Safety Device

This heater has a pilot with an Oxygen Depletion Sensor Shutoff System (ODS). The ODS/pilot is a required feature for vent-free room heaters. The ODS/pilot shuts off the heater if there is not enough fresh air.

### Piezo Ignition System

This heater has a piezo ignitor. This system requires no matches, batteries, or other sources to light heater.

# FRESH AIR FOR COMBUSTION AND VENTILATION

## WARNING

**This heater must have fresh air for proper operation. If not, poor fuel combustion could result. Read the following instructions to insure proper fresh air for this and other fuel-burning appliances in your home.**

Today's homes are built more energy efficient than ever. New materials, increased insulation, and new construction methods help reduce heat loss in homes. Home owners weather strip and caulk around windows and doors to keep the cold air out and the warm air in. During heating months, home owners want their homes as airtight as possible.

While it is good to make your home energy efficient, your home needs to breathe. Fresh air must enter your home. All fuel-burning appliances need fresh air for proper combustion and ventilation.

Exhaust fans, fireplaces, clothes dryers, and fuel burning appliances draw air from the house to operate. You must provide adequate fresh air for these appliances. This will insure proper venting of vented fuel-burning appliances.

### PRODUCING ADEQUATE VENTILATION

All spaces in homes fall into one of the three following ventilation classifications:

1. Unusually Tight Construction; 2. Unconfined Space; 3. Confined Space.

The information on pages 5 through 8 will help you classify your space and provide adequate ventilation.

#### Unusually Tight Construction

The air that leaks around doors and windows may provide enough fresh air for combustion and ventilation. However, in buildings of unusually tight construction, you must provide additional fresh air.

**Unusually tight construction is defined as construction where:**

- a. walls and ceilings exposed to the outside atmosphere have a continuous water vapor retarder with a rating of one perm or less with openings gasketed or sealed *and*
- b. weather stripping has been added on openable windows and doors *and*
- c. caulking or sealants are applied to areas such as joints around window and door frames, between sole plates and floors, between wall-ceiling joints, between wall panels, at penetrations for plumbing, electrical, and gas lines, and at other openings.

**If your home meets all of the three criteria above, you must provide additional fresh air. See *Ventilation Air From Outdoors*, page 8.**

**If your home does not meet all of the three criteria above, continue reading.**

#### Unconfined Space

An unconfined space has a minimum air volume of 50 cubic feet for each 1000 BTU/Hr input rating of all appliances in the space (cubic feet equals length x width x height of space). Include adjoining rooms only if there are doorless passageways or ventilation grills between the rooms.

#### Confined Space

A confined space has an air volume of less than 50 cubic feet for each 1000 BTU/Hr input rating of all appliances in the space (cubic feet equals length x width x height of space). Include adjoining rooms only if there are doorless passageways or ventilation grills between the rooms.

*Continued*

# FRESH AIR FOR COMBUSTION AND VENTILATION

*Continued*

## DETERMINING FRESH-AIR FLOW FOR HEATER LOCATION

### Determining if You Have a Confined or Unconfined Space

Use this worksheet to determine if you have a confined or unconfined space.

**Space:** Includes the room in which you will install heater plus any adjoining rooms with doorless passageways or ventilation grills between the rooms.

1. Determine the volume of the space (length x width x height).

Length x Width x Height = \_\_\_\_\_ cu. ft. (volume of space)

*Example:* Space size 18 ft. (length) x 16 ft. (width) x 8 ft. (ceiling height) =  
2304 cu. ft. (volume of space)

If additional ventilation to adjoining room is supplied with grills or openings, add the volume of these rooms to the total volume of the space.

2. Divide the space volume by 50 cubic feet to determine the maximum BTU/Hr the space can support.

\_\_\_\_\_ (volume of space) ÷ 50 cu. ft. = (Maximum BTU/Hr  
the space can support)

*Example:* 2304 cu. ft. (volume of space) ÷ 50 cu. ft. = 46.1 or 46,100 (maximum  
BTU/Hr the space can support)

3. Add the BTU/Hr of all fuel burning appliances in the space.

|                       |         |        |
|-----------------------|---------|--------|
| Vent-free heater      | _____   | BTU/Hr |
| Gas water heater*     | _____   | BTU/Hr |
| Gas furnace           | _____   | BTU/Hr |
| Vented gas heater     | _____   | BTU/Hr |
| Gas fireplace logs    | _____   | BTU/Hr |
| Other gas appliances* | + _____ | BTU/Hr |
| Total                 | = _____ | BTU/Hr |

*Example:*

|                  |   |        |        |
|------------------|---|--------|--------|
| Gas water heater |   | 40,000 | BTU/Hr |
| Vent-free heater | + | 10,000 | BTU/Hr |
| Total            | = | 50,000 | BTU/Hr |

\* Do not include direct-vent gas appliances. Direct-vent draws combustion air from the outdoors and vents to the outdoors.

4. Compare the maximum BTU/Hr the space can support with the actual amount of BTU/Hr used.

\_\_\_\_\_ BTU/Hr (maximum the space can support)  
\_\_\_\_\_ BTU/Hr (actual amount of BTU/Hr used)

*Example:* 46,100 BTU/Hr (maximum the space can support)  
50,000 BTU/Hr (actual amount of BTU/Hr used)

The space in the above example is a confined space because the actual BTU/Hr used is more than the maximum BTU/Hr the space can support. You must provide additional fresh air. Your options are as follows:

- A. Rework worksheet, adding the space of an adjoining room. If the extra space provides an unconfined space, remove door to adjoining room or add ventilation grills between rooms. See *Ventilation Air From Inside Building*, page 7.
- B. Vent room directly to the outdoors. See *Ventilation Air From Outdoors*, page 8.
- C. Install a lower BTU/Hr heater, if lower BTU/Hr size makes room unconfined.

If the actual BTU/Hr used is less than the maximum BTU/Hr the space can support, the space is an unconfined space. You will need no additional fresh air ventilation.



**WARNING**

**You must provide additional ventilation air in a confined space.**

# FRESH AIR FOR COMBUSTION AND VENTILATION

*Continued*

## VENTILATION AIR

### Ventilation Air From Inside Building

This fresh air would come from an adjoining unconfined space. When ventilating to an adjoining unconfined space, you must provide two permanent openings: one within 12" of the ceiling and one within 12" of the floor on the wall connecting the two spaces (see options 1 and 2, Figure 2). You can also remove door into adjoining room (see option 3, Figure 2).

### WARNING

**Rework worksheet, adding the space of the adjoining unconfined space. The combined spaces must have enough fresh air to supply all appliances in both spaces.**

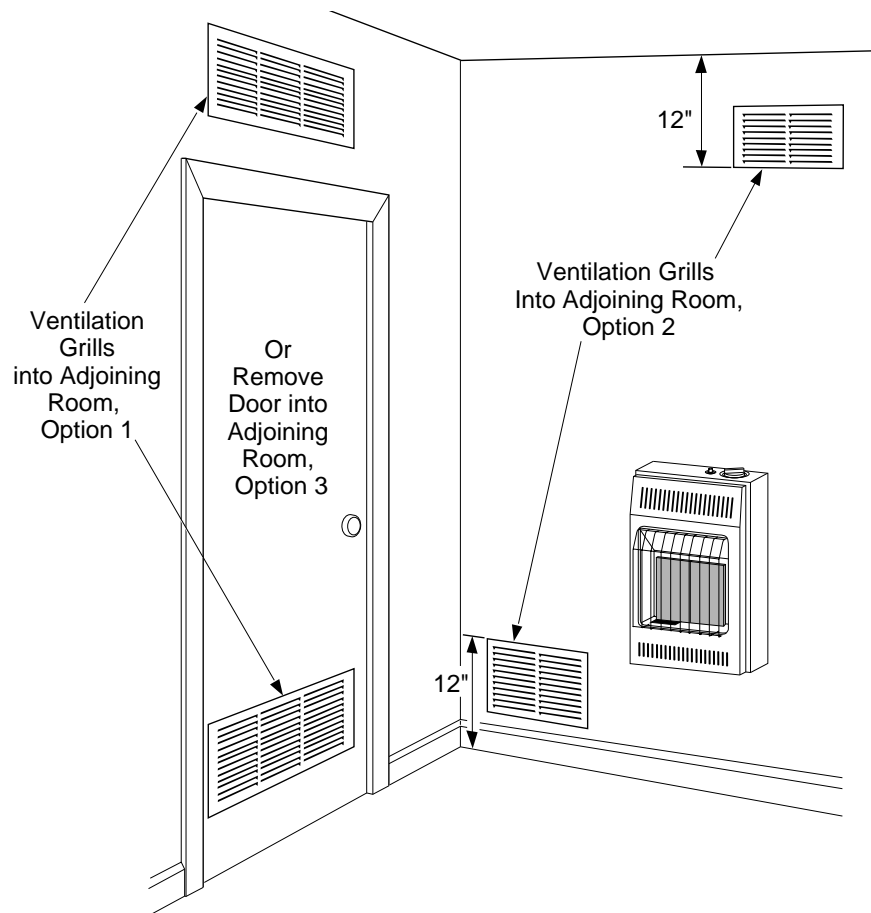

**Figure 2 - Ventilation Air from Inside Building**

*Continued*

# FRESH AIR FOR COMBUSTION AND VENTILATION

*Continued*

## VENTILATION AIR *(Continued)*

### Ventilation Air From Outdoors

Provide extra fresh air by using ventilation grills or ducts. You must provide two permanent openings: one within 12" of the ceiling and one within 12" of the floor. Connect these items directly to the outdoors or spaces open to the outdoors. These spaces include attics and crawl spaces. Follow the *National Fuel Gas Code NFPA 54/ANSI Z223.1, Section 5.3, Air for Combustion and Ventilation* for required size of ventilation grills or ducts.

**IMPORTANT:** Do not provide openings for inlet or outlet air into attic if attic has a thermostat-controlled power vent. Heated air entering the attic will activate the power vent.

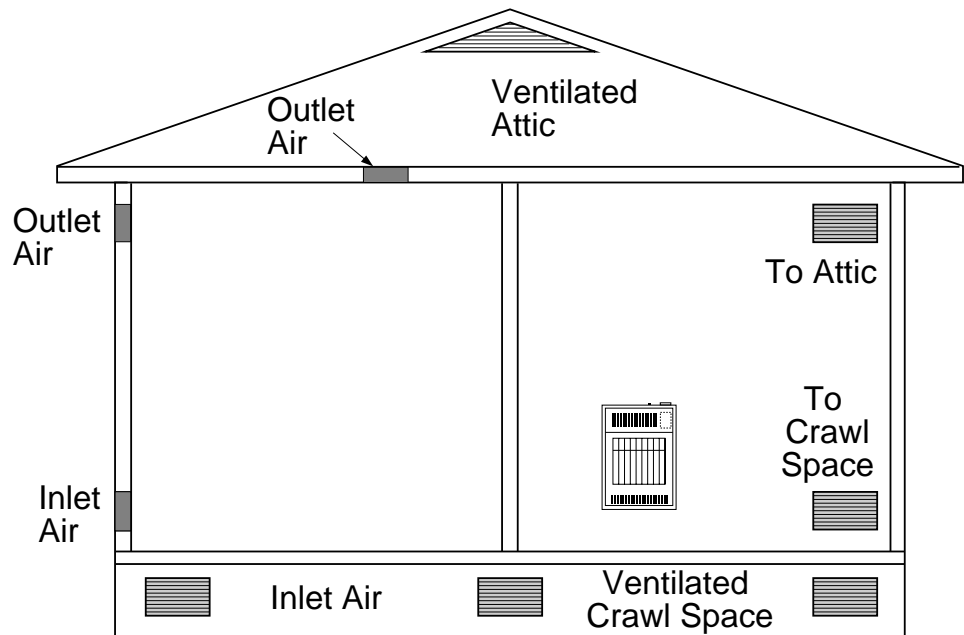

**Figure 3 - Ventilation Air from Outdoors**



# INSTALLING TO WALL

## NOTICE

**A qualified service person must install heater. Follow all local codes.**

### CHECK GAS TYPE

Use only natural gas. If your gas supply is not natural, do not install heater. Call dealer where you bought heater for proper type heater.

### INSTALLATION ITEMS

Before installing heater, make sure you have the items listed below.

- piping (check local codes)
- sealant (resistant to propane gas)
- manual shutoff valve \*
- ground joint union
- test gauge connection \* (see Figure 12, page 14)
- sediment trap
- tee joint
- pipe wrench

\* An A.G.A. design-certified manual shutoff valve with 1/8" NPT tap is an acceptable alternative to test gauge connection. Purchase the optional A.G.A. design-certified manual shutoff valve from your dealer. See *Accessory*, page 25.

### LOCATING HEATER

This heater is designed to be mounted on a wall.

## WARNING

**Maintain the minimum clearances shown in Figure 4 (page 10). If you can, provide greater clearances from floor, ceiling, and joining wall.**

## WARNING

**Never install the heater**

- in a bedroom or bathroom (VN12A)
- in a recreational vehicle
- where curtains, furniture, clothing, or other flammable objects are less than 36 inches from the front, top, or sides of the heater
- as a fireplace insert
- in high traffic areas
- in windy or drafty areas

## CAUTION

**This heater creates warm air currents. These currents move heat to wall surfaces next to heater. Installing heater next to vinyl or cloth wall coverings or operating heater where impurities in the air (such as tobacco smoke) exist, may discolor walls.**

*IMPORTANT:* Vent-free heaters add moisture to the air. Although this is beneficial, installing heater in rooms without enough ventilation air may cause mildew to form from too much moisture. See *Fresh Air for Combustion and Ventilation*, pages 5 through 8.

## CAUTION

**If you install the heater in a home garage**

- heater pilot and burner must be at least 18 inches above floor
- locate heater where moving vehicle will not hit it

*Continued*

# INSTALLING TO WALL

Continued

For convenience and efficiency, install heater

- where there is easy access for operation, inspection, and service
- in coldest part of room

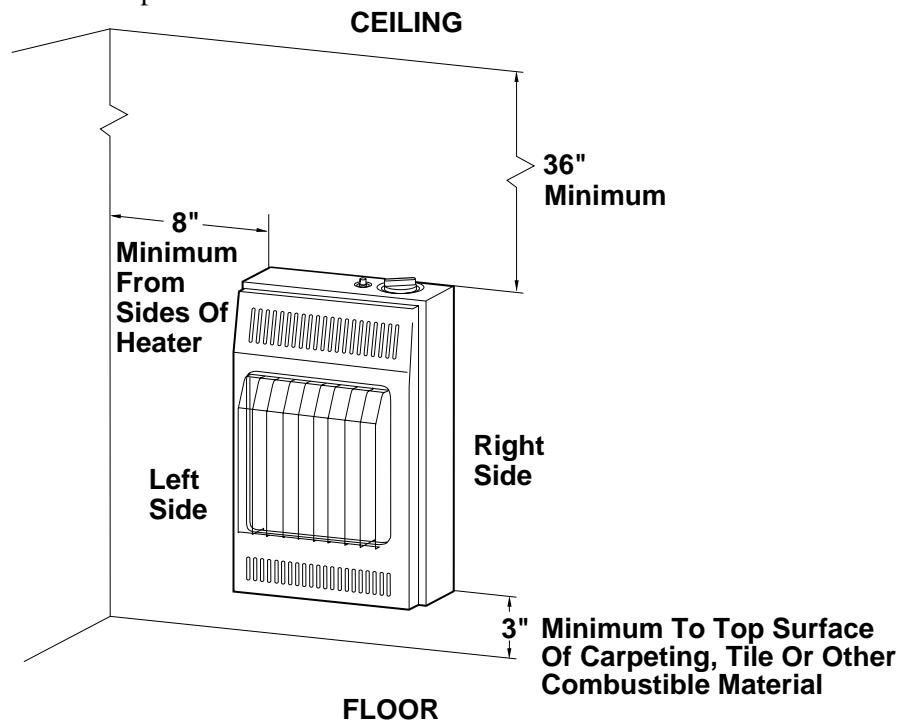

Figure 4 - Mounting Clearances As Viewed From Front of Heater

## INSTALLING HEATER TO WALL

### Marking Screw Locations

1. Determine where you will locate heater.

### ⚠ WARNING

Maintain minimum clearances shown in Figure 5. If you can, provide greater clearances from floor and joining wall.

2. Mark two mounting screw locations on wall (see Figure 5).

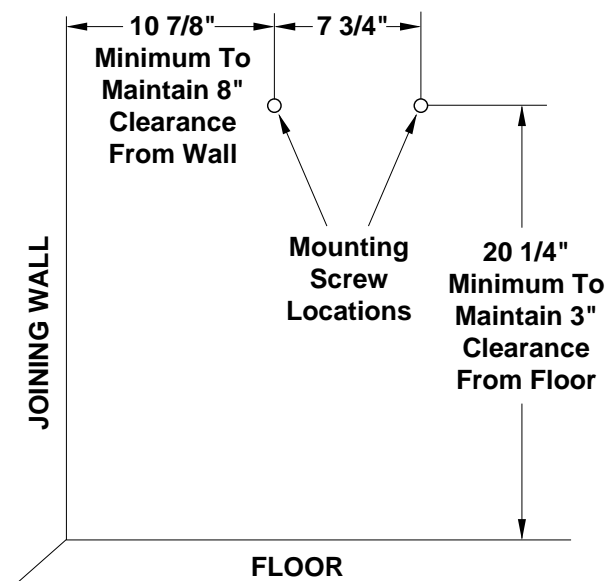

Figure 5 - Mounting Screw Locations

# INSTALLING TO WALL

*Continued*

## Installing Two Mounting Screws

*Note:* Wall anchors and mounting screws are in hardware package. The hardware package is provided with heater.

### Attaching to wall stud method

For attaching mounting screw to wall stud

1. Drill hole at marked location using 9/64" drill bit.
2. Insert mounting screw into wall stud.
3. Tighten screw until 1/16" space (thickness of penny) is between screwhead and wall.

### Attaching to wall anchor method

Follow instructions below to attach mounting screws to hollow walls (wall areas between studs) or solid walls (concrete or masonry).

1. Drill holes at marked locations using 5/16" drill bit. For solid walls (concrete or masonry), drill at least 1 1/4" deep.
2. Fold wall anchor (see Figure 6).

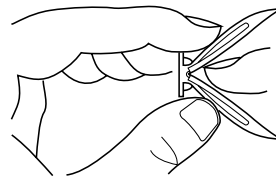

**Figure 6 - Folding Anchor**

3. Insert wall anchor (wings first) into hole. Tap anchor flush to wall.
4. For thin walls (1/2" or less), insert red key into wall anchor. Push red key to "pop" open anchor wings (see Figure 7). *IMPORTANT:* Do not hammer key! For thick walls (over 1/2" thick) or solid walls, do not pop open wings.

Thin Walls  
(1/4" to 1/2" thick)

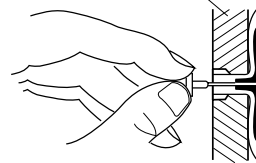

**Figure 7 - Popping Open Anchor Wings For Thin Walls**

5. Tighten two screws until 1/16" space (thickness of penny) is between screwheads and wall (see Figure 8).

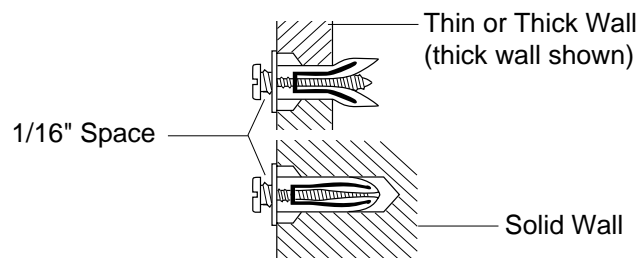

**Figure 8 - Tightening Anchors**

*Continued*

# INSTALLING TO WALL

*Continued*

## Placing Heater On Mounting Screws

1. Locate two keyhole slots on back panel of heater (see Figure 9).
2. Place large openings of slots over screwheads. Slide heater down until screws are in small portion of slots.

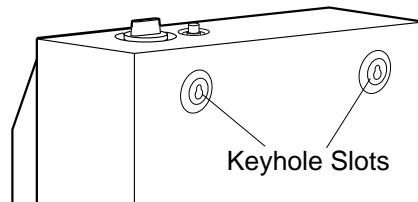

**Figure 9 - Location Of Keyhole Slots On Back Panel Of Heater**

## Removing Front Panel Of Heater

1. Remove two screws near bottom corners of front panel.
2. Lift straight up on grill guard until it stops. Grill guard will slide up about 1/4".
3. Pull bottom of front panel forward, then down.

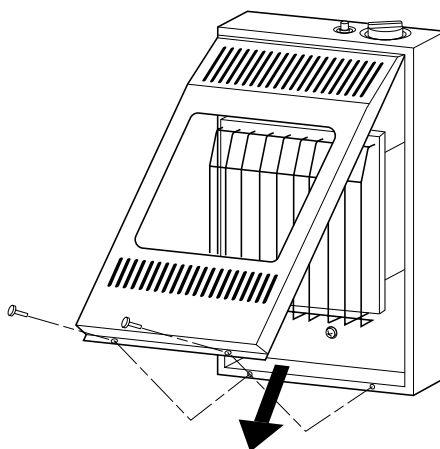

**Figure 10 - Removing Front Panel Of Heater**

## Installing Bottom Mounting Screw

1. Locate bottom mounting hole. This hole is near bottom on back panel of heater (see Figure 11).
2. Mark screw location on wall.
3. Remove heater from wall.
4. If installing bottom mounting screw into hollow or solid wall, install wall anchor. Follow steps 1 through 5 under *Attaching To Wall Anchor Method*, page 11. If installing bottom mounting screw into wall stud, drill hole at marked location using 9/64" drill bit.
5. Replace heater on wall.
6. Insert bottom anchor screw through back panel into bottom anchor or drilled hole (see Figure 11).
7. Tighten screw until heater is firmly secured to wall. Do not over tighten.  
*Note:* Do not replace front panel at this time. Replace front panel after making gas connections and checking for leaks (see pages 13-15).

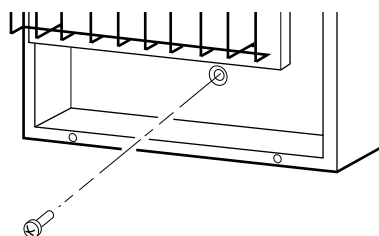

**Figure 11 - Installing Bottom Mounting Screw**

# CONNECTING TO GAS SUPPLY

## NOTICE

**A qualified service person must connect heater to gas supply. Follow all local codes.**

## WARNING

**Never connect heater to private (non-utility) gas wells. This gas is commonly known as well-head gas.**

*IMPORTANT:* Check gas line pressure before connecting heater to gas line. Gas line pressure must be no greater than 14 inches of water. If gas line pressure is higher, heater regulator damage could occur.

## CAUTION

**Use only new, black iron or steel pipe. Internally-tinned copper tubing may be used in certain areas. Check your local codes. Use pipe 3/8" diameter or greater to allow proper gas volume to heater. If pipe is too small, undue loss of pressure will occur.**

Installation must include a manual shutoff valve, ground joint union, and plugged 1/8" NPT tap. Locate NPT tap within reach for test gauge hook up. NPT tap must be upstream from heater (see Figure 12, page 14).

Apply pipe joint sealant lightly to male threads. This will prevent excess sealant from going into pipe. Excess sealant in pipe could result in clogged heater valves.

## CAUTION

**Use pipe joint sealant that is resistant to liquid petroleum (LP) gas.**

Install sediment trap in supply line as shown in Figure 12, page 14. Locate sediment trap where it is within reach for cleaning. Locate sediment trap where trapped matter is not likely to freeze. A sediment trap traps moisture and contaminants. This keeps them from going into heater controls. If sediment trap is not installed or is installed wrong, heater may not run properly.

*Continued*

# CONNECTING TO GAS SUPPLY

Continued

**IMPORTANT:** Hold pressure regulator with wrench when connecting it to gas piping and/or fittings.

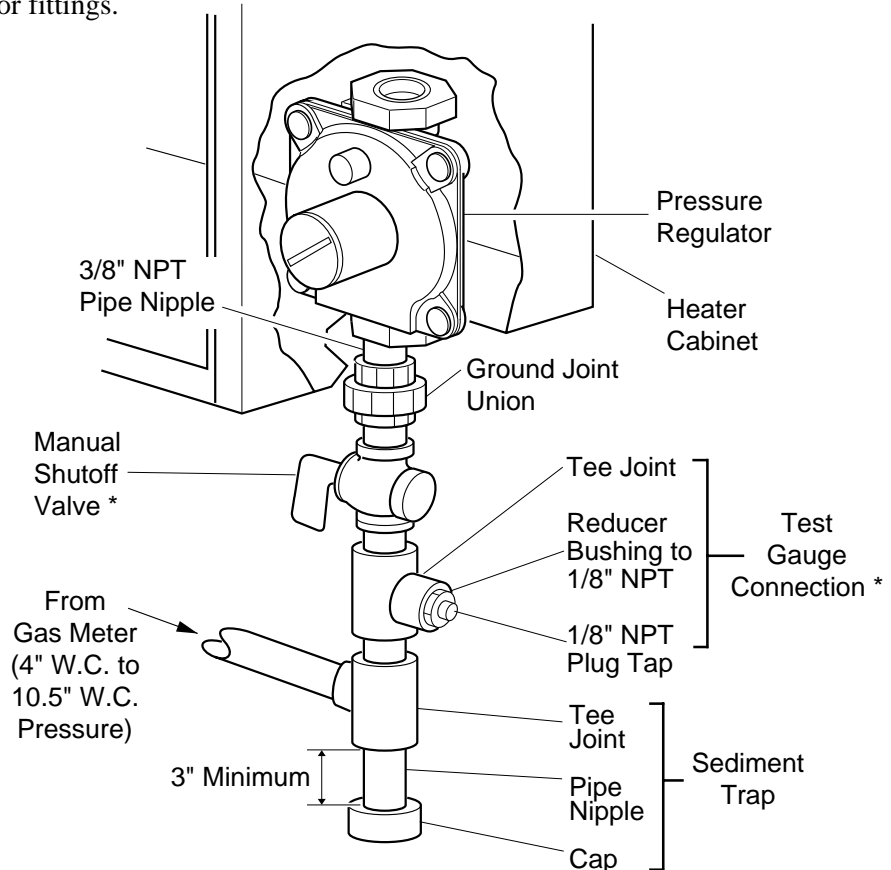

Figure 12 - Gas Connection

\* An A.G.A. design-certified manual shutoff valve with 1/8" NPT tap is an acceptable alternative to test gauge connection. Purchase the optional A.G.A. design-certified manual shutoff valve from your dealer. See *Accessory*, page 25.

# CHECKING GAS CONNECTIONS

## ⚠ WARNING

Test all gas piping and connections for leaks after installing or servicing. Correct all leaks at once.

## ⚠ WARNING

Never use an open flame to check for a leak. Apply a mixture of liquid soap and water to all joints. Bubbles forming show a leak. Correct all leaks at once.

## PRESSURE TESTING GAS SUPPLY PIPING SYSTEM

### Test Pressures In Excess Of 1/2 PSIG

1. Disconnect heater and its individual manual shutoff valve from gas supply piping system. Pressures in excess of 1/2 PSIG will damage heater regulator.
2. Cap off open end of gas pipe where manual shutoff valve was connected.
3. Pressurize supply piping system by either using compressed air or opening main gas valve located on or near gas meter.

# CHECKING GAS CONNECTIONS

*Continued*

4. Check all joints of gas supply piping system. Apply mixture of liquid soap and water to gas joints. Bubbles forming show a leak.
5. Correct all leaks at once.

## Test Pressures Equal To or Less Than 1/2 PSIG

1. Close manual shutoff valve (see Figure 13).
2. Pressurize supply piping system by either using compressed air or opening main gas valve located on or near gas meter.
3. Check all joints from gas meter to manual shutoff valve (see Figure 14). Apply mixture of liquid soap and water to gas joints. Bubbles forming show a leak.
4. Correct all leaks at once.

## PRESSURE TESTING HEATER GAS CONNECTIONS

1. Open manual shutoff valve (see Figure 13).
2. Open main gas valve located on or near gas meter.
3. Make sure control knob of heater is in the OFF position.
4. Check all joints from manual shutoff valve to control valve (see Figure 14). Apply mixture of liquid soap and water to gas joints. Bubbles forming show a leak.
5. Correct all leaks at once.
6. Light heater (see *Operating Heater*, pages 16 through 19). Check all other internal joints for leaks.
7. Turn off heater (see *To Turn Off Gas to Appliance*, page 19).
8. Replace front panel.

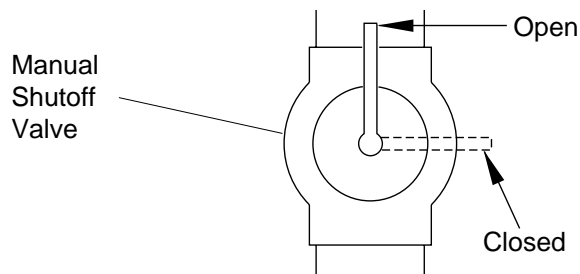

**Figure 13 - Manual Shutoff Valve**

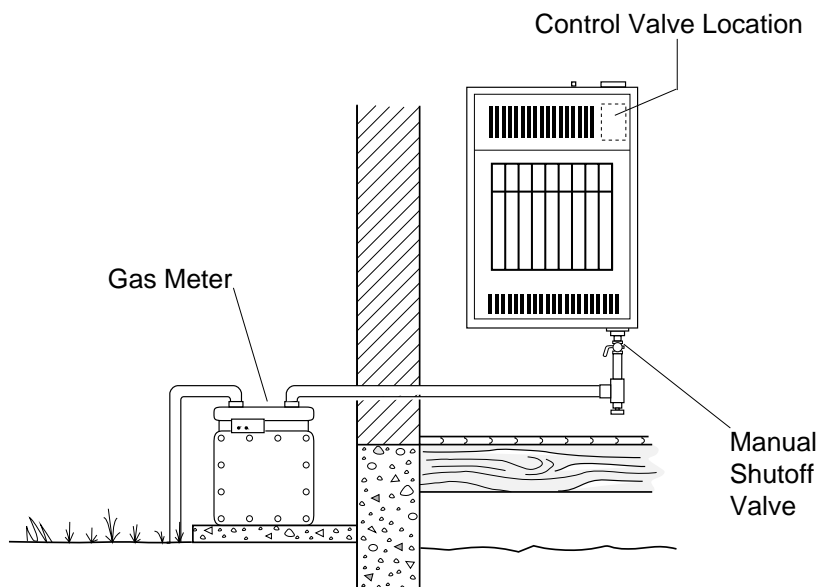

**Figure 14 - Checking Gas Joints**

# OPERATING HEATER

## FOR YOUR SAFETY READ BEFORE LIGHTING

### WARNING

If you do not follow these instructions exactly, a fire or explosion may result causing property damage, personal injury or loss of life.

- A. This appliance has a pilot which must be lighted by hand. When lighting the pilot, follow these instructions exactly.
- B. **BEFORE LIGHTING** smell all around the appliance area for gas. Be sure to smell next to the floor because some gas is heavier than air and will settle on the floor.

#### WHAT TO DO IF YOU SMELL GAS

- Do not try to light any appliance.
  - Do not touch any electric switch; do not use any phone in your building.
  - Immediately call your gas supplier from a neighbor's phone. Follow the gas supplier's instructions.
  - If you cannot reach your gas supplier, call the fire department.
- C. Use only your hand to push in or turn the gas control knob. Never use tools. If the knob will not push in or turn by hand, don't try to repair it, call a qualified service technician or gas supplier. Force or attempted repair may result in a fire or explosion.
  - D. Do not use this appliance if any part has been under water. Immediately call a qualified service technician to inspect the appliance and to replace any part of the control system and any gas control which has been under water.

## LIGHTING INSTRUCTIONS

1. **STOP!** Read the safety information above.
2. Make sure manual shutoff valve is fully open.
3. Turn control knob clockwise  to the OFF position.

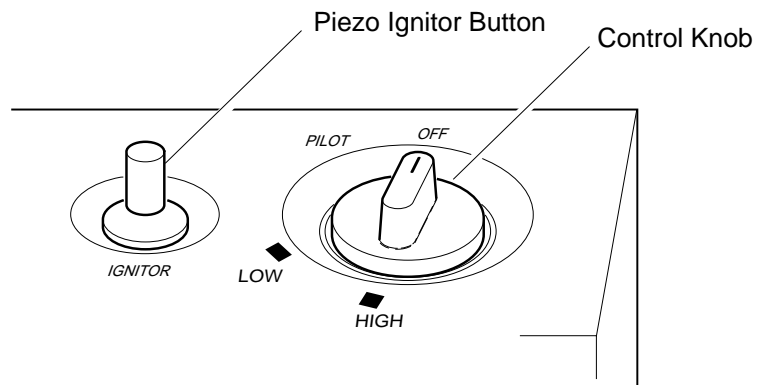

Figure 15 - Control Knob In The OFF Position (Model VN12A Shown)



# OPERATING HEATER

*Continued*

4. Wait five (5) minutes to clear out any gas. Then smell for gas, including near the floor. If you smell gas, **STOP!** Follow “B” in the safety information at the top of page 16. If you don’t smell gas, go to the next step.

5. Press in control knob, and turn counterclockwise ↶ to pilot position. Keep control knob pressed for five seconds.

**Note:** You may be running this heater for the first time after hooking up to gas supply. If so, the control knob may need to be pressed in for 30 seconds. This will allow air to bleed from the gas system.

- If control knob does not pop up when released, contact a qualified service person or gas supplier for repairs.

6. With control knob pressed in, push down and release ignitor button. This will light pilot. The pilot is attached to the front of burner. If needed, keep pressing ignitor button until pilot lights.

**Note:** If pilot does not light, refer to *Troubleshooting*, pages 21 through 24. Also contact a qualified service person or gas supplier for repairs. Until repairs are made, light pilot with match. To light pilot with match, see *Manual Lighting Procedure*, page 19.

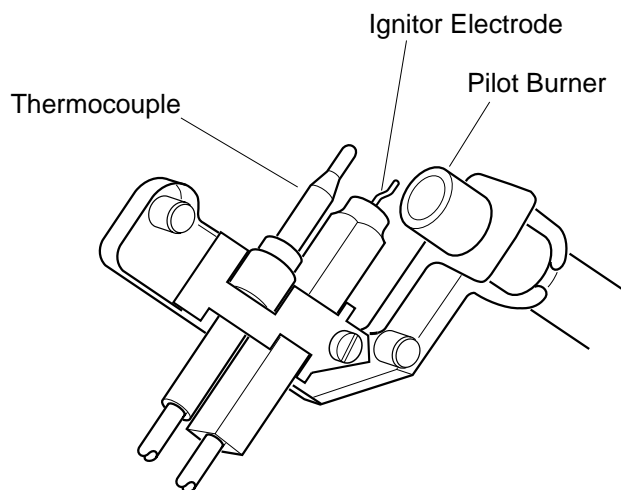

**Figure 16 - Pilot**

7. Keep control knob pressed in for 10 seconds after lighting pilot. After 10 seconds, release control knob.

**Note:** If pilot goes out, repeat steps 3 through 7.

*Continued*

# OPERATING HEATER

*Continued*

## TO SELECT HEATING LEVEL

### WARNING

When running heater, set control knob at **LOW** or **HIGH** locked positions (VN12A) or **ON** position (VN6B). Never set control knob between locked positions. Poor combustion and higher levels of carbon monoxide may result.

### CAUTION

Do not try to adjust heating levels by using the manual shutoff valve.

1. Slightly press in control knob and turn counterclockwise  to the **LOW** or **HIGH** positions (VN12A) or **ON** position (VN6B). **IMPORTANT:** Release downward pressure while turning control knob. Control knob will lock at the desired position.

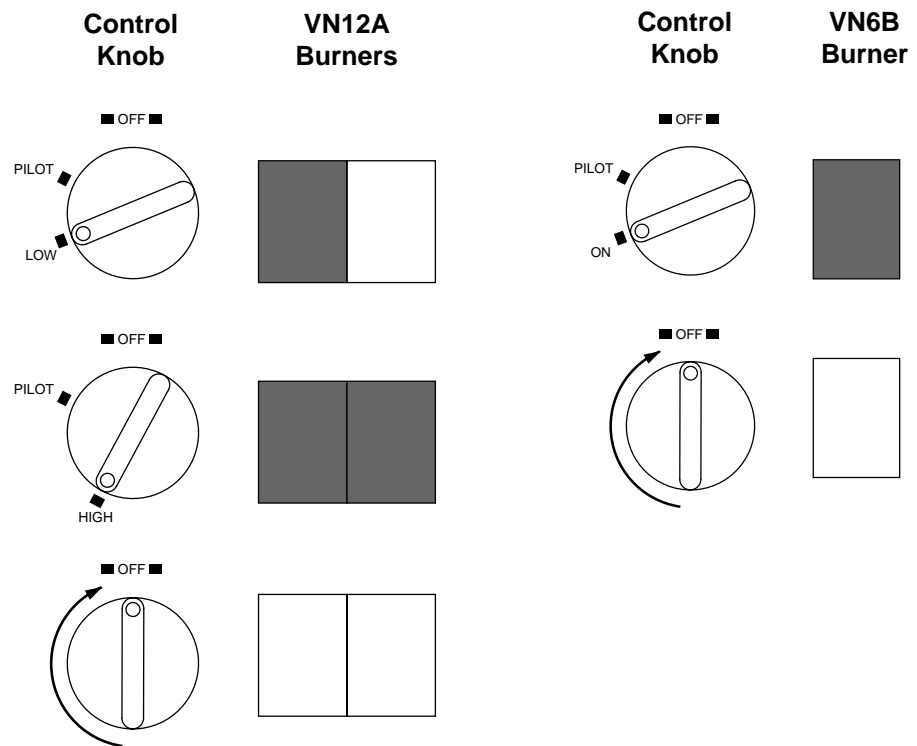

**Figure 17 - Burner Patterns**

# OPERATING HEATER

*Continued*

# INSPECTING BURNER

## TO TURN OFF GAS TO APPLIANCE

### Shutting Off Heater

1. Turn control knob clockwise  to the OFF position.

### Shutting Off Burner Only (pilot stays lit)

1. Turn control knob clockwise  to the PILOT position.

## MANUAL LIGHTING PROCEDURE

1. Remove front panel (see Figure 10, page 12).
2. Follow steps 1 through 5 under *Lighting Instructions*, pages 16 and 17.
3. With control knob pressed in, strike match. Hold match to pilot until pilot lights.
4. Keep control knob pressed in for 10 seconds after pilot is lit. After 10 seconds, release control knob.
5. Replace front panel.

Check pilot flame pattern and burner flame pattern often.

### PILOT FLAME PATTERN

Figure 18 shows a correct pilot flame pattern. Figure 19 shows an incorrect pilot flame pattern. The incorrect pilot flame is not touching the thermocouple. This will cause the thermocouple to cool. When the thermocouple cools, the heater will shut down.

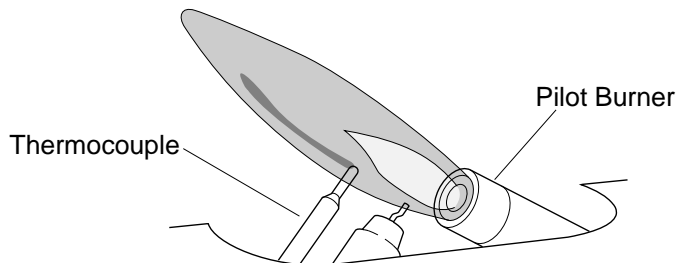

**Figure 18 - Correct Pilot Flame Pattern**

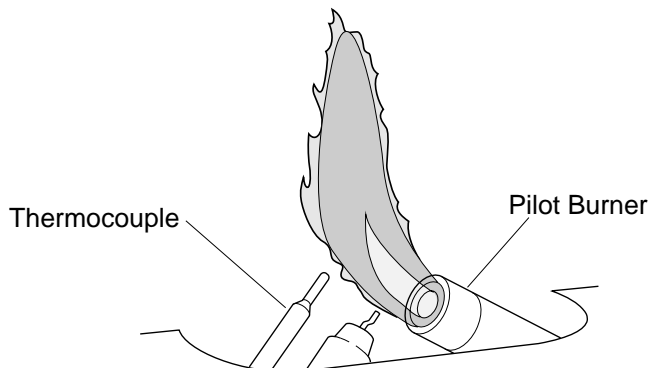

**Figure 19 - Incorrect Pilot Flame Pattern**

If pilot flame pattern is incorrect, as shown in Figure 19

- turn heater off (see *To Turn Off Gas to Appliance*, above)
- see *Troubleshooting*, pages 21 through 24

*Continued*

# INSPECTING BURNER

*Continued*

## BURNER FLAME PATTERN

Figure 20 shows a correct burner flame pattern. Figure 21 shows an incorrect burner flame pattern.

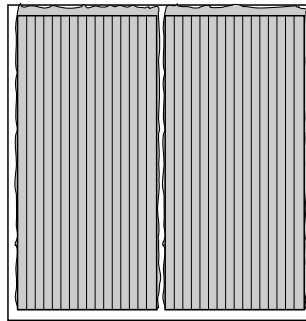

**Figure 20 - Correct Burner Flame Pattern (Model VN12A Shown)**

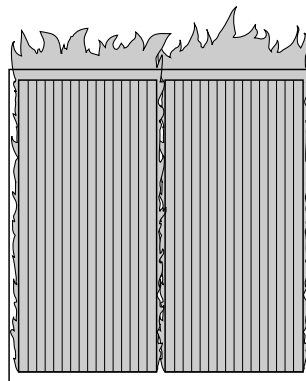

**Figure 21 - Incorrect Burner Flame Pattern (Model VN12A Shown)**

If burner flame pattern is incorrect, as shown in Figure 21

- turn heater off (see *To Turn Off Gas to Appliance*, page 19)
- see *Troubleshooting*, pages 21 through 24

# CLEANING AND MAINTENANCE

## WARNING

Turn off heater and let cool before cleaning.

## CAUTION

You must keep control areas, burner, and circulating air passageways of heater clean. Inspect these areas of heater before each use. Have heater inspected yearly by a qualified service person. Heater may need more frequent cleaning due to excessive lint from carpeting, bedding material, etc.

## ODS/PILOT AND BURNER ORIFICE

- Use a vacuum cleaner, pressurized air, or small, soft bristled brush to clean.

## CABINET

### Air Passageways

- Use a vacuum cleaner or pressurized air to clean.

### Exterior

- Use a soft cloth dampened with a mild soap and water mixture. Wipe the cabinet to remove dust.

# TROUBLE-SHOOTING

*Note:* All troubleshooting items are listed in order of operation.

## WARNING

Turn off heater and let cool before servicing. Only a qualified service person should service and repair heater.

## CAUTION

Never use a wire, needle, or similar object to clean ODS/pilot. This can damage ODS/pilot unit.

| OBSERVED PROBLEM  | POSSIBLE CAUSE  | REMEDY   |
|---|---|--|
| When ignitor button is pressed and control knob is pressed in and turned to the PILOT position, there is no spark at ODS/pilot              | 1. Ignitor electrode positioned wrong                   | 1. Replace ignitor   |
|   | 2. Ignitor electrode broken                             | 2. Replace ignitor   |
|   | 3. Ignitor electrode not connected to ignitor cable     | 3. Reconnect ignitor cable   |
|   | 4. Ignitor cable pinched or wet                         | 4. Free ignitor cable if pinched by any metal or tubing. Keep ignitor cable dry                      |
|   | 5. Piezo ignitor nut is loose                           | 5. Tighten nut holding piezo ignitor to heater cabinet. Nut is located inside heater cabinet at top. |
|   | 6. Broken ignitor cable                                 | 6. Replace ignitor cable   |
|   | 7. Bad piezo ignitor                                    | 7. Replace control valve (piezo is part of control valve)  |
| When ignitor button is pressed and control knob is pressed in and turned to the PILOT position, there is spark at ODS/pilot but no ignition | 1. Gas supply turned off or manual shutoff valve closed | 1. Turn on gas supply or open manual shutoff valve   |
|   | 2. Control knob not in PILOT position                   | 2. Turn control knob to PILOT position   |
|   | 3. Control knob not pressed in while in PILOT position  | 3. Press in control knob while in PILOT position   |
|   | 4. Air in gas lines when installed                      | 4. Continue holding down control knob. Repeat igniting operation until air is removed                |
|   | 5. ODS/pilot is clogged                                 | 5. Clean ODS/pilot (see <i>Cleaning and Maintenance</i> , page 20) or replace ODS/pilot assembly     |
|   | 6. Gas regulator setting is not correct                 | 6. Replace gas regulator   |

*Continued*

# TROUBLE-SHOOTING

*Continued*

| OBSERVED PROBLEM  | POSSIBLE CAUSE   | REMEDY  |
|---|--|---|
| ODS/pilot lights but flame goes out when control knob is released | <ol style="list-style-type: none"> <li>Control knob not fully pressed in</li> <li>Control knob not pressed in long enough</li> <li>Manual shutoff valve not fully open</li> <li>Thermocouple connection loose at control valve</li> <li>Pilot flame not touching thermocouple, which allows thermocouple to cool, causing pilot flame to go out. This problem could be caused by one or both of the following:<br/>A) Low gas pressure<br/>B) Dirty or partially clogged ODS/pilot</li> <li>Thermocouple damaged</li> <li>Control valve damaged</li> </ol> | <ol style="list-style-type: none"> <li>Press in control knob fully</li> <li>After ODS/pilot lights, keep control knob pressed in 10 seconds</li> <li>Fully open manual shut-off valve</li> <li>Hand tighten until snug, then tighten 1/4 turn more</li> <li>A) Contact local natural gas company<br/><br/>B) Clean ODS/pilot (see <i>Cleaning and Maintenance</i>, page 20) or replace ODS/pilot assembly</li> <li>Replace thermocouple</li> <li>Replace control valve</li> </ol> |
| Burner(s) does not light after ODS/pilot is lit                   | <ol style="list-style-type: none"> <li>Burner orifice(s) is clogged</li> <li>Burner orifice(s) diameter is too small</li> <li>Inlet gas pressure is too low</li> </ol>   | <ol style="list-style-type: none"> <li>Clean burner orifice(s) (see <i>Cleaning and Maintenance</i>, page 20) or replace burner orifice(s)</li> <li>Replace burner orifice(s)</li> <li>Contact local natural gas company</li> </ol>   |
| Delayed ignition of burner(s)                                     | <ol style="list-style-type: none"> <li>Manifold pressure is too low</li> <li>Burner orifice(s) is clogged</li> </ol>   | <ol style="list-style-type: none"> <li>Contact local natural gas company</li> <li>Clean burner orifice(s) (see <i>Cleaning and Maintenance</i>, page 20) or replace burner orifice(s)</li> </ol>  |
| Burner backfiring during combustion                               | <ol style="list-style-type: none"> <li>Burner orifice(s) is clogged or damaged</li> <li>Burner damaged</li> <li>Gas regulator defective</li> </ol>   | <ol style="list-style-type: none"> <li>Clean burner orifice(s) (see <i>Cleaning and Maintenance</i>, page 20) or replace burner orifice(s)</li> <li>Replace burner</li> <li>Replace gas regulator</li> </ol>  |

# TROUBLE-SHOOTING

*Continued*

| OBSERVED PROBLEM  | POSSIBLE CAUSE  | REMEDY  |
|---|---|---|
| Burner plaque(s) does not glow  | <ol style="list-style-type: none"> <li>1. Plaque damaged</li> <li>2. Inlet gas pressure is too low</li> <li>3. Control knob set between locked positions</li> </ol> | <ol style="list-style-type: none"> <li>1. Replace burner</li> <li>2. Contact local natural gas company</li> <li>3. Turn control knob until it locks at desired setting</li> </ol> |
| Slight smoke or odor during initial operation                                 | <ol style="list-style-type: none"> <li>1. Residues from manufacturing processes</li> </ol>  | <ol style="list-style-type: none"> <li>1. Problem will stop after a few hours of operation</li> </ol>   |
| Heater produces a clicking/ticking noise just after burner is lit or shut off | <ol style="list-style-type: none"> <li>1. Metal expanding while heating or contracting while cooling</li> </ol>   | <ol style="list-style-type: none"> <li>1. This is common with most heaters. If noise is excessive, contact qualified service person</li> </ol>                                    |

## WARNING

### If you smell gas

- Shut off gas supply.
- Do not try to light any appliance.
- Do not touch any electrical switch; do not use any phone in your building.
- Immediately call your gas supplier from a neighbor's phone. Follow the gas supplier's instructions.
- If you cannot reach your gas supplier, call the fire department.

*IMPORTANT:* Operating heater where impurities in air exist may create odors. Cleaning supplies, paint, paint remover, cigarette smoke, cements and glues, new carpet or textiles, etc., create fumes. These fumes may mix with combustion air and create odors.

|  |  |   |
|--|--|---|
| Heater produces unwanted odors         | <ol style="list-style-type: none"> <li>1. Heater burning vapors from paint, hair spray, glues, etc. See <i>IMPORTANT</i> statement above</li> <li>2. Gas leak. <b>See Warning statement above</b></li> </ol> | <ol style="list-style-type: none"> <li>1. Ventilate room. Stop using odor-causing products while heater is running</li> <li>2. Locate and correct all leaks (see <i>Checking Gas Connections</i>, page 14)</li> </ol> |
| Heater shuts off in use (ODS operates) | <ol style="list-style-type: none"> <li>1. Not enough fresh air is available</li> <li>2. Low line pressure</li> <li>3. ODS/pilot is partially clogged</li> </ol>  | <ol style="list-style-type: none"> <li>1. Open window and/or door for ventilation</li> <li>2. Contact local natural gas company</li> <li>3. Clean ODS/pilot (see <i>Cleaning and Maintenance</i>, page 20)</li> </ol> |

*Continued*

# TROUBLE-SHOOTING

*Continued*

## WARNING

If you smell gas

- Shut off gas supply.
- Do not try to light any appliance.
- Do not touch any electrical switch; do not use any phone in your building.
- Immediately call your gas supplier from a neighbor's phone. Follow the gas supplier's instructions.
- If you cannot reach your gas supplier, call the fire department.

| OBSERVED PROBLEM                                   | POSSIBLE CAUSE   | REMEDY  |
|--|--|---|
| Gas odor even when control knob is in OFF position | 1. Gas leak. <b>See Warning statement at top of page</b> | 1. Locate and correct all leaks (see <i>Checking Gas Connections</i> , page 14) |
|  | 2. Control valve defective                               | 2. Replace control valve  |
| Gas odor during combustion                         | 1. Foreign matter between control valve and burner       | 1. Take apart gas tubing and remove foreign matter                              |
|  | 2. Gas leak. <b>See Warning statement at top of page</b> | 2. Locate and correct all leaks (see <i>Checking Gas Connections</i> , page 14) |

You may have further questions about installation, operation, or troubleshooting. If so, contact DESA International's Technical Service Department at 1-800-323-5190.

# TECHNICAL SERVICE

# SPECIFICATIONS

|                                      | VN12A                 | VN6B                  |
|--------------------------------------|-----------------------|-----------------------|
| BTU (Variable)                       | 6,000/12,000          | 6,000                 |
| Type Gas                             | Natural Only          | Natural Only          |
| Ignition                             | Piezo                 | Piezo                 |
| Pressure Regulator Setting           | 3" W.C.               | 3" W.C.               |
| Inlet Gas Pressure (inches of water) |                       |                       |
| Maximum                              | 10.5"                 | 10.5"                 |
| Minimum                              | 4"                    | 4"                    |
| Dimensions, Inches (H x W x D)       |                       |                       |
| Heater                               | 20 1/2 x 13 1/2 x 5   | 20 1/2 x 13 1/2 x 5   |
| Carton                               | 25 x 16 11/16 x 7 1/2 | 25 x 16 11/16 x 7 1/2 |
| Weight (pounds)                      |                       |                       |
| Heater                               | 14                    | 13                    |
| Shipping                             | 17                    | 16                    |



## SERVICE HINTS

### When gas pressure is too low

- pilot will not stay lit
- burner(s) will have delayed ignition
- heater will not produce specified heat

### When gas quality is bad

- pilot will not stay lit
- burner(s) will produce flames and soot
- heater will backfire when lit

You may feel your gas pressure is too low or gas quality is bad. If so, contact your local natural gas supplier.

*Note:* Use only original replacement parts. This will protect your warranty coverage for parts replaced under warranty.

### Parts Under Warranty

Contact authorized dealer from whom you purchased this product. If they cannot supply original replacement part(s), call DESA International's Technical Service Department at 1-800-323-5190 for referral information.

When contacting your dealer or DESA International, have ready:

- your name
- your address
- model number of your heater
- how heater was malfunctioning
- type of gas used (propane or natural gas)
- purchase date

Usually, we will ask you to return the defective part to the factory.

### Parts Not Under Warranty

Contact authorized dealers of this product. If they cannot supply original replacement part(s), call DESA International's Parts Department at 1-800-972-7879 for information.

When calling DESA International, have ready:

- model number of your heater
- the replacement part number

You can purchase a service manual from the address listed on the back page of this manual. Send a check for \$5.00 payable to DESA International.

## ACCESSORY

Purchase this heater accessory from your local dealer. If they cannot supply this accessory, call DESA International's Parts Department at 1-800-972-7879 for information. You can also write to the address listed on the back page of this manual.

### MANUAL SHUTOFF VALVE - GA5010

Manual shutoff valve with 1/8" NPT tap.

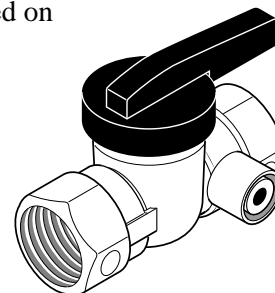

## REPLACEMENT PARTS

## SERVICE PUBLICATIONS

# PARTS LIST VN6B

This list contains replaceable parts used in your heater. When ordering parts, follow the instructions listed under *Replacement Parts* on page 25 of this manual.

| KEY NO. | PART NUMBER | DESCRIPTION                   | QTY. | KEY NO.                            | PART NUMBER | DESCRIPTION            | QTY. |
|---------|-------------|-------------------------------|------|------------------------------------|-------------|------------------------|------|
| 1       | 098304-01   | Screw, #10 x 3/8"             | 2    | 14                                 | 099057-01   | Pressure Tap Fitting   | 1    |
| 2       | 099467-01   | Front Panel Assembly          | 1    | 15                                 | 098276-01   | 1/8 Pipe Plug          | 1    |
| 3       | 099318-03   | Grill Guard                   | 1    | 16                                 | 099468-04   | Cabinet Assembly       | 1    |
| 4       | 098342-01   | Grill Guard Clip              | 2    | 17                                 | 099415-01   | Gas Regulator          | 1    |
| 5       | 099469-01   | Reflector Assembly            | 1    | 18                                 | 098303-02   | Screw, #6 x 5/16"      | 2    |
| 6       | M15823-37   | Screw Hex #8 x 1/4"           | 9    | 19                                 | 098508-01   | Valve Retainer Nut     | 1    |
| 7       | 503329      | ODS/Pilot Assembly            | 1    | 20                                 | 099393-01   | Control Knob           | 1    |
| 7-1     | 098514-01   | Thermocouple                  | 1    | 21                                 | M11084-26   | Screw, #10 x 3/8"      | 2    |
| 7-2     | 098594-01   | Ignitor Electrode             | 1    | 22                                 | 099818-01   | Internal Tooth Washer  | 1    |
| 8       | 099884-01   | Burner Assembly               | 1    | 23                                 | 097159-02   | Piezo Ignitor          | 1    |
| 9       | 099056-04   | Injector                      | 1    | 24                                 | 098271-03   | Ignitor Cable          | 1    |
| 10      | 099390-01   | Tubing - Valve to burner      | 1    | <b>PARTS AVAILABLE - NOT SHOWN</b> |             |                        |      |
| 11      | 099387-05   | Pilot Tubing - Valve to pilot | 1    |                                    |             |                        |      |
| 12      | 099391-02   | Tubing - Regulator to valve   | 1    |                                    |             |                        |      |
| 13      | 100829-01   | Control Valve                 | 1    |                                    | 099395-01   | Control Position Label | 1    |

## ILLUSTRATED PARTS BREAKDOWN VN6B

HEATER EXPLODED VIEW

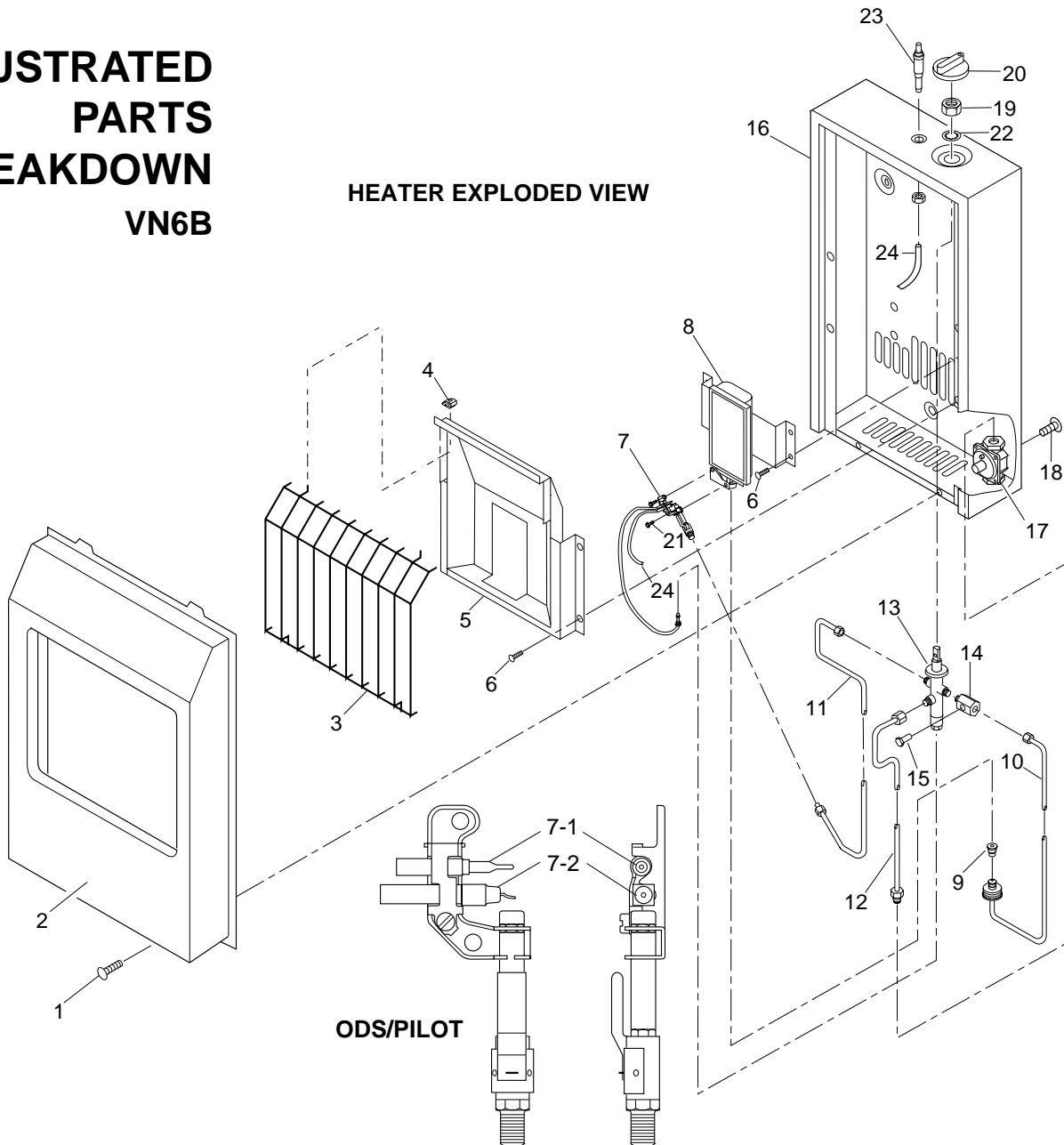

ODS/PILOT

# PARTS LIST VN12A

This list contains replaceable parts used in your heater. When ordering parts, follow the instructions listed under *Replacement Parts* on page 25 of this manual.

| KEY NO. | PART NUMBER | DESCRIPTION                   | QTY. | KEY NO.                            | PART NUMBER | DESCRIPTION            | QTY. |
|---------|-------------|-------------------------------|------|------------------------------------|-------------|------------------------|------|
| 1       | 098304-01   | Screw, #10 x 3/8"             | 2    | 14                                 | 100432-01   | Control Valve          | 1    |
| 2       | 099467-01   | Front Panel Assembly          | 1    | 15                                 | 099057-01   | Pressure Tap Fitting   | 1    |
| 3       | 099318-03   | Grill Guard                   | 1    | 16                                 | 098276-01   | 1/8 Pipe Plug          | 1    |
| 4       | 098342-01   | Grill Guard Clip              | 2    | 17                                 | 099468-05   | Cabinet Assembly       | 1    |
| 5       | 099469-02   | Reflector Assembly            | 1    | 18                                 | 099415-01   | Gas Regulator          | 1    |
| 6       | M15823-37   | Screw Hex #8 x 1/4"           | 10   | 19                                 | 098303-02   | Screw, #6 x 5/16"      | 2    |
| 7       | 503329      | ODS/Pilot Assembly            | 1    | 20                                 | 098508-01   | Valve Retainer Nut     | 1    |
| 7-1     | 098514-01   | Thermocouple                  | 1    | 21                                 | 099393-01   | Control Knob           | 1    |
| 7-2     | 098594-01   | Ignitor Electrode             | 1    | 22                                 | M11084-26   | Screw, #10 x 3/8"      | 2    |
| 8       | 099884-02   | Burner Assembly               | 1    | 23                                 | 099818-01   | Internal Tooth Washer  | 1    |
| 9       | 099056-04   | Injector                      | 2    | 24                                 | 097159-02   | Piezo Ignitor          | 1    |
| 10      | 099390-02   | Tubing - Valve to plaque A    | 1    | 25                                 | 098271-03   | Ignitor Cable          | 1    |
| 11      | 099387-05   | Pilot Tubing - Valve to pilot | 1    | <b>PARTS AVAILABLE - NOT SHOWN</b> |             |                        |      |
| 12      | 099392-01   | Tubing - Valve to plaque B    | 1    |                                    | 099395-02   | Control Position Label | 1    |
| 13      | 099391-02   | Tubing - Regulator to valve   | 1    |                                    |             |                        |      |
| 14      | 100432-01   | Control Valve                 | 1    |                                    |             |                        |      |

## ILLUSTRATED PARTS BREAKDOWN VN12A

HEATER EXPLODED VIEW

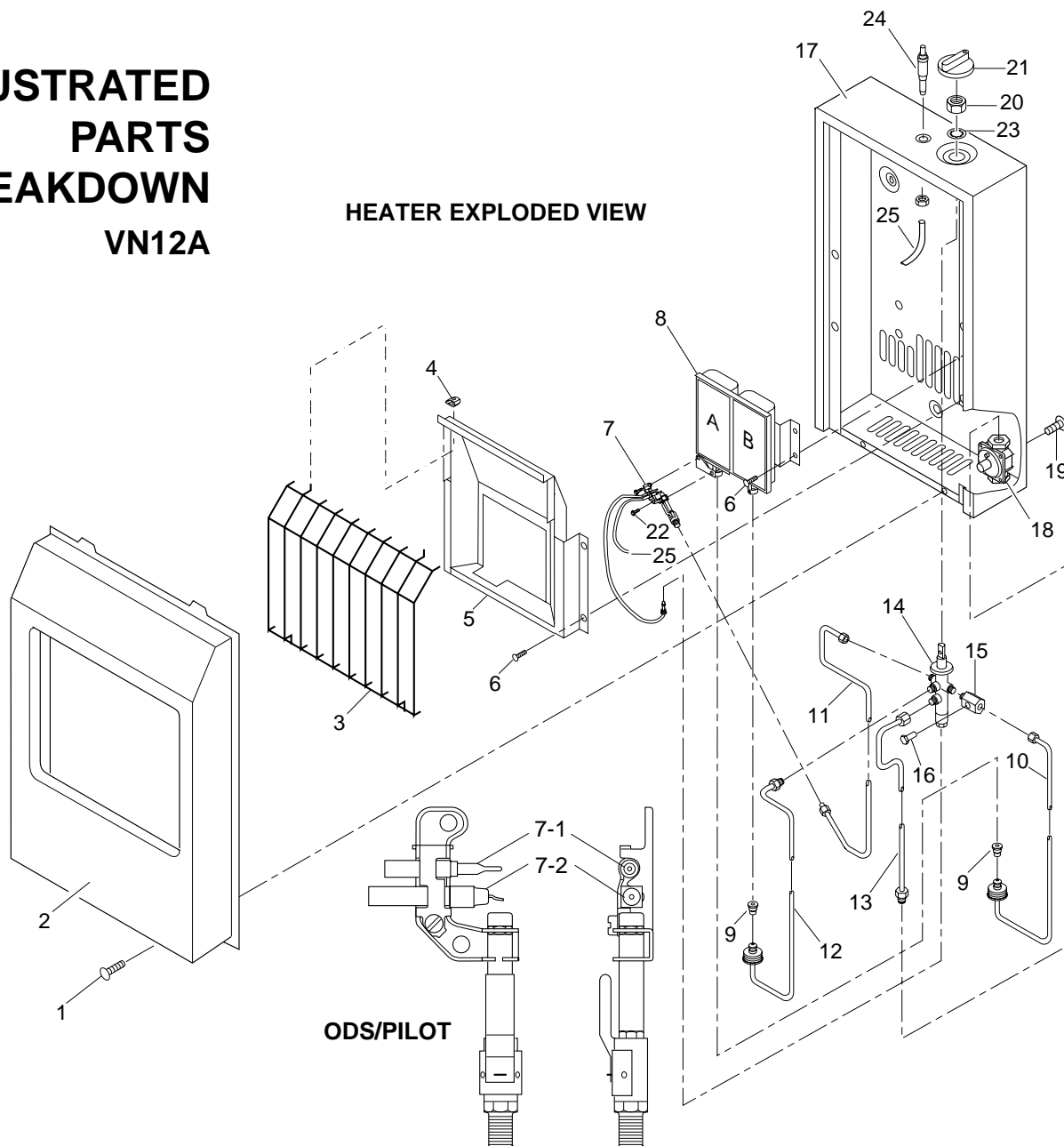

# WARRANTY INFORMATION

## KEEP THIS WARRANTY

Model \_\_\_\_\_

Serial No. \_\_\_\_\_

Date Purchased \_\_\_\_\_

Always specify model and serial numbers when communicating with the factory.

We reserve the right to amend these specifications at any time without notice. The only warranty applicable is our standard written warranty. We make no other warranty, expressed or implied.

### LIMITED WARRANTY VANGUARD VENT-FREE RESIDENTIAL GAS HEATERS

DESA International warrants this product and any parts thereof, to be free from defects in material and workmanship for two years from the date of first purchase, provided that the product has been properly installed, operated, and maintained in accordance with all applicable instructions. To make a claim under this warranty, the bill of sales or proof of purchase must be presented.

This warranty is extended only to the original retail purchaser. This warranty covers only the cost of parts and labor required to restore this heater to proper operating condition. Warranty parts must be obtained through authorized dealers of this product and/or DESA International who will provide original factory replacement parts. Failure to use original factory replacement parts voids this warranty. The heater must be installed by a qualified installer in accordance with all local codes and instructions furnished with the unit.

This warranty does not apply to parts that are not in original condition because of normal wear and tear, or parts that fail or become damaged as a result of misuse, accidents, lack of proper maintenance, alteration, tampering, contaminated fuels, or defects caused by improper installation. Travel, transportation, and incidental costs associated with warranty repairs are not reimbursable under this warranty and are the responsibility of the owner.

To the full extent allowed by the law of the jurisdiction that governs the sale of the product: this express warranty excludes any and all other expressed warranties and limits the duration of any and all implied warranties, including warranties of merchantability and fitness for a particular purpose to two years from the date of first purchase: and DESA International's liability is hereby limited to the purchase price of the product and DESA International shall not be liable for any other damages whatsoever including indirect, incidental, or consequential damages.

Some states do not allow a limitation of how long an implied warranty lasts or an exclusion or limitation of incidental or consequential damages, so the above limitation of implied warranties, or exclusion, or limitation of damages may not apply to you.

This warranty provides the original retail purchaser with specific legal rights. For specific information regarding those rights, please consult the applicable state laws.

**DESA**  
**INTERNATIONAL**

2701 Industrial Drive  
P.O. Box 90004  
Bowling Green, KY 42102-9004

100845-01  
REV. C  
5/94

## Free Manuals Download Website

<http://myh66.com>

<http://usermanuals.us>

<http://www.somanuals.com>

<http://www.4manuals.cc>

<http://www.manual-lib.com>

<http://www.404manual.com>

<http://www.luxmanual.com>

<http://aubethermostatmanual.com>

Golf course search by state

<http://golfingnear.com>

Email search by domain

<http://emailbydomain.com>

Auto manuals search

<http://auto.somanuals.com>

TV manuals search

<http://tv.somanuals.com>