

Techni'Sat[®]

DigiPal 2 DigitMod T1

for the reception of
DVB-T TV and radio channels



Operating Manual



1 Contents

1	Contents	.2
2	Illustrations	.3
3	Important notes on operation	.8
	Note on disposal	.9
	Safety notes	.9
	When not in use	.9
4	Connections	.11
4.1	Antenna	.11
4.2	Connection to a television set	.11
4.2.1	Using a SCART cable	.11
4.2.2	Using HF cable*	.11
4.3	Video cassette recorder (VCR)*	.11
4.4	Hi-fi amplifier*	.12
4.4.1	Analogue*	.12
4.4.2	Digital*	.12
4.5	Mains power connection	.12
4.6	Serial interface (RS 232)*	.12
5	Getting started: initial installation	.12
6	Settings	.15
6.1	Menu language	.15
6.2	Basic settings	.15
6.2.1	Time difference to GMT (hours)	.15
6.2.2	Country	.16
6.2.3	Remote control code	.16
6.2.4	Antenna feed 5V	.16
6.2.5	Stand-by clock*	.16
6.3	Audio/Video settings	.17
6.3.1	Picture format TV set	.17
6.3.2	Language (Audio signal)	.17
6.3.3	Language (Sub-titles)	.17
6.3.4	TV SCART mode*	.17
6.3.5	VCR SCART mode*	.17
6.3.6	Dolby Digital (AC3)*	.18
6.4	Antenna adjustment	.18
7	Operation	.18
7.1	Switching on and off	.18
7.2	Programme selection	.19
7.2.1	Using the Programme up/down keys	.19
7.2.2	Using the numeric keys	.19
7.2.3	Using the programme list (Navigator)	.19
7.2.3.1	Selecting a list	.20
7.2.4	Calling up blocked programmes	.20
7.2.5	Information box	.20
7.3	Volume control	.21
7.4	Selecting a different language	.21

7.4.1	Dolby Digital (AC3 mode)*	21
7.5	TV/Radio switching	22
7.6	Return to last programme selected	22
7.7	Display time and programme information	22
7.8	Additional Programme information	22
7.9	Channel information	23
7.10	Freeze frame	23
7.11	Sleep timer	23
7.12	Video text	23
7.12.1	Using the video text decoder of your TV	23
7.12.2	Using the internal video text decoder	23
7.13	Sub-titles	24
7.14	Electronic Programme Guide SFI	25
7.14.1	Downloading SFI data	25
7.14.2	Interrupting the download	25
7.14.3	Viewing the Electronic Programme Guide	26
7.14.4	Now (Table of current programme contents)	26
7.14.5	Next	26
7.14.6	More	27
7.14.7	SFI Functions	27
7.14.7.1	SFI Information	27
7.14.7.2	Marking a programme	27
7.14.7.3	SFI Timer programming	28
7.14.7.4	SFI Programme overview	28
7.14.7.5	SFI overview by programme type (category)	29
7.14.8	Exiting SFI	30
7.15	Timer recording	30

8 Changing the basic programming . . .33

8.1	Configuring the Favourites list	33
8.1.1	Calling up the Navigator	33
8.1.2	Adding programmes to the Favourites list	34
8.1.3	Deleting programmes	35
8.1.3.1	Removing (deleting) from the Favourites list	35
8.1.3.2	Deleting from the Total list	36
8.1.4	Sorting programmes	36
8.2	Programming the electr. programme guide	36
8.2.1	Selecting a channel	37
8.2.2	Start category	38
8.2.3	SFI Channel	38
8.3	Parental control(blocking programmes)	39
8.3.1	Changing the receiver PIN code	39
8.3.2	Mode	40
8.3.3	Selecting a programme	40
8.4	Programme search (scan)	41
8.4.1	Automatic Scan	41
8.4.2	Expanded Scan	42
8.4.3	Manual Scan	43

8.4.4	After the scan	.43
8.5	Service settings	.44
8.5.1	Activating default (factory) setting	.44
8.5.2	Delete all programmes	.44
8.5.3	Updating Software	.45
8.5.4	Copying settings	.45
8.6	System configuration	.46
9	Technical terms	.46
10	Technical data	.47
11	Trouble-shooting guide	.50
	Notes	.51
	Index	.53
	For daily use	.54

Your unit carries the CE logo, and complies with all relevant EU standards.
Not responsible for printing errors, subject to change without notice.

Correct as at 06/05

TechniSat, DigiPal 2 and DigitMod T1 are registered trade-marks of

TechniSat Digital GmbH

P.O. Box 560

D- 54541 Daun Germany

www.technisat.com

Reproduction and copying only with the permission of the publisher

2 Illustrations

Remote Control

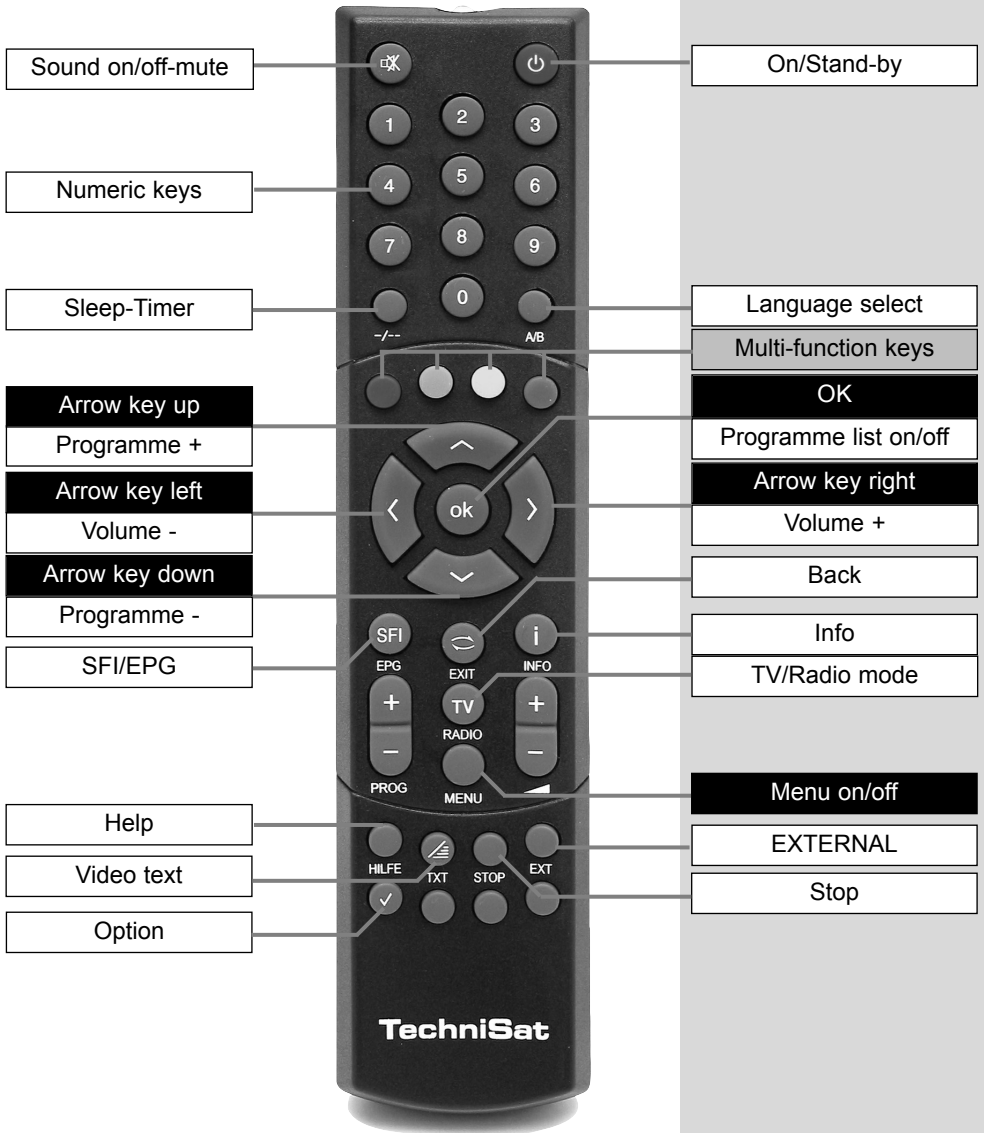

DigiPal 2

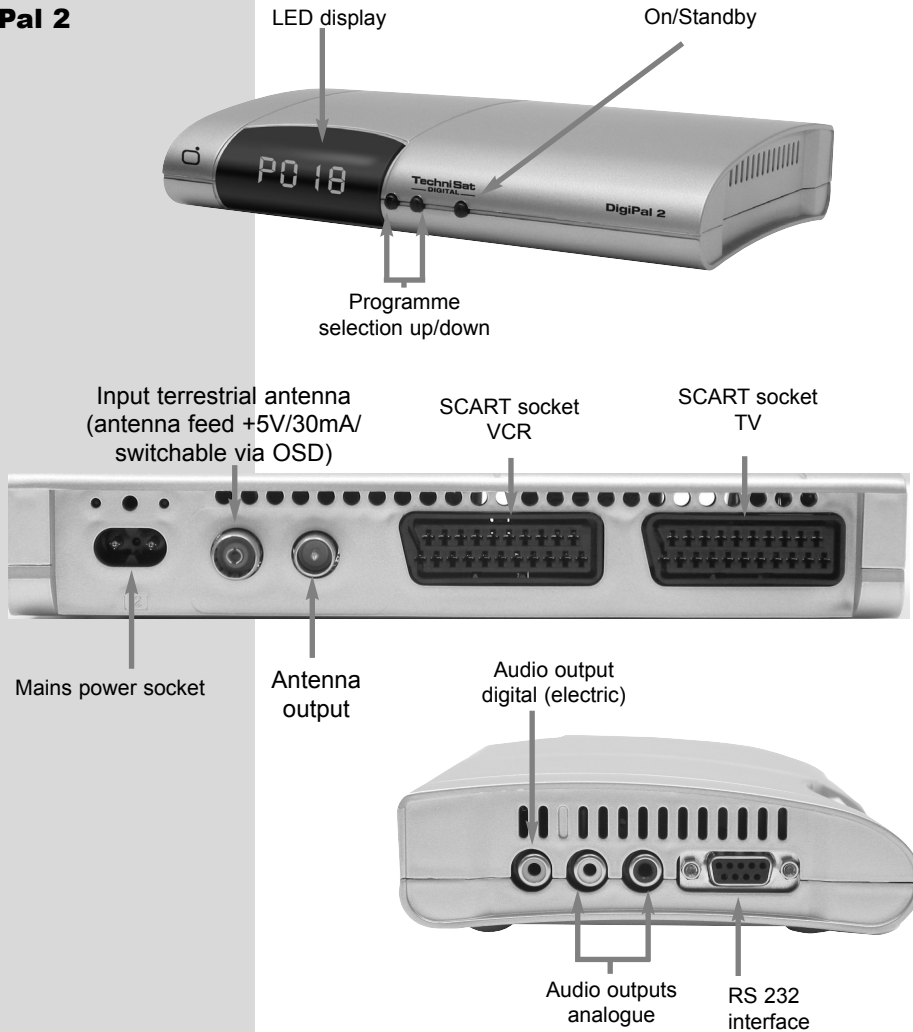

DigitMod T1

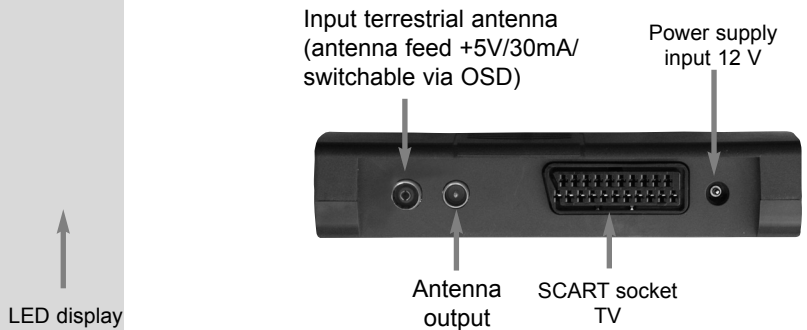

Dear customer,

congratulations on your decision to buy this digital receiver. This operating manual is designed to assist you in using the comprehensive functions of your new digital receiver to the optimum.

We have tried to keep the instructions as brief as possible, while making them as comprehensive, and comprehensible, as necessary.

The range of features of your unit is constantly being expanded in the form of software updates. This may lead to additional operating steps becoming necessary which are not yet described in this manual, or the operation of existing functions may be altered. For this reason, you should occasionally visit the TechniSat homepage in the Internet, to download the most up-to-date operating manual.

We wish you many years of enjoyable entertainment with your digital receiver!

Your

TechniSat Team

3 Please read this first

- > Before you set up your unit for operation, please first check that the package contains all the components that should be there. The following are supplied as standard:
1 digital receiver, 1 mains power cable, 1 remote control unit, 1 operating manual, 1 guarantee card, 2 batteries (1,5V AAA size).
- > Insert the batteries provided in the battery compartment of the remote control unit. Note the correct polarity when inserting the batteries.
- > Before connecting the digital receiver, please first read the safety notes in **Chapter 3**.
- > **Chapters 4, 5 and 6** describe connection of the receiver, and adjusting it to the external installation (dish antenna, LNC, etc.), to the television set, VCR, etc. These settings need only be made once during initial installation, and need only be adjusted or changed when there are any changes in your equipment, i.e. if a different external unit is connected, or additional appliances are connected.
- > **Chapter 7** describes all the functions necessary for day-to-day operation, such as programme selection or volume adjustment.
- > **Chapter 8** contains information on how to add new programmes, and how to change the programme order.
- > Technical terms used in the operating manual are explained in **Chapter 9**.
- > Technical data may be found in **Chapter 10**.
- > Assistance in finding and eliminating problems can be found in the trouble-shooting guide in **Chapter 11**.

Important notes on operation

The use of a so-called "On Screen Display" simplifies the operation of the digital receiver, and reduces the number of keys required on the remote control unit. All functions are displayed on the screen, and can be controlled by a few key-strokes. Related functions are grouped together in a "MENU". The selected function is highlighted in a different colour. The lower line of the display shows coloured bars representing the red, green, yellow and blue function keys. These coloured bars represent different functions in the various menus, which can be executed by pressing the appropriate colour-coded key ("multi-function key") on the remote control unit. The function keys are only active when a brief description is displayed in the appropriate field.

The descriptions of keys and terms that appear in the OSD menu are printed in bold type in this operating manual.

Help function:

Where available in the menu, pressing the **blue** function key will cause a help text to be displayed, pressing again will return to normal operation.

Note on disposal

The packaging of your unit consists entirely of recyclable material. Please sort the components appropriately, and dispose of them via the "Dual System", or your equivalent recycling system. Please note that spent batteries from the remote control unit, as well as electronic components in general, should not be disposed of in your domestic refuse. For appropriate disposal, consult your specialist retailer, or consult your local authority).

Safety notes

For your own protection you should read the notes on safety precautions carefully before commencing operation of your new unit.

The manufacturer bears no responsibility for damage caused by non-observance of the safety precautions, or by inappropriate handling.

- > To ensure adequate circulation of air, place the unit on a smooth horizontal surface and do not place any objects on top of the unit. The top cover contains air slits which permit heat to escape from the interior of the unit.
- > Do not place any burning items, such as burning candles, on top of the unit.
- > Do not place any containers filled with liquid, such as vases, on top of the unit, and ensure the unit remains dry, i.e. it must not be subjected to water spray or droplets.
- > The unit may only be operated in a temperate climate.
- > Do not open the cover of your unit! You are in danger of receiving an electric shock. If it becomes necessary to open the unit, this should only be done by trained personnel.

In the following cases you should disconnect the unit from the mains power and consult a specialist repair service:

- > the mains cable or the mains plug are damaged
- > the unit has been exposed to humidity, or liquid has entered the casing
- > in case of severe malfunction
- > in case of significant external damage

When not in use

The unit should be disconnected from the mains power supply if it will not be operated for an extended period (e.g. when you are away on holiday), or during an electric storm.

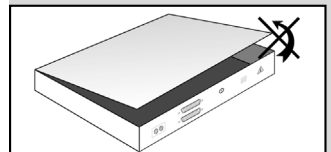
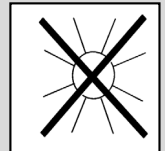
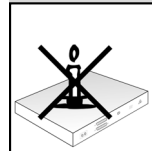
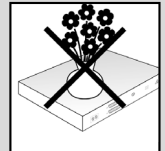
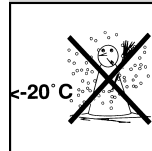
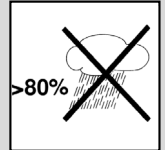
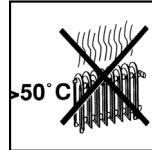

Connecting the DVB-T receiver

- a. Connect the antenna with the **terrestrial antenna input** of the DVB-T receiver.
- b. Scart connection between the DVB receiver and the television set.
- c. Connection between the **antenna output** of the DVB-T receiver and the antenna input of the television set.
- d. Scart connection of a video recorder with the **VCR Scart socket** of the DVB receiver.
- e. Connection between the audio outputs and a Hi-Fi installation.
- f. Mains power connection

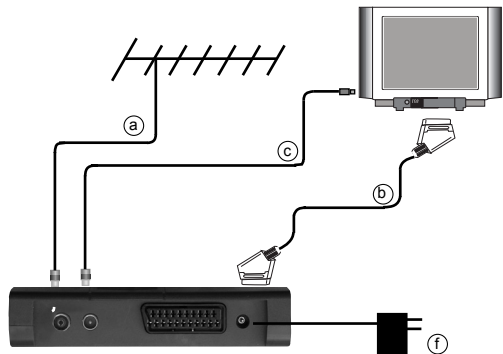
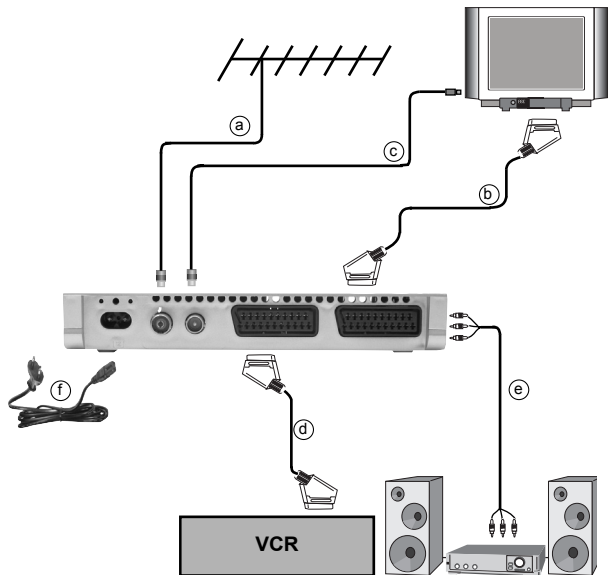

4 Connections

The references below to items **a b c** etc. refer to the illustration on page 10.

4.1 Antenna

- a** The cable coming from the terrestrial antenna (roof-mounted or room antenna) should be connected with the **terrestrial antenna input** of the receiver. Wherever possible please use a roof-mounted antenna. An internal room antenna may be sufficient under very favourable reception conditions. If an active antenna is being used, ensure that the antenna feed is switched on (Point 6.2.4).

4.2 Connection to a television set

4.2.1 Using a SCART cable

- b** Connect your receiver (**SCART socket TV**) and the television set (SCART socket) by means of a SCART cable. If your television set is appropriately equipped, this will switch automatically to AV mode when the digital receiver is switched on, and will thus switch to DVB-T operation.

4.2.2 Using HF cable

If you wish to continue receiving any analogue programmes that may be available, the digital receiver must be connected to the antenna input of the television set.

- c** Connect the receiver (**antenna output**) with the antenna input socket of the television set, using a suitable cable connection.

4.3 Video cassette recorder (VCR)*

- d** Connect the video recorder to the SCART socket **VCR**. In playback mode, the video recorder will supply a switching signal to the digital receiver. The video recorder signal will be supplied automatically to the television set. If your video recorder does not supply a switching signal, use the **O/AV** key to switch your digital receiver to the external input **AV**. Press this key again to revert to normal operation.

4.4 Hi-fi amplifier*

4.4.1 Analogue*

- e** To enjoy the best possible sound quality, you can connect the digital receiver to a hi-fi amplifier. Use a suitable cable to connect the cinch sockets **Audio R** and **Audio L** of the digital receiver to an input of the hi-fi amplifier (e.g. CD or AUX; please note that the Phono input is not suitable!).

4.4.2 Digital*

- e** If your amplifier is equipped with an appropriate electrical or optical input socket, connect the socket **AUDIO OUT DIGITAL electrical** with the electrical input of your amplifier.

Sampling rates of 32, 44.1 and 48 KHz are provided, depending on the broadcasting station.

In addition, this connection will reproduce the Dolby Digital signal (AC3), where available.

4.5 Mains power connection

The digital receiver should only be connected to the mains power supply after it has been completely connected with all other components in the system. This serves to avoid the digital receiver or other components being damaged or destroyed.

- f** When you have completed making all the connections, use the mains cable (DigiPal 2) or power adapter (DigitMod T1) supplied to connect the receiver to a mains power outlet 230 V/50-60 Hz.

4.6 Serial interface (RS 232)*

The RS 232 interface is used to update the operating system, and to facilitate pre-programming by means of a personal computer.

5 Getting started: initial installation

When you have read the safety notes, and have connected the unit as described in Chapter 4, you can proceed to switch on the receiver as described in Chapter 7. When switching on the unit for the first time, the Start window with the AutoInstall **installation assistant** (Fig. 5-1) will be displayed. The installation assistant will guide you through the most important settings of the digital receiver quickly and in an easy-to-follow manner.

The keys on the remote control required to make the appropriate step in the installation are marked. You can break off the initial installation procedure at any time by pressing the **red** function key.



(Fig. 5-1)

Pressing the **green** function key takes you back to the previous step of the installation procedure. This allows you to correct any entries made in error.

If the initial installation is not carried out at all, or is interrupted, your unit will start operation with its standard pre-programmed settings.

The initial installation procedure described here serves only as an example. The exact initial installation procedure will depend on the settings you wish to make.

Please follow closely any instructions that appear on the screen.

Menu/OSD language:

- > Press **OK** to display the selection window for the **Menu/OSD language**. (Fig. 5-2)
- > Use the **arrow keys up/down** to select the preferred OSD language.
- > Confirm by pressing **OK**.

Audio language

- > Use the **arrow keys up/down** to select the preferred audio channel language. (Fig. 5-3)
When the installation assistant has been completed, your language selection here will be used to sort the programmes in your Favourites list.
- > Confirm by pressing **OK**.

Country/Time Zone

- > Use the **arrow keys up/down** to select the time zone of the country in which you are located. (Fig. 5-4)
The time on the receiver clock will be set automatically based on your selection.
- > Press **OK** to confirm your selection, and continue with antenna configuration.

Searching/scanning for channels/stations

When the software version has been checked, and updated if necessary, you can proceed to the programme search.

- > Use the **arrow keys up/down** to mark the field **All Programmes**, if you want to search for both freely available and encrypted programmes, or **All unencrypted Programmes**, if you want to search only for free-to-air programmes. (Fig. 5-5)



(Fig. 5-2)



(Fig. 5-3)



(Fig. 5-4)

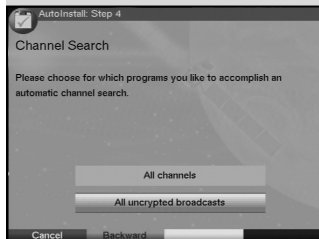

(Fig. 5-5)



(Fig. 5-6)



(Fig. 5-7)

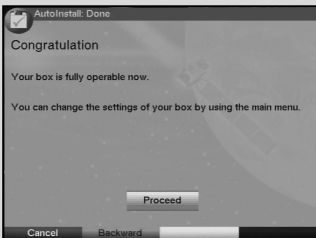

(Fig. 5-8)

- > Press the **OK** key now to confirm, and an automatic programme scan will be carried out. The entire reception range of the receiver will be scanned for digital programmes. This procedure may take several minutes. Please note any messages displayed on the screen (Fig. 5-6).

Updating the software

When the programme scan has been completed, the digital receiver will check whether a new version of the software is available for your unit. If a new version is available, you can perform an automatic software update.

- > Use the **arrow keys left/right** to select the field **Update**, and confirm by pressing **OK**. (Fig. 5-7) The new software for the receiver will now be downloaded. This procedure may take several minutes.

Exiting from the installation assistant

- > Read the message displayed (Fig. 5-8) and confirm by pressing **OK**, to return to normal operation.

6 Settings

Now that you have completed connecting your new digital receiver, and have commenced operation, you can, if you wish, further optimize the settings of the digital receiver for your personal preferences.

6.1 Menu language

Under this menu item you have the option of setting the menu language according to your personal preference.

To alter the OSD language proceed as follows:

- > Press the **Menu** key to call up the **Main Menu**.
(Fig. 6-1)
- > Now use the **arrow keys up/down** to select the menu item **OSD/Menu language**.
- > Confirm by pressing **OK**.
The sub-menu **OSD language** will be displayed.
- > Use the **arrow keys up/down** to select the desired language.
- > Confirm by pressing **OK**, this will store the selection in memory.
- > Press **Back** to return to the **Main Menu**.



(Fig. 6-1)

6.2 Basic settings

To optimize the performance of your DVB receiver, you must still set this to your personal preferences.

- > Press the **Menu** key to call up the **Main Menu**.
- > Use the **arrow keys up/down** to mark the item **Settings**.
- > Confirm by pressing **OK**. The sub-menu **Settings** will be displayed. (Fig. 6-2)
- > Now use the **arrow keys up/down** to mark the item **Basic Settings**.
- > Confirm by pressing **OK**. The menu **Basic Settings** will be displayed. (Fig. 6-3)
- > Use the **arrow keys up/down** to move the marker within the menu, and to change the individual positions as indicated. When selecting a menu item, please also note any messages displayed on the screen.
The following settings may be made:

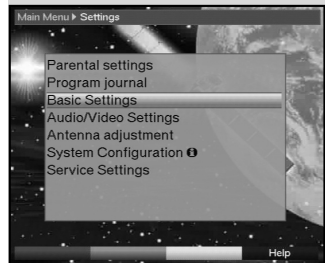

(Fig. 6-2)



(Fig. 6-3)

6.2.1 Time difference to GMT (hours)

Your receiver is equipped with a clock. This is synchronised to **Greenwich Mean Time** via satellite signals. If you have selected the option **None** under the heading **Country** (Point 6.2.3), you will simply need to correct the time to correspond to your local time by using the **arrow keys right/left**.

6.2.2 Country

This function provides for automatic adjustment for summer and winter time. Using the **arrow keys right/left**, enter your home country in the line **Country**.

- > Press the **Back** key to return to the menu **Settings**, or press the **Menu** key to return to normal operation. The settings are automatically stored in memory.

6.2.3 Remote control code

Your digital receiver can be operated with the remote control unit supplied (remote control code Sat2), or with an optional remote control unit utilising remote control code Sat1. This option allows you, for instance, to operate two similar sets in the same room, with each being controlled independently, and without interference of the other. To do this, unit 1 is controlled by remote control code Sat1, and unit 2 by remote control code Sat2.

In this line, decide whether your receiver should be allocated the remote control code **SAT1** or **SAT2**.

- > In this line, operate any key of the appropriate remote control unit (Sat1 or Sat2) to select the remote control code.
- > Press **Back** to return to the menu **Settings**, or press **Menu** to return to normal operation. The settings will be stored automatically.

6.2.4 Antenna feed 5V

If you are using an active antenna, you will have to switch on the antenna power feed (5V/30mA). The antenna will be fed via the **terrestrial antenna input**.

- > In this line, use the **arrow keys left/right** to switch the antenna feed **on** or **off**.

In case of an overload or short circuit of the antenna feed, this will be switched off automatically. If this occurs, rectify the problem/cause, then switch the antenna feed on again.

6.2.5 Stand-by clock*

To reduce the power consumption of your unit in -standby mode, you have the option of switching the clock time display on or off.

- > In this line, use the **arrow keys left/right** to set the standby clock mode to **on** or **off**.
- > Press **Back** to return to the menu **Settings**, or press **Menu** to return to normal operation. The settings will be stored automatically.

6.3 Audio/Video settings

In order to optimize the performance of your digital receiver in conjunction with your television set, you may wish to make further settings in the menu **Audio /Video Settings**.

- > Press the Menu key to call up the **Main Menu**.
- > Use the **arrow keys up/down** to select the line **Settings**.
- > Confirm by pressing **OK**. The sub-menu **Settings** will be displayed. (Fig. 6-4)
- > Now use the **arrow keys up/down** to select the line **Audio/Video Settings**.
- > Confirm by pressing **OK**. The menu **Audio/Video Settings** will be displayed. (Fig. 6-5)
- > You can use the **arrow keys up/down** to move the marker around within the menu, and change the individual settings as indicated. When selecting a menu item please also note any messages displayed on screen.

The following settings can be adjusted:

6.3.1 Picture format TV set

Use the **arrow keys left/right** to select the appropriate picture format for your TV set, **4:3** or **16:9**. This function provides for automatic adjustment of the picture format broadcast to your television set.

6.3.2 Language (Audio signal)

Use the **arrow keys right/left** to select your preferred language. If the language is available from the provider, this language will be automatically selected.

6.3.3 Language (Sub-titles)

Sub-titles can be displayed on your screen using this DVB receiver. If the function Sub-titles is switched on, and the language selected is being broadcast, these will be automatically displayed.

If the function is not switched on, sub-titles can also be displayed manually. Sub-titles are indicated by the osd insertion **Sub-title choosing** shown in the information box. Please also note Point 7.13 of this operating manual.

6.3.4 TV SCART mode*

Use the **arrow keys right/left** to select the appropriate setting for your TV set, **FBAS**, **S-Video** or **RGB**. The standard setting is **FBAS**.

6.3.5 VCR SCART mode

Use the **arrow keys left/right** to select the appropriate setting for your video recorder, either **FBAS** or **S-Video**.

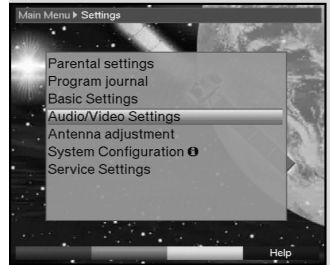

(Fig. 6-4)

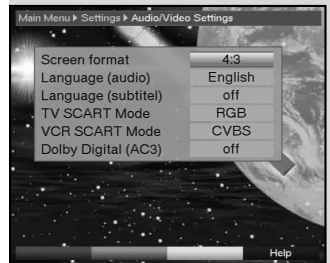

(Fig. 6-5)

6.3.6 Dolby Digital (AC3)*

A number of movies are transmitted in the Dolby Digital format. This is indicated after a programme has been selected by the Dolby logo  in the information window. If you have connected a Dolby Digital 5.1 channel amplifier to the system, you can enjoy movies in 5.1 channel Dolby Digital sound where available.

To enjoy this feature, you must simply connect the Audio Out Digital output (see Point 4.5.2) of your DVB receivers with the digital input of your Dolby Digital 5.1 channel amplifier.

Where a programme is broadcast in Dolby Digital sound, this will be indicated by the Dolby logo being displayed in the information window when the programme is selected. If the function Dolby Digital (AC3) is switched on, these programmes will automatically be reproduced in Dolby Digital format. If the function is not enabled (**off**), Dolby Digital sound can also be switched on manually. Please refer to Point 7.4.1 of this operating manual.

6.4 Antenna adjustment

To position the antenna in the optimum direction, the receiver is equipped with a signal strength indicator.

- > Press the **Menu** key to display the **Main Menu**.
- > Now use the **arrow keys up/down** to select the entry **Settings**.
- > Confirm by pressing **OK**.
The sub-menu **Settings** will be displayed.
(Fig. 6-6)
- > Now use the **arrow keys up/down** to mark the menu line **Antenna adjustment**.
- > Confirm by pressing **OK**. The menu **Antenna adjustment** will be displayed. (Fig. 6-7)
- > Now use the **arrow keys left/right** to enter the channel with the weakest reception signal.
- > Now position the antenna in such a way that both bars show a maximum position.

red bar	poor reception
yellow bar	good reception
green bar	excellent reception

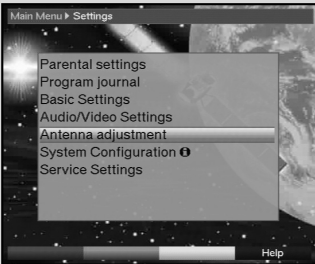

(Fig. 6-6)



(Fig. 6-7)

7 Operation

7.1 Switching on and off

- > You can switch on the digital receiver by pressing the **On/Standby** key either on the receiver front panel, or on the remote control.

- > Press the same key again, either on the receiver front panel or on the remote control, to switch the receiver off again.
- > The receiver is now in standby mode, and the display on the receiver will show the time. If the current time is not shown, this must still be downloaded to the unit. To do this, switch the receiver on, and set it to a major channel that broadcasts a time signal, for about 30 seconds to download the time automatically.

7.2 Programme selection

7.2.1 Using the Programme up/down keys

- > You can move through the list one slot at a time, up or down, by using the **Programme keys up/down** either on the receiver or on the remote control.

7.2.2 Using the numeric keys

- > Use the numeric keys to enter the programme number you wish to view.

For example:

- 1** for programme slot **1**
- 1**, then **4** for programme slot **14**
- 2**, then **3**, then **4** for programme slot **234**

When entering multi-digit programme numbers you have approx. 3 seconds after pressing the key to complete your entry.

If you wish to enter a number consisting of only one or two digits, you can speed up the selection process by holding down the key of the last digit a little longer.

7.2.3 Using the programme list (Navigator)

- > Press **OK**. The programme list will now be displayed. In TV mode only the TV programmes will be displayed, and in radio mode only the radio programmes will be displayed. The programme currently selected is marked/highlighted. (Fig. 7-1)
- > Use the **arrow keys up/down** to mark the desired programme.
- > Press the yellow function key Preview to view a preview of the programme highlighted.
- > Press **OK** to view the highlighted programme.
- > Use the **arrow keys up/down** to move the marker around the list one line at a time.
- > Use the **arrow keys right/left** to move the marker around the list, backward or forward, one page at a time.



(Fig. 7-1)



(Fig. 7-2)



(Fig. 7-3)



(Fig. 7-4)

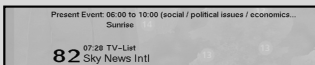

(Fig. 7-5)

7.2.3.1 Selecting a list

To facilitate finding programmes your receiver is equipped with several programme lists. You may select your **Favourites list** (see Point 8.1), or display the alphabetically sorted **Total list** or sort the list by **Providers**.

- > Press **OK** to display the active programme list.
- > Now use the **red** function key to open a window showing the types of programme list available (**Favourites List, Providers and Total list**). The active programme list type will be highlighted. (Fig. 7-2)
- > Use the **arrow keys up/down** to select, e.g. the programme list type Total list.
- > Confirm by pressing **OK**. The alphabetically sorted **Total list**, which includes all programmes, will be displayed. (Fig. 7-3)
- > Use the **arrow keys up/down** to mark the programme you wish to view.
- > Confirm by pressing **OK**.

7.2.4 Calling up blocked programmes

If you select a programme that is blocked by the parental control function, the message **Receiver PIN** will be displayed on screen. (Fig. 7-4)

- > Use the **numeric keys** to enter your PIN code. You can now view the programme selected.

or

- > Switch to a programme that is not blocked.

If you have selected the option **Always** under Point 6.2.1, the message requiring entry of the code will appear each time you switch to a blocked programme. However, to make your life a little easier, the PIN code only needs to be entered once in each operational cycle.

If you have selected the option Auto, only the programme currently running will be unblocked. The parental control will be active again for the next programme broadcast, and the PIN code will also have to be entered again.

7.2.5 Information box

Each time the programme is changed, an information box will be displayed briefly (Fig. 7-5) showing the programme slot and programme name. In addition, symbols will indicate other programme characteristics, such as **Text** for video text, **16/9** for a 16/9 format programme, **A/B** for various audio channels (e.g. movie with soundtrack in various languages, or various radio programmes) and **ENC** for encrypted programmes. Where available from the provider, the recommended age restriction as well as the programme genre will also be indicated.

7.3 Volume control

You have the facility to adjust the volume of your digital receiver. This makes operating the receiver even more convenient, since you can access all important functions from a single remote control, and will rarely have to use the remote control of your television set. When the digital receiver is switched on it will reproduce sound at the volume level last set.

- > Adjust the volume of your digital receiver using the **Volume +** key to increase volume, and the **Volume -** key to make it softer.
- > Press the **Sound on/off** key to switch the sound off (mute), press the same key again to switch the sound back on.

7.4 Selecting a different language

If a programme is broadcast in several languages, or with various soundtracks (Fig. 7-6), proceed as follows to select a different language or sound channel:

- > Press the **Language Select** key. A list of languages currently broadcast will be displayed on screen (Fig. 7-7).
- > Use the **arrow keys up/down** to select the desired language.
- > Confirm by pressing **OK**.

You can now listen to the programme in the desired language. Your digital receiver can also receive mono broadcasts.

- > Use the **arrow keys right/left** to choose between Mono Channel 1 (), Mono Channel 2 () and Stereo ().

7.4.1 Dolby Digital (AC3 mode)*

If a programme is broadcast in Dolby Digital sound, this will be indicated by the Dolby logo in the information window when you switch to the programme. If the Dolby Digital (AC3) function has been enabled as per Point 6.3.6, this programme will automatically be reproduced in this format.

If you have not switched on the function **Dolby Digital (AC3)**, switch your receiver to AC-3 mode manually as follows:

- > Press the **Language Select key**. If available, a list of the languages currently being broadcast as well as **Dolby Digital (AC 3)** will be displayed on screen.
- > Use the **arrow keys up/down** to mark the line **Dolby Digital**.
- > Confirm by pressing **OK**.

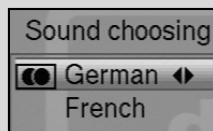
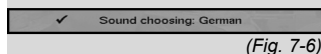

You can now enjoy the programme in full 5.1 channel Dolby Digital sound. If you would like your receiver to recognise and reproduce Dolby Digital broadcasts automatically, you should set your receiver to automatic AC3 reproduction as described in Point 6.3.6.

7.5 TV/Radio switching

The pre-programming setup contains not only television programmes, but radio programmes as well.

- > Press the **TV/Radio** key to switch the digital receiver to radio mode.
The receiver will now play the radio programme last selected.
- > Press the **TV/Radio** key again to return to the television programme last viewed.

7.6 Return to last programme selected

- > Press **Back** on the remote control to return to the last programme viewed previously.
- > Press the key again to return to the programme viewed previously.

7.7 Display time and programme information

This function allows you to view programme information related to the current programme.

- > Press the **Info** key to display the information related to the current programme (Fig. 7-8).

In the bottom half of the screen you will now see displayed the current time, the name of the current channel and programme, including the starting and ending time, where these data are broadcast by the provider.

- > Where available, press the **Info** key again to display information on the next programme.

7.8 Additional Programme information

Where available, the function Programme Information can be used to obtain additional programme information on the programme currently selected.

- > Press 2 x the **Info** key to open an additional information window (Fig. 7-9).
More detailed information on the current programme will be displayed.
- > Lengthy text passages can be scrolled one line at a time using the **arrow keys right/left**.
- > Press the **Info** function key again to display information on the next programme.

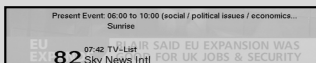

(Fig. 7-8)



(Fig. 7-9)

- > Press the **Info** key once more to exit the information window.

7.9 Channel information

- > Press the **OK** key
- > Use the **arrow keys up/down** to mark the programme you wish to view informations.
- > Press **Option** key to display the data of the channel currently selected. (Fig. 7-10)
- > You may use the other coloured function keys to display **Audio/Video** information, **Programme** information and, where available, information on the **Encryption system (CA)** used.
- > Press **Menu** to return to normal operating mode.

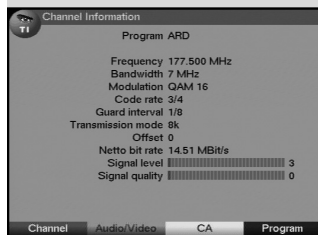

(Fig. 7-10)

7.10 Freeze frame

- > Press the **Stop** key to freeze the current television image as a still image.
- > Press the same key again to return to normal operation.

7.11 Sleep timer

- > Press the key **Sleep timer** several times to select the desired switch-off time of the receiver, from 15 minutes to 2 hours. At the end of the selected time, the receiver will switch off automatically, and go to stand-by mode.

7.12 Video text

7.12.1 Using the video text decoder of your television set

Where broadcast by the provider, video text will be transferred to your television set. To operate the video text function, use the remote control of your television set. Should you experience problems with your television set, such as an overlap of video text and picture content, you should set your digital receiver to **FBAS mode** (Point 6.3.4).*

7.12.2 Using the internal video text decoder

As an alternative, you can utilize the integrated TOP video text decoder to display information. The TOP video text system groups together all text pages in groups and blocks according to subject matter, which makes the system more manageable.

- > Select the programme on which you wish to view video text information.



(Fig. 7-11)

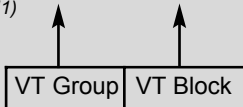

> Press the **Video text** key to switch on the video text (Fig. 7-11).

> Use the **numeric keys** to enter the video text page you wish to view. Your entry will be displayed in the upper left corner of the screen. When you have entered the desired video text page, your receiver will search for this page.

Since not all video text pages can be transmitted simultaneously, it may take a few seconds for your unit to find the page and display it on your television screen.

All video text providers utilize page 100 for their index.

- > Use the **red** resp. **green** keys to move forward or back one page at a time.
- > Press the **yellow** function key to call up the video text group indicated in the yellow field.
- > Press the **blue** function key to call up the video text block indicated in the blue field.

Mixed mode

> Pressing the key **Video text** again will switch the screen display to mixed mode (simultaneous display of the video text information as well as of the TV picture). Press this key again to exit from mixed mode.

Stop mode

- > Press the **Stop** key; the message Stop will be displayed in the top left corner of the video text window. This will prevent the automatic continuous paging of the video text sub-pages. Press the **Stop** key again to exit the Stop mode.
- > Press **Back** to return to normal operation.

7.13 Sub-titles

Where sub-titles are available, this will be indicated by the osd insertion **Sub-title choosing** in the information window. If you have enabled the function **Sub-titles** (in accordance with Point 6.3), these will automatically be displayed, provided they are available in the language selected. If the sub-titles are only available in other languages, or are broadcast via video text, you can enable these manually as follows.

- > Press the **Option** key (you may have to press it several times) until the heading **Sub-titles** display a table listing the sub-title languages being broadcast, and/or the video text pages on which the sub-titles are being broadcast.
- > Use the **arrow keys up/down** to mark the desired language or video text page.
- > Confirm by pressing **OK**. The sub-titles will now be displayed.

Please note that these functions are only available when sub-titles are actually being broadcast, and the settings are not stored in memory if you switch to another channel.

7.14 Electronic Programme Guide SFI

Your digital receiver provides an electronic programme guide. This allows you to view the programme information relating to one or more programmes on your screen.

You can very quickly obtain an overview of programmes currently being broadcast, or you can view all the programmes being broadcast today, or on the following days.

The SFI functions allow you to:

- display information relating to programme contents on your screen
- mark programmes you wish to view, which will be automatically selected when the programme begins
- programme time events
- search for and set programmes according to the programme type or category.

7.14.1 Downloading SFI data

The programme information is updated by your receiver at the times set in accordance with Point 8.2.3 (SFI Channel). The only proviso is that the receiver must be in standby mode.

The download procedure is indicated by the message **SFI** in the display. If your receiver is switched on at this time, the function will not be carried out.

You can also initiate a manual download procedure immediately after switching the receiver off (while the display shows "oooo") by pressing the SFI key. During the download procedure the message **SFI** will appear briefly in the display, followed by an indication of the percentage of SFI data already transferred, e.g.038P for 38%).

The duration of the download procedure will depend on the number of programmes that need to be updated. The maximum period in advance for which data is available is seven days. Based on the limit on total data that can be stored, this time-frame will be reduced the more programmes are listed in the electronic programme guide.

You can decide for yourself, which programme should be listed in the electronic programme guide. These can be added to the list as described in Point 8.2.1.

7.14.2 Interrupting the download

The download procedure can be interrupted by switching on the digital receiver (**On/Standby** key). The SFI data obtained during the previous update remains available.



(Fig. 7-12)

7.14.3 Viewing the Electronic Programme Guide

- > Switch on both the digital receiver and your television set.
- > Press the **SFI** key on the remote control of your digital receiver.
The electronic programme guide will now be displayed on screen (Fig. 7-12). The programmes you have selected, or which were listed as part of the default setting, are shown here with their current programmes being broadcast. You can now use the SFI function to obtain information on the contents of various programmes. You can also use the SFI functions to select a particular programme, to pre-select it for later viewing, or to add it to the timer programming.

7.14.4 Now (Table of current programme contents)

The SFI table "Now" (Fig. 7-12) listing current programmes will be displayed first. The yellow bar to the right of the programme name indicates the time elapsed of the current programme. The programme currently being viewed is highlighted.

- > Use the **arrow keys up/down** to move the marker one line at a time. Use the **arrow keys right/left** to move the marker one page at a time.
- > The SFI functions (Point 7.14.7) are now available.
- > Press the **yellow** function key to move to the SFI table "Next" (See Point 7.14.5)

or

- > Press the **TV/Radio** key to return to normal operation.

7.14.5 Next

- > Use the **yellow** function key to display the table "Next" (following programmes). (Fig. 7-13)
The SFI functions (Point 7.14.3) are available.
- > Press the **yellow** function key to move to the SFI table "More" (Point 7.14.6)

or

- > Press **green** function key or **Back** key to return to the previous SFI table "Now"

or

- > Press the **TV/Radio** key to return to normal operation.



(Fig. 7-13)

7.14.6 More

- > While the SFI table "**Next**" is displayed, press the **yellow** function key to display the SFI table "**More**". (Fig. 7-14)
An additional time window will be displayed in the title line of this table. This window will show the time of the SFI table displayed.
 - > Press the **yellow** function key to page onward by the time indicated in the **yellow** bar.
 - > Keep the **yellow** function key depressed to continue paging on. A clock will be shown to give you a better overview.
 - > Press the **green** function key to page backward
The individual days of the week are displayed along the lower border of your screen. If information is available for the following days, the corresponding fields will be highlighted.
 - > To obtain a preview for a specific day, press the appropriate number corresponding to the day of the week on the **numeric keys**
- or
- > Press **Back** to return to the table "**Next**".

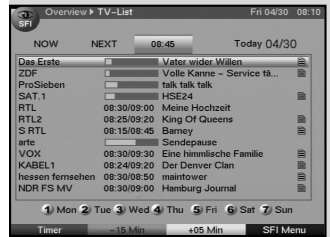

(Fig. 7-14)

7.14.7 SFI Functions

To perform the following SFI functions, call up the **SFI** as described in Point 7.14.3.

7.14.7.1 SFI Information

Use the **SFI Information** to obtain brief information on the programme or channel selected. Where SFI information is available, this will be indicated by  next to the corresponding programme.

- > Use the **arrow keys** resp. the **function keys** to highlight the desired programme.
- > Press the **SFI** key to display the information.
Lengthy text passages can be scrolled one line at a time by using the **arrow keys** or use the green or red function keys to move backward or forward one page at a time.
- > Press **Back** to return to the previous table.

7.14.7.2 Marking a programme

- > Use the **arrow keys** or the **function keys** to mark/pre-select the desired .
- > Confirm by pressing **OK**. The programme will be automatically marked, and will be selected when the broadcast begins.
- > Press **Back** to return to the previous table.

7.14.7.3 SFI Timer programming

Use the electronic programme guide SFI to simplify the programming of timer events.

Marking a programme

- > Use the **arrow keys** or **function keys** to mark the appropriate programme
- > Press **OK** to automatically mark the programme, the receiver will switch to this channel when the programme begins.

or

Recording a programme (timer operation)

- > Use the **arrow keys** to mark the desired programme.
- > Press the **OK** key twice to highlight the line in red and to accept the data for this programme directly into the timer memory.

or

- > Press the red function key (Timer/VCR) to open a selection window.
- > Use the **arrow keys up/down** to mark your desired **type** of timer.
- > Confirm by pressing **OK**.

The **timer menu** showing the data of the selected programme will be displayed for monitoring purposes. If necessary, you can make alterations or corrections at this stage (see 7.15).

- > Press Back to return to the previous table. The appropriate line will be highlighted. Your receiver will be switched on at the starting time of the programme selected. Most of the functions of the remote control are disabled at this stage to avoid any accidental interruption of the recording.

In standby mode the active timer will be indicated by the blinking of the colon in the time display.

Delete timer operation

If you wish to delete a timer event programmed by means of the SFI, proceed as described in Point 7.15. To abort an active timer, switch the digital receiver off by pressing the

On/Standby key.

Then press this key again to switch the receiver on, and proceed to operate it normally.

7.14.7.4 SFI Programme overview

The SFI programme overview function allows you to display the full daily programme of an individual channel. Proceed as follows:

- > Press the key **SFI**.
The SFI table "**Now**" will be displayed.

- > Press the **blue** function key **SFI Menu** to open a selection window.
- > Use the **arrow keys up/down** to mark the line **Programmes**.
- > Confirm by pressing **OK**. The overview for today of the programme selected will be displayed. (Fig. 7-15)
- > Use the **arrow keys** to move the marker to the appropriate programme or starting time.
- The individual days of the week are displayed along the lower border of your screen.
- If information is available for the following days, the appropriate fields will be highlighted.
- > To display the programme contents for a specific day, press the **numeric key** corresponding to the desired day of the week.

Displaying SFI overview for other programmes

- > Press the **green** function key **Programmes**. A list of SFI programmes will be displayed. (Fig. 7-16)
- > Now use the **arrow keys** to mark the desired programme.
- > Press the **OK** key to display the SFI overview of the marked programme.

7.14.7.5 SFI overview by programme type (category)

If you are particularly interested in certain types of programme, you can have the programme information displayed according to certain categories such as movies, news, etc.

- > Press the **SFI** key. The SFI table “**Now**” will be displayed.
- > Press the **blue** function key **SFI Menu** to open a selection window.
- > Use the **arrow keys up/down** to mark the line **Categories**.
- > Confirm by pressing **OK**.
- > Use the **green** function key **Categories** to open a window showing the programme categories available. (Fig. 7-17)
- > Use the **arrow keys** to select the desired programme category, and confirm by pressing **OK**. An overview of the day’s programmes conforming to this category will be displayed. (Fig. 7-18)
- > Use the **arrow keys up/down** to move the marker to any specific programme.
- > Use the **arrow keys right/left** to move the marker to programmes with a later starting time.



(Fig. 7-15)



(Fig. 7-16)

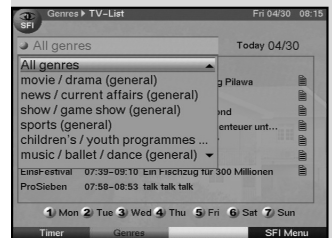

(Fig. 7-17)



(Fig. 7-18)

The individual days of the week are shown along the lower border of the screen. If information is available for any of the following days, the corresponding fields will be highlighted.

- > To display the programme contents of a specific day, press the appropriate **numeric key** corresponding to the day of the week.

7.14.8 Exiting SFI

- > Press the **Menu** or **TV/Radio** key to return to normal operation.

7.15 Timer recording

Your receiver is equipped with both a video recorder timer and a programme switching timer. In terms of their programming, these two timer types differ only with regard to the respective categories..

You can programme your timer manually as described in this chapter, or by means of the SFI function, as described in Point 7.14.7.

1. Video recorder timer

Use a video recorder timer to switch your digital receiver on and off in your absence, in order to record a programme by means of an external recording unit, e.g. a video recorder. Please note that you must also programme your video recorder in order to record the programme.

If the unit was switched on by means of the video recorder timer, this will be indicated by "rec" in the display. Most of the remote control functions will be disabled, to avoid an accidental interruption of the recording. In stand-by mode, the active timer will be indicated by the colon in the LED resp. time display blinking.

2. Programme change timer

If your unit is in normal operating mode, it will switch to the pre-selected programme slot at the selected time. Unlike the video recorder timer mode, all the functions of the unit remain operational, and the unit will not be switched off at the end of the programme.

Manual timer programming

- > Press the Menu key to display the **Main Menu**.
- > Use the **arrow keys up/down** to mark the line **Timer organizing**.
- > Confirm by pressing **OK**.
The sub-menu **Timer organizing** will be displayed. (Fig. 7-19)
- > Use the **arrow keys up/down** to select the type of timer you wish to programme.



(Fig. 7-19)

- > Press **OK** to go to the entry window used to programme a new timer event. (Fig. 7-20)

To programme a timer event, proceed as follows:

Source

- > Use the **arrow keys** to mark the column **Source**.
- > Press **OK** to enter the desired source (TV or Radio).
- > Use the **arrow keys up/down** to mark the desired source (**TV** or **Radio**).
- > Press **OK**.
- > Use the **arrow keys** to mark the column Channel.
- > Press **OK**.
- Depending on the previous setting, either the TV or the radio programme list will now be displayed.
- > Use the **arrow keys** to mark the desired programme.
- > Use the **arrow keys up/down** to move the marker around the list one line at a time.
- > Use the **arrow keys right/left** to move the marker backward or forward in the list one page at a time.
- > Press **OK** to accept this into the timer programming.

Date

- > Use the **arrow keys** to mark the column **Date**.
- > Use the **numeric keys** to enter the date on which you wish to record a programme.

Start

- > Use the **arrow key right** to mark the column **Start**.
- > In this line, use the **numeric keys** to enter the starting time for the timer.

Stop

- > Repeat the steps as described under “Start” to enter the stopping time.

Repeat

- > Use the arrow keys to mark the column Rep.
- > Press **OK**.
- A selection window will be displayed, offering various suggested repeating intervals.
- 1x** Timer used once only
- T** Daily repeat
- 1 W** Repeat once weekly
- 1-5** Repeat only on weekdays
- 6-7** Repeat only on weekends
- > Use the **arrow keys up/down** to select the desired function.
- > Press **OK** to accept the setting into memory.



(Fig. 7-20)

Transferring data into memory

- > When you have completed the programming, press the **yellow** function key **Accept** to transfer the data into memory.
If under **Programme** you have selected a programme that is blocked as per Point 8.3, you must first enter the PIN code before the data will be accepted into memory.
- > Press the **TV/Radio** key to return to normal operation.

Timer overview

The timer overview function will display a list of all timer events already programmed.

- > To display the menu **Timer overview**, call up the menu **Timer organizing** as described above.
- > Use the **arrow keys up/down** to mark the line **Timer overview**.
- > Confirm by pressing **OK**.

If there is an overlap of timer events, these overlaps will be marked in red.

Changing timer programming

- > To change an existing timer setting, use the **arrow keys up/down** to mark the timer event you wish to change.
Press the **yellow** function key **Change** to move to the settings of the marked timer. You can now effect the changes as described in Point 7.15.1.2.
- > When you have completed the programming, press the **yellow** function key **Accept** to transfer the data into memory.

Deleting timer programming

- > To delete an existing timer setting, use the **arrow keys up/down** to mark the setting.
- > Press the **green** function key **Delete**.
The message will be displayed: "Do you really want to delete this timer?"
- > Use the **arrow keys right/left** to mark **Yes**.
- > To delete the timer entry, confirm by pressing **OK**.
- > Press the TV/Radio key to return to normal operation.

Programming a new timer event

- > To programme a new timer event, use the **arrow keys up/down** to mark a free line in the menu **Timer overview**.
- > Press the **yellow** function key **New** to go to the entry window used to programme the new timer event. Work through this as described above.

- > Use the **arrow keys up/down** to mark the additional field **Type**.
- > Confirm by pressing **OK**. A window will be displayed, showing the various available types of timer.
- > Use the **arrow keys up/down** to select the desired timer type.
- > To accept the timer type, confirm by pressing **OK**.
- > When you have completed the programming, press the **yellow** function key **Accept** to transfer the data into the timer memory.

Note!!!

Please check that the unit has acquired the clock time. If activated as described in Point 6.2.5, this will be shown on the display in stand-by mode. If this is not the case, leave your unit switched to a major channel for approx. 30 seconds, so that the current time can be downloaded.

The time should now be displayed in stand-by mode, if it has been activated as per Point 6.2.5.

8 Changing the basic programming

8.1 Configuring the Favourites list

This chapter describes how you can change the pre-programming of your digital receiver as well as the Favourites programme list according to your preferences. This function is also required to sort newly found programmes into the list after a search has been carried out.

In this regard you should know the following: your receiver is equipped with two programme lists, the **Favourites list** and the **Total list**. The Favourites programme list includes all the programmes you have placed there, using the procedure as described below. The Total list contains all programmes.

This chapter also describes how you can delete programmes, or restrict access to programmes by means of the parental control feature. When calling up a programme list by pressing **OK** the Favourites programme list will be displayed.

8.1.1 Calling up the Navigator (Programme List Manager)

To manage the Favourites list, proceed as follows:

- > Press the **Menu** key to call up the **Main Menu**. (Fig. 8-1)
- > Use the **arrow keys up/down** to mark the line **Manage TV lists**, to work on the TV list, or **Manage Radio list**, to work on the radio list.



(Fig. 8-1)



(Fig. 8-2)

- > Confirm by pressing **OK**.
The appropriate Navigator will be displayed, allowing you to work on the Favourites list (TV or radio list). (Fig. 8-2)
- The Favourites list will be displayed on the right half of the screen. This is currently active, as the programme currently selected is highlighted in blue. The alphabetically sorted Total list will be displayed on the left half of the screen.

This Total list includes all available programmes.

- > Press the **red** function key to move the marker to the Total list. This is now active.
- > Press the **red** function key again to open a selection window. You are given the option of sorting the Total list according to various selection criteria (e.g. all programmes, all free-to-air, all newly found, all English-language programmes, etc.) or sorted by **Providers**.
- > Use the **arrow keys up/down** to select the preferred programme listing (e.g. Total list).
- > Confirm by pressing **OK**.

An additional selection window will be displayed. (Fig. 8-3)



(Fig. 8-3)

- > Now use the **arrow keys up/down** to mark the selection criterion according to which the Total list is to be sorted. Select e.g. **All Programmes**, to indicate all available programmes in the Total list or **All new**, to indicate only the newly found programmes of the last programme search or **All English**, to indicate only English-language programmes.
- > Confirm by pressing **OK**.

Depending on your selection, a programme list will now be displayed showing, e.g., all, all new or all English-language programmes. Programmes already included in the Favorites list are indicated by a check-mark.

- > Press the **red** function key **Programmes** resp. the **green** function key **TV List** can switch between the Favourites list and the Total list. The currently active list is indicated by a blue marker.

8.1.2 Adding programmes to the Favourites list

To accept programmes from the Total list into the Favourites list, call up the Navigator as described in Point 8.1.1, and switch to the Total list.

- > Press the **blue** function key **Functions**.
A selection window will be displayed, indicating the available Navigator functions. (Fig. 8-4)
- > Use the **arrow keys up/down** to mark the line **Add**.
- > Confirm by pressing **OK**.



(Fig. 8-4)

- > Use the **arrow keys up/down** to mark a programme that you wish to include in the list.
- > Press the **yellow** function key **Add** to add the marked programme to the Favourites list.

Marking blocks of programmes

To mark several programmes simultaneously proceed as follows:

- > Press **OK** to access the Selection mode. The marked programme will be indicated by a cross at the left side of the entry.
- > Use the **arrow keys up/down** to mark the following and/or previous programmes as well.
- > When you have marked all the programmes you wish to select, press the **yellow** function key **Add**, to include the marked programmes in the Favourites list.

8.1.3 Deleting programmes

8.1.3.1 Removing (deleting) from the Favourites list

To remove programmes from the Favourites list, call up the Navigator as described in Point 8.1.1. You will move to the Favourites list.

- > Press the **blue** function key **Functions**. A selection window indicating the Navigator functions will be displayed. (Fig. 8-5)
- > Use the **arrow keys up/down** to mark the line **Remove**.
- > Confirm by pressing **OK**.
- > Use the **arrow keys up/down** to mark a programme that you wish to remove from the list.
- > Press the **yellow** function key **Remove**. The following message will be displayed: "Remove programme(s) from the list?".
- > Use the **arrow keys right/left** to mark **Yes** or **No**.
- > Confirm your entry by pressing **OK**.
- > To remove several programmes simultaneously, mark these as described in 8.1.2 (**Marking blocks of programmes**).
- > When you have completed marking the programmes you wish to remove in this manner, press the **yellow** function key **Remove**. The message will be displayed "Do you really want to delete the programme(s)?".
- > Use the **arrow keys right/left** to mark **Yes** or **No**.
- > Confirm your entry by pressing **OK**.

The programmes deleted in this manner remain in the Total list, and can be added to the Favourites list again at any time.



(Fig. 8-5)



(Fig. 8-6)

8.1.3.2 Deleting from the Total list

To remove programmes from the Total list, proceed as described in Point 8.1.3.1. However, after calling up the Navigator, press the **red** function key **Programmes**, and move to the Total list first before selecting the function **Delete**.

8.1.4 Sorting programmes

Call up the Navigator as described in Point 8.1.1 to sort the programme order of the Favourites list according to your personal preference. The Favourites list will be active.

- > Press the **blue** function key **Functions**. A window will be opened, indicating the Navigator functions available. (Fig. 8-6)
- > Use the **arrow keys up/down** to mark the line **Sort**.
- > Confirm by pressing **OK**.
- > Use the **arrow keys up/down** to mark the programme you wish to move to another place in the list.
- > Now press the **yellow** function key **Sort**. A double arrow will be displayed next to the programme selected.
- > You can now use either the **arrow keys up/down** or the **numeric keys** to move the marked programme to the desired position in the list.
- > Press the **yellow** function key **Sort** to save the programme at the new position.
- > To sort several programmes simultaneously, mark these as described in 8.1.2 (**Marking blocks of programmes**).
- > Now press the **yellow** function key **Sort**. A double arrow will be displayed next to the block of programmes selected.
- > You can now use either the **arrow keys up/down** or the **numeric keys** to move the block of programmes to the desired list position.
- > Press the **yellow** function key **Sort** to save the block of programmes at the new position.
- > When you have completed configuring the programme list according to your preference in this manner, press the **Menu** key to return to normal operation.

8.2 Programming the electronic programme guide

To improve the readability, you can also configure the electronic programme guide SFI to conform to your favourite programmes. To add programmes to the electronic programme guide, or to delete them from the guide, call up the Navigator as described in Point 8.1.1. You are now in the Favourites list.

Please note:

The more programmes are added to the electronic programme guide, the longer it will take to update the SFI data! Also, the more programmes are added, the less likely it is that the full preview period of seven days for the electronic programme guide can be accommodated in the limited memory space available.

- > Press the **Menu** key to display the **Main Menu**.
- > Use the **arrow keys up/down** to mark the line **Settings**.
- > Confirm by pressing **OK**.
The sub-menu Settings will be displayed.
- > Use the **arrow keys up/down** to mark the line **Programme Guide**.
- > Confirm by pressing **OK**.
The menu **Programme Guide** will be displayed. (Fig. 8-7)
- > Use the **arrow keys up/down** to move the marker around within the menu, and to change the various positions. When selecting a menu item, please also note any messages displayed on the screen.

8.2.1 Selecting a channel

- > Press the **OK** key. The Favourites list of the mode selected (Radio or TV) will be displayed. The programme currently selected will be highlighted. (Fig. 8-8)
- > Press the **green** function key to switch between radio and TV lists.
- > Press the **red** function key to display a selection window. Here you can select the desired type of programme list.
- > Use the **arrow keys up/down** to select the desired type of programme list, e.g. Favourites list.
- > Confirm by pressing **OK**. The programme list selected will be displayed.
- > Use the **arrow keys** to mark a programme you wish to include in the electronic programme guide.
- > Press the **yellow** function key **SFI** to accept the marked programme into the electronic programme guide.
- > To add several programmes to the electronic programme guide simultaneously, proceed as described in Point 8.1.2 (**Marking blocks**).
- > When you have completed marking the desired programmes in this way, press the **yellow** function key **SFI**, to accept the marked programmes into the electronic programme guide.
- > Press the **Menu** key to return to normal operation.

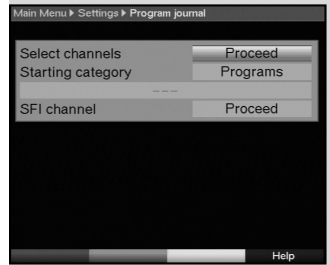

(Fig. 8-7)



(Fig. 8-8)

You can now initiate the updating procedure manually:

> Use the **On/Standby** key to switch off the receiver (Standby).

> Now, while the display shows “oooo”, press the key **SFI**.

The receiver will now perform an update. This will be indicated by the message **SFI**d appearing briefly in the display, followed by a progressive indication of the percentage of SFI data already downloaded.

> The updating procedure may be interrupted by switching on the digital receiver (Key **On/ Standby**).

8.2.2 Start category

The electronic programme guide is equipped with various display/presentation modes (categories).

Overview

This display mode gives you a quick overview of all programmes included in the electronic programme guide.

Programmes

This display mode shows the programmes for the current day for one specific channel.

Genres

If you are interested in particular types of programmes, you can display the programme information sorted according to specific genres, such as movies, news, etc..

Last used

When this setting is selected, the unit will always show the last type of display used when the SFI is called up.

> In this line, use the **arrow keys left/right** to select the display mode you wish to utilise when the electronic programme guide is called up.

> If you select **Genres**, you can use the **arrow keys** to further select the preferred category, e.g. movies, news, shows, etc..

8.2.3 SFI Channel

Your receiver is equipped to receive a data channel carrying additional SFI (EPG) data. This allows you to see programme previews covering as much as a whole week.

> Press **OK**, to display the sub-menu **SFI Channel** (Fig. 8-9).

Source

> Use the **arrow keys** to mark the field **Source**, and confirm by pressing **OK**.

> Use the **arrow keys up/down** to select the channel from which the SFI data is to be downloaded, and confirm by pressing **OK**.



(Fig. 8-9)

Your receiver will now check whether SFI data is being received on the channel selected. This information will be displayed along the bottom of the window.

Update time

- > In the line **Update time** use the **numeric keys** to set the time at which you wish the automatic download of SFI data to be performed.

Updating

- > To download the data of the data channel, mark the line **SFI Updating**.

Switch the function on by pressing **OK**.

If you do not wish to receive the additional data, or if you are unable to receive the data because of your location, the data reception function can also be switched off:

- > Set the **SFI Updating** function to **off**, to switch off the data reception. Only the programme information provided by programme providers will then be available.

Starting download procedure manually

- > To start the updating of SFI data manually, press the **red** function key **Start now**.

8.3 Parental control (blocking programmes)

Your unit is equipped with a parental control function. This means that important functions (e.g. calling up the main menu) can be protected from unauthorised manipulation. In addition, programmes and recordings that you have specifically blocked can only be accessed after entering a four-digit PIN code (unit PIN).

To work with the **Parental Control** menu proceed as follows:

- > Press the **Menu** key to display the **Main Menu**.
- > Use the **arrow keys up/down** to mark the line **Settings**.
- > Confirm by pressing **OK**.
The sub-menu **Settings** will be displayed.
- > Use the **arrow keys up/down** to mark the line **Parental Control**.
- > Confirm by pressing **OK**.
The menu **Parental Control** will be displayed.
(Fig. 8-10)
- > Use the **arrow keys up/down** to move the marker within the menu, and to change the individual positions as indicated. When selecting a menu item, please also note any messages displayed on the screen.

8.3.1 Changing the receiver PIN code

The receiver PIN code is set at the factory to **0000**.

To change the receiver PIN code proceed as follows:

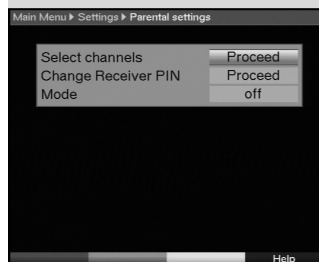

(Fig. 8-10)

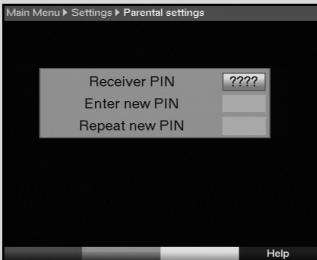

(Fig. 8-11)

- > Use the **Menu** key to call up the **Main Menu**.
- > Use the **arrow keys up/down** to mark the line **Settings**.
- > Confirm by pressing **OK**.
The sub-menu **Settings** will be displayed.
- > Use the **arrow keys up/down** to mark the line **Change Receiver PIN**.
- > Confirm by pressing **OK**.
- > Now use the **numeric keys** to enter the current receiver PIN code (**Default setting 0000**).
(Fig. 8-11)
- > Use the **numeric keys** to enter the desired new receiver PIN code.
- > Repeat the entry of the code.
- > When you have changed the receiver PIN code as described here, press the **Menu** key to return to normal operation.

Note!

Ensure that you do not forget the receiver PIN code. If you do forget it, please consult your specialist retailer!

8.3.2 Mode

- > In this line, use the **arrow keys left/right** to switch the parental control **on** or **off**.

8.3.3 Selecting a programme

- > Press **OK**. The Favourites list of the selected range (TV or Radio) will be displayed. The programme currently selected will be highlighted.
(Fig. 8-12)
- > Press the **green** function key to switch back and forth between radio and TV lists.
- > Press the **red** function key to display a selection window. Here you have the option of selecting the desired type of programme list.
- > Use the **arrow keys up/down** to select the desired type of programme list, e.g. Favourites list.
- > Confirm by pressing **OK**. The programme list selected will be displayed.
- > Now use the **arrow keys** to mark the programme which you wish to block.
- > Block access to the programme by pressing the **yellow** function key. The parental control symbol  will be displayed next to the programme selected.
- > To block access to a number of programmes simultaneously, proceed as described in 8.1.2 (**Marking Blocks**) and block the whole group by pressing the **yellow** function key.

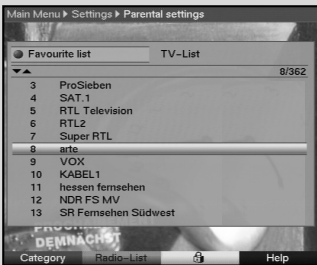

(Fig. 8-12)

- > When you have completed configuring the programme list according to your preference, press **Menu** to return to normal operation.
- > To lift the blocking of individual programmes, proceed as described above. Mark the specific programme, and press the **yellow** function key to remove the Parental Control symbol.

8.4 Programme search (scan)

To receive new programmes, several options exist to carry out a programme search.

1. Automatic search

Select this type of search to scan the entire reception frequency band of the receiver for programmes.

2. Expanded search

Select this type of search to scan a specific frequency or channel range for programmes.

3. Manual search

Select this type of scan to scan a particular channel or frequency for programmes. Use this type of scan to look for a specific programme by means of programme-specific PID numbers.

After the scan has been completed, a message will be displayed on screen indicating how many programmes your digital receiver has found, how many of these are new, and how many are broadcast in encrypted form. New programmes will be stored in the **Total list**, and can then be transferred to the **Favourites list** as described in Point 8.1.

- > To perform a programme search, first call up the **Main Menu**. (Fig. 8-13)
- > Use the **arrow keys up/down** to mark the entry **Programme Search**.
- > Confirm by pressing **OK**.
The sub-menu **Programme Search** will be displayed (Fig. 8-14)
- > Now use the **arrow keys up/down** to select the type of scan you wish to perform. Confirm by pressing **OK**.

8.4.1 Automatic Scan

If this type of scan is selected, the entire reception frequency range of the receiver will be scanned for programmes. The scanning procedure may take more than 15 minutes. Please also note any messages displayed on the screen.

- > You can terminate the scan by pressing the **red** function key.

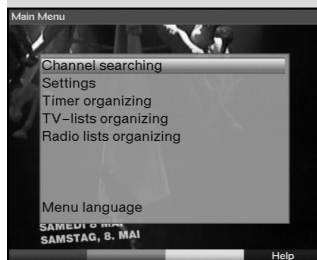

(Fig. 8-13)

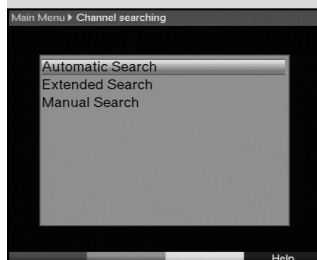

(Fig. 8-14)



(Fig. 8-15)

8.4.2 Expanded Scan

When using the expanded scan function (Fig. 8-15) you have two options for performing a programme scan.

1. Frequency scan

When using the frequency scan mode, a specific frequency range selected by the user will be scanned for programmes.

2. Channel scan

When using the channel scan mode, a specific range of channels selected by the user will be scanned for programmes. The channel scan mode is faster than the frequency scan mode.

- > Press **OK** to display a selection window showing the available scan mode options.
- > Use the **arrow keys up/down** to mark the scanning mode you wish to perform.
- > Confirm by pressing **OK**.
- > Use the **arrow keys up/down** to mark either the field **Start Channel** or **Start Frequency**.
- > Use the **arrow keys left/right** to enter the start channel, or use the **numeric keys** to enter the start frequency.
- > Use the **arrow keys up/down** to mark the field **Stop Channel** resp. **Stop Frequency**, and proceed as described above to enter the stop channel or the stop frequency.
In the line **Scan Mode** you can decide whether you wish to search only for free-to-air programmes, or whether you wish to include encrypted programmes as well.
- > Use the **arrow keys up/down** to select the desired **Scan Mode**.
- > Press **OK**, to decide whether you wish to scan only for free-to-air programmes (**Only free**) or whether you wish to include encrypted programmes (**All Programmes**).
- > Press the **red** function key **Start Scan** to initiate the programme scan.
The scan will commence. Please note any messages displayed on the screen.
- > You can terminate the scan by pressing the **red** function key **Abort**.

The scanning procedure may take more than 15 minutes. Please note any messages displayed on the screen.

8.4.3 Manual Scan

Should a programme not be found by either the automatic scan or the expanded scan, you can scan a specific channel for available programmes, or you may use PID data to search for a specific programme. These numbers may have to be found in the Internet, or obtained from the relevant programme provider.

- > To scan a particular channel (Fig. 8-16), use the **arrow keys left/right** to enter the desired channel.
- > Press the **red** function key **Start Scan** to initiate the scan.

PID scan

- > Enter the channel on which the desired programme is broadcast as described above.
- > Use the **green** function key PID scan to enter the PCR, Audio and Video PID. (Fig. 8-17)
- > Now use the **arrow keys up/down** to mark the lines **PCR PID**, **Audio PID** and **Video PID** and use the **numeric keys** to enter the appropriate values.

8.4.4 After the scan

You can follow the progress of the programme scan on screen while it is still in progress. When the scan is completed, the total number of programmes found as well as the number of new programmes found will be indicated. In addition, a prompt will be displayed, asking you whether you wish to save the programmes found automatically in the TV or Radio list. If you wish to accept the programme list automatically, you can then decide whether the programmes should be added to the Favourites list in **sorted** or **unsorted** form.

Sorted

The programmes found will be sorted into the Favourites list in accordance with a pre-programmed list. The order in which programmes are listed will depend on the audio language selected in Point 6.3.2 resp. the country selected in Point 6.2.2.

Unsorted

The newly found programmes will be added to the end of the Favourites list in unsorted form.

No

The newly found programmes will not be added to the Favourites list, and will only be added to the Total list.

- > Use the **arrow keys left/right** to indicate whether you wish to accept the programmes in **sorted** or **unsorted** form.



(Fig. 8-16)

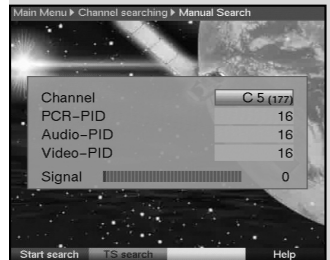

(Fig. 8-17)

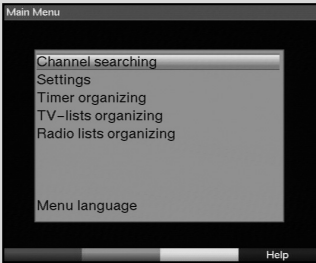

(Fig. 8-18)

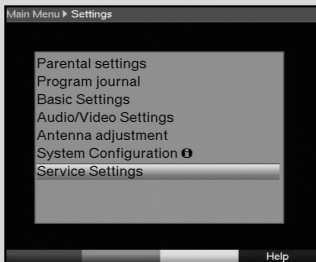

(Fig. 8-19)

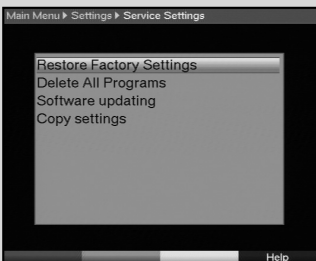

(Fig. 8-20)

- > Confirm by pressing **OK**.
Please note any other messages displayed on screen.
- > Press the **Menu** key to return to normal operation.
- > Independently of whether you have added the found programmes automatically to the Favourites list, you can still add these to the Favourites manually at any time, as described in Point 8.1.

8.5 Service settings

You can revert to the factory-installed default settings at any time. Also, if the programme list has become outdated by virtue of changes effected by the programme providers, you can delete this completely and perform a new programme search/scan. Please note that, if you have used the delete function, you must then initiate a scan, and copy the programmes found from the Total list to the Favourites list.

- > Press the **Menu** key to display the **Main Menu**.
(Fig. 8-18)
- > Now use the **arrow keys up/down** to select the menu item **Settings**.
Confirm by pressing **OK**.
The sub-menu **Settings** will be displayed.
(Fig. 8-19)
- > Now use the **arrow keys up/down** to mark the menu line **Service Settings**.
Confirm by pressing **OK**.
The sub-menu **Service Settings** will be displayed.
(Fig. 8-20)

8.5.1 Activating default (factory) setting

When this function is called up, the original default programming will be restored, as set at the factory, any personal settings will be deleted, and the **AutoInstall installation** assistant will be started.

- > Use the **arrow keys up/down** to mark the line **Activate default setting**.
Confirm by pressing **OK**.
The message will be displayed: "Do you really wish to activate the default setting?".
- > Use the **arrow keys left/right** to select either **Yes** or **Abort**.
- > Confirm your entry by pressing **OK**.

8.5.2 Delete all programmes

This function will delete all programme memory banks.

- > Use the **arrow keys up/down** to mark the line **Delete All Programmes**.
Confirm by pressing **OK**.
The following message will be displayed; "Do you really wish to delete all programmes?".

- > Use the **arrow keys left/right** to select **Yes** or **Abort**.
- > Confirm your selection by pressing **OK**.

8.5.3 Updating Software

You also have the facility of updating the operating software of your digital receiver.

- > Press **OK** to display the sub-menu **Software update** (Fig. 8-21).
To perform a software update, mark the line **Software update**.
- > Set the software update function to **on** by pressing **OK**.
- > In the line **Update time**, use the **numeric keys** to set the time when the software update is to be carried out.
- > To initiate the update for the operating software manually, press the **red** function key **Test**.
- > Press the **Menu** key to return to normal operation.

Should the parameters of the data used to download the software update have changed, you can correct these via the menu. Current transmission data can be obtained via your retailer. Under normal circumstances, there should be no need for you to make any changes in this menu.

Note:

For the new software version to be downloaded automatically, the digital receiver must be in standby mode. The downloading procedure is indicated by “TERL”, followed by “TER0” to “TER9” in the display. Ensure that this procedure is not interrupted by switching the receiver on or off while the download is in progress.

Independent of whether you have switched the automatic software update function on or off, the receiver will check automatically each time it is switched on whether a new version of the operating software for your digital receiver is available. If a new version of the operating software is available, this will be indicated by a message displayed on screen. To start the software update, follow the instructions displayed on your screen.

8.5.4 Copying settings

You have the facility to copy all the settings of the programme list, antenna settings, etc. of your digital receiver from your receiver to another digital receiver of the same type, and using the same operating software version. (Fig. 8-22)

- > Use a null modem cable to connect the two receivers.
- > Switch on the receiver to which the settings are to be transferred.



(Fig. 8-21)

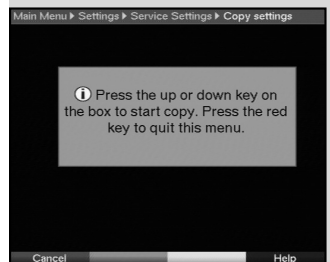

(Fig. 8-22)

- > To copy the settings, press one of the keys on the panel of the source receiver.
The settings of this source receiver will now be transferred to the other, receiving, receiver. Please note any messages displayed on screen.

8.6 System configuration

Use this menu item to view the specific data relating to your receiver.

- > Use the **arrow keys up/down** to mark this line in the sub-menu **Settings**.
- > Confirm by pressing **OK**.
- > Press the **Menu** key to return to normal operation.

9 Technical terms

Antenna cable:

Cable used to connect the modulator of the satellite receiver to the antenna input socket of the television set. Used as an alternative where no SCART socket is available

AV: see SCART

Channel:

Part of a frequency band, divided and allocated by an agreed system. A TV channel consists of two frequencies, one for the audio and one for the visual content. Each channel is described in terms of a numeric description (with the exception of European television channels broadcast in the frequency band 40-230 MHz, these are denoted by letters).

Data compression/MPEG1/MPEG2:

The transmission of the current television standard (625 lines, and a picture frequency of 50 Hz) results in a digital data volume of 216 MBit/s.

This would require enormous bandwidths which are simply not available, whether via satellite or via terrestrial reception. Therefore the data is compressed in order to achieve a reduction in the data volume. For Europe, MPEG-2 has been laid down as the world-wide standard for data compression. MPEG2 is an expanded version of MPEG1

Coaxial cable:

Cable used to connect the LNC to the satellite receiver, used to transmit the signal received as well as to provide power to the LNC.

DVB:

Digital Video Broadcasting: A digital universal broadcast technology used to transmit pictures, graphics, sound and text, i.e. data in any form imaginable form, in appropriate quality.

Frequency:

A physical term, indicates the number of vibrations per second, expressed in terms of the unit Hertz (Hz)

DVB-T receiver:

The signals received by the antenna cannot be processed by the television set. The DVB-T receiver processes them in such a way that audio and video signals (AV) are available at its outputs, which can then be passed on to the television set.

OSD:

On Screen Display - data shown on screen

PID:

Packet Identifier, Packet-ID

Receiver:

The signals received from the antenna cannot be processed by the television set. The signals are processed by the receiver so that audio and video (AV) signals are generated at its outputs that can be handled by the television set.

SCART:

Type of connector used on television sets, video recorders, satellite receivers and other home electronics components to transmit audio and video signals (AV).

Software Update:

Digital television is a new medium that provides improved sound and picture quality as well as the facility to provide interactive services. These new services are constantly being developed and improved by the providers. To utilize the services, it may occasionally be necessary to update the software of the digital receiver.

Signal:

General description for data, for information, sound or pictures, the content of which is modulated electrically to broadcast the data over a distance, or to connect various suitable reception and viewing units with each other.

10 Technical data

DVB-T Tuner:

Input frequency range	174.... 230 MHz / 470 860 MHz
Tuner input	IEC socket
Input/output impedance	75 Ohms
Tuner output	IEC jack
Bandwidth	7/8 MHz (switchable)
S/N ratio	<8dB
Demodulation	COFDM 2k/8K
No. of carriers	1705/6817
Guard Interval	1/4, 1/8, 1/16, 1/32
Constellation	QPSK, 16-QAM, 64-QAM
antenna feed	5V/0,03A (double insulated, switchable)

Demultiplexing:	in accordance with ISO 13818-1
Video decoding:	MPEG-2 and MPEG-1 compatible
Video compression	Up to MP@ML (main profile @
main level)	
Video standard	PAL / 25 Hz
Active screen area	720 pixels x 576 lines
Picture format	4 : 3 / 16 : 9
Picture material 16:9	Automatic adaptation for 16:9 TV sets (via SCART)
	Letterbox filtering for 4:3 TV sets
Audio decoding:	
Audio compression	MPEG-1 & MPEG-2 Layer I and II
Audio Mode	Dual (main/sub), Stereo
Sampling frequencies	32 kHz, 44.1 kHz, 48 kHz
Audio parameters:	
Output analogue:	
Output level L/R	0,5 V r.m.s. (nominal)
Output impedance	600 Ohms
THD	> 60 dB (1 kHz)
S/N	> 60 dB
Cross-talk	< - 65 dB
Input analogue:	
Input level l/r	0,5 V r.m.s. (nominal)
Input impedance	> 40 kOhm
Volume at switch-on	Automatic output of volume level previously selected
	Dolby Digital AC3
Video parameters:	
Output:	
Output level FBAS	1 Vs-s +/- 0.3 dB into 75 Ohms
Output level RED	0,7 Vs-s +/- 0.1Vp-p into 75 Ohms
Output level GREEN	0,7 Vs-s +/- 0.1Vp-p into 75 Ohms
Output level BLUE	0,7 Vs-s +/- 0.1Vp-p into 75 Ohms
S/N rated	> 60 dB
Connections:	
TV SCART:	
Output:	FBAS or RGB or S-Video
VCR SCART:	
Output:	FBAS or S-Video
Input:	FBAS or RGB or S-Video
Audio output digital:	
S/PDIF output	electrical, cinch socket (yellow)
Audio output analogue:	
Audio channel left/right	cinch sockets (white, red)
Video text:	
Teletext filtering	in accordance with ETS 300 472
Standard	
Scanning teletext data	(FBAS) corresponding to ITU-R BT.653-2 lines: 6-22 and 320-335

Soft video text 800 pages memory (DigiPal 2)
1000 pages memory (DigitMod T1)

Display:

LED display 4-digit (7 segment) (DigiPal 2)
LED green and red (DigitMod T1)

Serial interface RS 232:

Type RS 232, bidirectional
Bit rate 115,2 kBit/s max.
Connection D-SUB socket, 9-pin
Function Update for operating system software, pre-programming

Programme memory:

Number of programmes, Favourites list TV:
999 TV programmes
Number of programmes, Favourites list:
999 RADIO programmes

Number of programmes:

Total list TV/Radio: 4000 programme possible in Total list

SFI data:

SFI preview: maximum 7 days in advance

Timer:

Events: maximum 124 (DigiPal 2)
30 (DigitMod T1) events,
one year in advance

Remote control system: RC-5
Sub-system address 10 (SAT 2)
Modulation frequency 36 kHz
Infra-red wavelength 950 nm

Optional remote control:

Sub-system address 8 (SAT 1)

Power supply:

Mains adapter:

Power consumption (DigiPal 2):

3,4 VA Stand-by mode (standby clock on)
3,0 VA Stand-by mode (standby clock off)
7 VA in operation

Nominal power supply (DigiPal 2):

230 V / 50 Hz alternating current

Input power supply (DigiPal 2):

180 V... 250 V / 47 ... 63 Hz alternating current

Input power supply (DigitMod T1):

12 V / 0,5 A

Power consumption (DigitMod T1):

3,5 W Stand-by mode
7,5 W in operation

General:

DigiPal 2:

Dimensions (WxDxH): 205 mm x 130 mm x 35 ... 38 mm
Weight: approx. 370 g

DigitMod T1:

Dimensions (WxDxH): 155 mm x 105 mm x 30 ... 35 mm
Weight: approx. 230 g

11 Trouble-shooting guide

Problem	Possible cause	Solution
Various programmes not shown in the programme list	Wrong programme list selected	Select another programme list (see Point 7.2.3.1)
Sound OK, no TV picture	Radio mode selected	Switch to TV mode
Clock time not shown in stand-by mode*	Clock time not downloaded Stand-by clock switched off	Go to a major channel for 30 secs. Switch on stand-by clock (Point 6.2.5)
Unit cannot be operated	Defective data stream-->unit blocked	Pull mains plug for approx. 5 secs., then switch unit on again Press stand- by key on unit for approx. 5 seconds
Remote control not working	Batteries spent	Insert new batteries
Picture temporarily shows blocks. Unit switches temporarily to freeze frame, no sound. Screen temporarily black with message "No signal".	Antenna incorrectly positioned	Adjust antenna position
No picture, no sound, display on	Defective or no cable connection	Check all cable connections
	Antenna incorrectly positioned	Adjust antenna position
No reception when using an active antenna	Antenna power feed (5V) not switched on	Switch on antenna power feed (Point 6.2.4)
No picture, no sound, display off	No mains power	Check mains cable and plug
No reception of programmes previously received	Antenna defective, or incorrectly positioned	Check antenna
	Programme now broadcast on another channel	Perform scan (see Point 8.4)
	Programme no longer being broadcast	None
Unit cannot be switched on, or cannot be operated	Unit blocked	Perform flash-reset: Note! All personal settings will be lost. <ul style="list-style-type: none"> > Disconnect mains plug. > Simultaneously press Programme up and Programme down keys on the unit and hold down. > While Programme up and down keys are pressed, re-connect mains power plug. > Keep keys pressed for approx. 5 secs. until message * "FLAS" is displayed.

Notes

Notes

Index

AC3	18, 21
Antenna adjustment	18
Antenna feed	16
Automatic search	41
Channel information	23
Clock	22
Country	16
Deleting programmes	36
Disposal advice	9
Dolby Digital	18, 21
Electronic Programme Guide	25
Expanded search mode	42
Freeze frame	23
Frequency	46
Genre	29
Infobox	20
Initial installation	12
Language	21
Manual search mode	43
MPEG1	46
MPEG2	46
Navigator	19
Operating language	15
Operation	18
Parental control	39
Picture format	17
Programme information	23
Programme list management	33
Programme search mode	41
Remote control code	16
RS 232	12
Safety advice	9
SCART	47
Serial interface	12
SFI channel	38
SFI (Electronic Programme Guide)	25
Software updates	45
Sorting programmes	36
Sub-titles	24
System configuration	46
Timer recordings	30
TV/Radio switching	22
Unit PIN	39
Video text	23
Volume control	21
When not in use	9

For daily use

Switching on and off

- > Switch on the digital receiver by pressing the **On/Standby** key, either on the receiver or on the remote control.
- > Press this key again to switch the receiver off.
- > The receiver is now in standby mode, the display on the receiver shows the time.

Programme selection

Using the programme up/down keys

- > Use the **programme keys up/down** either on the remote control or on the receiver to move up or down one programme slot at a time.

Using the numeric keys

- > Use the numeric keys to enter the desired programme number.

For example

- 1** for programme slot **1**
- 1**, then **4** for programme slot **14**
- 2**, then **3**, then **4** for programme slot **234**

When entering programme numbers consisting of several digits, you have approximately 3 seconds after pressing a key to complete the entry.

If you wish to enter a number consisting of only one or two digits, you can speed up the switching procedure by keeping the key depressed a little longer on the last digit.

Using the programme list:

- > Press **OK**.
- > You can now use the **arrow keys up/down** to mark the desired programme.
- > Press **OK** to switch to the marked programme.
- > Use the **arrow keys up/down** to move the marker by one line at a time within the list.
- > Use the **arrow keys right/left** to move the marker around the list one page at a time.

Volume control

- > You can regulate the volume of your digital receiver: press the key **Volume +** to increase the volume, and **Volume -** to decrease it.
- > Press the key **Sound on/off** to switch the sound on or off (mute).

Free Manuals Download Website

<http://myh66.com>

<http://usermanuals.us>

<http://www.somanuals.com>

<http://www.4manuals.cc>

<http://www.manual-lib.com>

<http://www.404manual.com>

<http://www.luxmanual.com>

<http://aubethermostatmanual.com>

Golf course search by state

<http://golfingnear.com>

Email search by domain

<http://emailbydomain.com>

Auto manuals search

<http://auto.somanuals.com>

TV manuals search

<http://tv.somanuals.com>