

# TechniSat®

## DigiBox IRDETO



## Instruction Manual

Integrated IRDETO decoding unit. Receives free-to-air as well as IRDETO encoded/scrambled satellite programmes.

**DVB**  
Digital Video  
Broadcasting

# Remote control

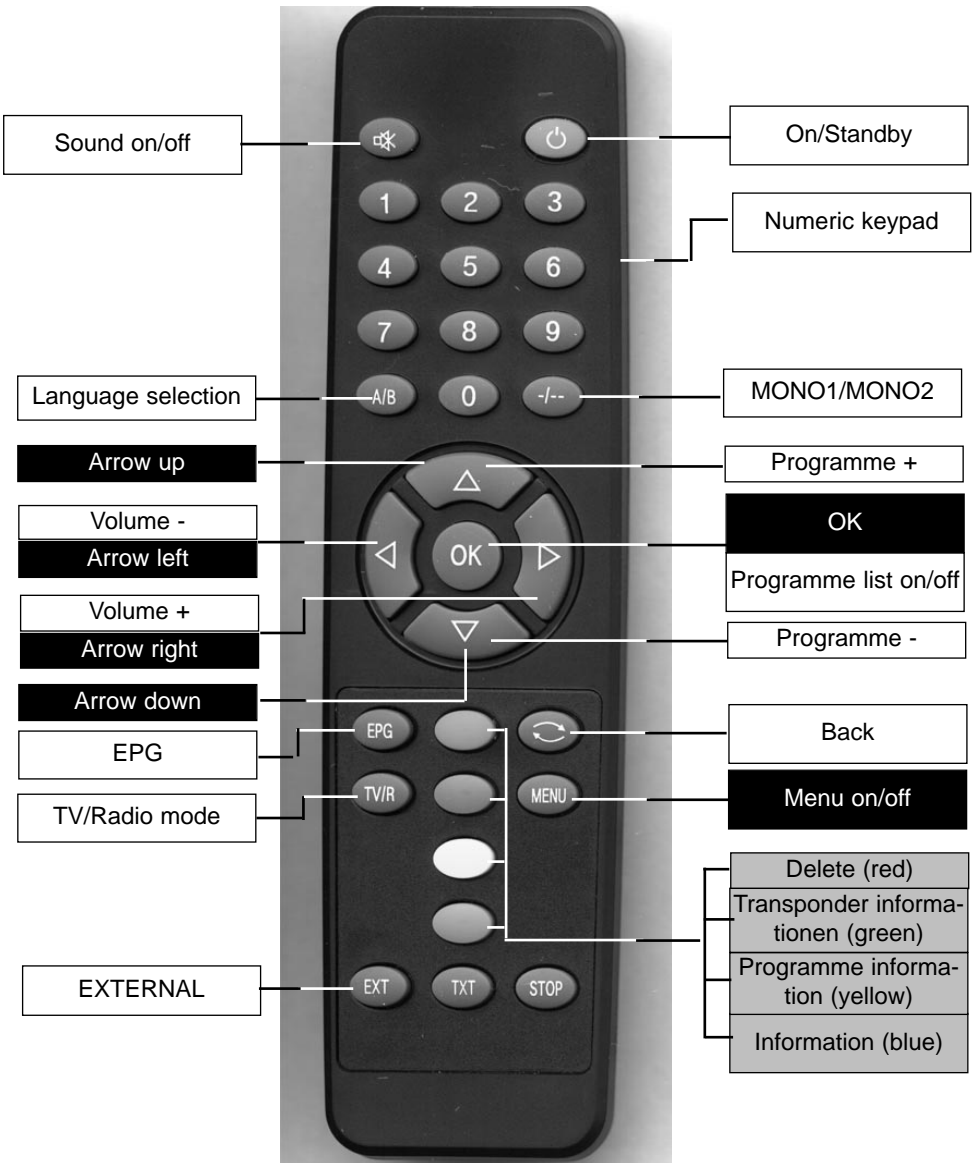

---

# Contents

<b>1</b>	<b>Illustrations</b> .....	<b>3</b>
<b>2</b>	<b>Contents</b> .....	<b>2, 5</b>
<b>3</b>	<b>Important - please read first</b> .....	<b>6</b>
	<b>Disposal instructions</b> .....	<b>6</b>
	<b>Safety instructions</b> .....	<b>7</b>
<b>4</b>	<b>Connections</b> .....	<b>8</b>
4.1	Mains connection .....	9
4.2	External unit .....	9
4.3	Connecting to a TV set .....	9
4.3.1	Via SCART cable .....	9
4.3.2	Via HF cable .....	9
4.4	Adjusting the UHF output channel .....	10
4.5	Connecting a video cassette recorder (VCR) .....	11
4.5.1	Connecting a Super-VHS video recorder .....	11
4.6	Amplifier .....	11
4.7	Serial connection/interface .....	11
<b>5</b>	<b>Installation</b> .....	<b>12</b>
5.1	OSD language selection .....	12
5.2	Basic settings .....	12
5.3	Audio and video settings .....	13
5.4	Adjusting to conform to external unit .....	15
<b>6</b>	<b>Operation</b> .....	<b>18</b>
6.1	On/off switch .....	18
6.2	Programme selection .....	18
6.2.5	Infobox .....	19
6.3	Receiving scrambled/encrypted programmes .....	19
6.4	Volume adjustment .....	19
6.5	Selecting a different language .....	19
6.6	TV/radio switching .....	20
6.7	Going back to last/previous programme selected .....	20
6.8	Display clock/timer and programme information .....	20
6.9	Additional programme information .....	20
6.10	Transponder information .....	20
6.11	Teletext .....	20
6.12	Display sub-titles .....	20
<b>6.13</b>	<b>Electronic Programme Guide (EPG)</b> .....	<b>21</b>
6.13.1	Entering EPG data .....	21
6.13.2	Interrupting the data entry process .....	21
6.13.3	Calling up the Electronic Programme Guide .....	21
6.13.4	Table of current contents .....	22
6.13.5	Table of contents immediately following .....	22
6.13.6	Preview .....	22

---

<b>6.13.7</b>	<b>EPG functions</b>	<b>.23</b>
6.13.7.1	EPG information	.23
6.13.7.2	Pre-selecting a programme	.23
6.13.7.3	Activating the VCR (timer mode)	.23
6.13.7.4	Overview of EPG	.24
6.13.7.5	EPG Search	.25
6.13.7.6	Manual programming of timer	.26
<b>7</b>	<b>Changing basic programme settings</b>	<b>.28</b>
7.1	Adding/deleting programmes	.29
7.2	Sorting programmes	.30
7.3	Locking programmes	.31
7.4	Changing the PIN	.31
7.5	Programming the Electronic Programme Guide	.31
7.6	Unlocking reception of specific programmes	.33
7.7	Programme search	.33
7.7.1	All programmes	.34
7.7.2	Satellite programmes	.34
7.7.3	Transponders	.35
7.7.4	Programs	.35
<b>7.8</b>	<b>Factory settings/System configuration</b>	<b>.36</b>
7.8.1	Restoring original factory settings	.37
7.8.2	Delete total programme memory	.37
7.8.3	EPG channel	.37
7.9	System configuration	.38
7.10	Embedded Irdeto	.38
<b>8</b>	<b>Technical Terms</b>	<b>.39</b>
<b>9</b>	<b>Technical Data</b>	<b>.42</b>
<b>10</b>	<b>Troubleshooting Guide</b>	<b>.44</b>

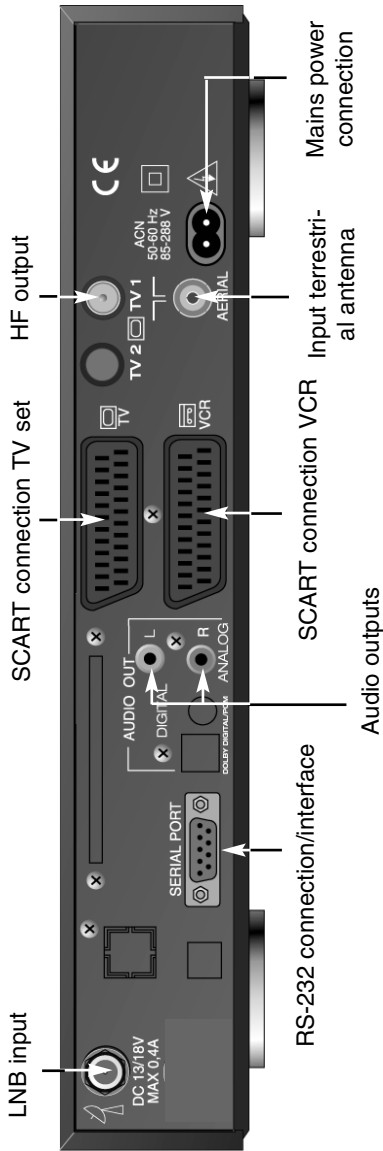
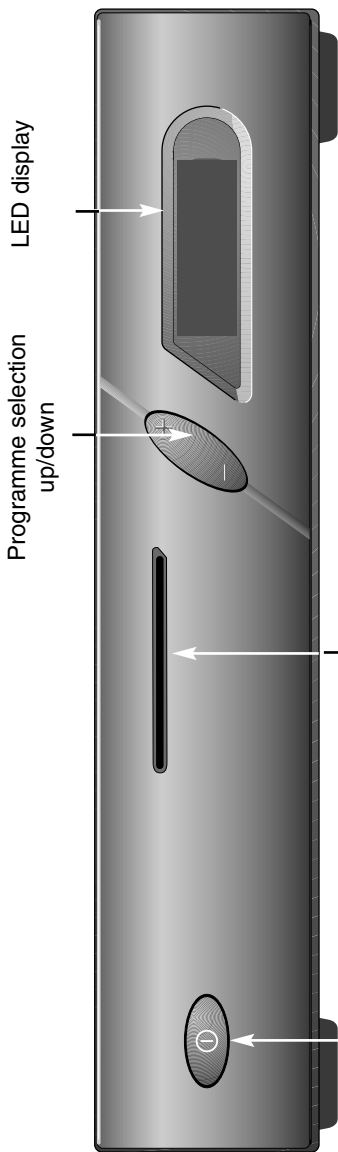

---

### 3 Please read this first

- > Before connecting the receiver, first check that you have received all necessary parts. The following are included:
  - 1 receiver                      1 mains cable                      1 remote control unit
  - 1 instruction manual   1 guarantee card                      2 batteries (1.5V size AAA)
- > Insert the enclosed batteries in the battery compartment of the remote control unit, ensuring the polarity is correct as indicated
- > Before switching on the receiver, please first read the safety hints in **Chapter 3**
- > **Chapters 4 and 5** show you how to adjust and connect the receiver so that it conforms to the requirements of the external unit (dish antenna, LNB, etc.) as well as to those of the TV set, VCR, etc. These settings have to be made only once when commencing operation, and only need to be augmented when you attach additional equipment to the set-up, or if the specifications of your external unit are changed.
- > **Chapter 6** describes all functions required for everyday usage, such as volume adjustment and programme selection.
- > **Chapter 7** shows you ways of setting additional programmes, and of changing the order of programmes.
- > Technical terms used in the instruction manual are explained in **Chapter 8**.
- > Technical data and specifications are to be found in **Chapter 9**.
- > Hints on finding and correcting faults and malfunctions are described in **Chapter 10**.

#### Disposal Instructions:

The packaging of your receiver consists entirely of recyclable and re-usable materials. Please dispose of these in the manner prescribed by your local authorities ("Dual System" in Germany). Please note that spent batteries (from the remote control unit) as well as general electronic components should not be disposed of in domestic garbage, but must be disposed of in special containers, or returned to the retail stockist, as local regulations may prescribe.

### Important hints on Usage

The use of a so-called "On Screen Display" (see example of screen shots) simplifies the use of the receiver, and makes it possible to manage with fewer buttons on the remote control unit. All functions are displayed on the TV screen, and can be adjusted with a few clicks of the button.

Functions that logically belong together are combined into a single "MENU".

The function selected is marked by a blue background in the relevant line. A short comment on the selected function is shown in the lower half of the display.

Terms used in the OSD menu are shown in bold type in this instruction manual.

Example:

- > Use the button **MENU** to open the **Main Menu**.



- > Now select the line of text **OSD LANGUAGE**, by marking the appropriate line with the aid of the arrow up/down controls.
- > Confirm with **OK**.

---

## Safety Instructions

For your own safety, you should read the safety instructions carefully before switching on your new receiver for the first time.

The manufacturer can accept no responsibility for damage caused by inappropriate handling, or by ignoring the safety advice.

- > To ensure a sufficient ventilation, place the receiver on a plain, flat underground. Do not lay any objects on the upper surface of the receiver. This contains cooling slots, which are essential to ensure that the heat generated inside the receiver can escape freely.
- > Do not place any burning objects e.g. burning candles on the receiver.
- > Do not expose the receiver to drop and splash water. Do not place any liquid filled objects e.g. vase on the receiver.
- > The receiver should only be used in moderate climate.
- > NEVER open the receiver! You are in danger of receiving an electrical shock. If it is ever necessary to open the equipment housing this should be done only by appropriately trained personnel.

### Equipment not in use:

During an electrical storm as well as during extended periods when the equipment is not in use it is advisable to disconnect it from the electrical mains.

### In the following cases you should disconnect the equipment from the mains and call a specialist for assistance :

- > when the mains cable or plug are damaged;
- > when the equipment has been exposed to extreme damp, or when liquid has entered the equipment;
- > when there are serious malfunctions;
- > if there is severe external damage to the receiver.

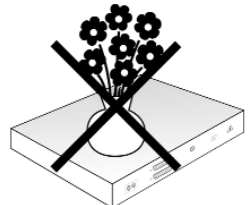
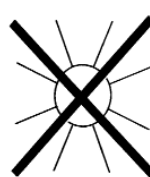
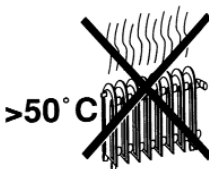
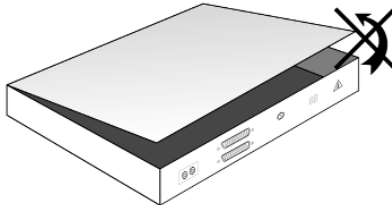

## Connecting a DVB receiver to a satellite installation

- a. Connection from LNB to LNB IN connection on DVB receiver
- b. Mains connection
- c. Connection from terrestrial antenna to antenna input (RF IN) on DVB receiver.
- d. SCART connection between a VCR and the VCR Scart connection on the DVB receiver.
- e. SCART connection between DVB receiver and the TV set.

Optional:

- f. Connection from HF output on the DVB receiver to the HF input of your TV set.

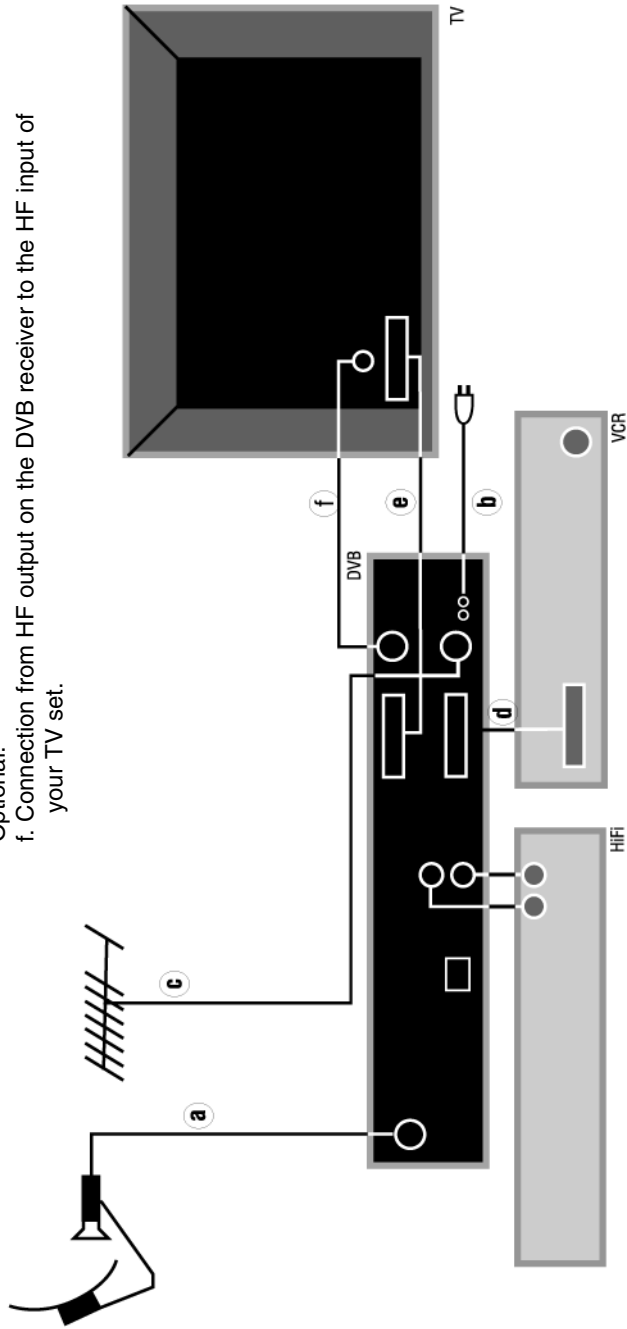



---

## 4 Connections

The references in bold type - **a b c** etc. refer to the diagram on page 8.

### 4.1 Mains connection

The receiver should only be connected to the mains supply after all connections with other components and equipment have been made. This helps to eliminate the likelihood of damage to the receiver or other components.

- b** Once all other cable connections have been made, connect the receiver to a mains supply of 230 V/50 Hz, using the mains cable included.

### 4.2 External Installation

- a** Use a suitable coaxial cable to connect the **LNB INPUT** of the receiver to the LNB unit of your external installation. Also note Point 5 "Installation".

### 4.3 Connection to a Television set

After you have connected your receiver to the TV set as described in this chapter, it may be necessary to adjust the receiver to the TV broadcasting norm used by your TV set, before making further adjustments and settings.

Please also note Point 5.3 (Video system).

#### 4.3.1 By means of a Scart cable:

In order to obtain the best picture quality possible, we advise you to use a Scart cable to connect your receiver to the TV set.

The procedure is as follows:

- e** Connect the receiver (**SCART TV** connection) with the TV set (Scart connection), using a Scart cable. If your TV set is fitted with an appropriate connection, the set will automatically switch to AV mode, and thus receive the satellite signal, whenever the receiver is switched on.

#### 4.3.2 By means of an HF connection

If your TV set is not fitted with a Scart connector, the receiver will have to be connected to the antenna input of the TV set. If this form of connection is used, sound will only be available in mono mode, and not in stereo.

The procedure is as follows:

- f** Using a suitable TV connection cable (coaxial), connect the receiver (**HF OUT**) to the antenna input connector of your TV set.
- c** The cable feeding the terrestrial signal from the antenna should be connected to the **Terrestrial Antenna Input** of the receiver.

Now you must tune the TV set to the transmission channel used by the receiver. Select a free programme slot on your TV set, and select channel 38 (if necessary, refer to the instruction manual of your TV set for this).

If you do not receive a clear picture on channel 38, this may indicate that either this or a neighbouring channel are already receiving a programme signal via the antenna. You can check on this by temporarily disconnecting the antenna cable from the **Terrestrial Antenna Input** of the receiver. If you then temporarily receive a clear picture, you should select a different transmission channel within the receiver's range of 21 to 69.

---

## 4.4 Setting the UHF Output Channel

The procedure is as follows:

- > Use the **Menu** key to select the **Main Menu**



- > Now select the entry **Settings**, marking it in blue by using the **up/down arrow** keys
  - > Confirm by pressing **OK**
- The sub-menu **Settings** will be displayed.

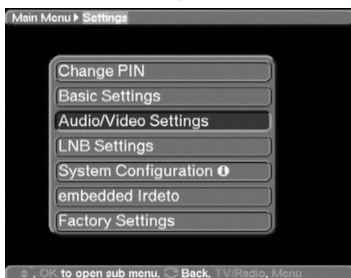

- > Now use the **up/down arrow** keys to mark the line **Audio/Video Settings**
  - > Confirm by pressing **OK**
- The sub-menu **Audio/Video** will be displayed

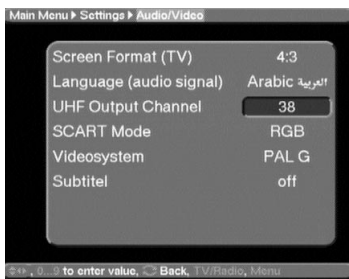

- > Now select the line **UHF Out Channel**, marking it in blue by using the **up/down arrow** keys.
  - > Select a free UHF channel on your TV set in the range between 21 and 69.
  - > Finally, use the **numeric key pad** to enter the new output transmission channel in your receiver's memory.
- The receiver will now transmit the signal on the UHF channel shown in the display. Should you still experience interference on the channel selected, please repeat the procedure until you find a suitable channel, free from interference.

- 
- > Once you have found a UHF channel with optimal quality, please remember to enter it into the memory of your TV set.  
You can now select further settings in the **Audio/Video Settings** menu, or you can press the **Menu** key to return to normal operation. The selected setting will be automatically stored in memory when you exit the menu.
  - > If your TV set is only equipped with an automatic channel scan, select any UHF channel on your receiver, then start the automatic scan run on your TV set. If necessary, repeat this procedure until you find a suitable transmission channel (as described above), and store the selected channel in your TV set's memory.
  - > It may be necessary to finish off with some fine tuning of the channel on the TV set.

## 4.5 Video Cassette Recorders (VCR)

- d** Connect the video cassette recorder to the Scart connection marked **VCR** on your receiver. When the video player is set to PLAY, it will send a switching signal to the receiver, which will transmit the video player signal to the TV set automatically. If your video recorder is not equipped to provide this switching signal, set your receiver to the external input **AV1**, using the **EXTERNAL** key on your remote control. Pressing this key again will take you back into normal operating mode.

### 4.5.1 Super VHS Video Cassette Recorders

If you have a Super VHS video recorder, you can use this to make recordings in Super VHS quality through your DVB receiver. In order to achieve this, make all the necessary settings as described in **5.3 (Audio/video Settings)**

Note: this setting applies to both the **TV** and **VCR** Scart connections of your receiver.

## 4.6 Amplifier

In order to achieve the best possible sound quality, the receiver can be connected to a hi-fi amplifier. Use a suitable cable to connect the cinch outputs **Audio R** and **Audio L** of the receiver with an input connection of your hi-fi amplifier (use either CD or AUX inputs, the Phono connection is not suitable).

## 4.7 Serial Interface RS 232

The RS 232 interface can be used to update the operating software, and in order to pre-programme the receiver via a PC.

---

## 5 Installation

Now that you have made all the necessary connections to and from your receiver, and have switched it on, you may, if necessary resp. if you wish, optimise the operation of the receiver.

### 5.1 OSD Language

This menu heading gives you the opportunity of selecting a language of your choice, in which the menus will be displayed. The receiver is given a default setting of German in the factory. You have a choice of English, German, Arabian, French, Italian, Greek and Dutch. In order to change the OSD language, please follow these steps:

- > Use the **Menu** key to select the **Main Menu**

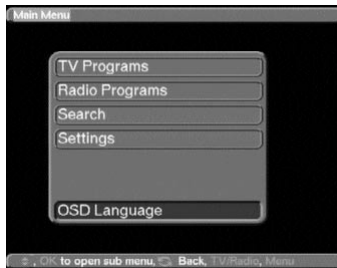

- > Select the entry **OSD Language (OSD-Sprache)**, marking it in blue by using the **up/down arrow** keys.
- > Confirm by selecting **OK**
- The sub-menu **OSD Language (OSD-Sprache)** will be displayed
- > Select the preferred language by means of the **up/down arrow** keys. Use the **up/down arrow** keys to move the marker by one line at a time, while the **left/right arrow** keys are used to scroll to the previous or the following page respectively.
- > Press **OK** to store the selected language.
- > Press **Back** to return to the **Main menu**.

### 5.2 Basic Settings

In order to gain the optimal benefit from your DVB receiver, you can still set several individual preferences.

- > Press the **Menu** key to call up the **Main Menu** display.
- > Use the **up/down arrow** keys to mark the entry **Settings**.
- > Press **OK** to confirm this selection
- The sub-menu **Settings** will be displayed.



- > Use the **up/down arrow** keys to mark the entry **Basic Settings**.
- > Press **OK** to confirm this selection
- > The sub-menu **Basic** will be displayed.



- > You can use the up/down arrow keys to move the marker within the menu, and to change the individual positions as stated. When selecting a menu item, please also note any additional screen notices.  
The following settings can be made:

#### **Parental lock:**

Your receiver is provided with a security circuit to prevent use by children. Any programmes whose reception you have blocked as per points 7.3 and 7.4 can only be received after a four-digit PIN is entered. You can enable or disable the parental lock facility by pressing the **OK** key while this entry is marked.

#### **GMT Time Offset (hrs.)**

Your receiver is provided with a clock. This is synchronised to Greenwich Mean Time by means of satellite signals. If you do not live in the GMT time zone, you must correct the time display with the aid of the **OK** key, to correspond to your local time. In Germany, standard time is GMT + 1 hour, and Daylight Savings Time is GMT + 2 hours. When the receiver is in stand-by mode, the time is shown on the receiver display.

#### **Country**

This function provides an automatic change-over between standard (winter) time and daylight savings (summer) time. Mark the entry **Country** to select your home country, and confirm by pressing the **OK** key.

As this information is currently not broadcast by all programme providers, you should initially select None for this setting.

- > Press the key **Back** to return to the menu **Settings**, or press the **Menu** key to return to normal operation. All settings selected will be automatically stored.

#### **Searchmode**

When you are on this line of the menu, decide by means of the OK key whether a programme search (see Point 7.7 of this instruction manual) should include only free or all (free-to-air and encoded/scrambled) channels.

## **5.3 Audio/Video Settings**

In order to further optimise the operation of your receiver in conjunction with your TV set, you can make further selections in the **Audio/Video settings** menu.

- > Press the **Menu** key for the **Main Menu** to be displayed.
- > Use the **up/down arrow** keys to highlight the entry **Settings**
- > Confirm this selection by pressing the **OK** key  
The sub-menu **Settings** will be displayed.

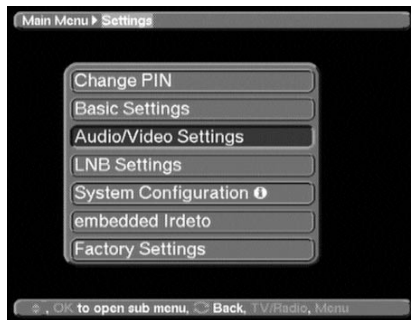

- > Now highlight the entry **Audio/Video Settings**, using the **up/down arrow** keys.
- > Confirm by pressing **OK**  
The sub-menu **Settings Audio/Video** will be displayed

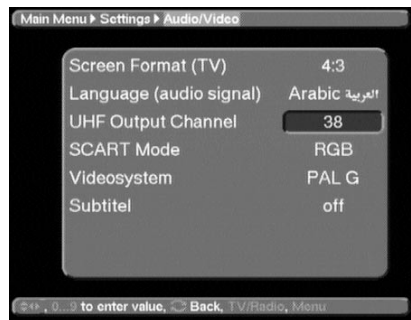

- > Use the **up/down arrow** keys to move the marker (blue highlighted entry) within the menu, and to change the individual settings as indicated. When selecting an option, please also note any additional on-screen notices.  
The following selections are possible:

#### **Screen Format (TV):**

Use the **OK** key to select either the 4:3 (standard) or 16:9 (widescreen) picture format, in accordance with the features of your TV set. This function automatically adjusts the picture format to the specifications of your TV set.

#### **Language (audiosignal)**

Use the **OK** key to select your preferred language. Where a programme is broadcast with several language soundtracks, this feature will automatically select your preferred language, if available.

#### **UHF-Output Channel**

See Point 4.4

#### **SCART-Mode**

Use the **OK** key to select either **CVBS**, **RGB** or **S-VHS**, in accordance with the specifications of your TV set. For standard equipment retain the default setting **RGB**.

#### **Videosystem**

In this line of the menu, use the **OK** key to set the video standard appropriate to your TV set. You can choose from the following options: **PAL G**, **PAL I**, **SECAM G** and **SECAM L**.

---

## Subtitel

Your DVB receiver has the facility to display sub-titles. Provided the function Sub-titles has been enabled, and the preferred language selected in terms of the Audio signal selection is available, the sub-titles will be superimposed on the picture automatically. If the function has not been enabled, it can be set manually, Sub-titles are indicated by the symbol  in the information display. Please also refer to Point 6.12 in this instruction manual.

## 5.4 Adjustments for the External Unit

Once you have made all the individual selections, to make the receiver conform to your preferences, it may still be necessary to make some adjustments for the receiver to work optimally with your antenna/satellite dish. The default factory setting is pre-programmed for reception of ASTRA and EUTELSAT broadcasts by means of a universal LNB (see Glossary at end for technical terms). Once the receiver has been connected to an external reception unit and switched on, these programmes can be received without any further adjustments. Should you also wish to receive signals from other satellites, or if you have a different type of LNB, you can make the following adjustments in your receiver to provide for these programmes:

- > Press the **Menu** key to display the **Main Menu**



- > Use the **up/down arrow** keys to select the entry **Settings**.
- > Confirm by pressing the **OK** key.  
The menu **Settings** will be displayed.



- > Now use the **up/down arrow** keys to select the entry **LNB Settings**
- > Confirm by pressing the **OK** key.  
The menu **Settings LNB** will be displayed.



The following selections can be made in this sub-menu:

#### 5.4.1 Switching DiSEqC on or off

DiSEqC (**D**igital **S**atellite **E**quipment **C**ontrol) is a digital signal that can control the functions of DiSEqC-compatible components via the antenna connection.

If your external installation features DiSEqC components, you should enable the DiSEqC control function:

- > When this entry is highlighted, use the **OK** key to switch the **DiSEqC** function **on** or **off**.

#### 5.4.2 Adjusting the Switching Matrix and LNB Properties

The menu reflects the four switching criteria of the DiSEqC control.

Your receiver is pre-programmed to receive ASTRA broadcasts on switch setting A/A, and EUTELSAT signals on setting B/A of a Multiswitch. Should the switching matrix of your external receiving unit be set up differently, or should you wish to receive satellite signals other than those mentioned, you can adjust the receiver settings as follows:

- > Use the **up/down arrow** keys to select the DiSEqC switch position (1-4) that you wish to use for allocation to a satellite (e.g. **A/B 3 No Satellite**), and highlight the appropriate entry.
- > Press the **OK** key to confirm.  
A list of several satellites will be displayed, from which you can make your selection.
- > Use the **up/down arrow** keys to select the appropriate satellite.  
Pressing the **up/down arrow** keys will move the marker by one line at a time, up or down, while the **left/right arrow** keys will take you to the previous or following pages respectively.  
Should the satellite you are looking for not be included in the list, please select one of the spare settings, which are marked **User 1** to **User 15**.
- > Confirm by pressing the **OK** key.  
The highlighted entry will now be inserted in the **Menu >Settings>LNB** at the previously selected position

In this way, you can continue to customise the **Menu>Settings>LNB** until all the information in this menu correspond to those of your receiving unit. For those switching criteria you do not require you should select the setting **No Satellite**.

#### 5.4.3 Additional Settings

Now that the switching matrix of your DVB receiver has been adjusted to conform to your external reception equipment, you should also check on the other settings for your receiving equipment, and adjust the settings where necessary.

- > Use the **left/right arrow** keys to mark the entry **Check LNB**.
- > Using the **up/down arrow** keys to move around the field **Check LNB**, select the satellite position (1-4) that you wish to adjust resp. check on; mark the entry **Proceed** in blue.



- > Confirm by pressing **OK**.  
The menu **>LNB>Check** will now be displayed, together with the DiSEqC setting selected (e.g. **A/A 1**).

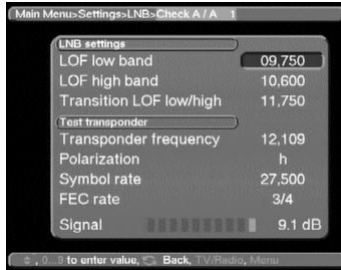

The following settings can be made:

### **LOF low band**

LOF (local oscillator frequency) is the frequency used by the LNB to convert the frequency received into the so-called 1st Intermediate Frequency, which can then be utilised by the receiver. So-called universal LNBS utilise 2 LOFs in order to cover the whole frequency range of 10.7 to 11.8 GHz (low band) and 11.7 to 12.75 GHz (high band). Using the numeric key pad of your remote control, enter here the LOF frequency corresponding to the low band of your LNB.

### **LOF high band**

As above - using the numeric key pad of your remote control, enter here the LOF frequency corresponding to the high band of your LNB.

### **Transition LOF low/high**

Use the numeric key pad of your remote control to enter the frequency at which your LNB switches from low band to high band.

### **Transponder Test**

The following points of this menu should only be entered if you want to test a satellite signal by means of a self-generated satellite (User 1 to 15).

### **Transponder frequency**

Use the **numeric key pad** to enter a frequency at which digital programmes are broadcast.

### **Polarisation**

Use the **OK** key to enter the appropriate polarisation plane (**h**orizontal or **v**ertical) on which the selected programme is broadcast.

### **Symbol rate**

The symbol rate is an indication of the volume of data being transmitted per second. A typical rate might be 27000, indicating that 27000 symbols per second are being transmitted. Use the **numeric key pad** to enter the appropriate symbol rate.

### **FEC Rate**

The FEC function adjusts error correction to the requirements of the selected transponder. Use the **OK** key to enter the appropriate FEC. This can be **1/2**, **2/3**, **3/4**, **5/6**, **6/7** or **7/8**. If the FEC rate is not known, use the **Auto** setting.

### **Signal**

This line will indicate the signal strength, provided the details of the transponder have been entered correctly.

Red bar: poor reception, digital reception not possible

---

Yellow bar: good reception  
Green bar: excellent reception

## 6 Operation

At the first time the receiver the receiver gets connected to the main supply the display shows successively the symbols **dL**, **lu** and **rA**. During this time the receiver checks if a new operation software is available at the serial interface. If a new software is available the receiver gets updated.

### 6.1 Switching on and off

- > Use the key **On/standby** on the receiver or on the remote control to switch the receiver on.
- > Pressing the same key on the receiver or on the remote control again will switch the receiver off again.  
While the display shows **ird**, the receiver checks the last activated transponder if there is a new irdeto software available.
- > After this procedure the receiver is in standby mode.

### 6.2 Programme Selection

#### 6.2.1 Using the Programme up/down keys

- > Use the **Channel up/down** keys either on the receiver front panel or on the remote control to move up or down the list one channel at a time.

#### 6.2.2 Using the Numeric Key Pad

- > Use the numeric key pad to enter the desired programme/channel number directly:  
For example:

<b>1</b>	Programme/channel <b>1</b>
<b>1</b> , followed by <b>4</b>	Programme/channel <b>14</b>
<b>2</b> , followed by <b>3</b> , followed by <b>4</b>	Programme/channel <b>234</b>

When entering programme numbers consisting of more than one digit, you have about 3 seconds after pressing one digit to enter the next digit, in order to complete the entry in such a way that the receiver recognises all digits as part of one selection.

If you are entering a programme number with only one or two digits, you can speed up the selection process by pressing **OK** after entering the last digit.

#### 6.2.3 Using the Programme List

- > Press the key **OK**  
A list of programmes will now be displayed.



---

If the receiver is in TV mode, only TV programmes will be shown, and in Radio mode only radio programmes will be displayed. The programme currently selected is highlighted in red.

- > You can now proceed to mark the desired programme in blue by using the **up/down arrow** keys.
- > Press the **OK** key, and the desired programme will be shown.
- > Use the **up/down arrow** keys to move up or down the programme list one line at a time.
- > Use the **left/right arrow** keys to move forward or back one page at a time.

#### 6.2.4 Selecting blocked programmes

If a programme is selected that is subject to parental lock, the words **PIN Number** will appear on the screen

- > Use the **numeric key pad** to enter your PIN number.  
The desired programme can now be viewed.

In order to make this function easy to use, the PIN number needs to be entered only once during an operational phase. The parental lock feature is only activated again next time the receiver is switched on.

#### 6.2.5 Information (Info) Box

Every time the programme is changed, an info box will be displayed temporarily, showing the programme number and name. In addition, any programme features will be shown, e.g. **TxT** for tele text, **16/9** for a 16/9 widescreen broadcast, **A/B** for various audio channels (e.g.

movies with several language soundtracks, or various radio programmes) or the  symbol for sub-titles.

### 6.3 Reception of scrambled (encrypted) Programmes

Your receiver is equipped with a built-in **IRDETO** decoding module. This enables you to receive scrambled programmes in conjunction with an appropriate smart card. In order to receive such programmes, you must insert a **IRDETO** smart card into the integrated card reader, with the gold-coloured chip at the bottom, and facing in the direction in which it is being inserted, and push in carefully until resistance is felt.

### 6.4 Adjusting sound volume

You can adjust the volume of your receiver. This facilitates use of the receiver, as it means you have all important functions in one remote control, and will have to revert to the remote control of your TV set only very rarely. Whenever the receiver is switched on, the volume setting used last will be set again.

- > Use the keys **Volume +** to increase the sound volume, and **Volume -** to reduce the volume.
- > Press the key **Sound on/Off** to mute the sound. Repeated pressing of this key will restore the sound.

### 6.5 Selecting a different language

If a programme is broadcast in several languages, you can select a language as follows:

- > Press the **Language Selection** key  
The list of languages available will now be displayed on screen.
- > Use the **up/down arrow keys** to select the desired language.  
Confirm by pressing the **OK** key.  
Disable the menu display by pressing the **Language Selection** key again.

You can now listen to the programme in the selected language. If the programme is chan-

---

ged, the receiver automatically reverts to the default language setting (see 5.3 Language Selection). Your receiver also provides the facility to receive mono broadcasts. For mono transmissions, you can use the **MONO1/MONO2** key to switch between the MONO1 and MONO2 sound channels.

## 6.6 TV/Radio selection

Your receiver has been pre-programmed with a selection of radio as well as TV programmes. When selecting a radio programme, the TV image is switched off, and only the radio programme name is displayed.

- > Use the **TV/Radio** key to select radio mode.  
The receiver will automatically go to the last radio programme selected.
- > Press the **TV/Radio** key again, and the last TV programme selected will be displayed again.

## 6.7 Return to previous programme selected

- > Press the **Back** key on the remote control to view the last programme previously selected.
- > Press the same key again to return to the programme viewed before the change.

## 6.8 Displaying Time and Programme Information

This function allows you to view information about the programme currently selected.

- > Press the **blue** key in order to display information on the current programme. The bottom of the screen will now display the current time, the current channel as well as the name of the current programme, including the starting and end times of the programme, if these details are broadcast by the channel concerned.

## 6.9 Additional Programme Information

In as far as such information is provided by the broadcasters, you can obtain additional programme information by pressing the Programme Info key.

- > Pressing the **yellow key** will open a further viewing window on your screen. Information relating to the current programme will be displayed.
- > Now press the **OK** key to obtain information about the following programme
- > Pressing the **yellow key** again will cause the on-screen information to disappear.

## 6.10 Transponder Information

- > Press the **green key** Transponder Info to display data relative to the transponder selected.
- > Press the same key again to return to the normal video display.

## 6.11 Teletext

Where broadcast, tele text will be sent through to your TV set. Use the remote control of your TV set to utilise the tele text function. Should your TV set experience problems, e.g. video content and text are superimposed, you should set your receiver to **CVBS mode** (Point 5.3)

## 6.12 Sub-titles

The symbol  displayed in the on-screen information window will indicate when sub-titles are being broadcast. If you have enabled the **Sub-title** function as per Point 5.3, these will be displayed automatically if they are being broadcast in the language selected (Point 5.3).

---

If you have not enabled the **Sub-title** function, or if sub-titles are only being provided in other languages, you can also enable their display manually as follows:

- > Press the **red function key**.
- > A list of the sub-title languages currently being broadcast will be displayed.
- > Use the **up/down arrow** keys to select the language required.
- > Confirm with **OK**.

The sub-titles will now be displayed in the language selected.

You can also use this procedure to select another language for sub-titles. Please note that this function is only available when sub-titles are actually being broadcast. Also, this manual selection will be lost (i.e. not stored in memory) when changing to other programmes.

## 6.13 Electronic Programme Guide

The EPG or Electronic Programme Guide will allow you to view programme details and contents of various programmes on your TV screen. This can provide you with a quick overview of the current and next programmes.

### The EPG functions allow you to

- Preselect programmes which will then be automatically switched on when they start broadcasting;
- Programming of timers
- View information about programme contents on the screen
- Select programmes according to categories, and to view accordingly.

#### 6.13.1 Entering EPG data

Your receiver will update programme information daily, at 05h00, provided it receive the ASTRA satellite and is in standby mode at that time.

The receiving of data will be shown by **EPLd** on the receiver display. If your receiver is switched on at this time, the download of information will not take place

If you press the **EPG** key while the display shows 4 bars after switching the receiver into standby mode, you can also initiate a download manually.

The duration of the download will depend on the number of programmes being updated. The system will show programmes up to a maximum of seven days in advance. As the number of available programmes increases, so the volume of data will cause a reduction in the period of time that can be previewed in the Electronic Programme Guide.

You can decide for yourself which programmes should be included in the Electronic Programme Guide, the details can be entered as described in Point 7.5.

#### 6.13.2 Interrupting EPG download

The process of downloading data can be interrupted by switching on the receiver (key **On/Standby**). The data as per the last previous download still remains available.

#### 6.13.3 Viewing the Electronic Programme Guide

- > Switch on your receiver as well as your TV set.
  - > Press the **EPG** key on the remote control of your receiver.
- The Electronic Programme Guide will now be displayed on screen. The list will include the programmes preprogrammed at the factory, or those selected by you. You can now use the **EPG functions** to set (**Set**) the programme, to **Preselect** it, or to mark it for timer programming (**Activate VCR**)
- You can also obtain information on the content of various programmes from the EPG function.

### 6.13.4 Now (Display of current programme contents)

The first tables to be displayed will be those of programmes currently being broadcast (Now). The yellow bar right from the programme name shows the past time of the current programme.



- > You may now utilise the EPG functions as per Point 6.13.3.
- > Press the **right arrow** key to view the EPG-table Next (see Point 6.13.5).
- Or
- > Press the **TV/Radio** key to return to normal signal reception.

### 6.13.5 Next

#### (Display of immediately following programmes)

- > Use the **right arrow** key to select the Next table (programmes immediately following current programmes).



- > The EPG functions as per Point 6.13.3 are now available.
- > Press the **right arrow** key to view the table **Preview** (Point 6.13.6).
- Or
- > Press the **Back** key to return to the previous table **Now**.
- Or
- > Press the **TV/Radio** key to return to normal signal reception.

### 6.13.6 Preview

- > Pressing the **right arrow** key again once you are viewing the table **Next** will take you to the table **Preview**.

INFOSAT-EPG TV		2002/01/23 15:18	
Now	Next	Preview	
		Today	Wed 02/01/23 15:46
Das Erste	14:03-16:00	Sportschau live	
ZDF	15:10-16:00	Streit um Drei	
ProSieben	15:00-16:00	Absolut Schlegl	
SAT.1	15:00-16:00	Richterin Barbara Salesch	
RTL	15:00-16:00	Die Wache	
RTL2	15:40-16:10	Dragon Ball	
S RTL	15:25-16:00	Norman Normal	
VOX	15:05-16:05	St. Tropez	
KABEL 1	15:30-16:20	Time Trax - Zurück in die Zukunft	
Bayerl...	15:25-16:00	Neues vom Süderhof	
hessen ...	15:45-16:15	Service: Wohnen	
NDR F...	15:15-16:00	Bilderbuch Deutschland	

Time, Channel, EPG Info, Note down, TV/Radio  
VCR activate, Programs, Timer, Search

The title line of this table shows an additional window in the heading line, displaying the time of the EPG table being shown.

- > Use the **right arrow** key to scroll through the tables in chronological order.
- > Holding down the **right arrow** key a little longer will allow you to scroll through one hour at a time. This will allow you to get to later programmes, or those on following days, more quickly.
- > Pressing or holding down the **left arrow** key allows you to scroll through in reverse chronological order.

Or

- > Press the **Back** key to return to the **Next** table.

## 6.13.7 EPG - Functions

In order to utilise the following EPG functions, you must first select the **EPG** as described in Point 6.13.3.

### 6.13.7.1 EPG Information

The EPG Info will allow you to view a brief piece of information on the programme or broadcast selected/marked, provided this information is available.

- > Use the **arrow** keys to indicate the programme selected.
- > Press the **EPG** key to display the information  
More extensive text can be moved, by using the **up/down arrow** keys, or scrolled, by using the **left/right arrow** keys.
- > Press the **Back** key to return to the previous table.

Or

### 6.13.7.2 Preselect Programmes

- > Mark the desired programme by using the **arrow** keys.
- > Pressing the **OK** key will automatically preselect the programme, and it can be viewed as soon as the programme begins broadcasting.
- > Press the **Back** key to return to the previous table.

### 6.13.7.3 Activate VCR (Timer mode)

The **Activate VCR** function allows you to switch your receiver on or off for a selected programme, e.g. in order to record this in your absence. Please note that you must also programme your VCR in order to record the programme.

- > Use the **arrow** keys to mark the selected programme.
- > Press the **red** function key.

The selected entry will now be displayed in red.

Your receiver will be switched on at the time when the selected programme is due to begin. If the receiver is switched on by the timer, the letter "t" will be shown on the display, together with the channel number. In this mode, most of the functions of the remote control are disabled in order to prevent an accidental premature interruption of the recording.

If the receiver is in standby mode, the activated timer will be indicated by blinking of the two dots (colon) in the time display.

> Press the Back key to return to the previous display.

### **Disabling the timer function**

If you want to cancel a timer command entered via the EPG, repeat the above steps, then cancel the timer setting by pressing the **red function** key.

In order to interrupt/disable while the timer is actively in operation, switch off the receiver by means of the **on/standby** key. When you press this key again, the receiver will be switched on, and you can continue with normal operation.

## **6.13.7.4 EPG Survey**

You can use the EPG Survey in order to display the current day's programme of a single channel. This can be done as follows:

- > Press the **EPG** key.  
The EPG table "**Now**" will be displayed.
- Press the **green** function key.

The table **EPG Survey** will be displayed.

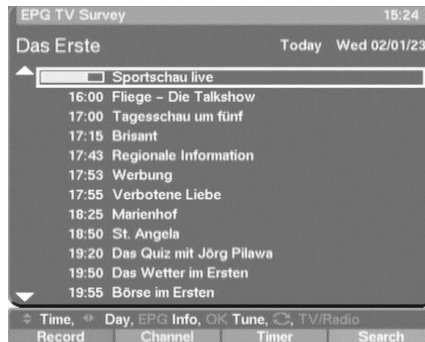

- > Use the **up/down** arrow keys to select the required programme resp. time.
- > If available, the **left/right** arrow keys can be used to display the programme contents for the next few days.

### **Displaying EPG Summary of other Channels**

- > While the menu **EPG Summary** is being displayed, press the **green** function key. A list of EPG channels will be displayed.



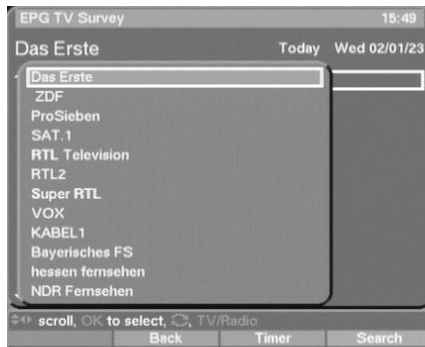

- > Use the **arrow** keys to mark the required channel.
- > Press the **OK** key to display the EPG Summary of the selected channel.

### 6.13.7.5 EPG Search

The EPG Search function allows you to search for specific types of programmes. The search criteria available are **Date**, **Time Period** and **Programme Type**. The search will only be carried out among those channels for which the EPG function has been activated. In order to initiate an EPG Search, proceed as follows:

- > Press the **EPG** key to display the EPG table.
- > Press the **blue** function key.

The EPG Search menu will be displayed.



- > Now, if required, use the **numeric key pad** to enter a date for the EPG search.
- > By pressing the **right arrow** key you can move the marker to the "**from, to**" columns, where you can also enter the time period by means of the **numeric key pad**.

#### **Programme Type**

In this field you can enter the type of programme that should be identified by the EPG search.

- > Use the **right arrow** key to mark the column **Programme Type**. This field will initially show "**All Programme Types**" as the search criterion. Press the **OK** key to display a further table showing a list of programme types/categories that may be selected.

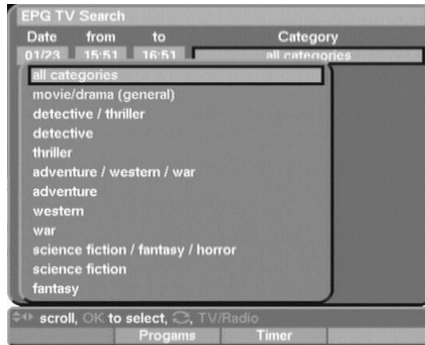

- > Use the **up/down** as well as **left/right arrow** keys to mark the programme type required.
- > Press the **OK** key to transfer the selected category to the column **Programme Type**.
- > Now press the **blue** function key to start the EPG search.  
After a few seconds the screen will display a summary of the programmes with the desired content.  
If you selected "**All Programme Types**" the contents of all programmes activated for EPG searches within the selected time period will be displayed.  
If there are no programmes of the desired type being broadcast during the time period selected, the screen display will show "**No Entries Found**".
- > Press the **Back** key to return to the column **Programme Types**, and continue your search for other types of programmes.

### 6.13.7.6 Programming the Timer

Apart from using the EPG to programme the timer, you can also do this manually:

- > Press the **EPG** key
- > Press the **yellow** function key  
The **EPG Timer menu** will be displayed



- > Press the **yellow** function key again to display the menu for programming the timer.

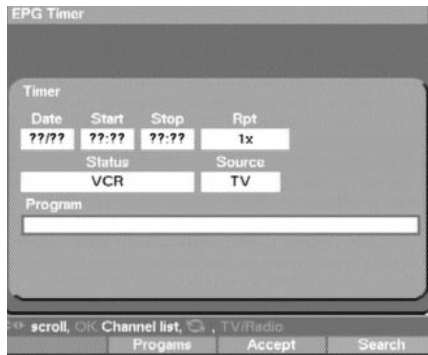

The timer can be programmed as follows:

### Date

- > Use the **arrow** keys to mark the Date column
- > Use the **numeric key pad** to enter the date on which you wish to record a programme

### Start

- > Use the **right arrow** key to mark the Start column.
- > Use the **numeric key pad** to enter the starting time for the timer.

### Stop

- > Repeat the steps shown under "Start" to enter the time when the timer should stop, i.e. be switched off.

**In order to ensure a smooth operation, there should be a gap of at least one minute between the end of one timer period and the start of the next timer period!**

### Switching Timer on - Repeat

- > Use the **right arrow** key to mark the column **Rpt.**
- > If required, switch the timer on by pressing the **OK** key (Display **1x**)
- > By repeatedly pressing the **OK** key you can set the timer for further days as follows:

Display:	
-	Timer off
<b>1x</b>	Timer on
<b>D</b>	Daily repeat
<b>1W</b>	Repeat once per week
<b>2W</b>	Repeat every two weeks
<b>3W</b>	Repeat every 3 weeks
<b>4W</b>	Repeat every 4 weeks
<b>1-5</b>	Repeat only on workdays
<b>6-7</b>	Repeat only on weekends

---

## Status

- > Use the **arrow** keys to mark the Status column
- > Use the **OK** key to enter the desired status in this line.

### 1.VCR

Your equipment will be switched on and off for the selected programme.

If the equipment was switched on by means of the timer, the display will show a "t" together with the appropriate channel number. Most of the functions of the remote control are disabled in order to prevent an accidental interruption of the recording. When your receiver is in Standby mode, the timer activation will be indicated by blinking of the two dots (colon) in the time display.

### 2. Noted down

When the selected time is reached, your receiver will switch on and select the preselected channel. In contrast to the VCR setting, the remote control functions are not disabled, and the receiver will not switch off when the programme has ended.

### 3. delete

The timer setting will not be activated.

## Source

- > Use the right **arrow** key to mark the **Source** column
- > Use the **OK** key to indicate the source required, either **TV** or **Radio**.

## Program

- > Use the **arrow** keys to mark the **Program** column.
- > Press the **OK** key.  
Depending on which has been selected last, the display will now show the list of TV or radio programmes.
- > Use the **arrow** keys to select the required programme.
- > Press the **OK** key for this to be stored in the timer memory.
- > Use the **up/down arrow** keys to move the marker by one line at a time.
- > Use the **left/right arrow** keys to move backwards or forwards through the list one page at a time.
- > When you have completed your programming session, press the **yellow** function key in order to store the data in memory.
- > Press the **TV/Radio** key in order to return to normal operation.

## IMPORTANT NOTICE !!!

Ensure that the receiver has received and stored the basic time. The time is shown in the info box (Point 6.2.5).

- > Press the **blue** key to display the info box.

If this is not the case, you should select a channel with an automatic time signal and switch this on for approximately 30 seconds, so that your receiver can automatically acquire the current time data.

After this procedure, the current time should be displayed in the info box.

## 7 Changing the Basic Programming

If for some reason you are not satisfied with the preprogrammed settings of your receiver, you can alter the list of channels according to your own preferences. This function is also required in order to sort the programmes identified in a Search run.

You should note the following:

Your receiver features two programme/channel lists, the User List and the Total List.

The User List includes those channels you can select by means of the numeric key pad, and by using the channel up/down keys.

The Total List includes all channels.

If you do a search in this list, new programmes will be shown in red, and can be transferred from the Total List to the User List.

## 7.1 Adding/Deleting Channels

To add new channels to the user list, or to delete channels, proceed as follows:

- > Press the **Menu** key to display the **Main Menu**.

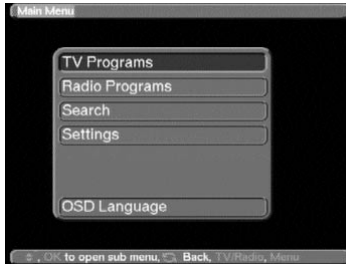

- > Use the **up/down arrow** keys to mark **TV Programs** if you wish to add TV channels, or Radio Programmes, if you wish to add radio stations.
  - > Confirm with the **OK** key.
- The sub-menu **>TV-Programmes** will be displayed.

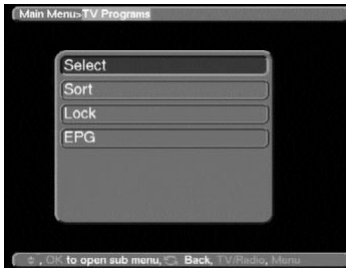

- > Use the **up/down arrow** keys to mark the entry **Select**.
  - > Confirm with the **OK** key.
- The sub-menu **>TV-Programmes>Select** will be displayed.



This table lists the various bouquets with their respective channels. Existing channels will be shown in white type, newly found channels will be displayed in red type. Channels that also

---

appear in the User List are marked with a red cross. Scrambled channels are marked with a key symbol. Bouquets are displayed with a blue background.

### 7.1.1 Adding items to the User Channel List

- > Use the **up/down arrow** keys to mark a channel or bouquet that you wish to work on.
- > Press the **OK** key, and this field will display a red cross (inclusion in user list). If a single channel is added, the menu background will turn transparent, and the video image of that channel will be displayed in the background.

### 7.1.2 Deleting items from the User List

If the red cross is removed, the marked channel will be deleted from the User List. However, it will be retained in the Total List, and can be reinstated in the User List at any time.

### 7.1.3 Deleting items from the Total List

- > The marked channel can be deleted from the total List by pressing the **red** function key. As long as you have not left this menu again, the channel can again be included again by pressing the **red** function key.

If you have marked a bouquet, the setting will affect the whole bouquet, whereas only a specific channel will be affected if you mark the channel. New channels added to the User List will be positioned at the end of the list, and can then be sorted to any desired position.

## 7.2 Sorting Channels

In order to sort the User List of channels according to your own preferences, proceed as follows:

- > Use the **Menu** key to display the **Main Menu**.
- > Use the **up/down arrow** keys to mark **TV Programs**, if you wish to sort TV channels, or **Radio Programs**, if you wish to sort radio stations.
- > Confirm with the **OK** key.  
The sub-menu **>Programs** will be displayed.
- > Now use the **up/down arrow** keys to mark the entry **Sort**.
- > Confirm with the **OK** key.  
The **User Channel List** will be displayed.
- > Use the **up/down arrow** keys to mark a channel whose position in the list you want to change.
- > Confirm with the **OK** key.
- > Now you can use the **up/down arrow** keys to place the marked channel at any position in the list where you would like it to be.

Or

- > Use the **numeric key pad** to enter the position in the list where you would like to channel to appear. The channel number will be displayed on the menu.
- > Use the **OK** key to insert the channel at the selected position.
- > Repeat this process until the list conforms to your preferences.
- > Press the **Menu** key to return to normal operation.

---

## 7.3 Locking Channels

You have the facility to lock specific channels (parental lock). A locked programme will only be shown on the TV screen if you enter your personal PIN after selecting the channel. This number need be entered only once during an operating session, i.e. the locking will only become operative again the next time the receiver is switched on (standby).

In order to block a specific channel, follow this procedure:

- > Press the **Menu** key to display the **Main Menu**.
- > Use the **up/down arrow** keys to select **TV Programs**, if you wish to block viewing of TV channels, or **Radio Programs** if you wish to block radio stations.
- > Confirm with the **OK** key.  
The sub-menu **>Programs** will be displayed.
- > Use the **up/down arrow** keys to mark the entry **Lock**.
- > Confirm with the **OK** key.  
The **User List** will be displayed.
- > Use the **arrow** keys to mark the channel/station you wish to have locked.
- > Confirm with the **OK** key.  
The channel will be marked with a red cross in the list.
- > You can repeat this process as often as required to lock all channels you wish to lock.
- > Press the **Menu** key to return to normal operation.
- > In order to activate the parental control function, you must still enter your personal PIN in the following point **Change PIN**, and then activate the parental lock as described in **Point 5.2** (Basic Settings)

## 7.4 Change PIN

The PIN is set at the factory to **0000**. In order to activate the programme locking function, you must still enter your own personal PIN in the place of the factory default setting.

**Please Note! Be sure not to forget your PIN number. If you do ever forget it, please contact your retailer!**

In order to change the PIN number, follow this procedure:

- > Press the **Menu** key to display the **Main Menu**.
- > Use the **up/down arrow** keys to mark the entry **Settings**.
- > Confirm with the **OK** key.  
The sub-menu **Settings** will be displayed.
- > Use the **up/down arrow** keys to mark the entry **Change PIN**.
- > Confirm with the **OK** key.
- > Now enter the PIN of your choice by means of the **numeric key pad** - you may choose any 4-digit number you like.
- > Repeat the entry.
- > Press the **OK** key to return to the **Settings** menu.

## 7.5 Programming the Electronic Programme Guide

In this chapter we describe how you can add programmes/channels to the Electronic Programme Guide, or delete them. You thus have the facility to customise the Electronic Programme Guide according to your personal preferences, giving you a better view of the programmes available.

---

**Please Note:**

The more channels and programmes are added to the Electronic Programme Guide, the longer will it take to acquire/update data.

Also, the maximum preview period of 7 days may not be possible if the number of programmes stored in the Electronic Programme Guide is increased.

Proceed as follows in order to programme the EPG:

- > Press the **Menu** key to display the **Main Menu**.



- > Use the **up/down arrow** keys to select **TV Programs**, if you wish to work on TV channels, or **Radio Programs**, if you wish to work on radio stations.
- > Press the **OK** key to display the sub-menu **TV Programs** or **Radio Programs**.

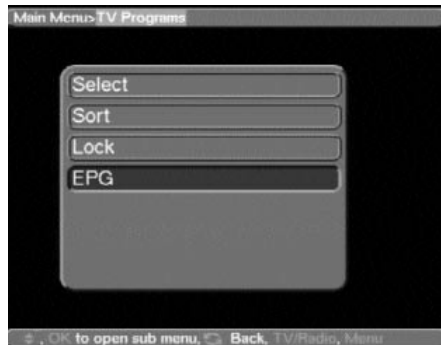

- > Use the **up/down arrow** keys to mark the entry **EPG**.
- > Press the **OK** key to display the sub-menu **EPG**.





- 
- > You may now proceed to use the **arrow** keys in order to select/mark individual channels. Press the **OK** key to add a channel to the Electronic Programme Guide (cross appears in display) or to delete a channel from the guide (cross disappears from display).
  - > Use the **up/down arrow** keys to move around the list one line at a time.
  - > Use the **left/right arrow** keys to move around the list one page at a time.
  - > When you have completed programming the EPG in this manner, press the **Back** key to return to the previous menus.

Or

- > Press the **Menu** key to resume normal operation.  
All settings selected will be automatically stored

Once you have customized the Electronic Programme Guide to your personal preferences, the process of data acquisition by the EPG can be started manually as follows

- > Use the **On/Standby** key to switch the receiver off (standby).
- > Press the key **EPG** within 5 seconds.  
The receiver will now carry out the data acquisition procedure. This is shown in the display by the letters **EPLd**.
- > The data acquisition process can be interrupted by switching on (**On/Standby** key) the receiver.

## 7.6 Unblocking the parental lock for individual channels

Enter your PIN in order to get to the appropriate menu, then proceed as described in Point 7.3, removing individual red crosses by pressing the **OK** key. In this manner, individual channels can again be excluded from the parental lock control.

## 7.7 Programme Search

As mentioned previously, your receiver has been pre-programmed to receive signals from the ASTRA and EUTELSAT satellites. In order to add new channels, or those received from other satellites, there are four possibilities of carrying out a programme/channel search. Please note that your Basic Settings (5.2 - search mode) will determine whether only free-to-air or all (free-to-air and scrambled) channels will be searched.

### 1. All:

All satellites and transponders selected will be searched.

### 2. Satellite:

Choose this option to find specific channels or bouquets.

### 3. Transponder:

Choose this option to scan a specific transponder of a specific satellite. You can search for all or selected programmes of a particular transponder.

### 4. Program:

This option is intended specifically for cases where the desired channel could not be found by any of the other options. Please note that to utilise this search method, you will have to enter the specific Service ID Number of the channel, which you can obtain from the broadcaster, or from the Internet.

Once the search has been completed, the number of channels identified by your receiver will be displayed on your screen, also stating how many of these are new channels. New channels are shown in red type in the Total List, and can be transferred to the User List in accordance with **Point 7** (Changing the Basic Programming).

- > In order to search for programmes, press the **Menu** key to display the **Main Menu**.



- > Use the **up/down arrow** keys to mark the entry **Search**.
- > Confirm with the **OK** key.
- The sub-menu **>Search** will be displayed.



- > Use the **arrow** keys to select the search mode to be used.
- > Press the **OK** key to display the relevant sub-menu.

### 7.7.1 All

When this search mode is activated, all satellites and transponders available in the system will be scanned. At the end, new programmes will be displayed in red type in the programme/channel list.

- > Use the **up/down arrow** keys to select the **All** option.
- > Confirm with the **OK** key.
- The legend "**Start search**" will appear on the display.
- > Press **OK** again to start the search
- > The search can be terminated at any time by pressing **OK**.

It is quite likely that a full scan may take 15 minutes or longer.  
Please note any notes and information displayed on the screen.

### 7.7.2 Satellite

This search mode can be used to search a specific satellite. All other satellites will be ignored in this mode.

- > Use the **up/down arrow** keys to select the Satellite option.
- > Confirm with the **OK** key.
- The legend "**Start search**" will appear on the display.
- > Before proceeding further, you will still have to select the satellite to be scanned. Press the **OK** key.
- A selection window will appear with the four available satellite positions.
- > Use the **up/down arrow** keys to select the satellite.

- > Confirm with the **OK** key.
- > Use the **up/down arrow** keys to mark the entry **Start search**.
- > Press **OK** again to start the search.
- > The search can be terminated at any time by pressing **OK**.

It is quite likely that a full scan may take 15 minutes or longer.

Please note any notes and information displayed on the screen.

### 7.7.3 Transponder

This search mode can be used to search a specific transponder (see Point 9: Technical Terms) for channels. In order to use this function, you will have to enter data relating to the transponder.

- > Use the **up/down arrow** keys to select the **Transponder** option.
- > Confirm with the **OK** key.  
The menu **>Search>Transponder** will be displayed.

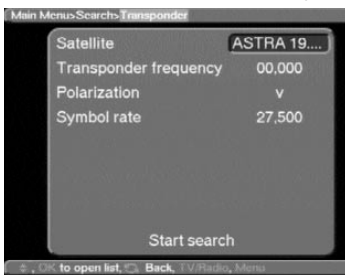

### Satellite

In this line you must select the satellite corresponding to the selected transponder.

- > Use the **up/down arrow** keys to select the **Satellite** option.
- > Press **OK** to display a table listing four satellites.
- > Use the **up/down arrow** keys to mark the selected satellite.
- > Confirm with the **OK** key.  
The selected satellite has now been acquired by the menu.

### Transponder frequency

- > Use the **up/down arrow** keys to mark the entry **Transponder frequency**.
- > Use the **numeric key pad** to enter the correct frequency in this line.

### Polarization

- > Use the **up/down arrow** keys to mark the entry **Polarization**.
- > Use the **OK** key to enter the polarisation plane (**horizontal** or **vertical**) on which the desired programme is broadcast.

### Symbol rate

The symbol rate indicates the volume of data transmitted per second. An example might be 27500, indicating transmission of 27500 symbols per second.

- > Use the **up/down arrow** keys to mark the entry **Symbol rate**.
- > Use the **numeric key pad** to enter the correct symbol rate.
- > Once you have entered all the information, start the search by using the **up/down arrow** keys to mark the entry **Start search**.
- > Confirm with the **OK** key.

Please note any notes and information displayed on the screen.

### 7.7.4 Channel/Programme

If a channel cannot be found by means of any of the first three search modes, it may be necessary to enter a programme-specific Service-ID-Number. This number will be obtainable

---

directly from the service provider/broadcaster, or from the Internet.

Select the menu **>Search>Program**.

> Use the **up/down arrow** keys to mark the entry **Program**.

> Confirm with the **OK** key.

The menu **>Search>Program** will be displayed.

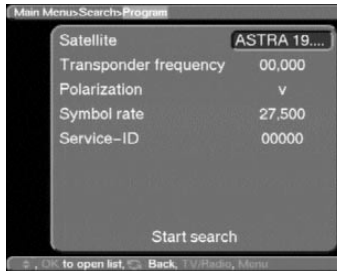

This menu differs from the **Transponder** menu only in terms of the list item **Service ID**.

> Proceed as described in Point 7.7.3 above.

> Use the **up/down arrow** keys to mark the entry **Service ID**.

> Use the **numeric key pad** to enter the Service ID number.

## 7.8 Activate factory settings/change data channels

You may at any stage revert to the original default settings for the LNB, as set in the factory. You may also wish to delete the programme list, which may be outdated, completely before initiating a new search. Please note that, if you delete all programmes from memory, you will then have to initiate a search, and you will have to copy your selected programmes from the Total List into the User List.

> Use the **Menu** key to display the **Main Menu**.



> Use the **up/down arrow** keys to mark the entry **Settings**.

> Confirm with the **OK** key.

The sub-menu **>Settings** will be displayed.

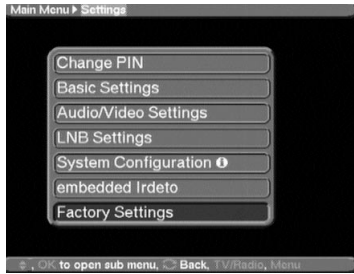

- > Use the **up/down arrow** keys to mark the entry **Factory Settings**.
  - > Confirm with the **OK** key.
- The sub-menu **>Factory Settings** will be displayed.



### 7.8.1 Restore Factory Settings

This function will delete all personal settings, and will restore all default settings as programmed in the factory.

### 7.8.2 Delete All Programs

This function will delete all channels/programmes stored in memory.

- > Use the **up/down arrow** keys to select the entry.
- > Confirm with the **OK** key.

Please note any notes and information displayed on the screen.

### 7.8.3 EPG Channel

Your receiver provides the facility of receiving a dedicated data channel with expanded EPG information via the ASTRA satellite system at 19° East. This enables you to preview programmes for up to a week in advance. If you do not wish to receive this additional data, or if it is not available at your location, data reception may be disabled as follows:

- > Press the **OK** key to display the sub-menu **EPG**.
- > Choose the setting **Download enabled yes** in order to receive the data channel, or **Download enabled no** in order to disable reception.

The EPG information provided by broadcasters/channels is only now available.

Should the parameters of the data channel used for loading the EPG list have changed, they can be corrected in this menu as described under points 7.7.3 and 7.7.4 (search for transponders and programmes). Current transponder information can be obtained from your retailer, or from our homepage in the Internet. Under normal circumstances you should not change the settings in this menu.

---

## 7.9 System Configuration

This menu entry allows you to view all specific data relating to the receiver.

- > Use the **up/down arrow** keys to mark this entry in the sub-menu **Settings**.
- > Confirm with the **OK** key.
- > Use the **Back** or **Menu** keys to exit this function.

## 7.10 embedded Irdeto

Use this menu entry to access the sub-menus related to the smart card being used.

---

## 8 Technical Terms

### **Antenna cable:**

Cable connection between the modulator of the satellite receiver and the antenna input of the TV set, used as an alternative where no SCART connection is provided.

**AV:** see SCART

### **Coaxial cable:**

Cable connection between the LNB and the satellite receiver, transmits the signals received and transmits power supply to the LNBs.

### **Data compression/MPEG1/MPEG2:**

The transmission of an image in accordance with current TV standards (625 lines with a picture frequency of 50 Hz) results in a digital data volume of 216 Mbit/s. This would require bandwidths not available in terrestrial or satellite systems. The data volume is thus subjected to a process of data reduction. MPEG2, which is an expanded development of MPEG1, has been set in Europe as the worldwide standard for data compression.

### **Deemphasis:**

Making the audio frequency curve conform to the broadcast signal, this is determined by the transmission parameters of the satellite.

### **DiSEqC:**

Digital Satellite Equipment Control - a digital control signal used to control DiSEqC-compatible components of the external unit via the antenna connection.

### **DVB:**

Digital Video Broadcasting - a universal digital transmission technology for video images, graphics, sound and text, i.e. for data in any conceivable form and in every possible and appropriate quality.

### **External unit:**

Description for the entire system mounted outdoors, consisting of the parabolic dish antenna as well as one or more LNBs, to receive signals from one or more satellites.

### **Frequency:**

Physical unit for measuring the number of oscillations per second, expressed in Hertz (Hz) or cycles per second.

### **Frequency range**

a) Satellite or LNB

11 GHz range from 10.70 GHz to 11.70 GHz, 12 GHz range from 11.70 to 12.75 GHz

b) Receiver - Intermediate Frequency or 1st Intermediate Frequency 950 to 2150 MHz

Unit of frequency	Name	Oscillations per second
-------------------	------	-------------------------

1 Hz	1 Hertz	1
------	---------	---

1 kHz	1 Kilohertz	1.000
-------	-------------	-------

1 MHz	1 Megahertz	1.000.000
-------	-------------	-----------

1 GHz	1 Gigahertz	1.000.000.000
-------	-------------	---------------

### **Intermediate Frequency:**

The frequency range broadcast by satellite cannot be transported by cable, the LNB therefore transforms the incoming signal to the intermediate frequency range of 950 to 2050 MHz, thus allowing the signal to be transmitted to and modulated in the receiver.

1. IF = Intermediate Frequency

### **IRDETO**

Form of digital encryption (scrambling)

---

## **LNB/LNC (Low Noise Block converter)**

Receiving unit at the focal point of the parabolic dish antenna, converts the signal from the frequency range of the satellite to the intermediate frequency of the receiver.

### **LOF:**

Local oscillator frequency, measured in MHz or GHz, varies according to the LNB and the frequency range received.

Receiving frequency of the receiver = transmitting frequency of the satellite - LOF.

### **Mode:**

Determines whether a mono or stereo programme will be received.

### **Modulation at 22 KHz:**

Apart from the 14/28 Volt switching mode, this also serves to switch between 2 LNBs. In universal LNBs it is used to switch into the High range.

### **Modulator:**

Switch in a satellite receiver or a video recorder that is used to connect the TV set by means of an antenna cable.

### **Multyfeed**

External unit consisting of a parabolic dish antenna as well as several LNBs, suitable for receiving signals from several satellites.

### **Operational voltage:**

The LNBs are supplied with power by means of the coaxial cable. In order to provide this, the receiver must supply power at 14 or 18 volt.

### **Parabolic dish (antenna):**

A reflector of metal or coated plastic, shaped in a parabolic form, used to focus the electromagnetic waves broadcast by a satellite in a focal point.

### **Polarisation plane:**

In order to better utilise the available frequency range, satellites will transmit neighbouring programmes with opposite polarisation (horizontal and vertical, or dextro-rotatory and laevo-rotatory). In order to receive both polarisation planes, either two single LNBs or one V/H LNB are required.

### **Receiver: see Satellite receiver**

### **Satellite:**

Description of a satellite usually includes its name as well as its orbital position.

ASTRA 19° East

EUTELSAT 13° East

### **Satellite Receiver:**

The signals received and modulated by the LNB cannot be processed by the TV set. The receiver alters the frequency of these signals so that usable audio and video signals (AV) are generated at its outputs, which are transmitted to the TV set.

### **SCART:**

Type of connector used in conjunction with TV sets, video players, satellite receivers and other electronic equipment in order to transmit audio and video signals (AV).

### **Software update:**

Digital television is a new medium, which offers improved sound and image quality as well as the facility to utilise interactive services. These new services are constantly being developed and improved by providers. In order to use these services optimally, it may be necessary to update the software of your receiver occasionally.



---

**Transponder:**

Piece of equipment in the satellite that processes one or more programmes, including receiving the data from the ground station, amplification, retransmission of data back to earth.

**Universal LNB:**

Name given to a three-band LNB. It is able to receive the following ranges: FFS (10.70-11.70 GHz), BBS (11.70-12.50 GHz) and FFS High Band (12.50-12.75 GHz). This whole range is usually divided into two bands:

Low Band: 10.70 - 11.80 GHz; LOF 9750 MHz

High Band: 11.70 - 12.75 GHz; LOF 10600 MHz

**VIACCESS**

Form of digital encryption (scrambling)

---

## 9 Technical Data

### DBS-Tuner:

Input frequency range	950...2150 MHz
Input level range	-65 dBm... -25dBm
Noise	max 12 dB
DBS tuner input	F-connector
Input impedance	75 Ohm
AFC capture range	+/- 3 MHz
Demodulation	Shaped QPSK
Symbol rate	2...45 Mbaud/s, SCPC/MCPC compatible
FEC	concatenated Viterbi and Reed-Solomon
Viterbi rates	1/2, 2/3, 3/4, 5/6, 7/8 and automatic detection (K=7)
Roll-off factor	35 %

**Demultiplexing:** in accordance with ISO 13818-1

### Card reader:

Type	Single slot card reader
Function	Card reader for embedded IRDETO

### Video decoding:

Video compression	Compatible with MPEG-1 and MPEG-2 Up to MP@ ML (main profile @ main level)
Format	PAL / SECAM (25Hz)
Active image area	720 pixels x 576 lines
Picture formats	4:3 / 16:9
Picture input 16:9	Automatic Letterbox filtering for 4:3 TV sets

### Audio decoding:

Audio compression	MPEG-1 and MPEG-2 Layer I and II
Audio mode	Dual (main/sub), stereo
Sampling frequencies	32 kHz, 44.1 kHz, 48 kHz

### Audio parameter:

#### Analogue output:

Output level L/R	0.5 V RMS (nominal)
Output impedance	600 Ohm
THD	>60 dB (1 kHz)
Crosstalk	< - 65 dB

#### Analogue input:

Input level L/R	0.5 V RMS (nominal)
Input impedance	> 40 kOhm
Volume at Switch-on	Automatic use of previous volume setting

### Video parameters:

#### Input:

Input level CVBS	1 Vs-s +/- 0.3 dB into 75 Ohm
Input level RED	0.7 Vs-s +/- 0.1 Vp-p into 75 Ohm
Input level GREEN	0.7 Vs-s +/- 0.1 Vp-p into 75 Ohm
Input level BLUE	0.7 Vs-s +/- 0.1 Vp-p into 75 Ohm

---

Teletext filtering in accordance with standard ETS 300 472  
Entry teletext data compliant to ITU-R BT.653-2; lines: 6-22 and 320-335

**TV-SCART:**

Output CVBS with RGB, or only CVBS, or only S-VHS (switchable)

**VCR-SCART::**

Input CVBS with RGB or S-VHS

Output CVBS or S-VHS

**Serial Interface RS 232:**

Type RS 232 bi-directional

Bitrate Max. 115.2 Kbit/s

Connection 9-pin D-SUB connector, male

Function Pre-programming and updating operational software

**PLL-Modulator:**

Output range UHF channels 21 to 69

Antenna input 47...862 MHz

Input/output impedance 75 Ohm

Antenna output 47...862 MHz, including re-modulated UHF signal

Video system PAL / SECAM

**LNB power supply:**

LNB power Max. 400 mA, short circuit detected

LNB voltage vertical <14.0 V no load, >11.5 V at 400 mA

LNB voltage horizontal <20 V no load, >17.5 V at 400 mA

LNB switched off in Standby mode

**22 kHz-Modulation:** 22 kHz, amplitude 0.6 V +/- 0.2 V

**Programme memory/ Satellite positions:**

No. of programmes user list TV: 999 TV programmes (F1 to F999)

No. of programmes user list Radio: 999 radio programmes (r1 to r999)

**Number of Programmes:**

Bouquet lists TV/Radio total of 2000 programmes possible in bouquet lists

**Number of active satellite positions:**

Max. 4 (DiSEqC 1.0, SAT POSITION/ SAT OPTION)

**Total number of satellite position: 32**

One home transponder is stored in memory for each of the 32 satellite positions. This transponder facilitates automatic channel/programme search on each satellite position.

**EPG Data:**

EPG preview: Maximum 7 days in advance

Memory capacity: Programmable for a maximum of 50 programmes

**Timer:**

Events Maximum 128 events, one year in advance

**Remote Control System: RC-5**

Sub-system address 8 (SAT 1)

Modulation frequency 36 kHz

Infrared wavelength 950 nm

---

**Power supply:****Mains switch:****Power usage:**

<24 W (in operation, horizontal polarisation, 400 mA supply to LNB)

<15 W (in operation, excluding LNB)

< 5 W (in standby mode)

**Mains voltage:**

230 V /50 Hz AC

**General:**

Ambient temperature + 15° C ....+ 35° C

Humidity < 80 %

Dimensions (WxDxH) 305 mm x 135 mm x 65 mm

Weight 0.8 kg

## 10 Troubleshooting Guide

Problem	Possible Cause	Solution
No picture, no sound, Display off	No power	Check power plug and cable
No picture, no sound, Display on	Short circuit in LNB connection	Switch receiver off, repair short, switch receiver on again
	Defective or missing cable connection	Check all cable connections
	LNB defective	Replace LNB
	Wrong external unit set on receiver	Correct setting (see point 5.4)
	Dish positioned incorrectly	Correct dish position
Picture shows intermittent blocks. May switch to still image, no sound, at times screen black and note "No signal"	Heavy rain or snow	Clear dish of snow
	Dish positioned incorrectly	Correct dish position
	Dish too small for this location	Use larger dish
	Obstruction between dish and satellite (e.g. tree)	Mount dish with uninterrupted view
Sound OK, screen blue	Radio mode selected	Switch to TV mode
Sound OK, no picture	SCART connector not properly Inserted	Check SCART connections

<b>Problem</b>	<b>Possible Cause</b>	<b>Solution</b>
No reception of channels previously received	Dish faulty, or position changed	Check dish
	Channel moved to another transponder	Initiate search (see point 7.7)
	Channel no longer broadcast	None
Remote control not working	Batteries spent	Replace batteries
Time not displayed in Standby mode	Time not entered	Set to a program with automatic time for 30 secs.to acquire time
Temporary interruptions on Pro 7, Sat.1, TM3, Cable 1, DSF and HOT	Interference caused by DECT cordless telephones	Place telephone base station further from receiver

Your receiver bears the CE control label, and complies with all relevant EU standards.

Subject to change and printing errors. Correct at 01/02  
 TechniSat and DigiBox IRDETO are registered trademarks of  
 TechniSat Digital GmbH  
 P.O.Box 560  
 D-54541 Daun  
 Germany  
[www.technisat.de](http://www.technisat.de)

---

## Summary for everyday use

### Switching on and off

- > Switch the receiver on by pressing the **On/Standby** key on the front panel of the receiver, or on the remote control unit.
- > Press the key again, either on the front panel of the receiver or on the remote control, to switch the receiver off.
- > The receiver is now in standby mode.

### Selecting a programme/channel

#### Using the up/down arrow keys:

- > You may use the **up/down arrow** keys, either on the receiver or on the remote control, to move up or down the selected programmes/channels one step at a time.

#### Using the numeric key pad:

- > Use the **numeric keys** to directly enter the number of the programme/channel you wish to view. For instance

<b>1</b>	for programme slot 1
<b>1</b> , then <b>4</b>	for programme slot 14
<b>2</b> , then <b>3</b> , then <b>4</b>	for programme slot 234

When entering programme/channel numbers with more than one digit, you have approx. 3 seconds after pressing the last key to continue with the entry.

If you are entering a channel number with only one or two digits, we recommend you press the **OK** key after entering the digit(s) in order to speed up the process.

#### Using the programme/channel list:

- > Press the key **OK**.  
A list of programmes will be displayed.

When operating in TV mode, a list of TV programmes only will be displayed, when operating in Radio mode, a list of radio programmes only will be displayed. The programme/channel currently selected will be displayed in red.

- > You can now proceed to select a programme by using the **up/down arrow** keys; the selected programme will be displayed in blue.
- > Press the **OK** key for the selected programme to be viewed.
- > The **up/down arrow** keys allow you to scroll through the programme list one entry at a time.
- > The **left/right arrow** keys allow you to page through the programme list one page at a time.

### Volume adjustment

You have the facility to adjust the volume directly in your receiver, as opposed to adjusting this via your TV set controls. This makes operation even more convenient, as you now have all important functions combined on one remote control unit, and will have to use the remote control of your TV set only very rarely.

- > Use the **Volume +** key to increase the volume of your receiver, and the **Volume -** key to reduce the sound volume.
- > Press the **Sound on/off** key to mute the sound completely. Pressing the same key again will restore the sound.

## Free Manuals Download Website

<http://myh66.com>

<http://usermanuals.us>

<http://www.somanuals.com>

<http://www.4manuals.cc>

<http://www.manual-lib.com>

<http://www.404manual.com>

<http://www.luxmanual.com>

<http://aubethermostatmanual.com>

Golf course search by state

<http://golfingnear.com>

Email search by domain

<http://emailbydomain.com>

Auto manuals search

<http://auto.somanuals.com>

TV manuals search

<http://tv.somanuals.com>