

Sunfire | HRS™

*High Resolution Series
Satellite and Center
Loudspeakers*

HRS-SAT4 and HRS-SAT4C

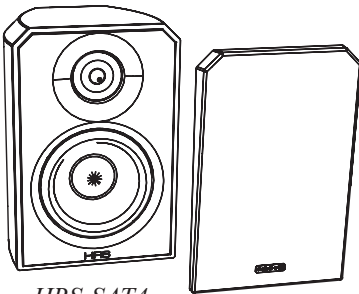

HRS-SAT4

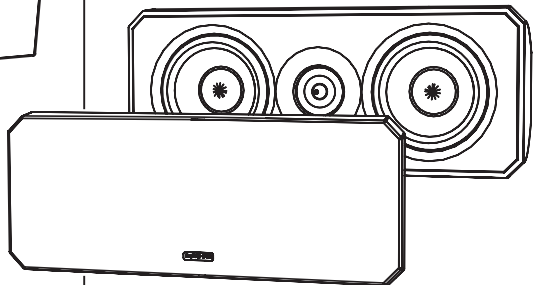



HRS-SAT4C

User's Manual

Important Safety Instructions

1. Read Instructions.
2. Keep these Instructions.
3. Heed all Warnings.
4. Follow all Instructions.
5. Do not use this apparatus near water.
6. Clean only with a dry cloth.
7. Do not install near any heat sources such as radiators, heat registers, stoves, or other apparatus (including amplifiers) that produce heat.
8. Refer all servicing to qualified service personnel. Servicing is required when the apparatus has been damaged in any way, such as a connector is damaged, liquid has been spilled or objects have fallen into the apparatus, the apparatus has been exposed to rain or moisture, does not operate normally, or has been dropped.
9. Object and Liquid Entry — Care should be taken so that objects do not fall into and liquids are not spilled into the inside of the apparatus.

	WARNING: THIS LOUDSPEAKER IS CAPABLE OF PRODUCING VERY HIGH SOUND PRESSURE LEVELS. YOU MUST TAKE EVERY PRECAUTION TO PROTECT YOUR HEARING FROM PERMANENT DAMAGE.	
-----------------------------------------------------------------------------------	-------------------------------------------------------------------------------------------------------------------------------------------------------------------------	-----------------------------------------------------------------------------------

Contents

Safety Instructions.....	2
Introduction	3
Features	5
Location	6
Using a subwoofer	8
Installation	9
Optional Stand	11
Specifications	13
Troubleshooting	14
Limited Warranty	15
Service Assistance	15

For more information on this and other Sunfire products, please visit our website:

www.sunfire.com



Introduction

Thank you for purchasing a Sunfire High Resolution Series loudspeaker. We hope you enjoy it and the music it makes as much as we have enjoyed creating it for you.

This loudspeaker follows a great heritage of both world-class loudspeaker designs and industry-leading subwoofer technologies.

The HRS-SAT4 satellite loudspeaker and HRS-SAT4C center loudspeaker are designed as a perfect match to our High Resolution Series subwoofers, resulting in an amazing home theater experience... the kind of heart-felt experience that could only come from Sunfire.

Unpacking

Your Sunfire High Resolution Series loudspeaker should reach you in perfect condition. If you do notice any shipping damage, please contact Sunfire immediately.

Gently lift out the loudspeaker and all the packing material. It is important to save all the packing materials and the box in case your loudspeaker ever needs to be moved or shipped for repair.

Make sure that you keep your sales receipt. It is the only way to establish the duration of your Limited Warranty and it may come in useful for insurance purposes.

Features

- Perfectly matched to the HRS subwoofers to form a complete system
- HRS-SAT4 can be wall-mounted, or stand on a cabinet or shelf. It can be used for left, right, surround, and surround-back applications
- HRS-SAT4C can be wall-mounted, or stand on a TV cabinet or shelf. It can be used horizontally as a center channel, or wall-mounted vertically as a left, right, or surround loudspeaker
- Two-way, high pressure design with fully-sealed enclosure, offers tight bass and high output
- Magnetically shielded
- 4.5" High Back-emf drivers (one for the HRS-SAT4, two for the HRS-SAT4C)
- 1" ring radiating tweeter
- 111 dB maximum output
- 200 watts maximum power
- Magnetic grilles
- Gold-plated 5-way terminals
- "Kickstand" tilt control (HRS-SAT4C only)
- High gloss multi-layer cabinet finish
- Optional stand for the HRS-SAT4

Care

If your loudspeaker needs servicing, please read the Troubleshooting section on page 14. If a problem persists, please contact your nearest authorized Sunfire Dealer.

Please take a moment to fill out and mail the Sunfire Customer Response card. Also read the serial number located on the rear label and record it here:

Serial Number: _____

Purchased from: _____

Date: _____

Overview

The HRS-SAT4 and HRS-SAT4C are high performance loudspeakers, specifically designed to provide high output and high performance for your home theater. Years of research and decades of experience have gone into these amazing loudspeakers.

Sunfire created the category of small-box, high-power subwoofers more than a decade ago with the original True Subwoofer. This design relies on high-pressure, "High Back-emf" technology that provides very high bass output from a very small box. When migrating this subwoofer technology to the midrange and high frequencies on these HRS loudspeakers, you get the same advantages: high output, small size, high efficiency, and years of trouble-free operation.

Woofers

The "Trifilar" voice coil (actually 3 dual voice coils wound in parallel) has a much higher output than conventional multi-layer voice coil designs, and is also significantly lighter. This, combined with the lightweight and incredibly-strong Kevlar® cone, means that the driver responds very quickly. As a result, drum kicks, and other percussive effects will sound tighter and more lifelike. Having a lightweight woofer means that it has improved top-end response. This makes for smoother integration with the tweeter in the critical upper midrange, lower treble range – where much of the vocal information lives. As a result, vocals and dialog sound very natural – not muffled or tinny.

The woofer's 1" excursion is up to four times that of conventional woofers, and provides the highest power handling in its class.

The cast aluminum basket offers more rigidity than the typical stamped variety. When driven at high volume, they will not flex, and the result is tight bass at high volume, with very low distortion.

Tweeter

The tweeter used in both the center and surround loudspeakers represents a unique approach to tweeter design that results in unrivaled performance. It shares design elements with tweeters found in very expensive European loudspeakers, and has a frequency response that is flat to above 20 kHz for crystal-clear detail from any source.

The 1" ring radiating silk dome offers instantaneous response and wide dispersion. The tweeter's vented back chamber contributes to high power handling, improves frequency response with lower distortion, and provides superior transition from high frequencies to the critical midrange.

Cabinet and baffle

The woofer(s) and tweeter are mounted to a cast aluminum front baffle that is clamped to the cabinet from the rear, forming a fully-sealed enclosure. This clamping design produces a stiff cabinet that is very resistant to vibration, resulting in tight bass response, high fidelity reproduction, and high output for music and movies.

Nine layers of paint and clear coats provide an elegant finish with protection and scratch resistance, and matches the finish of the HRS subwoofers.

Optional satellite stand

Specially designed for the HRS-SAT4, these optional stands follow the cabinet shape, and produce an integrated, one-piece look. The stand has an attractive high-gloss lacquered base and painted aluminum column.

Speaker wires are hidden inside the column, for a sleek finished product.

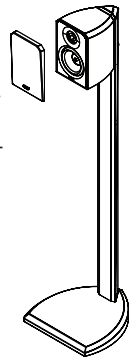

Features

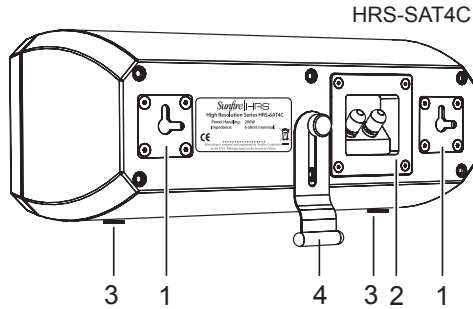
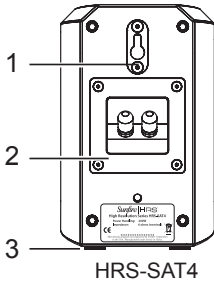

1. Mounting Brackets

The satellite loudspeaker has one keyhole bracket that allows for wall mounting and fitting onto the optional stand.

The center channel loudspeaker has two keyhole brackets, and can be mounted horizontally or vertically.

2. Binding Posts

The loudspeakers each have a pair of 5-way binding posts, that accept bare wire, pin connectors, spade connectors, banana and dual-banana plugs*.

Always use high quality connections and speaker wires, and make sure there are no loose fittings or stray wire strands.

Connect the positive speaker-level output of your power amplifier or receiver to the positive (red) input of the loudspeaker. Connect the negative speaker-level output of your power amplifier or receiver to the negative (black) input of the loudspeaker.

Make sure that the positive and negative connections do not touch, or this may damage your power amplifier.

*Note that the banana and dual-banana plugs will not work if the loudspeakers are wall-mounted, or if the HRS-SAT4 is fitted on the optional stand.

3. Anti-vibration pads

These pads can be fixed to the bottom of the loudspeakers if they are not wall mounted, and can be fixed to the rear panel if they are wall-mounted. They can also be fitted along the bottom edge of the HRS-SAT4C to allow it to tilt further up if required (see below).

To stand the center speaker vertically on a shelf, use the pads on the rear of the touching face to allow the speaker to stand vertically (or they will tilt back).

4. Kickstand

This supports the rear of the HRS-SAT4C, and allows it to tilt up or down. Tighten the knurled nut when you have found the best position.

If you are wall-mounting the loudspeaker, then the kickstand and nut must be removed. Keep them in a safe place.

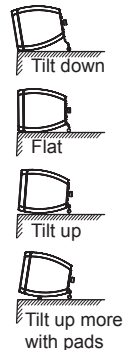

5. Grille

The grilles are attached with magnets. To remove them, gently pry away from the corners. The magnetic logo badge on the HRS-SAT4C fits either vertically or horizontally in shallow recesses in the grille, depending on how you are using the loudspeaker.

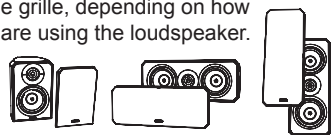

Loudspeaker Locations

The details below show various systems incorporating the loudspeakers, with a subwoofer to handle the low frequency range.

Ideally, all of the surround loudspeakers in a home theater system should be of the same make and model, and positioned at similar heights to produce a smooth and continuous soundfield.

Front Left/Right Speakers

The front left and right loudspeakers should be positioned so that your TV screen is exactly centered between them. This will help focus your attention towards the screen. The HRS-SAT4 can be wall-mounted on each side of a flat panel display, or mounted on the optional stands either side of your TV. Alternatively, you can use the HRS-SAT4C wall-mounted in a vertical orientation.

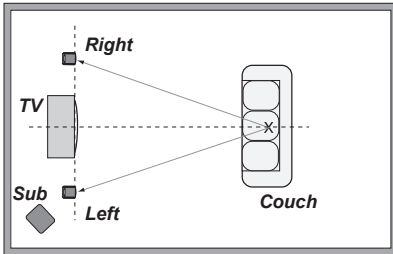

Front left and right loudspeakers

Center Loudspeaker

Most movie dialog will come from the center loudspeaker, so careful positioning is an important part of a good home theater system. Your eyes and ears should focus your attention towards the center of the screen.

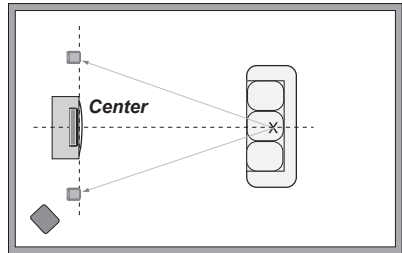

Center loudspeaker

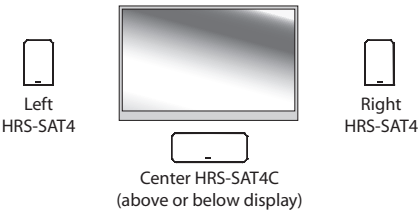

Wall-mounted display and loudspeakers

The left loudspeaker should be set exactly the same distance and angle away from your listening position as the right loudspeaker.

The center loudspeaker can sit on top, or directly underneath the TV, as long as it is located on the centerline and not off to one side. Use the kickstand to adjust the elevation angle so it is pointing towards your listening position.

Position the front face of the loudspeaker close to the front edge of the TV cabinet. (The sound waves may otherwise reflect off the top of the TV cabinet and distort the center imaging.)

For flat panel displays, the center loudspeaker can be fitted on the walls directly

above or below the display, as long as it is located on the centerline and not off to one side.

If possible, have the center, left and right loudspeakers at the same height (within two feet). This will help give a smooth transition when sound effects move from loudspeaker to loudspeaker.

5.1 Configuration

Place each surround loudspeaker an equal distance away from your central listening position, and keep them at least one or two feet above ear level (with you sitting down).

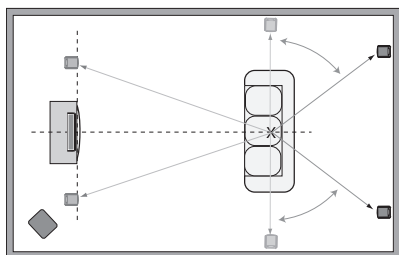

5.1 System

They can be placed behind the listening position, on the rear walls or the side walls, or on the optional stands.

You can also experiment with “toeing-in” the speakers slightly, to direct the high frequencies to the listening position.

6.1 and 7.1 Configuration

Sunfire home theater processors and receivers have two extra outputs for surround back loudspeakers. These create a wonderful sense of realism in surround effects during playback of Dolby Digital EX, Dolby Pro Logic IIx, and DTS-ES.

Such systems can be configured for one or two surround back loudspeakers.

If you are connecting one surround back loudspeaker, place it directly behind your listening position and move the surround loudspeakers to the side as shown:

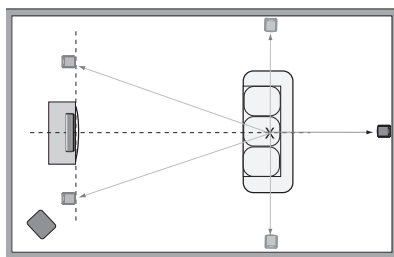

6.1 System

With two surround back loudspeakers, set them behind and between the surround loudspeakers:

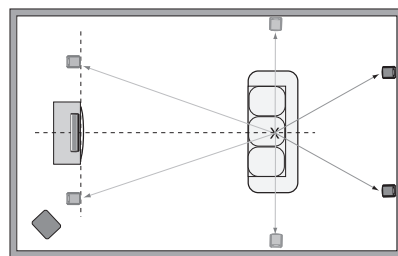

7.1 System

9.1 Configuration

Some Sunfire home theater processors and receivers have two side-axis channels that are matrixed from the left and right front channels, and they are available in stereo as well as surround modes.

Place the side-axis loudspeakers along the side walls, close to the fronts. You can also angle them in towards your listening position.

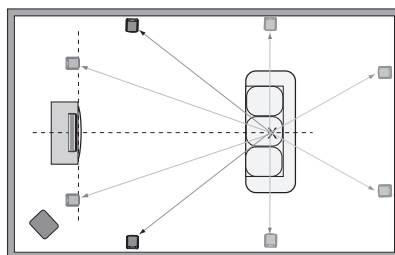

9.1 System

Subwoofer Location

The best location for a single subwoofer can be found by following these steps:

1. Place the subwoofer on your couch or favorite easy-listening chair.
2. You can then either run a calibration (noise) signal through it, or play some of your favorite music samples with heavy bass.
3. Walk around the room, standing in all the positions where you might be able to place the subwoofer. This is usually somewhere close to the corners of the room. Try locations fairly close to the front loudspeakers, and try crouching down low.
4. Find the place in the room where the bass output from the subwoofer is most even. Shut things down and install the subwoofer there.
5. This is the best position for the subwoofer. The bass will sound the best when you are sitting in your normal listening position.

Using a subwoofer



The loudspeakers are designed to be used with a subwoofer to fill in the lower frequency range.

They are not designed to accept 200 watts of power at the full frequency range.

The Sunfire High Resolution Series subwoofers are a perfect match for the satellite and center loudspeakers. Three subwoofer models are available: HRS-8, HRS-10, and HRS-12.

Your system should be designed so that the satellite and center loudspeakers receive only the range above 95 Hz, with a subwoofer to handle the frequencies below 95 Hz.

Sunfire home theater processors and receivers have a bass management system that allows you to redirect the bass frequency range of each channel to the subwoofer. The advantages are :

- The overall bass of the system is improved, as subwoofers, such as Sunfire's powered HRS subwoofers are specially designed for this frequency range.
- The subwoofer can simultaneously play the bass from all of the loudspeakers, in addition to its own low frequency effects channel (LFE).
- There is no loss in perception of the position of movie or music sound effects, as the ear cannot easily locate the position of bass sound sources.
- Compact loudspeakers can be used for front, center and surrounds, as they do not have to reproduce the low frequency range. This leads to a saving in room space.
- Your amplifiers do not waste power reproducing the low frequency range.

Installation

Read the details on page 6 and 7 to help determine the best position for your loudspeaker.

The loudspeaker can be wall-mounted, or simply placed on bookshelves or on top of TV cabinets. If you are not wall-mounting the loudspeaker, then we recommend that you add the supplied anti-vibration pads to the bottom surface.

To wall-mount the loudspeaker, please follow the instructions below.

Tools required:

- Phillips screwdriver
- Pencil or other marker
- Electric drill and 5/16" drill bit
- Level
- Safety glasses
- Step ladder if needed
- Electronic stud finder
- Wood screws and dry wall anchors with screws are supplied

Preliminary steps:

- Clear the area where you are going to work, so it will be safe.



Make sure there is no wiring, or gas or water pipes behind the wall where you are going to drill!

- Temporarily remove any wall-mounted flat screen display if you will be working close to it.
- We recommend mounting the loudspeakers into a wall stud.
- If you have to mount the loudspeakers onto a masonry wall, we recommend that you consult with your hardware supplier to buy suitable masonry hardware.

The HRS-SAT4 weighs 7.0 lb. (3.2 kg) and the HRS-SAT4C weighs 12.0 lb. (5.4 kg). You should allow a good safety margin. If in doubt, please contact your Sunfire dealer for professional installation.

Wall-mounting the HRS-SAT4

Into a wall stud

1. Use a studfinder to find the location of a wall stud. Mark the wall with a pencil on the centerline of the stud, at the height of the keyhole bracket of the loudspeaker.
2. Put on your safety glasses. With a 5/16" drill bit, drill through the dry wall at this mark, without going into the wall stud. Remove any dust.
3. Screw in the supplied woodscrew into the wall stud by hand, until the head is sticking out approximately 1/8". Jump to step 8 below.

Into dry wall

4. Find the best location, and mark the wall with a pencil in the location and height of the keyhole.
5. Put on your safety glasses. With a 5/16" drill bit, drill a hole through the dry wall at this mark. Remove any dust or particles.
6. Press a dry wall anchor (supplied) into the hole, and gently tap it in flush.
7. Tighten the screw by hand, until the head is sticking out 1/8".
8. To reduce the chance of the loudspeaker vibrating against the wall, place the supplied anti-vibration pads in two locations on the rear panel.

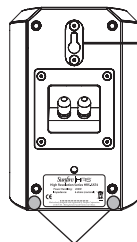

Keyhole bracket

Anti-vibration pads

- Connect your speaker wires to the back of the loudspeaker, making sure of the correct polarity. Gently pull on the wires to make sure of a good connection. Secure the wires so their weight is not pulling against the terminals. Note that banana or dual-banana plugs will not work when wall-mounting the loudspeaker, or when fitting the HRS-SAT4 on the optional stand.
- Hold the loudspeaker in place, so the keyhole lines up with the screw on the wall. Make sure that the screw head is securely in the keyhole slot. If the loudspeaker feels loose, drive the screw in further and remount the loudspeaker.

- Put on your safety glasses. With a 5/16" drill bit, drill through the dry wall at each mark, without drilling into the wall stud. Remove any dust.
- For holes into a wall stud, screw in the supplied woodscrew into the wall stud by hand, until the head is sticking out approximately 1/8".
- For holes into dry wall, press a dry wall anchor into each hole, and gently tap them in flush. Tighten the screws by hand, until the heads are sticking out approximately 1/8".
- To reduce the chance of the loudspeaker vibrating against the wall, place the supplied anti-vibration pads in two locations on the rear panel as shown.

Wall-mounting the HRS-SAT4C

The HRS-SAT4C comes with a wall-mount template to help you mark the correct position for the two mounting screws. It is recommended that you get at least one of the screws into a wall stud, if possible. If this is not possible, then two dry wall anchors and screws are supplied.

Remove the nut and the kickstand bracket, and keep them in a safe place.

- Use a studfinder to find the location of a suitable wall stud.
- Position the wall-mount template so that one of the holes is over the wall stud centerline, at the right height. Use a level to make sure that the two holes are horizontal (or vertical, if that is your preference).

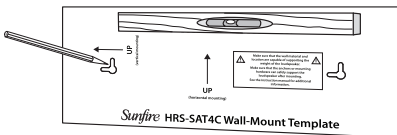

- Mark the wall with a pencil in the location of the two holes, and remove the template.

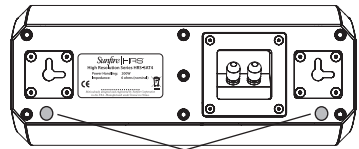

Anti-vibration pads

- Connect your speaker wires to the back of the loudspeaker, making sure of the correct polarity. Secure the wires so their weight is not pulling against the terminals. Note that banana or dual-banana plugs will not work when wall-mounting the loudspeaker.
- Hold the loudspeaker in place, so the keyholes line up with the screws on the wall. Make sure that the screwheads are securely in the keyhole slots. If the loudspeaker feels loose, drive the screws in further and remount the loudspeaker.

Optional Satellite Stand

The HRS-SAT4 satellite loudspeaker has an optional stand that allows it to be installed neatly in your room.

The base of the stand can be fitted with four spikes, or four rubber-tipped spikes if you have hardwood floors etc.

Tools required:

- Allen wrench (supplied with stand)

Preliminary steps:

- Run the speaker cables to each location, so these can be fitted to the HRS-SAT4 loudspeaker during the assembly of the stand. See page 6 and 7 for placement options.

Procedure:

1. Fit the column into the base, and secure it with three screws supplied. Fit the four spikes or rubber-tipped spikes to the base and tighten with the supplied wrench.

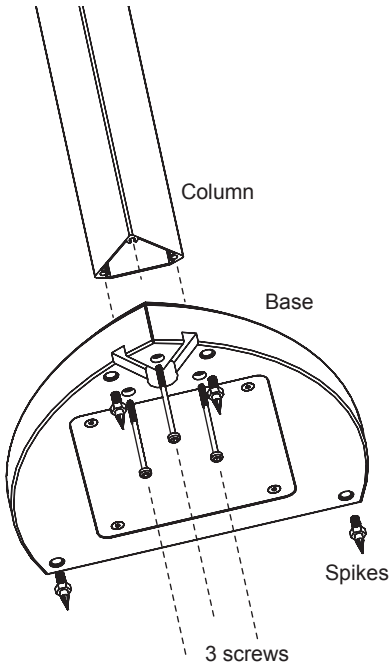

2. Feed the speaker wires up through the base, until they can be gently pulled through the rectangular hole near the top of the column.

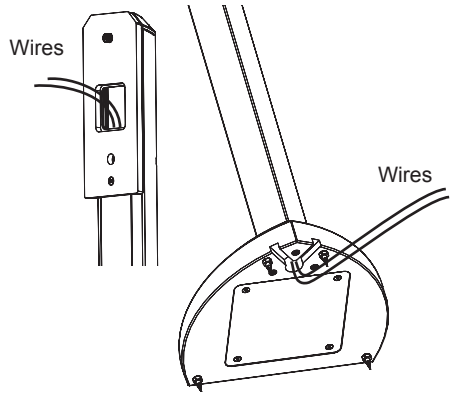

3. Connect the speaker wires to the loudspeaker rear terminals. Make sure the polarity is correct, and gently pull on the wires to make sure they make a secure connection. Note that single and dual-banana plugs cannot be used with this stand.

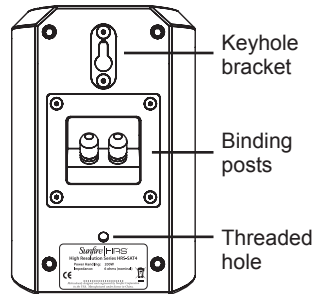

4. Fit the keyhole bracket in the rear of the loudspeaker over the screw head that sticks out near the top of the column. Check that it is securely in the keyhole slot.

5. Pass the large screw through the hole in the rear side of the column, and into the threaded hole in the rear of the loudspeaker. Be careful not to pinch or cut the speaker wires with the screw, or jam the wires between the loudspeaker and the top of the column. Tighten the screw until the loudspeaker is secured flush with the column.

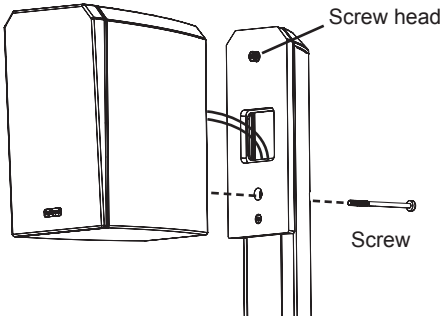

6. Move the loudspeaker/stand assembly into position in your room. Make sure that the speaker wires pass through the slots in the base when you set it down.

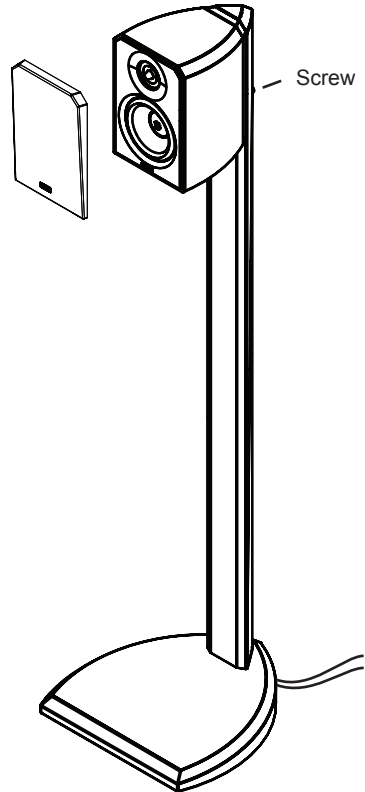
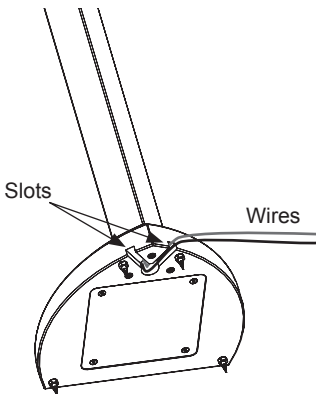

HRS-SAT4 mounted to the stand

7. Test that the loudspeaker is working correctly. If your home theater processor or receiver has a test tone system, try sending test tones through all of the loudspeakers in your system, to check for correct operation.

Specifications

Design

2 way, High Pressure

Drive Units

HF: 1-inch ring radiating tweeter

LF: 4.5-inch High Back-emf

Frequency Response

95 Hz to 30 kHz

Crossover Frequency

1.5 kHz

Maximum Power

200 watts

Minimum Power

25 watts

Sensitivity (2.83 V/1 meter)

88 dB

Maximum Output

111 dB

Impedance

6 ohms nominal

Connections

1 pair of gold plated 5-way terminals

Dimensions

(Maximum dimensions, including grille)

HRS-SAT4

Height	8.0" (203.2 mm)
Width	5.45" (138.4 mm)
Depth	6.0" (152.4 mm)
Weight	7.0 lb. (3.2 kg)

HRS-SAT4C

Height	5.45" (138.4 mm)
Width	13.2" (335.3 mm)
Depth	6.0" (152.4 mm)
Weight	12.0 lb. (5.4 kg)

© 2008 Sunfire, LLC.

All rights reserved. Sunfire, LLC reserves the right to improve its products at any time. Therefore, specifications are subject to change without notice.

Manual 913-150-00 Rev A

Troubleshooting

The HRS-SAT4 and HRS-SAT4C loudspeakers are designed and built to provide years of trouble-free performance. Most problems that occur can usually be solved by checking your setup, or by making sure all components are fully operational.

The following information will help you deal with common problems you may experience. If a problem persists, please contact your Dealer for assistance.

Poor or no sound

- Check all the connections from the loudspeaker to the amplifier or receiver. Swap loudspeakers around, and see if the poor sound follows a particular loudspeaker.
- Check that your amplifier is not driven too hard or is clipping. Even a low-powered amplifier driven into clipping can cause distortion, or damage your loudspeakers.
- Many processor/preamps can send test tones through all the loudspeakers in your system. Use this to adjust the volume of each channel until they are all playing at the same level. Make sure that any bass management options are set correctly, and any channels using the loudspeakers are set to "small," or "95 Hz."
- If the system bass is weak only when playing surround sources, check that your processor is correctly set to decode the surround modes, such as Dolby Digital or DTS.
- Some DVD discs have a menu that allows you to select which soundtrack to play. Check that the correct surround audio soundtrack is selected.

Limited Warranty

Sunfire, LLC is proud of its products that have been built with care using advanced technology and premium component parts. Your unit has been crafted to perform properly for many years. Sunfire offers the following Warranty to you, the owner of a new Sunfire product:

The Sunfire Warranty for the HRS-SAT4 and HRS-SAT4C loudspeakers is in effect for FIVE years from the date of original retail purchase. The Sunfire Warranty covers defects in materials and workmanship. The following, however, are excluded:

- a) Damage caused during shipment.
- b) Damage caused by accident, misuse, abuse of operation contrary to the instructions specified in the Sunfire user's manual
- c) Units where the serial number has been defaced, modified or removed,
- d) Damage resulting from modification or attempted repair by any person not authorized in writing by Sunfire, LLC.
- e) Units purchased from unauthorized dealers.

The Sunfire Warranty extends to the original owner during the five year warranty period so long as the original dated purchase receipt is presented whenever warranty service is required.

All implied warranties, including warranties or merchantability and fitness for particular purposes, are limited in duration to the five year length of this Warranty, unless otherwise provided by state law.

Sunfire's liability is limited to the repair or replacement, at our option, of any defective product and shall not in any event include property or any other incidental or consequential damages which may result from the failure of this product.

Some states do not allow limitations on how long an implied warranty lasts and/or do not allow the exclusion or limitation of incidental or consequential damages, so the above limitations or exclusions may not apply to you.

This Warranty gives you specific legal rights, and you may also have other rights which vary from state to state. We suggest that you attach your purchase receipt to this Warranty and keep these in a safe place. Thank you for your choice of a Sunfire product.

Service Assistance

We suggest that you read the Limited Warranty completely to fully understand your Warranty/Service coverage.

If your Sunfire product ever requires service, write to us, or call:

Sunfire, LLC
Technical Services Department
P.O. Box 1589
Snohomish, WA 98290
support@sunfire.com
Tel (425) 335-4748
Fax (425) 335-4746

You will be directed to an authorized Sunfire Service Station or receive instructions to ship the unit to the factory. Please save the original shipping carton and packing materials in case shipping is required. Please do not ship Parcel Post.

NOTE: Before sending in your unit for repair, you must call Sunfire for return authorization (RA).

Include a complete description of the problem, indicating how you have it connected, the associated equipment in your system and a copy of your purchase receipt. Initial shipping costs are not paid by Sunfire; return ground shipping costs will be prepaid if repairs were covered by the scope of this Warranty.

Sunfire | HRS™

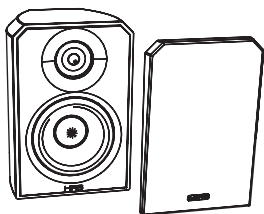

HRS-SAT4

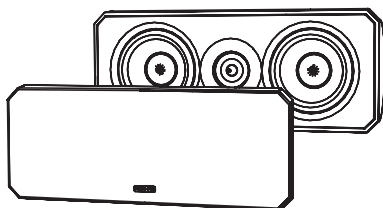

HRS-SAT4C

*High Resolution Series
Satellite and Center
Loudspeakers
HRS-SAT4 and HRS-SAT4C*

*Sunfire, LLC
P.O. Box 1589
Snohomish
WA 98291*

*Tel (425) 335-4748
Fax (425) 335-4746
www.sunfire.com*

Manual 913-150-00 Rev A

Free Manuals Download Website

<http://myh66.com>

<http://usermanuals.us>

<http://www.somanuals.com>

<http://www.4manuals.cc>

<http://www.manual-lib.com>

<http://www.404manual.com>

<http://www.luxmanual.com>

<http://aubethermostatmanual.com>

Golf course search by state

<http://golfingnear.com>

Email search by domain

<http://emailbydomain.com>

Auto manuals search

<http://auto.somanuals.com>

TV manuals search

<http://tv.somanuals.com>