

Digital Video Camera Recorder Video Camera Recorder **Hi8**

Operating Instructions

Before operating the unit, please read this manual thoroughly, and retain it for future reference.

Owner's Record

The model and serial numbers are located on the bottom. Record the serial number in the space provided below. Refer to these numbers whenever you call upon your Sony dealer regarding this product.

Model No. _____ -TRV _____ Model No. AC- _____

Serial No. _____ Serial No. _____

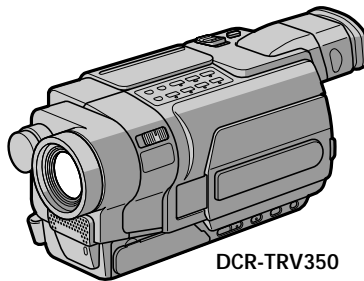

Digital Handycam

Handycam Vision™



Digital 8

DCR-TRV150/TRV250/TRV350/TRV351 

video Hi8

CCD-TRV118/TRV318/TRV418 **Hi8**

Welcome!

Congratulations on your purchase of this Sony Handycam. With your Handycam, you can capture life's precious moments with superior picture and sound quality. Your Handycam is loaded with advanced features, but at the same time it is very easy to use. You will soon be producing home video that you can enjoy for years to come.

WARNING

To prevent fire or shock hazard, do not expose the unit to rain or moisture.

For the customers in the U.S.A.

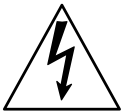
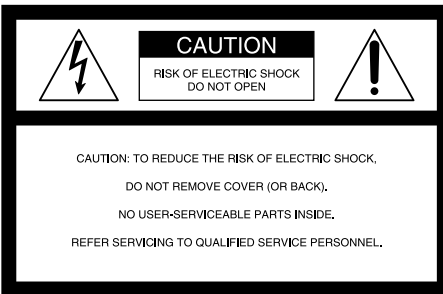

This symbol is intended to alert the user to the presence of uninsulated "dangerous voltage" within the product's enclosure that may be of sufficient magnitude to constitute a risk of electric shock to persons.



This symbol is intended to alert the user to the presence of important operating and maintenance (servicing) instructions in the literature accompanying the appliance.

If you have any questions about this product, you may call:
Sony Customer Information Center 1-800-222-SONY (7669)
The number below is for the FCC related matters only.

Regulatory Information

Declaration of Conformity

Trade Name: SONY
Model No.: DCR-TRV150,
DCR-TRV250
Responsible Party: Sony Electronics Inc.
Address: 680 Kinderkamack
Road, Oradell,
NJ07649 U.S.A.
Telephone No.: 201-930-6972
This device complies with Part 15 of the FCC Rules. Operation is subject to the following two conditions: (1) This device may not cause harmful interference, and (2) this device must accept any interference received, including interference that may cause undesired operation.

Declaration of Conformity

Trade Name: SONY
Model No.: DCR-TRV350
Responsible Party: Sony Electronics Inc.
Address: 680 Kinderkamack
Road, Oradell,
NJ07649 U.S.A.
Telephone No.: 201-930-6972
This device complies with Part 15 of the FCC Rules. Operation is subject to the following two conditions: (1) This device may not cause harmful interference, and (2) this device must accept any interference received, including interference that may cause undesired operation.

CAUTION

You are cautioned that any changes or modifications not expressly approved in this manual could void your authority to operate this equipment.

Note:

This equipment has been tested and found to comply with the limits for a Class B digital device, pursuant to Part 15 of the FCC Rules. These limits are designed to provide reasonable protection against harmful interference in a residential installation. This equipment generates, uses, and can radiate radio frequency energy and, if not installed and used in accordance with the instructions, may cause harmful interference to radio communications. However, there is no guarantee that interference will not occur in a particular installation. If this equipment does cause harmful interference to radio or television reception, which can be determined by turning the equipment off and on, the user is encouraged to try to correct the interference by one or more of the following measures:

- Reorient or relocate the receiving antenna.
- Increase the separation between the equipment and receiver.
- Connect the equipment into an outlet on a circuit different from that to which the receiver is connected.
- Consult the dealer or an experienced radio/TV technician for help.

The supplied interface cable must be used with the equipment in order to comply with the limits for a digital device pursuant to Subpart B of Part 15 of FCC Rules.

For the customers in the U.S.A. and CANADA

CAUTION

TO PREVENT ELECTRIC SHOCK, MATCH WIDE BLADE OF PLUG TO WIDE SLOT, FULLY INSERT.

RECYCLING LITHIUM-ION BATTERIES

Lithium-Ion batteries are recyclable. You can help preserve our environment by returning your used rechargeable batteries to the collection and recycling location nearest you.



For more information regarding recycling of rechargeable batteries, call toll free 1-800-822-8837, or visit <http://www.rbc.org/>.

Caution: Do not handle damaged or leaking Lithium-Ion batteries.

Main Features

On the model name indication

In this manual, camcorder-shape icons are used to indicate model names.

CCD-TRV118 : 

DCR-TRV150 : 

CCD-TRV318 : 

DCR-TRV250 : 

CCD-TRV418 : 

DCR-TRV350 : 

DCR-TRV351 : 

Instructions with no icons are for all models.



Instructions with icons are for the indicated models only.

Before you start reading this manual, check the model name of your camcorder.

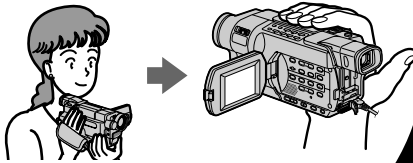
Recording moving or still images, and playing them back







On the tape

- Recording moving pictures (p. 30)
- Recording still images   (p. 56)
- Playing back a tape (p. 45)

On the “Memory Stick”

- Recording still images (p. 132)
- Recording moving pictures (p. 146)
- Viewing still images (p. 163)
- Viewing moving pictures (p. 166)

- Viewing pictures recorded on a tape or live from your camcorder on your computer – USB Streaming (p. 183)
- Capturing images on your computer from your camcorder using the USB cable (p. 197)
- Viewing images recorded on a “Memory Stick” using the USB cable   (p. 185)
- Converting an analog signal into digital to capture images onto your computer   (p. 208)

Capturing images on your computer

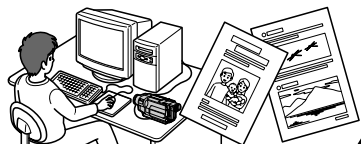

Other uses

Functions for adjusting exposure in the recording mode

- BACK LIGHT (p. 38)
- NightShot (p. 39)
- Super NightShot/Color Slow Shutter **350** **351** (p. 39, 40)
- PROGRAM AE (p. 68)
- Adjusting the exposure manually (p. 70)
- Built-in light (p. 79)

Functions for giving images more impact

- Digital zoom (p. 34) The default setting is OFF. (To zoom greater than 20×, select the digital zoom power in D ZOOM in the menu settings.)
- Fader (p. 61)
- Picture effect (In recording mode) (p. 64)
- Digital effect (In recording mode) **350** **351** (p. 65)
- Title (p. 75, 77)
- MEMORY MIX **350** **351** (p. 140)

Functions for giving a natural appearance to your recordings

- SPORTS (p. 68)
- LANDSCAPE (p. 68)
- Manual focus (p. 71)

Functions for use on recorded tapes

- END SEARCH (p. 43)
- EDITSEARCH/Rec Review **350** **351** (p. 43)
- DATA CODE **250** **350** **351** (p. 47)
- Tape PB ZOOM **350** **351** (p. 87)
- ZERO SET MEMORY **250** **350** **351** (p. 89)
- Easy Dubbing **118** **318** **418** (p. 98)
- Digital program editing **150** **250** **350** **351** (p. 106)

Contents of the recording cannot be compensated if recording or playback is not made due to a malfunction of the camcorder, storage media, etc.

Table of contents

| | |
|------------------------------------|---|
| Main Features | 4 |
| Checking supplied accessories..... | 9 |

Quick Start Guide

| | |
|--|----|
| - Recording on a tape | 10 |
| - Recording on a "Memory Stick" 350 351 | 12 |

Getting Started

| | |
|--|----|
| Using this manual | 14 |
| Step 1 Preparing the power supply ... | 18 |
| Installing the battery pack..... | 18 |
| Charging the battery pack..... | 19 |
| Connecting to a wall outlet | 24 |
| Step 2 Setting the date and time | 26 |
| Step 3 Inserting a cassette | 28 |

Recording – Basics

| | |
|--|----|
| Recording a picture | 30 |
| Shooting a backlit subject | |
| - BACK LIGHT | 38 |
| Shooting in the dark | |
| - NightShot | |
| - Super NightShot 350 351 | |
| - Color Slow Shutter 350 351 | 39 |
| Self-timer recording 350 351 | 41 |
| Superimposing the date and time on pictures 118 318 418 | 42 |
| Checking recordings | |
| - END SEARCH | |
| - EDITSEARCH 350 351 | |
| - Rec Review 350 351 | 43 |

Playback – Basics

| | |
|----------------------------------|----|
| Playing back a tape | 45 |
| To display the screen indicators | |
| - Display function | 47 |
| Viewing recordings on TV | 51 |

Advanced Recording Operations

| | |
|--|----|
| Recording still images on a "Memory Stick" while recording on a tape 350 351 | 53 |
| Recording still images on a tape | |
| - Tape Photo recording 150 250 | 56 |
| Using the wide mode | 58 |
| Using the fader function | 61 |
| Using special effects | |
| - Picture effect | 64 |
| Using special effects | |
| - Digital effect 350 351 | 65 |
| Using the PROGRAM AE function | 68 |
| Adjusting the exposure manually | 70 |
| Focusing manually | 71 |
| Interval recording 150 250 350 351 | 72 |
| Frame by frame recording | |
| - Frame recording 150 250 350 351 | 74 |
| Superimposing a title | 75 |
| Making your own titles | 77 |
| Using the built-in light | 79 |
| Inserting a scene 350 351 | 82 |

Advanced Playback Operations

| | |
|--|----|
| Playing back a tape with picture effects 150 250 350 351 | 83 |
| Playing back a tape with digital effects 350 351 | 85 |
| Enlarging recorded images | |
| - Tape PB ZOOM 350 351 | 87 |
| Quickly locating a scene | |
| - ZERO SET MEMORY 250 350 351 | 89 |
| Searching for a recording by date | |
| - DATE SEARCH 250 350 351 | 90 |
| Searching for a photo | |
| - PHOTO SEARCH/ PHOTO SCAN 250 | 92 |

Table of contents

Editing

| | |
|--|-----|
| Dubbing a tape | 94 |
| Dubbing a tape easily – Easy Dubbing 118 318 418 | 98 |
| Dubbing only desired scenes – Digital program editing (on tapes) 150 250 350 351 | 106 |
| Recording video or TV programs 150 250 350 351 | 119 |
| Inserting a scene from a VCR – Insert Editing 250 350 351 | 123 |

“Memory Stick” Operations

350 **351**

– Recording

| | |
|---|-----|
| Using a “Memory Stick” – Introduction | 126 |
| Recording still images on a “Memory Stick” – Memory Photo recording | 132 |
| Recording images from a tape as still images | 136 |
| Superimposing a still image in the “Memory Stick” on an image – MEMORY MIX | 140 |
| Recording moving pictures on a “Memory Stick” – MPEG movie recording | 146 |
| Recording pictures from a tape as a moving picture | 150 |
| Interval Photo recording | 154 |
| Recording edited pictures as a moving picture – Digital program editing (on a “Memory Stick”) | 156 |
| Setting up a folder | 160 |

– Playback

| | |
|--|-----|
| Viewing still images – Memory Photo playback | 163 |
| Viewing moving pictures – MPEG movie playback | 166 |
| Selecting a folder to view | 169 |
| Copying images recorded on a “Memory Stick” to a tape | 170 |
| Enlarging still images recorded on a “Memory Stick” – Memory PB ZOOM | 172 |
| Playing back images continuously – SLIDE SHOW | 174 |
| Preventing accidental erasure – Image protection | 176 |
| Deleting images – DELETE | 177 |
| Writing a print mark – PRINT MARK | 180 |

Viewing Images on Your Computer

| | |
|--|-----|
| Viewing images on your computer – Introduction 150 250 350 351 | 182 |
| Connecting your camcorder to your computer using the USB cable (Windows) 250 350 351 | 187 |
| Viewing pictures recorded on a tape or live from your camcorder on your computer – USB Streaming (Windows) 250 350 351 | 197 |
| Viewing images recorded on a “Memory Stick” on your computer (Windows) 350 351 | 202 |
| Connecting your camcorder to your computer using the USB cable (Macintosh) 350 351 | 205 |
| Viewing images recorded on a “Memory Stick” on your computer (Macintosh) 350 351 | 207 |
| Capturing images from an analog video unit on your computer – Signal convert function 350 351 | 208 |

Table of contents

Customizing Your Camcorder

Changing the menu settings 210

Troubleshooting

Types of trouble and how to correct
trouble 224

Self-diagnosis display 232

Warning indicators and messages 233

Additional Information

About video cassette 237

About the “Memory Stick” 240

About the “InfoLITHIUM” battery
pack 242

About i.LINK 244

Using your camcorder abroad 246

Maintenance information and
precautions 247

Specifications 253

Quick Reference

Identifying parts and controls 256

Index 267

- **Hi8** and **Hi8i** are trademarks.
- i.LINK and **i** are trademarks.
- “InfoLITHIUM” is a trademark of Sony Corporation.
- “Memory Stick,”  and “MagicGate Memory Stick” are trademarks of Sony Corporation.
- “Memory Stick Duo” and **MEMORY STICK DUO** are trademarks of Sony Corporation.
- Windows and Windows Media are trademarks or registered trademarks of Microsoft Corporation in the United States and/or other countries.
- Pentium is trademark or registered trademark of Intel Corporation.
- Macintosh and Mac OS, QuickTime are trademarks of Apple Computer Inc.
- All other product names mentioned herein may be the trademarks or registered trademarks of their respective companies. Furthermore, “™” and “®” are not mentioned in each case in this manual.

Checking supplied accessories

Make sure that the following accessories are supplied with your camcorder.

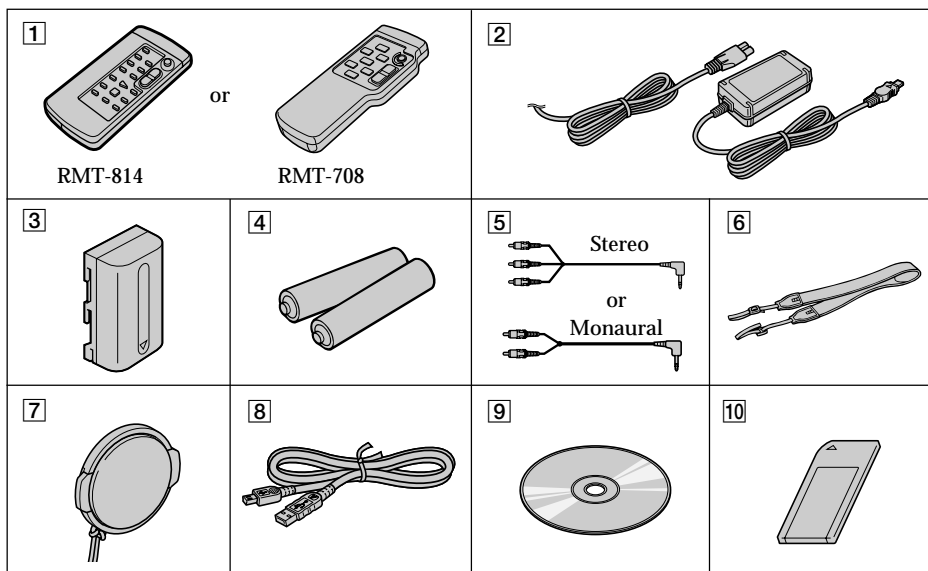

- 1** Wireless Remote Commander (1)
(p. 264)

RMT-814: **250** **350** **351**

RMT-708: **418**

- 2** AC-L15A/L15B AC Adaptor (1), Power
cord (1) (p. 19)

- 3** NP-FM30 Rechargeable Battery Pack
(1) (p. 18, 19)

- 4** Size AA (R6) battery for Remote
Commander (2) **418** **250** **350**
351 (p. 264)

- 5** A/V connecting cable (1) (p. 51, 94, 95)

Stereo: **150** **250** **350** **351**

Monaural: **118** **318** **418**

- 6** Shoulder strap (1) (p. 256)

- 7** Lens cap (1) (p. 30)

- 8** USB cable (1) **250** **350** **351** (p. 182)

- 9** CD-ROM (SPVD-010 USB Driver) (1)
250 **350** **351** (p. 189)

- 10** "Memory Stick" (1) **351** (p. 240)

Quick Start Guide – Recording on a tape

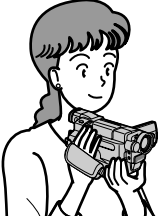

This chapter introduces you to the basic features to record on a tape of your camcorder. See the page in parentheses "()" for more information.

1 Connecting the power cord (p. 24)

Use the battery pack when using your camcorder outdoors (p. 18).

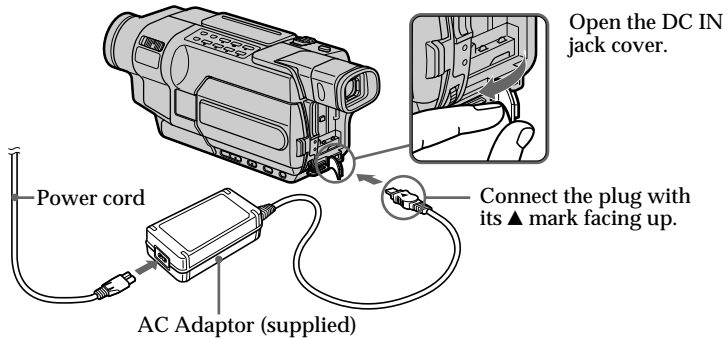

2 Inserting a cassette (p. 28)

- 1 Slide **OPEN/EJECT** in the direction of the arrow and open the lid.

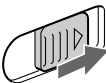

- 2 Push the center of the cassette back and insert the cassette properly with the cassette window facing up.

- 3 Close the cassette compartment by pressing **PUSH** on the cassette compartment. After the cassette compartment goes down completely, close the lid.

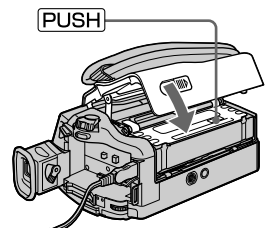
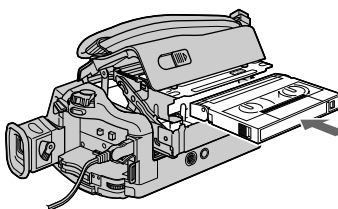
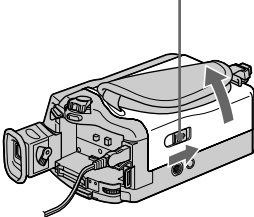

3 Recording a picture (p. 30)

1 Remove the lens cap.

The cap is not attached when you purchase your camcorder.

3 Open the LCD panel while pressing OPEN. The picture appears on the LCD screen.

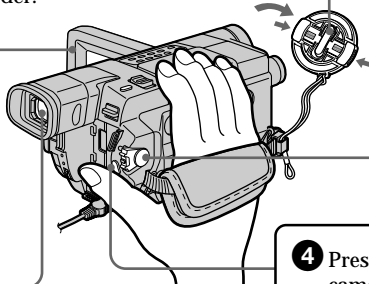

2 Set the POWER switch to CAMERA while pressing the small green button.

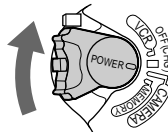

4 Press START/STOP. Your camcorder starts recording. To stop recording, press START/STOP again.



Viewfinder

View a picture placing your eye against this part when the LCD panel is closed (p. 32). Adjust the viewfinder lens to your eyesight (p. 35). The picture in the viewfinder is black and white.

When you purchase your camcorder, the clock is not set up yet. If you want to record the date and time for a picture, set the clock before recording (p. 26).

4 Monitoring the playback picture on the LCD screen (p. 45)

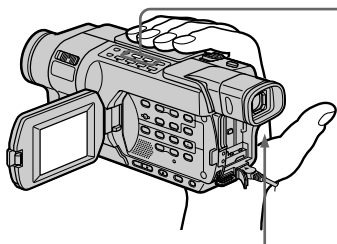

2 Press ◀◀ to rewind the tape.



3 Press ▶▶ to start playback.



1 Set the POWER switch to VCR/PLAYER while pressing the small green button.*

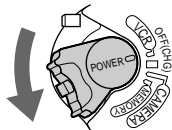

Note

Do not pick up your camcorder by the viewfinder, the LCD panel, or the battery pack.

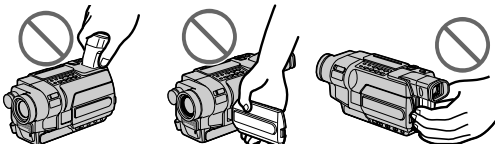

* Modes on the POWER switch vary depending on models (p. 16).

Quick Start Guide - Recording on a "Memory Stick"

350 351

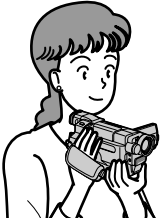

This chapter introduces you to the basic features to record on a "Memory Stick" of your camcorder. See the page in parentheses "()" for more information.

1 Connecting the power cord (p. 24)

Use the battery pack when using your camcorder outdoors (p. 18).

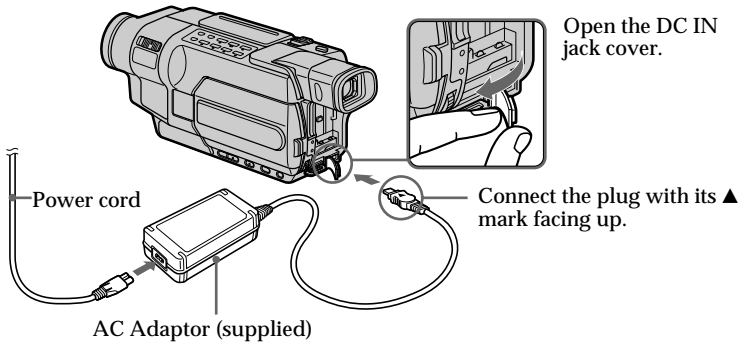

2 Inserting a "Memory Stick" (p. 127)

Insert a "Memory Stick" in the "Memory Stick" slot as far as it can go with the ◀ mark facing the LCD panel as illustrated.

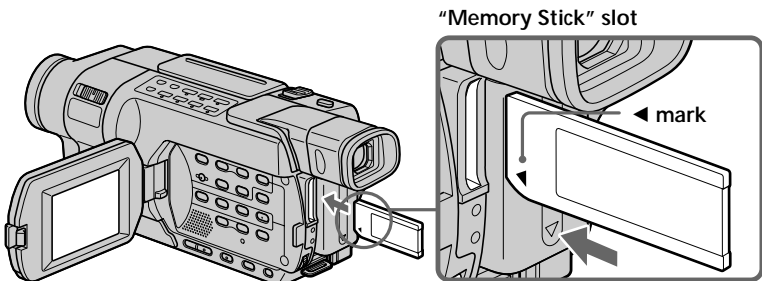

When ejecting the "Memory Stick," press the "Memory Stick" once lightly.

3

Recording a still image on a "Memory Stick" (p. 132)

1 Remove the lens cap.

The cap is not attached when you purchase your camcorder.

3 Open the LCD panel while pressing OPEN. The picture appears on the screen.

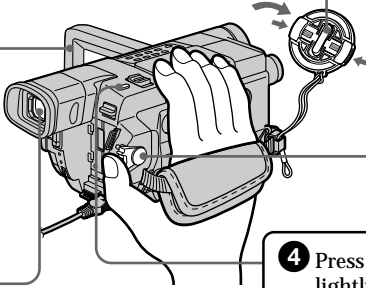

Viewfinder

View a picture placing your eye against this part when the LCD panel is closed (p. 32). Adjust the viewfinder lens to your eyesight (p. 35). The picture in the viewfinder is black and white.

2 Set the POWER switch to MEMORY while pressing the small green button. Make sure that the LOCK switch is set to the left (unlock) position.

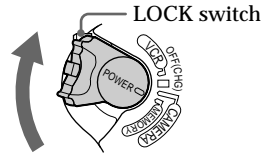

4 Press PHOTO lightly.



5 Press PHOTO deeper.

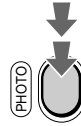

When you purchase your camcorder, the clock is not set up yet. If you want to record the date and time for a picture, set the clock before recording (p. 26).

4

Monitoring the playback still images on the LCD screen (p. 163)

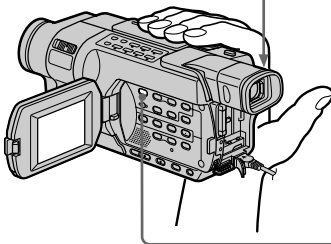

1 Set the POWER switch to MEMORY or VCR while pressing the small green button.

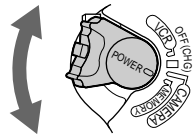

2 Press MEMORY PLAY. The last recorded image is displayed.



Press MEMORY +/- to select the desired image.

Note

Do not pick up your camcorder by the viewfinder, the LCD panel or the battery pack.

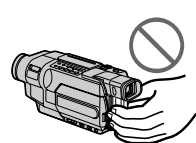
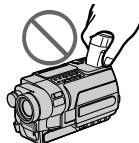

Using this manual

The instructions in this manual are for the seven models listed in the table below. Before you start reading this manual and operating your camcorder, check the model number by looking at the bottom of your camcorder. The DCR-TRV350 is the model used for illustration purposes. Otherwise, the model name is indicated in the illustrations. Any differences in operation are clearly indicated in the text, for example, “**350**.”

As you read through this manual, buttons and settings on your camcorder are shown in capital letters.

e.g. Set the POWER switch to CAMERA.

When you carry out an operation, you can hear a beep to indicate that the operation is being carried out.

Types of differences

| Model | video Hi8 | | | Digital 8 | | |
|---------------------|------------|------------|------------|------------|------------|-----------------------|
| | 118 | 318 | 418 | 150 | 250 | 350 351 |
| Recording system | Hi8 | Hi8 | Hi8 | Digital8 | Digital8 | Digital8 |
| Playback system | Hi8/8 | Hi8/8 | Hi8/8 | Digital8 | Digital8 | Digital8/Hi8/8 |
| AUDIO/VIDEO jack | OUT | OUT | OUT | OUT | OUT | IN/OUT |
| S VIDEO jack | OUT | OUT | OUT | OUT | OUT | IN/OUT |
| DV jack | — | — | — | IN/OUT | IN/OUT | IN/OUT |
| USB jack | — | — | — | — | ● | ● |
| “Memory Stick” slot | — | — | — | — | — | ● |
| LANC jack | — | — | — | — | — | ● |
| SteadyShot | — | ● | ● | ● | ● | ● |
| Remote sensor | — | — | ● | — | ● | ● |
| RFU jack | ● | ● | ● | — | — | — |
| MIC jack | — | — | — | — | — | ● |

- Provided
- Not provided

Before using your camcorder

With your camcorder, you can use the tapes and record/playback on the systems below. To enable smooth transition, we recommend that you do not mix pictures recorded in the Hi8 **Hi8**/standard 8 mm **8** with the Digital8 **8** system on a tape.

350 **351**

| | | |
|--------------------------------|---|---------------------------------------|
| Usable cassette tapes | Hi8 Hi8 /Digital8 8 (recommended) | Standard 8 mm 8 ^{*1)} |
| Recording system | Digital8 8 | |
| Playback system ^{*2)} | Digital8 8 | |
| | Hi8 Hi8 | Standard 8 mm 8 |

150 **250**

| | | |
|-----------------------|---|---------------------------------------|
| Usable cassette tapes | Hi8 Hi8 /Digital8 8 (recommended) | Standard 8 mm 8 ^{*1)} |
| Recording system | Digital8 8 | |
| Playback system | Digital8 8 | |

118 **318** **418**

| | | |
|--------------------------------|-------------------------------|------------------------|
| Usable cassette tapes | Hi8 Hi8 | Standard 8 mm 8 |
| Recording system | Hi8 Hi8 ^{*3)} | Standard 8 mm 8 |
| Playback system ^{*2)} | Hi8 Hi8 | Standard 8 mm 8 |

- ^{*1)} If you use standard 8 mm **8** tape, be sure to play back the tape on your camcorder. Mosaic noise may appear when you play back standard 8 mm **8** tape on other VCRs (including another DCR-TRV150/TRV250/TRV350/TRV351).
- ^{*2)} When you play back a tape, the Hi8 **Hi8** system or standard 8 mm **8** system is automatically detected and the playback system automatically switches to.
- ^{*3)} If you record on a Hi8 **Hi8** video cassette in the LP mode, recording is carried out in the standard 8 mm **8** system.

Note on TV color systems

TV color systems differ from country to country. To view your recordings on a TV, you need an NTSC system-based TV.

Copyright precautions **150** **250** **350** **351**

Television programs, films, video tapes, and other materials may be copyrighted. Unauthorized recording of such materials may be contrary to the provision of the copyright laws.

Using this manual

Note on connecting other equipment

When you connect your camcorder to other video equipment or a computer using the USB cable or i.LINK cable, observe the shape of the jack.

If you forcibly insert the plug, the jack may be damaged and they may result in a malfunction of your camcorder.

On the model name indication

In this manual, camcorder-shape icons are used to indicate model names.

CCD-TRV118 : 

DCR-TRV150 : 

CCD-TRV318 : 

DCR-TRV250 : 

CCD-TRV418 : 

DCR-TRV350 : 

DCR-TRV351 : 

Instructions with no icons are for all models.

Instructions with icons are for the indicated models only.

Before you start reading this manual, check the model name of your camcorder.

On the POWER switch

Modes on the POWER switch vary depending on models.

Consider this when following the operating instructions.

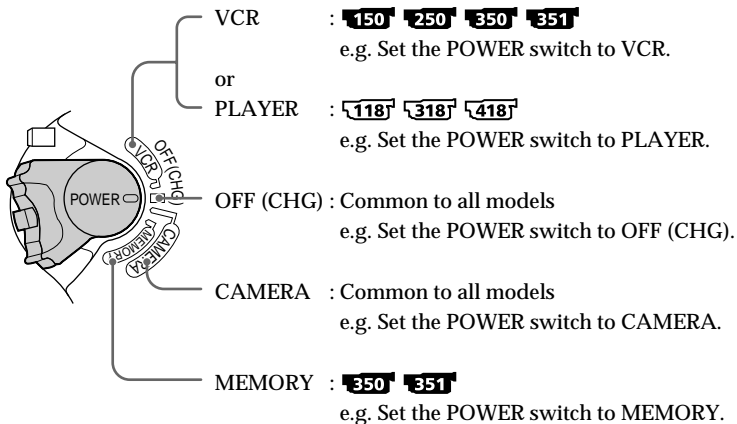

Precautions on camcorder care

Lens and LCD screen/finder

- The LCD screen and the finder are manufactured using extremely high-precision technology so over 99.99% of the pixels are operational for effective use. However, there may be some tiny black points and/or bright points (white, red, blue or green in color) that constantly appear on the LCD screen and the finder. These points are normal in the manufacturing process and do not affect the recording in any way.
- Do not let your camcorder become wet. Keep your camcorder away from rain and sea water. Letting your camcorder become wet may cause your camcorder to malfunction. Sometimes this malfunction cannot be repaired [a].
- Never leave your camcorder exposed to temperatures above 60°C (140°F), such as in a car parked in the sun or under direct sunlight [b].
- Be careful when placing the camera near a window or outdoors. Exposing the LCD screen, the finder or the lens to direct sunlight for long periods may cause malfunctions [c].
- Do not directly shoot the sun. Doing so might cause your camcorder to malfunction. Take pictures of the sun in low light conditions such as dusk [d].

[a]

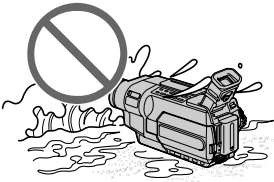

[b]

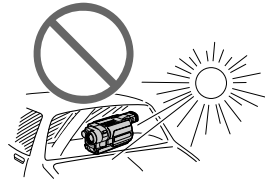

[c]

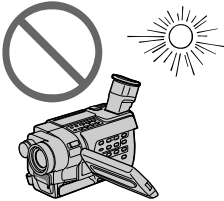

[d]

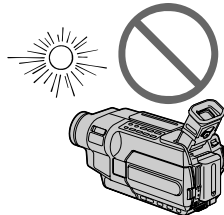

Step 1 Preparing the power supply

Installing the battery pack

- (1) Lift up the viewfinder.
- (2) Slide the battery pack down until it clicks.

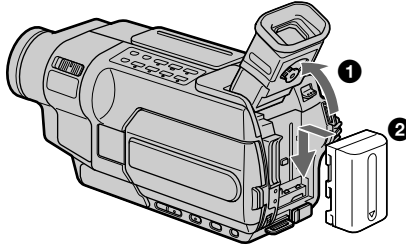

To remove the battery pack

- (1) Lift up the viewfinder.
- (2) Slide the battery pack out in the direction of the arrow while pressing the BATT (battery) release lever down.

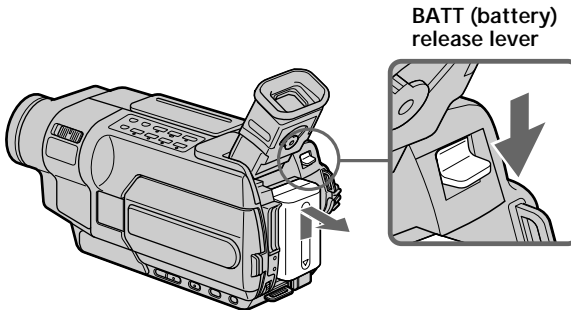

If you install the large-capacity battery pack

If you install the NP-FM70/QM71/QM71D/FM90/FM91/QM91/QM91D battery pack on your camcorder, extend the viewfinder.

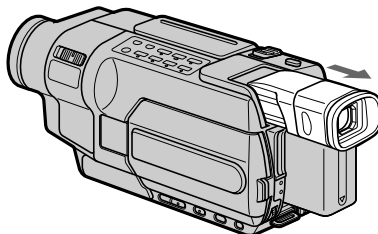

Step 1 Preparing the power supply

Charging the battery pack

Use the battery pack after charging it for your camcorder.
Your camcorder operates only with the "InfoLITHIUM" battery pack (M series).
See page 242 for details of "InfoLITHIUM" battery pack.

- (1) Open the DC IN jack cover and connect the AC Adaptor supplied with your camcorder to the DC IN jack with the plug's ▲ mark facing up.
- (2) Connect the power cord to the AC Adaptor.
- (3) Connect the power cord to a wall outlet.
- (4) Set the POWER switch to OFF (CHG).

The charge lamp lights up when charging begins.

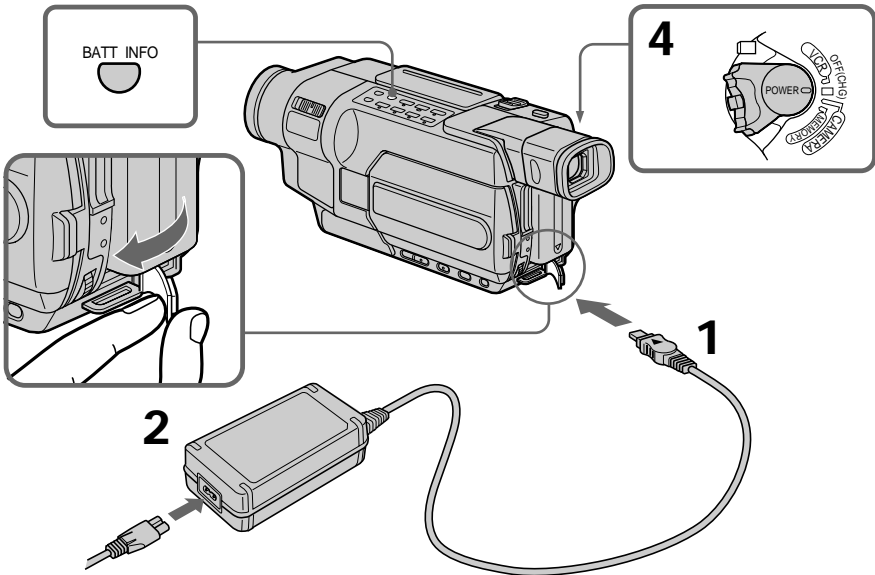

Step 1 Preparing the power supply

To check the state of the battery (BATTERY INFO)

Open the LCD panel while pressing OPEN, then press BATT INFO.

The BATTERY INFO is displayed for about seven seconds.

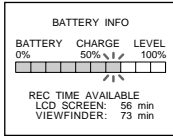

The battery charge level is displayed as percentage and recordable time with the LCD screen/viewfinder.

The battery charge level is displayed in 10% increments.

Charging

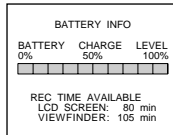

When the battery is fully charged, the battery charge level indicator shows 100% and the charge lamp goes out.

Full charge

After charging the battery pack

Disconnect the AC Adaptor from the DC IN jack on your camcorder.

Until the remaining battery charge is calculated

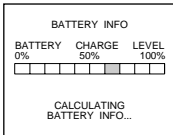

The battery charge level indicator moves flashing and "CALCULATING BATTERY INFO..." is displayed.

Note

Prevent metallic objects from coming into contact with the metal parts on the DC plug of the AC Adaptor. This may cause a short-circuit, damaging the AC Adaptor.

When you use the AC Adaptor

Place the AC Adaptor near a wall outlet. If any trouble occurs with this unit, disconnect the plug from the wall outlet as soon as possible to cut off the power.

The numeric value displayed in the BATTERY INFO

Refer to the value displayed in the BATTERY INFO as a rough standard.

To display the BATTERY INFO longer

Press BATT INFO again while the BATTERY INFO is still displayed. The information is displayed for another seven seconds.

If you keep pressing BATT INFO, the BATTERY INFO is displayed for up to about 20 seconds.

The BATTERY INFO is not displayed in the following cases:

- The POWER switch is not set to OFF (CHG).
- The battery pack is not installed properly.
- The battery pack is fully discharged.

Step 1 Preparing the power supply

If the power goes off although the remaining battery time indicator indicates that the battery pack has enough power to operate

Charge the battery pack fully again so that the indication is correct.

What is "InfoLITHIUM"?

The "InfoLITHIUM" is a lithium ion battery pack that can exchange data such as battery consumption with compatible electronic equipment. This unit is compatible with the "InfoLITHIUM" battery pack (M series). Your camcorder operates only with the "InfoLITHIUM" battery. "InfoLITHIUM" M series battery packs have the

 mark (p. 242).

Charging time

| Battery pack | Full charge |
|--------------------|-------------|
| NP-FM30 (supplied) | 145 |
| NP-FM50 | 150 |
| NP-FM70 | 240 |
| NP-QM71/QM71D | 260 |
| NP-FM90 | 330 |
| NP-FM91/QM91/QM91D | 360 |

Approximate minutes to charge an empty battery pack at 25°C (77°F).

The charging time may increase if the battery's temperature is extremely high or low because of the ambient temperature.

Step 1 Preparing the power supply

Recording time

350 **351**

| Battery pack | Recording with the viewfinder | | Recording with the LCD screen | |
|--------------------|-------------------------------|----------|-------------------------------|----------|
| | Continuous | Typical* | Continuous | Typical* |
| NP-FM30 (supplied) | 105 | 50 | 80 | 40 |
| NP-FM50 | 170 | 85 | 130 | 70 |
| NP-FM70 | 355 | 175 | 270 | 145 |
| NP-QM71/QM71D | 415 | 205 | 315 | 165 |
| NP-FM90 | 540 | 270 | 410 | 215 |
| NP-FM91/QM91/QM91D | 625 | 310 | 475 | 250 |

150 **250**

| Battery pack | Recording with the viewfinder | | Recording with the LCD screen | |
|--------------------|-------------------------------|----------|-------------------------------|----------|
| | Continuous | Typical* | Continuous | Typical* |
| NP-FM30 (supplied) | 115 | 55 | 85 | 40 |
| NP-FM50 | 185 | 90 | 140 | 70 |
| NP-FM70 | 385 | 190 | 295 | 145 |
| NP-QM71/QM71D | 445 | 220 | 340 | 165 |
| NP-FM90 | 580 | 285 | 450 | 220 |
| NP-FM91/QM91/QM91D | 670 | 330 | 520 | 255 |

118 **318** **418**

| Battery pack | Recording with the viewfinder | | Recording with the LCD screen | |
|--------------------|-------------------------------|----------|-------------------------------|----------|
| | Continuous | Typical* | Continuous | Typical* |
| NP-FM30 (supplied) | 165 | 80 | 120 | 60 |
| NP-FM50 | 265 | 130 | 195 | 100 |
| NP-FM70 | 540 | 265 | 400 | 205 |
| NP-QM71/QM71D | 640 | 315 | 465 | 235 |
| NP-FM90 | 820 | 400 | 600 | 305 |
| NP-FM91/QM91/QM91D | 955 | 465 | 695 | 355 |

Approximate minutes when you use a fully charged battery

* Approximate recording time.

The actual battery life may be shorter in the following cases:

- When you repeat recording start/stop, zooming and turning the power on/off.
- When the battery is used repeatedly or self-discharged after charging (p. 242).

Step 1 Preparing the power supply

Playing time

350 **351**

| Battery pack | Playing on the LCD screen | Playing with the LCD closed |
|--------------------|---------------------------|-----------------------------|
| NP-FM30 (supplied) | 80 | 120 |
| NP-FM50 | 135 | 195 |
| NP-FM70 | 285 | 400 |
| NP-QM71/QM71D | 335 | 465 |
| NP-FM90 | 435 | 600 |
| NP-FM91/QM91/QM91D | 505 | 695 |

150 **250**

| Battery pack | Playing on the LCD screen | Playing with the LCD closed |
|--------------------|---------------------------|-----------------------------|
| NP-FM30 (supplied) | 90 | 130 |
| NP-FM50 | 150 | 210 |
| NP-FM70 | 310 | 430 |
| NP-QM71/QM71D | 365 | 505 |
| NP-FM90 | 475 | 655 |
| NP-FM91/QM91/QM91D | 550 | 755 |

118 **318** **418**

| Battery pack | Playing on the LCD screen | Playing with the LCD closed |
|--------------------|---------------------------|-----------------------------|
| NP-FM30 (supplied) | 120 | 175 |
| NP-FM50 | 195 | 280 |
| NP-FM70 | 400 | 570 |
| NP-QM71/QM71D | 465 | 675 |
| NP-FM90 | 600 | 865 |
| NP-FM91/QM91/QM91D | 695 | 1010 |

Approximate minutes when you use a fully charged battery

Step 1 Preparing the power supply

Note

Approximate continuous playing time at 25°C (77°F). The battery life will be shorter if you use your camcorder in a cold environment.

Playback time **350'** **351'**

The table shows the playing time for tapes recorded in the Digital8 **8** system.

The playing time of tapes recorded in the Hi8 **Hi8**/standard 8 mm **8** system is reduced by about 20%.

You can charge the battery in other countries

For details, see page 246.

Recommended charging temperature

We recommend charging the battery pack in an ambient temperature of between 10°C to 30°C (50°F to 86°F).

Connecting to a wall outlet

When you use your camcorder for a long time, we recommend that you power it from a wall outlet using the AC Adaptor.

- (1) Open the DC IN jack cover, and connect the AC Adaptor to the DC IN jack on your camcorder with the plug's ▲ mark facing up.
- (2) Connect the power cord to the AC Adaptor.
- (3) Connect the power cord to a wall outlet.

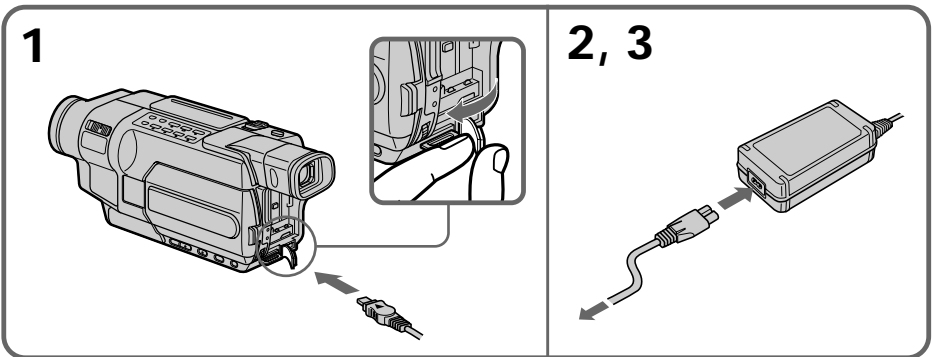

Step 1 Preparing the power supply

PRECAUTION

The set is not disconnected from the AC power source (house current) as long as it is connected to the wall outlet, even if the set itself has been turned off.

Notes

- The AC Adaptor can supply power even if the battery pack is attached to your camcorder.
- The DC IN jack has “source priority.” This means that the battery pack cannot supply any power if the power cord is connected to the DC IN jack, even when the power cord is not plugged into a wall outlet.
- Place the AC Adaptor near a wall outlet.

While using the AC Adaptor, if any trouble occurs with this unit, disconnect the plug from the wall outlet as soon as possible to cut off the power.

Using a car battery

Use Sony Car Battery Adaptor (optional). Refer to the operating instructions of the Car Battery Adaptor for further information.

Step 2 Setting the date and time

Set the date and time when you use your camcorder for the first time. "CLOCK SET" will be displayed each time when you set the POWER switch to CAMERA or MEMORY unless you set the date and time settings.*

If you do not use your camcorder for **about three months**, the date and time settings may be cleared from memory (bars may appear) because the built-in rechargeable battery will have been discharged (p. 249).

Set the date and time after charging the built-in battery fully.

Set the year, then the month, the day, the hour and then the minute.

- (1) Set the POWER switch to CAMERA or MEMORY, and then press MENU to display the menu settings.*
- (2) Turn the SEL/PUSH EXEC dial to select CLOCK SET in , then press the dial.
- (3) Turn the SEL/PUSH EXEC dial to select the desired year, then press the dial.
- (4) Set the month, day and hour by turning the SEL/PUSH EXEC dial and pressing the dial.
- (5) Set the minute by turning the SEL/PUSH EXEC dial and pressing the dial by the time signal. The clock starts.
- (6) Press MENU to make the menu settings disappear.

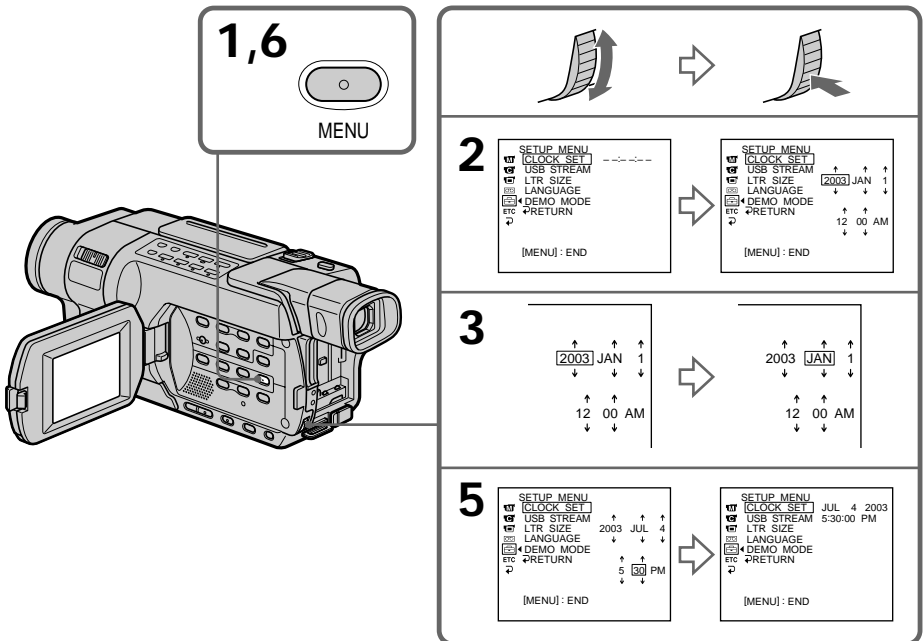

* Modes on the POWER switch vary depending on models (p. 16).

Step 2 Setting the date and time

The year changes as follows:

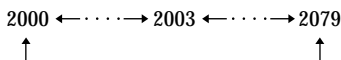

To check the preset date and time **[118]** **[318]** **[418]**

Press DATE to display the date indicator.

Press TIME to display the time indicator.

Press DATE (or TIME) and then press TIME (or DATE) to simultaneously display the date and time indicator.

Press DATE and/or TIME again. The date and/or time indicator disappears.

Auto date function **[118]** **[318]** **[418]**

When you use your camcorder for the first time, turn it on and set the date and time to your local time before you start recording (p. 26). The date is automatically recorded for 10 seconds after you start recording (Auto date function). This function works only once a day.

If you do not set the date and time

"-----" "--:--:--" is recorded on the tape **[250]** **[350]** **[351]** or the "Memory Stick" **[350]** **[351]**.

Note on the time indicator

The internal clock of your camcorder operates on a 12-hour cycle.

- 12:00 AM stands for midnight.
- 12:00 PM stands for noon.

Note on the auto date function **[118]** **[318]** **[418]**

You can change the AUTO DATE setting by selecting ON or OFF in the menu settings.

The auto date function automatically displays the date once a day.

However, the date may automatically appear more than once a day if:

- you set the date and time.
- you eject and insert the tape again.
- you stop recording within 10 seconds.
- you set AUTO DATE to OFF once and set it back to ON in the menu settings.

Step 3 Inserting a cassette

See page 15 for details about the usable cassettes types.

- (1) Prepare the power source (p. 18).
- (2) Slide **OPEN/EJECT** in the direction of the arrow and open the lid.
The cassette compartment automatically lifts up and opens.
- (3) Push the center of the cassette back and insert the cassette properly with the cassette window facing up.
- (4) Close the cassette compartment by pressing **PUSH** on the cassette compartment.
The cassette compartment automatically goes down.
- (5) After the cassette compartment goes down completely, close the lid until it clicks.

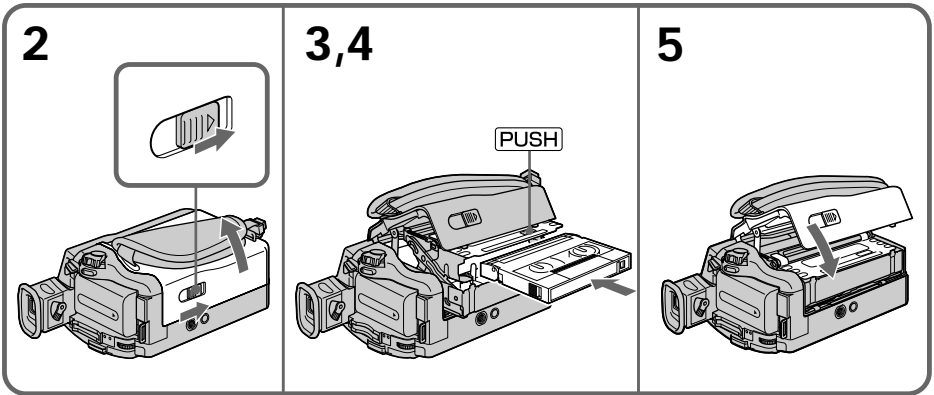

To eject the cassette

Follow the procedure above, and take out the cassette in step (3).

Step 3 Inserting a cassette

Notes

- Do not press the cassette compartment down. Doing so may cause a malfunction.
- The cassette compartment may not be closed when you press any part of the cassette compartment other than the **PUSH** mark.

150 **250** **350** **351**

- Your camcorder records pictures in the Digital8 **8** system.
- The recording time when you use your camcorder is half of the indicated time on Hi8 **Hi8** tape. If you select the LP mode in the menu settings, the recording time is 3/4 of the indicated time on Hi8 **Hi8** tape.
- If you use standard 8 mm **8** tape, be sure to play back the tape on your camcorder. Mosaic noise may appear when you play back standard 8 mm **8** tape on other camcorders (including another DCR-TRV150/TRV250/TRV350/TRV351).

To prevent accidental erasure

Slide the write-protect tab on the cassette to expose the red mark.

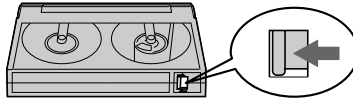

Recording a picture

Your camcorder automatically focuses.

- (1) Remove the lens cap and attach the lens cap to the grip strap.
- (2) Install the power source and insert a cassette. See "Step 1" to "Step 3" for more information (p. 18 to 29).
- (3) Set the POWER switch to CAMERA while pressing the small green button. This sets your camcorder to the standby mode.
- (4) Open the LCD panel while pressing OPEN. The viewfinder automatically turns off.
- (5) Press START/STOP. Your camcorder starts recording. The REC indicator appears on the screen. The camera recording lamp located on the front of your camcorder lights up. To stop recording, press START/STOP again. The recording lamp lights up in the viewfinder when you record with the viewfinder.

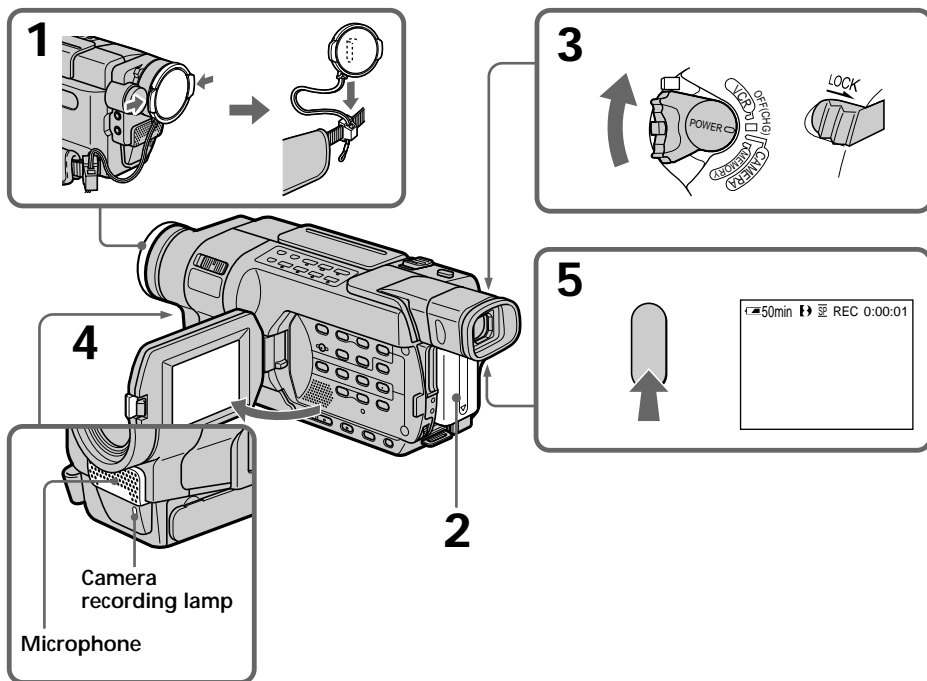

Notes

- The data code (date/time when recorded) are not displayed during recording. However, they are recorded automatically onto the tape. To display the data code (date/time), press DATA CODE on the Remote Commander during playback.

250 350 351

- Fasten the grip strap firmly.
- Do not touch the built-in microphone during recording.

Recording a picture

Note on the LOCK switch **350** **351**

When you slide the LOCK switch to the right, the POWER switch can no longer be set to MEMORY accidentally. The LOCK switch is set to the left as the default setting.

Note on recording mode

Your camcorder records and plays back in the SP (standard play) mode or in the LP (long play) mode. Select SP or LP in the menu settings (p. 219). In the LP mode, you can record **longer** than in SP mode.*¹⁾ When you record a tape in the LP mode on your camcorder, we recommend that you play back the tape on your camcorder.

To enable smooth transition

Transition between the last scene you recorded and the next scene is smooth as long as you do not eject the cassette even if you turn off your camcorder.

However, check the following:

- Do not mix recordings in the SP mode and in the LP mode on one tape.
- When you change the battery pack, set the POWER switch to OFF (CHG).

If you leave your camcorder in the standby mode for a certain period ^{*2)} while the cassette is inserted

Your camcorder automatically turns off. This is to save battery power and to prevent battery and tape wear. To resume the standby mode, set the POWER switch to OFF (CHG) once, then turn it to CAMERA again. However, your camcorder does not turn off automatically while the cassette is not inserted.

To set the counter to 0:00:00 **118** **318** **418**

Press COUNTER RESET (p. 259).

When you record in the SP and LP modes on one tape or you record some scenes in the LP mode

- The time code may not be written properly between scenes. **150** **250** **350** **351**
- The transition between scenes may not be smooth.
- The playback picture may be distorted.

*¹⁾ 1.5 times: **150** **250** **350** **351**

Twice: **118** **318** **418**

*²⁾ three minutes: **150** **250** **350** **351**

five minutes: **118** **318** **418**

Recording a picture

After recording

- (1) Set the POWER switch to OFF (CHG).
- (2) Close the LCD panel.
- (3) Eject the cassette.
- (4) Attach the lens cap.
- (5) Remove the battery pack.

After using your camcorder

Remove the battery pack from your camcorder to avoid turning on the built-in light accidentally.

Adjusting the LCD screen

The LCD panel can be opened up to 90 degrees. The LCD panel moves about 90 degrees to the viewfinder side and about 180 degrees to the lens side (from the initial opening position).

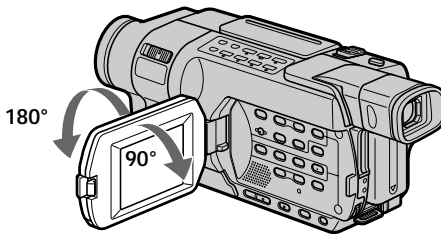

When closing the LCD panel, set it vertically until it clicks, and swing it into the camcorder body.

Note

When using the LCD screen except in the mirror mode, the viewfinder is automatically turned off.

Notes on the LCD screen

- When you use the LCD screen outdoors in direct sunlight, the LCD screen may be difficult to see. If this happens, we recommend that you use the viewfinder.
- When you adjust angles of the LCD panel, make sure if the LCD panel is opened up to 90 degrees.

When recording with the LCD panel opened

Recording time becomes a little shorter compared with when recording with the LCD panel closed.

Adjusting the brightness of the LCD screen

- (1) Set the POWER switch to CAMERA, VCR/PLAYER or MEMORY.*
- (2) Turn the SEL/PUSH EXEC dial to select LCD BRIGHT in  in the menu settings, then press the dial (p. 216).
- (3) Turn the SEL/PUSH EXEC dial to adjust the brightness of the LCD screen with LCD BRIGHT, then press the dial.
- (4) Press MENU to make the menu settings disappear.

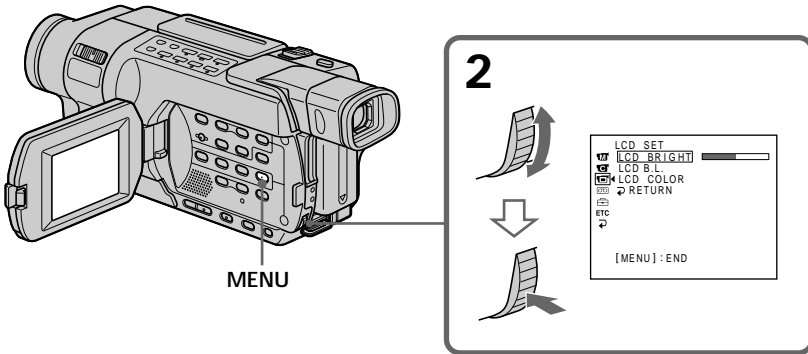

LCD screen backlight

- You can adjust the brightness of the backlight. Select LCD B.L. in the menu settings when using the battery pack (p. 216).
- Even if you adjust the LCD screen backlight, the recorded picture will not be affected.

* Modes on the POWER switch vary depending on models (p. 16).

Recording a picture

Using the zoom feature

Set the POWER switch to CAMERA or MEMORY.*

Move the power zoom lever a little for a slower zoom. Move it further for a faster zoom.

Using the zoom function sparingly results in better-looking recordings.

“T” side: for telephoto (subject appears closer)

“W” side: for wide-angle (subject appears farther away)

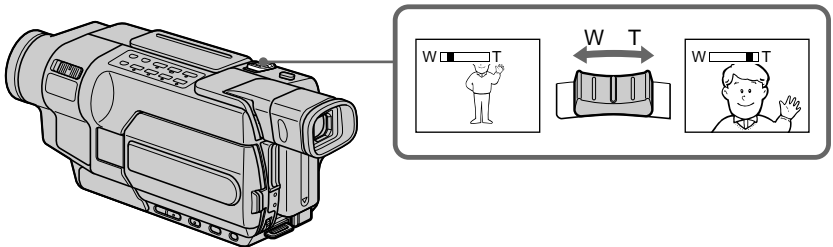

To use zoom greater than 20×

Zoom greater than 20× is performed digitally. To activate digital zoom, select the digital zoom power in D ZOOM in the menu settings. The digital zoom function is set to OFF as a default setting (p. 212).

The right side of the bar shows the digital zooming zone.

The digital zooming zone appears when you select the digital zoom power in the menu settings.

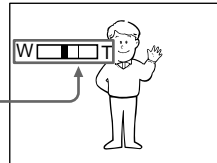

Notes on digital zoom

- Digital zoom power can be set to 40× or 700×. **250** **350** **351**
- Digital zoom power can be set to 40× or 560×. **118** **318** **418** **150**
- The picture quality deteriorates as you move the power zoom lever towards the “T” side.

When you shoot close to a subject

If you cannot get a sharp focus, move the power zoom lever to the “W” side until the focus is sharp. You can shoot a subject that is at least about 80 cm (about 2 feet 5/8 inch) away from the lens surface in the telephoto position, or about 1 cm (about 1/2 inch) away in the wide-angle position.

* Modes on the POWER switch vary depending on models (p. 16).

Recording a picture

Adjusting the viewfinder lens

If you record pictures with the LCD panel closed, check the picture with the viewfinder. Adjust the viewfinder lens to your eyesight so that the indicators in the viewfinder come into sharp focus.

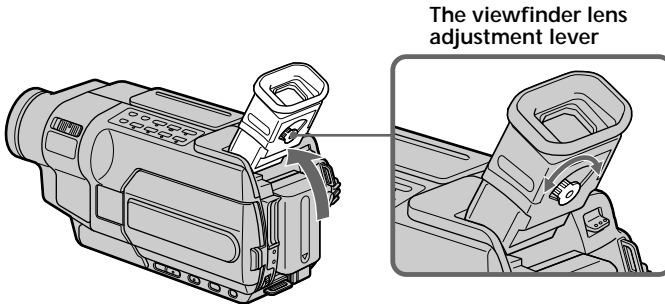

Set the POWER switch to CAMERA, VCR/PLAYER or MEMORY.*
Lift up the viewfinder and move the viewfinder lens adjustment lever.



Shooting with the Mirror Mode

The subject uses this feature to check his or her own image on the LCD screen while you look at the subject in the viewfinder.

Set the POWER switch to CAMERA or MEMORY, and rotate the LCD screen 180 degrees.*

The ☺ indicator appears in the viewfinder and on the LCD screen.

||● appears in the standby mode, and ● appears in the recording mode. Some of other indicators appear mirror-reversed and others are not displayed.

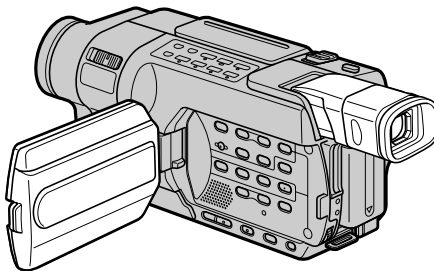

* Modes on the POWER switch vary depending on models (p. 16).

Recording a picture

Pictures in the mirror mode

The picture on the LCD screen is a mirror-image. However, the picture will be normal when recorded.

During recording in the mirror mode **118** **318** **418**

DATE and TIME on your camcorder do not work.

Indicators displayed in the recording mode

The indicators are not recorded on the tape.

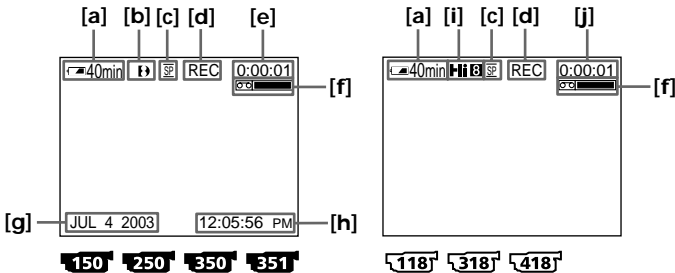

[a] : Remaining battery time indicator

[b] : Format indicator

[c] : Mirror mode indicator **118** **318** **418**/
Recording mode indicator

[d] : STBY/REC indicator

[e] : Tape photo recording indicator **150** **250**/
Time code indicator

[f] : Remaining tape indicator

This appears after you set the POWER switch to CAMERA and insert a cassette for a while. **150** **250** **350** **351**

This appears after you insert a cassette and record or play back for a while.

118 **318** **418**

[g] : Date indicator

This is displayed for five seconds after the POWER switch is set to CAMERA or MEMORY.*

[h] : Time indicator

This is displayed for five seconds after the POWER switch is set to CAMERA or MEMORY.*

[i] : Hi8 format indicator

This appears while playing back or recording Hi8 format tapes.

[j] : Tape counter indicator



* Modes on the POWER switch vary depending on models (p. 16).

Remaining battery time indicator

The remaining battery time indicator indicates the approximate recording time. The indicator may not be correct, depending on the conditions in which you are recording. When you close the LCD panel and open it again, it takes about one minute for the correct remaining battery time in minutes to be displayed.

Time code (for tapes recorded in the Digital8 system only)

- When you play back tapes recorded in the Hi8 Hi8/standard 8 mm  system, the tape counter appears on the screen.  
- The time code indicates the recording or playback time, “0:00:00” (hours:minutes:seconds) in CAMERA mode and “0:00:00:00” (hours:minutes:seconds:frames) in VCR mode. You cannot rewrite only the time code. You cannot reset the time code or the tape counter.

Data code

The data code (date/time or various settings when recorded) are not displayed while recording. However, they are recorded automatically onto tape. To display the data code, press DATA CODE on the Remote Commander during playback (p. 47).

Shooting a backlit subject – BACK LIGHT

When you shoot a subject with the light source behind the subject or a subject with a light background, use the backlight function.

Set the POWER switch to CAMERA or MEMORY, and press BACK LIGHT.*

The  indicator appears on the screen.

To cancel the backlight function, press BACK LIGHT again.

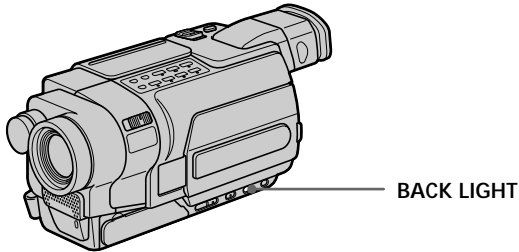

If you press EXPOSURE when shooting backlit subjects

The backlight function will be canceled.

* Modes on the POWER switch vary depending on models (p. 16).

Shooting in the dark – NightShot

– Super NightShot **350** **351**

– Color Slow Shutter **350** **351**

The NightShot function enables you to shoot a subject in a dark place. For example, you can satisfactorily record the environment of nocturnal animals for observation when you use this function.

Using NightShot

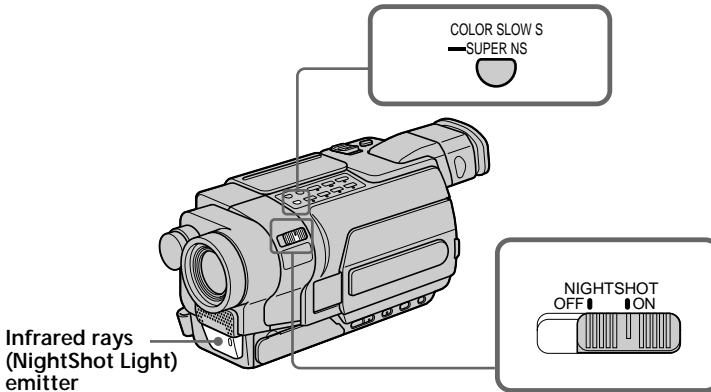

Set the POWER switch to CAMERA or MEMORY, and slide NIGHTSHOT to ON.* The  indicator and “NIGHTSHOT” flash on the screen.

To cancel the NightShot function, slide NIGHTSHOT to OFF.



Using the Super NightShot **350** **351**

The Super NightShot function makes subjects up to 16 times brighter than those recorded in the NightShot mode.

- (1) Set the POWER switch to CAMERA, and slide NIGHTSHOT to ON. The  indicator and “NIGHTSHOT” flash on the screen.
- (2) Press SUPER NS. The  indicator and “SUPER NIGHTSHOT” flash on the screen.

To cancel the Super NightShot function, press SUPER NS again. Your camcorder returns to the NightShot mode.

Using the NightShot Light

The picture will be clearer with the NightShot Light on. To enable NightShot Light, set N.S.LIGHT to ON in the menu settings. (The default setting is ON.) (p. 213)

* Modes on the POWER switch vary depending on models (p. 16).

Recording a picture

Using Color Slow Shutter **350** **351**

The Color Slow Shutter function enables you to record color images in a dark place.

- (1) Set the POWER switch to CAMERA, and slide NIGHTSHOT to OFF.
- (2) Press COLOR SLOW S.

The **Q** indicator and COLOR SLOW SHUTTER flash on the screen.

To cancel the Color Slow Shutter function, press COLOR SLOW S again.

Notes

- Do not use the NightShot function in bright places (e.g. outdoors in the daytime). This may cause your camcorder to malfunction.
- When you keep NIGHTSHOT set to ON in normal recording, the picture may be recorded in incorrect or unnatural colors.
- If focusing is difficult with the autofocus mode when using the NightShot function, focus manually.

While using the NightShot function, you cannot use the following functions:

- Exposure
- PROGRAM AE

While using the Super NightShot or Color Slow Shutter function, you cannot use the following functions **350** **351** :

- Fader
- Digital effect
- Exposure
- PROGRAM AE

While using the Super NightShot or Color Slow Shutter function **350** **351**

The shutter speed is automatically adjusted depending on the brightness. The motion of the picture will be slow.

NightShot Light

NightShot Light rays are infrared and so are invisible. The maximum shooting distance using the NightShot Light is about 3 m (10 feet).



While recording, be sure not to cover the infrared rays emitter with your fingers, etc.

In total darkness **350** **351**

The Color Slow Shutter function may not work normally.

Self-timer recording **350** **351**

Recording with the self-timer starts in 10 seconds automatically. You can also use the Remote Commander for this operation.

- (1) In the standby mode, press MENU to display the menu settings.
- (2) Turn the SEL/PUSH EXEC dial to select SELFTIMER in , then press the dial.
- (3) Turn the SEL/PUSH EXEC dial to select ON, then press the dial.
- (4) Press MENU to make the menu settings disappear.
The  (self-timer) indicator appears on the screen.
- (5) Press START/STOP.

Self-timer starts counting down from 10 with a beep. In the last two seconds of the countdown, the beep gets faster, then recording starts automatically.

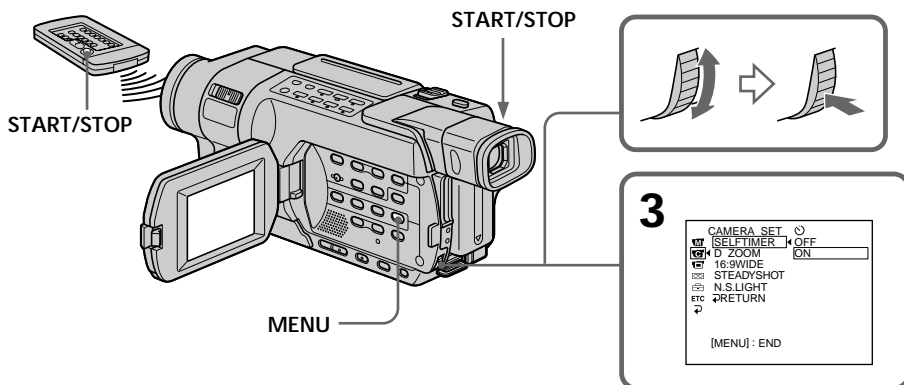

To stop the countdown

Press START/STOP.

To restart the countdown, press START/STOP again.

To cancel self-timer recording

Set SELFTIMER to OFF in the menu settings in the standby mode.

You cannot cancel self-timer using the Remote Commander.

Note

The self-timer is automatically canceled when:

- Self-timer recording is finished.
- The POWER switch is set to OFF (CHG) or VCR.

When the POWER switch is set to MEMORY

You can also record still images on a "Memory Stick" with the self-timer (p. 135).

Recording a picture

Superimposing the date and time on pictures

You can record the date and/or time displayed on the screen superimposed on the picture.

Carry out the following operations in CAMERA mode.

Press DATE to record the date.

Press TIME to record the time.

Press DATE (or TIME), then press TIME (or DATE) to record the date and time.

Press DATE and/or TIME again. The date and/or time indicator disappears.

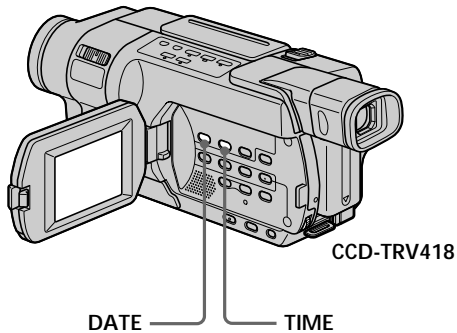

When you purchase your camcorder, the clock is not set up yet. Set the date and time to your local time before using (p. 26).

Note

The date and time indicators recorded manually cannot be deleted.

If you do not record the date and time in the picture

Record the date and time in the black screen as the background for about 10 seconds, then erase the date and time indicators before starting actual recording.

Checking recordings – END SEARCH

– EDITSEARCH

– Rec Review

You can use these buttons to check the recorded picture for making the transition between the last recorded scene and the next scene you record smooth.

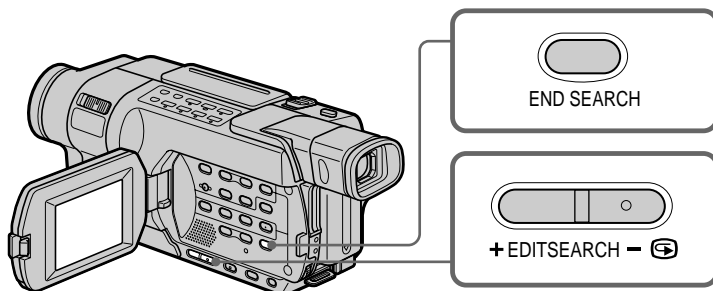

END SEARCH

You can go to the end of the recorded section after you record.

In the standby mode, press END SEARCH.

The last five seconds of the recorded section are played back and your camcorder returns to the standby mode. You can monitor the sound from the speaker.

EDITSEARCH

You can search for the next recording start point.

In the standby mode, hold down the either side of EDITSEARCH. The recorded portion is played back.

+ : To go forward

-  : To go backward

Release EDITSEARCH to stop playback. If you press START/STOP, re-recording begins from the point you released EDITSEARCH. You cannot monitor the sound.

Rec Review

You can check the last recorded section.

In the standby mode, press the -  side of EDITSEARCH momentarily.

The section you have stopped most recently will be played back for a few seconds, and then your camcorder will return to the standby mode. You can monitor the sound from the speaker.

Checking recordings – END SEARCH

- EDITSEARCH **350** **351**
 - Rec Review **350** **351**
-

Notes

- The end search, edit search and Rec Review functions do not work with tapes recorded in the Hi8 **Hi8**/standard 8 mm **8** system. **350** **351**
- If you start recording after using the end search function, occasionally, the transition between the last scene you recorded and the next scene may not be smooth.
- Once you eject the cassette after you have recorded on the tape, the end search function does not work.

If a tape has a blank portion between recorded portions

The end search function may not work correctly.

Playing back a tape

You can monitor the playback picture on the LCD screen. If you close the LCD panel, you can monitor the playback picture in the viewfinder.

418 250 350 351

You can control playback using the Remote Commander supplied with your camcorder.

- (1) Install the power source and insert the recorded tape.
- (2) Set the POWER switch to VCR/PLAYER while pressing the small green button.*
- (3) Open the LCD panel while pressing OPEN.
- (4) Press ◀◀ to rewind the tape.
- (5) Press ▶▶ to start playback.
- (6) To adjust the volume, press either of the two buttons on VOLUME. When you close the LCD panel, sound is muted.
- : To turn the volume down
+ : To turn the volume up

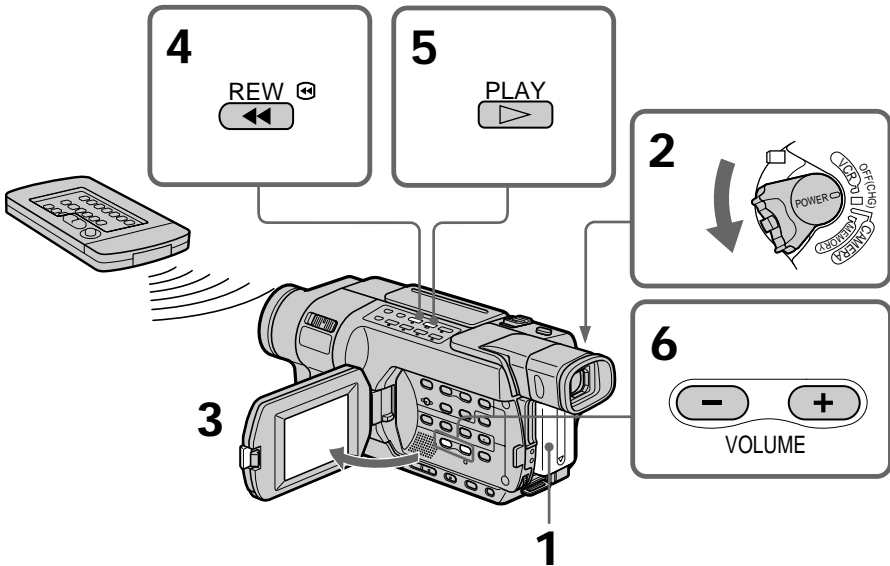

To stop playback

Press ■.







* Modes on the POWER switch vary depending on models (p. 16).

Playing back a tape

If you leave the power on for a long time

Your camcorder gets warm. This is not a malfunction.

Tapes that can be played back

- Tapes recorded in the Digital8  system    
- Tapes recorded in the Hi8 /standard 8 mm  system

When monitoring on the LCD screen

You can turn the LCD panel over and move it back to the camcorder body with the LCD screen facing out.

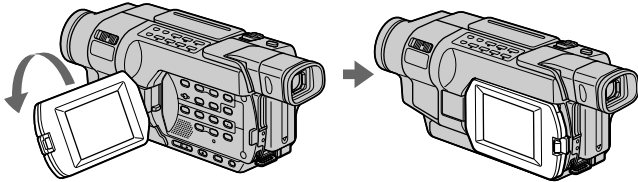

When you open or close the LCD panel

Make sure that the LCD panel is set vertically.

Playing back a tape

To display the screen indicators – Display function

Press DISPLAY on the Remote Commander. **418** **250** **350** **351**
Press DISPLAY on your camcorder.
The indicators appear on the screen.
To make the indicators disappear, press DISPLAY again.

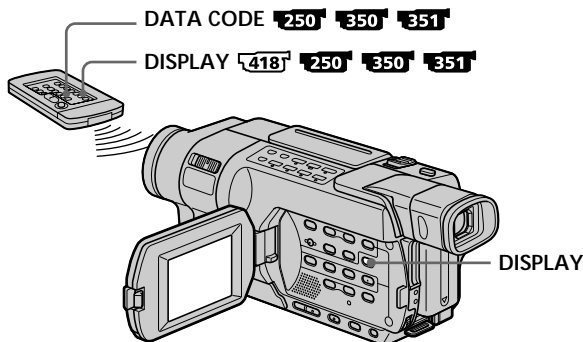

About data code **250** **350** **351**

Use the Remote Commander for this operation.
Your camcorder automatically records not only pictures on the tape but also the data code (date/time or various settings when recorded).

- ① Set the POWER switch to VCR, then play back a tape.
- ② Press DATA CODE on the Remote Commander.

The display changes as follows:

date/time → various settings → no indicator

Date/time

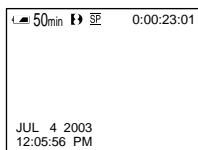

Various settings

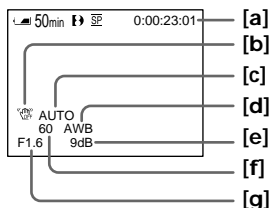

- [a]: Time code/Tape counter
- [b]: SteadyShot off
- [c]: Exposure mode
- [d]: White balance
- [e]: Gain
- [f]: Shutter speed
- [g]: Aperture value

Playing back a tape

To not display various settings

Set DATA CODE to DATE in the menu settings (p. 222).

The display changes as follows when you press DATA CODE on the Remote Commander:

date/time ↔ no indicator

Notes on the data code **250** **350** **351**

- The data code does not work with tapes recorded in the Hi8 **Hi8**/standard 8 mm **8** system.
- Various settings of the data code are not recorded when recording images on a "Memory Stick."

Data code (Various settings) **250** **350** **351**

The data code is your camcorder's information at the time of recording. In the recording mode, the data code will not be displayed.

When you use data code, bars (-- --) appear if **250** **350** **351** :

- A blank portion of the tape is being played back.
- The tape is unreadable due to tape damage or noise.
- The tape was recorded by a camcorder without the date and time set.

Data code **250** **350** **351**

When you connect your camcorder to a TV, the data code appears on the TV screen.

Remaining battery time indicator during playback **150** **250** **350** **351**

The indicator indicates the approximate continuous playback time. The indicator may not be correct, depending on the conditions in which you are playing back. When you close the LCD panel and open it again, it takes about one minute for the correct remaining battery time to be displayed.

Playing back a tape

Various playback modes

To operate the video control buttons, set the POWER switch to VCR/PLAYER.*

To pause playback (viewing a still image)

Press **II** during playback. To resume normal playback, press **II** or **▶**.

To advance the tape

Press **▶▶** in the stop mode. To resume normal playback, press **▶**.

To rewind the tape

Press **◀◀** in the stop mode. To resume normal playback, press **▶**.

To change the playback direction **250** **350** **351**

Press **<** on the Remote Commander during playback to reverse the playback direction. To resume normal playback, press **▶**.

To locate a scene monitoring the picture (picture search)

Keep pressing **◀◀** or **▶▶** during playback. To resume normal playback, release the button.

To monitor high-speed pictures while advancing or rewinding the tape (skip scan)

Keep pressing **◀◀** while rewinding or **▶▶** while advancing the tape. To resume rewinding or advancing, release the button.

To view pictures at slow speed (slow playback)

418 **250** **350** **351**

Press **▶** on the Remote Commander during playback. To resume normal playback, press **▶**.

To change the slow playback direction **250** **350** **351**

Press **<**, then press **▶** on the Remote Commander.

To view pictures at double speed **250** **350** **351**

Press **×2** on the Remote Commander during playback. For double speed playback in the reverse direction, press **<**, then press **×2** on the Remote Commander. To resume normal playback, press **▶**.

To view pictures frame-by-frame **250** **350** **351**

Press **II▶** on the Remote Commander in the playback pause mode. For frame-by-frame playback in the reverse direction, press **◀II**. To resume normal playback, press **▶**.

To search the last scene recorded (END SEARCH)

Press **END SEARCH** in the stop mode. The last five seconds of the recorded section are played back and playback stops.

* Modes on the POWER switch vary depending on models (p. 16).

Playing back a tape

In the various playback modes

- The previous recording may appear as a mosaic image when playing back in the Digital8 **F** system. **150** **250** **350** **351**
- Noise may appear when your camcorder plays back tapes recorded in the Hi8 **H**/standard 8 mm **8** system.
- Sound is muted.

When the playback pause mode lasts for a certain period *

Your camcorder automatically stops. To resume playback, press **▶**.

Note on the slow playback mode in Digital8 **F** system **250** **350** **351**

The slow playback can be performed smoothly on your camcorder, however, this function does not work for an output image from the **i** DV jack.

If slow playback lasts for about one minute **418**

Your camcorder automatically returns to normal speed playback.

When you play back a tape recorded in the LP mode **118** **318** **418**

Noise may appear on the LCD screen in the following cases:

- slow playback **418**
- playback pause
- picture search

* three minutes: **150** **250** **350** **351**

five minutes: **118** **318** **418**

Viewing recordings on TV

Connect your camcorder to your TV with the A/V connecting cable supplied with your camcorder to watch playback pictures on the TV screen. You can operate the video control buttons in the same way as when you monitor playback pictures on the LCD screen. When monitoring playback pictures on the TV screen, we recommend that you power your camcorder from a wall outlet using the AC Adaptor (p. 24). Refer to the operating instructions of your TV.

Open the jack cover. Connect your camcorder to the TV using the A/V connecting cable supplied with your camcorder. Then, set the TV/VCR selector on the TV to VCR.

150 250 350 351

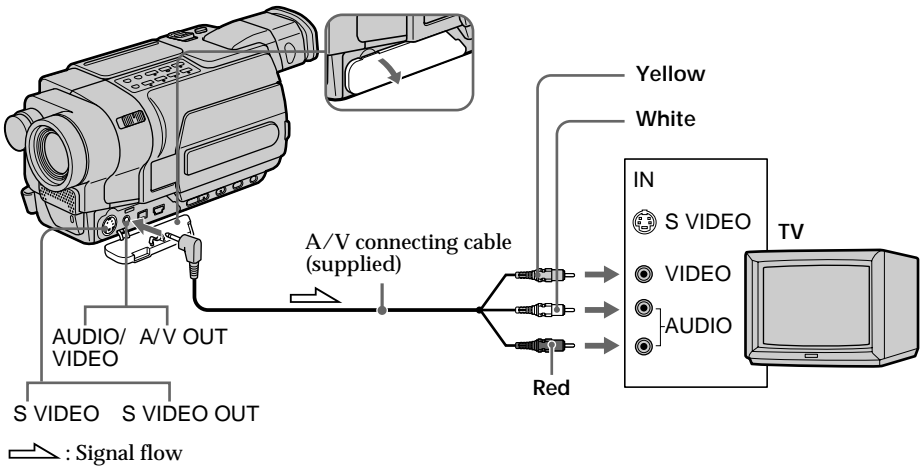

118 318 418

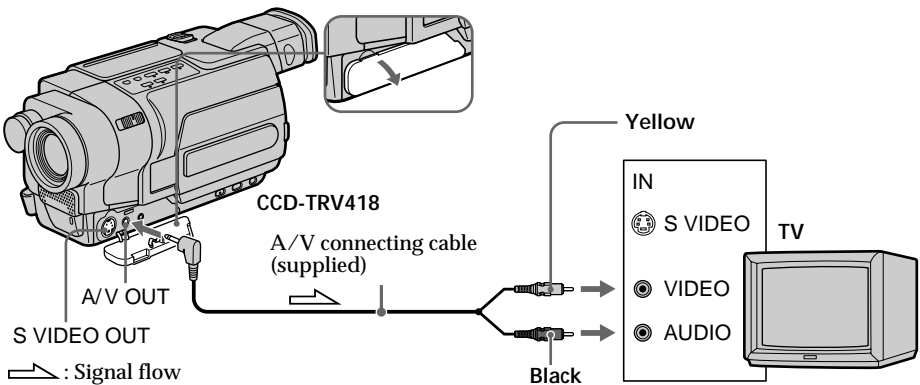

Viewing recordings on TV

If your TV is already connected to a VCR

Connect your camcorder to the LINE IN input on the VCR by using the A/V connecting cable supplied with your camcorder. Set the input selector on the VCR to LINE.

If your TV or VCR is a monaural type

Connect the yellow plug of the A/V connecting cable to the video input jack and the white or the red plug to the audio input jack on the VCR or the TV. When the white plug is connected, the left channel audio is output, and when the red plug is connected, the right channel audio is output.

To connect to a TV without Video/Audio input jacks

Use an NTSC system RFU adaptor (optional).
Refer to the operating instructions of your TV and the RFU adaptor.

If your TV is a stereo type

Connect the audio plug of the A/V connecting cable supplied to the left (white) input jack of your TV.

Note

Noise appears on the TV screen in the various playback modes.

If your TV has an S video jack

Pictures can be reproduced more faithfully by using an S video cable (optional). With this connection, you do not need to connect the yellow (video) plug of the A/V connecting cable. Connect the S video cable (optional) to the S video jacks on both your camcorder and the TV.

To display the screen indicators on TV

Set DISPLAY to V-OUT/LCD in the menu settings (p. 222).
Then, press DISPLAY on your camcorder. To turn the screen indicators off, press DISPLAY on your camcorder again.

Recording still images on a “Memory Stick” while recording on a tape

350 351

You can record still images on a “Memory Stick” in the tape recording or standby mode.

Before operation

Insert a “Memory Stick” into your camcorder (p. 127).

In the standby mode or during tape recording, press PHOTO deeper.

Recording is complete when the bar scroll indicator disappears.

The still image when you pressed PHOTO deeper will be recorded on the “Memory Stick.”

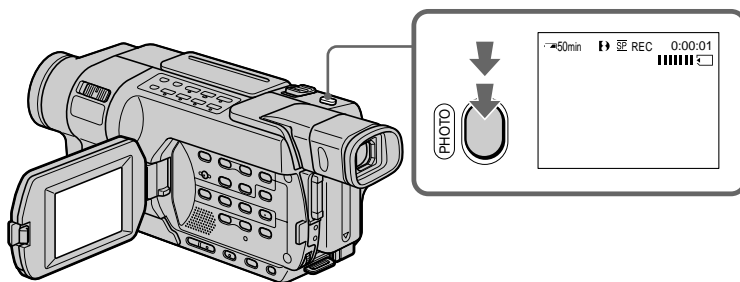

In the standby mode

You can check an image on the screen by pressing PHOTO lightly. The CAPTURE indicator appears. Recording does not start yet. To change the still image, release PHOTO, select a still image again, and then press and hold PHOTO lightly.

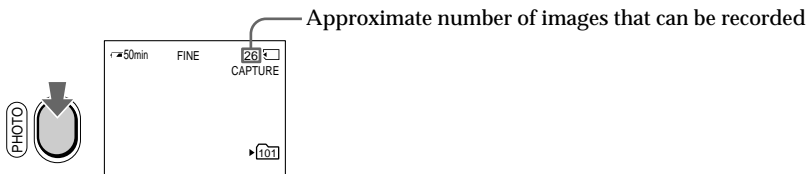

In the recording mode

You cannot check an image on the screen by pressing PHOTO lightly.

Recording still images on a “Memory Stick” while recording on a tape

“Memory Stick”

For more information, see page 240.

Notes

- Do not shake or strike your camcorder when you record still images. The image may fluctuate.
- You cannot record still images on a “Memory Stick” in the following functions (The  indicator flashes):
 - Wide mode
 - BOUNCE
 - MEMORY MIX
 - END SEARCH

The following settings cannot be changed

The settings you selected when the POWER switch was set to MEMORY are used:

- Image quality (p. 128)
- Recording folder (p. 162)

To record still images using the Remote Commander

Press PHOTO on the Remote Commander. Your camcorder immediately records the image on the screen.

During and after recording still images on a “Memory Stick”

Your camcorder continues recording on tape.

Title

The title cannot be recorded.

While recording still images on a “Memory Stick” in CAMERA mode

The image is recorded in the FIELD mode automatically even if you select FRAME in the menu settings.



Recording still images on a “Memory Stick” while recording on a tape

Self-timer recording

You can record still images on a “Memory Stick” with the self-timer. You can also use the Remote Commander for this operation.

Before operation

Insert a “Memory Stick” into your camcorder (p. 127).

- (1) In the standby mode, press MENU to display the menu settings.
- (2) Turn the SEL/PUSH EXEC dial to select SELFTIMER in , then press the dial.
- (3) Turn the SEL/PUSH EXEC dial to select ON, then press the dial.
- (4) Press MENU to make the menu settings disappear. The  (self-timer) indicator appears on the screen.
- (5) Press PHOTO deeper.

Self-timer starts counting down from 10 with a beep. In the last two seconds of the countdown, the beep gets faster, then recording starts automatically.

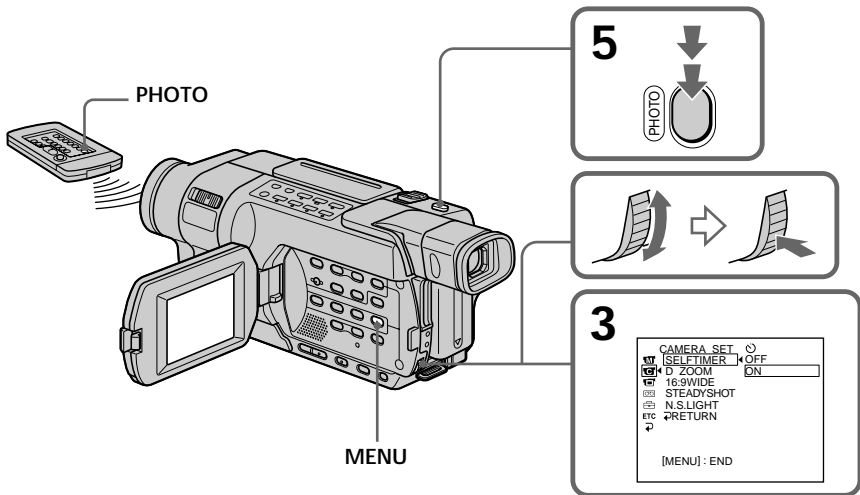

To cancel self-timer

Set SELFTIMER to OFF in the menu settings in the standby mode. You cannot cancel self-timer using the Remote Commander.

Note

- The self-timer is automatically canceled when:
- self-timer recording is finished.
 - the POWER switch is set to OFF (CHG) or VCR.

Taking photos with the self-timer

The self-timer can only be operated when in the standby mode.

Recording still images on a tape

- Tape Photo recording

150 250

You can record a still image like a photograph.

You can record about 510 images in the SP mode and about 765 images in the LP mode on a tape which can record for 60 minutes in the SP mode.

In the standby mode or during tape recording, press PHOTO deeper.

The still image on the screen is recorded for about seven seconds. The sound during those seven seconds is also recorded.

The still image is displayed on the screen until recording is completed.

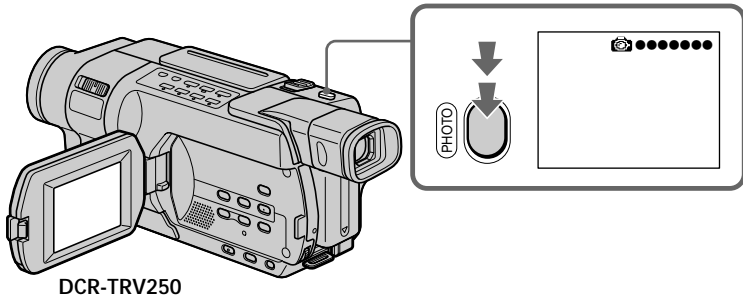

In the standby mode

You can check an image on the screen by pressing PHOTO lightly. The CAPTURE indicator appears. Recording does not start yet. To change the still image, release PHOTO, select a still image again, and then press and hold PHOTO lightly.

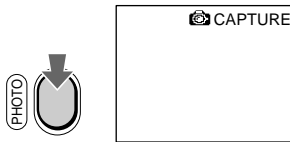

Recording still images on a tape – Tape Photo recording

Notes

- During Tape Photo recording, you cannot change the mode or setting.
- You cannot use PHOTO while using BOUNCE in the Fader function.
- When recording a still image, do not shake your camcorder. The image may fluctuate.
- The tape photo recording does not work while using Fader (The  indicator flashes).

If you record a moving subject with the tape photo recording function

The image may fluctuate when you play back the still image on other equipment. This is not a malfunction.

To use the tape photo recording function using the Remote Commander **250**

Press PHOTO on the Remote Commander. Your camcorder records an image on the screen immediately.

Using the wide mode

If you connect a TV compatible with the ID-1/ID-2 system, the screen size is automatically selected.

150 **250** **350** **351**

You can record a 16:9 wide picture to watch on the 16:9 wide-screen TV (16:9WIDE).

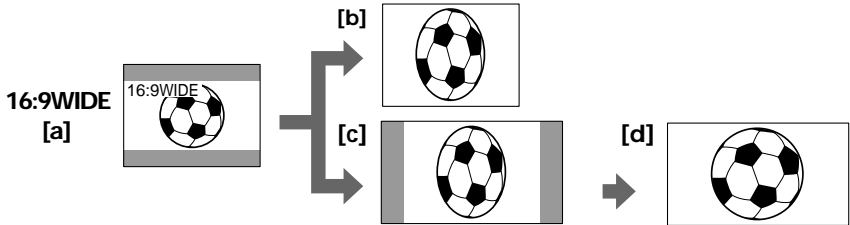

[a]: Recording in the 16:9WIDE mode

[b]: Playback on a normal TV

[c]: Playback on a wide TV in the normal screen mode

[d]: Full screen mode on a wide TV

In the standby mode, set 16:9WIDE to ON in  in the menu settings (p. 212).

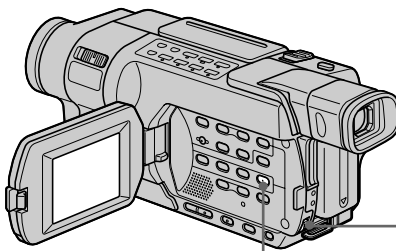

MENU

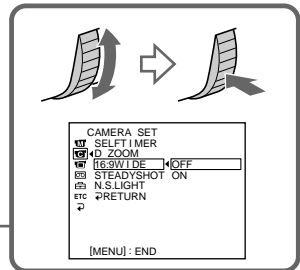

Using the wide mode

118 318 418

You can record a cinema-like picture (CINEMA) or a 16:9 wide picture (16:9FULL) to watch on the 16:9 wide-screen TV. Refer to the operating instructions of your TV.

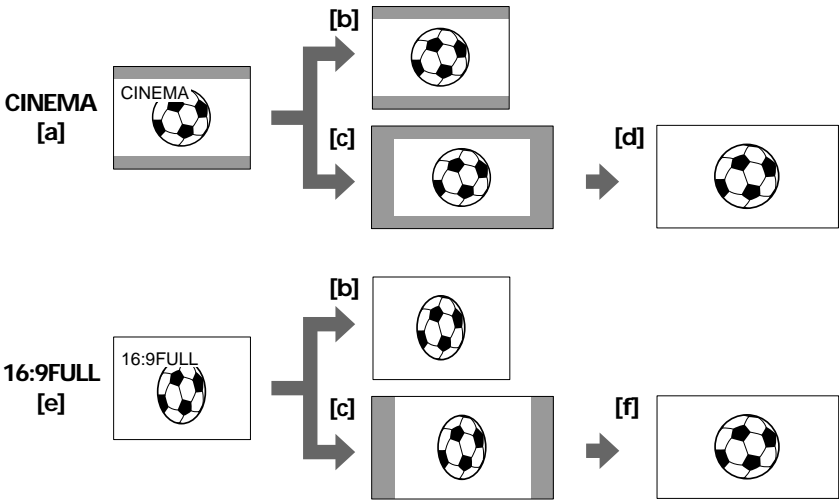

Advanced Recording Operations

- [a]: Recording in the CINEMA mode
- [b]: Playback on a normal TV
- [c]: Playback on a wide TV in the normal screen mode
- [d]: Zoom mode on a wide TV
- [e]: Recording in the 16:9FULL mode
- [f]: Full mode on a wide TV

In the standby mode, set 16:9WIDE to CINEMA or 16:9FULL in  in the menu settings (p. 212).

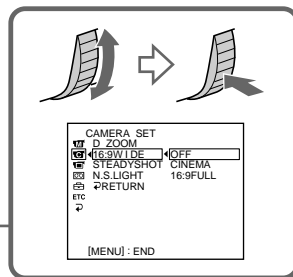
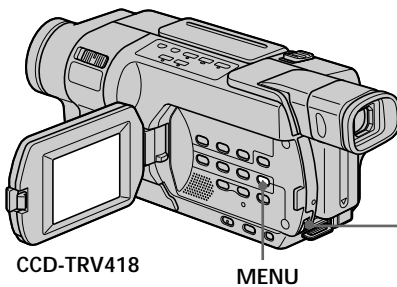

Using the wide mode

To cancel the wide mode

In the standby mode, set the wide mode to OFF in the menu settings.

In the wide mode

You cannot operate the following functions:

- OLD MOVIE **350** **351** (p. 65)
- Recording still images on a "Memory Stick" in tape recording or tape recording standby **350** **351**
- BOUNCE (p. 61)

Connection for a TV **150** **250** **350** **351**

Pictures recorded in the 16:9WIDE mode automatically appear on the TV screen at full size when:

- You connect your camcorder to a TV that is compatible with the video ID (ID-1/ID-2) system.
- You connect your camcorder to the S video jack on the TV.

ID-1 system

The ID-1 system sends aspect ratio (screen horizontal/vertical ratio) information (16:9, 4:3, or letter box) with video signals.

ID-2 system **150** **250** **350** **351**

The ID-2 system sends a copyright protection signal with ID-1 signals inserted between video signals when you connect your camcorder to other equipment by an A/V connecting cable.

In the wide mode

The SteadyShot does not work. If you set the wide mode described below in the menu settings when the SteadyShot is working, the  indicator flashes and the SteadyShot does not function:

- 16:9WIDE to ON **150** **250** **350** **351**
- 16:9WIDE to 16:9FULL **318** **418**

Date or time indicator **118** **318** **418**

When you record in the 16:9FULL mode, the date or time indicator will be widened on wide-screen TVs.

Using the fader function

You can fade in or out to give your recording a professional appearance.

[a] STBY REC

FADER

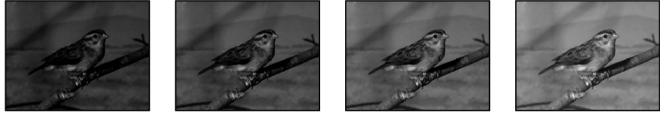

M.FADER
(mosaic)



STRIPE

118 318
418



BOUNCE *1) *2)



OVERLAP *2)

350 351



WIPE *2)

350 351

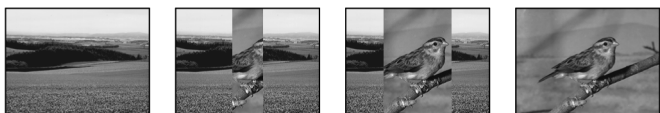

DOT *2)
(random dot)

350 351

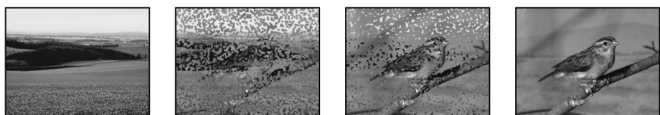

[b] STBY REC

MONOTONE

When fading in, the picture gradually changes from black-and-white to color.
When fading out, the picture gradually changes from color to black-and-white.

*1) You can use BOUNCE when D ZOOM is set to OFF in the menu setting.

*2) Fade in only

Using the fader function

(1) To fade in [a]

In the standby mode, press FADER until the desired fader indicator flashes.

To fade out [b]

In the recording mode, press FADER until the desired fader indicator flashes.

The indicator changes as follows:

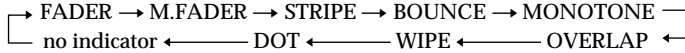

The last selected fader mode is indicated first of all.

(2) Press START/STOP. The fader indicator stops flashing.

After fade in/out ends, your camcorder automatically returns to the normal mode.

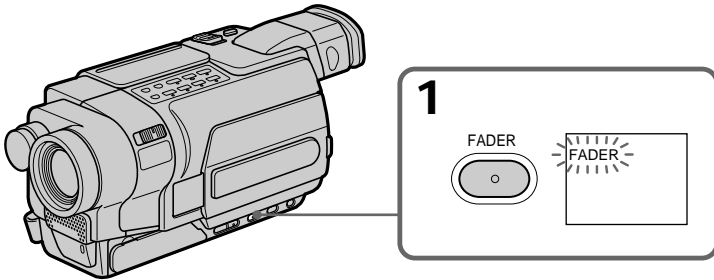

To cancel the fader function

Before pressing START/STOP, press FADER repeatedly until the indicator disappears.

Notes **150** **250** **350** **351**

- The OVERLAP, WIPE and DOT functions do not work with tapes recorded in the Hi8 **Hi8**/standard 8 mm **8** system. **350** **351**
- You cannot use the following functions while using the fader function. Also, you cannot use the fader function while using the following functions:
 - Digital effect **350** **351**
 - Color Slow Shutter **350** **351**
 - Super NightShot **350** **351**
 - Tape Photo recording **150** **250**
 - Interval recording
 - Frame recording

Using the fader function

When you set the POWER switch to MEMORY **350** **351**

You cannot use the fader function.

When you select OVERLAP, WIPE, or DOT **350** **351**

Your camcorder automatically stores the picture recorded on the tape. While the picture is being stored, the indicator flashes fast, and the picture from the tape appears on the screen. At this stage, the picture may not be recorded clearly, depending on the tape condition.

The date, time indicator **118** **318** **418** and title do not fade in or fade out

Erase them before operating the fader function if they are not needed.

While using the bounce mode, you cannot use the following functions:

- Recording on a "Memory Stick" **350** **351**
- Exposure **150** **250** **350** **351**
- Focus
- Zoom
- Picture effect
- PROGRAM AE
- BACK LIGHT

Note on the bounce mode

The BOUNCE indicator does not appear in the following functions:

- When D ZOOM is set to 40× or 700×. **250** **350** **351**
- When D ZOOM is set to 40× or 560×. **118** **318** **418** **150**
- Wide mode
- Picture effect
- PROGRAM AE

Using special effects – Picture effect

You can digitally process pictures to obtain special effects like those in films or on TV.

- NEG. ART [a]** : The color and brightness of the picture are reversed.
SEPIA : The picture appears in sepia.
B&W : The picture appears in monochrome (black-and-white).
SOLARIZE [b] : The picture appears as an illustration with strong contrast.
SLIM [c] : The picture expands vertically.
STRETCH [d] : The picture expands horizontally.
PASTEL [e] : The picture appears as a pale pastel drawing.
MOSAIC [f] : The picture appears mosaic.

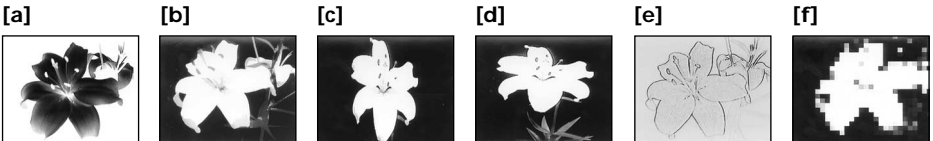

- (1) In CAMERA mode, press MENU to display the menu settings.
- (2) Turn the SEL/PUSH EXEC dial to select P EFFECT in **[M]**, then press the dial (p. 211).
- (3) Turn the SEL/PUSH EXEC dial to select the desired picture effect mode, then press the dial.

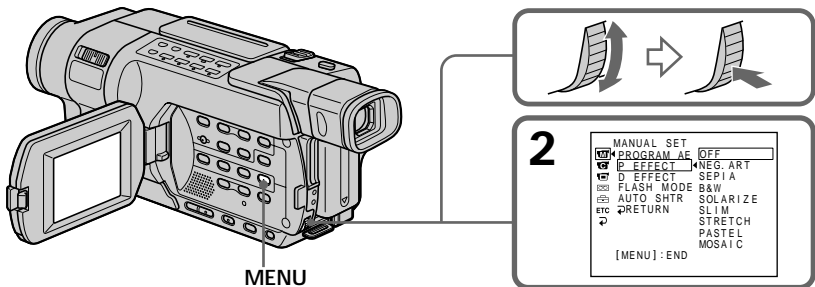

To cancel Picture effect

Set P EFFECT to OFF in the menu settings.

While using Picture effect **[350]** **[351]**

You cannot select OLD MOVIE with Digital effect.

When you set the POWER switch to OFF (CHG)

Picture effect is automatically canceled.

Using special effects – Digital effect

350 351

You can add special effects to recorded images using the various digital functions. The sound is recorded normally.

STILL

You can record a still image so that it is superimposed on a moving picture.

FLASH (FLASH MOTION)

You can record still images successively at regular intervals.

LUMI. (LUMINANCE KEY)

You can swap the brighter area in a still image with a moving picture.

TRAIL

You can record a picture so that an incidental image like a trail is left.

SLOW SHTR (SLOW SHUTTER)

You can slow down the shutter speed. The slow shutter mode is good for recording dark pictures more brightly.

OLD MOVIE

You can add an old movie type atmosphere to pictures. Your camcorder automatically changes the screen format to wide and the color to sepia and set the appropriate shutter speed.

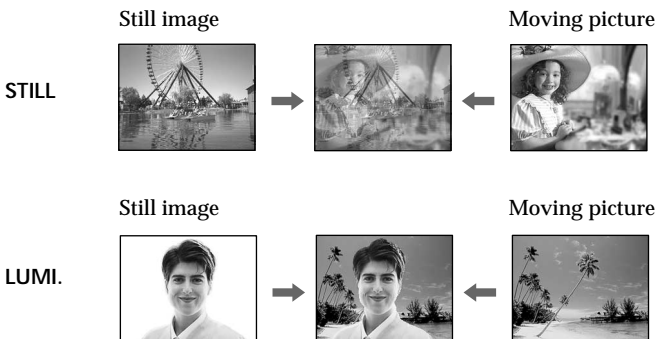

Using special effects – Digital effect

- (1) In CAMERA mode, press MENU to display the menu settings.
- (2) Turn the SEL/PUSH EXEC dial to select D EFFECT in , then press the dial (p. 211).
- (3) Turn the SEL/PUSH EXEC dial to select the desired digital effect mode.
- (4) Press the SEL/PUSH EXEC dial. The bars appear on the screen. In the STILL and LUMI. modes, the still image is stored in memory.
- (5) Turn the SEL/PUSH EXEC dial to adjust the effect, then press the dial.

| Effect | Items to be adjusted |
|-----------|---|
| STILL | The degree of still image you want to superimpose on the moving picture. |
| FLASH | The interval of flash motion. |
| LUMI. | The brightness of the area in the still image which is to be swapped with a moving picture. |
| TRAIL | The vanishing time of the incidental picture. |
| SLOW SHTR | Shutter speed. The larger the shutter speed number, the slower the shutter speed becomes. |
| OLD MOVIE | No adjustment necessary. |

The more bars there are on the screen, the stronger the effect. The bars appear in the following modes: STILL, FLASH, LUMI. and TRAIL.

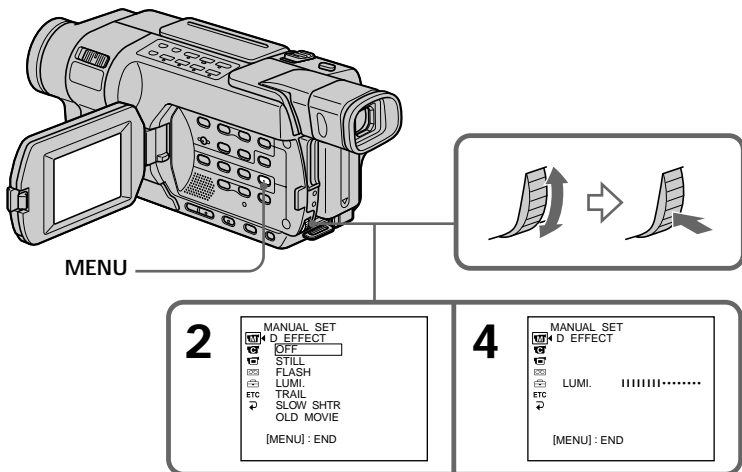

To cancel Digital effect

Set D EFFECT to OFF in the menu settings.

Using special effects – Digital effect

Notes

- The following functions do not work during digital effects:
 - Fader
 - Super NightShot
 - Color Slow Shutter
- The PROGRAM AE function does not work in the slow shutter mode.
- The following functions do not work in the OLD MOVIE mode:
 - Wide mode
 - Picture effect
 - PROGRAM AE

When you set the POWER switch to OFF (CHG)

Digital effect is automatically canceled.

When recording in the slow shutter mode

Auto focus may not be effective. Focus manually using a tripod.

Shutter speed

| Shutter speed number | Shutter speed |
|----------------------|---------------|
| SLOW SHTR 1 | 1/30 |
| SLOW SHTR 2 | 1/15 |
| SLOW SHTR 3 | 1/8 |
| SLOW SHTR 4 | 1/4 |

Using the PROGRAM AE function

You can select the PROGRAM AE (Auto Exposure) mode to suit your specific shooting requirements.

 (SPOTLIGHT)

This mode prevents people's faces, for example, from appearing excessively white when shooting subjects lit by strong light in the theater.

 (PORTRAIT)

This mode brings out the subject while creating a soft background for subjects such as people or flowers.

 (SPORTS)

This mode minimizes camera shake on fast-moving subjects such as in tennis or golf.

 (BEACH & SKI)

This mode prevents people's faces from appearing dark in strong light or reflected light, such as at a beach in midsummer or on a ski slope.

 (SUNSETMOON)

This mode allows you to maintain atmosphere when you are recording sunsets, general night views, fireworks displays and neon signs.

 (LANDSCAPE)

This mode is for when you record distant subjects such as mountains and prevents your camcorder from focusing on glass or metal mesh in windows when you record a subject behind glass or a screen.



Using the PROGRAM AE function

- (1) In CAMERA or MEMORY mode, press MENU to display the menu settings.*
- (2) Turn the SEL/PUSH EXEC dial, select PROGRAM AE in **[M]**, then press the dial (p. 211).
- (3) Turn the SEL/PUSH EXEC dial to select the desired mode, then press the dial.

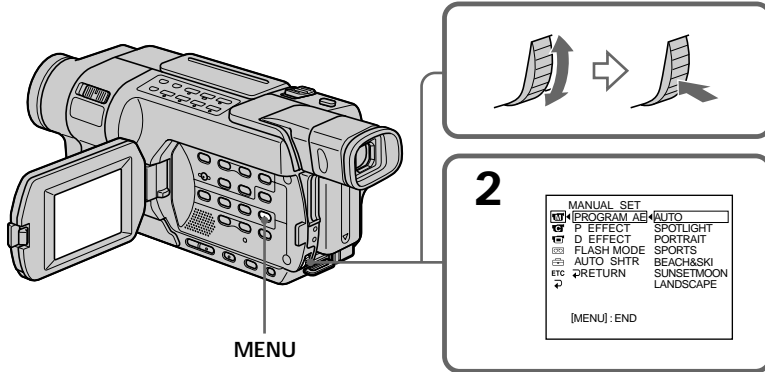

To cancel the PROGRAM AE function

Set PROGRAM AE to AUTO in the menu settings.

Notes

- In the SPOTLIGHT, SPORTS and BEACH & SKI modes, you cannot take close-ups. This is because your camcorder is set to focus only on subjects in the middle to far distance.
- In the SUNSETMOON and LANDSCAPE modes, your camcorder is set to focus only on distant subjects.
- The following functions do not work in the PROGRAM AE function:
 - Color Slow Shutter **[350] [351]**
 - SLOW SHUTTER **[350] [351]**
 - OLD MOVIE **[350] [351]**
 - BOUNCE
- PROGRAM AE function does not work in the following cases (The indicator flashes):
 - When using MEMORY MIX on a “Memory Stick.” **[350] [351]**
 - When NIGHTSHOT is set to ON.

If you are recording under a discharge tube such as a fluorescent lamp, sodium lamp or mercury lamp

Flickering or changes in color may occur in the following modes. If this happens, turn the PROGRAM AE function off:

- PORTRAIT
- SPORTS

Even if the PROGRAM AE function is selected

You can adjust the exposure.

* Modes on the POWER switch vary depending on models (p. 16).

Adjusting the exposure manually

You can manually adjust and set the exposure. Normally, exposure is automatically adjusted.

Adjust the exposure manually in the following cases:

- When the subject is backlit.
- When shooting bright subjects against dark backgrounds.
- When recording dark pictures (e.g. night scenes) faithfully.

- (1) In CAMERA or MEMORY mode, press EXPOSURE.* The exposure indicator appears on the screen.
- (2) Turn the SEL/PUSH EXEC dial to adjust the brightness.

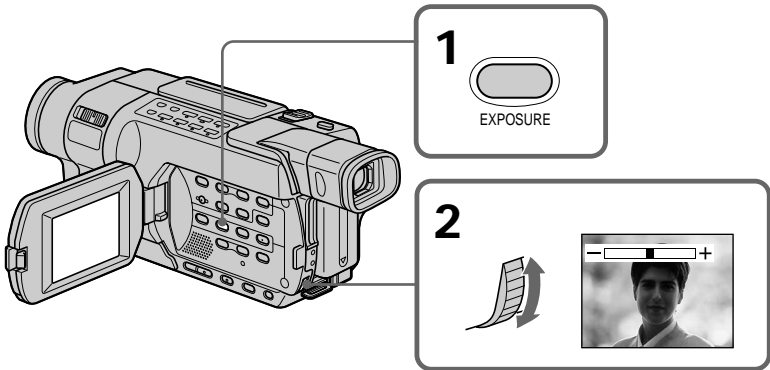

To return to the automatic exposure mode

Press EXPOSURE.

Note

When you adjust the exposure manually, the following functions do not work:

- Color Slow Shutter **350** **351**
- BACK LIGHT

Your camcorder automatically returns to the automatic exposure mode:

- If you change the PROGRAM AE mode.
- If you slide NIGHTSHOT to ON.

* Modes on the POWER switch vary depending on models (p. 16).

Focusing manually

You can gain better results by manually adjusting the focus in the following cases:

- The autofocus mode is not effective when shooting:
 - Subjects through glass covered with water droplets.
 - Horizontal stripes.
 - Subjects with little contrast with backgrounds such as walls or the sky.
- When you want to change the focus from a subject in the foreground to a subject in the background.
- Shooting a stationary subject when using a tripod.

Normally, focus is automatically adjusted.

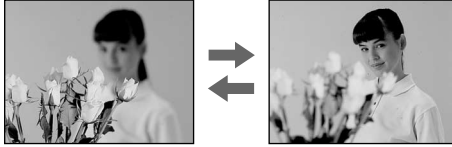

- (1) In CAMERA or MEMORY mode, press FOCUS.* The  indicator appears on the screen.
- (2) Turn the SEL/PUSH EXEC dial to sharpen focus.

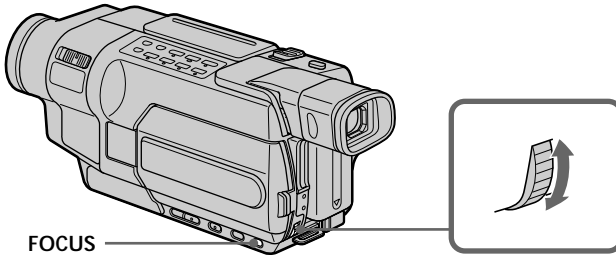

To return to the autofocus mode

Press FOCUS.

To focus precisely

It is easier to focus on subjects if you adjust the zoom to shoot at the “W” (wide-angle) after focusing at the “T” (telephoto) position.

When you shoot close to the subject

Focus at the end of the “W” (wide-angle) position.

The  indicator changes to the following indicators:

- ▲ when recording a distant subject.
- when the subject is too close to focus on.

* Modes on the POWER switch vary depending on models (p. 16).

Interval recording

150 250 350 351

You can make a time-lapse recording by setting your camcorder to automatically record and standby sequentially. You can achieve an excellent recording for flowering, gradual appearances, etc., with this function.

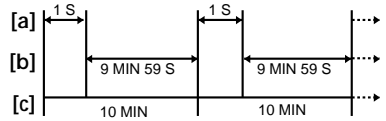

Example



[a]: Recording time (REC TIME)

[b]: Waiting time

[c]: Interval time (INTERVAL)

- (1) In the standby mode, press MENU to display the menu settings.
- (2) Turn the SEL/PUSH EXEC dial to select INT. REC in , then press the dial (p. 219).
- (3) Turn the SEL/PUSH EXEC dial to select SET, then press the dial.
- (4) Set INTERVAL and REC TIME.
 - ① Turn the SEL/PUSH EXEC dial to select INTERVAL, then press the dial.
 - ② Turn the SEL/PUSH EXEC dial to select the desired interval time, then press the dial.
The time: 30SEC ↔ 1MIN ↔ 5MIN ↔ 10MIN
 - ③ Turn the SEL/PUSH EXEC dial to select REC TIME, then press the dial.
 - ④ Turn the SEL/PUSH EXEC dial to select the desired recording time, then press the dial.
The time: 0.5SEC ↔ 1SEC ↔ 1.5SEC ↔ 2SEC
 - ⑤ Turn the SEL/PUSH EXEC dial to select  RETURN, then press the dial.
- (5) Turn the SEL/PUSH EXEC dial to select ON, then press the dial.
- (6) Press MENU to make the menu settings disappear. The INTERVAL TAPE indicator flashes.
- (7) Press START/STOP to start interval recording. The INTERVAL TAPE indicator lights up.

Interval recording

7

2,3

4

5

6

Advanced Recording Operations

To cancel interval recording

Perform either of the following:

- Set INT. REC to OFF in the menu settings.
- Set the POWER switch to the position other than CAMERA.

To perform normal recording during interval recording

You can perform normal recording only once during interval.

Press START/STOP. The INTERVAL TAPE indicator flashes, and normal recording starts. To stop normal recording, press START/STOP again and the screen in step (6) appears.

On recording time

There may be a discrepancy in the recording time of up to +/- six frames from the selected time.

Frame by frame recording

- Frame recording

150 250 350 351

You can make a recording with a stop-motion animated effect using frame recording. To create this effect, alternately move the subject a little and make a frame recording.

250 350 351

We recommend that you use a tripod, and operate your camcorder using the Remote Commander after step (5).

- (1) In the standby mode, press MENU to display the menu settings.
- (2) Turn the SEL/PUSH EXEC dial to select FRAME REC in , then press the dial (p. 219).
- (3) Turn the SEL/PUSH EXEC dial to select ON, then press the dial.
- (4) Press MENU to make the menu settings disappear. The FRAME REC indicator appears.
- (5) Press START/STOP to start frame recording. Your camcorder makes a recording for about six frames, and returns to recording standby.
- (6) Move the subject, and repeat step (5).

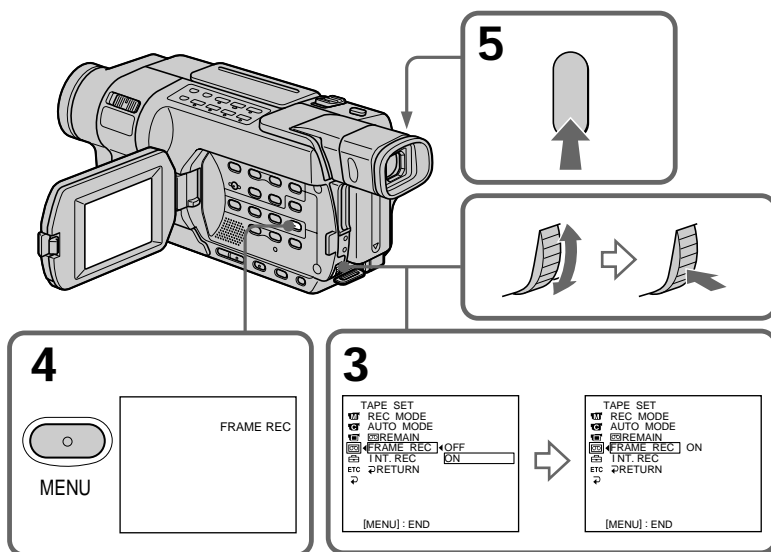

To cancel the frame recording

Perform either of the following:

- Set FRAME REC to OFF in the menu settings.
- Set the POWER switch to the position other than CAMERA.

Note

The remaining tape time is not indicated correctly if you use this function continuously.

When using the frame recording function

The last recorded cut is longer than other cuts.

Superimposing a title

You can select one of the eight preset titles and the two custom titles (p. 77). You can also select the language, color, size and position of titles.



- (1) In the standby mode, press TITLE to display the title menu. The title menu display appears on the screen.
- (2) Turn the SEL/PUSH EXEC dial to select , then press the dial.
- (3) Turn the SEL/PUSH EXEC dial to select the desired title, then press the dial. The titles are displayed in the language you selected.
- (4) Change the color, size, or position, if necessary.
 - ① Turn the SEL/PUSH EXEC dial to select COLOR, SIZE, or POSITION, then press the dial. The selected item appears on the screen.
 - ② Turn the SEL/PUSH EXEC dial to select the desired item, then press the dial.
 - ③ Repeat steps ① and ② until the title is laid out as desired.
- (5) Press the SEL/PUSH EXEC dial again to complete the setting.
- (6) Press START/STOP to start recording.
- (7) When you want to stop recording the title, press TITLE.

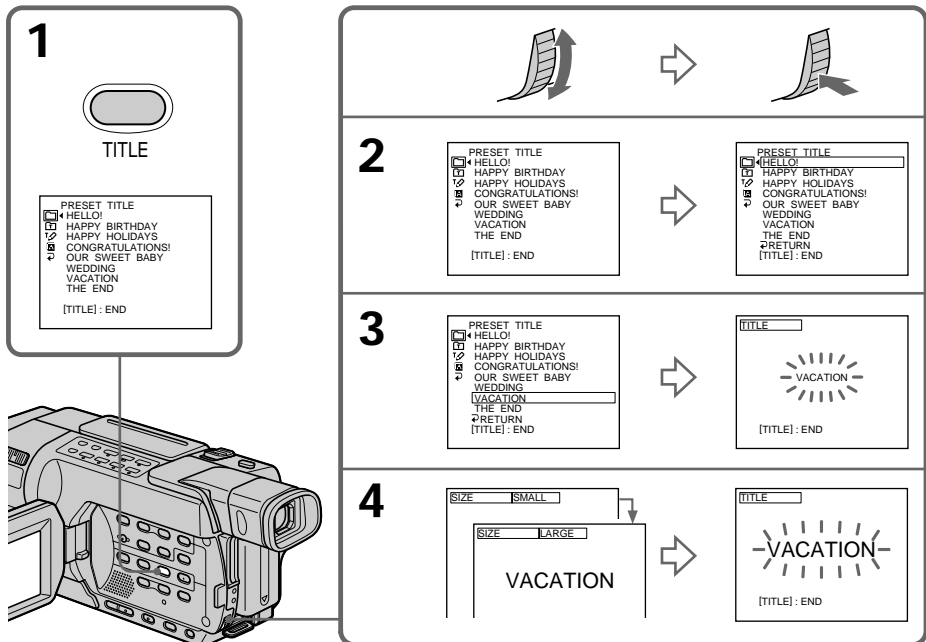

Superimposing a title

To superimpose the title while you are recording

Press TITLE while you are recording, and carry out steps (2) to (5). When you press the SEL/PUSH EXEC dial at step (5), the title is recorded.

To select the language of a preset title

If you want to change the language, select  before step (2). Then select the desired language and return to step (2).

Note

The date and time, or either of them, may not be displayed depending on the size or position of the title.

If you display the menu while superimposing a title

The title is not recorded while the menu is displayed.

To use a custom title

If you want to use a custom title, select  in step (2).

Title setting

- The title color changes as follows:
WHITE ↔ YELLOW ↔ VIOLET ↔ RED ↔ CYAN ↔ GREEN ↔ BLUE
- The title size changes as follows:
SMALL ↔ LARGE
You cannot input 13 characters or more in LARGE size. If you input more than 12 characters, the title size returns to SMALL even if you select LARGE.
- The title position changes as follows:
1 ↔ 2 ↔ 3 ↔ 4 ↔ 5 ↔ 6 ↔ 7 ↔ 8 ↔ 9
The larger the position number, the lower the title is positioned.
When you select the title size "LARGE," you cannot choose position 9.

In CINEMA mode, you cannot choose position 9 for "SMALL" size titles, and position 8 or 9 for "LARGE" size titles.

When you are selecting and setting the title

You cannot record the title displayed on the screen.

When you superimpose a title while you are recording

The beep does not sound.

While you are playing back

You can superimpose a title. However, the title is not recorded on the tape.

You can record a title when you dub a tape by connecting your camcorder to a VCR with the A/V connecting cable.

If you use the i.LINK cable instead of the A/V connecting cable, you cannot record the title.

Making your own titles

You can make up to two titles and store them in your camcorder. Each title can have up to 20 characters.

- (1) In CAMERA or VCR/PLAYER mode, press TITLE.*
- (2) Turn the SEL/PUSH EXEC dial to select , then press the dial.
- (3) Turn the SEL/PUSH EXEC dial to select CUSTOM1 SET or CUSTOM2 SET, then press the dial.
- (4) Turn the SEL/PUSH EXEC dial to select the column of the desired character, then press the dial.
- (5) Turn the SEL/PUSH EXEC dial to select the desired character, then press the dial.
- (6) Repeat steps (4) and (5) until you have selected all characters and completed the title.
- (7) To finish making your own titles, turn the SEL/PUSH EXEC dial to select SET, then press the dial. The title is stored in memory.
- (8) Press TITLE to make the title menu disappear.

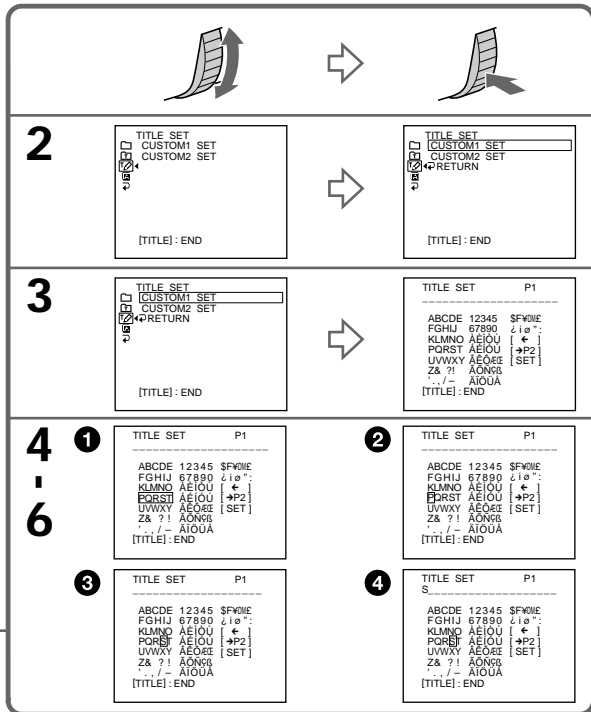
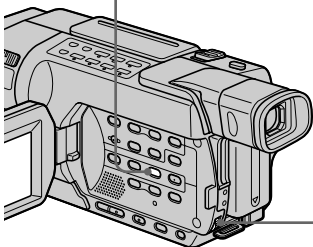
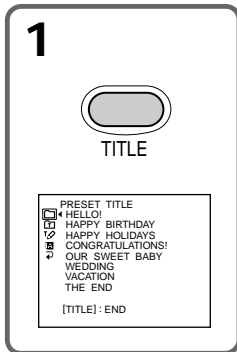

* Modes on the POWER switch vary depending on models (p. 16).

Making your own titles

To change a title you have stored

In step (3), select CUSTOM1 SET or CUSTOM2 SET, depending on which title you want to change, then press the SEL/PUSH EXEC dial.

Turn the SEL/PUSH EXEC dial to select [←], then press the dial to delete the title. The last character is erased. Enter the new title as desired.

If it takes a certain period ^{*1)} or longer to enter characters in the standby mode while a cassette is in your camcorder

The power automatically goes off. The characters you have entered remain stored in memory. Set the POWER switch to OFF (CHG) once, and turn it to CAMERA again, then start from step (1).

We recommend setting the POWER switch to VCR/PLAYER or removing the cassette so that your camcorder is not automatically turned off while you are entering title characters. ^{*2)}

To erase a character

Select [←]. The last character is erased.

To enter a space

Select [Z& ?!], then select the blank part between & and ?.

If you select [→P2]

The menu for selecting alphabet and Russian characters appears. Select [→P1] to return to the previous screen.

*1) three minutes: **150** **250** **350** **351**

five minutes: **118** **318** **418**

*2) Modes on the POWER switch vary depending on models (p. 16).

Using the built-in light

You can use the built-in light to suit your shooting situation. The recommended distance between the subject and camcorder is about 1.5 m (5 feet).

In CAMERA or MEMORY mode, press LIGHT repeatedly until the  indicator appears on the screen.*

The indicator changes as follows:



The built-in light turns on.

If you turn the POWER switch to OFF (CHG), the built-in light turns off simultaneously. You cannot turn the built-in light on by turning the POWER switch to CAMERA or MEMORY again.* To turn on the built-in light again, press LIGHT again in CAMERA or MEMORY mode.*

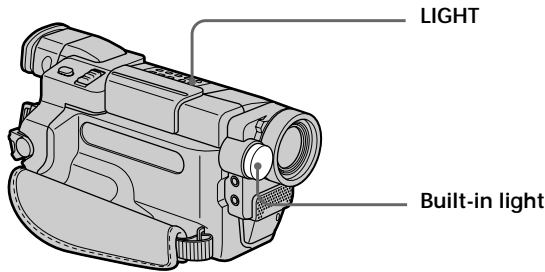

To turn off the built-in light

Press LIGHT repeatedly until no indicator appears on the screen.

To turn on the built-in light automatically

Press LIGHT repeatedly until the  indicator appears on the screen.

The built-in light automatically turns on and off according to the ambient brightness.

CAUTION

Be careful not to touch the lighting section, because the plastic window and surrounding surfaces are hot while the light is on. It remains hot for a while after the light is turned off.

DANGER

Not to be handled by children.

Emits intense heat and light.

Use with caution to reduce the risk of fire or injury to persons.

Do not directly aim the light at persons or materials from less than 1.22 m (4 feet) away during use and until the light becomes cool.

Turn the built-in light off when not in use.

* Modes on the POWER switch vary depending on models (p. 16).

Using the built-in light

Notes

- The built-in light turns off automatically in the following cases:
 - When you leave it on for more than five minutes with the POWER switch set to MEMORY. **350** **351**
 - When it stays on in the AUTO mode (📷) for more than five minutes.
 - When you leave it on for more than five minutes with no cassette inserted or after the tape has run out.To turn the built-in light on again, press LIGHT again.
- The battery pack discharges quickly while the built-in light is turned on. Turn it off when not in use.
- When you do not use your camcorder, turn the built-in light off and remove the battery pack to avoid turning on the built-in light accidentally.
- When flickering occurs while shooting in the AUTO mode (📷), press LIGHT until the 📷 indicator appears.
- The built-in light may turn on/off when you use the PROGRAM AE or backlight function while shooting in the AUTO mode (📷).
- The built-in light may turn off when inserting or ejecting a cassette.
- The built-in light is turned off in the following cases:
 - While the end search function is working
 - Interval time of Interval recording
- When you use the conversion lens (optional), light from the built-in light is blocked and may not illuminate the subject properly.

Using the built-in light

Replacing the bulb

Use the Sony XB-3D halogen lamp (optional). The supplied halogen lamp is not commercially available. Purchase the Sony XB-3D halogen lamp.
Remove the power source before replacing the bulb.

- (1) Remove the built-in light unit while pushing the hole under the built-in light unit using a wire.
- (2) Turn the bulb housing counterclockwise and detach from the built-in light unit.
- (3) Replace the bulb using a dry cloth.
- (4) Attach the bulb housing by turning it clockwise, then replace the built-in light unit.

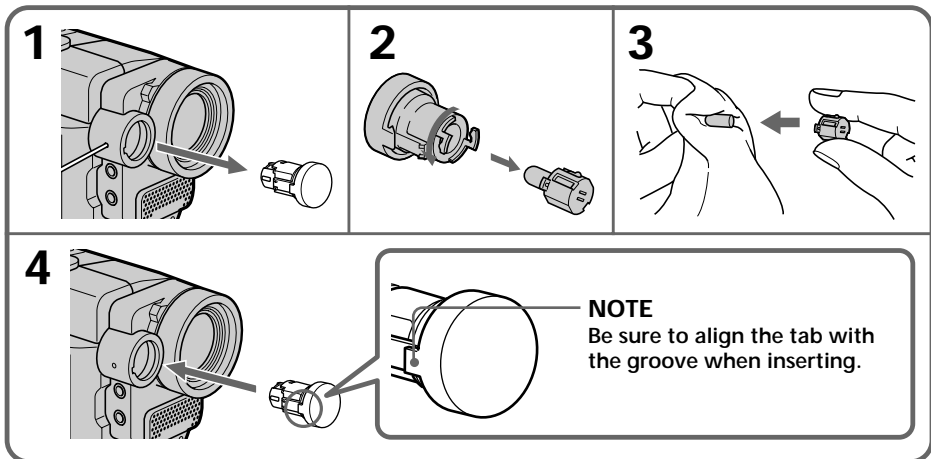

CAUTION

- When replacing the bulb, use only the Sony XB-3D halogen lamp (optional) to reduce the risk of fire.
- To prevent possible burn hazard, disconnect the power source before replacing and do not touch the bulb until the bulb becomes cool enough to handle (for about 30 minutes or more).

Note

To prevent the bulb from being smudged with finger prints, handle it with a dry cloth, etc. If the bulb is smudged, wipe it thoroughly.

Inserting a scene

350 351

You can insert a scene in the middle of a recorded tape by setting the start and end points. The previously recorded frames between these start and end points will be erased.

Use the Remote Commander for this operation.

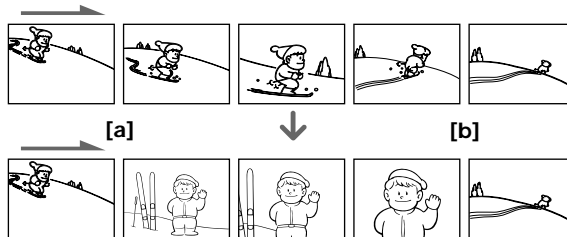

- (1) In the standby mode, keep pressing EDITSEARCH, and release the button at the insert end point [b].
- (2) Press ZERO SET MEMORY on the Remote Commander.
The ZERO SET MEMORY indicator flashes and the counter resets to zero.
- (3) Keep pressing the - ⊖ side of EDITSEARCH and release the button at the insert start point [a].
- (4) Press START/STOP to start recording.
The scene is inserted. Recording stops automatically near the counter zero point. Your camcorder returns to the standby mode.
The zero set memory function is canceled.

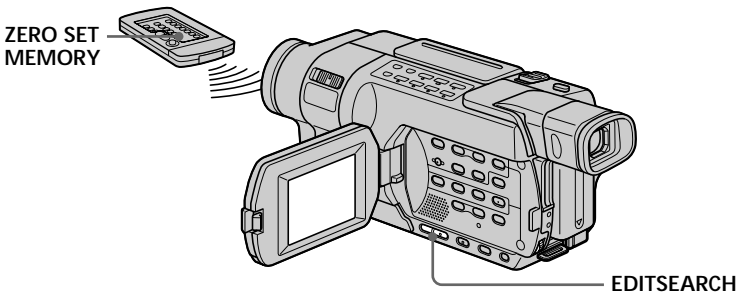

Notes

- The zero set memory function does not work with tapes recorded in the Hi8 Hi8i/standard 8 mm 8 system.
- The picture and the sound may be distorted at the end of the inserted section when it is played back.

If a tape has a blank portion between recorded portions

The zero set memory function may not work correctly.

Playing back a tape with picture effects

150 250 350 351

During playback, you can process a scene using the following picture effects: NEG.ART, SEPIA, B&W and SOLARIZE.

- (1) In the playback or playback pause mode, press MENU to display the menu settings.
- (2) Turn the SEL/PUSH EXEC dial to select P EFFECT in , then press the dial (p. 211).
- (3) Turn the SEL/PUSH EXEC dial to select the desired picture effect mode, then press the dial.

For details of each picture effect, see page 64.

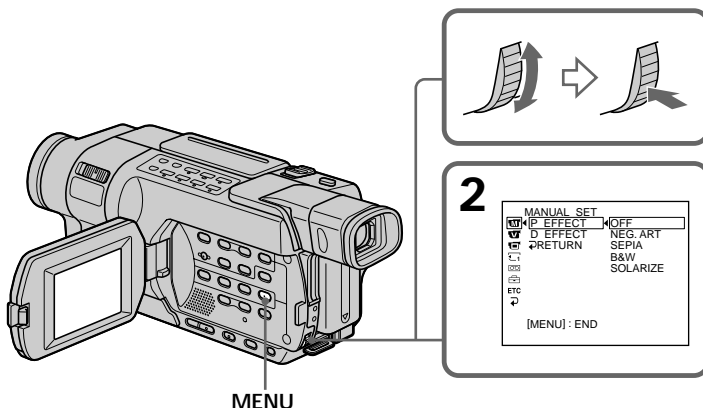

To cancel Picture effect

Set P EFFECT to OFF in the menu settings.

Playing back a tape with picture effects

Notes

- You cannot record images on a tape on your camcorder while you are processing the image using Picture effect. However, you can record images as follows:
 - on a “Memory Stick” as a still image **350** **351**
 - on a VCR using your camcorder as a player
- Picture effect does not work with tapes recorded in the Hi8 **Hi8**/standard 8 mm **8** system.
- You cannot process externally input scenes using Picture effect.

Pictures processed by Picture effect

Pictures processed by Picture effect are not output through the **i** DV jack.

When you set the POWER switch to OFF (CHG) or stop playing back Picture effect is automatically canceled.

Playing back a tape with digital effects

350 351

During playback, you can process a scene using the following digital effects: STILL, FLASH, LUMI. and TRAIL.

- (1) In the playback mode or playback pause mode, press MENU to display the menu settings.
- (2) Turn the SEL/PUSH EXEC dial to select D EFFECT in , then press the dial (p. 211).
- (3) Turn the SEL/PUSH EXEC dial to select the desired digital effect mode, then press the dial. The bars appear on the screen.
In the STILL or LUMI. mode, the picture shown when you press the SEL/PUSH EXEC dial is captured and stored in memory as a still image at the time.
- (4) Turn the SEL/PUSH EXEC dial to adjust the effect, then press the dial.
For details of each digital effect, see page 65.

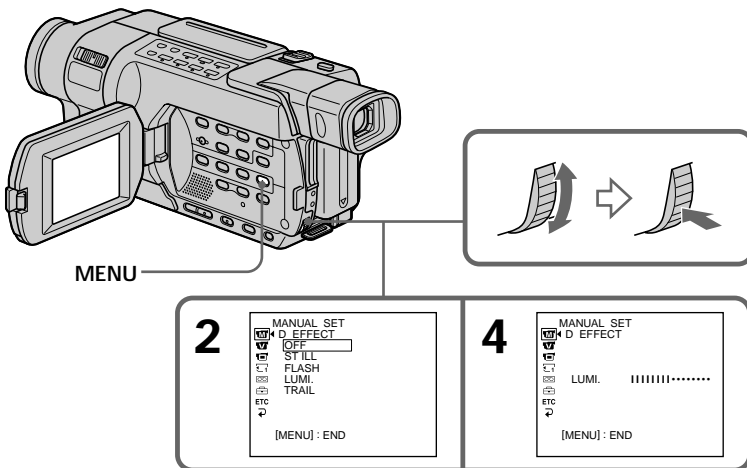

To cancel Digital effect

Set D EFFECT to OFF in the menu settings.

Playing back a tape with digital effects

Notes

- You cannot record images on a tape on your camcorder while you are processing the image using Digital effect. However, you can record images as follows:
 - on a “Memory Stick” as a still image
 - on a VCR using your camcorder as a player
- Digital effect does not work with tapes recorded in the Hi8 **Hi8**/standard 8 mm **8** system.
- You cannot process externally input scenes using Digital effect.

Pictures processed by Digital effect

Pictures processed by Digital effect are not output through the **i** DV jack.



When you set the POWER switch to OFF (CHG) or stop playing back
Digital effect is automatically canceled.

Enlarging recorded images – Tape PB ZOOM

350 351

You can enlarge an image recorded on tapes.

Besides the operation described here, your camcorder can enlarge still images recorded on a "Memory Stick" (p. 172).

- (1) In the playback or playback pause mode, press PB ZOOM. The center of the image is enlarged to about twice its size, and   appear on the screen.
- (2) Turn the SEL/PUSH EXEC dial to move the enlarged image, then press the dial.

 : To view the upper part of the image

 : To view the lower part of the image

- (3) Turn the SEL/PUSH EXEC dial to move the enlarged image, then press the dial.

 : To view the left part of the image (Turn the dial downward.)

 : To view the right part of the image (Turn the dial upward.)

- (4) Adjust the zoom ratio by the power zoom lever.

You can enlarge the image from 1.1 times up to five times its size.

W : To decrease the zoom ratio

T : To increase the zoom ratio

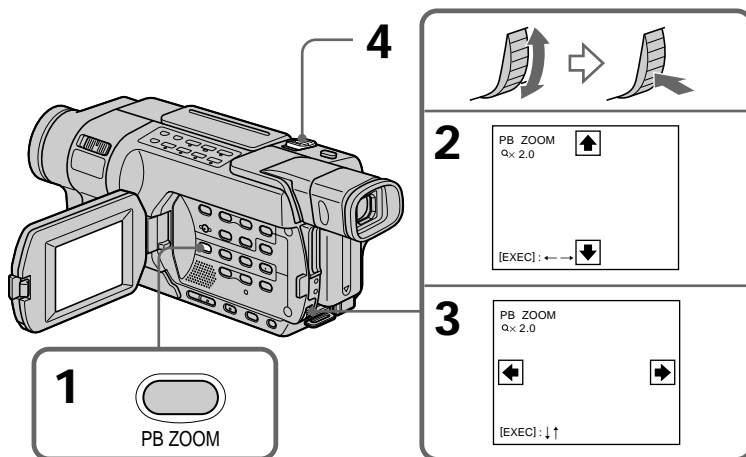

To cancel Tape PB ZOOM

Press PB ZOOM.

Enlarging recorded images – Tape PB ZOOM

Notes

- You cannot record images on a tape or on a “Memory Stick” on your camcorder while you are processing the image using Tape PB ZOOM. However, you can record images on a VCR using your camcorder as a player.
- Tape PB ZOOM does not work with tapes recorded in the Hi8 **Hi8**/standard 8 mm **8** system.
- You cannot process externally input scenes using Tape PB ZOOM.

Images in Tape PB ZOOM

These images are not output through the **i** DV jack.

Tape PB ZOOM is automatically canceled when:

- The POWER switch is set to OFF (CHG).
- You stop playing back.
- You press MENU.
- You press TITLE.

Quickly locating a scene – ZERO SET MEMORY

250 350 351

Your camcorder automatically searches for the scene having a tape counter value of "0:00:00."

Use the Remote Commander for this operation.

Use this function, for example, to view a desired scene later on during playback.

- (1) In the playback mode, press DISPLAY when the tape counter is not displayed on the screen.
- (2) Press ZERO SET MEMORY at the point you want to locate later. The tape counter shows "0:00:00," then starts counting. The ZERO SET MEMORY indicator flashes on the screen.
- (3) Press ■ when you want to stop playback.
- (4) Press ◀◀ to rewind the tape to the counter's zero point. The tape stops automatically when the counter reaches approximately zero. The ZERO SET MEMORY indicator disappears, and the time code appears.
- (5) Press ▶▶. Playback starts from the counter's zero point.

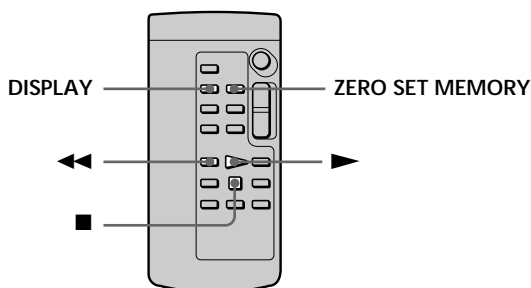

Notes

- The zero set memory does not work with tapes recorded in the Hi8 Hi8i/standard 8 mm 8 system.
- When you press ZERO SET MEMORY before rewinding the tape, the zero set memory is canceled.
- There may be a discrepancy of several seconds between the time code and the tape counter.

If a tape has a blank portion between recorded portions

The zero set memory may not work correctly.

The zero set memory also in the standby mode

When you insert a scene in the middle of a recorded tape, press ZERO SET MEMORY at the point you want to end the insertion. Rewind the tape to the insert start point, and start recording. Recording stops automatically at the tape counter zero point. Your camcorder returns to the standby mode.

Searching for a recording by date - DATE SEARCH

250 **350** **351**

Your camcorder can automatically search for the point where the recording date changes and starts playback from that point.

Use the Remote Commander for this operation.

Use this function to check where recording dates change or to edit the tape at each recording date.

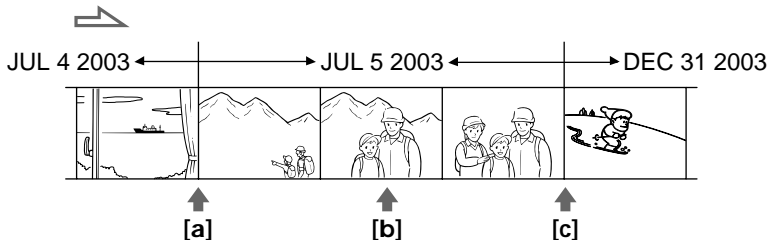

- (1) Set the POWER switch to VCR.
- (2) Press SEARCH MODE on the Remote Commander repeatedly until the DATE SEARCH indicator appears on the screen. The indicator changes as follows:

350 **351**

DATE SEARCH ↔ (no indicator)

250

DATE SEARCH → PHOTO SEARCH → PHOTO SCAN → (no indicator)

- (3) When the current position is [b], press ◀◀ to search toward [a] or press ▶▶ to search toward [c]. Your camcorder automatically starts playback at the point where the date changes.

Each time you press ◀◀ or ▶▶, your camcorder searches for the previous or next date.

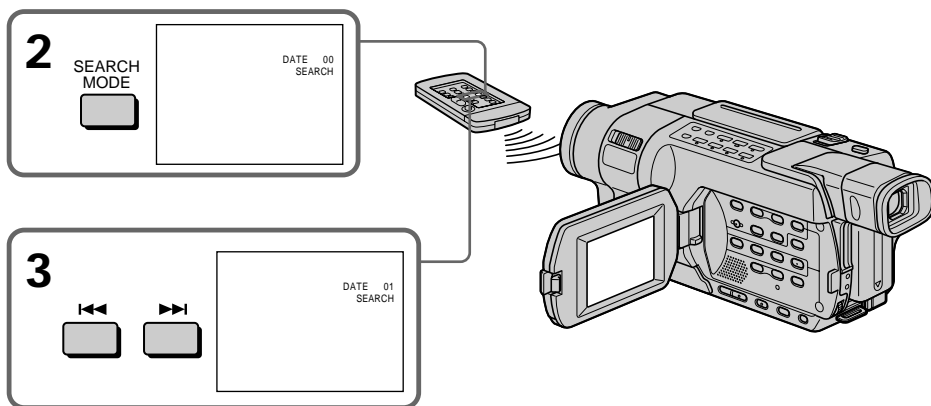

To stop searching

Press ■.

Searching for a recording by date – DATE SEARCH

Notes

- The date search function does not work with tapes recorded in the Hi8 **Hi8**/standard 8 mm **8** system.
- If one day's recording is less than two minutes, your camcorder may not accurately find the point where the recording date changes.

If a tape has a blank portion between recorded portions

The date search function may not work correctly.

Searching for a photo

- PHOTO SEARCH/PHOTO SCAN

250

You can search for the still image recorded on a tape (**photo search**).

You can also search for still images one after another and display each image for five seconds automatically (**photo scan**).

Use the Remote Commander for these operations.

Searching for a photo

- (1) Set the POWER switch to VCR.
- (2) Press SEARCH MODE on the Remote Commander repeatedly until the PHOTO SEARCH indicator appears on the screen. The indicator changes as follows:
DATE SEARCH → PHOTO SEARCH → PHOTO SCAN → (no indicator)
- (3) Press ◀◀ or ▶▶ to select the photo for playback. Each time you press ◀◀ or ▶▶ your camcorder searches for the previous or next photo. Your camcorder automatically starts playback of the photo.

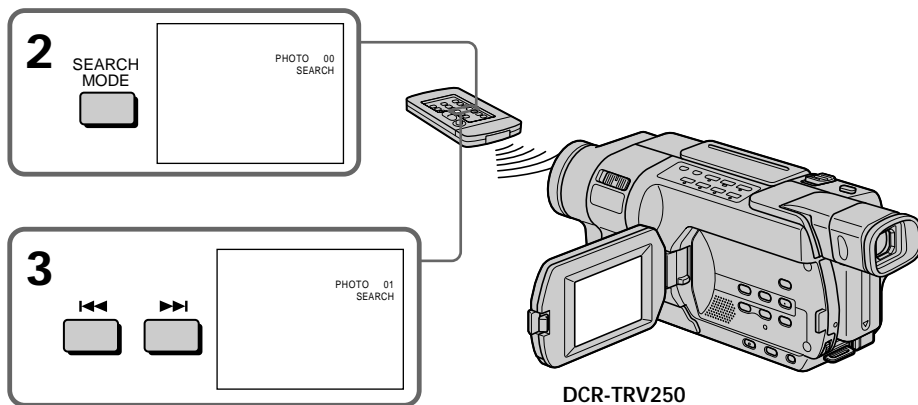

To stop searching

Press ■.

Searching for a photo – PHOTO SEARCH/PHOTO SCAN

Scanning photo

- (1) Set the POWER switch to VCR.
- (2) Press SEARCH MODE on the Remote Commander repeatedly until the PHOTO SCAN indicator appears on the screen.
The indicator changes as follows:
DATE SEARCH → PHOTO SEARCH → PHOTO SCAN → (no indicator)
- (3) Press ◀◀ or ▶▶.
Each photo is played back for about five seconds automatically.

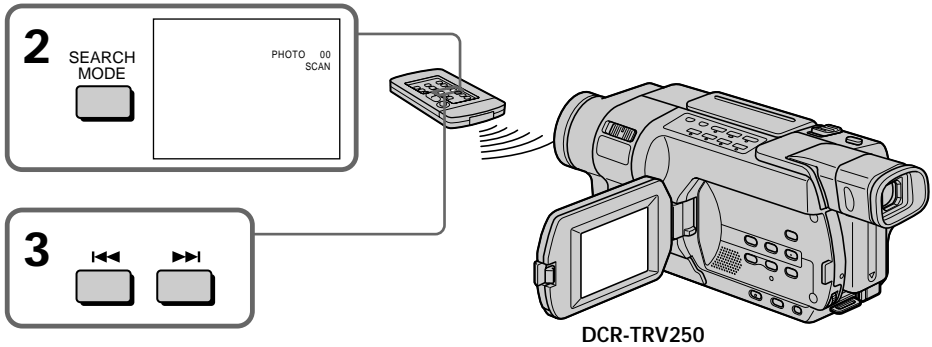

To stop scanning

Press ■.

If a tape has a blank portion between recorded portions

The photo search and photo scan function may not work correctly.

Dubbing a tape

Using the A/V connecting cable

You can dub or edit on the VCR connected to your camcorder using your camcorder as a player.

Before operation

- Set DISPLAY to LCD in the menu settings. (The default setting is LCD.)
- Press the following buttons to make the indicators disappear so that they will not be superimposed on the edited tape:
 - DATA CODE on the Remote Commander **250** **350** **351**
 - SEARCH MODE on the Remote Commander **250** **350** **351**
 - DISPLAY

- (1) Insert a tape for recording into the VCR, and insert the recorded tape into your camcorder.
- (2) Prepare the VCR for recording, then set the input selector to LINE.
Connect the A/V connecting cable to the AUDIO/VIDEO jack. Refer to the operating instructions of your VCR.
- (3) Set the POWER switch to VCR/PLAYER.*
- (4) Play back the recorded tape on your camcorder.
- (5) Start recording on the VCR.
Refer to the operating instructions of your VCR.

150 **250** **350** **351**

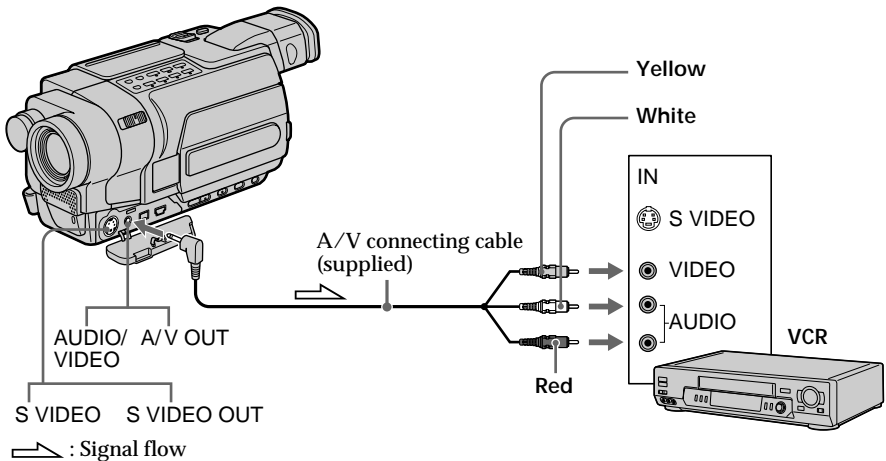

* Modes on the POWER switch vary depending on models (p. 16).

Dubbing a tape

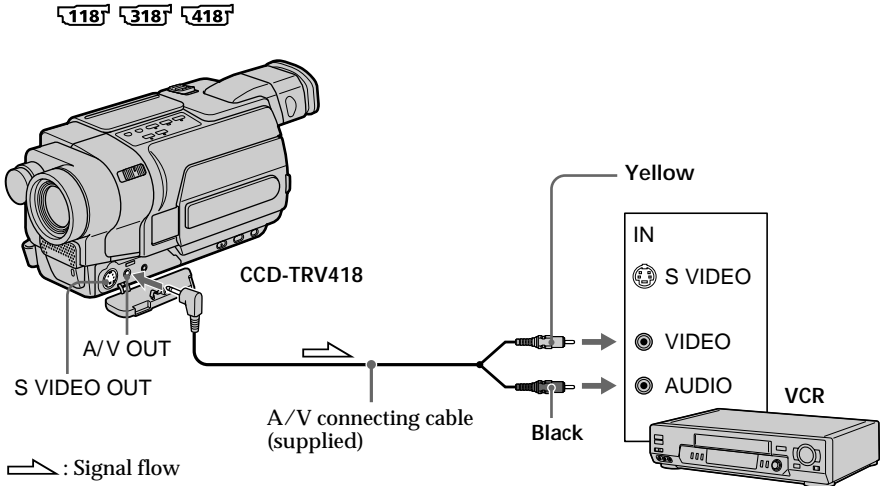

Editing

When you have finished dubbing a tape

Press **■** on both your camcorder and the VCR.

To prevent deterioration of pictures when dubbing

118 318 418

Set EDIT to ON in the menu settings before dubbing. (The default setting is OFF.)
(p. 214)

You can edit on VCRs that support the following systems:

8 mm **8**, Hi8 **Hi8**, Digital8 **D8**, VHS **VHS**, S-VHS **S-VHS**, VHSC **VHSC**, S-VHSC **S-VHSC**,
Betamax **B**, ED Betamax **ED Beta**, mini DV **Mini DV**, DV **DV**, or MICRO MV **MICRO MV**.

If your VCR is a monaural type **150 250 350 351**

Connect the yellow plug of the A/V connecting cable to the video input jack and the white or the red plug to the audio input jack on the VCR. When the white plug is connected, the left channel audio is output, and when the red plug is connected, the right channel audio is output.

If your VCR is a stereo type **118 318 418**

Connect the audio plug of the A/V connecting cable to the left (white) input jack of your VCR.

If your VCR has an S video jack

Pictures can be reproduced more faithfully by using an S video cable (optional). With this connection, you do not need to connect the yellow (video) plug of the A/V connecting cable. Connect an S video cable (optional) to the S video jacks of both your camcorder and the VCR.

Dubbing a tape

Using the i.LINK cable **150** **250** **350** **351**

Simply connect the i.LINK cable (optional) to DV on your camcorder and to DV IN on the DV products. With a digital-to-digital connection, video and audio signals are transmitted in digital form for high-quality editing. You cannot dub the screen indicators.

- (1) Insert a blank tape (or a tape you want to record over) into the VCR, and insert the recorded tape into your camcorder.
- (2) Set the input selector on the VCR to DV IN if it is available. Refer to the operating instructions of your VCR.
- (3) Set the POWER switch to VCR on your camcorder.
- (4) Play back the recorded tape on your camcorder.
- (5) Start recording on the VCR.
Refer to the operating instructions of your VCR.

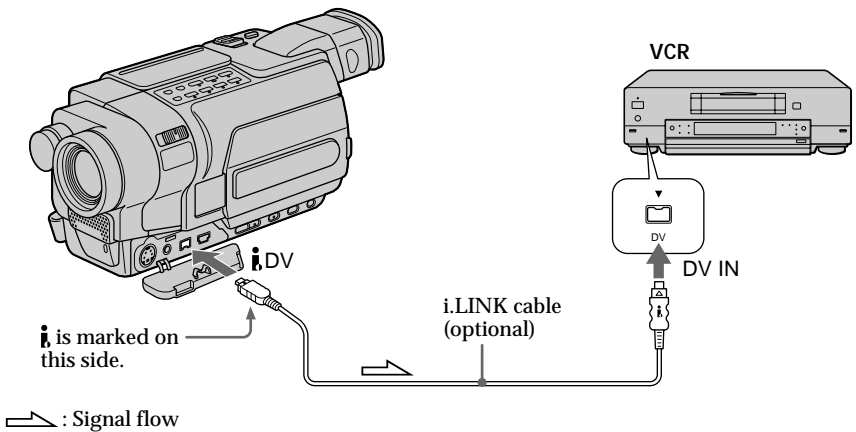

Dubbing a tape

When you have finished dubbing a tape

Press **■** on both your camcorder and the VCR.

Note on tapes that are recorded in the Hi8 **Hi8**/standard 8 mm **8** system

The picture may fluctuate. This is not a malfunction. Digital signals are output as image signals from the **i** DV jack during playback.

You can connect one VCR only using the i.LINK cable

See page 244 for more information about i.LINK.

Pictures processed by the following functions cannot be output through the **i** DV jack:

- Digital effect **350** **351**
- Tape PB ZOOM **350** **351**
- Picture effect



If you record paused playback picture with the **i** DV jack

The recorded picture becomes rough. Also, when you play back the picture using other video equipment, the picture may jitter.

When you connect using an i.LINK cable

You cannot dub the titles and display indicators.

Dubbing a tape easily – Easy Dubbing

VCR operation for dubbing can be controlled easily by using your camcorder when the VCR is connected.

You can select one of eight preset titles and two custom titles stored in your camcorder as instructed in “Making your own titles” (p. 77). Select the desired color, size, and background color of titles.

Using the Easy Dubbing

Step 1 Connecting the VCR

Step 2 Setting the VCR to operate with your camcorder (p. 99 to 102)

Step 3 Selecting the title (p. 103)

Step 4 Selecting the dubbing mode (p. 104)

Step 5 Performing Easy Dubbing (p. 105)

If you dub using the same VCR again, you can skip **Step 2** (p. 99 to 102).

If you do not need to put in a title, you can skip **Step 3** (p. 103).

Step 1: Connecting the VCR

Connect the devices as illustrated in page 95.

You can edit on VCRs that support the following systems:

8 mm , Hi8 , Digital8 , VHS , S-VHS , VHSC , S-VHSC ,
Betamax , ED Betamax , mini DV , DV , or MICRO MV .

If your VCR has an S video jack

Picture can be reproduced more faithfully by using an S video cable (optional).

With this connection, you do not need to connect the yellow (video) plug of the A/V connecting cable.

Connect an S video cable (optional) to the S video jacks of both your camcorder and the VCR.

Dubbing a tape easily – Easy Dubbing

Step 2: Setting the VCR to operate with your camcorder

Signals to control the VCR are sent from your camcorder's infrared rays emitter to the VCR's remote sensor.

When you connect using the A/V connecting cable, follow the procedure below, steps (1) to (4), to send the control signal correctly.

(1) Setting the modes to cancel recording pause on the VCR

- ① Set the POWER switch to PLAYER on your camcorder.
- ② Turn the power of the connected VCR on, then set the input selector to LINE. When you connect a video camera recorder, set its power switch to VTR/VCR.
- ③ Press EASY DUB to display the menu.
- ④ Turn the SEL/PUSH EXEC dial to select SETUP, then press the dial.
- ⑤ Turn the SEL/PUSH EXEC dial to select PAUSE MODE, then press the dial.
- ⑥ Turn the SEL/PUSH EXEC dial to select the mode to cancel recording pause on the VCR, then press the dial.

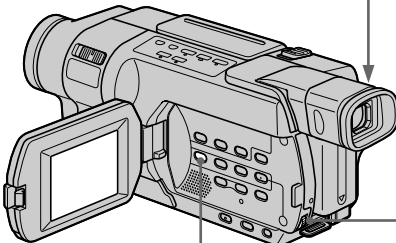
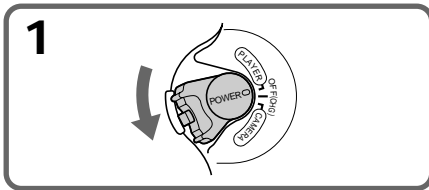

CCD-TRV418

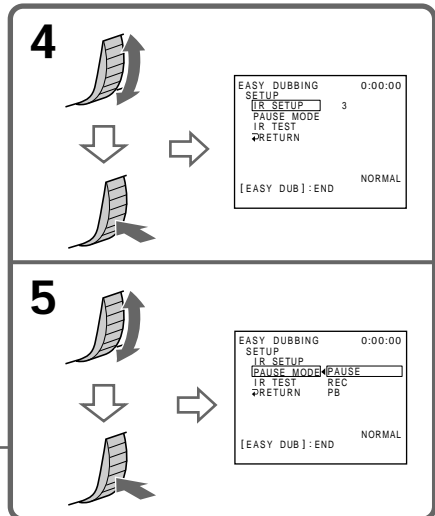
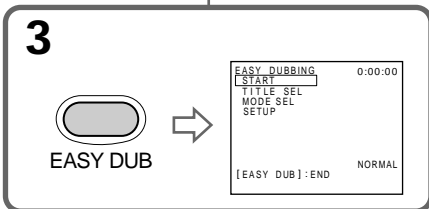

Dubbing a tape easily – Easy Dubbing

Buttons for canceling recording pause on the VCR

The buttons vary depending on your VCR. To cancel recording pause:

- Select PAUSE if the button to cancel recording pause is **II**.
- Select REC if the button to cancel recording pause is **●**.
- Select PB if the button to cancel recording pause is **▶**.

(2) Setting the IR SETUP code

- ① Turn the SEL/PUSH EXEC dial to select IR SETUP, then press the dial.
- ② Turn the SEL/PUSH EXEC dial to select the IR SETUP code of your VCR, then press the dial.
Check the code in “About the IR SETUP code” (p. 101).

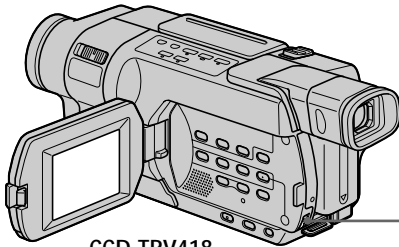

CCD-TRV418

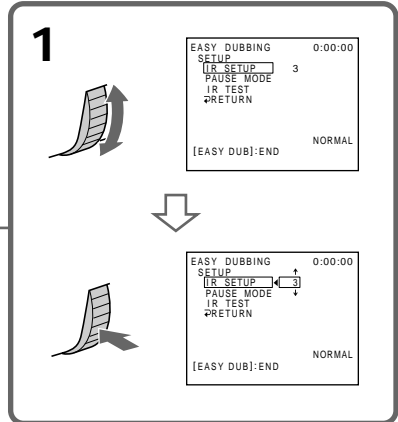

Dubbing a tape easily – Easy Dubbing

About the IR SETUP code

The IR SETUP code is stored in the memory of your camcorder. Be sure to set the correct code depending on your VCR. The default setting is Code number 3.

| Brand | IR SETUP code |
|------------------------|--------------------------------|
| Sony | 1, 2, 3, 4, 5, 6 |
| Admiral (M. Wards) | 89 |
| Aiwa | 80, 47, 54 |
| Akai | 49, 51 |
| Audio Dynamic | 21, 35 |
| Bell&Howell (M. Wards) | 36 |
| Brocsonic | 70, 82, 21 |
| Canon | 77, 78 |
| Citizen | 47 |
| Craig | 73, 47 |
| Curtis Mathis | 8, 80, 77 |
| Daewoo | 26, 40, 77 |
| DBX | 21, 33, 35 |
| Dimensia | 8 |
| Emerson | 26, 82, 59, 48, 70, 81, 80 |
| Fisher | 36, 45, 37, 44 |
| Funai | 80 |
| General Electric | 8, 77, 32*, 94*, 101 |
| Goldstar/LG | 47 |
| GO VIDEO | 71 |
| Hitachi | 78, 8, 42 |
| HQ | 40 |
| Instant Replay | 77, 78 |
| JC Penny | 77, 42, 8, 36, 21, 33, 35 |
| JVC | 21, 12, 13, 14, 33, 35 |
| Kenwood | 21, 33, 47, 35 |
| LXI (Sears) | 80, 47, 42, 44, 45, 36, 37, 49 |
| Magnavox | 83, 78, 77, 17 |
| Marantz | 21, 33, 35 |
| Marta | 47 |
| Memorex | 77, 37 |
| Minolta | 42, 8 |

| Brand | IR SETUP code |
|---------------------------|--|
| Mitsubishi/MGA | 28, 22, 23, 24, 29 |
| Multitech | 23, 80, 32 |
| NEC | 21, 33, 35 |
| Olympic | 77, 78 |
| Optimus | 22 |
| Orion | 60 |
| Panasonic | 16, 17, 78, 77 |
| Pentax | 42, 8 |
| Philco | 78, 77, 26, 70 |
| Philips | 47, 83, 78, 77 |
| Pioneer | 78 |
| Quasar | 78, 77, 16, 17, 6 |
| RCA/PROSCAN | 8, 42, 16, 77, 83, 7, 40, 41, 78, 78*, 101 |
| Realistic | 77, 36, 88, 37, 22, 80 |
| Sansui | 21 |
| Singer | 73 |
| Samsung | 94, 41, 32, 24, 32*, 94*, 24* |
| Sanyo | 36, 37, 26, 36, 47 |
| Scott | 40, 41, 32, 37, 28, 22, 23, 24 |
| Sharp | 89, 88 |
| Shintom | 73 |
| Signature 2000 (M. Wards) | 80, 89 |
| Sylvania | 83, 78, 77, 80 |
| Symphonic | 80 |
| Tashiro | 47 |
| Tatung | 21, 33, 35 |
| Teac | 21, 33, 80, 35 |
| Technics | 77, 78 |
| Toshiba | 40, 7, 49 |
| Wards | 89, 88, 37, 95, 47 |
| Yamaha | 36, 21, 33, 35 |
| Zenith | 95 |

* TV/VCR component

Note on IR SETUP code

Easy Dubbing is not possible if the VCR does not support IR SETUP codes.

Dubbing a tape easily – Easy Dubbing

(3) Setting your camcorder and the VCR to face each other

Locate the infrared rays emitter of your camcorder and face it towards the remote sensor of the VCR.

Set the devices about 30 cm (12 in.) apart, and remove any obstacles between the devices.

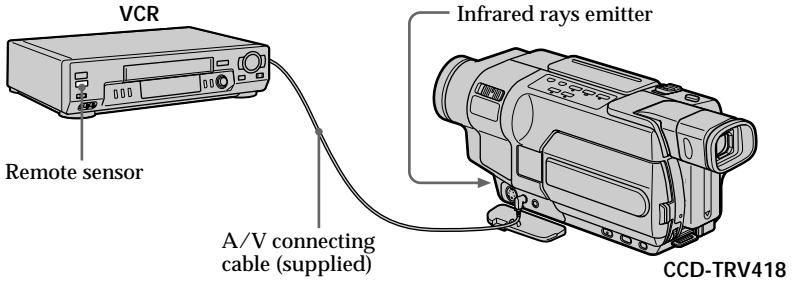

(4) Confirming the VCR operation

- ① Insert a recordable tape into the VCR, then set the VCR to recording pause.
- ② Turn the SEL/PUSH EXEC dial to select IR TEST, then press the dial.
- ③ Turn the SEL/PUSH EXEC dial to select EXECUTE, then press the dial.

If the VCR starts recording, the setting is correct.

When recording is finished, the indicator changes to COMPLETE.

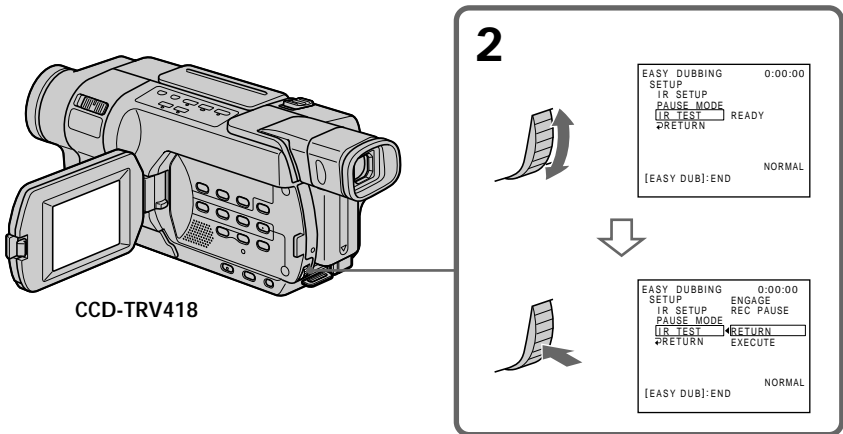

When the VCR does not operate correctly

- After checking the code in “About the IR SETUP code,” set IR SETUP or PAUSE MODE again.
- Place your camcorder at least 30 cm (12 in.) away from the VCR.
- Refer to the operating instructions of your VCR.

Dubbing a tape easily – Easy Dubbing

Step 3: Selecting the title

You can select title, color, size, and background color.
CUSTOM1 and CUSTOM2 are custom titles stored in your camcorder as instructed in “Making your own titles” (p. 77).

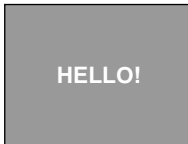

- (1) Turn the SEL/PUSH EXEC dial to select TITLE SEL, then press the dial.
- (2) Select the desired title in the menu settings, then press the dial.
The title flashes.
- (3) Change the color, size, or background color.
If you do not need to change them, go to Step 4 (p. 104).
 - ① Turn the SEL/PUSH EXEC dial to select the color, size, or background color, then press the dial. The item appears.
 - ② Turn the SEL/PUSH EXEC dial to select the desired item, then press the dial.
 - ③ Repeat steps ① and ② until the title is laid out as desired.
- (4) Press the SEL/PUSH EXEC dial again to complete the setting.

CCD-TRV418

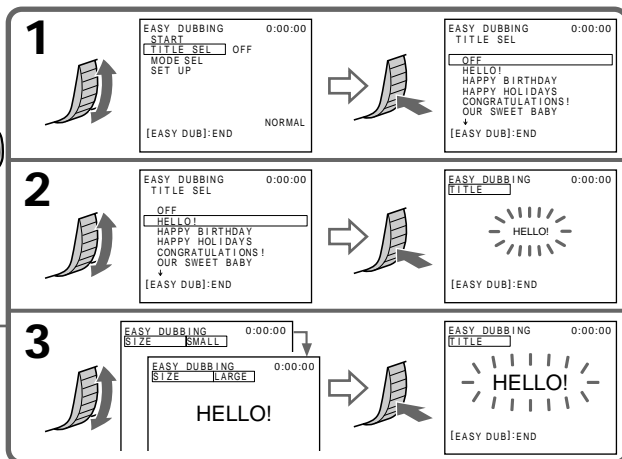
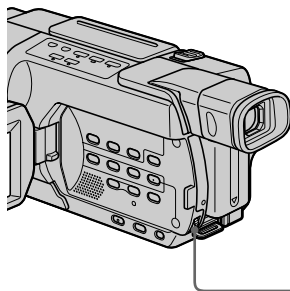

Dubbing a tape easily – Easy Dubbing

Note

You can put a title only into the tape of the VCR.

Title setting

- The title color changes as follows:
WHITE ↔ YELLOW ↔ VIOLET ↔ RED ↔ CYAN ↔ GREEN ↔ BLUE
- The title size changes as follows:
SMALL ↔ LARGE
- The background color changes as follows:
FADE ↔ WHITE ↔ YELLOW ↔ VIOLET ↔ RED ↔ CYAN ↔ GREEN ↔ BLUE ↔ BLACK

Step 4: Selecting the dubbing mode

You can choose either normal recording (NORMAL) or interval recording (PREVIEW).

(1) Turn the SEL/PUSH EXEC dial to select MODE SEL, then press the dial.

(2) Turn the SEL/PUSH EXEC dial to select NORMAL or PREVIEW, then press the dial.

- NORMAL: You can record into the VCR normally.
- PREVIEW: You can make a time-lapse dubbing by setting the VCR to automatically repeat five seconds' recording and 25 seconds' standby.

- [a]: Recording time (VCR)
[b]: Waiting time (VCR)
[c]: Playback time (camcorder)

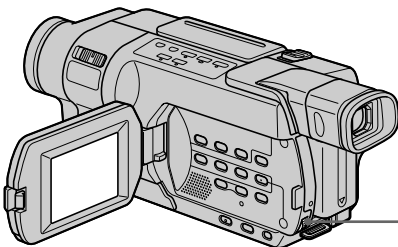
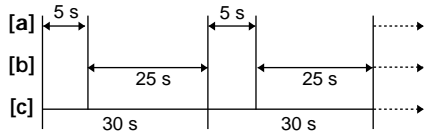

CCD-TRV418

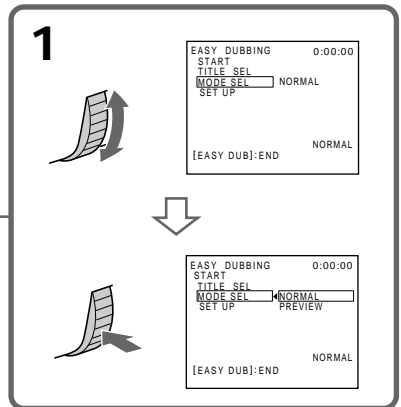

Dubbing a tape easily – Easy Dubbing

Step 5: Performing Easy Dubbing

Make sure that your camcorder and VCR are connected, and that the VCR is set to recording pause.

When you use a video camera recorder, set its power switch to VTR/VCR. Set the POWER switch of your camcorder to PLAYER.

- (1) Turn the SEL/PUSH EXEC dial to select START, then press the dial.
- (2) Turn the SEL/PUSH EXEC dial to select EXECUTE, then press the dial.

When dubbing ends, your camcorder and VCR stop automatically.

Then the display returns to the Easy Dubbing initial screen.

To stop dubbing during editing

Press ■ on your camcorder.

To quit Easy Dubbing

Press EASY DUB.

Note

If you set the background color to FADE in Step 3 (p. 103), the picture may not appear properly depending on the connected VCR.

You cannot record on the VCR when:

- The tape has run out.
- The write-protect tab is set to lock.
- The IR SETUP code is not correct.
- The button used to cancel recording pause is not correct.

NOT READY appears on the screen when

START is not carried out.

Dubbing only desired scenes

- Digital program editing (on tapes)

150 **250** **350** **351**

You can duplicate selected scenes (programs) for editing onto a tape without operating the VCR.

Scenes can be selected by frame. You can set up to 20 programs.

350 **351**

Your camcorder can dub on a "Memory Stick." See page 156 for more information.

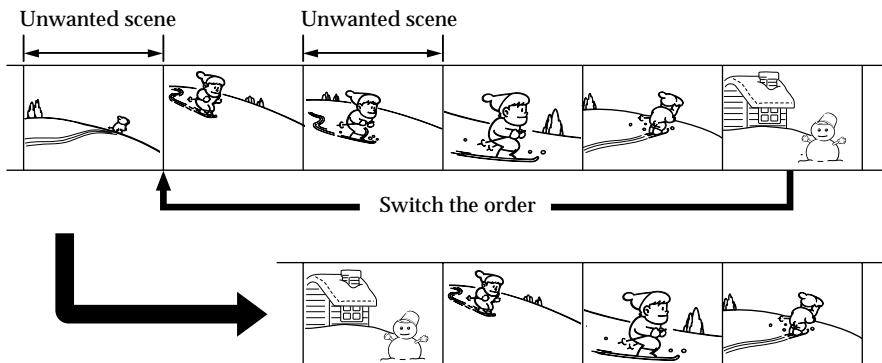

Before operation

Step 1 Connecting the VCR (p. 107)

Step 2 Setting the VCR for operation

- with the A/V connecting cable (p. 107 to 110)
- with the i.LINK cable (p. 111 to 112)

Step 3 Adjusting the synchronization of the VCR (p. 113)



When you dub using the same VCR again, you can skip **Step 2** (p. 107 to 112) and **Step 3** (p. 113 to 114).

Using this function

Operation 1 Making a program (p. 115)

Operation 2 Performing the program (Dubbing a tape) (p. 118)

Note

Digital program editing does not work with tapes recorded in the Hi8 /standard 8 mm  system.

Dubbing only desired scenes – Digital program editing (on tapes)

Step 1: Connecting the VCR

You can connect either an A/V connecting cable or an i.LINK cable.

When you use the A/V connecting cable, connect the devices as illustrated in page 94.

When you use the i.LINK cable, connect the devices as illustrated on page 96.

If you connect using the i.LINK cable

With a digital-to-digital connection, video and audio signals are transmitted in digital format for high-quality editing.

Step 2: Setting the VCR for operation with the A/V connecting cable

To edit using the VCR, set up your camcorder to send the control signal by infrared rays to the remote sensor on the VCR.

When you connect using the A/V connecting cable, follow the procedure below, steps (1) to (4), to send the control signal correctly.

(1) Set the IR SETUP code

- ① Set the POWER switch to VCR on your camcorder.
- ② Turn the power of the connected VCR on, then set the input selector to LINE.
When you connect a video camera recorder, set its power switch to VCR/VTR.
- ③ Press MENU to display the menu settings.
- ④ Turn the SEL/PUSH EXEC dial to select **ETC**, then press the dial.
- ⑤ **350** **351**
Turn the SEL/PUSH EXEC dial to select TAPE in VIDEO EDIT, then press the dial.
150 **250**
Turn the SEL/PUSH EXEC dial to select VIDEO EDIT, then press the dial.
- ⑥ Turn the SEL/PUSH EXEC dial to select EDIT SET, then press the dial.
- ⑦ Turn the SEL/PUSH EXEC dial to select CONTROL, then press the dial.
- ⑧ Turn the SEL/PUSH EXEC dial to select IR, then press the dial.
- ⑨ Turn the SEL/PUSH EXEC dial to select IR SETUP, then press the dial.
- ⑩ Turn the SEL/PUSH EXEC dial to select IR SETUP code number of your VCR, then press the dial.
Check the code in “About the IR SETUP code” (p. 101).

Dubbing only desired scenes - Digital program editing (on tapes)

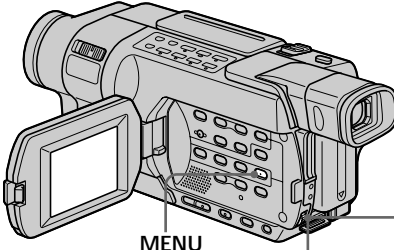

MENU

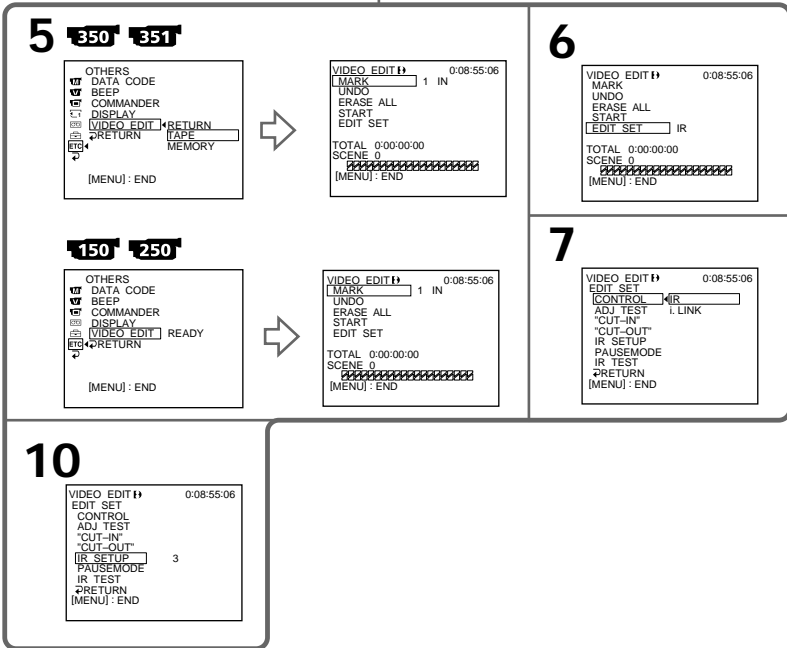
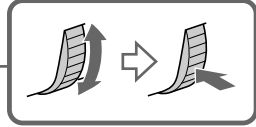

Dubbing only desired scenes – Digital program editing (on tapes)

(2) Setting the modes to cancel the recording pause on the VCR

- ① Turn the SEL/PUSH EXEC dial to select PAUSEMODE, then press the dial.
- ② Turn the SEL/PUSH EXEC dial to select the mode to cancel recording pause on the VCR, then press the dial.

Refer to the operating instructions of your VCR.

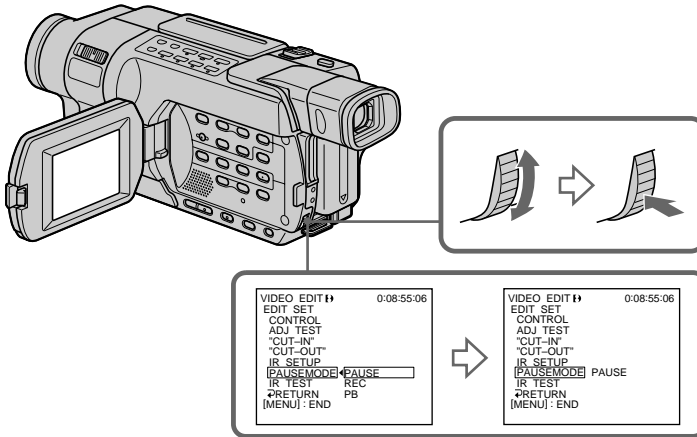

Buttons to cancel recording pause on the VCR

The buttons vary depending on your VCR. To cancel recording pause:

- Select PAUSE if the button to cancel recording pause is **II**.
- Select REC if the button to cancel recording pause is **●**.
- Select PB if the button to cancel recording pause is **▶**.

(3) Setting your camcorder and the VCR to face each other

Locate the infrared rays emitter of your camcorder and face it toward the remote sensor of the VCR.

Set the devices about 30 cm (12 in.) apart, and remove any obstacles between the devices.

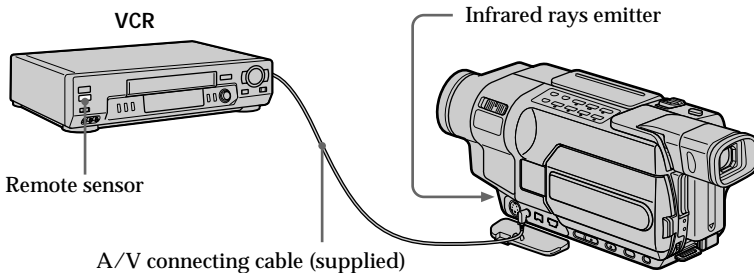

Dubbing only desired scenes – Digital program editing (on tapes)

(4) Confirming VCR operation

- ① Insert a recordable tape into the VCR, then set the VCR to recording pause.
- ② Turn the SEL/PUSH EXEC dial to select IR TEST, then press the dial.
- ③ Turn the SEL/PUSH EXEC dial to select EXECUTE, then press the dial.

If the VCR starts recording, the setting is correct.

When recording is finished, the indicator changes to COMPLETE.

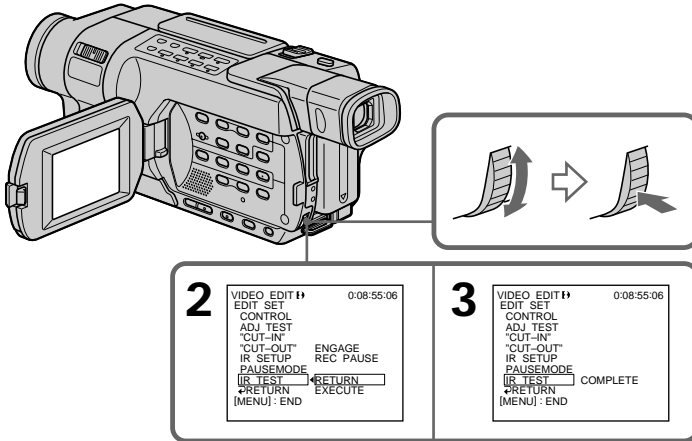

When the VCR does not operate correctly

- After checking the code in "About the IR SETUP code," set IR SETUP or PAUSEMODE again.
- Place your camcorder at least 30 cm (12 in.) away from the VCR.
- Refer to the operating instructions of your VCR.

Dubbing only desired scenes – Digital program editing (on tapes)

Step 2: Setting the VCR for operation with the i.LINK cable

When you connect using the i.LINK cable (optional), follow the procedure below.

- (1) Set the POWER switch to VCR on your camcorder.
- (2) Turn the power of the connected VCR on, then set the input selector to DV input. When you connect a digital video camera recorder, set its power switch to VCR/VTR.
- (3) Press MENU to display the menu settings.
- (4) Turn the SEL/PUSH EXEC dial to select **ETC**, then press the dial.
- (5) **350** **351**
Turn the SEL/PUSH EXEC dial to select TAPE in VIDEO EDIT, then press the dial.
150 **250**
Turn the SEL/PUSH EXEC dial to select VIDEO EDIT, then press the dial.
- (6) Turn the SEL/PUSH EXEC dial to select EDIT SET, then press the dial.
- (7) Turn the SEL/PUSH EXEC dial to select CONTROL, then press the dial.
- (8) Turn the SEL/PUSH EXEC dial to select i.LINK, then press the dial.

Dubbing only desired scenes – Digital program editing (on tapes)

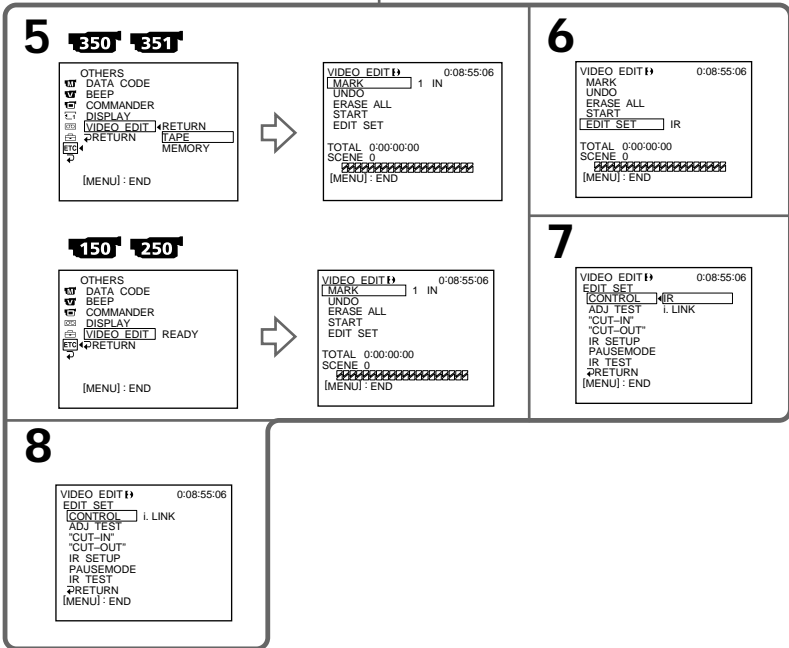
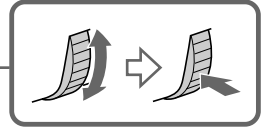
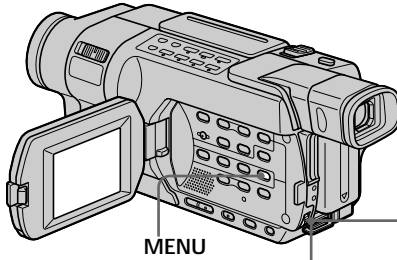

Note **350** **351**

When editing digital video, the operation signals cannot be sent with **LANC**.

When you connect using an i.LINK cable

- You cannot dub the titles and display indicators.
- You may not be able to operate the dubbing function correctly, depending on the VCR. Set CONTROL to IR in the menu settings of your camcorder.

Step 3: Adjusting the synchronization of the VCR

You can adjust the synchronization of your camcorder and the VCR. Have a pen and paper ready for notes. Before operation, eject the cassette from your camcorder if inserted.

- (1) Insert a tape for recording into the VCR, then set the VCR to recording pause. When you select i.LINK in CONTROL, you do not need to set the VCR to recording pause.
- (2) Turn the SEL/PUSH EXEC dial to select ADJ TEST, then press the dial.
- (3) Turn the SEL/PUSH EXEC dial to select EXECUTE, then press the dial. IN and OUT are recorded on an image five times each to calculate the numerical values for adjusting the synchronization. The EXECUTING indicator flashes on the screen. When finished, the indicator changes to COMPLETE.
- (4) Rewind the tape in the VCR, then start slow playback. Take a note of the first numerical value of each IN and the last numerical value of each OUT.
- (5) Calculate the average of all the first numerical values of each IN, and the average of all the last numerical values of each OUT.
- (6) Turn the SEL/PUSH EXEC dial to select “CUT-IN,” then press the dial.
- (7) Turn the SEL/PUSH EXEC dial to select the average numerical value of IN, then press the dial. The calculated start position for recording is set.
- (8) Turn the SEL/PUSH EXEC dial to select “CUT-OUT,” then press the dial.
- (9) Turn the SEL/PUSH EXEC dial to select the average numerical value of OUT, then press the dial. The calculated stop position for recording is set.
- (10) Turn the SEL/PUSH EXEC dial to select ↶ RETURN, then press the dial.

Dubbing only desired scenes – Digital program editing (on tapes)

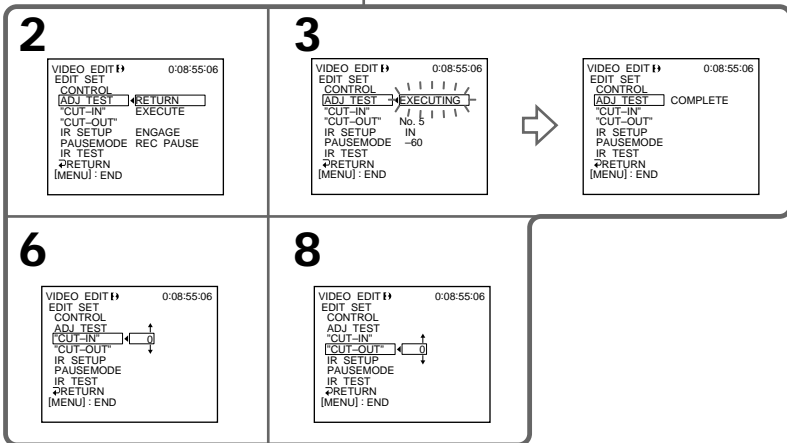
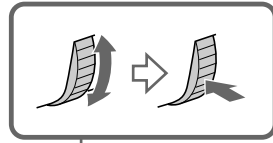
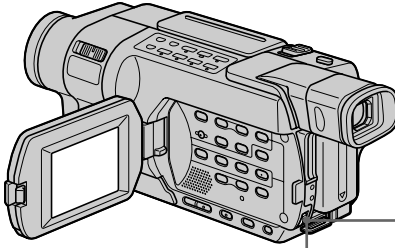

Notes

- When you complete step (3), the image used to adjust synchronization is recorded for about 50 seconds.
- If you start recording from the very beginning of the tape, the first few seconds of the tape may not record properly. Be sure to allow about 10 seconds' lead before starting recording.
- When you connect with the i.LINK cable, you may not be able to operate the dubbing function correctly depending on the VCR.
Keep the i.LINK connection, and set CONTROL to IR in the menu settings.
Video and audio signals are transmitted in digital format.

Operation 1: Making a program

- (1) Insert a tape for playback into your camcorder, and insert a tape for recording into the VCR.
- (2) Press MENU to display the menu settings.
- (3) Turn the SEL/PUSH EXEC dial to select **ETC**, then press the dial.
- (4) **350** **351**
Turn the SEL/PUSH EXEC dial to select TAPE in VIDEO EDIT, then press the dial.
150 **250**
Turn the SEL/PUSH EXEC dial to select VIDEO EDIT, then press the dial.
- (5) Search for the beginning of the first scene you want to insert using the video control buttons, then pause playback.
350 **351**
You can fine-adjust one frame at a time with EDITSEARCH.
- (6) Turn the SEL/PUSH EXEC dial to select MARK, then press the dial.
The IN point of the first program is set, and the upper part of the program mark changes to light blue.
- (7) Search for the end of the first scene you want to insert using the video control buttons, then pause playback.
- (8) Press the SEL/PUSH EXEC dial.
The OUT point of the first program is set, then the lower part of the program mark changes to light blue.
- (9) Repeat steps (5) to (8) to set other programs.
When the program is set, the program mark changes to light blue.
You can set up to 20 programs.

Dubbing only desired scenes - Digital program editing (on tapes)

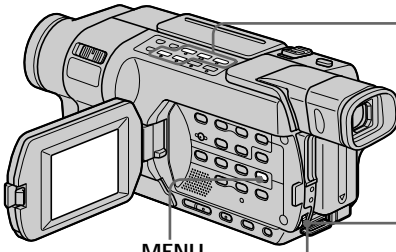

5,7

REW ◀ PLAY ▶ FF

STOP PAUSE

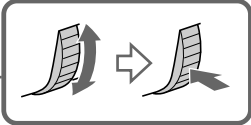

4

OTHERS

- DATA CODE
- BEEP
- COMMANDER
- DISPLAY
- VIDEO EDIT RETURN
- RETURN TAPE MEMORY

[MENU] : END

➔

VIDEO_EDIT 0:08:55:06

[MARK] 1 IN

UNDO

ERASE ALL

START

EDIT SET

TOTAL 0:00:00:00

SCENE 0

#####

[MENU] : END

6

VIDEO_EDIT 0:08:55:06

[MARK] 1 OUT

UNDO

ERASE ALL

START

EDIT SET

TOTAL 0:00:00:00

SCENE 0

#####

[MENU] : END

150 250

OTHERS

- DATA CODE
- BEEP
- COMMANDER
- DISPLAY
- VIDEO EDIT READY
- RETURN

[MENU] : END

➔

VIDEO_EDIT 0:08:55:06

[MARK] 1 IN

UNDO

ERASE ALL

START

EDIT SET

TOTAL 0:00:00:00

SCENE 0

#####

[MENU] : END

8

VIDEO_EDIT 0:09:07:06

[MARK] 2 IN

UNDO

ERASE ALL

START

EDIT SET

TOTAL 0:00:12:00

SCENE 1

#####

[MENU] : END

9

VIDEO_EDIT 0:10:01:23

[MARK] 4 IN

UNDO

ERASE ALL

START

EDIT SET

TOTAL 0:00:47:12

SCENE 3

#####

[MENU] : END

Dubbing only desired scenes – Digital program editing (on tapes)

Erasing the program you have set

Erase OUT first and then IN of the last program.

- (1) Turn the SEL/PUSH EXEC dial to select UNDO, then press the dial.
- (2) Turn the SEL/PUSH EXEC dial to select EXECUTE, then press the dial.
The last set program mark flashes, then the setting is canceled.

To cancel erasing

Select RETURN in step (2).

Erasing all programs

- (1) **350** **351**
Turn the SEL/PUSH EXEC dial to select TAPE in VIDEO EDIT, then press the dial.
150 **250**
Turn the SEL/PUSH EXEC dial to select VIDEO EDIT, then press the dial.
- (2) Select ERASE ALL in the menu settings. Turn the SEL/PUSH EXEC dial to select EXECUTE, then press the dial.
All the program marks flash, then the settings are canceled.

To cancel erasing all programs

Select RETURN in step (2).

To cancel the program you have set

Press MENU.

The program is stored in memory until the tape is ejected.

Notes

- Digital program editing does not work with tapes recorded in the Hi8 **Hi8**/standard 8 mm **8** system.
- You cannot dub the title or display indicators. However, you can dub the title which has already been recorded on a tape.
- You cannot operate recording during Digital program editing on a tape.

You cannot set IN or OUT to the following portions of the tape:

- A portion recorded in Hi8 **Hi8**/standard 8 mm **8** system
- A blank portion of the tape

The total time may not be displayed correctly in the following cases:

- The tape is recorded in the Hi8 **Hi8**/standard 8 mm **8** system.
- There is a blank portion between IN and OUT on the tape.

Operation 2: Performing the program (Dubbing a tape)

Make sure that your camcorder and VCR are connected, and that the VCR is set to recording pause.

When you use an i.LINK cable, setting the VCR to recording pause is not necessary.

When you use a digital video camera recorder, set its power switch to VCR/VTR.

(1) **350** **351**

Select VIDEO EDIT in the menu settings. Turn the SEL/PUSH EXEC dial to select TAPE, then press the dial.

150 **250**

Turn the SEL/PUSH EXEC dial to select VIDEO EDIT, then press the dial.

(2) Select START in the menu settings. Turn the SEL/PUSH EXEC dial to select EXECUTE, then press the dial.

Your camcorder searches for the beginning of the first program, then starts dubbing.

The program mark flashes.

The SEARCH indicator appears during search, and the EDITING indicator appears during edit on the screen.

The program mark changes to light blue after dubbing ends.

When dubbing ends, your camcorder and the VCR automatically stop.

Then the display returns to the VIDEO EDIT initial screen.

To stop dubbing during editing

Press **■** on your camcorder.

To end the Digital program editing

Press MENU.

You cannot record on the VCR when:

- The cassette has run out of tape.
- The write-protect tab on the cassette is set to lock.
- The IR SETUP code is not correct (when IR is selected).
- The button to cancel recording pause is not correct (when IR is selected).

NOT READY appears on the screen when:

- The program to operate Digital program editing has not been made.
- i.LINK is selected but an i.LINK cable is not connected.
- The power of the connected VCR is not turned on (when i.LINK is selected).

Recording video or TV programs

150 250 350 351

Using the A/V connecting cable 350 351

You can record a tape from another VCR or TV program from TV that has video/audio outputs. Use your camcorder as a recorder.

Before operation

Set DISPLAY to LCD in the menu settings. (The default setting is LCD.)

- (1) Insert a tape for recording into your camcorder. If you want to record a tape from the VCR, insert a recorded tape into the VCR.
- (2) Set the POWER switch to VCR on your camcorder.
- (3) Press ● REC and the button on its right simultaneously on your camcorder, then immediately press || on your camcorder.
- (4) Press ► on the VCR to start playback if you record a tape from a VCR. Select a TV program if you record from TV.
The picture from the TV or VCR appears on the screen of your camcorder.
- (5) Press || on your camcorder at the scene where you want to start recording from.

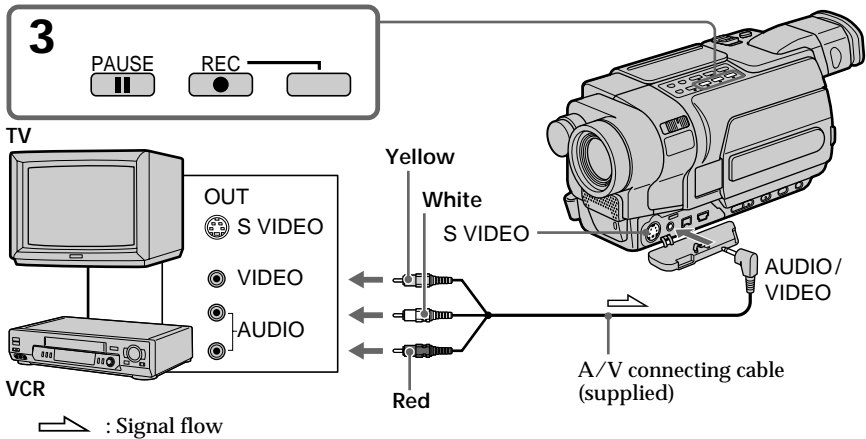

When you have finished dubbing a tape

Press ■ on both your camcorder and the VCR.

Recording video or TV programs

Notes

- To enable smooth transition, we recommend that you do not mix pictures recorded in the Hi8 Hi8/standard 8 mm 8 with the Digital8 8 system on a tape.
- If you do fast-forward or slow-playback on the other equipment, the image being recorded may fluctuate. When recording from other equipment, be sure to play back the original tape at normal speed.

If your VCR or TV is a monaural type

Connect the yellow plug of the A/V connecting cable to the video output jack and the white or the red plug to the audio output jack on the VCR or the TV. When the white plug is connected, the left channel audio is output, and when the red plug is connected, the right channel audio is output.

If your TV or VCR has an S video jack

Pictures can be reproduced more faithfully by using an S video cable (optional).

With this connection, you do not need to connect the yellow (video) plug of the A/V connecting cable.

Connect an S video cable (optional) to the S video jacks of both your camcorder and the TV or VCR.

Recording video or TV programs

Using the i.LINK cable **150** **250** **350** **351**

You can record a tape from a VCR that has DV outputs. Use your camcorder as a recorder.

Simply connect the i.LINK cable (optional) to **i** DV of your camcorder and to DV OUT of the DV products. With a digital-to-digital connection, video and audio signals are transmitted in digital form for high-quality editing.

- (1) Insert a blank tape for recording into your camcorder, and insert the recorded tape into the VCR.
- (2) Set the POWER switch to VCR on your camcorder.
- (3) Press **●** REC and the button on its right simultaneously on your camcorder, then immediately press **||** on your camcorder.
- (4) Press **▶** on the VCR to start playback.
The picture to be recorded appears on the screen of your camcorder.
- (5) Press **||** on your camcorder at the scene where you want to start recording from.

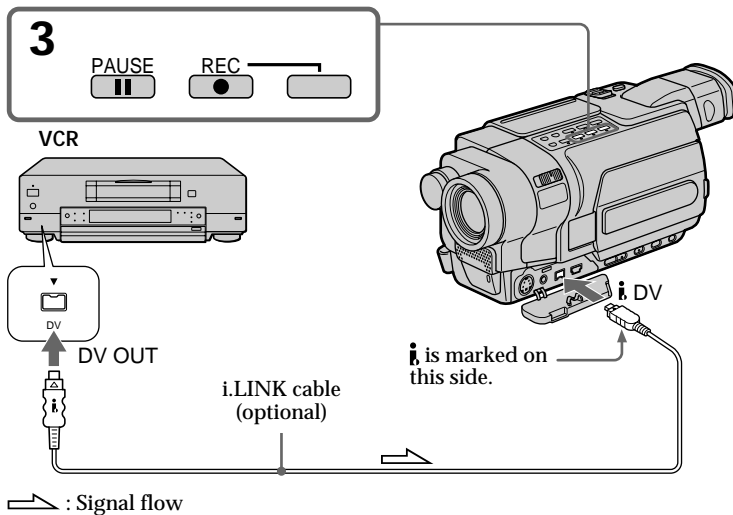

When you have finished dubbing a tape

Press **■** on both your camcorder and the VCR.

You can connect one VCR only using the i.LINK cable.

When you dub a picture in digital form

The color of the display may be uneven. However, this does not affect the dubbed picture.

Recording video or TV programs

If you record a paused playback picture with the DV jack

The recorded picture becomes rough. When you play back the picture using your camcorder, the picture may jitter.

Before recording

Make sure that the DV IN indicator appears on the screen of your camcorder by pressing DISPLAY. The DV IN indicator may appear on both equipment.

Inserting a scene from a VCR – Insert Editing

250 350 351

You can insert a new scene from a VCR onto your originally recorded tape by specifying the insert start and end points.

Use the Remote Commander for this operation.

Connections are the same as on page 119 and 121. Insert a cassette containing the desired scene into the VCR.

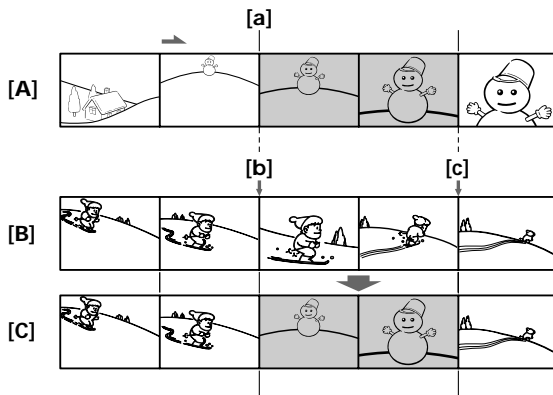

[A]: A tape that contains the scene to be superimposed (VCR)

[B]: A tape before editing (your camcorder)

[C]: A tape after editing (your camcorder)

Inserting a scene from a VCR – Insert Editing

- (1) Set the POWER switch to VCR on your camcorder.
- (2) On the connected VCR, locate just before the insert start point [a], then press **II** to set the VCR to the playback pause mode.
- (3) On your camcorder, locate the insert end point [c] by pressing **◀◀** or **▶▶**. Then press **II** to set your camcorder to the playback pause mode.
- (4) Press ZERO SET MEMORY on the Remote Commander. The ZERO SET MEMORY indicator flashes and the end point of the insert is stored in memory. The tape counter shows "0:00:00."
- (5) On your camcorder, locate the insert start point [b] by pressing **◀◀**. Press **● REC** and the button on its right simultaneously, then immediately press **II** to set your camcorder to the recording pause mode.
- (6) First press **II** on the VCR, and after a few seconds press **II** on your camcorder to start inserting the new scene.

Inserting automatically stops near the zero point on the counter. Your camcorder automatically stops. The end point [c] of the insert stored in memory is canceled.

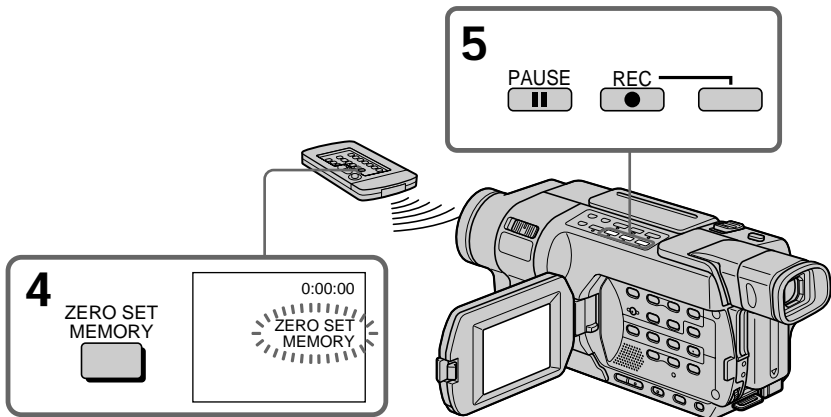

To change the insert end point

Press ZERO SET MEMORY again after step (5) to make the ZERO SET MEMORY indicator disappear and begin from step (3).

Inserting a scene from a VCR – Insert Editing

Notes

- The zero set memory function does not work with tapes recorded in the Hi8 Hi8/standard 8 mm 8 system.
- Pictures and sound recorded on the section between the insert start and end points will be erased when you insert the new scene.
- If you use the Remote Commander when dubbing a tape, the VCR may operate accidentally. Should this happen, change the commander mode of the VCR to one other than VTR2, or cover the sensor of the VCR with black paper.

If you insert scenes on the tape recorded on another camcorder

The pictures and sound may be distorted. We recommend that you insert scenes on a tape recorded on your camcorder.

When the inserted picture is played back

Pictures and sound may be distorted at the end of the inserted section. This is not a malfunction.

Pictures and sound at the start point and the end point may be distorted in the LP mode.

To insert a scene without setting the insert end point

Skip step (3) and (4). Press ■ when you want to stop inserting.

Using a “Memory Stick” – Introduction

350 **351**

You can record and play back images on a “Memory Stick.” You can easily play back, record or delete images. You can exchange image data with other equipment such as your computer, etc., using the USB cable for a “Memory Stick” (p. 182). See page 240 for details of “Memory Stick.”

On file format (DCF compliant)

Still image: Exif* Ver.2.2 JPEG compliant, DPOF compatible

Moving picture: MPEG1 compliant (monaural)

* Exif: Exif is a file format for still images, established by the Japan Electronics and Information Technology Industries Association (JEITA). Files in this format can have additional information such as your camcorder’s setting information at the time of recording.

Typical image data file name

Still image

101 (up to 999)-0001: This file name appears on the screen of your camcorder.

Dsc00001.jpg: This file name appears on the display of your computer.

Moving picture

MOV00001: This file name appears on the screen of your camcorder.

Mov00001.mpg: This file name appears on the display of your computer.

“Memory Stick” formatted on computer

A “Memory Stick” formatted on Windows OS or Macintosh OS is not guaranteed to be compatible with your camcorder.

Notes on image data compatibility

- Image data files recorded on a “Memory Stick” by your camcorder conform with the Design Rule for Camera File System universal standard established by the JEITA (Japan Electronics and Information Technology Industries Association). You cannot play back on your camcorder images recorded on other equipment (DCR-TRV890E/TRV900/TRV900E or DSC-D700/D770) that does not conform with this universal standard. (These models are not sold in some areas.)
- If you cannot use the “Memory Stick” that is used with other equipment, format it with your camcorder (p. 218). However, formatting erases all information on the “Memory Stick.”
- You may not be able to play back the images recorded using your camcorder, on other playback equipment.
- You may not be able to play back following images with your camcorder:
 - image data modified on a computer
 - image data shot with other equipment

Using a “Memory Stick” – Introduction

Inserting a “Memory Stick”

Insert a “Memory Stick” in the “Memory Stick” slot as far as it can go with the ◀ mark facing the LCD panel as illustrated.

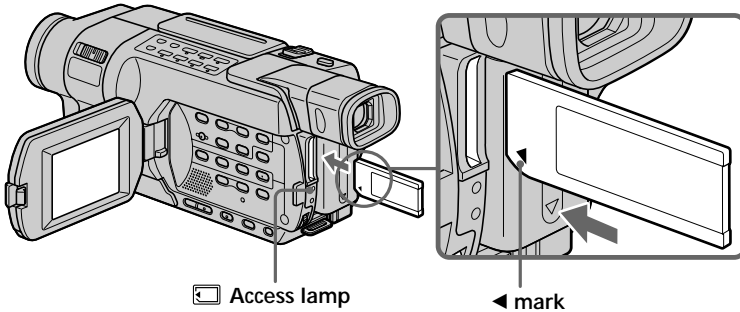

Ejecting the “Memory Stick”

Press the “Memory Stick” once lightly.

When the access lamp is lit or flashing

Do not shake or knock your camcorder because your camcorder is reading the data from the “Memory Stick” or recording the data on the “Memory Stick.” Do not turn the power off, eject the “Memory Stick” or remove the battery pack. Otherwise, image data may become damaged.

If “MEMORY STICK ERROR” is displayed

Reinsert “Memory Stick” a few times. The “Memory Stick” may be damaged if the indicator is still displayed. If this occurs, use another “Memory Stick.”

If the write-protect tab on a “Memory Stick” is set to LOCK

“” appears and functions using the “Memory Stick” do not work.

Using a "Memory Stick" – Introduction

Selecting the still image quality mode

You can select the image quality mode in still image recording. The default setting is FINE.

- (1) Set the POWER switch to VCR or MEMORY. Make sure that the LOCK switch is set to the left (unlock) position.
- (2) Press MENU to display the menu settings.
- (3) Turn the SEL/PUSH EXEC dial to select STILL SET in , then press the dial.
- (4) Turn the SEL/PUSH EXEC dial to select QUALITY, then press the dial.
- (5) Turn the SEL/PUSH EXEC dial to select the desired image quality, then press the dial.

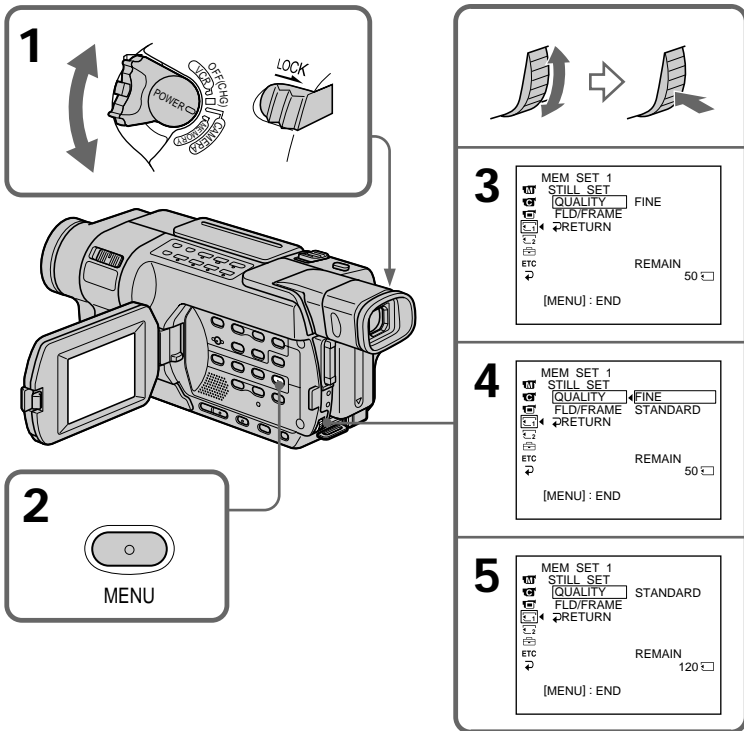

Using a “Memory Stick” – Introduction

Image quality settings

| Setting | Meaning |
|----------------|---|
| FINE (FINE) | Use this mode when you want to record high quality images. The number of still images that can be recorded on a “Memory Stick” becomes less than the number when recorded in STANDARD. Fine images are compressed to about 1/4. |
| STANDARD (STD) | This is the standard image quality. Standard images are compressed to about 1/10. |

Note

In some cases, changing the image quality mode may not affect the image quality, depending on the types of images you are shooting.

Differences in image quality mode

Recorded images are compressed in JPEG format before being stored into memory. The memory capacity allocated to each image varies depending on the selected image quality mode. Details are shown in the table below.

| Image quality mode | Memory capacity |
|--------------------|-----------------|
| FINE | About 150 KB |
| STANDARD | About 60 KB |

Image quality mode indicator

The image quality mode indicator is not displayed during playback.

When you select image quality

The number of images you can shoot in the currently selected image quality appears on the screen.

Using a "Memory Stick" – Introduction

Selecting the moving picture size

You can select either of two image sizes 320 × 240 or 160 × 112.
(The default setting is 320 × 240.)

- (1) Set the POWER switch to VCR or MEMORY. Make sure that the LOCK switch is set to the left (unlock) position.
- (2) Press MENU to display the menu settings.
- (3) Turn the SEL/PUSH EXEC dial to select MOVIE SET in , then press the dial.
- (4) Turn the SEL/PUSH EXEC dial to select IMAGESIZE, then press the dial.
- (5) Turn the SEL/PUSH EXEC dial to select the desired image size, then press the dial.

The indicator changes as follows:

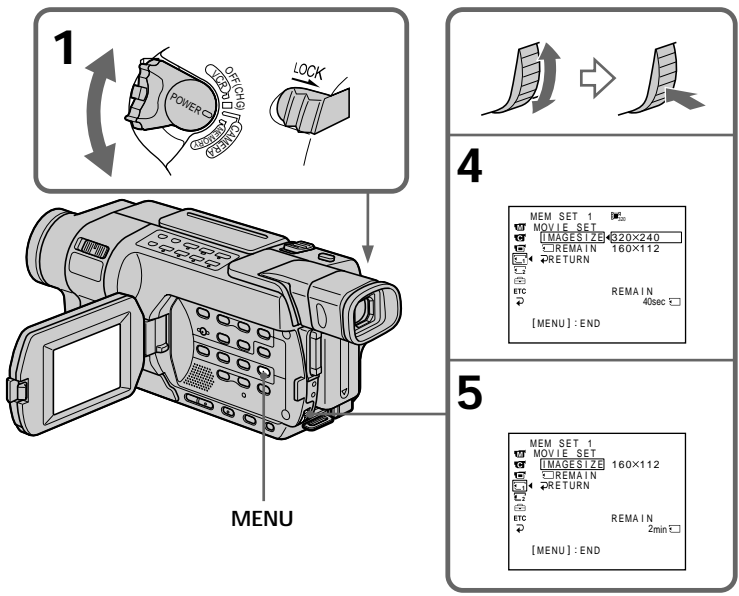

The diagram illustrates the steps to select the moving picture size. It shows a camera with a 'MENU' button and a 'LOCK' switch. Step 1 shows the camera with the 'POWER' switch set to 'MEMORY' and the 'LOCK' switch set to the left (unlock) position. Step 4 shows the camera's menu screen with 'MOVIE SET' selected and 'IMAGESIZE' set to '320x240'. Step 5 shows the camera's menu screen with 'MOVIE SET' selected and 'IMAGESIZE' set to '160x112'.

1

4

5



MENU

The still image size

The still image size is 640 × 480 only.

Using a "Memory Stick" – Introduction

Moving picture size settings

| Setting | Meaning | Indicator |
|-----------|------------------------------------|---|
| 320 × 240 | Records 320 × 240 moving pictures. |  320 |
| 160 × 112 | Records 160 × 112 moving pictures. |  160 |

Approximate number of still images you can record on a "Memory Stick"

The number of images you can record varies depending on which image quality you select and the complexity of the subject.

| Image quality | Type of the "Memory Stick" | | | | |
|---------------|---|-----------------|-----------------|-----------------|------------------|
| | 8MB (supplied)* ¹⁾ (optional)* ²⁾ | 16MB (optional) | 32MB (optional) | 64MB (optional) | 128MB (optional) |
| FINE | 50 images | 96 images | 190 images | 390 images | 780 images |
| STANDARD | 120 images | 240 images | 485 images | 980 images | 1970 images |

Approximate time of moving pictures you can record on a "Memory Stick"

The time of moving pictures you can record varies depending on which image size you select and the complexity of the subject.

| Image size | Type of the "Memory Stick" | | | | |
|------------|---|--------------------|--------------------|--------------------|--------------------|
| | 8MB (supplied)* ¹⁾ (optional)* ²⁾ | 16MB (optional) | 32MB (optional) | 64MB (optional) | 128MB (optional) |
| 320 × 240 | 1 min. 20 sec. | 2 min. 40 sec. | 5 min. 20 sec. | 10 min. 40 sec. | 21 min. 20 sec. |
| 160 × 112 | 5 min. 20 sec. | 10 min. 40 sec. | 21 min. 20 sec. | 42 min. 40 sec. | 85 min. 20 sec. |

The tables above show approximate number of still images and times of moving pictures you can record on a "Memory Stick" formatted on your camcorder.

When available recording time is not left on the "Memory Stick"

" FULL" appears.

*1) 

*2) 

Recording still images on a “Memory Stick” – Memory Photo recording

350 351

You can record still images on a “Memory Stick.”

You can select the FIELD or FRAME mode in still image recording. Your camcorder compensates for camera-shake when recording moving subjects in the FIELD mode. Your camcorder records in high quality in the FRAME mode. Select the FIELD or FRAME in the menu settings (p. 217). (The default setting is FIELD.)

Before operation

Insert a “Memory Stick” into your camcorder.

- (1) Set the POWER switch to MEMORY. Make sure that the LOCK switch is set to the left (unlock) position.
- (2) Keep pressing PHOTO lightly until the desired still image appears. The green ● mark stops flashing, then lights up. The brightness of the image and focus are adjusted and fixed while your camcorder targets at the middle of the image. Recording does not start yet.
- (3) Press PHOTO deeper. The shutter sounds, and the image becomes still. Recording is complete when the bar scroll indicator disappears. The image when you pressed PHOTO deeper will be recorded on the “Memory Stick.”

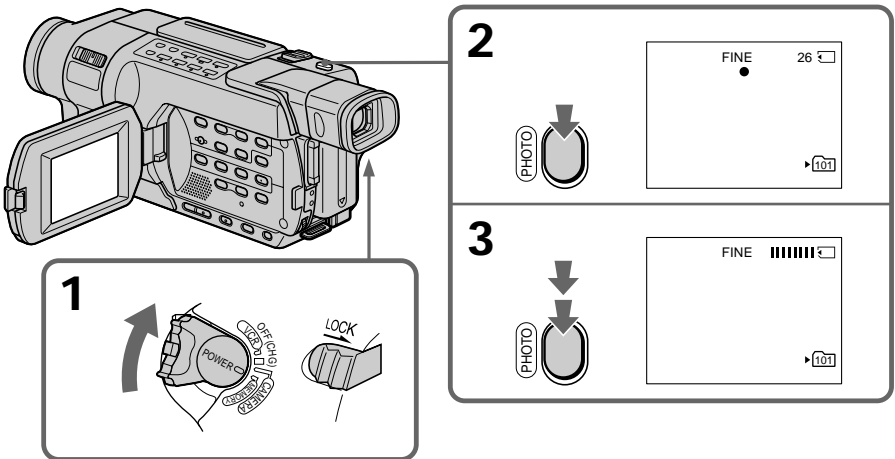

You can record still images on a “Memory Stick” in CAMERA mode.

For details, see page 53.

Recording still images on a "Memory Stick" - Memory Photo recording

Notes

- When recording fast-moving subjects in the FRAME mode, the recorded image appears blurry.
- When recording in the FRAME mode, your camcorder may not correct camera-shake. We recommend that you shoot objects with a tripod.

When the POWER switch is set to MEMORY

The following functions do not work:

- Wide mode
- Fader
- Super NightShot
- Color Slow Shutter
- Picture effect
- Digital effect
- Titles

While you are recording a still image

You can neither turn off the power nor press PHOTO.

When you press PHOTO on the Remote Commander

Your camcorder immediately records the image that is on the screen when you press the button.

When you press PHOTO lightly in step (2)

The image momentarily flickers. This is not a malfunction.

Data code

The data code (date/time or various settings when recorded) are not displayed while recording. However, they are recorded automatically onto the "Memory Stick."
To display the data code, press DATA CODE on the Remote Commander during playback.

Recording still images on a "Memory Stick" - Memory Photo recording

Screen indicators during still image recording

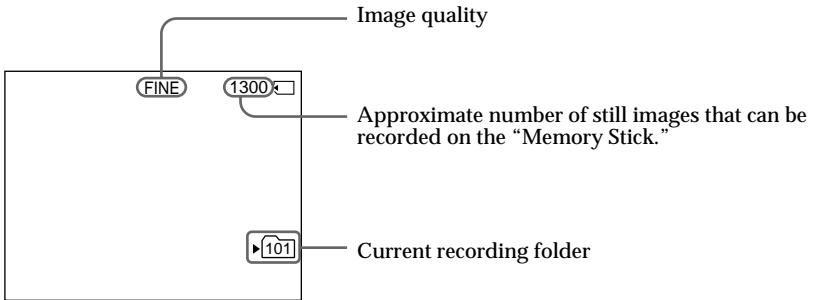

Notes

- The current recording folder indicator shows the folder in which images are recorded.
- The number of images can be recorded on a "Memory Stick" is displayable up to 9999. Even if the "Memory Stick" has a capacity of 10 000 images or more, it is still displayed as >9999.

The indication of the number of recordable still images

Depending on the image quality setting and the complexity of the subject, the indication of the remaining number of recordable still images may not change even after you record an image.



In CAMERA or VCR mode

- The current recording folder indicator is displayed for about five seconds in the following cases:
 - When a "Memory Stick" is inserted
 - When the POWER switch is set to another position
- The current recording folder indicator is displayed while your camcorder is capturing an image or recording a still image on a "Memory Stick."
The current recording folder indicator takes priority over the 16 BIT indicator (audio mode) when it is displayed.

Recording still images on a "Memory Stick" - Memory Photo recording

Self-timer memory photo recording

You can record still images on "Memory Stick"s with the self-timer. You can also use the Remote Commander for this operation.

- (1) Set the POWER switch to MEMORY. Make sure that the LOCK switch is set to the left (unlock) position.
- (2) Press MENU to display the menu settings.
- (3) Turn the SEL/PUSH EXEC dial to select SELFTIMER in , then press the dial.
- (4) Turn the SEL/PUSH EXEC dial to select ON, then press the dial.
- (5) Press MENU to make the menu settings disappear.
The  (self-timer) indicator appears on the screen.
- (6) Press PHOTO deeper.

Self-timer starts counting down from 10 with a beep. In the last two seconds of the countdown, the beep gets faster, then recording starts automatically.

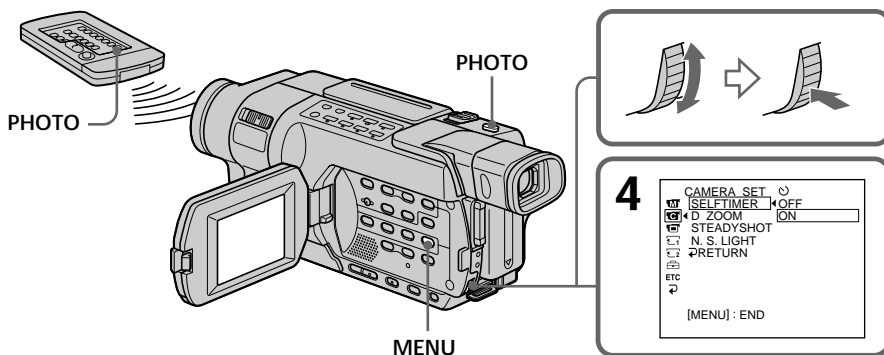

To cancel self-timer

Set SELFTIMER to OFF in the menu settings while your camcorder is in the standby mode. You cannot cancel self-timer with the Remote Commander.

Note

The self-timer is automatically canceled when:

- Self-timer recording is finished.
- The POWER switch is set to OFF (CHG) or VCR.

Recording images from a tape as still images

350 **351**

Your camcorder can read moving picture data recorded on a tape in the Digital8  system, and record it as a still image on a “Memory Stick.”

Your camcorder can also capture moving picture data through the input connector and record it as a still image on a “Memory Stick.”

Before operation

- Insert a tape recorded in the Digital8  system into your camcorder.
- Insert a “Memory Stick” into your camcorder.

- (1) Set the POWER switch to VCR.
- (2) Press . Moving pictures recorded on the tape are played back.
- (3) Keep pressing PHOTO lightly until the picture from the tape freezes. The CAPTURE indicator appears on the screen. Recording does not start yet. To change the still image, release PHOTO and select a still image again.
- (4) Press PHOTO deeper. Recording is complete when the bar scroll indicator disappears. The image displayed on the screen when you pressed PHOTO deeper will be recorded on the “Memory Stick.” Playback of the tape is resumed.

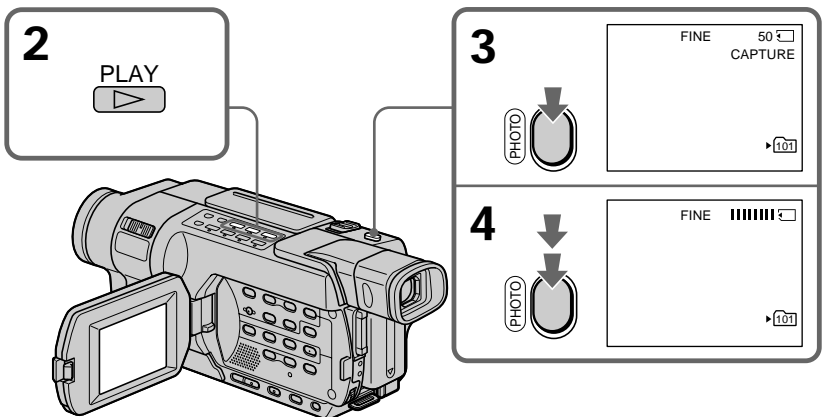

Recording images from a tape as still images

When the access lamp is lit or flashing

Do not shake or knock the unit. Also do not turn the power off, eject the "Memory Stick" or remove the battery pack. Otherwise, image data may become damaged.

If the indicator appears on the screen

The inserted "Memory Stick" is incompatible with your camcorder because its format does not conform with your camcorder. Check the format of the "Memory Stick."

If you press PHOTO lightly in the playback mode

Your camcorder stops momentarily.

Sound recorded on a tape

You cannot record audio from a tape.

When you press PHOTO on the Remote Commander

Your camcorder immediately records the image that is on the screen when you press the button.

Titles superimposed on tapes

You cannot record titles on the "Memory Stick." However, you can record titles which have already been recorded on tapes.

Data code

The data code (date/time) when it is recorded on the "Memory Stick" from a tape is recorded.

The data code (various settings) is not recorded.

The data codes recorded on a tape are not recorded.

While recording images from a tape as still images

The image is recorded in the FRAME mode automatically even if you select FIELD in the menu settings.

Recording folder

You cannot change the recording folder.

The recording folder you selected when the POWER switch was set to MEMORY is used (p. 162).

Recording images from a tape as still images

Recording a still image from external equipment

Before operation

Set DISPLAY to LCD in the menu settings. (The default setting is LCD.) (p. 222)

- (1) Set the POWER switch to VCR.
- (2) Play back the recorded tape, or turn the TV on to see the desired program.
The picture from TV or VCR appears on the screen of your camcorder.
- (3) Follow steps (3) and (4) on page 136.

Using the A/V connecting cable

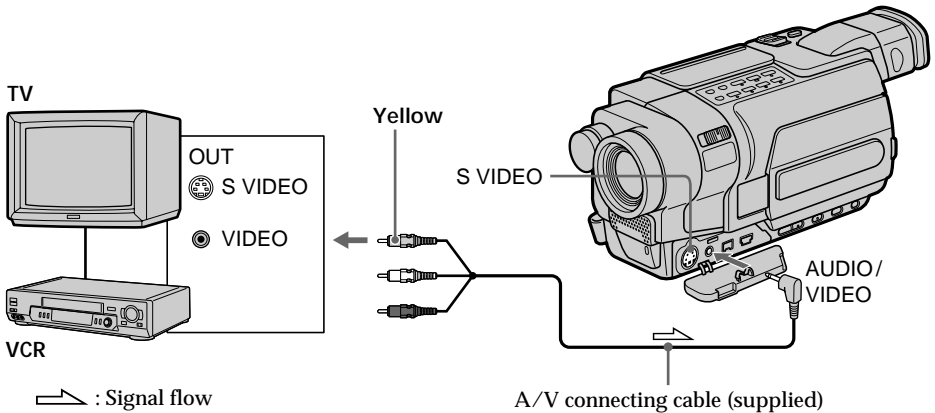

Connect the yellow plug of the A/V connecting cable to the video output jack on the VCR or the TV.

If your TV or VCR has an S video jack

Pictures can be reproduced more faithfully by using an S video cable (optional).

With this connection, you do not need to connect the yellow (video) plug of the A/V connecting cable.

Connect an S video cable (optional) to the S video jacks of both your camcorder and the TV or VCR.

Recording images from a tape as still images

Using the i.LINK cable

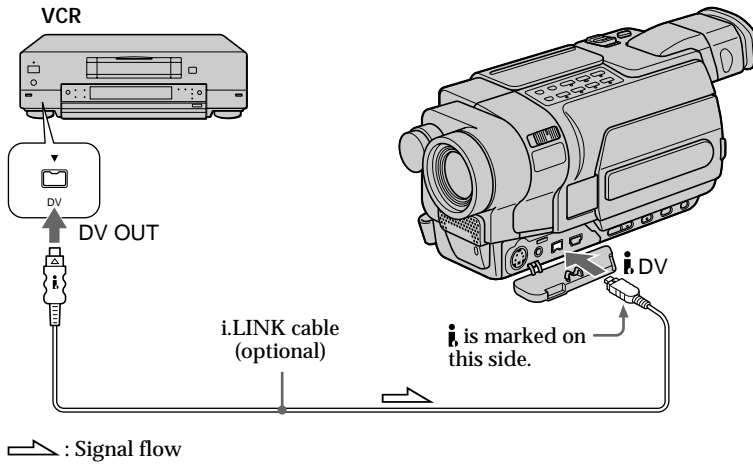

Note

In the following instances, "❑ REC ERROR" is displayed and recording is not possible. Record distortion-free images:

- When recording on a tape in a poor recording state, for example, on a tape that has been repeatedly used for dubbing.
- Between scenes or in the various playback modes on the tape recorded in Hi8 **Hi8**/standard 8 mm **8** system.
- When attempting to input images that are distorted due to poor radio wave reception when a TV tuner unit is in use.

Superimposing a still image in the “Memory Stick” on an image

- MEMORY MIX

350 351

You can superimpose a still image you have recorded on the “Memory Stick” on the moving picture you are recording. You can record the superimposed images on a tape or a “Memory Stick” as still images.

M. CHROM (memory chroma key)

You can swap only the blue area of a still image, such as an illustration or a frame, with a moving picture.

M. LUMI (memory luminance key)

You can swap a brighter area of a still image, such as a handwritten illustration or a title, with a moving picture. Recording a title on the “Memory Stick” before a trip or event is recommended.

C. CHROM (camera chroma key)

You can superimpose a moving picture on a still image such as an image that can be used as background. Shoot the subject against a blue background. Only the blue area of the moving image will be swapped with the still image.

M. OVERLAP * (memory overlap)

You can make a moving picture fade in on top of a still image recorded on the “Memory Stick” as the overlap function.

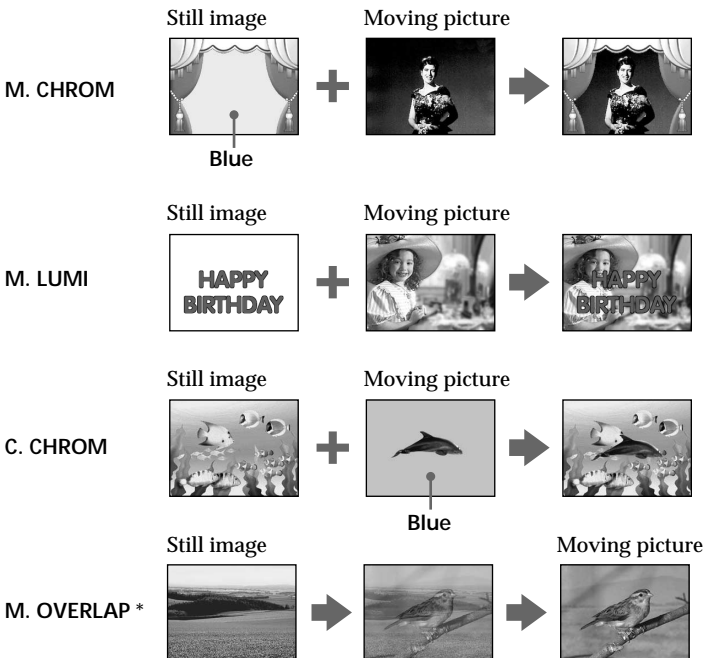

* The superimposed image using M. OVERLAP can be recorded on tapes only.

Superimposing a still image in the "Memory Stick" on an image - MEMORY MIX

Recording superimposed images on a tape

Before operation

- Insert a tape for recording into your camcorder.
- Insert a "Memory Stick" containing still images into your camcorder.

(1) Set the POWER switch to CAMERA.

(2) In the standby mode, press MEMORY MIX.

The first recorded image appears in the bottom-right corner of the screen as a thumbnail image. The last image that is used in MEMORY MIX will be displayed next time.

(3) Press MEMORY+/- to select the still image you want to superimpose.

- : To see the previous image

+ : To see the next image

(4) Turn the SEL/PUSH EXEC dial to select the desired mode.

The mode changes as follows:

M. CHROM ↔ M. LUMI ↔ C. CHROM ↔ M. OVERLAP

(5) Press the SEL/PUSH EXEC dial.

The still image overlaps with the picture on the screen.

(6) Turn the SEL/PUSH EXEC dial to adjust the effect.

M. CHROM - The degree of the blue areas in the still image which is to be swapped with a moving picture

M. LUMI - The brightness of the area in the still image which is to be swapped with a moving picture

C. CHROM - The degree of the blue areas in the moving picture which is to be swapped with a still image

M. OVERLAP - No adjustment necessary

The fewer bars there are on the screen, the stronger the effect becomes.

(7) Press START/STOP to start recording.

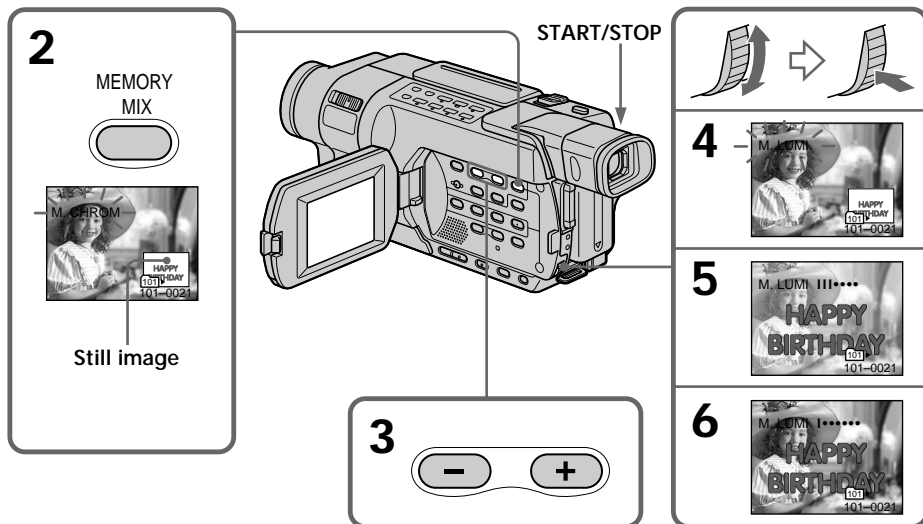

Superimposing a still image in the “Memory Stick” on an image - MEMORY MIX

To change the still image to superimpose

Do either of the following:

- Press MEMORY+/- before step (7).
- Press the SEL/PUSH EXEC dial before step (7), and repeat the procedure from step (3).

To change the mode setting

Press the SEL/PUSH EXEC dial before step (7), and repeat the procedure from step (4).

To cancel MEMORY MIX

Press MEMORY MIX.

Notes

- You cannot use MEMORY MIX for moving pictures recorded on a “Memory Stick.”
- When the overlapping still image has a large amount of white, the thumbnail image of the picture may not be clear.

Image data modified on your computer or shot with other equipment

You may not be able to play modified images back with your camcorder.

When you select M. OVERLAP

You cannot change the still image or the mode setting.

During recording

You cannot change the mode setting.

Sample images

- The “Memory Stick” supplied with your camcorder is already stored with the protected 20 images **351** :
 - For M. CHROM: 18 images (such as a frame) 101-0001 to 101-0018
 - For C. CHROM: two images (such as a background) 101-0019 to 101-0020
- The CD-ROM supplied with your camcorder is already stored with 20 images (p. 191):
 - For M. CHROM: 18 images (such as a frame) DSC 00001 to DSC 00018
 - For C. CHROM: two images (such as a background) DSC 00019 to DSC 00020

Recording superimposed images on a “Memory Stick” as a still image

Before operation

Insert a “Memory Stick” containing still images into your camcorder.

(1) Set the POWER switch to MEMORY. Make sure that the LOCK switch is set to the left (unlock) position.

(2) Press MEMORY MIX.

The first recorded image appears in the bottom-right corner of the screen as a thumbnail image. The last image that is used in MEMORY MIX will be displayed next time.

(3) Press MEMORY+/- to select the still image you want to superimpose.

- : To see the previous image

+ : To see the next image

(4) Turn the SEL/PUSH EXEC dial to select the desired mode.

The mode changes as follows:

M. CHROM ↔ M. LUMI ↔ C. CHROM

(5) Press the SEL/PUSH EXEC dial.

The still image overlaps with the picture on the screen.

(6) Turn the SEL/PUSH EXEC dial to adjust the effect.

M. CHROM – The degree of the blue areas in the still image which is to be swapped with a moving picture

M. LUMI – The brightness of the area in the still image which is to be swapped with a moving picture

C. CHROM – The degree of the blue areas in the moving picture which is to be swapped with a still image

The fewer bars there are on the screen, the stronger the effect becomes.

(7) Press PHOTO deeply to start recording.

The image displayed on the screen will be recorded on a “Memory Stick.” Recording is complete when the bar scroll indicator disappears.

Superimposing a still image in the "Memory Stick" on an image - MEMORY MIX

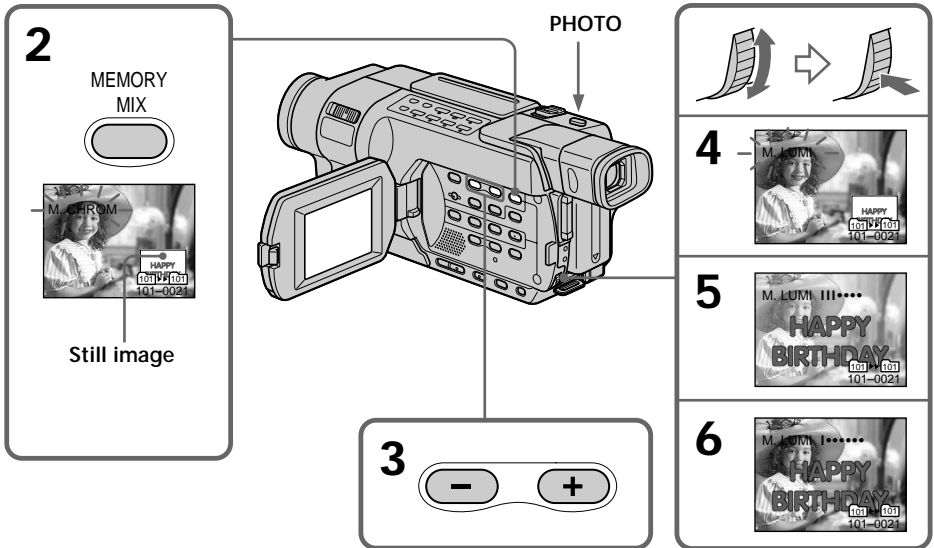

To change the still image to superimpose

Do either of the following:

- Press MEMORY+/- before step (7).
- Press the SEL/PUSH EXEC dial before step (7), and repeat the procedure from step (3).

To change the mode setting

Press the SEL/PUSH EXEC dial before step (7), and repeat the procedure from step (4).

To cancel MEMORY MIX

Press MEMORY MIX.

Superimposing a still image in the “Memory Stick” on an image - MEMORY MIX

Notes

- You cannot use MEMORY MIX for moving pictures recorded on a “Memory Stick.”
- When the overlapping still image has a large amount of white, the thumbnail image of the picture may not be clear.

Image data modified on your computer or shot with other equipment

You may not be able to play modified images back with your camcorder.

During recording

You cannot change the mode setting.

When using MEMORY MIX in MEMORY mode

The PROGRAM AE function does not work. (The indicator flashes.)

Recording folder

You cannot change the recording folder.

The recording folder you selected when the POWER switch was set to MEMORY is used (p. 162).

Sample images

- The “Memory Stick” supplied with your camcorder is already stored with the protected 20 images **351** :
 - For M. CHROM: 18 images (such as a frame) 101-0001 to 101-0018
 - For C. CHROM: two images (such as a background) 101-0019 to 101-0020
- The CD-ROM supplied with your camcorder is already stored with 20 images (p. 191):
 - For M. CHROM: 18 images (such as a frame) DSC 00001 to DSC 00018
 - For C. CHROM: two images (such as a background) DSC 00019 to DSC 00020

Recording moving pictures on a “Memory Stick” – MPEG movie recording

350 **351**

You can record moving pictures with sound on a “Memory Stick.”

The picture and sound are recorded up to the full capacity of a “Memory Stick” (MPEG MOVIE EX).

Before operation

Insert a “Memory Stick” into your camcorder.

(1) Set the POWER switch to MEMORY. Make sure that the LOCK switch is set to the left (unlock) position.

(2) Press START/STOP. Your camcorder starts recording. The camera recording lamp lights up.

The picture and sound are recorded up to the capacity of a “Memory Stick.”

For more information about recording time, see page 131.

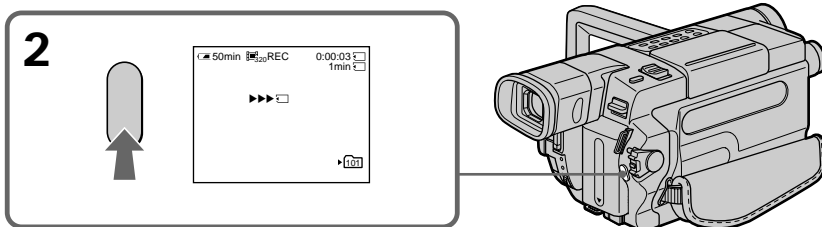

To stop recording

Press START/STOP.

Notes

- Sound is recorded in monaural.
- The moving picture files recorded on your camcorder cannot be played back on other camcorders without the folder creation function.

When the POWER switch is set to MEMORY

The following functions do not work:

- Wide mode
- Super NightShot
- Color Slow Shutter
- Fader
- Picture effect
- Digital effect
- Titles

Recording moving pictures on a "Memory Stick" - MPEG movie recording

When using an external flash (optional)

Turn the power of the external flash off when recording moving pictures on a "Memory Stick."

Otherwise, the charging sound for the flash may be recorded.

Data code

The data code (date/time) are not displayed while recording. However, they are automatically recorded onto the "Memory Stick."

To display the data code (date/time), press DATA CODE on the Remote Commander during playback.

The data code (various settings) cannot be recorded.

During recording on "Memory Stick"

Do not eject the cassette tape from your camcorder. While ejecting the tape, the sound is recorded on the "Memory Stick."

Recording moving pictures on a "Memory Stick" - MPEG movie recording

Screen indicators during MPEG movie recording

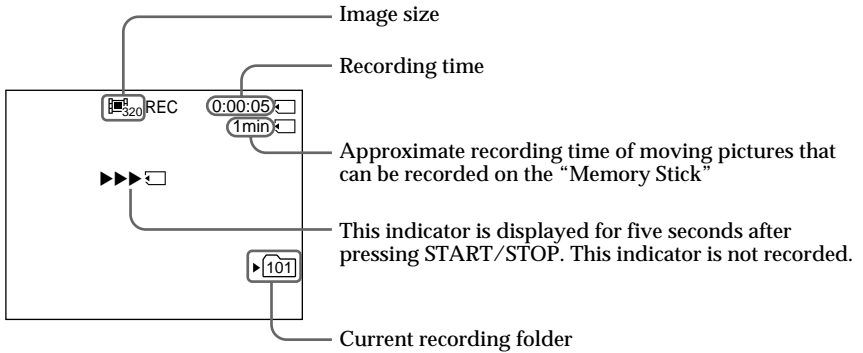

Note

The current recording folder indicator indicates the folder in which images are recorded.



In VCR mode

- The current recording folder indicator is displayed for about five seconds in the following cases:
 - When a "Memory Stick" is inserted
 - When the POWER switch is set to another position
- The current recording folder indicator is displayed while your camcorder is recording a moving picture on a "Memory Stick."

Recording moving pictures on a "Memory Stick" - MPEG movie recording

Self-timer MPEG movie recording

You can record moving pictures on a "Memory Stick" with the self-timer. You can also use the Remote Commander for this operation.

- (1) Set the POWER switch to MEMORY. Make sure that the LOCK switch is set to the left (unlock) position.
- (2) Press MENU to display the menu settings.
- (3) Turn the SEL/PUSH EXEC dial to select SELFTIMER in , then press the dial.
- (4) Turn the SEL/PUSH EXEC dial to select ON, then press the dial.
- (5) Press MENU to make the menu settings disappear.
The  (self-timer) indicator appears on the screen.
- (6) Press START/STOP.

Self-timer starts counting down from 10 with a beep. In the last two seconds of the countdown, the beep gets faster, then recording starts automatically.

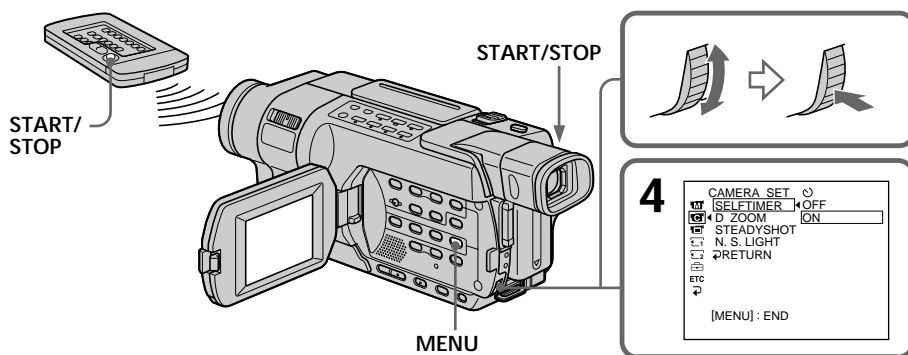

To stop the countdown

Press START/STOP. To restart the countdown, press START/STOP again.

To cancel self-timer

Set SELFTIMER to OFF in the menu settings in the standby mode. You cannot cancel self-timer with the Remote Commander.

Note

The self-timer is automatically canceled when:

- Self-timer recording is finished.
- The POWER switch is set to OFF (CHG) or VCR.

Recording pictures from a tape as a moving picture

350 351

Your camcorder can read moving picture data recorded on tapes and record it as a moving picture on a "Memory Stick." Your camcorder can also capture moving picture data through the input connector and record it as a moving picture on a "Memory Stick."

The picture and sound are recorded up to the full capacity of a "Memory Stick" (MPEG MOVIE EX).

Before operation

- Insert a recorded tape into your camcorder.
- Insert a "Memory Stick" into your camcorder.

- (1) Set the POWER switch to VCR.
- (2) Press **▶**. The picture recorded on the tape is played back.
And press **⏸** at the scene where you want to start recording from.
- (3) Press START/STOP on your camcorder.
Images and sound are recorded up to the remaining capacity of the "Memory Stick." For more information about recording time, see page 131.

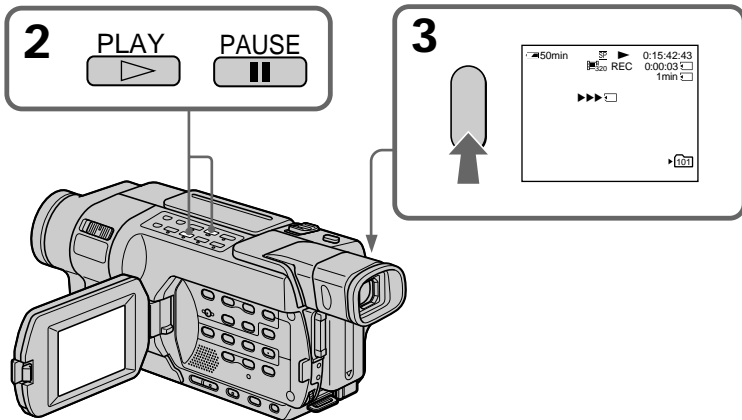

To stop recording

Press START/STOP.

Recording pictures from a tape as a moving picture

Notes

- Sound recorded in 48 kHz is converted to 32 kHz sound when recording pictures from a tape to a "Memory Stick."
- Sound recorded in stereo is converted to monaural sound when recording from a tape.
- The moving picture files recorded on your camcorder cannot be played back on other camcorders without the folder creation function.

When the access lamp is lit or flashing

Do not shake or knock your camcorder. Also, do not set the POWER switch to OFF, eject a "Memory Stick" or remove the battery pack. Otherwise, image data may become damaged.

Titles

You cannot record titles on the "Memory Stick." However, you can record titles which have already been recorded on tapes.

Data code

The data code (date/time) when it is recorded on the "Memory Stick" from a tape is recorded.

The data code (various settings) is not recorded.



The data codes recorded on a tape are not recorded.

If "AUDIO ERROR" is displayed

Sound that cannot be recorded by your camcorder has been recorded on the tape.

Connect external equipment with the A/V connecting cable and input images played back on it (p. 152).

The picture may be recorded on the "Memory Stick" incorrectly if:

- You turn the POWER switch during recording.
- You press any video control buttons during recording.
- Between the scenes recorded in the Digital8  system and in the Hi8 /standard 8 mm  system.
- A blank portion of the tape.
- The scenes when the input signal is cut off.

Recording folder

You cannot change the recording folder.

The recording folder you selected when the POWER switch was set to MEMORY is used (p. 162).

Recording pictures from a tape as a moving picture

Recording a moving picture from external equipment

Before operation

Set DISPLAY to LCD in the menu settings. (The default setting is LCD.)

- (1) Set the POWER switch to VCR.
- (2) Play back the recorded tape, or turn the TV on to see the desired program.
The picture of the other equipment is displayed on the screen or viewfinder.
- (3) Press START/STOP at the point where you want to start recording from.
Images and sound are recorded up to the remaining capacity of the "Memory Stick." For more information about recording time, see page 131.

Using the A/V connecting cable

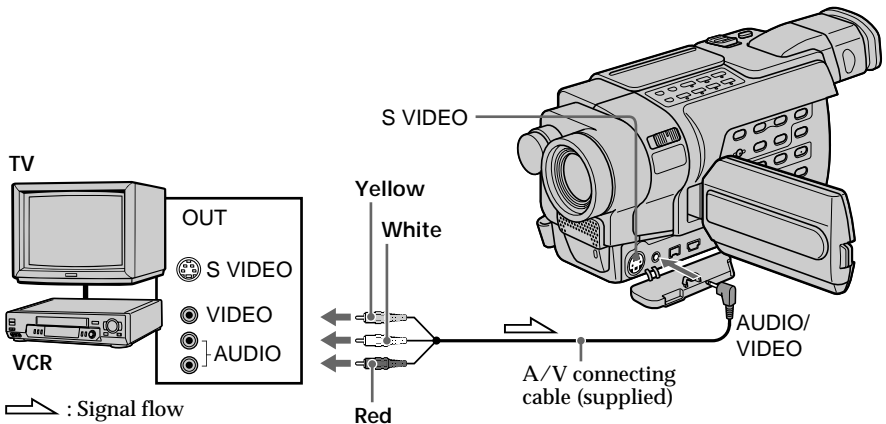

If your VCR or TV is a monaural type

Connect the yellow plug of the A/V connecting cable to the video output jack and the white or the red plug to the audio output jack on the VCR or the TV. When the white plug is connected, the left channel audio is output, and when the red plug is connected, the right channel audio is output.

If your TV or VCR has an S video jack

Pictures can be reproduced more faithfully by using an S video cable (optional).

With this connection, you do not need to connect the yellow (video) plug of the A/V connecting cable.

Connect an S video cable (optional) to the S video jacks of both your camcorder and the TV or VCR.

Recording pictures from a tape as a moving picture

Using the i.LINK cable

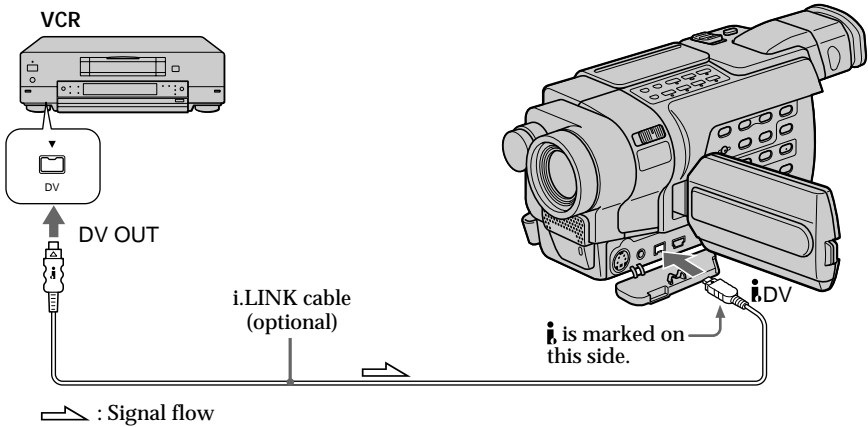

Note

In the following instances, recording is discontinued or "□ REC ERROR" is displayed and image data is not saved:

- When recording on a tape in a poor recording state, for example, on a tape that has been repeatedly used for dubbing.
- Between scenes or in the various playback modes on the tape recorded in Hi8 **Hi8**/standard 8 mm **8** system.
- When attempting to input images that are distorted due to poor radio wave reception when a TV tuner unit is in use.
- When the input signal is cut off.

During recording on "Memory Stick"

Do not eject the cassette tape from your camcorder. During ejecting of the tape, the sound is recorded on the "Memory Stick."

Interval Photo recording

350 **351**

You can take photos successively at regular intervals. You can achieve an excellent recording for flowering, emergence, etc., with this function. Each recording makes each still image file.

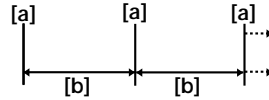



[a]: Recording

[b]: Interval time (INTERVAL)

Before operation

Insert a "Memory Stick" into your camcorder.

- (1) Set the POWER switch to MEMORY. Make sure that the LOCK switch is set to the left (unlock) position.
- (2) Press MENU to display the menu settings.
- (3) Turn the SEL/PUSH EXEC dial to select INT.R -STL in , then press the dial (p. 218).
- (4) Turn the SEL/PUSH EXEC dial to select SET, then press the dial.
- (5) Set INTERVAL.
 - ① Turn the SEL/PUSH EXEC dial to select INTERVAL, then press the dial.
 - ② Turn the SEL/PUSH EXEC dial to select the desired interval time, then press the dial.

The time: 1MIN ↔ 5MIN ↔ 10MIN
 - ③ Turn the SEL/PUSH EXEC dial to select  RETURN, then press the dial.
- (6) Turn the SEL/PUSH EXEC dial to select ON, then press the dial.
- (7) Press MENU to make the menu settings disappear. The INTERVAL MEM STILL indicator flashes.
- (8) Press PHOTO deeper to start interval photo recording. The INTERVAL MEM STILL indicator lights up.

Recording edited pictures as a moving picture – Digital program editing (on a “Memory Stick”)

350 **351**

You can duplicate selected scenes (programs) for editing onto a “Memory Stick.” The picture and sound are recorded up to the full capacity of a “Memory Stick” (MPEG MOVIE EX).

Before operation

- Insert a recorded tape into your camcorder.
- Insert a “Memory Stick” into your camcorder.

Making the program

- (1) Set the POWER switch to VCR on your camcorder.
- (2) Press MENU to display the menu settings.
- (3) Turn the SEL/PUSH EXEC dial to select VIDEO EDIT in **EDIT**, then press the dial.
- (4) Turn the SEL/PUSH EXEC dial to select MEMORY, then press the dial.
- (5) Turn the SEL/PUSH EXEC dial to select the desired image size in IMAGESIZE, then press the dial.
- (6) Search for the beginning of the first scene you want to insert using the video control buttons, then pause playback.
You can fine-adjust one frame at a time with EDITSEARCH.
- (7) Turn the SEL/PUSH EXEC dial to select MARK, then press the dial.
The IN point of the first program is set, and the upper part of the program mark changes to light blue.
- (8) Search for the end of the first scene you want to insert using the video control buttons, then pause playback.
- (9) Press the SEL/PUSH EXEC dial.
The OUT point of the first program is set, then the lower part of the program mark changes to light blue.
- (10) Repeat steps (6) to (9) to set other programs.
When the program is set, the program mark changes to light blue.
You can set 20 programs in maximum.

Recording edited pictures as a moving picture - Digital program editing (on a "Memory Stick")

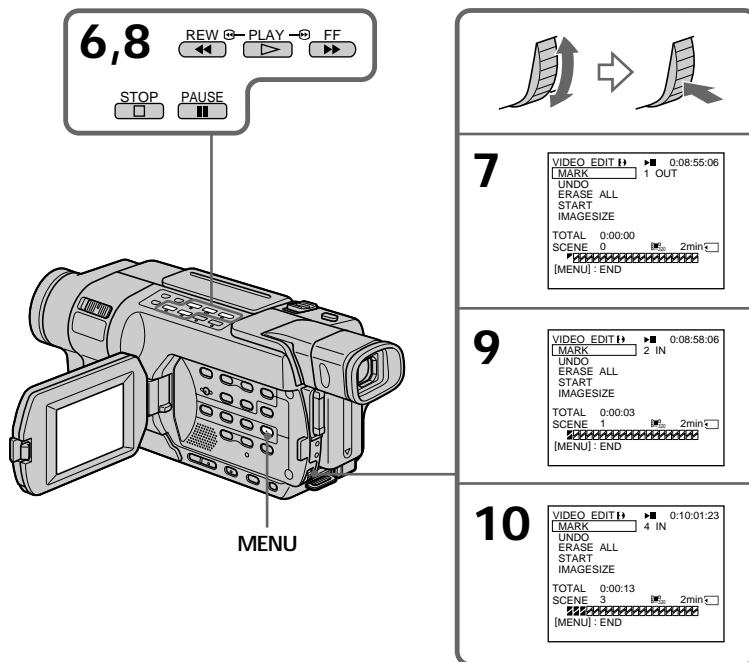

Erasing the program you have set

Erase OUT first and then IN of the last program.

- (1) Turn the SEL/PUSH EXEC dial to select UNDO, then press the dial.
- (2) Turn the SEL/PUSH EXEC dial to select EXECUTE, then press the dial.
The last set program mark flashes, then the setting is canceled.

To cancel erasing

Select RETURN in step (2).

Recording edited pictures as a moving picture - Digital program editing (on a "Memory Stick")

Erasing all programs

- (1) Select VIDEO EDIT in the menu setting. Turn the SEL/PUSH EXEC dial to select MEMORY, then press the dial.
- (2) Select ERASE ALL. Turn the SEL/PUSH EXEC dial to select EXECUTE, then press the dial.
All the program marks flash, then the settings are canceled.

To cancel erasing all programs

Select RETURN in step (2).

To cancel a program you have set

Press MENU.

The program is stored in memory until the tape is ejected.

Notes

- Digital program editing does not work with tapes recorded in the Hi8 Hi8/standard 8 mm 8 system.
- You cannot dub the title or display indicators. However, you can dub the title which has already been recorded on a tape.
- You cannot operate recording during Digital program editing on a "Memory Stick."
- The moving picture files recorded on your camcorder cannot be played back on other camcorders without the folder creation function.

You cannot set IN or OUT to the following portions of the tape:

- A portion recorded in Hi8 Hi8/standard 8 mm 8 system
- A blank portion of the tape

The total time may not be displayed correctly in the following cases:

- The tape is recorded in the Hi8 Hi8/standard 8 mm 8 system.
- There is a blank portion between IN and OUT on the tape.

While making a program

If you eject the cassette, NOT READY appears on the screen. The program will be erased.

Recording folder

You cannot change the recording folder.

The recording folder you selected when the POWER switch was set to MEMORY is used (p. 162).

Recording edited pictures as a moving picture - Digital program editing (on a "Memory Stick")

Performing the program (Dubbing onto a "Memory Stick")

- (1) Select VIDEO EDIT in the menu setting. Turn the SEL/PUSH EXEC dial to select MEMORY, then press the dial.
- (2) Select START. Turn the SEL/PUSH EXEC dial to select EXECUTE, then press the dial.

Your camcorder searches for the beginning of the first program, then starts dubbing.

The program mark flashes.

The SEARCH indicator appears during search, the EDITING indicator and the REC indicator appear during writing of data on your camcorder, and the REC indicator appears during dubbing on the "Memory Stick."

The program mark changes to light blue after dubbing is complete.

When the dubbing ends, your camcorder automatically stops.

Then the display returns to the VIDEO EDIT initial screen.

To stop dubbing during editing

Press ■ using the video control buttons.

The program you made is recorded on a "Memory Stick" up to the place where you press ■.

To end the Digital program editing

Press MENU.

Note

A blank portion may not be recorded on the "Memory Stick" correctly.

NOT READY appears on the screen when:

- The program to operate Digital program editing has not been made.
- The "Memory Stick" is not inserted.
- The write-protect tab on the "Memory Stick" is set to LOCK.

When the "Memory Stick" does not have enough space to record

The LOW MEMORY indicator appears on the screen. However, you can record pictures up to the time indicated.

When available recording time is not left on the "Memory Stick"

"MEMORY FULL" appears.

Setting up a folder

350 351

You can create folders in a "Memory stick" and group recorded images in them. You can group images by selecting a folder for each recording, for convenient later reference.

Images are recorded in the 101MSDCF folder unless other folders have been created. You can create folders up to 999MSDCF.

Before operation

Insert a "Memory stick" into your camcorder.

Creating a new folder

- (1) Set the POWER switch to MEMORY. Make sure that the LOCK switch is set to the left (unlock) position.
- (2) Press MENU to display the menu settings.
- (3) Turn the SEL/PUSH EXEC dial to select NEW FOLDER in , then press the dial.
- (4) Turn the SEL/PUSH EXEC dial to select ADD, then press the dial.
A new folder is created. The numeric part of the folder name is one larger than that of the last created folder. The image you record next time is stored in this newly created folder.

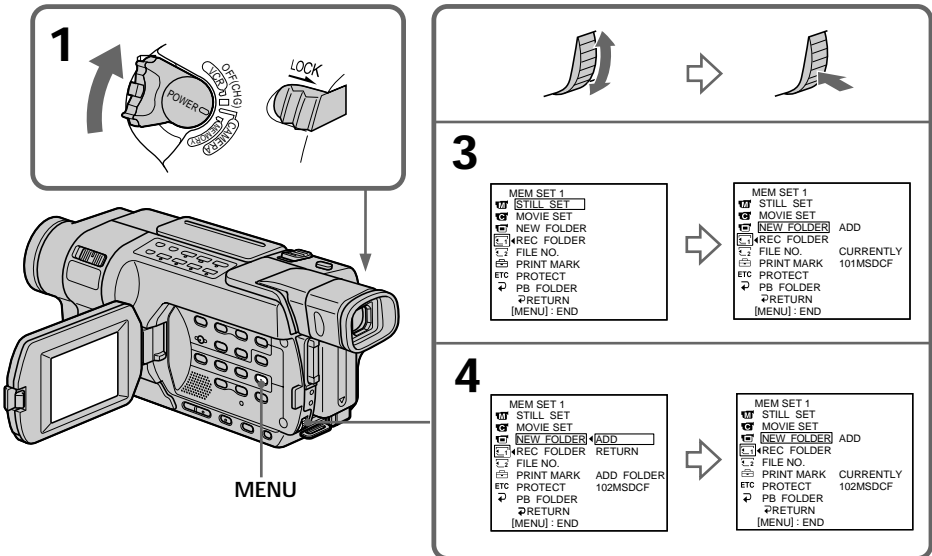

1

2

3

4

MEM SET 1
 STILL SET
 MOVIE SET
 NEW FOLDER
 REC FOLDER
 FILE NO.
 PRINT MARK
 ETC PROTECT
 PB FOLDER
 RETURN
 [MENU]: END

MEM SET 1
 STILL SET
 MOVIE SET
 NEW FOLDER ADD
 REC FOLDER
 FILE NO.
 PRINT MARK
 ETC PROTECT
 PB FOLDER
 RETURN
 [MENU]: END

MEM SET 1
 STILL SET
 MOVIE SET
 NEW FOLDER ADD
 REC FOLDER
 FILE NO.
 PRINT MARK
 ETC PROTECT
 PB FOLDER
 RETURN
 [MENU]: END

MEM SET 1
 STILL SET
 MOVIE SET
 NEW FOLDER ADD
 REC FOLDER
 FILE NO.
 PRINT MARK
 ETC PROTECT
 PB FOLDER
 RETURN
 [MENU]: END

MENU

To cancel creating a new folder

Press  RETURN in step (4).

Setting up a folder

Notes

- You cannot create folders in the following cases:
 - No “Memory Stick” is inserted.
 - The write-protect tab on the “Memory Stick” is set to LOCK.
 - Folders have already been created in the “Memory Stick” up to the limit (up to folder 999MSDCF), or a folder named 999MSDCF already exists.
- If you try to record an image in a folder that already contains 9999 images, or the folder contains an image named Dsc09999.jpg or Mov09999.mpg, a new folder is created automatically and the image is recorded in there.
- Folders cannot be deleted with your camcorder.

The folder in which images are recorded

Images will be recorded in the same folder until you select another folder or create a new folder.

Setting up a folder

Selecting a recording folder

- (1) Set the POWER switch to MEMORY. Make sure that the LOCK switch is set to the left (unlock) position.
- (2) Press MENU to display the menu settings.
- (3) Turn the SEL/PUSH EXEC dial to select REC FOLDER in , then press the dial.
- (4) Turn the SEL/PUSH EXEC dial to select the desired folder, then press the dial. The image you record next time is recorded in this folder.

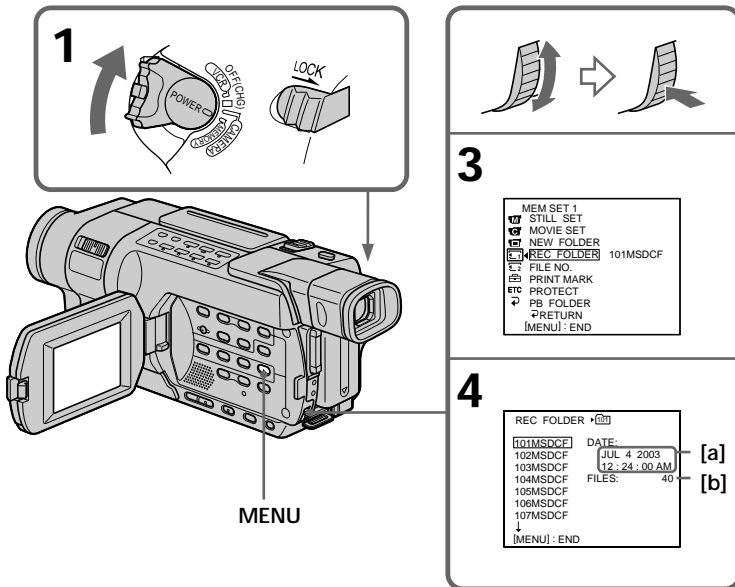

- [a]: The date when the folder is created
[b]: The number of the files stored in the folder

To cancel selecting a recording folder

Press  RETURN in step (3).

Note

You cannot select a recording folder in the following cases:

- No "Memory Stick" is inserted.
- The write-protect tab on the "Memory Stick" is set to LOCK.
- Folder 100 MSDCF (The folder is only for playback).

Viewing still images – Memory Photo playback

350 351

You can play back still images recorded on a “Memory Stick.” By selecting the index screen, you can also play back six images including moving pictures at a time arranged in the same order they are in the “Memory Stick.”

Before operation

Insert a “Memory Stick” into your camcorder.

- (1) Set the POWER switch to MEMORY or VCR. Make sure that the LOCK switch is set to the left (unlock) position.
- (2) Press MEMORY PLAY. The last recorded image is displayed.
- (3) Press MEMORY +/- to select the desired still image.
 - : To see the previous image
 - + : To see the next image

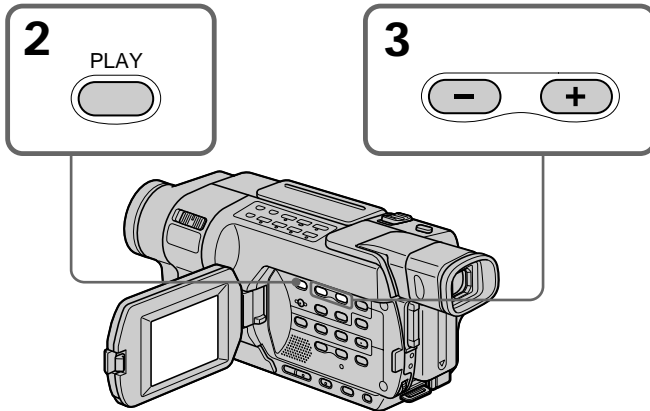

To stop memory photo playback

Press MEMORY PLAY.

Note

You may not be able to play back images with your camcorder:

- When playing back image data modified on your computer.
- When playing back image data shot with other equipment.

Viewing still images – Memory Photo playback

Notes on the file name

- The directory number may not be displayed and only the file name may be displayed if the structure of the directory does not conform to the DCF standard.
- The file name flashes on the screen if the file is corrupted or the file is unreadable.

To play back recorded images on a TV screen

- Before operation, connect your camcorder to the TV with the A/V connecting cable supplied with your camcorder (p. 51).
- When operating memory photo playback on a TV or the LCD screen, image quality may appear to have deteriorated. This is not a malfunction. The image data is as good as ever.
- Turn the audio volume of the TV down before operation, or noise (howling) may be output from the TV speakers.

When there is only one folder on the “Memory Stick” and no image is in it “ NO FILE” appears.

PB (playback) folder

You can select the PB folder only in MEMORY mode.

Screen indicators during still image playback

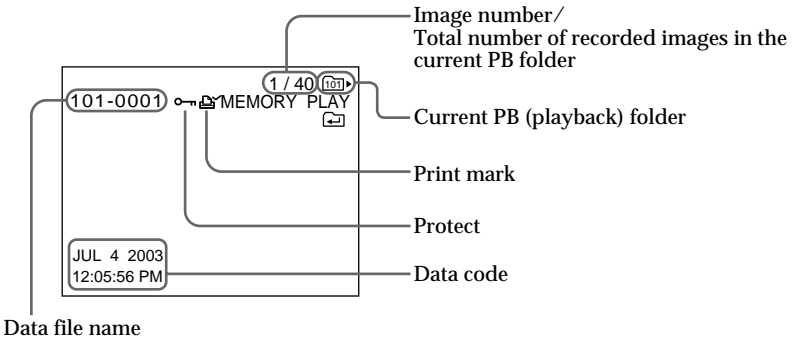

When a “Memory Stick” contains multiple folders

The following marks appear on the first and last images in a folder.

: You can move to the previous folder.

: You can move to the next folder.

: You can move to both the previous and the next folder.

Data code

You can view data code (date/time or various settings when recorded) by pressing DATA CODE on the Remote Commander.

To make the indicators disappear

Press DISPLAY.

Viewing still images – Memory Photo playback

Playing back six recorded images at a time (index screen)

You can play back six recorded images at a time. This function is especially useful when searching for a particular image.

Before operation

Insert a “Memory Stick” into your camcorder.

- (1) Set the POWER switch to MEMORY or VCR. Make sure that the LOCK switch is set to the left (unlock) position.
- (2) Press MEMORY INDEX to display the index screen.

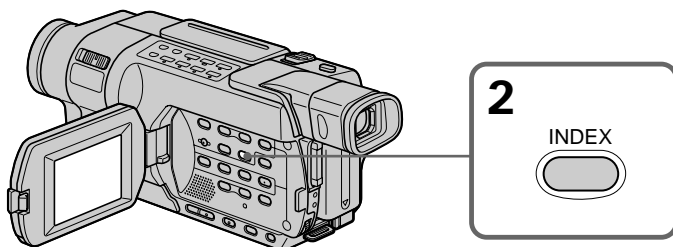

A red ► mark appears above the image that is displayed before changing to the index screen mode.

+ : To see the next images

- : To see the previous images

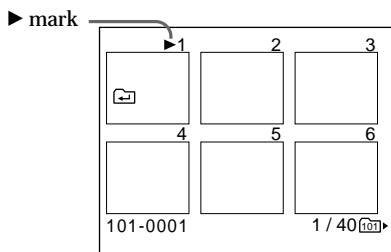

To return to the normal playback screen (single screen)

Press MEMORY +/- to move the ► mark to the image you want to display on full screen, then press MEMORY PLAY.

Note

When displaying the index screen, the number appears above each image. This indicates the order in which images are recorded on the “Memory Stick.” These numbers are different from the data file names (p. 126).

Image data modified on your computer or shot with other equipment

These files are sometimes not displayed on the index screen.

Viewing moving pictures – MPEG movie playback

350 351

You can play back moving pictures recorded on a “Memory Stick.” By selecting the index screen, you can also play back six images including still images at a time arranged in the same order they are in the “Memory Stick.”

Before operation

Insert a “Memory Stick” into your camcorder.

- (1) Set the POWER switch to MEMORY or VCR. Make sure that the LOCK switch is set to the left (unlock) position.
- (2) Press MEMORY PLAY. The last recorded image is displayed.
- (3) Press MEMORY +/- to select the desired moving pictures.
 - : To see the previous picture
 - + : To see the next picture
- (4) Press MPEG ►|| or SEL/PUSH EXEC dial to start playback.
- (5) To adjust the volume, press either of the two buttons on VOLUME.
 - : To turn the volume down
 - + : To turn the volume up

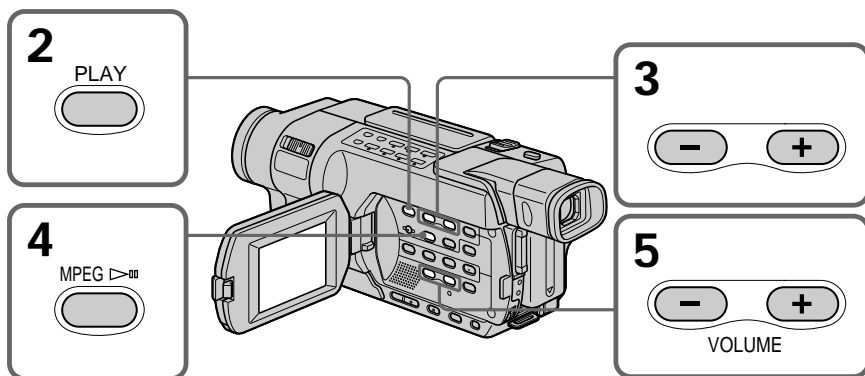

To stop MPEG movie playback

Press MPEG ►|| or SEL/PUSH EXEC dial.

Viewing moving pictures – MPEG movie playback

Note

You may not be able to play back images with your camcorder:

- When playing back image data modified on your computer.
- When playing back image data shot with other equipment.

To play back recorded images on a TV screen

- Before operation, connect your camcorder to the TV with the A/V connecting cable supplied with your camcorder (p. 51).
- Turn the audio volume of the TV down before operation, or noise (howling) may be output from the TV speakers.

When there is only one folder on the “Memory Stick” and no image is in it “ NO FILE” appears.

PB (playback) folder

You can select the PB folder only in MEMORY mode.

Playing back a moving picture from the desired part

The moving picture recorded on a “Memory Stick” is divided into 60 parts. You can select any point and play back the picture.

- (1) Follow steps (1) to (3) on page 166.
- (2) Turn the SEL/PUSH EXEC dial and select the point where you want to start playback, then press the dial.

↑ : To see the next part

↓ : To see the previous part

As you turn the dial to select the playback scene you want, the bar and counter change to indicate the playback point.

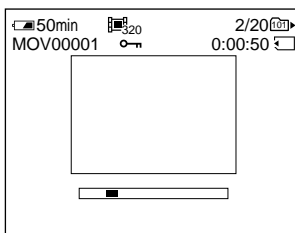

- (3) Press MPEG  or SEL/PUSH EXEC dial to start playback.
- (4) To adjust the volume, press either of the two buttons on VOLUME.
 - : To turn the volume down
 - + : To turn the volume up

To stop MPEG movie playback

Press MPEG  or SEL/PUSH EXEC dial.

Viewing moving pictures – MPEG movie playback

When recording time is not long

The moving picture may not be divided into 60 parts.

Screen indicators during moving picture playback

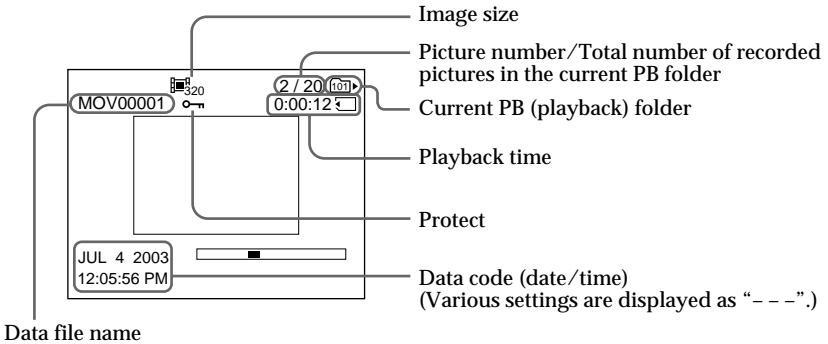

Data code (date/time)

You can view the data code (date/time) by pressing DATA CODE on the Remote Commander during playback.

To make the indicators disappear

Press DISPLAY.

Selecting a folder to view

350 351

You can select a folder to view images in it.

Before operation

Insert a "Memory Stick" into your camcorder.

- (1) Set the POWER switch to MEMORY. Make sure that the LOCK switch is set to the left (unlock) position.
- (2) Press MENU to display the menu settings.
- (3) Turn the SEL/PUSH EXEC dial to select PB FOLDER in , then press the dial (p. 217).
- (4) Press MEMORY +/- to select the desired folder.
 - : To view the previous folder
 - + : To view the next folderThe first image in the current selected PB folder and the folder information are displayed.
- (5) Press MENU when you find the folder that contains images you want to view. Press MEMORY +/- to select the desired image in the folder.

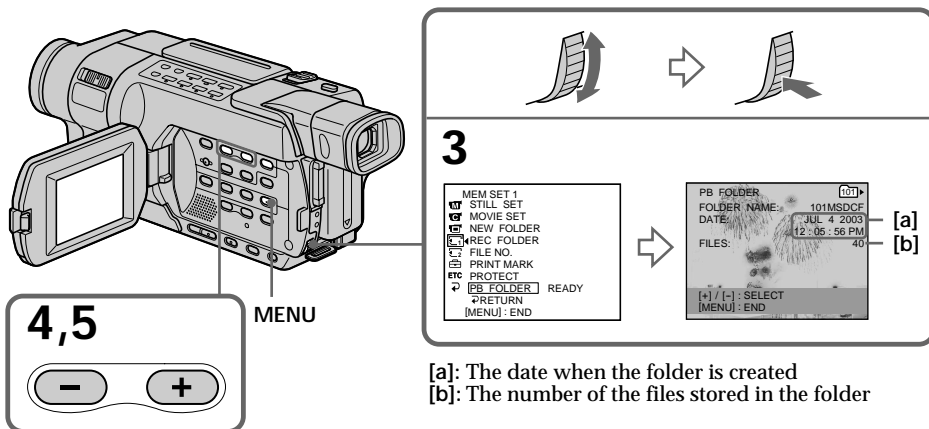

To cancel selecting the folder

Press  RETURN in step (3).

Note

Folders created, or renamed with your computer may not be recognized by your camcorder.

Current PB folder

The current PB folder is valid until the next recording is made. Once you record an image, the current recording folder becomes the current PB folder.

When no image is in the PB folder

"NO FILE AVAILABLE" appears.

Copying images recorded on a "Memory Stick" to a tape

350 **351**

You can copy still images recorded on a "Memory Stick" to a tape.

Before operation

- Insert a tape for recording into your camcorder.
- Insert a "Memory Stick" into your camcorder.

- (1) Set the POWER switch to VCR.
- (2) Using the video control buttons, search for a point where you want to record the desired still image. Set the tape to playback pause mode.
- (3) Press ● REC and the button on its right simultaneously on your camcorder. The tape is set to the recording pause mode.
- (4) Press MEMORY PLAY. The last recorded image is displayed.
- (5) Press MEMORY+/- to select the desired image.
 - : To see the previous image
 - + : To see the next image
- (6) Press II to start recording and press II again to stop. The ● indicator appears on the screen during recording.
- (7) If you have more to copy, repeat steps (5) to (6).

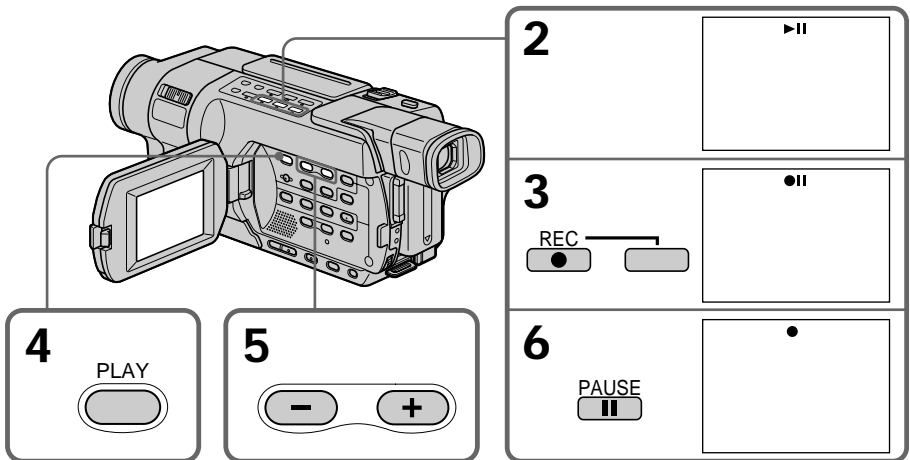

To stop copying

Press ■.

Copying images recorded on a "Memory Stick" to a tape

During copying

You cannot operate the following buttons:

- MEMORY PLAY
- MEMORY INDEX
- MEMORY DELETE
- MEMORY MIX
- MEMORY +/-

Note on the index screen

You cannot record the index screen.

If you press EDITSEARCH during pause mode

Memory playback stops.

Image data modified on your computer or shot with other equipment

You may not be able to copy modified images with your camcorder.

When copying movies

After step (6), press the MPEG ►|| button or SEL/PUSH EXEC dial and play back the image.







Enlarging still images recorded on a "Memory Stick" – Memory PB ZOOM

350 **351**

You can enlarge still images recorded on a "Memory Stick." You can select and view a desired part from the enlarged still image. Also, you can copy the desired part of the enlarged still image to a tape.

Before operation

Insert a "Memory Stick" into your camcorder.

- (1) Set the POWER switch to MEMORY or VCR. Make sure that the LOCK switch is set to the left (unlock) position.
- (2) Press PB ZOOM on your camcorder while you are playing back images recorded on the "Memory Stick." The center of the image is enlarged to about twice its size, and   appear on the screen.
- (3) Turn the SEL/PUSH EXEC dial to move the enlarged image, then press the dial.
 -  : To view the upper part of the image
 -  : To view the lower part of the image
- (4) Turn the SEL/PUSH EXEC dial to move the enlarged image, then press the dial.
 -  : To view the left part of the image (Turn the dial downward.)
 -  : To view the right part of the image (Turn the dial upward.)
- (5) Adjust the zoom ratio by the power zoom lever.
 - W : To decrease the zoom ratio
 - T : To increase the zoom ratio

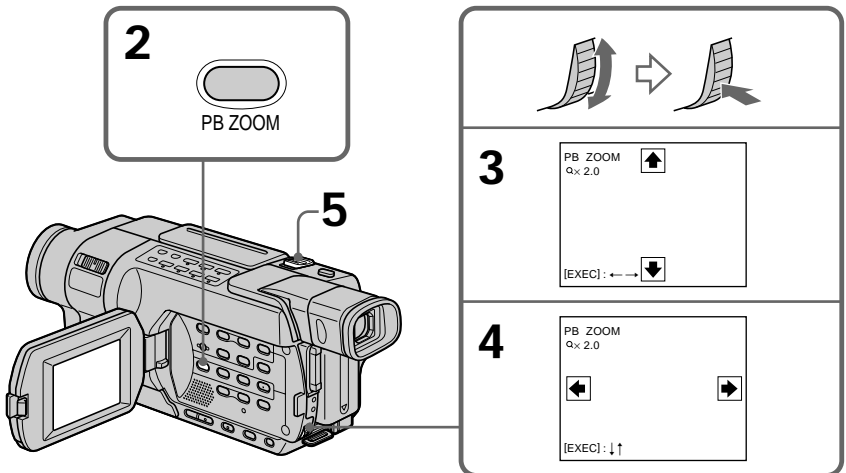

Enlarging still images recorded on a "Memory Stick" - Memory PB ZOOM

To cancel Memory PB ZOOM

Press PB ZOOM.

Memory PB ZOOM is canceled when the following buttons are pressed:

- MENU
- MEMORY PLAY
- MEMORY INDEX
- MEMORY +/-

Moving pictures recorded on a "Memory Stick"

Memory PB ZOOM does not work.

To copy the still image processed by Memory PB ZOOM to a tape

See page 170.

Playing back images continuously – SLIDE SHOW

350 351

Your camcorder can play back images in sequence automatically. This function is useful especially when checking recorded images or during a presentation.

Before operation

Insert a “Memory Stick” into your camcorder.

- (1) Set the POWER switch to MEMORY. Make sure that the LOCK switch is set to the left (unlock) position.
- (2) Press MENU to display the menu settings.
- (3) Turn the SEL/PUSH EXEC dial to select SLIDE SHOW in , then press the dial.
- (4) Turn the SEL/PUSH EXEC dial to select the desired mode, then press the dial.
ALL FILES: All images in the “Memory Stick” are played back continuously.
FOLDER □□□*: All images in the current PB folder are played back continuously.
* □□□ stands for the folder number.
- (5) Press MEMORY PLAY. Your camcorder plays back the images recorded on the “Memory Stick” in sequence.
The slide show ends after all images have been played back.

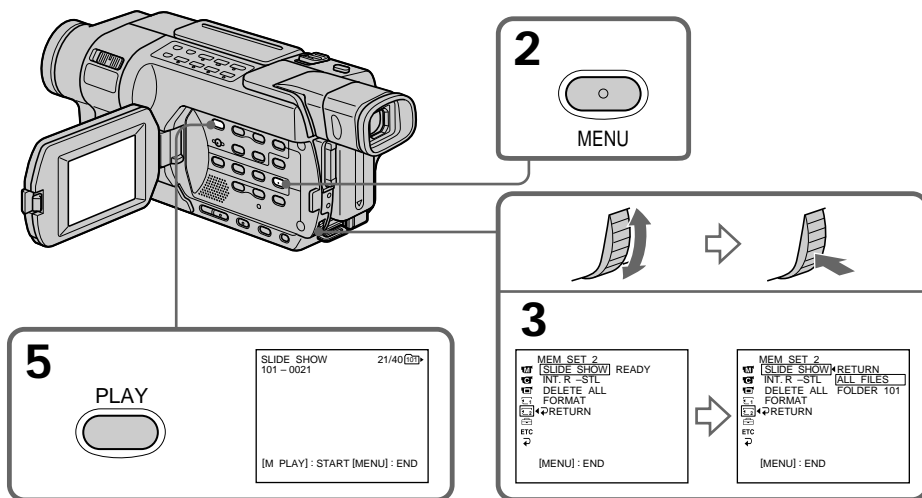

To cancel the slide show

Select RETURN in step (4), then press the SEL/PUSH EXEC dial.

To pause during a slide show

Press MEMORY PLAY.

To start the slide show from a particular image

Select the desired image using MEMORY +/- buttons before step (2).

Playing back images continuously – SLIDE SHOW

To view recorded images on TV

Before operation, connect your camcorder to a TV with the A/V connecting cable supplied with your camcorder (p. 51).

If you change the “Memory Stick” during operation

The slide show does not operate. If you change the “Memory Stick,” be sure to follow the steps again from the beginning.



Preventing accidental erasure - Image protection

350 351

You can protect selected images to prevent accidental erasure.

Before operation

Insert a "Memory Stick" into your camcorder.

- (1) Set the POWER switch to MEMORY or VCR. Make sure that the LOCK switch is set to the left (unlock) position.
- (2) Play back the image you want to protect.
- (3) Press MENU to display the menu settings.
- (4) Turn the SEL/PUSH EXEC dial to select PROTECT in , then press the dial.
- (5) Turn the SEL/PUSH EXEC dial to select ON, then press the dial.
- (6) Press MENU to make the menu settings disappear. The  mark is displayed beside the data file name of the protected image.

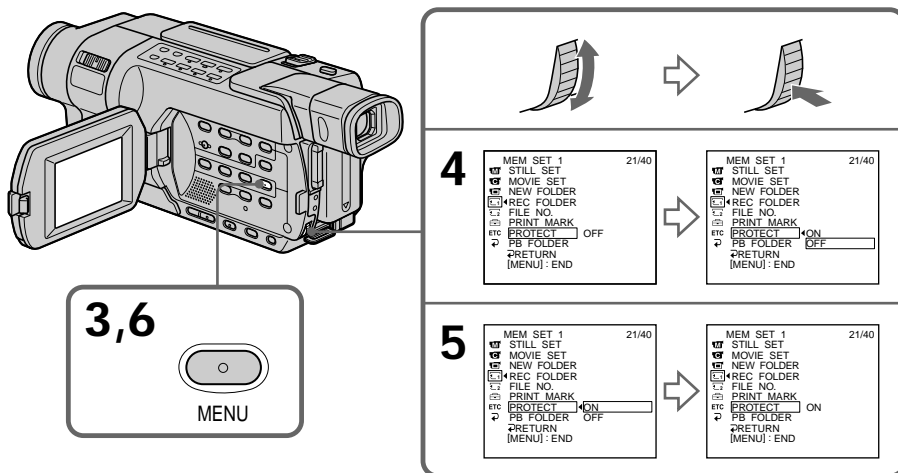

To cancel image protection

Select OFF in step (5), then press the SEL/PUSH EXEC dial.
The  mark disappears from the image.

Note

Formatting erases all information on the "Memory Stick," including the protected image data. Before formatting a "Memory Stick," check its contents.

If the write-protect tab on the "Memory Stick" is set to LOCK
You cannot protect images.

Deleting images – DELETE

350 351

You can delete images stored in a “Memory Stick.” You can delete all images or only selected images.

Deleting selected images

Before operation

Insert a “Memory Stick” into your camcorder.

- (1) Set the POWER switch to MEMORY or VCR. Make sure that the LOCK switch is set to the left (unlock) position.
- (2) Play back the image you want to delete.
- (3) Press MEMORY DELETE. The message DELETE? appears on the screen.
- (4) Press MEMORY DELETE again. The selected image is deleted.

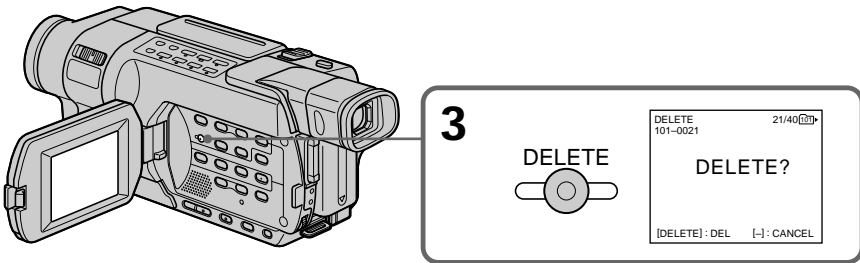

To cancel deleting an image

Press MEMORY – in step (4).

To delete an image displayed on the index screen

Press MEMORY +/- to move the ► indicator to the image and follow steps (3) and (4).

Notes

- You cannot delete a protected image. To delete a protected image, first cancel image protection.
- Once you delete an image, you cannot restore it. Before deleting an image, carefully check the image.
- Even if you delete the last image in the folder, the folder itself is not deleted.

If the write-protect tab on the “Memory Stick” is set to LOCK

You cannot delete images.



Deleting images – DELETE

Deleting all images

You can delete all unprotected images in a “Memory Stick.”

Before operation

Insert a “Memory Stick” into your camcorder.

- (1) Set the POWER switch to MEMORY. Make sure that the LOCK switch is set to the left (unlock) position.
- (2) Press MENU to display the menu settings.
- (3) Turn the SEL/PUSH EXEC dial to select DELETE ALL in , then press the dial.
- (4) Turn the SEL/PUSH EXEC dial to select the desired mode, then press the dial. ALL FILES: All unprotected images in the “Memory Stick” are deleted. FOLDER *: All unprotected images in the current PB folder are deleted. *  stands for the folder number.
- (5) Turn the SEL/PUSH EXEC dial to select OK, then press the dial. OK changes to EXECUTE.
- (6) Turn the SEL/PUSH EXEC dial to select EXECUTE, then press the dial. The DELETING indicator flashes on the screen. When all unprotected images are deleted, The COMPLETE indicator is displayed.

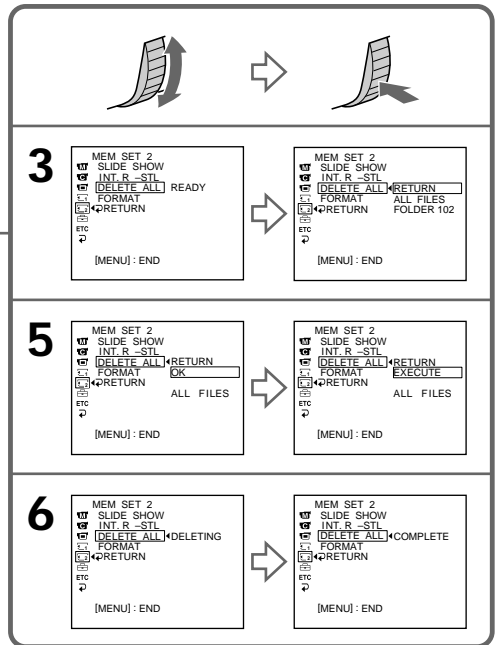
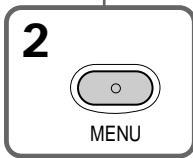
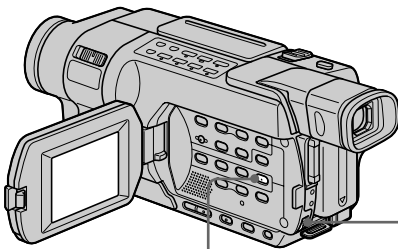

Deleting images – DELETE

To cancel deleting all the images

Select RETURN in step (4) or (5), then press the SEL/PUSH EXEC dial.

Note

You cannot delete the folders with your camcorder.

While the DELETING indicator appears

Do not turn the POWER switch or press any buttons.

If the write-protect tab on the “Memory Stick” is set to LOCK

You cannot delete images.



Writing a print mark – PRINT MARK

350 351

You can specify a recorded still image to print out by writing a print mark. This function is useful for printing out still images later. Your camcorder conforms to the DPOF (Digital Print Order Format) standard for specifying still images to print out.

Before operation

Insert a “Memory Stick” into your camcorder.

- (1) Set the POWER switch to MEMORY or VCR. Make sure that the LOCK switch is set to the left (unlock) position.
- (2) Play back the still image you want to write a print mark on.
- (3) Press MENU to display the menu settings.
- (4) Turn the SEL/PUSH EXEC dial to select PRINT MARK in , then press the dial.
- (5) Turn the SEL/PUSH EXEC dial to select ON, then press the dial.
- (6) Press MENU to make the menu settings disappear. The  mark is displayed beside the data file name of the image with a print mark.

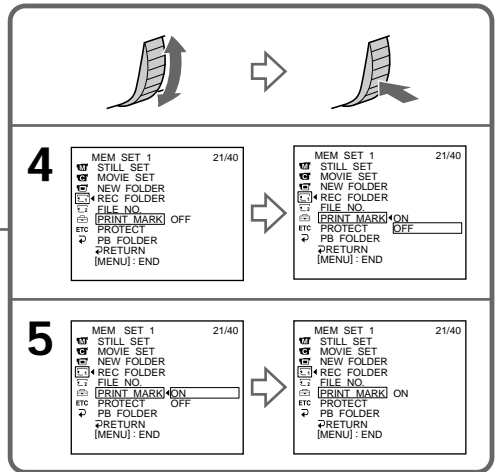
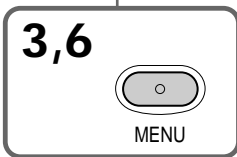
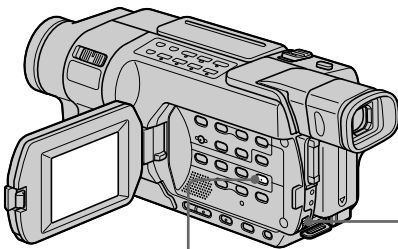

To cancel writing of print marks

Select OFF in step (5), then press the SEL/PUSH EXEC dial. The  mark disappears from the image.

Writing a print mark – PRINT MARK

If the write-protect tab on the “Memory Stick” is set to LOCK
You cannot write print marks on still images.

Moving pictures

You cannot write print marks on moving pictures.

While the file name is flashing

You cannot write the print mark on the still image.

Viewing images on your computer

- Introduction

150 **250** **350** **351**

The following are ways of connecting the camcorder to a computer to view images saved on a "Memory Stick"* **350** **351**, recorded on tape or live from your camcorder on your computer.

* To view images on a computer which has a Memory Stick slot, first remove the "Memory Stick" from the camcorder and then insert it into the computer's Memory Stick slot.

| | Camcorder Connection jack | Connection cable | Computer environment requirements |
|---|--|--------------------------|-------------------------------------|
| Tape stills and movies/Picture live from your camcorder | ψ (USB) jack 250 350 351 | ψ (USB) cable (supplied) | ψ (USB) connector, editing software |
| | DV jack | i.LINK cable (optional) | i.LINK connector, editing software |
| "Memory Stick" stills and movies 350 351 | ψ (USB) jack | ψ (USB) cable (supplied) | ψ (USB) connector, editing software |

When connecting to a computer via the USB jack, complete installation of the USB driver beforehand. If you connect the camcorder to the computer first, you will not be able to install the USB driver correctly.

For details about your computer's jacks and editing software, contact the computer manufacturer.

Viewing images on your computer – Introduction

Viewing pictures recorded on a tape or live from your camcorder – USB Streaming

When connecting to a computer using the USB cable 

250 **350** **351** (p. 187)

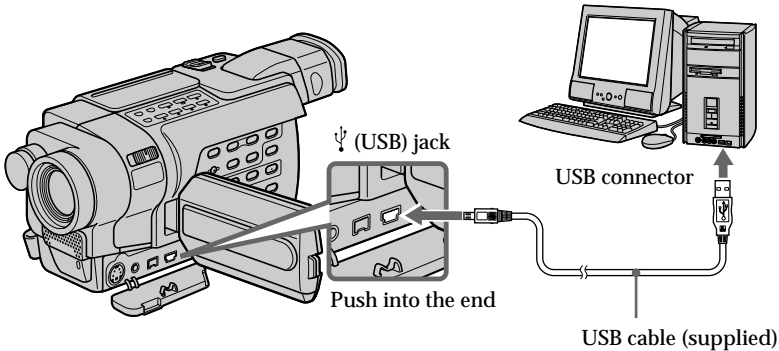

Follow the instructions in order described below

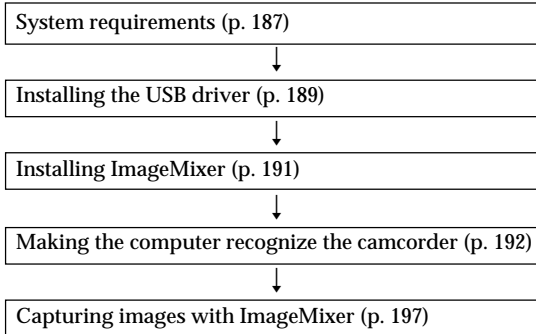

- Viewing pictures recorded on a tape (p. 197)
- Viewing pictures live from your camcorder (p. 199)
- Capturing still images (p. 199)
- Capturing moving pictures (p. 200)

Viewing images on your computer – Introduction

When connecting to a computer using the i.LINK cable

Your computer must have an i.LINK connector and editing software installed that can read video signals.

Refer to the operating instructions of the software for further information.

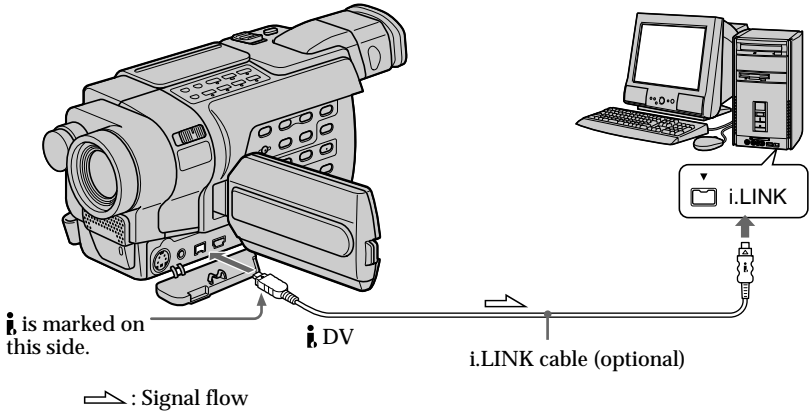

Viewing images on your computer – Introduction

Viewing images recorded on a “Memory Stick” 350 351

When connecting to a computer using the USB cable

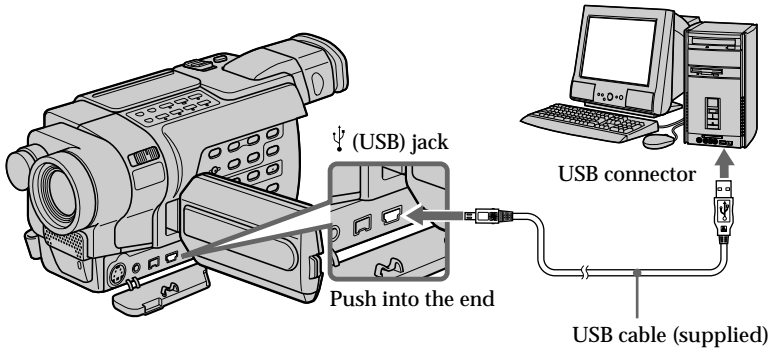

You can also use a Memory Stick Reader/Writer (optional).

Follow the instructions in order described below

Windows

- System requirements (p. 188)
- ↓
- Installing the USB driver (p. 189)
- ↓
- Installing Image Transfer (p. 190)
- ↓
- Making the computer recognize the camcorder (p. 192)
- ↓
- Viewing images with Image Transfer (p. 202)
Viewing images without Image Transfer (p. 203)

Macintosh

- System requirements (p. 205)
- ↓
- Installing the USB driver (p. 206)
- ↓
- Viewing images (p. 207)

Viewing images on your computer – Introduction

When connecting to a computer without a USB connector

Use an optional floppy disk adaptor for Memory Stick or a PC card adaptor for Memory Stick.

When purchasing an accessory, check its catalog beforehand for the recommended operating environment.

When connecting with USB port

You cannot operate your camcorder setting the POWER switch to MEMORY.

Notes on using your computer

“Memory Stick”

- “Memory Stick” operations on your camcorder cannot be assured if a “Memory Stick” formatted on your computer is used on your camcorder, or if the “Memory Stick” in your camcorder was formatted from your computer when the USB cable was connected.
- Do not compress the data on the “Memory Stick.” Compressed files cannot be played back on your camcorder.

Software

- Depending on your application software, the file size may increase when you open a still image file.
- When you load an image modified using retouching software from your computer to your camcorder or when you directly modify the image on your camcorder, the image format will differ so a file error indicator may appear and you may be unable to open the file.

Communications with your computer

Communications between your camcorder and your computer may not recover after recovering from Suspend, Resume, or Sleep.

Connecting your camcorder to your computer using the USB cable

250 350 351

Complete installation of the USB driver before connecting the camcorder to the computer. If you connect the camcorder to the computer first, you will not be able to install the USB driver correctly.

When connecting to a computer using the USB cable

You must install a USB driver onto your computer to connect the camcorder to the computer's USB connector. The USB driver can be found on the CD-ROM supplied, along with the application software required for viewing images.

System requirements

To view pictures recorded on a tape or live from your camcorder

OS:

Microsoft Windows 98SE, Windows Me, Windows 2000 Professional, Windows XP Home Edition or Windows XP Professional.

Standard installation is required.

However, operation is not assured if the above environment is an upgraded OS.

You cannot hear sound if your computer is running Windows 98, but you can read still images.

CPU:

Minimum 500 MHz Intel Pentium III or faster (800 MHz or faster recommended)

Application:

DirectX 8.0a or later

Sound system:

16 bit stereo sound card and stereo speakers

Memory:

64 MB or more

Hard disk:

Available memory required for installation:

at least 250 MB

Available hard disk memory recommended:

at least 1 GB (depending on the size of the image files edited)

Display:

4 MB VRAM video card, Minimum 800 × 600 dot high color (16 bit color, 65 000 colors), Direct Draw display driver capability. (At 800 × 600 dot or less, 256 colors and less, this product will not operate correctly)



Others:

The USB connector must be provided as standard.

This product is based on DirectX technology, so it is necessary to install DirectX.

You cannot use this function in the Macintosh environment.

System requirements

To view images recorded on a "Memory Stick"  

OS:

Microsoft Windows 98, Windows 98SE, Windows Me, Windows 2000 Professional, Windows XP Home Edition or Windows XP Professional.

Standard installation is required.

However, operation is not assured if the above environment is an upgraded OS.

CPU:

MMX Pentium 200 MHz or faster

Display:

Minimum 800 × 600 dot high color (16 bit color, 65 000 colors). (At 800 × 600 dot or less, 256 colors and less, the screen for installing USB driver is not displayed.)

Others:

The USB connector must be provided as standard.

Windows Media Player must be installed (to play back moving pictures).

Notes

- Operations are not guaranteed for the Windows environment if you connect two or more USB equipment to a single computer at the same time, or when using a hub.
- Some equipment may not operate depending on the type of USB equipment that is used simultaneously.
- Operations are not guaranteed for all system requirements mentioned above.

Installing the USB driver

Start the following operation without connecting the USB cable to your computer.
Connect the USB cable according to "Making the computer recognize the camcorder."

If you are using Windows 2000, log in with permission of administrators.
If you are using Windows XP, log in with permission of computer administrators.

- (1) Turn on your computer and allow Windows to load.
- (2) Insert the supplied CD-ROM in the CD-ROM drive of your computer. The application software starts up. If the screen does not appear, double-click "My Computer" and then "ImageMixer" (CD-ROM Drive).
- (3) Select "Handycam" on the screen.



The title screen appears.

- (4) Move the cursor to "USB Driver" and click. This starts USB driver installation.



- (5) Follow the on-screen messages to install the USB driver.
- (6) Remove the CD-ROM and then restart the computer, following the instructions on the screen.

Note

If you connect the USB cable before USB driver installation is complete, the USB driver will not be properly registered. Carry out installation again following the steps on page 194.

Installing Image Transfer

Image Transfer enables image data recorded on a “Memory Stick” to be automatically transferred (copied) to your computer.

If you are using Windows 2000, log in with permission of administrators.

If you are using Windows XP, log in with permission of computer administrators.

- (1) Turn on your computer and allow Windows to load.
- (2) Insert the supplied CD-ROM in the CD-ROM drive of your computer. The application software starts up.
- (3) Select “Handycam” on the screen.
The title screen appears.
- (4) Move the cursor to “Image Transfer” and click.



The Install Wizard program starts up and the “Choose Setup Language” screen appears.

- (5) Select the language for installation.
- (6) Follow the on-screen messages.
The installation screen disappears when installation is complete.

Installing ImageMixer

“ImageMixer Ver.1.5 for Sony” is an application that can capture or edit images, or create video CDs.

If you are using Windows 2000, log in with permission of administrators.
If you are using Windows XP, log in with permission of computer administrators.

- (1) Turn on your computer and allow Windows to load.
- (2) Insert the supplied CD-ROM into the CD-ROM drive of your computer.
The application software starts up.
- (3) Select “Handycam” on the screen.
The title screen appears.
- (4) Move the cursor to “ImageMixer” and click.



The Install Wizard program starts up and the “Choose Setup Language” screen appears.

- (5) Select the language for installation.
- (6) Follow the on-screen messages.
The installation screen disappears when installation is complete.
- (7) If DirectX 8.0a or later version is not installed on your computer, continue installation after installing ImageMixer.
Follow the on-screen messages to install DirectX. After installation is complete, restart your computer.

Note

The title screen is not displayed if the screen size of your computer is set to less than 800 × 600 dots and 256 colors or less. See page 187 about the System requirements.

Memory Mix Album **350** **351**



Once “ImageMixer” is installed, the Memory Mix album is created in “Album” of “ImageMixer” and sample images are stored in there.

Those sample images can be transferred from the Memory Mix album to a “Memory Stick” so that they can be used in MEMORY MIX (p. 140).

For details on the operation procedure, refer to the on-line help.

Making the computer recognize the camcorder

Viewing pictures recorded on a tape or live from your camcorder

- (1) Connect the AC Adaptor to your camcorder. Set the POWER switch to VCR.
- (2) Select USB STREAM in  to ON in the menu settings (p. 221).
- (3) Connect the  (USB) jack on your camcorder to the USB connector on your computer using the supplied USB cable.

Your computer recognizes your camcorder, and the Windows Add Hardware Wizard starts.

- (4) Follow the on-screen messages so that the Add Hardware Wizard recognizes that the USB drivers have been installed. The Add Hardware Wizard starts three times because three different USB drivers are installed. Be sure to allow the installation to complete without interrupting it.

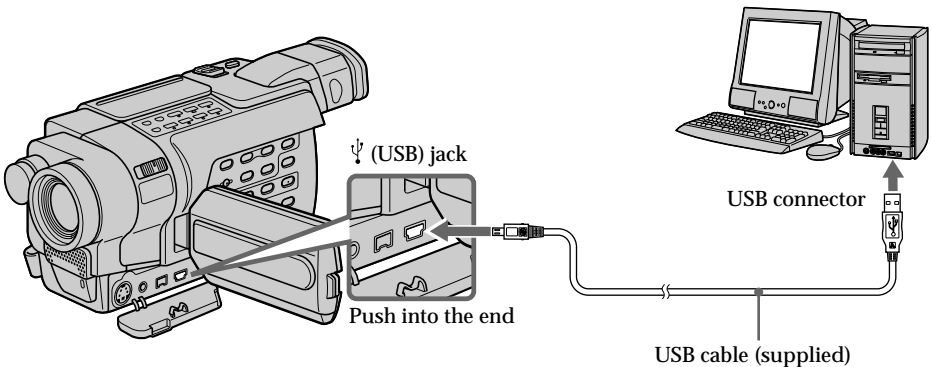

Making the computer recognize the camcorder

Viewing images recorded on a "Memory Stick" **350** **351**

- (1) Insert a "Memory Stick" into your camcorder.
- (2) Connect the AC Adaptor and set the POWER switch to MEMORY.
- (3) Connect the  (USB) jack on your camcorder to the USB connector on your computer using the supplied USB cable.
"USB MODE" appears on the screen of your camcorder. Your computer recognizes the camcorder, and the Add Hardware Wizard starts.

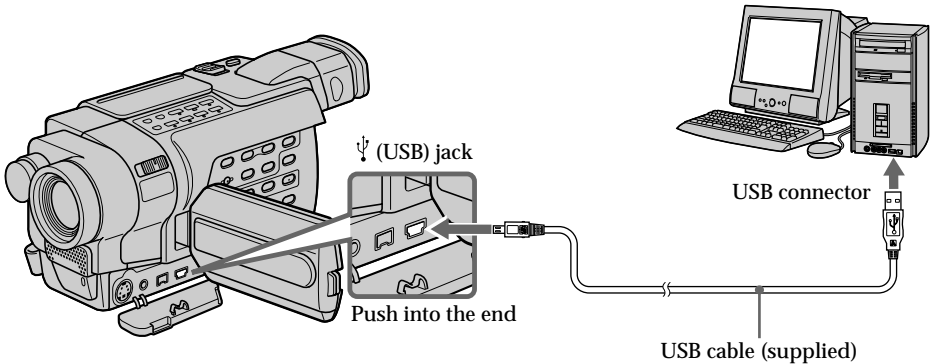

- (4) Follow the on-screen messages so that the Add Hardware Wizard recognizes that the USB drivers have been installed. The Add Hardware Wizard starts two times because two different USB drivers are installed. Be sure to allow each installation to complete without interrupting them.

You cannot install the USB driver if a "Memory Stick" is not in your camcorder. Be sure to insert a "Memory Stick" into your camcorder before installing the USB driver.

If you cannot install the USB driver

The USB driver has been registered incorrectly as your computer was connected to your camcorder before installation of the USB driver was completed. Perform the following procedure to correctly install the USB driver.

Viewing images recorded on a tape or live from your camcorder

Step 1: Uninstall the incorrect USB driver

- ① Turn on your computer and allow Windows to load.
- ② Connect the AC Adaptor, and set the POWER switch to VCR.
- ③ Connect the Ψ (USB) jack on your camcorder to the USB connector on your computer using the supplied USB cable.
- ④ Open your computer's "Device Manager."

Windows XP:

Select "Start" → "Control Panel" → "System" → "Hardware" tab and click the "Device Manager" button.

If there is no "System" inside "Pick a category" after clicking "Control Panel," click "Switch to classic view" instead.

Windows 2000:

Select "My Computer" → "Control Panel" → "System" → "Hardware" tab and click the "Device Manager" button.

Windows 98SE/Windows Me:

Select "My Computer" → "Control Panel" → "System," and click "Device Manager."

Connecting your camcorder to your computer using the USB cable



⑤ Select and delete the underlined devices.

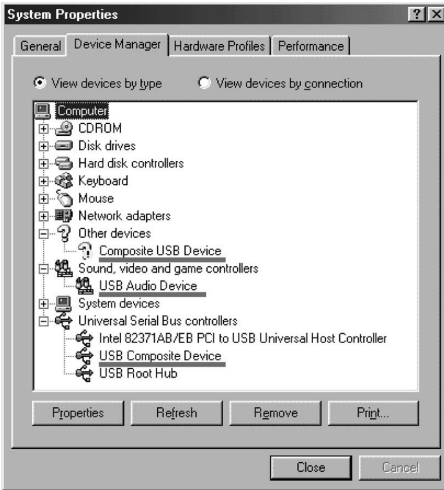

Windows 98SE

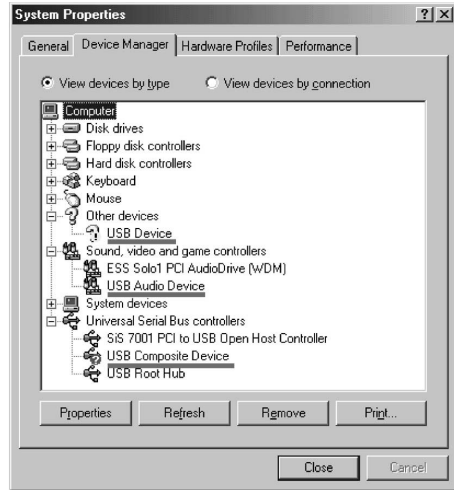

Windows Me

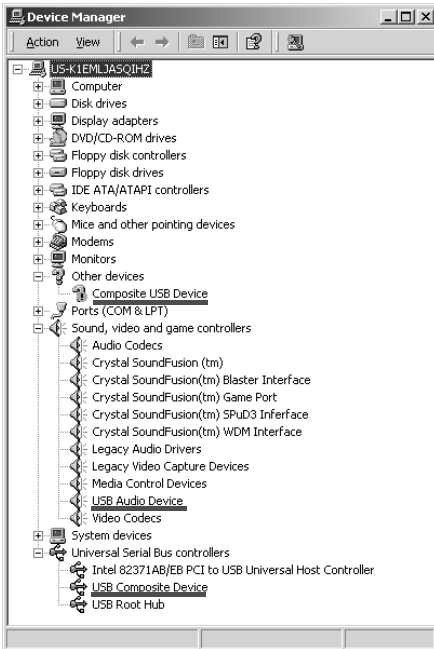

Windows 2000

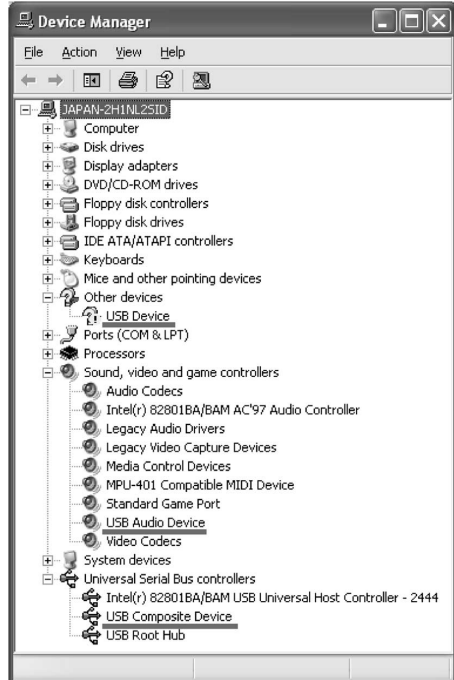

Windows XP

Viewing Images on Your Computer

- ⑥ Turn the POWER switch to OFF (CHG) on your camcorder, and then disconnect the USB cable.
- ⑦ Restart your computer.

Step 2: Install the USB driver on the supplied CD-ROM

Perform the entire procedure described in “Installing the USB driver” on page 189.

Viewing images recorded on a “Memory Stick”

Step 1: Uninstall the incorrect USB driver

- ① Turn on your computer and allow Windows to load.
- ② Insert a “Memory Stick” into your camcorder.
- ③ Connect the AC Adaptor, and set the POWER switch to MEMORY.
- ④ Connect the  (USB) jack on your camcorder to the USB connector on your computer using the supplied USB cable.
- ⑤ Open your computer’s “Device Manager.”

Windows XP:

Select “Start” → “Control Panel” → “System” → “Hardware” tab and click the “Device Manager” button.

If there is no “System” inside “Pick a category” after clicking “Control Panel,” click “Switch to classic view” instead.

Windows 2000:

Select “My Computer” → “Control Panel” → “System” → “Hardware” tab, and click the “Device Manager” button.

Other OS:

Select “My Computer” → “Control Panel” → “System,” and click “Device Manager.”

- ⑥ Select “Other devices.”
Select the device prefixed with the “?” mark and delete.
Ex: (?)Sony Handycam
- ⑦ Turn the POWER switch to OFF (CHG) on your camcorder, and then disconnect the USB cable.
- ⑧ Restart your computer.

Step 2: Install the USB driver on the supplied CD-ROM

Perform the entire procedure described in “Installing the USB driver” on page 189.



Viewing pictures recorded on a tape or live from your camcorder on your computer – USB Streaming **Windows**

250 350 351

Capturing images with ImageMixer

You need to install the USB driver and ImageMixer to view images recorded on a tape with your computer (p. 189, 191).

Viewing pictures recorded on a tape

- (1) Turn on your computer and allow Windows to load.
- (2) Connect the AC Adaptor, and insert a tape into your camcorder.
- (3) Set the POWER switch to VCR.
Select USB STREAM in  to ON in the menu settings (p. 221).
- (4) Select “Start” → “Program” → “PIXELA” → “ImageMixer” → “ImageMixer Ver.1.5 for Sony.”
The “ImageMixer Ver.1.5 for Sony” startup screen appears on your computer.
The title screen is displayed.
- (5) Click  on the screen.

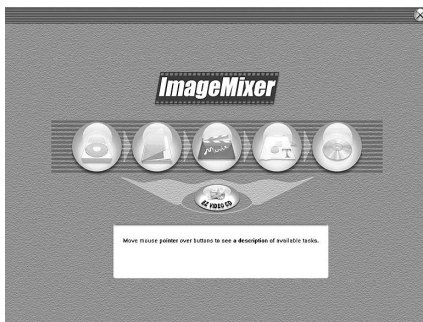

Viewing pictures recorded on a tape or live from your camcorder on your computer - USB Streaming (Windows)

(6) Select .

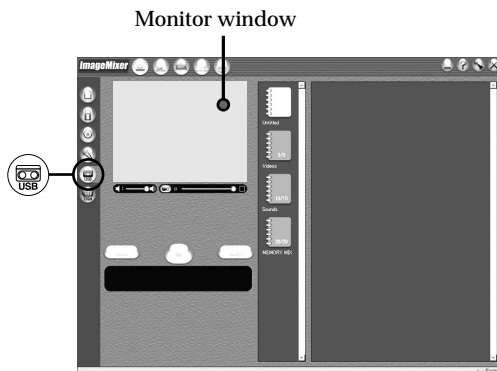

(7) Connect the USB connector on your computer to the  (USB) jack on your camcorder using the supplied USB cable.

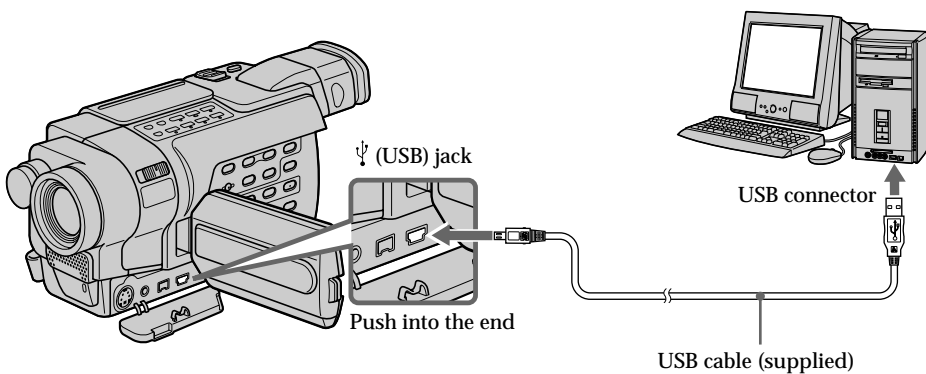

Viewing pictures recorded on a tape or live from your camcorder on your computer – USB Streaming Windows

- (8) Press ► to start playback.

You can control video operations with the buttons on the screen.

The picture appears in the monitor windows on your computer.

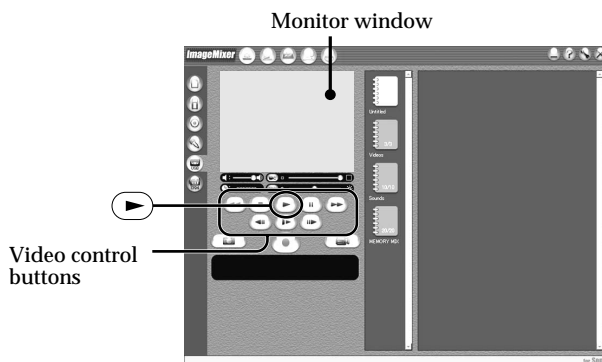

Viewing pictures live from your camcorder

- (1) Follow the steps (1), (2) on page 197.

- (2) Set the POWER switch to CAMERA.

Select USB STREAM in  to ON in the menu settings (p. 221).

- (3) Follow the steps (4) to (7) on pages 197 and 198.

The picture from your camcorder appears in the monitor window on your computer.

Capturing still images

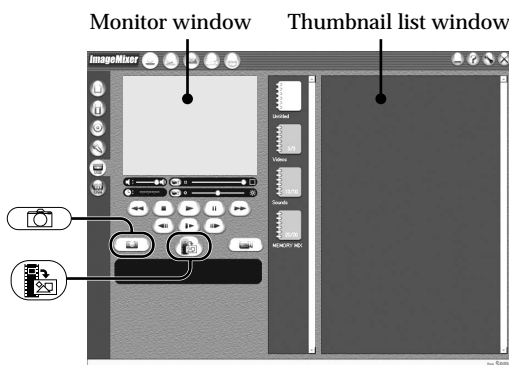

- (1) Select  .





- (2) Looking at the monitor window, move the cursor to  and click it at the point you want to capture.

The still image on the screen is captured.

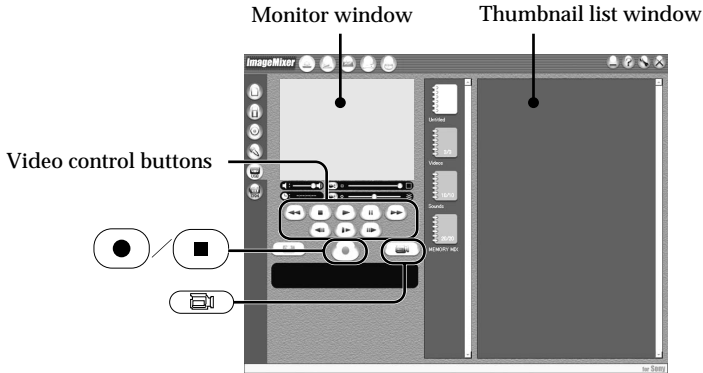
Captured images are displayed in the thumbnail list window.

Capturing moving pictures



- (1) Select .
- (2) Look at the monitor window and click on  at the first scene of the movie you want to capture.  changes to .
- (3) Look at the monitor window and click on  at the last scene you want to capture. The captured images appear in the thumbnail list window.

To close "ImageMixer"

Click  in the upper right corner of the screen.

Notes

- When you view images on your computer with the USB connection, the following may occur. This is not a malfunction:
 - The image shakes up and down.
 - Some images are not displayed correctly due to noise, etc.
 - Some images are displayed with the cracking noise.
 - Images of different color systems to that of your camcorder are not displayed correctly.
- When your camcorder is in the standby mode with a cassette inserted, it turns off automatically after three minutes.
- We recommend setting DEMO MODE to OFF in the menu settings when your camcorder is in the standby mode, and no cassette is inserted.
- Indicators on the screen do not appear on images that are captured into your computer.
- You cannot carry out any "Memory Stick" operations during the USB Streaming.

Viewing pictures recorded on a tape or live from your camcorder on your computer – USB Streaming

If image data cannot be transferred by the USB connection

The USB driver has been registered incorrectly as your computer was connected to your camcorder before installation of the USB driver was completed. Reinstall the USB driver following the procedure on page 194.

If any trouble occurs

Close all running applications, then restart your computer.

Carry out the following operations after quitting the application:

- Disconnect the USB cable.
- Set the POWER switch to another position or OFF (CHG) on your camcorder.

Seeing the on-line help (operating instructions) of ImageMixer

A “ImageMixer Ver.1.5 for Sony” on-line help site is available where you can find detailed operating information.

- (1) Click the  button located in the upper-right corner of the screen.
The ImageMixer’s Manual screen appears.
- (2) You can find the information you need from the list of contents.

To exit on-line help

Click the  button in the top right corner of the screen.

If you have any questions about ImageMixer

“ImageMixer Ver.1.5 for Sony” is the product of PIXELA corporation. For more information, refer to the instruction manual of the CD-ROM supplied with your camcorder.

Viewing images recorded on a “Memory Stick” on your computer **Windows**

350 351

Viewing images with Image Transfer

The image data recorded on a “Memory Stick” is automatically transferred (copied) to your computer with Image Transfer. You can also view images with ImageMixer.

- (1) Turn on your computer and allow Windows to load.
- (2) Insert a “Memory Stick” into your camcorder, and connect the AC Adaptor to your camcorder.
- (3) Set the POWER switch to MEMORY.
- (4) Connect the Ψ (USB) jack on your camcorder to the USB connector on your computer using the supplied USB cable.
- (5) Image Transfer automatically starts up and the transfer of image data begins.

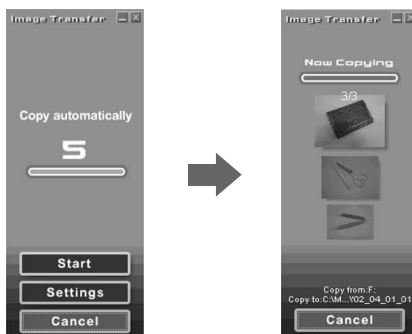

- (6) ImageMixer automatically starts up, enabling you to view the copied image.

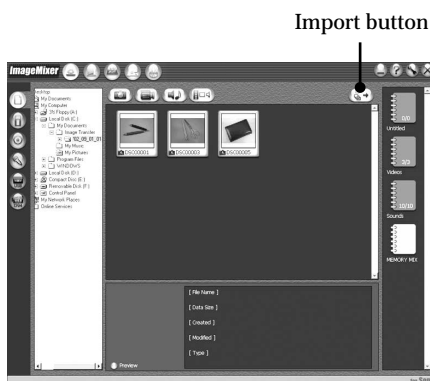

- (7) Select an album and the image, then press the import button.
The image is added in your album, and you can edit the image.

Viewing images recorded on a “Memory Stick” on your computer

Windows

Viewing images without Image Transfer

Before operation

An application such as Windows Media Player must be installed to play back moving pictures in Windows environment.

- (1) Turn on your computer and allow Windows to load.
- (2) Insert a “Memory Stick” into your camcorder, and connect the AC Adaptor to your camcorder.
- (3) Set the POWER switch to MEMORY.
- (4) Connect the  (USB) jack on your camcorder to the USB connector on your computer using the supplied USB cable.
“USB MODE” appears on the LCD screen of your camcorder.

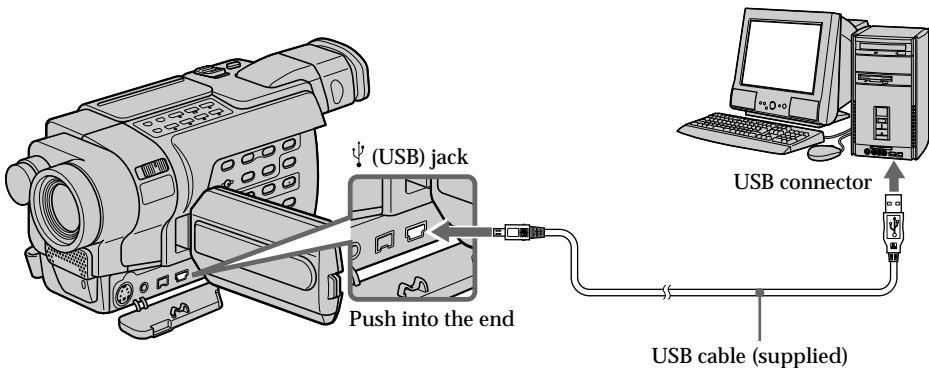

- (5) Open “My Computer” on Windows and double-click the newly recognized drive (e.g. “Removable Disk (F:)”).
The folders inside the “Memory Stick” are displayed.
- (6) Double-click the desired image file from the folder in this order.
“Dcim” folder → “□□□msdcf” folder *¹⁾ → Image file *²⁾
For the detailed folder and file name, see “Image file storage destinations and image files” (p. 204).

*¹⁾ □□□ stands for any number (within the range) from 101 to 999.

*²⁾ Copying a moving picture file to the hard disk of your computer before viewing it is recommended. If you play back the file directly from the “Memory Stick,” the image and sound may break off.

Image file storage destinations and image files

Image files recorded with your camcorder are grouped in folders described below. The meanings of the file names are as follows. □□□□ stands for any number within the range from 0001 to 9999.

Example: For Windows Me users (The drive recognizing your camcorder is [F:].)

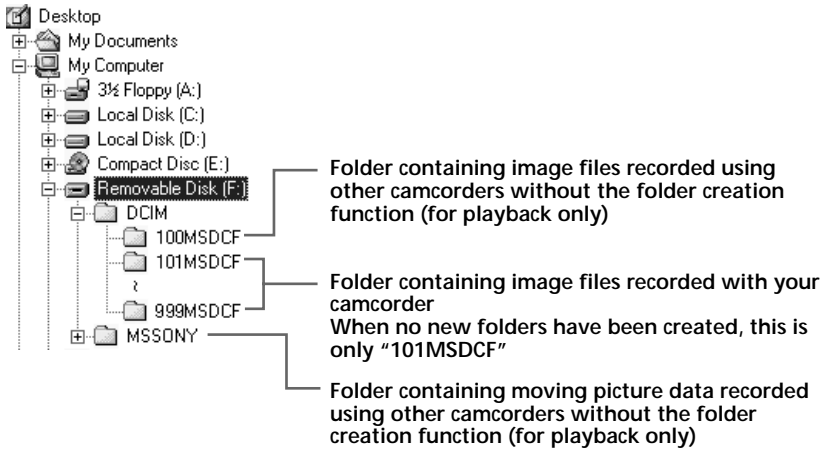

| Folder | File | Meaning |
|------------------|--------------|---------------------|
| 101MSDCF | DSC0□□□□.JPG | Still image file |
| (up to 999MSDCF) | MOV0□□□□.MPG | Moving picture file |

Disconnect the USB cable and remove the “Memory Stick” or set the POWER switch to OFF (CHG)

For Windows 2000, Windows Me, Windows XP users

- (1) Move the cursor to the “Unplug or Eject Hardware” on the Task Tray and click to cancel the applicable drive.
- (2) After the “Safe to remove” message appears, disconnect the USB cable and eject the “Memory Stick” or set the POWER switch to OFF (CHG).

Connecting your camcorder to your computer using the USB cable

350 351

When connecting to a computer using the USB cable

You must install a USB driver onto your computer in order to connect the camcorder to the computer's USB connector. The USB driver can be found on the CD-ROM supplied, along with the application software required for viewing images.

System requirements

OS:

Mac OS 8.5.1/8.6/9.0/9.1/9.2 or Mac OS X (v10.0/v10.1)

Standard installation is required.

However, note that upgrade to Mac OS 9.0/9.1 should be used for the following models:

- iMac with the Mac OS 8.6 standard installation and a slot loading type CD-ROM drive
- iBook or Power Mac G4 with the Mac OS 8.6 standard installation

Others:

The USB connector must be provided as standard.

QuickTime 3.0 or later must be installed to play back moving pictures.

Notes

- Operations are not guaranteed for the Macintosh environment if you connect two or more USB equipment to a single computer at the same time, or when using a hub.
- Some equipment may not operate depending on the type of USB equipment that is used simultaneously.
- Operations are not guaranteed for all the recommended computer environments mentioned above.

Installing the USB driver

For Mac OS 9.1/9.2/Mac OS X (v10.0/v10.1)

The USB driver does not have to be installed. Your camcorder is automatically recognized as a drive just by connecting it to your Mac using the USB cable.

For Mac OS 8.5.1/8.6/9.0 users

Do not connect the USB cable to your computer before installation of the USB driver is completed.

- (1) Turn on your computer and allow the Mac OS to load.
- (2) Insert the supplied CD-ROM in the CD-ROM drive of your computer.
The application software screen appears.
- (3) Select "Handycam" on the screen.
The title screen appears.
- (4) Click "USB Driver" to open the folder containing the six files related to "Driver."

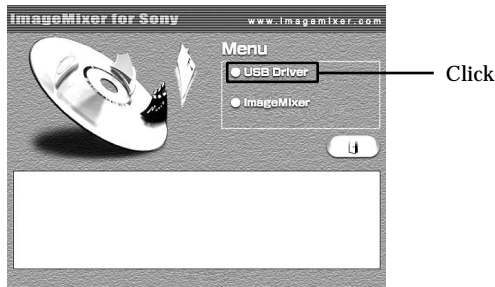

- (5) Select the following two files, and drag and drop them into the System Folder.
 - Sony Camcorder USB Driver
 - Sony Camcorder USB Shim

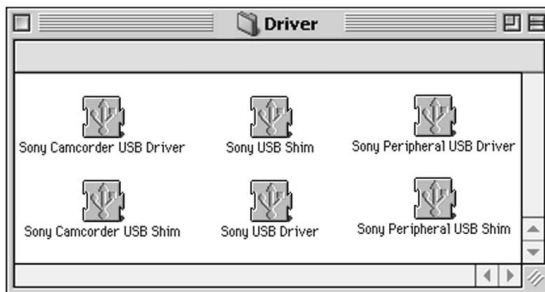

- (6) When the message appears, click "OK."
The USB driver is installed on your computer.
- (7) Remove the CD-ROM from the computer.
- (8) Restart your computer.

Viewing images recorded on a “Memory Stick” on your computer

350 351

Viewing images

Before operation

- You need to install the USB driver to view a “Memory Stick” images on your computer (p. 206).
- QuickTime 3.0 or later must be installed to play back moving pictures.

- (1) Turn on your computer and allow Mac OS to load.
- (2) Insert a “Memory Stick” into your camcorder, and connect the AC Adaptor to your camcorder.
- (3) Set the POWER switch to MEMORY.
- (4) Connect the  (USB) jack on your camcorder with the USB jack on your computer using the supplied USB cable.
“USB MODE” appears on the screen of your camcorder.
- (5) Double-click the “Memory Stick” icon on the desktop.
The folders inside the “Memory Stick” are displayed.
- (6) Double-click the desired image file from the folder in this order.
“Dcim” folder → “□□□msdcf” folder ^{*1)} → Image file ^{*2)}

^{*1)} □□□ stands for any number (within the range) from 101 to 999.

^{*2)} Copying a moving picture file to the hard disk of your computer before viewing it is recommended. If you play back the file directly from the “Memory Stick,” the image and sound may break off.

Disconnect the USB cable and remove the “Memory Stick” or set the POWER switch to OFF (CHG)

- (1) Close all running applications.
Make sure that the access lamp of your camcorder is not lit.
- (2) Drag the “Memory Stick” icon into the “Trash.” Alternatively, select the “Memory Stick” icon by clicking it, and then select “Eject disk” from the “Special” menu at the top left of the screen.
- (3) Unplug the USB cable or eject the “Memory Stick.” Set the POWER switch of your camcorder to OFF (CHG).

For Mac OS X (v10.0) users

Shut down your computer, then unplug the USB cable, eject the “Memory Stick” or set the POWER switch to OFF (CHG).

Capturing images from an analog video unit on your computer – Signal convert function

350 351

You can capture images and sound from an analog video unit on your computer which has the i.LINK connector by transmitting data via your camcorder.

Before operation

Set DISPLAY to LCD in the menu settings. (The default setting is LCD.)

- (1) Set the POWER switch to VCR.
- (2) Press MENU to display the menu settings.
- (3) Turn the SEL/PUSH EXEC dial to set A/V → DV OUT in  to ON (p. 214).
- (4) Start playback on the analog video unit.
- (5) Start procedures for capturing images and sound on your computer.

The operation procedures depend on your computer and the software you are using.

For details on how to capture images, refer to the operating instructions of your computer and the software you are using.

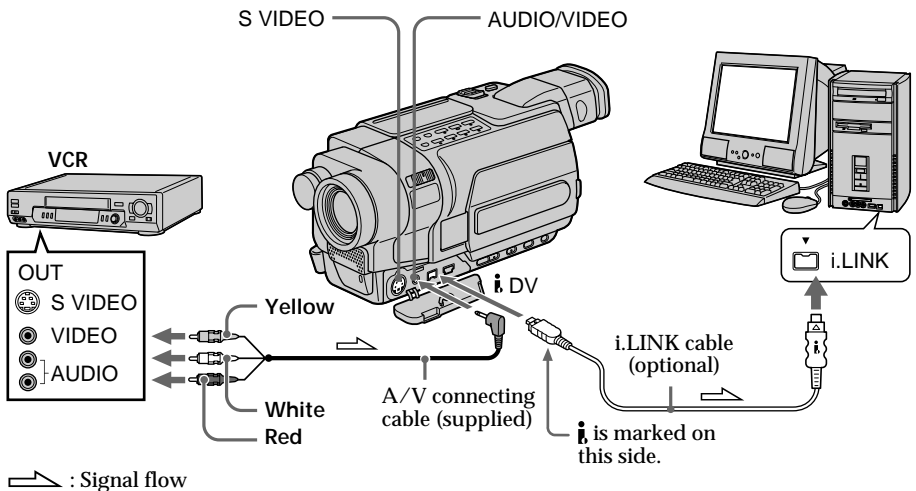

After capturing images and sound

Stop capturing procedures on your computer, and stop playback on the analog video unit.

Capturing images from an analog video unit on your computer – Signal convert function

Notes

- You need the software and computer that support the exchange of digital video signals.
- Depending on the state of the analog video signals, your computer may not be able to output images correctly when you convert analog video signals into digital video signals via your camcorder.
- You cannot record or capture video output via your camcorder when the video tapes include copyright protection signals such as the ID-2 system.

If your computer has a USB jack

You can connect your camcorder to your computer using the USB cable supplied with your camcorder. Note, however, that the image may flicker.

If your VCR has an S video jack

Pictures can be reproduced more faithfully by using an S video cable (optional).

With this connection, you do not need to connect the yellow (video) plug of the A/V connecting cable.

Connect an S video cable (optional) to the S video jacks of both your camcorder and the VCR.

Changing the menu settings

To change the mode settings in the menu settings, select the menu items with the SEL/PUSH EXEC dial. The default settings can be partially changed. First, select the icon, then the menu item and then the mode.

- (1) In CAMERA, VCR/PLAYER or MEMORY mode, press MENU to display the menu settings.*
- (2) Turn the SEL/PUSH EXEC dial to select the desired icon, then press the dial to set.
- (3) Turn the SEL/PUSH EXEC dial to select the desired item, then press the dial to set.
- (4) Turn the SEL/PUSH EXEC dial to select the desired mode, and press the dial to set.
- (5) If you want to change other items, select \rightarrow RETURN and press the dial, then repeat steps from (2) to (4).

For details, see “Selecting the mode setting of each item” (p. 211).

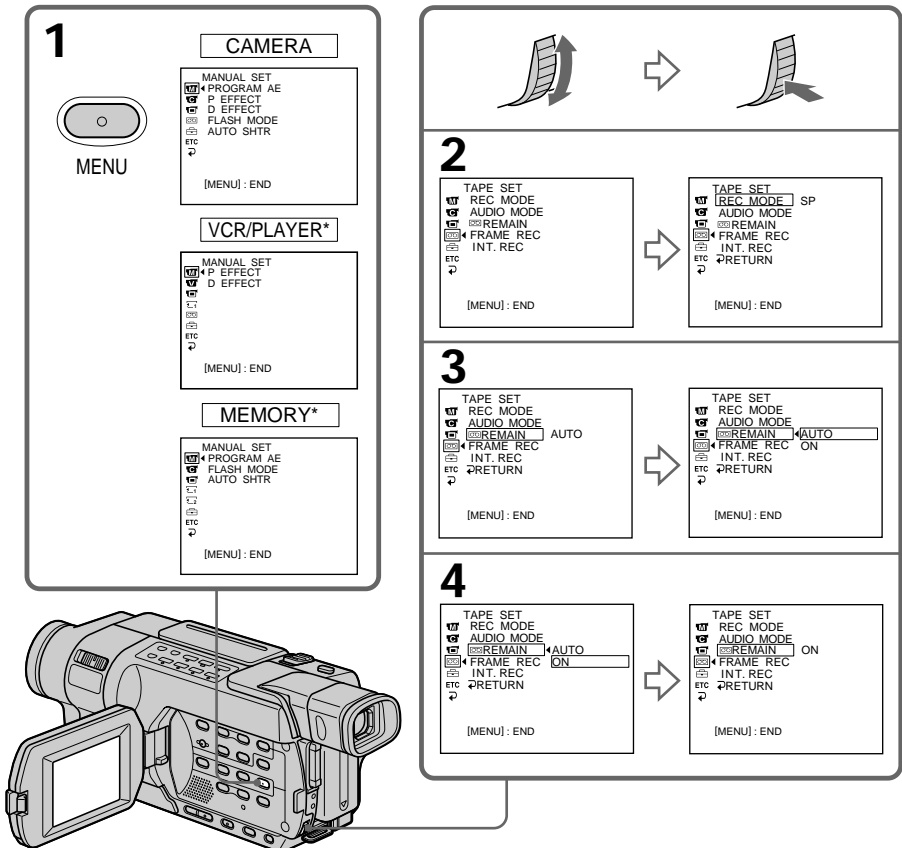











Changing the menu settings

To make the menu display disappear

Press MENU.

Menu items are displayed as the following icons:

| | |
|---|---|
|  | MANUAL SET |
|  | CAMERA SET |
|  | VCR SET 150 250 350 351 |
|  | PLAYER SET 118 318 418 |
|  | LCD SET |
|  | MEM SET 1 350 351 |
|  | MEM SET 2 350 351 |
|  | TAPE SET |
|  | SETUP MENU |
|  | OTHERS |

Depending on your camcorder model

The menu display may be different from that in this illustration.

Selecting the mode setting of each item ● is the default setting.

Menu items differ depending on the position of the POWER switch.

The screen shows only the items you can operate at the moment.

| Icon/item | Mode | Meaning | POWER switch ^{*1)} |
|---|------|---|-----------------------------|
|  MANUAL SET | | | |
| PROGRAM AE | — | To suit your specific shooting requirement (p. 68). | CAMERA MEMORY |
| P EFFECT (in recording) | — | To add special effects, like those in films or on TV, to images (p. 64). | CAMERA |
| P EFFECT (in playback) ^{*2)} | — | To add special effects, like those in films or on TV, to images (p. 83). | VCR |
| D EFFECT ^{*3)} | — | To add special effects using the various digital functions (p. 65, 85). | VCR CAMERA |
| FLASH MODE ^{*3)} | ● ON | To fire the flash (optional) regardless of the brightness of the surroundings. | CAMERA MEMORY |
| | AUTO | To fire the flash automatically. | |
| AUTO SHTR ^{*2)} | ● ON | To automatically activate the electronic shutter when shooting in bright conditions. | CAMERA MEMORY |
| | OFF | To not automatically activate the electronic shutter even when shooting in bright conditions. | |

^{*1)} Modes on the POWER switch vary depending on models (p. 16).

^{*2)} **150** **250** **350** **351**

^{*3)} **350** **351**

(continued on the following page)

Changing the menu settings

Notes on FLASH MODE *3)

- You cannot adjust FLASH MODE if the external flash (optional) is not compatible with the FLASH MODE.
- You cannot adjust FLASH MODE if the external flash (optional) is not connected.

Note on AUTO SHTR *2)

The Auto Shutter function electronically adjusts the shutter speed.

*1) Modes on the POWER switch vary depending on models (p. 16).

*2) **150** **250** **350** **351**

*3) **350** **351**

| Icon/item | Mode | Meaning | POWER switch *1) |
|---------------------|-----------|--|------------------|
| 📷 CAMERA SET | | | |
| SELFTIMER *2) | ● OFF | To not use the self-timer function. | CAMERA MEMORY |
| | ON | To use the self-timer function (p. 41, 55, 135, 149). | |
| D ZOOM *3) | ● OFF | To deactivate the digital zoom. Up to 20× zoom is performed. | CAMERA |
| | 40× | To activate the digital zoom. More than 20× to 40× zoom is performed digitally (p. 34). | |
| | 560× | To activate the digital zoom. More than 20× to 560× zoom is performed digitally (p. 34). | |
| | *4) ● OFF | To deactivate the digital zoom. Up to 20× zoom is performed. | CAMERA MEMORY |
| | 40× | To activate the digital zoom. More than 20× to 40× zoom is performed digitally (p. 34). | |
| | 700× | To activate the digital zoom. More than 20× to 700× zoom is performed digitally (p. 34). | |
| 16:9WIDE *5) | ● OFF | — | CAMERA |
| | ON | To record a 16:9 wide picture (p. 58). | |
| | *6) ● OFF | — | CAMERA |
| | CINEMA | To record in the CINEMA mode (p. 59). | |
| | 16:9FULL | To record in the 16:9FULL mode. | |

*1) Modes on the POWER switch vary depending on models (p. 16).

*2) **350** **351**

*3) **118** **318** **418** **150**

*4) **250** **350** **351**

*5) **150** **250** **350** **351**

*6) **118** **318** **418**

*7) **318** **418** **150** **250** **350** **351**

Changing the menu settings

| Icon/item | Mode | Meaning | POWER switch ^{*1)} |
|---|--------------------------------|--|-----------------------------|
| CAMERA SET | | | |
|  | STEADYSHOT ^{*7)} ● ON | To compensate for camera-shake. | CAMERA MEMORY |
| | OFF | To cancel the SteadyShot function. Natural pictures are produced when shooting a stationary subject with a tripod. | |
| N.S.LIGHT | ● ON | To use the NightShot Light function (p. 39). | CAMERA MEMORY |
| | OFF | To cancel the NightShot Light function. | |

Notes on the SteadyShot function ^{*7)}

- The SteadyShot function will not correct excessive camera-shake.
- Attachment of a conversion lens (optional) may influence the SteadyShot function.

If you cancel the SteadyShot function ^{*7)}

The SteadyShot off indicator  appears on the screen. Your camcorder prevents excessive compensation for camera-shake.

^{*1)} Modes on the POWER switch vary depending on models (p. 16).

^{*2)}  

^{*3)}    

^{*4)}   

^{*5)}    

^{*6)}   

^{*7)}      

Changing the menu settings

| Icon/item | Mode | Meaning | POWER switch ^{*1)} |
|---|----------|---|-----------------------------|
| VCR SET 150 250 350 351 | | | |
| PLAYER SET 118 318 418 | | | |
| HiFi SOUND ^{*2)} | ● STEREO | To play back a stereo tape or dual sound track tape with main and sub sound (p. 238). | VCR |
| | 1 | To play back a stereo tape with the left sound or a dual sound track tape with main sound. | |
| | 2 | To play back a stereo tape with the right sound or a dual sound track tape with sub sound. | |
| EDIT ^{*3)} | ● OFF | — | PLAYER |
| | ON | To minimize picture deterioration when editing. | |
| TBC ^{*4) *5)} | ● ON | To correct jitter. | VCR/ PLAYER |
| | OFF | To not correct jitter. Set TBC to OFF when playing back a tape on which you have dubbed over and recorded the signal of a TV game or similar machine. | |
| TBC stands for "Time Base Corrector." | | | |
| DNR ^{*4) *5)} | ● ON | To reduce picture noise. | VCR/ PLAYER |
| | OFF | To reduce a conspicuous afterimage when the picture has a lot of movement. | |
| DNR stands for "Digital Noise Reduction." | | | |
| AUDIO MIX ^{*2)} | — | To adjust the balance between the stereo 1 and stereo 2. | VCR |
| | | | |
| A/V → DV OUT ^{*6)} | ● OFF | To output digital images and sound in analog format using your camcorder. | VCR |
| | ON | To output analog images and sound in digital format using your camcorder (p. 208). | |

^{*1)} Modes on the POWER switch vary depending on models (p. 16).

^{*2)} **150** **250** **350** **351**

^{*3)} **118** **318** **418**

^{*4)} **118** **318** **418** **350** **351**

^{*5)} When you play back tapes recorded in the Hi8 /standard 8 mm system only

^{*6)} **350** **351**

Changing the menu settings

| Icon/item | Mode | Meaning | POWER switch *1) |
|-------------|--------|--|------------------|
| VCR SET | | | |
| PLAYER SET | | | |
| PB MODE *6) | ● AUTO | To automatically select the system (Hi8 / standard 8 mm or Digital8) that was used to record on the tape, and play back the tape. | VCR |
| | | To play back a tape that was recorded in the Hi8 / standard 8 mm system when your camcorder does not automatically distinguish the recording system. | |

After five minutes of removing the power source

The HiFi SOUND *2), EDIT *3) and AUDIO MIX *2) items are returned to their default settings.

Notes on AUDIO MIX *2)

- You can adjust the balance only for tapes recorded in the Digital8 system.
- When playing back a tape recorded in the 16-bit mode, you cannot adjust the balance.

Note on PB MODE *6)

The mode will return to the default setting when:

- you remove the power source.
- you turn the POWER switch.

*1) Modes on the POWER switch vary depending on models (p. 16).

*2)



*3)

*4)

*5) When you play back tapes recorded in the Hi8 / standard 8 mm system only

*6)

Changing the menu settings

| Icon/item | Mode | Meaning | POWER switch * |
|----------------|--------------|---|------------------------------------|
| LCD SET | | | |
| LCD BRIGHT | — | To adjust the brightness on the LCD screen with the SEL/PUSH EXEC dial.  To darken ← → To lighten | VCR/ PLAYER CAMERA MEMORY |
| LCD B.L. | ● BRT NORMAL | To set the brightness of the LCD screen backlight to normal. | VCR/ PLAYER CAMERA MEMORY |
| | BRIGHT | To brighten the LCD screen backlight. | |
| LCD COLOR | — | To adjust the color on the LCD screen, turning the SEL/PUSH EXEC dial to adjust the following bar.  To get low-intensity ← → To get high-intensity | VCR/ PLAYER CAMERA MEMORY |

Notes on LCD B.L.

- When you select BRIGHT, battery life is reduced by about 10 percent during recording.
- When you use power sources other than the battery pack, BRIGHT is automatically selected.

Even if you adjust LCD BRIGHT, LCD B.L., LCD COLOR



The recorded picture will not be affected.

* Modes on the POWER switch vary depending on models (p. 16).

Changing the menu settings

| Icon/item | Mode | Meaning | POWER switch |
|------------------|-----------------------|--|---------------|
| MEM SET 1 | 350 351 | | |
| STILL SET | | | |
| QUALITY | ● FINE | To record still images in fine image quality mode (p. 128). | VCR MEMORY |
| | STANDARD | To record still images in standard image quality mode. | |
| FLD/FRAME | ● FIELD | To record moving subjects correcting jitter (p. 132). | MEMORY |
| | FRAME | To record stationary subjects in high quality. | |
| MOVIE SET | | | |
| IMAGESIZE | ● 320 × 240 | To record moving pictures in 320 × 240 size (p. 130). | VCR MEMORY |
| | 160 × 112 | To record moving pictures in 160 × 112 size. | |
| REMAIN | ● AUTO | To display the remaining capacity of the “Memory Stick” in the following cases: <ul style="list-style-type: none"> • For five seconds after you set the POWER switch to VCR or MEMORY. • For five seconds after inserting a “Memory Stick” into your camcorder. • When the capacity of the “Memory Stick” is less than a few minutes in MEMORY mode. • For five seconds after you start recording a moving picture. • For five seconds after you stop recording a moving picture. | VCR MEMORY |
| | ON | To always display the remaining capacity of the “Memory Stick.” | |
| NEW FOLDER | ● ADD | To create a new folder (p. 160). | MEMORY |
| | RETURN | To cancel creating a new folder. | |
| REC FOLDER | — | To select a folder in which images are recorded (p. 162). | MEMORY |
| FILE NO. | ● SERIES | To assign numbers to files in sequence even if the “Memory Stick” is changed. However, when a new folder is created or the recording folder is changed, the file number sequence is reset. | VCR MEMORY |
| | RESET | To reset the file numbering each time the “Memory Stick” is changed. | |
| PRINT MARK | ON | To write a print mark on recorded still images you want to print out later (p. 180). | VCR MEMORY |
| | ● OFF | To cancel print marks on still images. | |
| PROTECT | ON | To protect selected images against accidental erasure (p. 176). | VCR MEMORY |
| | ● OFF | To not protect images. | |
| PB FOLDER | — | To select a folder that contains images to be played back (p. 169). | MEMORY |

Changing the menu settings

| Icon/item | Mode | Meaning | POWER switch |
|---|----------------|---|--------------|
|  MEM SET 2   | | | |
| SLIDE SHOW | RETURN | To cancel the slide show. | MEMORY |
| | ● ALL FILES | To play back all images in the “Memory Stick” continuously (p. 174). | |
| | FOLDER □□□ *1) | To play back all images in the current PB folder continuously. | |
| INT.R -STL | ON | To activate the interval photo recording function (p. 154). | MEMORY |
| | ● OFF | To deactivate the interval photo recording function. | |
| | SET | To set INTERVAL for interval photo recording. | |
| DELETE ALL | ● RETURN | To cancel deleting all images. | MEMORY |
| | ALL FILES | To delete all unprotected images in the “Memory Stick” (p. 178). | |
| | FOLDER □□□ *1) | To delete all unprotected images in the current PB folder. | |
| FORMAT | ● RETURN | To cancel formatting. | MEMORY |
| | OK | To format an inserted “Memory Stick.” Formatting erases all information on a “Memory Stick.” 1. Select FORMAT with the SEL/PUSH EXEC dial, then press the dial. 2. Select OK with the SEL/PUSH EXEC dial, then press the dial. 3. After EXECUTE appears, press the SEL/PUSH EXEC dial. The FORMATTING indicator flashes during formatting. The COMPLETE indicator appears when formatting is finished. | |

Notes on formatting

- Formatting erases all folders.
- Formatting erases all images even if they are protected.
- The supplied “Memory Stick” has been formatted at factory. Formatting the “Memory Stick” on your camcorder is not required.*2)
- Do not do any of the following while the FORMATTING indicator is displayed:
 - Switch the POWER switch
 - Operate buttons
 - Eject the “Memory Stick”
 - Remove the power source
- You cannot format the “Memory Stick” if the write-protect tab on the “Memory Stick” is set to LOCK.
- Format the “Memory Stick” when “ FORMAT ERROR” is displayed.

*1) □□□ stands for the folder number.

*2) 

Changing the menu settings

| Icon/item | Mode | Meaning | POWER switch *1) |
|--|---------|---|--------------------------|
| TAPE SET | | | |
| REC MODE | ● SP | To record in the SP (Standard Play) mode. | VCR CAMERA |
| | LP | To increase the recording time to 1.5 *2)/2 *3) times the SP mode. | |
| AUDIO MODE *2) | ● 12BIT | To record in the 12-bit mode (two stereo sounds). | VCR *4) CAMERA |
| | 16BIT | To record in the 16-bit mode (one stereo sound with high quality). | |
| ORC TO SET *3) | — | To automatically adjust the recording condition to get the best possible recording. Press START/STOP to start adjustment. Your camcorder takes about 10 seconds to check the tape condition and then returns to the standby mode. | CAMERA |
| ORC stands for "Optimizing the Recording Condition." | | | |
| REMAIN | ● AUTO | To display the remaining tape bar: <ul style="list-style-type: none"> • For about eight seconds after your camcorder is turned on and calculates the remaining amount of tape. • For about eight seconds after a cassette is inserted and your camcorder calculates the remaining amount of tape. • For about eight seconds after ► is pressed in VCR/PLAYER mode. • For about eight seconds after DISPLAY is pressed to display the screen indicators. • For the period of tape rewinding, forwarding or picture search in VCR/PLAYER mode. | VCR/ PLAYER CAMERA |
| | ON | To always display the remaining tape bar. | |
| FRAME REC *2) | ● OFF | To deactivate the frame recording. | CAMERA |
| | ON | To activate the frame recording (p. 74). | |
| INT. REC *2) | ON | To activate the interval recording function (p. 72). | CAMERA |
| | ● OFF | To deactivate the interval recording function. | |
| | SET | To set INTERVAL and REC TIME for interval recording. | |

*1) Modes on the POWER switch vary depending on models (p. 16).

*2) **150** **250** **350** **351**

*3) **118** **318** **418**

*4) **350** **351**

(continued on the following page)

Changing the menu settings

Notes on the LP mode

- When you record a tape in the LP mode on your camcorder, we recommend playing back the tape on your camcorder. When you playback the tape recorded on another camcorder or VCR, noise may occur in images or sounds.
- When you record in the LP mode, we recommend using a Sony cassette so that you can get the most out of your camcorder.
- When you record in the SP and LP modes on one tape or you record some scenes in the LP mode, the playback picture may be distorted or the time code may not be written properly between scenes.*²⁾
- Noise may occur also when you play back on your camcorder tapes recorded in the LP mode on another camcorder or VCR.*³⁾
- When you record a tape in the LP mode on your camcorder, recording is carried out in the standard 8 mm **8** system.*³⁾

Note on AUDIO MODE *²⁾

When playing back a tape recorded in the 16-bit mode, you cannot adjust the balance in AUDIO MIX.

Note on dubbing a tape to another VCR *⁴⁾

You cannot select AUDIO MODE for tapes recorded in the Digital8 **8** system. You, however, can select AUDIO MODE when you dub tapes recorded in the Hi8 **Hi8**/standard 8 mm **8** system to another VCR using the i.LINK cable.

Notes on ORC setting *³⁾

- Each time you eject the cassette, the ORC setting will be canceled. If necessary, set the setting.
- You cannot use this setting on a tape with the red mark on the cassette exposed. (i. e. the tape is write-protected)
- When you set ORC TO SET, a non-recorded section of about 0.1 seconds appears on the tape. However, note that this non-recorded section disappears from the tape when you continue recording from this section.
- To check if you have already set the ORC setting, select ORC TO SET in the menu settings. "ORC ON" is displayed if ORC TO SET is already set.

*¹⁾ Modes on the POWER switch vary depending on models (p. 16).

*²⁾ **150** **250** **350** **351**

*³⁾ **118** **318** **418**

*⁴⁾ **350** **351**

Changing the menu settings

| Icon/item | Mode | Meaning | POWER switch ^{*1)} |
|--|-----------|--|------------------------------------|
|  SETUP MENU | | | |
| CLOCK SET | — | To set the date or time (p. 26). | CAMERA MEMORY |
| AUTO DATE ^{*2)} | ● ON | To record the date for 10 seconds after recording has started. | CAMERA |
| | OFF | To cancel the auto date function. | |
| USB STREAM ^{*3)} | ● OFF | To deactivate the USB Streaming function. | VCR CAMERA |
| | ON | To activate the USB Streaming function. | |
| LTR SIZE | ● NORMAL | To display selected menu items in normal size. | VCR/ PLAYER CAMERA MEMORY |
| | 2× | To display selected menu items at twice the normal size. | |
| LANGUAGE | ● ENGLISH | To display the information indicators in English. | VCR/ PLAYER CAMERA MEMORY |
| | FRANÇAIS | To display the some of the information indicators in French. | |
| | ESPAÑOL | To display the some of the information indicators in Spanish. | |
| | PORTUGUÊS | To display the some of the information indicators in Portuguese. | |
| | 中文 | To display the some of the information indicators in Chinese. | |
| | 한국어 | To display the some of the information indicators in Korean. | |
| DEMO MODE | ● ON | To make the demonstration appear. | CAMERA |
| | OFF | To cancel the demonstration mode. | |



Notes on DEMO MODE

- You cannot select DEMO MODE when a “Memory Stick” is inserted in your camcorder. ^{*4)}
- You cannot select DEMO MODE when a cassette is inserted in your camcorder.
- The DEMO MODE default setting is STBY (Standby), and the demonstration starts about 10 minutes after you have set the POWER switch to CAMERA without a cassette inserted.

To cancel the demonstration, insert a “Memory Stick”^{*4)} or a cassette, set the POWER switch to anything other than CAMERA, or set DEMO MODE to OFF. To set to STBY (Standby) again, leave the DEMO MODE at ON in the menu settings, turn the POWER switch to OFF (CHG), and return the POWER switch to CAMERA.

- When NIGHTSHOT is set to ON, “NIGHTSHOT” appears on the screen and you cannot select DEMO MODE in the menu settings.

*1) Modes on the POWER switch vary depending on models (p. 16).

*2)   

*3)   

*4)  

Changing the menu settings

| Icon/item | Mode | Meaning | POWER switch *1) |
|-------------------|------------|---|------------------------------------|
| ETC OTHERS | | | |
| DATA CODE *2) | ● DATE/CAM | To display date, time and recording data during playback. | VCR MEMORY |
| | DATE | To display date and time during playback. | |
| WORLD TIME | — | To set the clock to the local time. Turn the SEL/PUSH EXEC dial to set a time difference. The clock changes by the time difference you set here. If you set the time difference to 0, the clock returns to the originally set time. | CAMERA MEMORY |
| BEEP | ● MELODY | To output the melody when you start/stop recording or when an unusual condition occurs on your camcorder. | VCR/ PLAYER CAMERA MEMORY |
| | NORMAL | To output the beep instead of the melody. | |
| | OFF | To cancel all sound including shutter sound. | |
| COMMANDER *3) | ● ON | To activate the Remote Commander supplied with your camcorder. | VCR/ PLAYER CAMERA MEMORY |
| | OFF | To deactivate the Remote Commander to avoid erroneous remote control operation caused by other VCR's remote control. | |
| DISPLAY | ● LCD | To show the display on the LCD screen and in the viewfinder. | VCR/ PLAYER CAMERA MEMORY |
| | V-OUT/LCD | To show the display on the TV screen, LCD screen and in the viewfinder. | |
| REC LAMP | ● ON | To light up the camera recording lamp at the front of your camcorder. | CAMERA MEMORY |
| | OFF | To turn the camera recording lamp off so that the person is not aware of the recording. | |

*1) Modes on the POWER switch vary depending on models (p. 16).

*2) 250 350 351

*3) 418 250 350 351

*4) 350 351

*5) 150 250

Changing the menu settings

| Icon/item | Mode | Meaning | POWER switch ^{*1)} |
|-------------------|-------------------------|---|-----------------------------|
| ETC OTHERS | | | |
| VIDEO EDIT | ^{*4)} ● RETURN | To cancel video editing. | VCR |
| | TAPE | To make a program and perform video editing (p. 106). | |
| | MEMORY | To make a program and perform MPEG editing (p. 156). | |
| | ^{*5)} — | To make a program and perform video editing (p. 106). | VCR |

Note ^{*4)}

If you press DISPLAY with DISPLAY set to V-OUT/LCD in the menu settings, the picture from a TV or VCR will not appear on the screen even when your camcorder is connected to outputs on the TV or VCR. (Except when your camcorder is connected with the i.LINK cable)

After five minutes of removing the power source ^{*3)}

The COMMANDER item returns to their default settings.

When recording a close subject

When REC LAMP is set to ON, the red camera recording lamp on the front of the camcorder may reflect on the subject if it is close. In this case, we recommend that you set REC LAMP to OFF.

^{*1)} Modes on the POWER switch vary depending on models (p. 16).

^{*2)} **250** **350** **351**

^{*3)} **418** **250** **350** **351**

^{*4)} **350** **351**

^{*5)} **150** **250**



Types of trouble and how to correct trouble

If you run into any problem using your camcorder, use the following table to troubleshoot the problem. If the problem persists, disconnect the power source and contact your Sony dealer or local authorized Sony service facility. If “C:□□:□□” appears on the screen, the self-diagnosis display function has worked. See page 232.

In the recording mode

| Symptom | Cause and/or Corrective Action |
|--|---|
| START/STOP does not operate. | <ul style="list-style-type: none"> The POWER switch is not set to CAMERA. → Set it to CAMERA (p. 30). The tape has run out. → Rewind the cassette or insert a new one (p. 28, 45). The write-protect tab is set to expose the red mark. → Use a new tape or slide the tab (p. 29). The tape is stuck to the drum (moisture condensation). → Remove the cassette and leave your camcorder for at least one hour to acclimatize (p. 247). |
| The power goes off. | <ul style="list-style-type: none"> While being operated in CAMERA mode, your camcorder has been in the standby mode for more than three minutes *¹⁾/five minutes *²⁾. → Set the POWER switch to OFF (CHG) and then to CAMERA again (p. 30). The battery pack is dead or nearly dead. → Install a charged battery pack (p. 18, 19). |
| The image on the viewfinder screen is not clear. | <ul style="list-style-type: none"> The viewfinder lens is not adjusted. → Adjust the viewfinder lens (p. 35). |
| The SteadyShot function does not work.* ³⁾ | <ul style="list-style-type: none"> STEADYSHOT is set to OFF in the menu settings. → Set it to ON (p. 213). 16:9WIDE is set to ON in the menu settings.*¹⁾ → Set it to OFF (p. 212). 16:9WIDE is set to 16:9FULL.*²⁾ → Set it to OFF (p. 212). |
| The autofocus function does not work. | <ul style="list-style-type: none"> The setting is the manual focus mode. → Set the autofocus mode (p. 71). Shooting conditions are not suitable for autofocus. → Adjust to focus manually (p. 71). |
| The  indicator flashes in the viewfinder. | <ul style="list-style-type: none"> The video heads may be dirty. → Clean the heads using the Sony V8-25CLD cleaning cassette (optional) (p. 248). |

*¹⁾    

*²⁾   

*³⁾      

*⁴⁾  

Types of trouble and how to correct trouble

| Symptom | Cause and/or Corrective Action |
|--|---|
| The picture does not appear in the viewfinder. | <ul style="list-style-type: none"> The LCD panel is open. → Close the LCD panel when you do not record using the LCD screen (p. 32). |
| A vertical band appears when you shoot a subject such as lights or a candle flame against a dark background. | <ul style="list-style-type: none"> The contrast between the subject and background is too high. This is not a malfunction. |
| A vertical band appears when you shoot a very bright subject. | <ul style="list-style-type: none"> The smear phenomenon is occurring. This is not a malfunction. |
| Some tiny white, red, blue or green spots appear on the screen.*4) | <ul style="list-style-type: none"> Slow shutter, Super NightShot or Color Slow Shutter mode is activated. This is not a malfunction. |
| An unknown picture is displayed on the screen. | <ul style="list-style-type: none"> If 10 minutes passes after you set the POWER switch to CAMERA or DEMO MODE is set to ON in the menu settings without a "Memory Stick" *4) or a cassette inserted, your camcorder automatically starts the demonstration. → Insert a "Memory Stick" *4) or a cassette and the demonstration stops. You can also cancel DEMO MODE (p. 221). |
| The picture is recorded in incorrect or unnatural colors. | <ul style="list-style-type: none"> NIGHTSHOT is set to ON. → Set it to OFF (p. 39). |
| Picture appears too bright, and the subject does not appear on the screen. | <ul style="list-style-type: none"> NIGHTSHOT is set to ON in a bright place. → Set it to OFF (p. 39). The backlight function is active. → Deactivate the backlight function (p. 38). |
| The shutter does not sound.*4) | <ul style="list-style-type: none"> BEEP is set to OFF in the menu settings. → Set it to MELODY or NORMAL (p. 222). |
| A horizontal black band appears when shooting a TV screen or a computer screen.*3) | <ul style="list-style-type: none"> Set STEADYSHOT to OFF in the menu settings (p. 213). |
| An external flash (optional) does not work.*4) | <ul style="list-style-type: none"> The power of the external flash is off or the power source is not installed. → Turn on the external flash or install the power source. AUTO is selected in FLASH MODE in the menu settings while recording in a bright place. → Set it to ON (p. 211). |

*1) **150** **250** **350** **351**

*2) **118** **318** **418**

*3) **318** **418** **150** **250** **350** **351**

*4) **350** **351**

Types of trouble and how to correct trouble

In the playback mode

| Symptom | Cause and/or Corrective Action |
|--|---|
| The picture does not appear on the screen when playing back a tape.* ¹⁾ | <ul style="list-style-type: none"> The tape is recorded in the Hi8 Hi8/Standard 8 mm 8 system. |
| The tape does not move when a video control button is pressed. | <ul style="list-style-type: none"> The POWER switch is set to MEMORY, CAMERA or OFF (CHG).*²⁾ <ul style="list-style-type: none"> → Set it to VCR/PLAYER *²⁾ (p. 45). |
| The playback button does not work. | <ul style="list-style-type: none"> The cassette has run out of tape. <ul style="list-style-type: none"> → Rewind the tape (p. 45). |
| There are horizontal lines on the picture. The playback picture is not clear or does not appear. | <ul style="list-style-type: none"> The television's video channel is not adjusted correctly. <ul style="list-style-type: none"> → Adjust it *³⁾ (p. 51). EDIT is set to ON in the menu settings. <ul style="list-style-type: none"> → Set it to OFF *³⁾ (p. 214). The video head may be dirty. <ul style="list-style-type: none"> → Clean the heads using the Sony V8-25CLD cleaning cassette (optional) (p. 248). |
| No sound or only a low sound is heard when playing back a tape. | <ul style="list-style-type: none"> The stereo tape is played back with HiFi SOUND set to 2 in the menu settings.*⁴⁾ <ul style="list-style-type: none"> → Set it to STEREO (p. 214). The volume is turned to minimum. <ul style="list-style-type: none"> → Press VOLUME + (p. 45). AUDIO MIX is set to the ST2 side in the menu settings.*⁴⁾ <ul style="list-style-type: none"> → Adjust AUDIO MIX (p. 214). |
| The date search does not work correctly.* ⁵⁾ | <ul style="list-style-type: none"> The tape has a blank portion between recorded portions (p. 90). |
| The picture which is recorded in the Digital8 8 system is not played back.* ⁶⁾ | <ul style="list-style-type: none"> PB MODE is set to Hi8/8 in the menu settings. <ul style="list-style-type: none"> → Set it to AUTO (p. 215). |
| The tape which is recorded in the Hi8 Hi8 /standard 8 mm 8 system is not played back correctly.* ⁶⁾ | <ul style="list-style-type: none"> → Set PB MODE to Hi8/8 in the menu settings (p. 215). |
| "PAL" is displayed on the screen.* ⁴⁾ | <ul style="list-style-type: none"> The TV color system recorded on the tape is different from that of your camcorder. |

*1) **150** **250**

*2) Modes on the POWER switch vary depending on models (p. 16).

*3) **118** **318** **418**



*4) **150** **250** **350** **351**

*5) **250** **350** **351**

*6) **350** **351**

Types of trouble and how to correct trouble

In the recording and playback modes

| Symptom | Cause and/or Corrective Action |
|--|--|
| Your camcorder does not function even when the POWER switch is set to a position other than OFF (CHG). | <ul style="list-style-type: none">• The battery pack is not installed, or is dead or nearly dead. → Install a charged battery pack (p. 18, 19).• The AC Adaptor is not connected to a wall outlet. → Connect the AC Adaptor to a wall outlet (p. 24). |
| The end search function does not work. | <ul style="list-style-type: none">• The tape was ejected after recording.• You have not recorded on the new cassette yet. |
| The end search function does not work correctly. | <ul style="list-style-type: none">• The tape has a blank portion at the beginning or midway. |
| The battery pack is quickly discharged. | <ul style="list-style-type: none">• The operating temperature is too low.• The battery pack is not charged enough. → Charge the battery pack fully again (p. 19).• The battery pack is completely dead, and cannot be recharged. → Replace with a new battery pack (p. 18). |
| The remaining battery time indicator does not indicate the correct time. | <ul style="list-style-type: none">• You have used the battery pack in an extremely hot or cold environment for a long time.• The battery pack is completely dead, and cannot be recharged. → Replace with a new battery pack (p. 18).• The battery is dead. → Use a fully charged battery pack (p. 18, 19).• A deviation has occurred in the remaining battery time. → Charge the battery pack fully so that the remaining battery time indicator indicates correct time (p. 19). |
| The power goes off although the remaining battery time indicator indicates that the battery pack has enough power to operate. | <ul style="list-style-type: none">• A deviation has occurred in the remaining battery time. → Charge the battery pack fully so that the remaining battery time indicator indicates correct time (p. 19). |
| The cassette cannot be removed from the holder. | <ul style="list-style-type: none">• The power source is disconnected. → Connect it firmly (p. 18, 24).• The battery is dead. → Use a charged battery pack (p. 18, 19). |
| The  and  indicators flash and no functions except for cassette ejection work. | <ul style="list-style-type: none">• Moisture condensation has occurred. → Remove the cassette and leave your camcorder for at least one hour to acclimatize (p. 247). |
| The remaining tape indicator is not displayed. | <ul style="list-style-type: none">• The  REMAIN is set to AUTO in the menu settings. → Set it to ON to always display the remaining tape indicator. |

Types of trouble and how to correct trouble

When operating using the "Memory Stick" **350** **351**

| Symptom | Cause and/or Corrective Action |
|---|--|
| The "Memory Stick" does not function. | <ul style="list-style-type: none"> • The POWER switch is not set to MEMORY. → Set it to MEMORY (p. 132). • The "Memory Stick" is not inserted. → Insert a "Memory Stick" (p. 127). |
| Recording does not function. | <ul style="list-style-type: none"> • The "Memory Stick" is full. → Delete unnecessary images and record again (p. 177). • The "Memory Stick" formatted incorrectly is inserted. → Format the "Memory Stick" on your camcorder or use another "Memory Stick" (p. 127, 218). • The write-protect tab on the "Memory Stick" is set to LOCK. → Release the lock (p. 240). |
| An image cannot be deleted. | <ul style="list-style-type: none"> • The image is protected. → Cancel image protection (p. 176). • The write-protect tab on the "Memory Stick" is set to LOCK. → Release the lock (p. 240). |
| You cannot format a "Memory Stick." | <ul style="list-style-type: none"> • The write-protect tab on the "Memory Stick" is set to LOCK. → Release the lock (p. 240). |
| Deleting all the images cannot be carried out. | <ul style="list-style-type: none"> • The write-protect tab on the "Memory Stick" is set to LOCK. → Release the lock (p. 240). |
| You cannot protect an image. | <ul style="list-style-type: none"> • The write-protect tab on the "Memory Stick" is set to LOCK. → Release the lock (p. 240). • The image to protect is not played back. → Press MEMORY PLAY to play back the image (p. 163). |
| You cannot write a print mark on a still image. | <ul style="list-style-type: none"> • The write-protect tab on the "Memory Stick" is set to LOCK. → Release the lock (p. 240). • The image to write a print mark to is not played back. → Press MEMORY PLAY to play back the image (p. 163). • You are trying to write a print mark on a moving picture. → Print marks cannot be written on a moving picture. |
| You cannot play back images in actual size. | <ul style="list-style-type: none"> • You may not be able to play back images in actual size when you try to play back images recorded by other equipment. This is not a malfunction. |
| You cannot play back image data. | <ul style="list-style-type: none"> • Folders/files renamed or images processed with your computer may not be played back. (The file name will blink.) • If you record images with any other equipment, the images may not play back normally on your camcorder. |

Types of trouble and how to correct trouble

Others

| Symptom | Cause and/or Corrective Action |
|---|---|
| Easy Dubbing does not function.* ¹⁾ | <ul style="list-style-type: none"> Your VCR and/or video camera recorder is not set correctly. <ul style="list-style-type: none"> → Make sure the input selector of the VCR is set to LINE. Also, make sure the power switch of the video camera is set to VTR/VCR (p. 99). The IR SETUP code or PAUSE MODE is not set correctly. <ul style="list-style-type: none"> → Select the correct IR SETUP code and PAUSE MODE, according to your VCR. Then confirm VCR operation with the IR TEST function (p. 99). |
| Digital program editing to a tape does not function.* ²⁾ | <ul style="list-style-type: none"> The input selector on the VCR is not set correctly. <ul style="list-style-type: none"> → Check the connection and set the input selector on the VCR again (p. 107). Your camcorder is connected to DV equipment of other than Sony using the i.LINK cable. <ul style="list-style-type: none"> → Set it to IR (p. 107). You have attempted to set a program on a blank portion of the tape. <ul style="list-style-type: none"> → Set the program again on a recorded portion (p. 115). Your camcorder and the VCR are not synchronized. <ul style="list-style-type: none"> → Adjust the synchronization (p. 113). The IR SETUP code is incorrect. <ul style="list-style-type: none"> → Set the correct code (p. 101). PB MODE is set to Hi 8/8 in the menu settings.*³⁾ <ul style="list-style-type: none"> → Set it to AUTO (p. 215). |
| Digital program editing to a "Memory Stick" does not function.* ³⁾ | <ul style="list-style-type: none"> Setting program on a blank portion of the tape is attempted. <ul style="list-style-type: none"> → Set the program again on a recorded portion (p. 156). |
| The Remote Commander supplied with your camcorder does not work.* ⁴⁾ | <ul style="list-style-type: none"> COMMANDER is set to OFF in the menu settings. <ul style="list-style-type: none"> → Set it to ON (p. 222). Something is blocking the infrared rays. <ul style="list-style-type: none"> → Remove the obstacle. The batteries are inserted with + and - incorrectly matching + and - inside the battery compartment. <ul style="list-style-type: none"> → Insert the batteries correctly (p. 264). The batteries are dead. <ul style="list-style-type: none"> → Insert new ones (p. 264). |

- *¹⁾ **118** **318** **418**
 *²⁾ **150** **250** **350** **351**
 *³⁾ **350** **351**
 *⁴⁾ **418** **250** **350** **351**
 *⁵⁾ **250** **350** **351**

(continued on the following page)

Types of trouble and how to correct trouble

| Symptom | Cause and/or Corrective Action |
|---|---|
| The picture from a TV or VCR does not appear on the screen even when your camcorder is connected to the outputs of other equipment (connected with the A/V cable).*3) | <ul style="list-style-type: none"> • DISPLAY is set to V-OUT/LCD in the menu settings. → Set it to LCD (p. 222). |
| The melody or beep sounds for five seconds. | <ul style="list-style-type: none"> • Moisture condensation has occurred. → Eject the cassette and leave your camcorder for at least one hour to acclimatize (p. 247). • Some trouble has occurred in your camcorder. → Eject the cassette and insert it again, then operate your camcorder. |
| You cannot charge the battery pack. | <ul style="list-style-type: none"> • The POWER switch is not set to OFF (CHG). → Set it to OFF (CHG). |
| The BATTERY INFO is not displayed. | <ul style="list-style-type: none"> • The POWER switch is not set to OFF (CHG). → Set it to OFF (CHG). • The battery pack is not installed properly. → Install it properly (p. 18). • The battery pack is fully discharged. → Install a fully charged battery pack. |
| No function works though the power is on. | <ul style="list-style-type: none"> → Disconnect the power cord of the AC Adaptor or remove the battery, then reconnect it in about one minute. Turn the power on. If the functions still do not work, open the LCD panel and press the RESET button using a sharp-pointed object. (If you press the RESET button, all the settings including the date and time return to their defaults.) (p. 258) |
| You cannot install the USB driver.*5) | <ul style="list-style-type: none"> • Your camcorder was connected to your computer with the USB cable before installing the USB driver, so the driver was not recognized by the computer. → Uninstall the unrecognized driver, and then reinstall the driver (p. 194). |

- *1)   
- *2)    
- *3)  
- *4)    
- *5)   

Types of trouble and how to correct trouble

| Symptom | Cause and/or Corrective Action |
|--|---|
| USB Streaming does not work.*5) | <ul style="list-style-type: none"> The USB driver is not installed correctly. <ul style="list-style-type: none"> → Uninstall the unrecognized driver, and then reinstall the driver (p. 194). Your computer's operating system is Windows 98 or earlier. USB STREAM is set to OFF in the menu settings. <ul style="list-style-type: none"> → Set it to ON. USB Streaming does not work when: <ul style="list-style-type: none"> – you record MPEG movie on a "Memory Stick."**3) – you record a photo on a "Memory Stick."**3) |
| Image data cannot be transferred by the USB connection.*5) | <ul style="list-style-type: none"> The USB cable was connected before installation of the USB driver was completed. <ul style="list-style-type: none"> → Uninstall the incorrect USB driver and reinstall the USB driver (p. 194). |
| The cassette cannot be removed even if the cassette lid is open. | <ul style="list-style-type: none"> Moisture has started to condense in your camcorder (p. 247). |

- *1) 
 *2) 
 *3) 
 *4) 
 *5) 

Self-diagnosis display

Your camcorder has a self-diagnosis display function.

This function displays the current state of your camcorder as a 5-digit code (a combination of a letter and numbers) on the screen.

If a 5-digit code is displayed, check the following list of codes. The last two digits (indicated by □□) differ depending on the state of your camcorder.

LCD screen or viewfinder

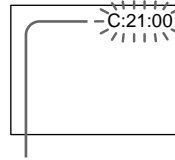

Self-diagnosis display

- C:□□:□□
You can service your camcorder yourself.
- E:□□:□□
Contact your Sony dealer or local authorized Sony service facility.

| 5-digit display | Cause and/or Corrective Action |
|-----------------|---|
| C:04:□□ | <ul style="list-style-type: none"> • You are using a battery pack that is not an "InfoLITHIUM" battery pack. → Use an "InfoLITHIUM" battery pack (p. 21, 242). |
| C:21:□□ | <ul style="list-style-type: none"> • Moisture condensation has occurred. → Eject the cassette and leave your camcorder for at least one hour to acclimatize (p. 247). |
| C:22:□□ | <ul style="list-style-type: none"> • The video heads are dirty. → Clean the heads using the Sony V8-25CLD cleaning cassette (optional) (p. 248). |
| C:31:□□ | <ul style="list-style-type: none"> • A malfunction other than the above that you can service has occurred. → Eject the cassette and insert it again, then operate your camcorder. → Disconnect the power cord of the AC Adaptor or remove the battery pack. After reconnecting the power source, operate your camcorder. |
| C:32:□□ | |
| E:20:□□ | <ul style="list-style-type: none"> • A malfunction that you cannot service has occurred. → Contact your Sony dealer or local authorized Sony service facility and inform them of the 5-digit code. (e.g. E:61:10) |
| E:61:□□ | |
| E:62:□□ | |

If you are unable to rectify the problem even if you try corrective actions several times, contact your Sony dealer or local authorized Sony service facility.

Warning indicators and messages

If indicators and messages appear on the screen, check the following.
See the page in parentheses “()” for more information.

Warning indicators

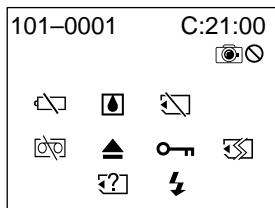

Tape/Battery pack warning indicator

Slow flashing:

- The battery pack is nearly dead.
- The tape is near the end.

Fast flashing:

- The battery pack is dead.
- The tape has run out.*

101-0001 Warning indicator as to file

350 **351**

Slow flashing:

- The file is corrupted.
- The file is unreadable.
- You are trying to use the MEMORY MIX function on a moving picture (p. 140).

C:21:00 Self-diagnosis display (p. 232)

Warning indicator as to battery

Slow flashing:

- The battery is nearly dead.
- The  indicator sometimes flashes even if the remaining battery time is about five to 10 minutes depending on the operating conditions, environment and battery condition.

Fast flashing:

- The battery pack is dead.
- The battery pack is completely dead, and cannot be charged.

Moisture condensation has occurred *

Fast flashing:

- Eject the cassette, turn off your camcorder, and leave it for about one hour with the cassette compartment open (p. 247).

Warning indicator as to tape

Slow flashing:

- The remaining tape becomes shorter than the length for five-minute recording.
- No tape is inserted.*
- The write-protect tab on the cassette is set to LOCK (red) * (p. 29).

Fast flashing:

- The cassette has run out of tape.*

Warning indicator as to incompatible

"Memory Stick" * **350** **351**

Slow flashing:

- An incompatible "Memory Stick" is inserted.

* You hear the melody or beep.

Warning indicators and messages

You need to eject the cassette *

Slow flashing:

- The write-protect tab on the cassette is set to LOCK (red) (p. 29).

Fast flashing:

- Moisture condensation has occurred (p. 247).
- The cassette has run out of tape.
- The self-diagnosis display function is activated (p. 232).

Warning indicator as to “Memory Stick”

Slow flashing:

- No “Memory Stick” is inserted.

Fast flashing*:

- The “Memory Stick” is not readable on your camcorder (p. 126).
- The image cannot be recorded on a “Memory Stick.”

Warning indicator as to “Memory Stick” formatting *

Fast flashing:

- “Memory Stick” data is corrupted (p. 240).
- “Memory Stick” is not formatted correctly (p. 218).

The image is protected *

Slow flashing:

- The image is protected (p. 176).



Warning indicator as to the flash (optional)

Fast flashing:

- There is something wrong with the external flash. (optional)

Warning indicator as to still image recording



















Slow flashing:

- The still image cannot be recorded on the “Memory Stick”  (p. 53).
- The still image cannot be recorded on the tepe  (p. 56).

* You hear the melody or beep.

Warning indicators and messages

Warning messages













- CLOCK SET Set the date and time (p. 26).
- FOR “InfoLITHIUM” BATTERY ONLY Use an “InfoLITHIUM” battery pack (p. 242).
-   TAPE END The cassette has run out of tape.*
-  NO TAPE Insert a cassette tape.*
-  CLEANING CASSETTE The video heads are dirty. (The  indicator and “ CLEANING CASSETTE” message appear one after another on the screen.)* (p. 248)
- COPY INHIBIT You tried to record a picture that has a copyright control signal * (p. 238).
   
- START/STOP KEY Press START/STOP to activate the ORC setting. This message is displayed in white (p. 219).
  
- ORC ORC is working. This message is displayed in white (p. 219).
  
-  NOW CHARGING Charging an external flash (optional) does not work correctly.*
 

* You hear the melody or beep.

Warning indicators and messages

Warning messages as to "Memory Stick"

You hear the melody or beep.

-  FULL The "Memory Stick" is full (p. 131).
-  FOLDER NO. FULL Folders have already been created in the "Memory Stick" up to the limit (up to the folder 999 MSDCF) (p. 161).
-   The write-protect tab on the "Memory Stick" is set to LOCK (p. 240).
-  NO FILE No still image is recorded on the "Memory Stick."
-  NO MEMORY STICK No "Memory Stick" is inserted.
-  AUDIO ERROR You are trying to record an image with sound that cannot be recorded by your camcorder on "Memory Stick" (p. 151).
-  MEMORY STICK ERROR The "Memory Stick" data is corrupted (p. 127).
-  FORMAT ERROR Check the type of the "Memory Stick" format (p. 218).
-  PLAY ERROR The image cannot be played back. Reinsert the "Memory Stick," then play back the image again.
-  REC ERROR Check the input signal before retrying recording (p. 139, 153).
-  INCOMPATIBLE MEMORY STICK The "Memory Stick" inserted is not compatible with your camcorder.
- DELETING You have pressed PHOTO during deleting all images on "Memory Stick."
- FORMATTING You have pressed PHOTO during formatting a "Memory Stick."
- NO FILE AVAILABLE No file is in the current PB folder (p. 169).
- USB STREAMING ON GOING You cannot carry out any "Memory Stick" operations during USB Streaming (p. 200).
- READ-ONLY MEMORY STICK The 100MSDCF is only for playback (p. 162).

About video cassette

Usable cassette tapes and Recording / Playback systems

350 **351**

| | | |
|---------------------------------|--|--|
| Usable cassette tapes | Hi8 Hi8 /Digital8 D8 (recommended) | Standard 8 mm 8 * ¹⁾ |
| Recording system | Digital8 D8 | |
| Playback system * ²⁾ | Digital8 D8 | |
| | Hi8 Hi8 | Standard 8 mm 8 |

150 **250**

| | | |
|-----------------------|--|--|
| Usable cassette tapes | Hi8 Hi8 /Digital8 D8 (recommended) | Standard 8 mm 8 * ¹⁾ |
| Recording system | Digital8 D8 | |
| Playback system | Digital8 D8 | |

118 **318** **418**

| | | |
|---------------------------------|--------------------------------|------------------------|
| Usable cassette tapes | Hi8 Hi8 | Standard 8 mm 8 |
| Recording system | Hi8 Hi8 * ³⁾ | Standard 8 mm 8 |
| Playback system * ²⁾ | Hi8 Hi8 | Standard 8 mm 8 |

*¹⁾ If you use standard 8 mm **8** tape, be sure to play back the tape on your camcorder. Mosaic noise may appear when you play back standard 8 mm **8** tape on other VCRs (including another DCR-TRV150/TRV250/TRV350/TRV351).

*²⁾ When you play back a tape, the Hi8 **Hi8** system or standard 8 mm **8** system is automatically detected and the playback system automatically switches to.

*³⁾ If you record on a Hi8 **Hi8** video cassette in the LP mode, recording is carried out in the standard 8 mm **8** system.

What is the “Digital8 **D8** system”?

This video system has been developed to enable digital recording to Hi8 **Hi8**/Digital8 **D8** video cassette.

The recording time when you use your Digital8 **D8** system camcorder on Hi8 **Hi8**/standard 8 mm **8** tape is half the recording time when using the conventional Hi8 **Hi8**/standard 8 mm **8** system camcorder. (120 minutes of recording time becomes 60 minutes in the SP mode.)

What is the “Hi8 **Hi8** system”?

This Hi8 **Hi8** system is an extension of the standard 8 mm **8** system, and was developed to produce higher quality pictures.

You cannot play back a tape recorded in the Hi8 **Hi8** system correctly on video recorders/players other than a Hi8 video recorder/player.

About video cassette

Copyright signal

When you play back

If the tape you play back on your camcorder contains copyright signals, you cannot copy it with another video camera recorder connected to your camcorder.

When you record **150** **250** **350** **351**

You cannot record software on your camcorder that contains copyright control signals for copyright protection of software.

The COPY INHIBIT indicator appears on the LCD screen, in the viewfinder or on the TV screen if you try to record such software. Your camcorder does not record copyright control signals on the tape when it records.

When you play back a dual sound track tape **150** **250** **350** **351**

When you use a tape recorded in the Digital8 **B** system

When you play back a Digital8 **B** system tape which is dubbed from a dual sound track tape recorded in the DV system, set HiFi SOUND to the desired mode in the menu settings (p. 214).

Sound from speaker

| HiFi Sound Mode | Playing back a stereo tape | Playing back a dual sound track tape |
|-----------------|----------------------------|--------------------------------------|
| STEREO | Stereo | Main sound and sub sound |
| 1 | Lch | Main sound |
| 2 | Rch | Sub sound |

You cannot record dual sound programs on your camcorder.

When you use a tape recorded in the Hi8 Hi8/standard 8 mm **B** system **350** **351**

When you play back a dual sound track tape recorded in an AFM HiFi stereo system, set HiFi SOUND to the desired mode in the menu settings (p. 214).

Sound from speaker

| HiFi Sound Mode | Playing back a stereo tape | Playing back a dual sound track tape |
|-----------------|----------------------------|--------------------------------------|
| STEREO | Stereo | Main sound and sub sound |
| 1 | Monaural | Main sound |
| 2 | Unnatural Sound | Sub sound |

You cannot record dual sound programs on your camcorder.

About video cassette

Display during automatic detection of system

The Digital8 **Ⓜ** system or Hi8 **Hi8**/standard 8 mm **Ⓜ** system is automatically detected, and the playback system is automatically switched to. During switching of systems, the screen turns blue, and the following displays appear on the screen. A hissing noise also sometimes can be heard.

Ⓜ → **Hi8**/**Ⓜ**: During switching from Digital8 **Ⓜ** to Hi8 **Hi8**/standard 8 mm **Ⓜ**

Hi8/**Ⓜ** → **Ⓜ**: During switching from Hi8 **Hi8**/standard 8 mm **Ⓜ** to Digital8 **Ⓜ**

About the “Memory Stick”

“Memory Stick” is a new compact, portable and versatile IC recording medium with a data capacity that exceeds the capacity of a floppy disk.

In addition to exchanging data between “Memory Stick” compatible equipment, you can also use a “Memory Stick” to store data as a type of detachable external recording media.

There are two types of “Memory Stick”: an ordinary “Memory Stick” and a “MagicGate Memory Stick” that is equipped with the MagicGate * copyright protection technology. You can use both types of “Memory Stick” with your camcorder. However, because your camcorder does not support the MagicGate standards, data recorded with your camcorder is not subject to MagicGate copyright protection.

In addition, you can also use “Memory Stick Duo” with your camcorder.

* MagicGate is copyright protection technology that uses encryption technology.

- You cannot record or delete images when the write-protect tab is set to LOCK. The position or the shape of the write-protect tab may differ depending on the “Memory Stick” you use.

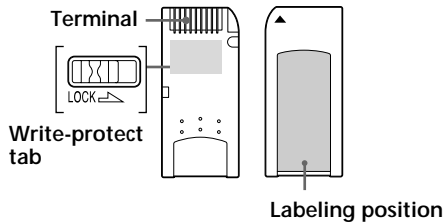

- Do not remove the “Memory Stick” or turn off the camcorder while reading or writing data.
- Data may be damaged in a location subject to the effects of static electricity or noise.
- We recommend backing up important data on the hard disk of your computer.
- Do not attach any other material than the supplied label on the labeling position.
- When you carry or store the “Memory Stick,” put it in the case supplied with it.
- Do not touch the terminal of a “Memory Stick” with your hand or a metal object.
- Do not strike, bend or drop a “Memory Stick.”
- Do not disassemble or modify a “Memory Stick.”
- Do not expose the “Memory Stick” to water.
- Do not use or keep the “Memory Stick” under the following conditions:
 - High temperature locations such as in a car parked in direct sunlight
 - Locations exposed to direct sunlight
 - Humid locations or locations with corrosive substances

About the “Memory Stick”

Notes on using “Memory Stick Duo” (optional)

- When using a “Memory Stick Duo” with your camcorder, be sure to insert the “Memory Stick Duo” into a Memory Stick Duo Adaptor.
- Make sure that a “Memory Stick Duo” is inserted facing the proper direction. Inserting a “Memory Stick Duo” facing the wrong direction may damage the equipment.
- Do not insert a “Memory Stick Duo” without a Memory Stick Duo Adaptor into “Memory Stick” compatible equipment, as this may cause equipment trouble.

About the “InfoLITHIUM” battery pack

What is the “InfoLITHIUM” battery pack?

The “InfoLITHIUM” battery pack is a lithium-ion battery pack that has functions for communicating information related to operating conditions between your camcorder and an AC Adaptor/charger (optional).

The “InfoLITHIUM” battery pack calculates the power consumption according to the operating conditions of your camcorder, and displays the remaining battery time in minutes. Estimated operating time and charging completion time are also displayed.

Charging the battery pack

- Be sure to charge the battery pack before you start using your camcorder.
- We recommend charging the battery pack in an ambient temperature of between 10°C to 30°C (50°F to 86°F) until the charge lamp goes off. If you charge the battery outside of this temperature range, you may not be able to efficiently charge the battery.
- After charging is completed, either disconnect the cable from the DC IN jack on your camcorder or remove the battery pack.

Effective use of the battery pack

- Battery pack performance decreases in low-temperature surroundings. So, the time that the battery pack can be used is shorter in cold places. We recommend the following to ensure longer battery pack use:
 - Put the battery pack in a pocket to warm it up, and insert it in your camcorder immediately before you start taking shots.
 - Use the large-capacity battery pack (NP-FM70/QM71/QM71D/FM90/FM91/QM91/QM91D, optional).
- Frequently using the LCD panel or frequently operating playback, fast-forward or rewind wears out the battery pack faster. We recommend using the large-capacity battery pack (NP-FM70/QM71/QM71D/FM90/FM91/QM91/QM91D, optional).
- Be sure to turn the POWER switch to OFF (CHG) when not taking shots or playing back on your camcorder. The battery pack is also consumed when your camcorder is in the standby mode or playback is paused.
- Have spare battery packs handy for two or three times the expected recording time, and make a trial recordings before taking the actual recording.
- Do not expose the battery pack to water. The battery pack is not water-resistant.

Remaining battery time indicator

- If the power goes off although the remaining battery time indicator indicates that the battery pack has enough power to operate, charge the battery pack fully again so that the indication on the remaining battery time indicator is correct. Note, however, that the correct battery indication sometimes will not be restored if it is used in high temperatures for a long time or left in a fully charged state, or the battery pack is frequently used. Regard the remaining battery time indication as the approximate shooting time.
- The  mark indicating that there is little remaining battery time sometimes flashes depending on the operating conditions or ambient temperature and environment even if the remaining battery time is about five to 10 minutes.

About the "InfoLITHIUM" battery pack

How to store the battery pack

- If the battery pack is not used for a long time, do the following procedure once per year to maintain proper function.
 1. Fully charge the battery.
 2. Discharge on your electronic equipment.
 3. Remove the battery from the equipment and store it in a dry, cool place.
- To use the battery pack up on your camcorder, leave your camcorder in the standby mode until the power goes off without a cassette inserted.

Battery life

- The battery life is limited. Battery capacity drops little by little as you use it more and more, and as time passes. When the available battery time is shortened considerably, a probable cause is that the battery pack has reached the end of its life. Buy a new battery pack.
- The battery life varies according to how it is stored, operating conditions and environment for each battery pack.

About i.LINK

The DV jack on this unit is an i.LINK-compliant DV jack. This section describes the i.LINK standard and its features.

What is “i.LINK”?

i.LINK is a digital serial interface for handling digital video, digital audio and other data in two directions between equipment having the i.LINK jack, and for controlling other equipment.

i.LINK-compatible equipment can be connected by a single i.LINK cable. Possible applications are operations and data transactions with various digital AV equipment. When two or more i.LINK-compatible equipment are connected to this unit in a daisy chain, operations and data transactions are possible with not only the equipment that this unit is connected to but also with other devices via the directly connected equipment.

Note, however, that the method of operation sometimes varies according to the characteristics and specifications of the equipment to be connected, and that operations and data transactions are sometimes not possible on some connected equipment.

Note

Normally, only one piece of equipment can be connected to this unit by the i.LINK cable. When connecting this unit to i.LINK-compatible equipment having two or more i.LINK jacks (DV jacks), refer to the operating instructions of the equipment to be connected.

About the name “i.LINK”

i.LINK is a more familiar term for IEEE 1394 data transport bus proposed by Sony, and is a trademark approved by many corporations. IEEE 1394 is an international standard standardized by the Institute of Electrical and Electronic Engineers.

i.LINK baud rate

i.LINK's maximum baud rate varies according to the equipment. Three maximum baud rates are defined:

S100 (approx. 100 Mbps*)

S200 (approx. 200 Mbps)

S400 (approx. 400 Mbps)

The baud rate is listed under “Specifications” in the operating instructions of each equipment. It is also indicated near the i.LINK jack on some equipment.

The maximum baud rate of equipment on which it is not indicated such as this unit is “S100.”

When units are connected to equipment having a different maximum baud rate, the baud rate sometimes differs from the indicated baud rate.

* What is “Mbps”?

Mbps stands for megabits per second, or the amount of data that can be sent or received in one second. For example, a baud rate of 100 Mbps means that 100 megabits of data can be sent in one second.

About i.LINK

i.LINK functions on this unit

For details on how to dub when this unit is connected to other video equipment having DV jacks, see page 96 and 121.

This unit can also be connected to other i.LINK (DV) compatible non-video equipment made by Sony (e.g. VAIO series computer).

Before connecting this unit to a computer, make sure that application software supported by this unit is already installed on the computer.

For details on precautions when connecting this unit, also refer to the operating instructions of the equipment to be connected.

Required i.LINK cable

Use the Sony i.LINK 4-pin-to-4-pin cable (during DV dubbing).

Using your camcorder abroad

Using your camcorder abroad

You can use your camcorder in any country or area with the AC Adaptor supplied with your camcorder within 100 V to 240 V AC, 50/60 Hz.

When charging the battery pack, use a commercially available AC plug adaptor [a], if necessary, depending on the design of the wall outlet [b].

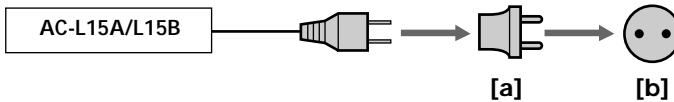

Your camcorder is an NTSC system based camcorder. If you want to view the playback picture on a TV, it must be an NTSC system based TV with VIDEO/AUDIO input jack. The following shows TV color systems used overseas.

NTSC system

Bahama Islands, Bolivia, Canada, Central America, Chile, Colombia, Ecuador, Jamaica, Japan, Korea, Mexico, Peru, Surinam, Taiwan, the Philippines, the U.S.A., Venezuela, etc.

PAL system

Australia, Austria, Belgium, China, Czech Republic, Denmark, Finland, Germany, Holland, Hong Kong, Hungary, Italy, Kuwait, Malaysia, New Zealand, Norway, Poland, Portugal, Singapore, Slovak Republic, Spain, Sweden, Switzerland, Thailand, United Kingdom etc.

PAL-M system

Brazil

PAL-N system

Argentina, Paraguay, Uruguay

SECAM system



Bulgaria, France, Guiana, Iran, Iraq, Monaco, Russia, Ukraine, etc.

Simple setting of clock by time difference



You can easily set the clock to the local time by setting a time difference. Select WORLD TIME in the menu settings. See page 222 for more information.

Maintenance information and precautions

Moisture condensation

If your camcorder is brought directly from a cold place to a warm place, moisture may condense inside your camcorder, on the surface of the tape, or on the lens. In this state, the tape may stick to the head drum and be damaged or your camcorder may not operate correctly. If there is moisture inside your camcorder, the beep sounds and the  indicator flashes. When the  indicator flashes at the same time, the cassette is inserted in your camcorder. If moisture condenses on the lens, the indicator will not appear.

If moisture condensation has occurred

None of the functions except cassette ejection ( OPEN/EJECT) work while the alarm indicator is on. Eject the cassette, turn off your camcorder, and leave it for about one hour with the cassette compartment open. Your camcorder can be used again if the  indicator does not flash.

Note on moisture condensation

Moisture may condense when you bring your camcorder from a cold place into a warm place (or vice versa) or when you use your camcorder in a hot place as follows:

- You bring your camcorder from a ski slope into a place warmed up by a heating device.
- You bring your camcorder from an air-conditioned car or room into a hot place outside.
- You use your camcorder after a squall or a shower.
- You use your camcorder in a place of high temperature or humidity.

How to prevent moisture condensation

When you bring your camcorder from a cold place into a warm place, put your camcorder in a plastic bag and tightly seal it. Remove the bag when the air temperature inside the plastic bag has reached the surrounding temperature (after about one hour).

Maintenance information

Cleaning the video heads

To ensure normal recording and clear pictures, clean the video heads.

If the below problem [a], [b] or [c] occurs, clean the video heads for 10 seconds with the Sony V8-25CLD cleaning cassette (optional). Check the picture and if the above problem persists, repeat cleaning.

If the video heads get dirtier, the entire screen becomes blue [c].

150 250 350 351

When you playback/record in the Digital8 **8** system

The video heads may be dirty when:

- Mosaic-pattern noise appears on the playback picture.
- Playback pictures do not move.
- Playback pictures are hardly visible.
- Playback pictures do not appear.
- The **⊗** indicator and “**⊗** CLEANING CASSETTE” message appear one after another.

[a]



[b]



[c]

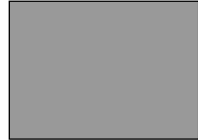

118 318 418 350 351

When you play back in the Hi8 **8**/Standard 8 mm **8** system

The video heads may be dirty when:

- The **⊗** indicator and “**⊗** CLEANING CASSETTE” message appear one after another on the screen or the **⊗** indicator flashes on the screen.
- Playback pictures contain noise.
- Playback pictures are hardly visible.
- Playback pictures do not appear.

[a]



[b]

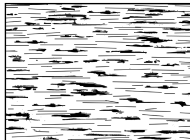

[c]



Cleaning the LCD screen

If fingerprints or dust makes the LCD screen dirty, we recommend using the LCD Cleaning Kit (optional) to clean the LCD screen.

Maintenance information and precautions

Notes

- Store your camcorder with the cassette removed from it when you do not use it for an extended period of time.
- Clean the heads with an optional head cleaner (cleaning cassette) before important recording or when playback image or sound is distorted.
- When the playback pictures still contain noise even if you have cleaned the video heads with a cleaning cassette, the video heads may have worn down due to long use. If this is the case, they must be replaced with new heads. Contact your Sony dealer or local authorized Sony service facility.

Charging the built-in rechargeable battery

Your camcorder is supplied with a built-in rechargeable battery installed to retain the date and time, etc., regardless of the setting of the POWER switch. The built-in rechargeable battery is always charged as long as you are using your camcorder. The battery, however, will become discharged gradually if you do not use your camcorder. It will be completely discharged in **about three months** if you do not use your camcorder at all. Even if the built-in rechargeable battery is not charged, it will not affect camcorder operation. To retain the date, time, and other information, charge the battery if the battery is discharged.

Charging the built-in rechargeable battery:

- Connect your camcorder to wall outlet using the AC Adaptor supplied with your camcorder, and leave your camcorder with the POWER switch turned off for more than 24 hours.
- Or, install a fully charged battery pack in your camcorder, and leave your camcorder with the POWER switch set to OFF (CHG) for more than 24 hours.

Precautions

Camcorder operation

- Operate your camcorder on 7.2 V (battery pack) or 8.4 V (AC Adaptor).
- For DC or AC operation, use the accessories recommended in these operating instructions.
- If any solid object or liquid gets inside the casing, unplug your camcorder and have it checked by a Sony dealer before operating it any further.
- Avoid rough handling or mechanical shock. Be particularly careful of the lens.
- Keep the POWER switch set to OFF (CHG) when you are not using your camcorder.
- Do not wrap your camcorder with a towel, for example, and operate it. Doing so might cause heat to build up inside.
- Keep your camcorder away from strong magnetic fields or mechanical vibration.
- Do not touch the LCD screen with your fingers or a sharp-pointed object.
- If your camcorder is used in a cold place, a residual image may appear on the screen. This is not a malfunction.
- While using your camcorder, the back of the LCD screen may heat up. This is not a malfunction.

Maintenance information and precautions

Built-in light

- Do not knock or jolt the built-in light while it is turned on as it may damage the bulb or shorten the life of the bulb.
- Do not leave the built-in light on while it is resting on or against something; it may cause a fire or damage the built-in light.



On handling tapes

- Do not insert anything into the small holes on the rear of the cassette. These holes are used to sense the type and thickness of the tape and if the recording tab is in or out.
- Do not open the tape protect cover or touch the tape.
- Avoid touching or damaging the terminals. To remove dust, clean the terminals with a soft cloth.

Camcorder care



- Remove the tape, and periodically turn on the power, operate the CAMERA and VCR/PLAYER sections and play back a tape for a certain period ^{*1)} when your camcorder is not to be used for a long time. ^{*2)}
- Clean the lens with a soft brush to remove dust. If there are fingerprints on the lens, remove them with a soft cloth.
- Clean the camcorder body with a dry soft cloth, or a soft cloth lightly moistened with a mild detergent solution. Do not use any type of solvent which may damage the finish.
- Do not let sand get into your camcorder. When you use your camcorder on a sandy beach or in a dusty place, protect it from the sand or dust. Sand or dust may cause your camcorder to malfunction, and sometimes this malfunction cannot be repaired.

Connection to your computer

When inputting the image recorded by Hi8 /standard 8 mm  system into Sony VAIO

The Program Capture function of DVgate motion does not work. To use this function, dub the image into a Digital8  or DV tape first, and then input it into your Sony VAIO.

Connection to your computer

When recording an image processed or edited by your computer with the i.LINK cable, use a new Hi8 /Digital8  tape.

*1) three minutes: 

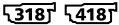
five minutes: 

*2) Modes on the POWER switch vary depending on models (p. 16).

AC Adaptor

- Unplug the unit from the wall outlet when you are not using it for a long time. To disconnect the power cord, pull it out by the plug. Never pull the power cord itself.
- Do not operate the unit with a damaged cord or if the unit has been dropped or damaged.
- Do not bend the power cord forcibly, or place a heavy object on it. This will damage the cord and may cause fire or electric shock.
- Prevent metallic objects from coming into contact with the metal parts of the connecting section. If this happens, a short may occur and the unit may be damaged.
- Always keep metal contacts clean.
- Do not disassemble the unit.
- Do not apply mechanical shock or drop the unit.
- While the unit is in use, particularly during charging, keep it away from AM receivers and video equipment. AM receivers and video equipment disturb AM reception and video operation.
- The unit becomes warm during use. This is not a malfunction.
- Do not place the unit in locations that are:
 - Extremely hot or cold
 - Dusty or dirty
 - Very humid
 - Vibrating

About care and storage of the lens

- Wipe the surface of the lens clean with a soft cloth in the following instances:
 - When there are fingerprints on the lens surface
 - In hot or humid locations
 - When the lens is used in environments susceptible to salt such as the seaside
- Store the lens in a well-ventilated location subject to little dirt or dust.

To prevent mold from occurring, periodically perform the above.

We recommend turning on and operating your camcorder about once per month to keep your camcorder in an optimum state for a long time.

Rechargeable Battery Pack

- Use only the specified charger or video equipment with the charging function.
- To prevent accidental short circuit, do not allow metal objects to come into contact with the rechargeable battery terminals.
- Keep the Rechargeable Battery Pack away from fire.
- Never expose the Rechargeable Battery Pack to temperatures above 60°C (140°F), such as in a car parked in the sun or under direct sunlight.
- Keep the Rechargeable Battery Pack in a cool, dry place.
- Do not expose the Rechargeable Battery Pack to any mechanical shock.
- Do not disassemble or modify the Rechargeable Battery Pack.
- Attach the Rechargeable Battery Pack to the video equipment securely.
- Charging while some capacity remains does not affect the original battery capacity.

Maintenance information and precautions

Notes on dry batteries

To avoid possible damage from battery leakage or corrosion, observe the following:

- Be sure to insert the batteries with the + and - correctly matching the + and - inside the battery compartment.
- Dry batteries are not rechargeable.
- Do not use a combination of new and old batteries.
- Do not use different types of batteries.
- Current flows from batteries when you are not using them for a long time.
- Do not use leaking batteries.

If batteries are leaking

- Wipe off the liquid in the battery compartment carefully before replacing the batteries.
- If you touch the liquid, wash it off with water.
- If the liquid gets into your eyes, wash your eyes with a lot of water and then consult a doctor.

If any problem occurs, unplug your camcorder and contact your nearest Sony dealer.

Specifications

Video camera recorder

| | | 118 | 318 | 418 | 150 | 250 | 350 | 351 |
|--------|--|---|-----|-----|---|-----|-----|-----|
| System | Video recording system | 2 rotary heads Helical scanning FM system | | | 2 rotary heads Helical scanning system | | | |
| | Audio recording system | Rotary heads, FM system | | | Rotary heads, PCM system Quantization: 12bits (Fs 32 kHz, stereo 1, stereo 2), 16bits (Fs 48 kHz, stereo) | | | |
| | Video signal | NTSC color, EIA standards | | | | | | |
| | Usable cassette | 8 mm video format cassette | | | | | | |
| | Recording/playback time (using 120 min. Hi8/Digital8 video cassette) | SP mode: 2 hours LP mode: 4 hours | | | SP mode: 1 hour LP mode: 1 hour and 30 minutes | | | |
| | Fastforward/rewind time (using 120 min. Hi8/Digital8 video cassette) | Approx. 5 min. | | | | | | |
| | Viewfinder | Electric Viewfinder (monochrome) | | | | | | |
| | Image device | 3 mm (1/6 type) CCD (Charge Coupled Device) Gross: Approx. 320 000 pixels Effective: Approx. 200 000 pixels | | | 3 mm (1/6 type) CCD (Charge Coupled Device) Gross: Approx. 460 000 pixels Effective: Approx. 290 000 pixels | | | |
| | Lens | Combined power zoom lens Filter diameter 37 mm (1 7/16 in.) 20× (Optical), 560× (Digital) | | | | | | |
| | Focal length | f = 2.5 - 50 mm (1/8 - 2 in.) When converted to a 35 mm still camera f = 42 - 840 mm (1 11/16 - 33 1/8 in.) | | | | | | |
| | Color temperature | Auto | | | | | | |
| | Minimum illumination | 1 lx (lux) (F 1.6) | | | 4 lx (lux) (F 1.6) | | | |
| | 0 lx (lux) (in the NightShot mode)* * Objects unable to be seen due to the dark can be shot with infrared lighting. | | | | | | | |

(continued on the following page)

Specifications

| | | 118 318 418 | 150 | 250 | 350 351 |
|-------------------------|---|---|--|---|---|
| Input/output connectors | S video jack | Output Luminance signal: 1 Vp-p, 75 Ω (ohms), unbalanced Chrominance signal: 0.286 Vp-p, 75 Ω (ohms), unbalanced 4-pin mini DIN | | | Input/Output Luminance signal: 1 Vp-p, 75 Ω (ohms), unbalanced Chrominance signal: 0.286 Vp-p, 75 Ω (ohms), unbalanced 4-pin mini DIN |
| | Audio/Video jack | Output AV MINIJACK, VIDEO: 1 Vp-p, 75 Ω (ohms), unbalanced, sync negative AUDIO: 327 mV, (at output impedance more than 47 kΩ (kilohms)) Input impedance with more than 47 kΩ (kilohms) Output impedance with less than 2.2 kΩ (kilohms) | | | Input/Output AV MINIJACK, VIDEO: 1 Vp-p, 75 Ω (ohms), unbalanced, sync negative AUDIO: 327 mV, (at output impedance more than 47 kΩ (kilohms)) Input impedance with more than 47 kΩ (kilohms) Output impedance with less than 2.2 kΩ (kilohms) Stereo minijack (ø 3.5 mm) |
| | | Monaural minijack (ø 3.5 mm) | Stereo minijack (ø 3.5 mm) | | |
| | RFU DC OUT | Mini-minijack (ø 2.5 mm), DC5V | — | | |
| | MIC jack | — | | | Stereo minijack (ø 3.5 mm) |
| | DV jack | — | 4-pin connector | | |
| | USB jack | — | mini-B | | |
| | LANC jack | — | — | | |
| LCD screen | Picture | 6.2 cm (2.5 type), 50.3 × 37.4 mm (2 × 1 1/2 in.) | | | |
| | Total dot number | 61 600 (280 × 220) | 123 200 (560 × 220) | | |
| General | Power requirements | 7.2 V (Rechargeable Battery Pack) 8.4 V (AC Adaptor) | | | |
| | Average power consumption (when using the battery pack) | During camera recording using LCD 2.6 W During camera recording using viewfinder 1.9 W | During camera recording using LCD 3.5 W During camera recording using viewfinder 2.7 W | During camera recording using LCD 3.8 W During camera recording using viewfinder 2.9 W | |
| | Operating temperature | 0°C to 40°C (32°F to 104°F) | | | |
| | Recommended charging temperature | 10°C to 30°C (50°F to 86°F) | | | |
| | Storage temperature | -20°C to +60°C (-4°F to +140°F) | | | |
| | Dimensions (approx.) | 89 × 101 × 199 mm (3 5/8 × 4 × 7 7/8 in.) (w/h/d) | | | |
| | Mass (approx.) | 800 g (1 lb 12 oz) (main unit only) | 810 g (1 lb 12 oz) (main unit only) | | 830 g (1 lb 13 oz) (main unit only) |
| | | 940 g (2 lb 1 oz) (including the Rechargeable Battery Pack NP-FM30, Hi8/Digital8 cassette, lens cap, and shoulder strap) | 950 g (2 lb 1 oz) (including the Rechargeable Battery Pack NP-FM30, Hi8/Digital8 cassette, lens cap, and shoulder strap) | | 970 g (2 lb 2 oz) (including the Rechargeable Battery Pack NP-FM30, Hi8/Digital8 cassette, lens cap, and shoulder strap) |
| Supplied accessories | See page 9. | | | | |

Specifications

AC Adaptor AC-L15A/L15B

| | |
|-----------------------|--|
| Power requirements | 100 - 240 V AC, 50/60 Hz |
| Current consumption | 0.35 - 0.18 A |
| Power consumption | 18 W |
| Output voltage | DC OUT: 8.4 V, 1.5 A in the operating mode |
| Operating temperature | 0°C to 40°C (32°F to 104°F) |
| Storage temperature | -20°C to +60°C (-4°F to +140°F) |
| Dimensions (approx.) | 56 × 31 × 100 mm (2 1/4 × 1 1/4 × 4 in.) (w/h/d) excluding projecting parts |
| Mass (approx.) | 190 g (6.7 oz) excluding power cord |

Rechargeable Battery Pack NP-FM30

| | |
|------------------------|---|
| Maximum output voltage | DC 8.4 V |
| Output voltage | DC 7.2 V |
| Capacity | 5.0 Wh (700 mAh) |
| Operating temperature | 0°C to 40°C (32°F to 104°F) |
| Dimensions (approx.) | 38.2 × 20.5 × 55.6 mm (1 9/16 × 13/16 × 2 1/4 in.) (w/h/d) |
| Mass (approx.) | 65 g (2.3 oz) |
| Type | Lithium ion |

"Memory Stick"

| | |
|----------------------|--|
| Memory | Flash memory 8MB; MSA-8A |
| Operating voltage | 2.7 - 3.6 V |
| Power consumption | Approx. 45 mA during operation Approx. 130 µA in the standby mode |
| Dimensions (approx.) | 50 × 2.8 × 21.5 mm (2 × 1/8 × 7/8 in.) (w/h/d) |
| Mass (approx.) | 4 g (0.14 oz) |

Design and specifications are subject to change without notice.

Identifying parts and controls

Camcorder

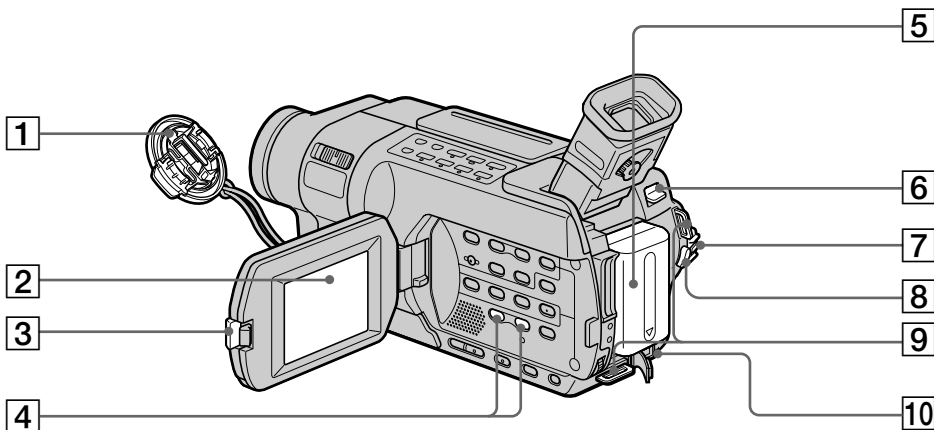

1 Lens cap (p. 30)

2 LCD screen (p. 30)

3 OPEN button (p. 30)

4 VOLUME +/- * button (p. 45)

5 Rechargeable Battery Pack (p. 18)

6 BATT (battery) release lever (p. 18)

7 POWER switch (p. 30)

8 START/STOP button (p. 30)

9 Hooks for shoulder strap

10 DC IN jack (p. 19)

* This button has a tactile dot.

Attaching the shoulder strap

Attach the shoulder strap supplied with your camcorder to the hooks for the shoulder strap.



Identifying parts and controls

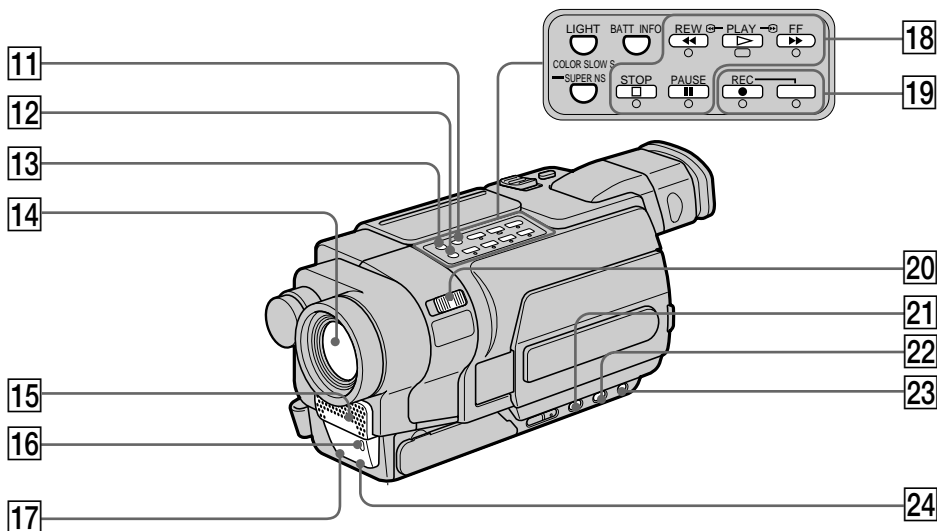

11 BATT INFO (p. 20)

12 SUPER NS/COLOR SLOW S button *¹⁾
(p. 39)

13 LIGHT button (p. 79)

14 Lens

15 Microphone

16 Camera recording lamp (p. 30)

17 Infrared rays emitter (p. 39)

18 Video control buttons *²⁾ (p. 45, 49)

- STOP (stop)
- ◀ REW (rewind)
- ▶ PLAY (playback)
- ▶▶ FF (fast-forward)
- || PAUSE (pause)

19 Rec buttons *²⁾ *³⁾

- REC (recording)

20 NIGHTSHOT switch (p. 39)

21 FADER button *²⁾ (p. 61)

22 BACK LIGHT button (p. 38)

23 FOCUS button (p. 71)

24 Remote sensor *⁴⁾

*¹⁾ **350** **351**

*²⁾ This button has a tactile dot.

*³⁾ **150** **250** **350** **351**

*⁴⁾ **418** **250** **350** **351**

Identifying parts and controls

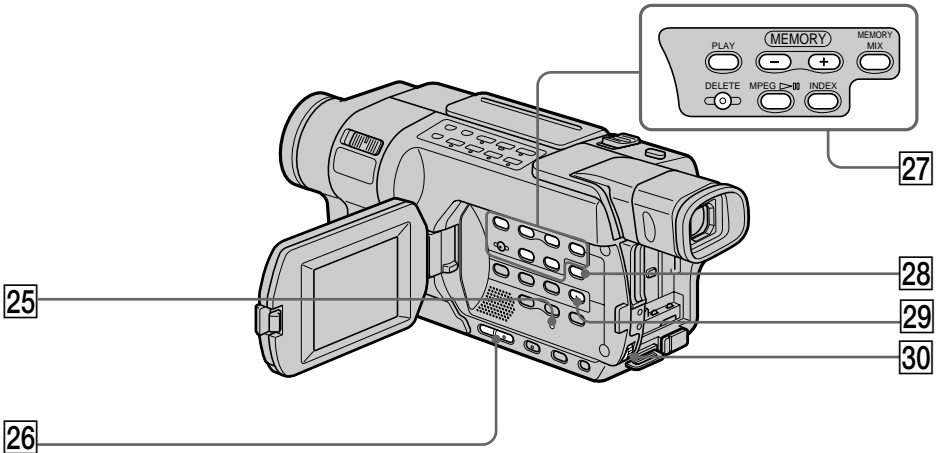

25 RESET button (p. 230)

26 EDITSEARCH button *1) *2) (p. 43)

27 MEMORY operation buttons *2)
MEMORY PLAY button (p. 163)
MEMORY - button (p. 163)
MEMORY + button (p. 163)
MEMORY MIX button (p. 141)
MEMORY DELETE button (p. 177)
MPEG ►|| button (p. 166)
MEMORY INDEX button (p. 165)

28 DISPLAY button (p. 47)

29 MENU button *1) (p. 210)

30 SEL/PUSH EXEC dial (p. 210)

Attaching the lens cap

Attach the lens cap to the grip strap as illustrated.

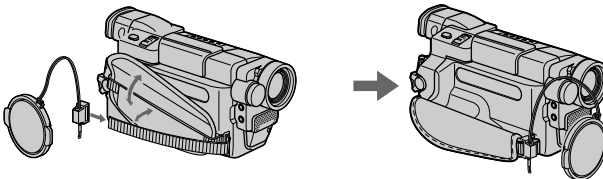

*1) This button has a tactile dot.

*2) **350** **351**

Identifying parts and controls

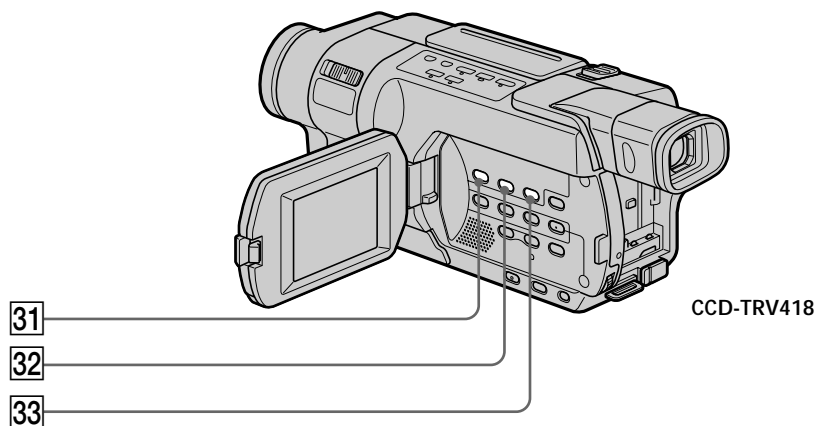

31 DATE button * (p. 42)

32 TIME button * (p. 42)

33 COUNTER RESET button * (p. 31)

* **118** **318** **418**

Identifying parts and controls

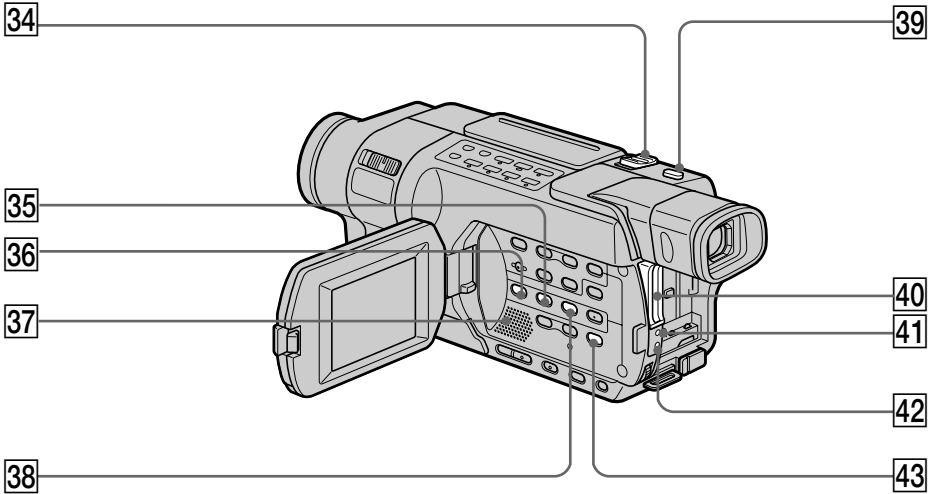

34 Power zoom lever (p. 34)

35 EXPOSURE button (p. 70)

36 PB ZOOM button *¹⁾ (p. 87, 172)
EASY DUB button *²⁾ (p. 98)

37 Speaker

38 TITLE button (p. 75)

39 PHOTO button *³⁾ (p. 53, 56, 132)

40 "Memory Stick" slot *¹⁾ (p. 127)

41 Access lamp *¹⁾ (p. 127)

42 CHG lamp (p. 19)

43 END SEARCH button (p. 43, 49)

*¹⁾ **350** **351**

*²⁾ **118** **318** **418**

*³⁾ **150** **250** **350** **351**

Identifying parts and controls

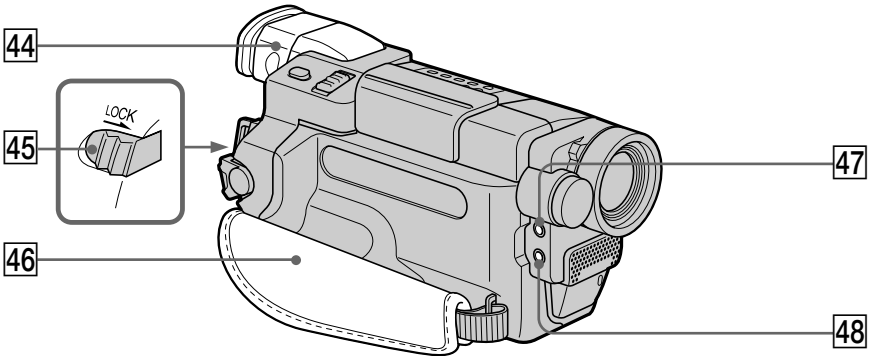

44 Viewfinder (p. 35)

45 LOCK switch * (p. 30)

46 Grip strap

47 MIC (PLUG IN POWER) jack (red) *
Connect an external microphone (optional). This jack also accepts a "plug-in-power" microphone.

48 LANC jack (blue) *

LANC stands for Local Application Control Bus System. The LANC control jack is used for controlling the tape transport of video equipment and other peripherals connected to the video equipment. This jack has the same function as the jack indicated as CONTROL L or REMOTE.

Fastening the grip strap

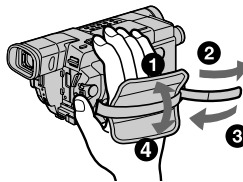

Fasten the grip strap firmly.

* **350** **351**

Identifying parts and controls

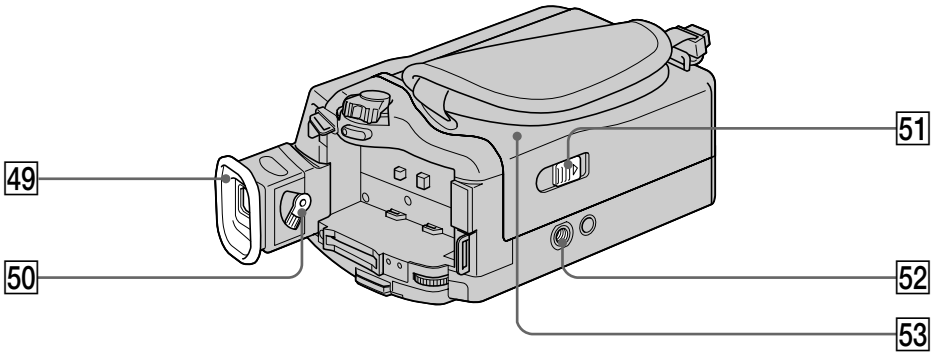

49 Eyecup

50 Viewfinder lens adjustment lever
(p. 35)

51  OPEN/EJECT switch (p. 28)

52 Tripod receptacle (base)
Make sure that the length of the tripod
screw is less than 5.5 mm (7/32 in.).
Otherwise, you cannot attach the tripod
securely and the screw may damage
your camcorder.

53 Cassette compartment (p. 28)

Identifying parts and controls

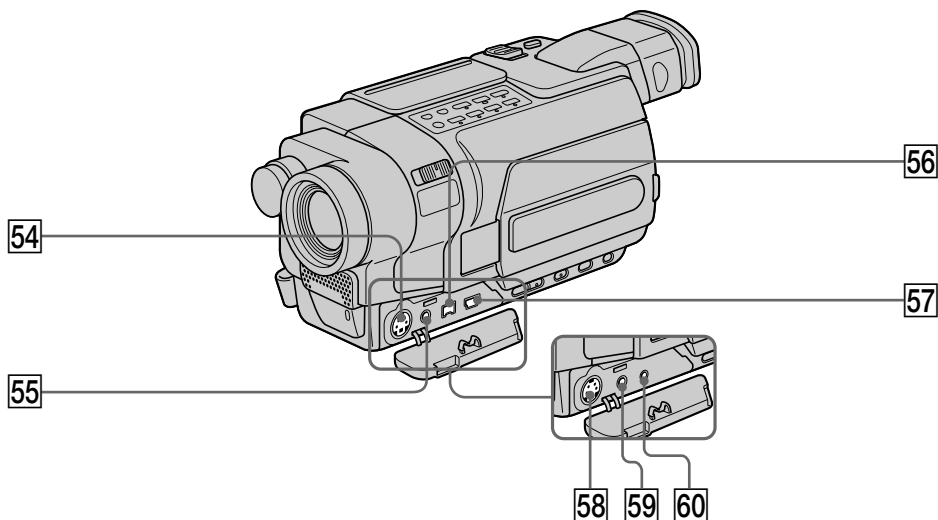

54 S VIDEO or S VIDEO OUT jack *¹⁾
(p. 51, 94, 119, 138, 152, 208)

55 AUDIO/VIDEO or A/V OUT jack *¹⁾
(p. 51, 94, 119, 138, 152, 208)

56  DV jack *¹⁾
(p. 96, 121, 139, 153, 184, 208)
The DV jack is i.LINK compatible.

57  (USB) jack *²⁾ (p. 183, 185)

58 S VIDEO OUT *³⁾ (p. 51, 95)

59 A/V OUT *³⁾ (p. 51, 95)

60 RFU DC OUT *³⁾ (p. 52)

*¹⁾ **150** **250** **350** **351**

*²⁾ **250** **350** **351**

*³⁾ **118** **318** **418**

Identifying parts and controls

Remote Commander

The buttons that share the same name on the Remote Commander and your camcorder function identically.

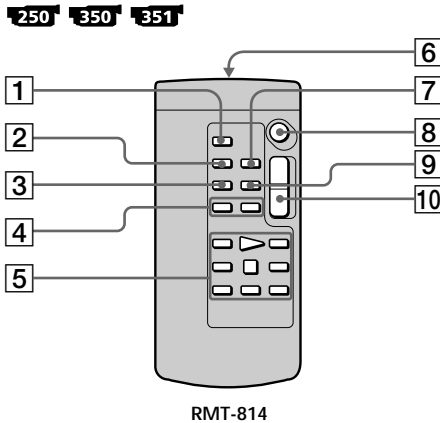

RMT-814

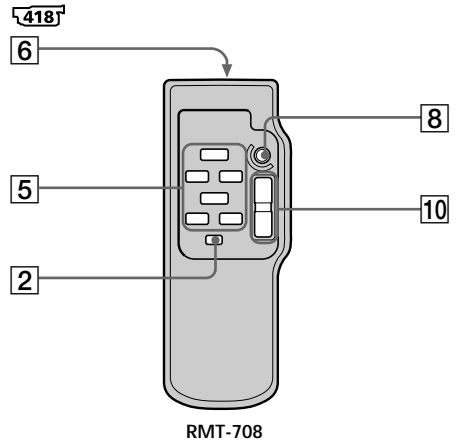

RMT-708

- 1 PHOTO button (p. 53, 56, 132)
- 2 DISPLAY button (p. 47)
- 3 SEARCH MODE button (p. 90, 92)
- 4 ◀▶ buttons (p. 90, 92)
- 5 Video control buttons (p. 45, 49)
- 6 Transmitter
Point toward the remote sensor to control the camcorder after turning on the camcorder.
- 7 ZERO SET MEMORY button (p. 89, 124)
- 8 START/STOP button (p. 30)
- 9 DATA CODE button (p. 47)
- 10 Power zoom button (p. 34)

To prepare the Remote Commander

Insert 2 size AA (R6) batteries by matching the + and - polarities on the batteries to the + - marks inside the battery compartment.

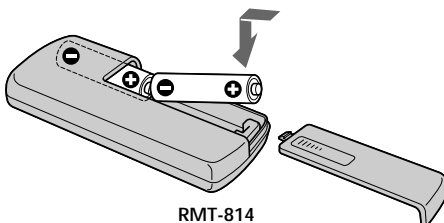

RMT-814

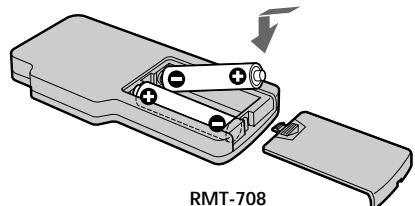

RMT-708

Notes on the Remote Commander

- Point the remote sensor away from strong light sources such as direct sunlight or overhead lighting. Otherwise, the Remote Commander may not function properly.
- Your camcorder works in the commander mode VTR 2. The commander modes 1, 2 and 3 are used to distinguish your camcorder from other Sony VCRs to avoid unintentional operations. If you use another Sony VCR in the commander mode VTR 2, we recommend changing the commander mode or covering the sensor of the VCR with black paper.

Download from [Www.Somanuals.com](http://www.Somanuals.com). All Manuals Search And Download.

Identifying parts and controls

Operation indicators

LCD screen and Viewfinder

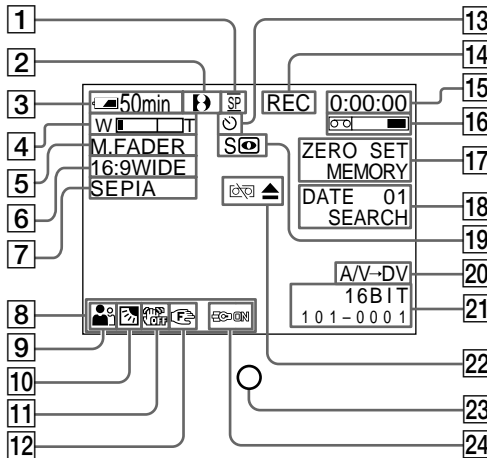

- | | |
|---|--|
| <p>1 Recording mode (p. 36) Mirror mode 118 318 418 (p. 35)</p> <p>2 Format (p. 36) F, Hi or S indicator appears.</p> <p>3 Remaining battery time (p. 36)</p> <p>4 Zoom (p. 34) Exposure (p. 70)</p> <p>5 Fader (p. 61) Digital effect 350 351 (p. 65, 85) MEMORY MIX 350 351 (p. 140)</p> <p>6 Wide mode (p. 58) FRAME indicator 350 351 (p. 132)</p> <p>7 Picture effect (p. 64, 83)</p> <p>8 Volume (p. 45) Data code 250 350 351 (p. 47)</p> <p>9 PROGRAM AE (p. 68)</p> <p>10 Backlight (p. 38)</p> | <p>11 SteadyShot off 318 418 150 250 350 351 (p. 213)</p> <p>12 Manual focusing (p. 71)</p> <p>13 Self-timer indicator 350 351 (p. 41, 55, 135, 149)</p> <p>14 STBY/REC (p. 30) Video control mode (p. 49) Image size 350 351 (p. 130) Image quality 350 351 (p. 128)</p> <p>15 Tape counter (p. 36) Time code 150 250 350 351 (p. 36) Self-diagnosis display (p. 232) Tape Photo recording 150 250 (p. 56) Memory Photo recording 350 351 (p. 132) Image number 350 351 (p. 164)</p> |
|---|--|

Identifying parts and controls

- 16** Remaining tape (p. 36)
-
- 17** ZERO SET MEMORY **250** **350** **351**
(p. 89, 124)
-
- FRAME REC indicator **150** **250** **350** **351** (p. 74)
-
- INTERVAL TAPE indicator **150** **250** **350** **351** (p. 73)
-
- INTERVAL MEM STILL indicator **350** **351** (p. 154)
-
- 18** END SEARCH (p. 43, 49)
-
- DATE SEARCH **250** **350** **351**
(p. 90)
-
- PHOTO SEARCH/PHOTO SCAN **250**
(p. 92)
-
- 19** NIGHTSHOT (p. 39)
-
- SUPER NIGHTSHOT **350** **351** (p. 39)
-
- COLOR SLOW SHUTTER **350** **351**
(p. 40)
-
- 20** A/V → DV **350** **351** (p. 208)
-
- DV IN **150** **250** **350** **351** (p. 122)
-
- Current folder **350** **351** (p. 132)
-
- 21** Audio mode **150** **250** **350** **351**
(p. 219)
-
- Data file name *1) **350** **351**
(p. 164, 168)
-
- Time (p. 36)
-
- Auto date **118** **318** **418** (p. 221)
-
- 22** Warning (p. 233)
-
- 23** Camera recording lamp (p. 30)
This indicator appears in the viewfinder.
-
- 24** Built-in light (p. 79)
-
- Video flash mode *2) **350** **351**
(p. 211)
-
- Flash *2) **350** **351**
-

*1) This indicator appears when MEMORY MIX works.

*2) This indicator appears when you use the video flash light (optional).

Index

A, B

AC Adaptor 19
Adjusting viewfinder lens 35
AFM HiFi Sound 238
AUDIO MIX 214
AUDIO MODE 219
AUTO SHTR 211
A/V connecting cable
..... 51, 94, 119, 138, 152, 208
BACK LIGHT 38
BATTERY INFO 20
Battery pack 18
BEEP 222
BOUNCE 61
Built-in light 79

C, D

Camera chroma key 140
Charging battery 19
Charging built-in rechargeable
battery 249
Cleaning cassette indicator
..... 248
Clock set 26
Color Slow Shutter 40
Data code 47
Date search 90
DEMO 221
DIGITAL EFFECT 65, 85
Digital8 system 237
Digital program editing
..... 106, 156
DISPLAY 47
DNR 214
DOT 61
Dual sound track tape 238

E

Easy Dubbing 98
EDITSEARCH 43
END SEARCH 43, 49
Exif 126
Exposure 70

F, G, H

FADER 61
Fade in/out 61
FLASH MOTION 65
FOCUS 71
Format 218
Frame recording 74
Full charge 20
Grip strap 261
Heads 248
HiFi SOUND 214
Hi8/standard 8 mm system
..... 237

I, J, K, L

i.LINK 244
i.LINK cable 96, 121, 139, 153,
184, 208, 245
ID-1 system 60
ID-2 system 60
Image protection 176
Image quality mode 128
Image size 130
Index screen 165
"InfoLITHIUM" battery 242
Infrared rays emitter
..... 39, 102, 109, 257
Insert editing 123
Interval recording 72
Interval Photo recording
..... 154
JPEG 126
LANC jack 261
LUMINANCE KEY 65

M, N

Main sound 214, 238
Manual focus 71
Memory chroma key 140
Memory luminance key 140
MEMORY MIX 140
Memory overlap 140
Memory PB ZOOM 172
Memory photo recording 132
"Memory Stick" 126, 240
"Memory Stick" recording
capacity 131
Menu settings 210
Mirror mode 35
Moisture condensation 247
Monaural 52, 95, 120, 152
MONOTONE 61
M.FADER 61
MPEG 126
MPEG movie recording 146
New folder 160
NIGHTSHOT 39
NTSC system 246

O, P, Q

OLD MOVIE 65
Operation indicators 265
ORC 219
OVERLAP 61
PB folder 169
Photo scan 93
Photo search 92
PICTURE EFFECT 64, 83
Picture search 49
Playback pause 49
Playing time 23
Print mark 180
PROGRAM AE 68

R

Recording folder 162
Recording time 22
Recording/Playback system
..... 237
Rec Review 43
Remaining battery time
indicator 36, 48
Remaining tape indicator 36
Remote Commander 264
Remote sensor 257
RESET 230

S

Self-diagnosis display 232
Self-timer recording
..... 41, 55, 135, 149
Shoulder strap 256
Signal convert function 208
Skip scan 49
SLIDE SHOW 174
SLOW SHUTTER 65
STEADYSHOT 213
Stereo tape 238
STILL 65
STRIPE 61
Sub sound 214, 238
SUPER NIGHTSHOT 39
S VIDEO jack
..... 51, 94, 119, 138, 152, 208

T, U, V

Tape counter 36
Tape PB ZOOM 87
Tape photo recording 56
TBC 214
Time code 37
Title 75, 77
TRAIL 65
Transition 31
TV color systems 246
USB jack 183, 185
USB Streaming 197

W, X, Y, Z

Warning indicators 233
Warning message 236
Wide-angle 34
Wide mode 58
WIPE 61
WORLD TIME 222
Write-protect tab 29, 240
Zero set memory 89
Zoom 34

<http://www.sony.net/>



Printed on 100% recycled paper using
VOC (Volatile Organic Compound)-free
vegetable oil based ink.



3 0 7 9 4 6 7 1 3

Printed in Japan

Download from [Www.Somanuals.com](http://www.Somanuals.com). All Manuals Search And Download.

Free Manuals Download Website

<http://myh66.com>

<http://usermanuals.us>

<http://www.somanuals.com>

<http://www.4manuals.cc>

<http://www.manual-lib.com>

<http://www.404manual.com>

<http://www.luxmanual.com>

<http://aubethermostatmanual.com>

Golf course search by state

<http://golfingnear.com>

Email search by domain

<http://emailbydomain.com>

Auto manuals search

<http://auto.somanuals.com>

TV manuals search

<http://tv.somanuals.com>