



MDR-AS700BT

[Getting Started](#) >

[BLUETOOTH](#) >

[One-touch connection \(NFC\)](#) >

[Music](#) >

[Phone calls](#) >

[Multi point connection](#) >

[Troubleshooting](#) >

[Important information](#) >

Copyright 2013 Sony Corporation



Getting Started

[Before First Use](#) >

[Features and location of parts](#) >

[Power](#) >

Copyright 2013 Sony Corporation



BLUETOOTH

[BLUETOOTH](#) >

[BLUETOOTH connection](#) >

Copyright 2013 Sony Corporation



One-touch connection (NFC)

[One-touch connection \(NFC\)](#) >

[One-touch connection](#) >

Copyright 2013 Sony Corporation



Music

[Listening to music](#)



Copyright 2013 Sony Corporation



[Top >](#)

Phone calls

[Phone calls](#)



Copyright 2013 Sony Corporation



Multi point connection

[Multi point connection](#)



Copyright 2013 Sony Corporation



Troubleshooting

[To deal with a trouble](#)



[Possible causes of symptoms](#)



Copyright 2013 Sony Corporation



Important information

[Important information](#)



Copyright 2013 Sony Corporation



Before First Use

[Before first use](#)



Copyright 2013 Sony Corporation



Features and location of parts

[Features](#) >

[Location and function of parts](#) >

Copyright 2013 Sony Corporation



Power

[Charging the headset](#)



Copyright 2013 Sony Corporation



BLUETOOTH

[What is BLUETOOTH wireless technology?](#) >

[What you can do with BLUETOOTH function](#) >

[Steps to BLUETOOTH function](#) >

Copyright 2013 Sony Corporation



BLUETOOTH connection

[Pairing and connecting with an Android smartphone](#) >

[Connecting with a paired Android smartphone](#) >

[Pairing and connecting with an iPhone](#) >

[Connecting with a paired iPhone](#) >

[Pairing and connecting with other BLUETOOTH devices](#) >

[Connecting with a paired BLUETOOTH device](#) >

[Indications of BLUETOOTH function](#) >



One-touch connection (NFC)

[Compatible smartphones](#)



[Preparation on the smartphone](#)



[About “NFC Easy Connect” App](#)



Copyright 2013 Sony Corporation



One-touch connection

[Connecting with a smartphone by one-touch functions](#) >

[Disconnecting the smartphone by one-touch functions](#) >

[Switching the device by one-touch functions](#) >

Copyright 2013 Sony Corporation



Listening to music

[Listening to music](#) >

[Controlling the audio device](#) >

[Selecting the sound quality mode of music playback](#) >

Copyright 2013 Sony Corporation



Phone calls

[Making a call](#) >

[Receiving a call](#) >

[Controlling the smartphone or mobile phone](#) >

Copyright 2013 Sony Corporation



Multi point connection

[Connecting the headset with a music player and a smartphone \(mobile phone\)](#) >

[Connecting the headset with 2 Android smartphones](#) >

[Connecting the headset with an Android smartphone and an iPhone](#) >

Copyright 2013 Sony Corporation



To deal with a trouble

[What can I do to solve a problem?](#)



Copyright 2013 Sony Corporation



Possible causes of symptoms

[Table of contents for symptoms and possible causes](#) >

[Power and charging](#) >

[BLUETOOTH connection](#) >

[One-touch connection \(NFC\)](#) >

[Music](#) >

[Phone calls](#) >

Copyright 2013 Sony Corporation



Important information

[License and trademark notice](#)



Copyright 2013 Sony Corporation



Before first use

In addition to this Help Guide, read the printed manuals supplied: “Quick Start Guide” and “Reference Guide.”

Quick Start Guide

This covers initial settings and basic operations.

Reference Guide

This includes information about using your wireless stereo headset safely, and specifications of your wireless stereo headset.

For information about the customer support Web site, access:

<http://www.sony.net/>

About battery charging

See “[Charging the headset](#)” on how to charge the battery.

→ [Features](#)



Features

- Water resistant specification against sweat or a spray
- Neck band style for comfortable listening and stable fitting
- One-touch connection (NFC)
- BLUETOOTH version 3.0 for higher quality audio with less interference, lower power consumption and easy connection
- AAC Codec supported
Plays music compressed in AAC format with high quality sound.
- Enjoy music wirelessly from BLUETOOTH Stereo-enabled music players and mobile phones.
- Embedded microphone enables hands-free conversation from BLUETOOTH-enabled mobile phone.
- Noise suppression and echo cancellation functions for superior conversation sound quality
- Enjoy basic remote control operation (play, pause , etc.) of music player functions via BLUETOOTH connection.
- Multi pairing and multi point connection supported
- Up to 9 hours of listening time
- Easy USB recharging using the provided micro-USB cable

→ [Location and function of parts](#)



Location and function of parts

Functions of buttons, indicators, and other parts on your wireless stereo headset are explained here.

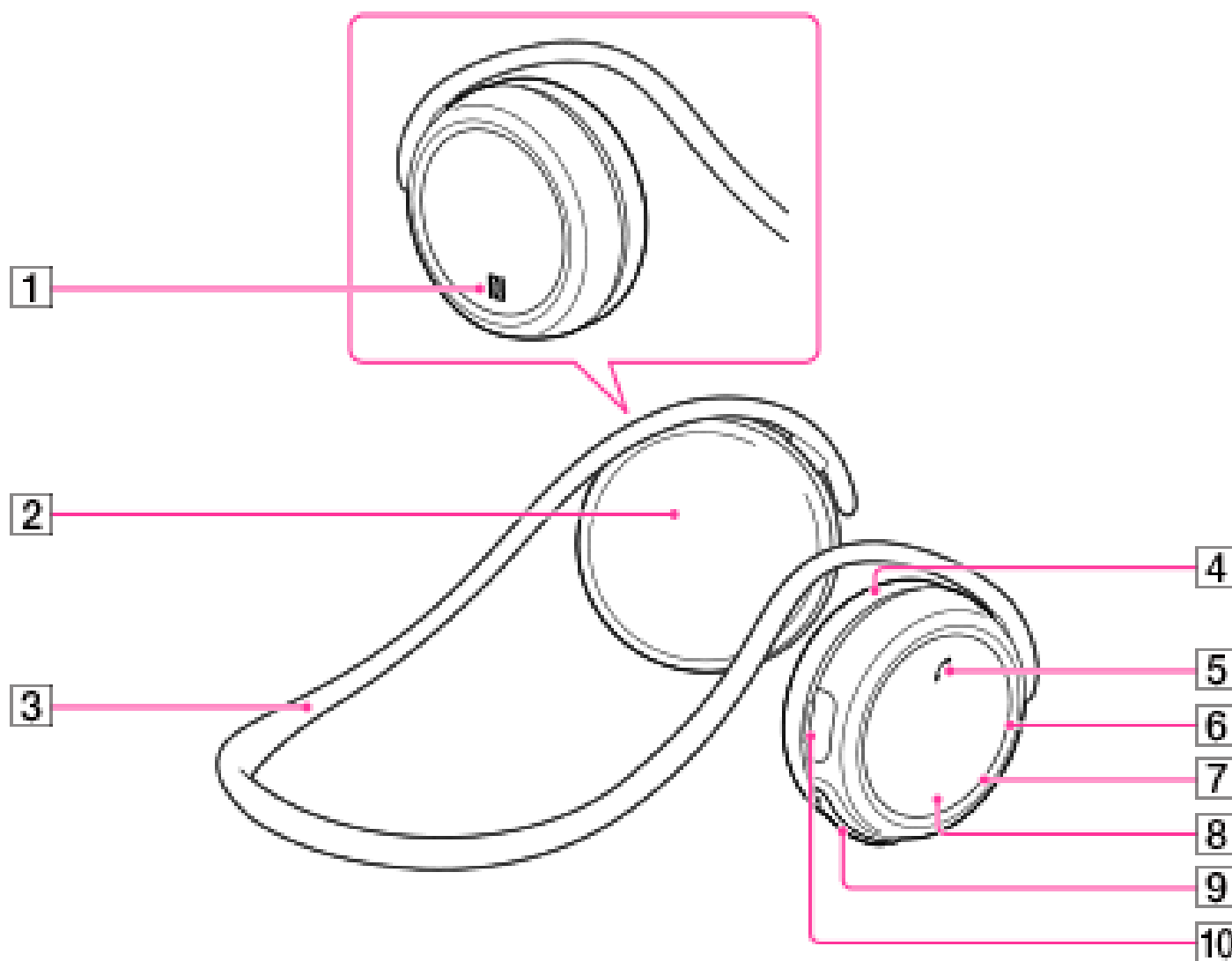

1 N mark [\[Details\]](#)

2 Left (L) unit

- 3 Neck band
- 4 Right (R) unit
- 5  POWER button
Controls various call and playback functions.
- 6 Microphone
- 7 Indicator
Lights up in red or blue to indicate the power or communication status of the headset.
- 8 Built-in antenna
The BLUETOOTH antenna is built into the headset.
- 9 VOL (volume) +/- (◀▶) buttons
Controls various functions when listening to music.
The + button has a tactile dot.
- 10 Micro-USB port [\[Details\]](#)
Connect a computer to this port with the supplied micro-USB cable to charge the headset.

→ [Charging the headset](#)

Copyright 2013 Sony Corporation



Charging the headset

The headset contains a lithium ion rechargeable battery, which should be charged before using the headset for the first time.

System requirements for battery charge using USB

Personal Computer with pre-installed with any of the following operating systems and USB port:

Operating Systems

(when using Windows)

Windows® 8 / Windows® 8 Pro

Windows® 7

Home Basic / Home Premium / Professional / Ultimate

Windows Vista® (Service Pack 2 or later)

Home Basic / Home Premium / Business / Ultimate

Windows® XP (Service Pack 3 or later)

Home Edition / Professional / Media Center Edition 2004 / Media Center Edition 2005

(when using Macintosh)

Mac OS X (version.10.3 or later)

Charging the headset

1. Open the cover of the micro-USB port.
2. Connect the supplied micro-USB cable to the headset, and then connect the other end to a computer booted.

Make sure that you connect the plug of the micro-USB cable in the direction as shown in the illustration below.

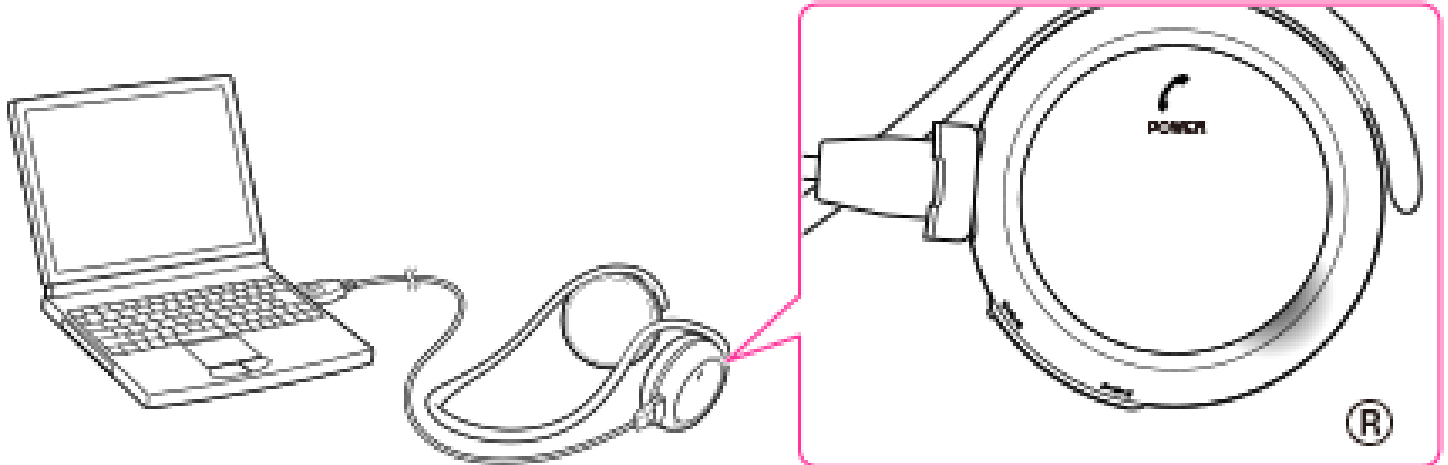

Charging starts when the headset and the computer are connected.

Make sure that the indicator (red) lights up. Charging is completed in about 1.5 hours* and the indicator (red) goes off automatically.

* Time required to charge the empty battery to its full capacity

Notes

- Use the micro-USB cable supplied. You may not be able to charge the headset with other cables.
- If the headset is not used for a long time, the indicator (red) may not light up when you connect the micro-USB cable to charge the headset. In this case, do not disconnect the micro-USB cable from the headset and wait until the indicator (red) lights up.

Tips

- If the micro-USB cable is connected to a computer while the headset is turned on, the headset will be turned off automatically.
- To charge the headset from an AC outlet, use USB AC Adaptor* (sold separately). For details, refer to the manuals supplied with the USB AC Adaptor.
- The headset cannot be turned on while charging the battery.

* Refer to the Reference Guide on the recommended adapter.

Caution

If the headset detects a problem while charging, the indicator (red) may turn off,

although charging is not complete.

Check for the following causes:

- Ambient temperature exceeds the range of 5 °C – 35 °C (41 °F – 95 °F).
- There is a problem with the battery.

In this case, charge again within the above-mentioned temperature range. If the problem persists, consult your nearest Sony dealer.

Notes

- If the headset is not used for a long time, the battery may be quickly depleted, however, after a few recharges, the battery life will improve.
- Even if you do not intend to use the headset for a long time, charge the battery to its full capacity once every 6 months to maintain its performance.
- If the headset is not used for a long time, it may take longer to charge the battery.
- If the life of the built-in rechargeable battery drops to half the normal length, the battery should be replaced. Consult your nearest Sony dealer for replacement of the rechargeable battery.
- Avoid exposure to temperature extremes, direct sunlight, moisture, sand, dust or mechanical shock. Never leave the headset in a car parked in the sun.
- If the computer enters into hibernation mode while connected to the headset, charging will not be completed properly. Check the setting of the computer before charging. The indicator (red) will go off automatically even if the computer enters into hibernation mode. Charge the headset again in this case.
- Use the supplied micro-USB cable only, and connect directly to a computer. Charging will not be completed properly by an indirect connection, such as via a USB hub.

Usage hours

Status	Approx. usage hours
Communication time (including music playback time) (up to)	9 hours

Time stated above may vary, depending on ambient temperature or conditions of use.

Checking the remaining battery

When you turn on the headset by pressing the  POWER button, the indicator (red) flashes. You can check the remaining battery by the number of times the indicator (red) flashes.

Indicator (red)	Status
3 times	Full
2 times	Mid
1 time	Low (needs to charge)

When the battery is almost empty

The indicator turns red. When the battery becomes empty, the headset sounds a beep and turns off automatically.



What is BLUETOOTH wireless technology?

Bluetooth® wireless technology is a short-range wireless technology that enables wireless data communication between digital devices, such as a computer or digital camera. BLUETOOTH wireless technology operates within a range of about 10 meters (about 30 feet).

Connecting 2 devices as necessary is common, but some devices can be connected to multiple devices at the same time.

You do not need to use a cable for connection, nor is it necessary for the devices to face one another, such is the case with infrared technology. For example, you can use such a device in a bag or pocket.

BLUETOOTH standard is an international standard supported by thousands of companies all over the world, and employed by various companies worldwide.

Communication System and Compatible BLUETOOTH Profiles of the headset

Profile is standardization of the function for each BLUETOOTH device specification.

The headset supports the following BLUETOOTH version and profiles:

Communication System :

BLUETOOTH Specification Ver. 3.0

Compatible BLUETOOTH Profiles:

- A2DP (Advanced Audio Distribution Profile): Transmitting or receiving audio content of high-quality.
- AVRCP (Audio Video Remote Control Profile): Controlling A/V equipment; pausing, stopping, starting playback, etc.
- HSP (Headset Profile)*: Talking on the phone/Operating the phone.
-

- HFP (Hands-free Profile)*: Talking on the phone/Operating the phone by hands-free.

* When you use a BLUETOOTH mobile phone supported by both HFP (Hands-free Profile) and HSP (Headset Profile), set it to HFP.

Notes

- To use the BLUETOOTH function, the BLUETOOTH device to be connected requires the same profile as that of the headset. Even if the device has the same profile, functions may vary depending on the specifications.
- Due to the characteristic of BLUETOOTH wireless technology, the sound played on the headset is slightly delayed from the sound played on the BLUETOOTH device during talking on the telephone or listening to the music.
- Do not use the BLUETOOTH function on an airplane. The radio waves may cause malfunction of the airplane and result in hazardous accidents.

→ [What you can do with BLUETOOTH function](#)

Copyright 2013 Sony Corporation



What you can do with BLUETOOTH function

The headset uses BLUETOOTH wireless technology. You can enjoy music wirelessly from a smartphone, mobile phone, or music player. Also, you can make or receive a call by operating the headset.

Listening to music

You can enjoy music wirelessly from a smartphone, mobile phone, or music player.

[\[Details\]](#)

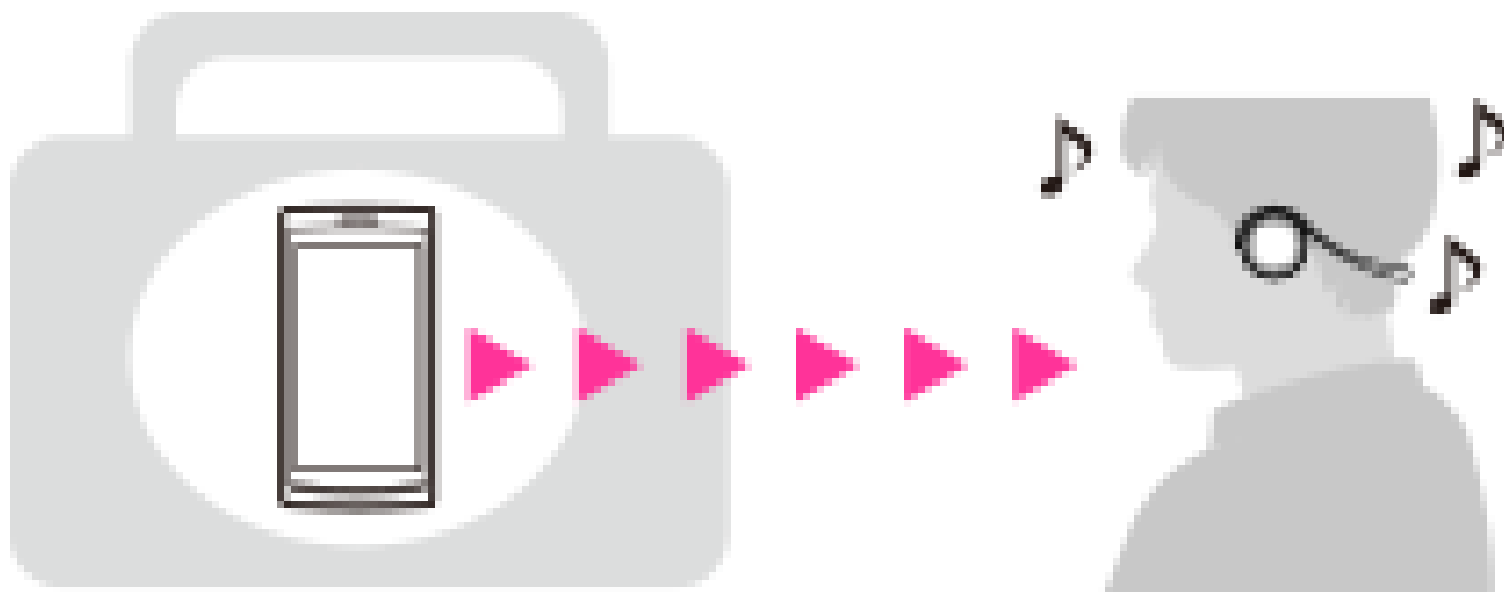

Talking on the phone

You can make and receive a call with your hands free, while leaving your smartphone or mobile phone in your bag or pocket. [\[Details\]](#)

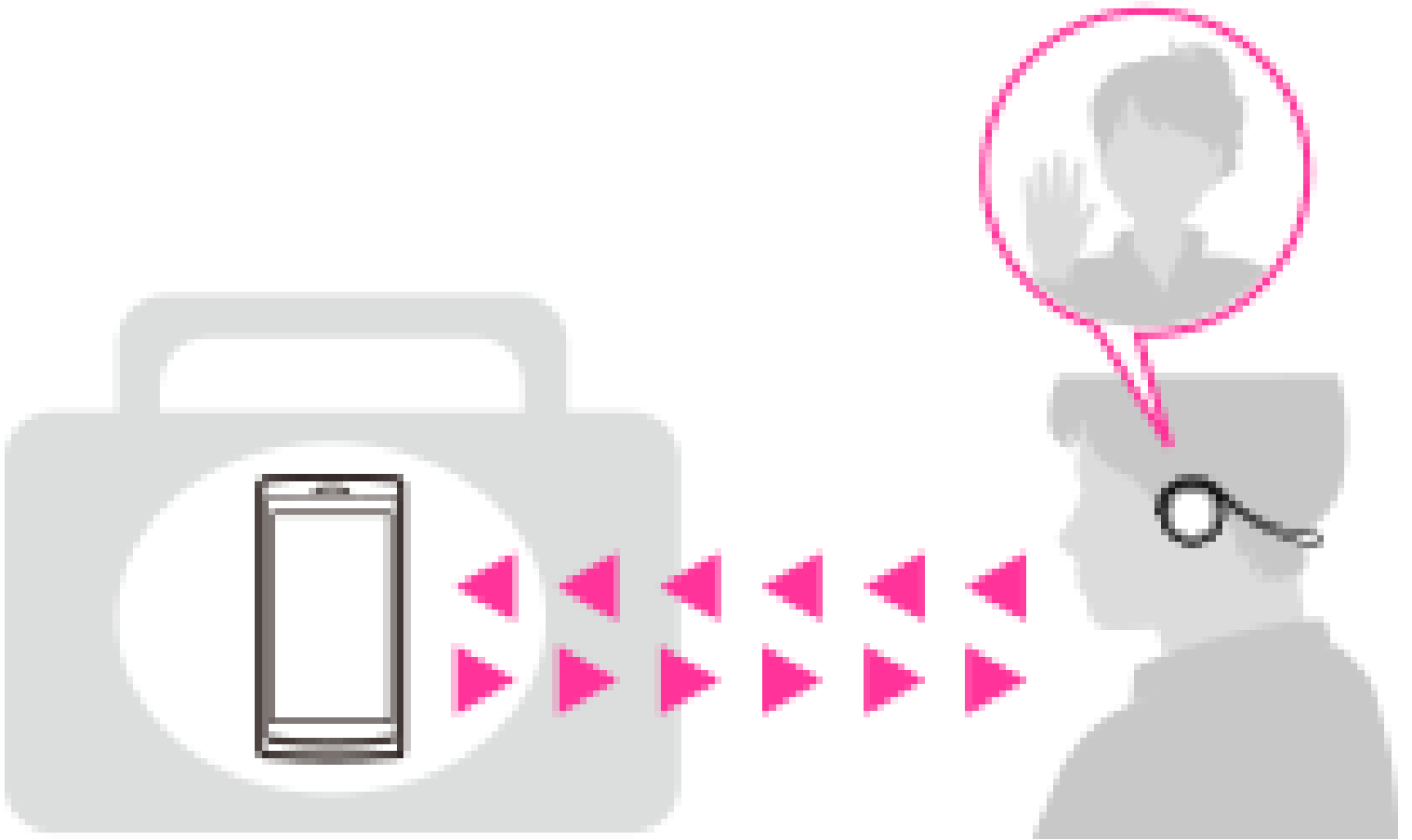

→ [Steps to BLUETOOTH function](#)

Copyright 2013 Sony Corporation



Steps to BLUETOOTH function

To listen to music played, or make a call on a BLUETOOTH smartphone or mobile phone, you must establish a BLUETOOTH connection between the headset and the BLUETOOTH device.

There are following 2 ways to establish a BLUETOOTH connection:

- One-touch connection (NFC): You can connect the headset with a device by one touch using the NFC function. [\[Details\]](#)
- Pairing the headset with a BLUETOOTH device by operating the BLUETOOTH device [\[Details\]](#)

In the case of the one-touch connection, you can perform steps 1 and 2 below by a one-touch operation.

1. Register (pair) a BLUETOOTH device (smartphone, mobile phone, etc.) and the headset with each other.

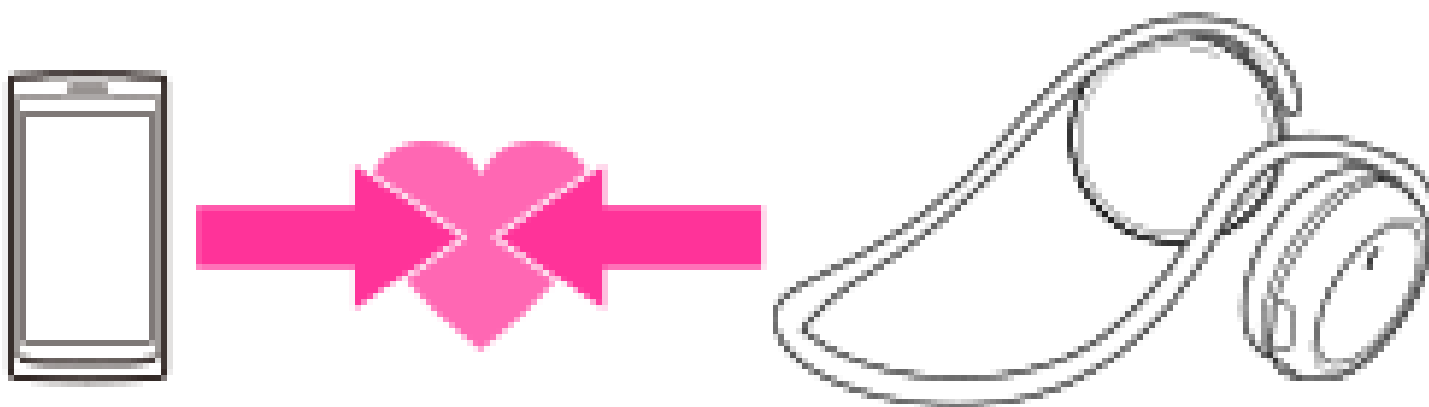

2. Use the BLUETOOTH device to make a BLUETOOTH connection.



3. Listen to music played on the BLUETOOTH device, or make and receive a call by operating the headset.

The headset supports the following BLUETOOTH version and profiles:

Communication System :

BLUETOOTH Specification Ver. 3.0

Compatible BLUETOOTH Profiles:

- A2DP (Advanced Audio Distribution Profile): Transmitting or receiving audio content of high-quality.
- AVRCP (Audio Video Remote Control Profile): Controlling A/V equipment; pausing, stopping, starting playback, etc.
- HSP (Headset Profile)*: Talking on the phone/Operating the phone.
- HFP (Hands-free Profile)*: Talking on the phone/Operating the phone by hands-free.

* When you use a BLUETOOTH smartphone or mobile phone supported by both HFP (Hands-free Profile) and HSP (Headset Profile), set it to HFP.

Notes

- To use the BLUETOOTH function, the BLUETOOTH device to be connected requires the same profile as that of the headset. Even if the device has the same profile, functions may vary depending on the specifications.
- Due to the characteristic of BLUETOOTH wireless technology, the sound played on the headset is slightly delayed from the sound played on the BLUETOOTH

device during talking on the telephone or listening to the music.

- Do not use the BLUETOOTH function on an airplane. The radio waves may cause malfunction of the airplane and result in hazardous accidents.

→ [Pairing and connecting with an Android smartphone](#)

Copyright 2013 Sony Corporation



Pairing and connecting with an Android smartphone

It is necessary to pair BLUETOOTH devices to establish a BLUETOOTH connection. When pairing the headset with a smartphone, place the smartphone within 1 meter (3 feet) of the headset.

1. Enter pairing mode on the headset.

Press and hold the  POWER button for more than 7 seconds.

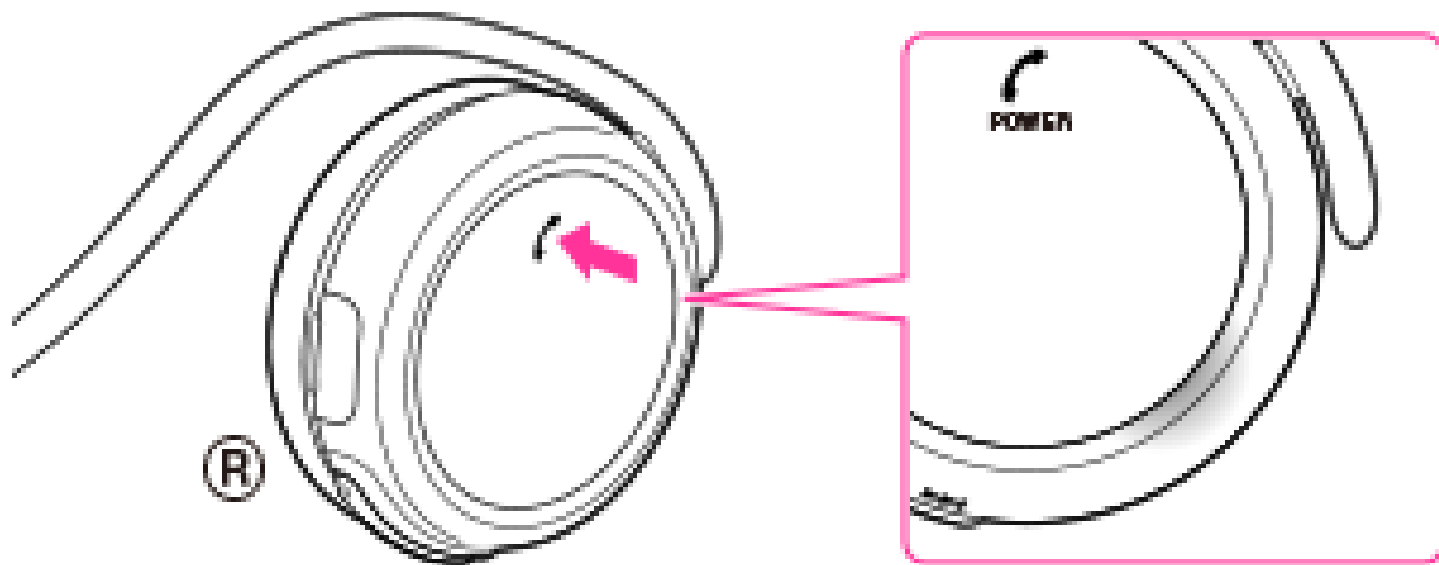

Make sure that the indicator flashes blue and red alternately after you release the button.

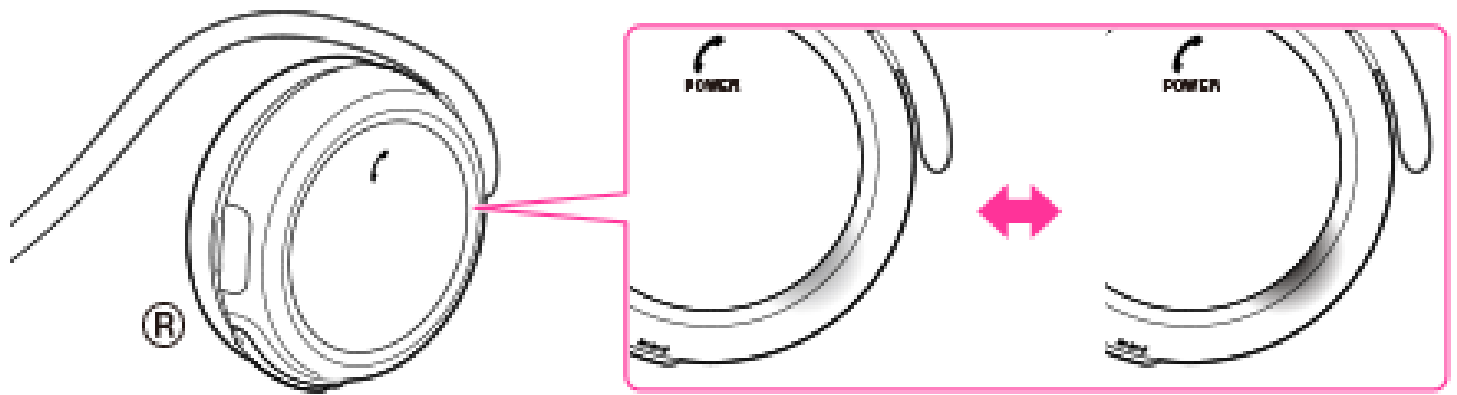

Note

- If pairing is not established within about 5 minutes, pairing mode will be cancelled and the headset will turn off. In this case, start over from step 1.
2. Select the BLUETOOTH setting on the smartphone.
Select [Settings] → [Bluetooth].
 3. Turn on the BLUETOOTH function on the smartphone.
Touch the button next to [Bluetooth] to turn on [Bluetooth].

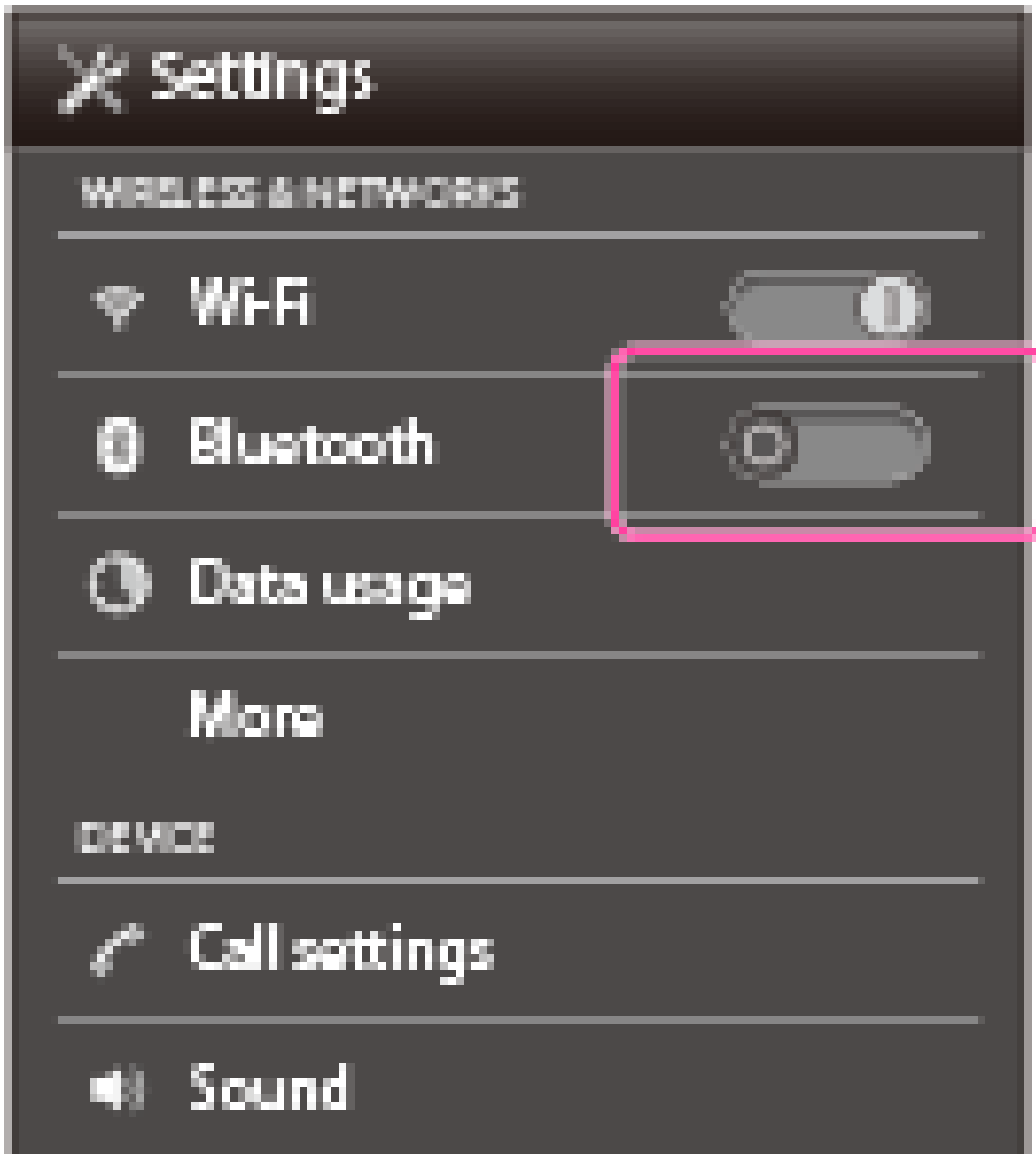

4. Search for this headset on the smartphone.
Touch [Bluetooth] → [Search for devices].

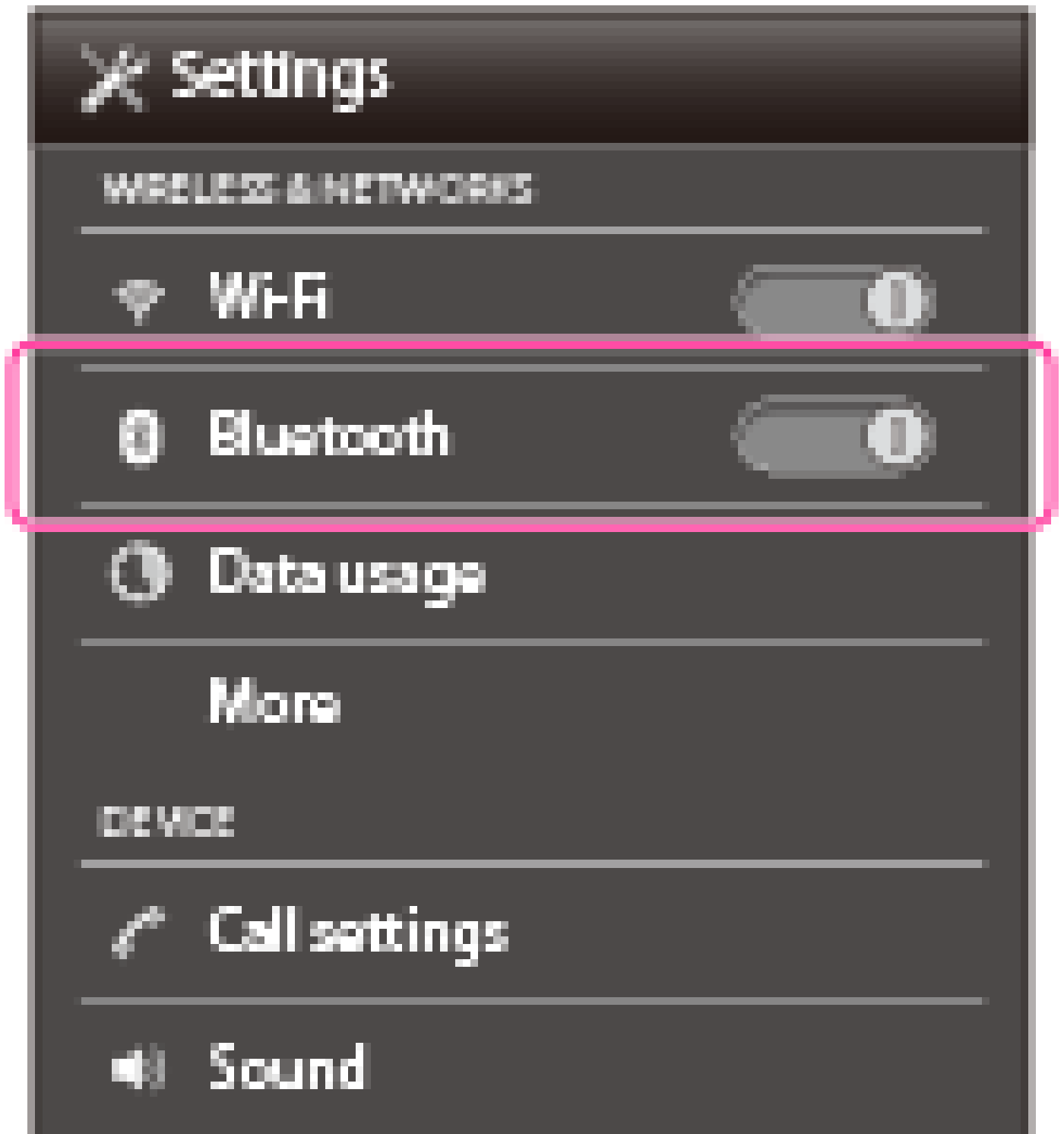

5. Touch [MDR-AS700BT].

If passkey input is required, input "0000."

A Passkey may be called a "Passcode," a "PIN code," a "PIN number," or a "Password."



The above procedure is an example. For details, refer to the manual supplied with your smartphone.

The headset and the smartphone are paired each other and connected.

If they are not connected, see step 2 of [“Connecting with a paired Android smartphone.”](#)

Tip

- To delete all pairing information, see [“What can I do to solve a problem?”](#)

Note

- Once BLUETOOTH devices are paired, there is no need for pairing again, except in the following cases:
 - Pairing information is deleted after repair, etc.
 - The headset is paired with 9 or more devices. The headset can be paired with up to 8 devices; if a new device is paired after 8 devices have been paired, the device whose latest connection time is the oldest among the 8 paired devices is replaced by the new one.
 - When recognition of the headset by the device to be connected is deleted.
 - The headset is initialized. All pairing information is deleted.
- [Connecting with a paired Android smartphone](#)
-

Copyright 2013 Sony Corporation



Connecting with a paired Android smartphone

1. Turn on the headset.

Press and hold the  POWER button for about 2 seconds.

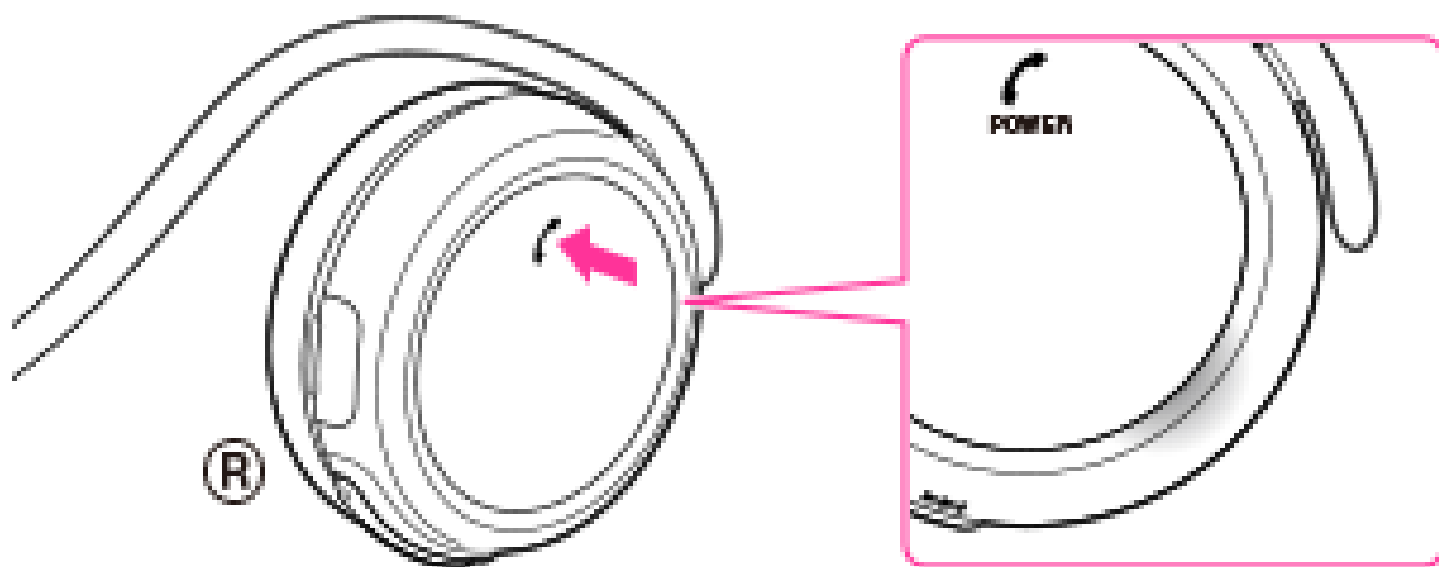

Make sure that the indicator (blue) flashes after you release the button.

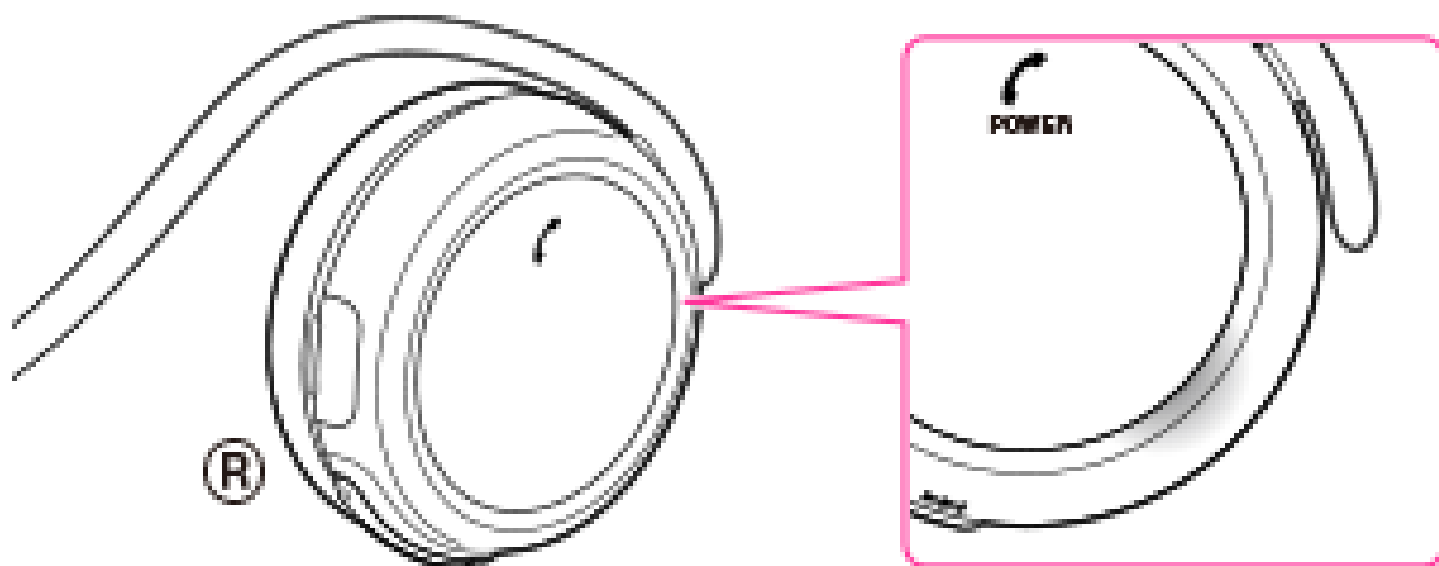

The headset may be connected with the smartphone as soon as you turn on both devices.

Check the connecting status on the smartphone. If not connected, proceed to step 2.

2. Make the BLUETOOTH connection from the smartphone.

Touch [Settings] → [Bluetooth]. Make sure that [Bluetooth] is set to on, then touch [MDR-AS700BT].

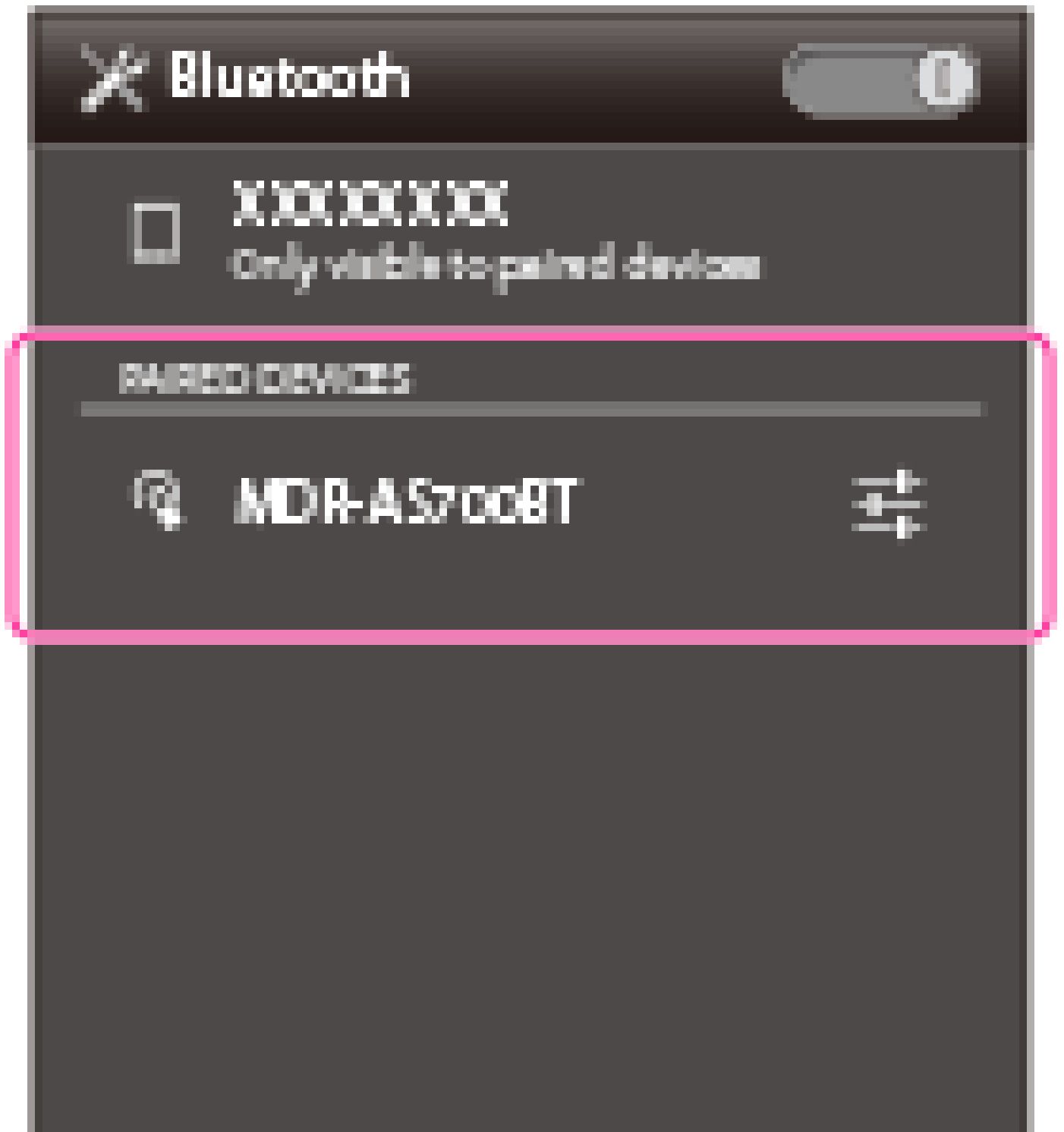

→ [Pairing and connecting with an iPhone](#)



Pairing and connecting with an iPhone

It is necessary to pair BLUETOOTH devices to establish a BLUETOOTH connection. When pairing the headset with an iPhone, place the iPhone within 1 meter (3 feet) of the headset.

1. Enter pairing mode on the headset.

Press and hold the  POWER button for more than 7 seconds.

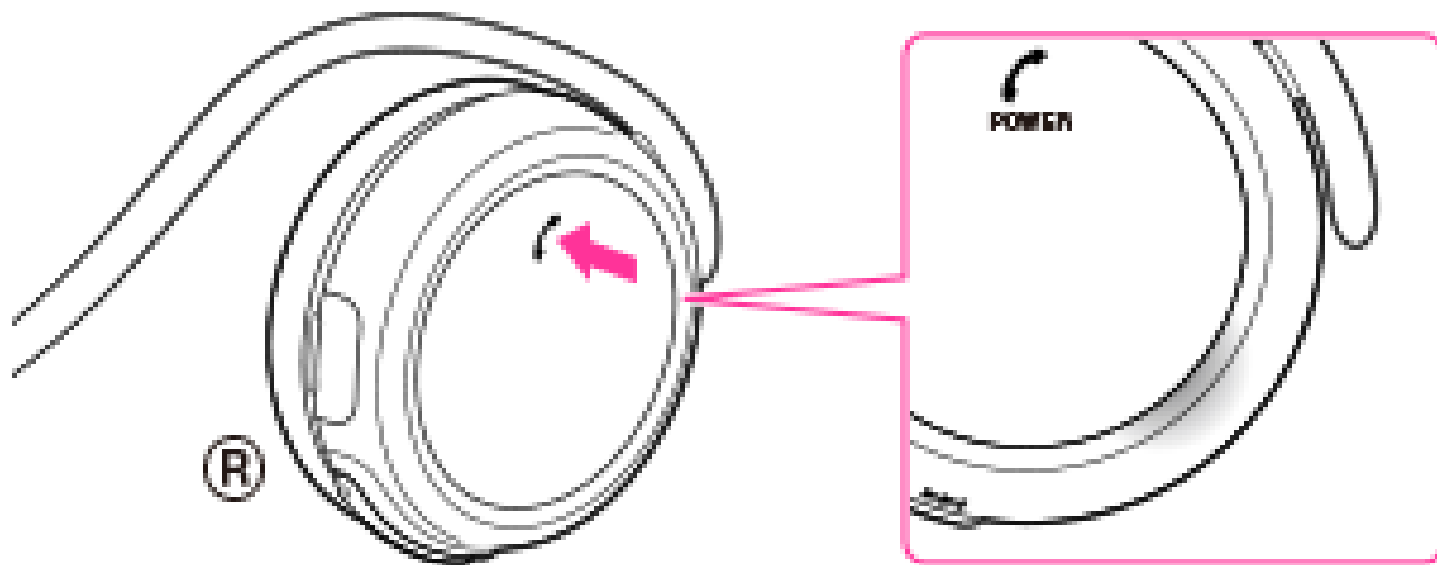

Make sure that the indicator flashes blue and red alternately after you release the button.

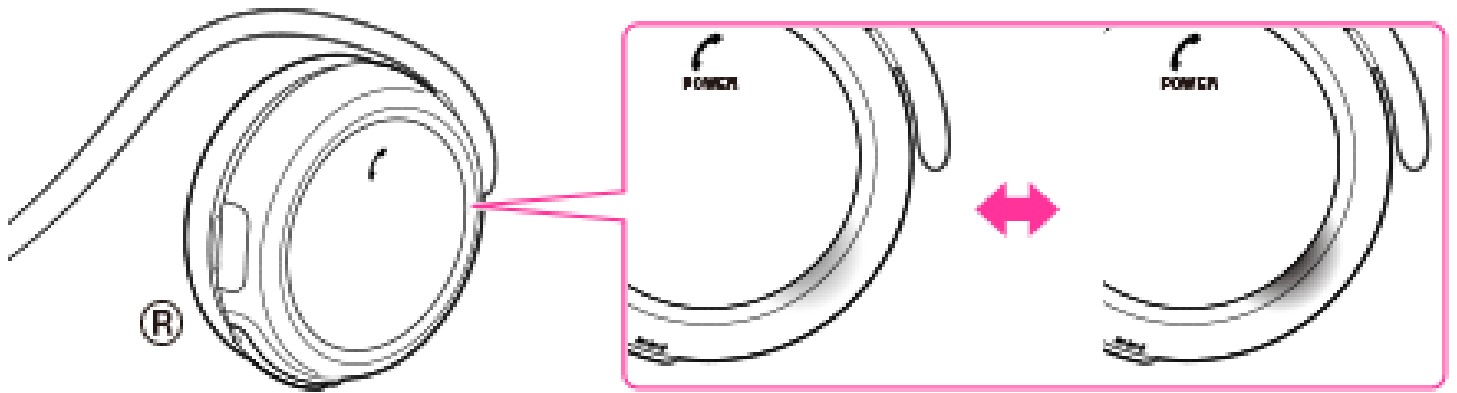

Note

- If pairing is not established within about 5 minutes, pairing mode will be cancelled and the headset will turn off. In this case, start over from step 1.

2. Select the BLUETOOTH setting on the iPhone.
Select [Settings] → [Bluetooth].



3. Turn on the BLUETOOTH function on the iPhone.
Touch [OFF] to change it to [ON].



4. Touch [MDR-AS700BT].

If passkey input is required, input "0000."

A Passkey may be called a "Passcode," a "PIN code," a "PIN number," or a "Password."

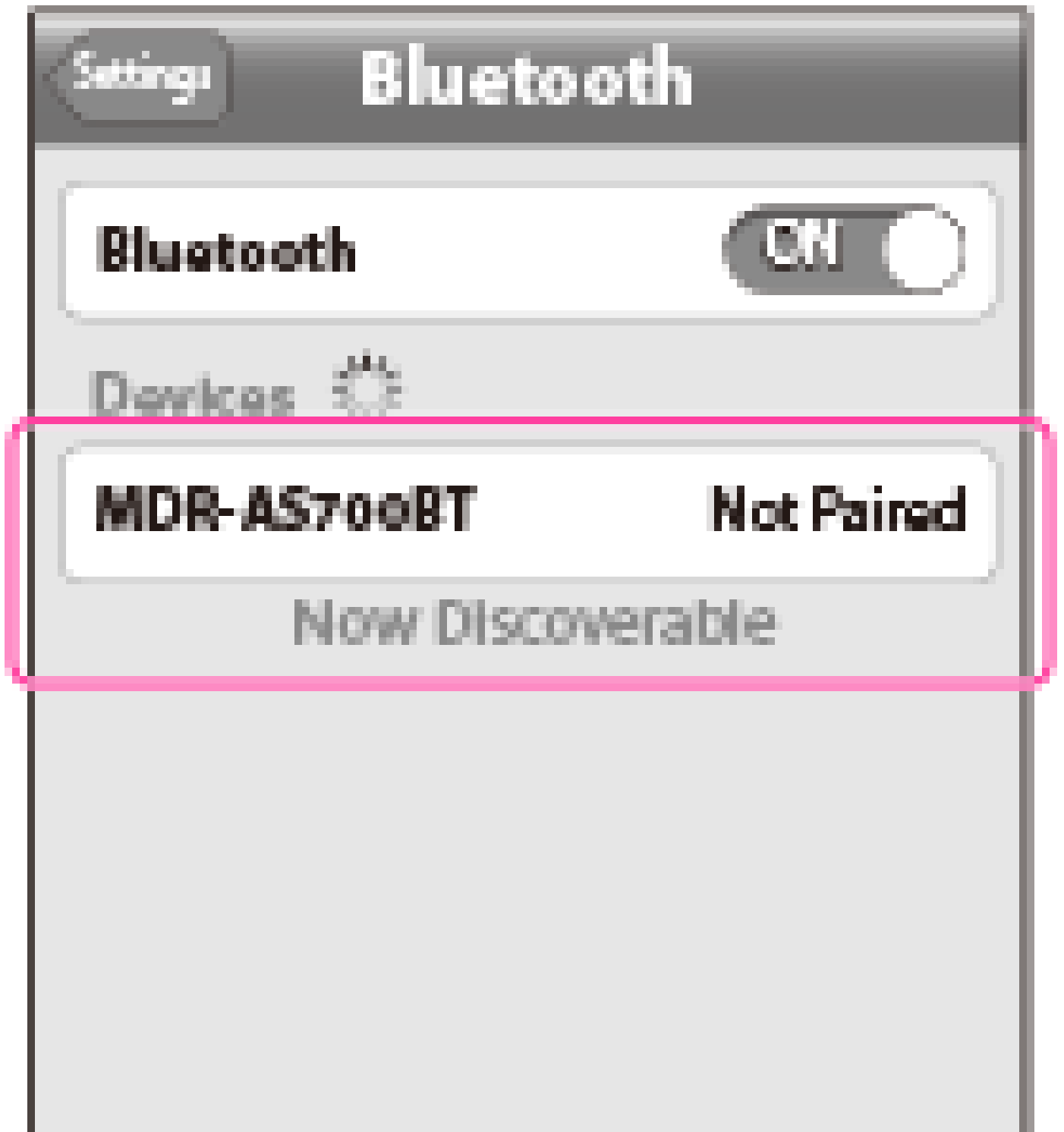

The above procedure is an example. For details, refer to the manual supplied with your iPhone.

The headset and the iPhone are paired each other and connected.

If they are not connected, see step 2 of [“Connecting with a paired iPhone.”](#)

Tip

- To delete all pairing information, see [“What can I do to solve a problem?”](#)

Note

- Once BLUETOOTH devices are paired, there is no need for pairing again, except in the following cases:
 - Pairing information is deleted after repair, etc.
 - The headset is paired with 9 or more devices. The headset can be paired with up to 8 devices; if a new device is paired after 8 devices have been paired, the device whose latest connection time is the oldest among the 8 paired devices is replaced by the new one.
 - When recognition of the headset by the device to be connected is deleted.
 - The headset is initialized. All pairing information is deleted.

→ [Connecting with a paired iPhone](#)

Copyright 2013 Sony Corporation



Connecting with a paired iPhone

1. Turn on the headset.

Press and hold the  POWER button for about 2 seconds.

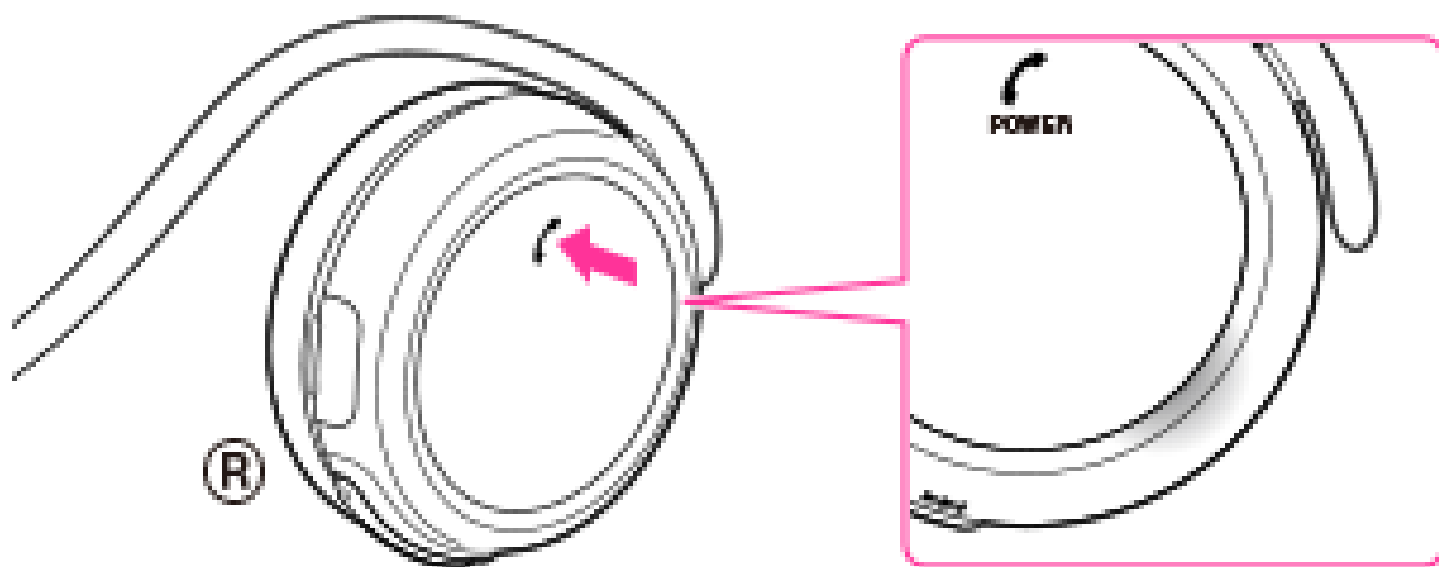

Make sure that the indicator (blue) flashes after you release the button.

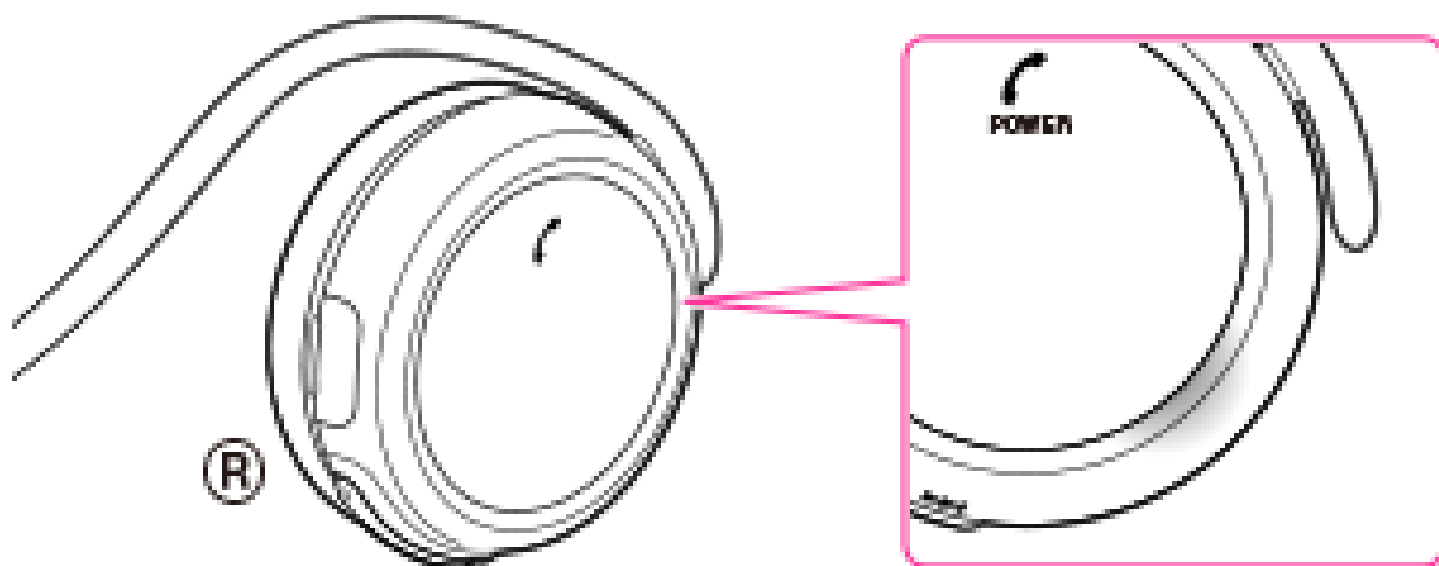

The headset may be connected with the iPhone as soon as you turn on both devices.

Check the connecting status on the iPhone. If not connected, proceed to step 2.

2. Make the BLUETOOTH connection from the iPhone.

Touch [Settings] → [Bluetooth]. Make sure that [ON] is selected, then touch [MDR-AS700BT].



→ Pairing and connecting with other BLUETOOTH devices

Copyright 2013 Sony Corporation



Pairing and connecting with other BLUETOOTH devices

It is necessary to pair BLUETOOTH devices to establish a BLUETOOTH connection. When pairing the headset with a BLUETOOTH device, place the BLUETOOTH device within 1 meter (3 feet) of the headset.

1. Enter pairing mode on the headset.

Press and hold the  POWER button for more than 7 seconds.

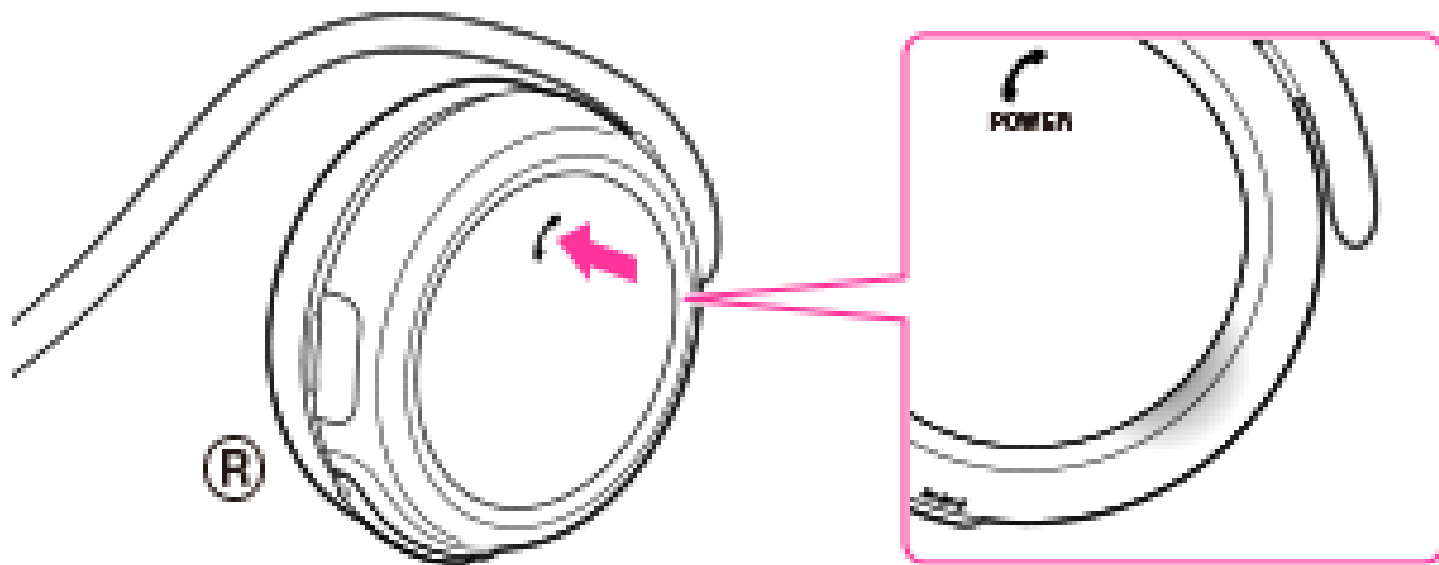

Make sure that the indicator flashes blue and red alternately after you release the button.

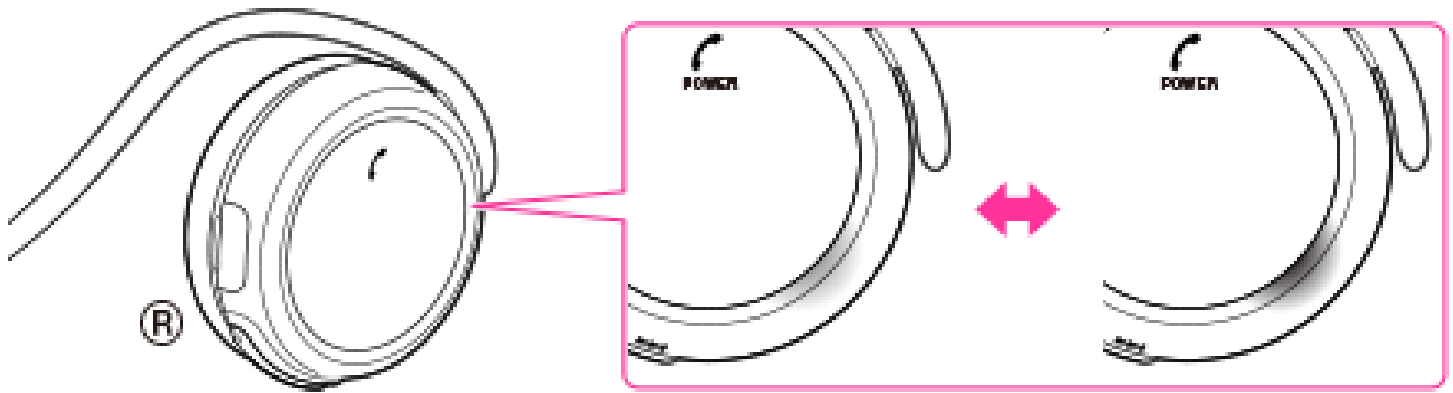

Note

- If pairing is not established within about 5 minutes, pairing mode will be cancelled and the headset will turn off. In this case, start over from step 1.
2. Perform the pairing procedure on the BLUETOOTH device to search for this headset.
“MDR-AS700BT” will be displayed on the list of detected devices on the screen of the BLUETOOTH device. If “MDR-AS700BT” is not displayed, repeat from step 1.
 3. Select “MDR-AS700BT” on the screen on the BLUETOOTH device to pair both devices.
If passkey input is required on the display of a BLUETOOTH device, input “0000.”
A Passkey may be called a “Passcode,” a “PIN code,” a “PIN number,” or a “Password.”
 4. Make the BLUETOOTH connection from the BLUETOOTH device.
Depending on the BLUETOOTH device, the headset may be connected with the device automatically as soon as they are paired.

Tip

- To delete all pairing information, see [“What can I do to solve a problem?”](#)

Notes

- For details, refer to the manual supplied with the BLUETOOTH device.
- When pairing with a BLUETOOTH device that cannot display a list of detected devices or that has no display, you may pair the device by setting both the

headset and the BLUETOOTH device to pairing mode. At this time, if passkey is set besides “0000” on the BLUETOOTH device, pairing cannot be done with the headset.

- Once BLUETOOTH devices are paired, there is no need for pairing again, except in the following cases:
 - Pairing information is deleted after repair, etc.
 - The headset is paired with 9 or more devices. The headset can be paired with up to 8 devices; if a new device is paired after 8 devices have been paired, the device whose latest connection time is the oldest among the 8 paired devices is replaced by the new one.
 - When recognition of the headset by the device to be connected is deleted.
 - The headset is initialized. All pairing information is deleted.

→ [Connecting with a paired BLUETOOTH device](#)

Copyright 2013 Sony Corporation



Connecting with a paired BLUETOOTH device

1. Turn on the headset.

Press and hold the  POWER button for about 2 seconds.

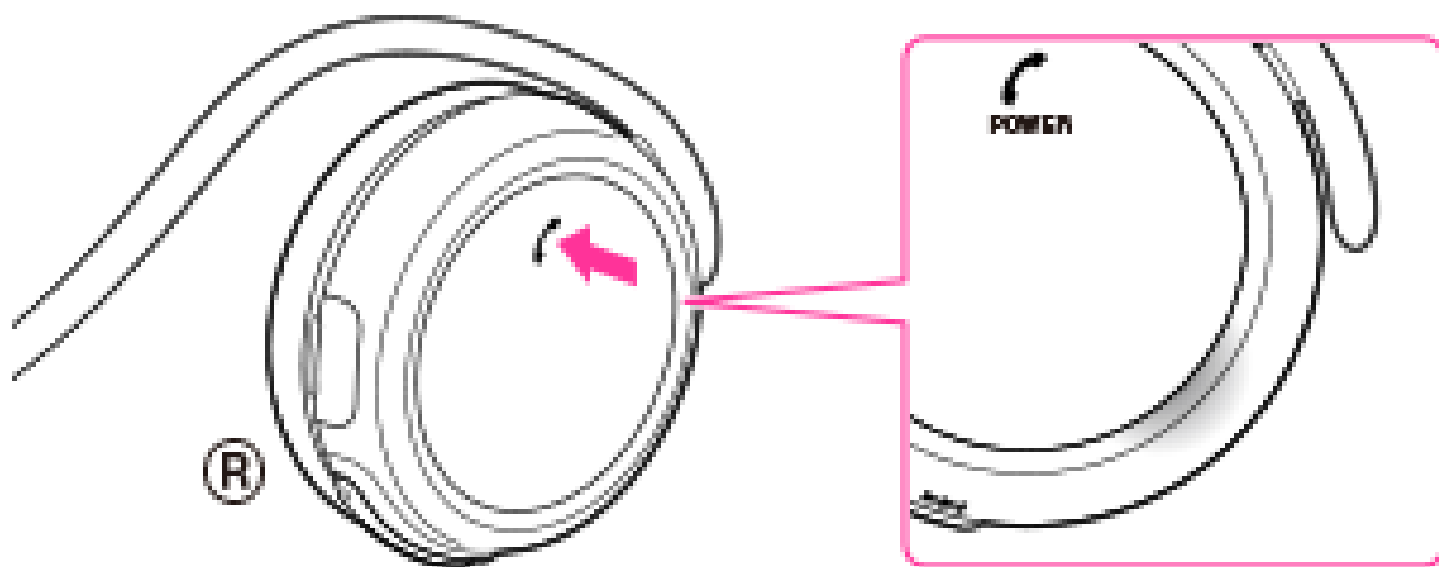

Make sure that the indicator (blue) flashes after you release the button.

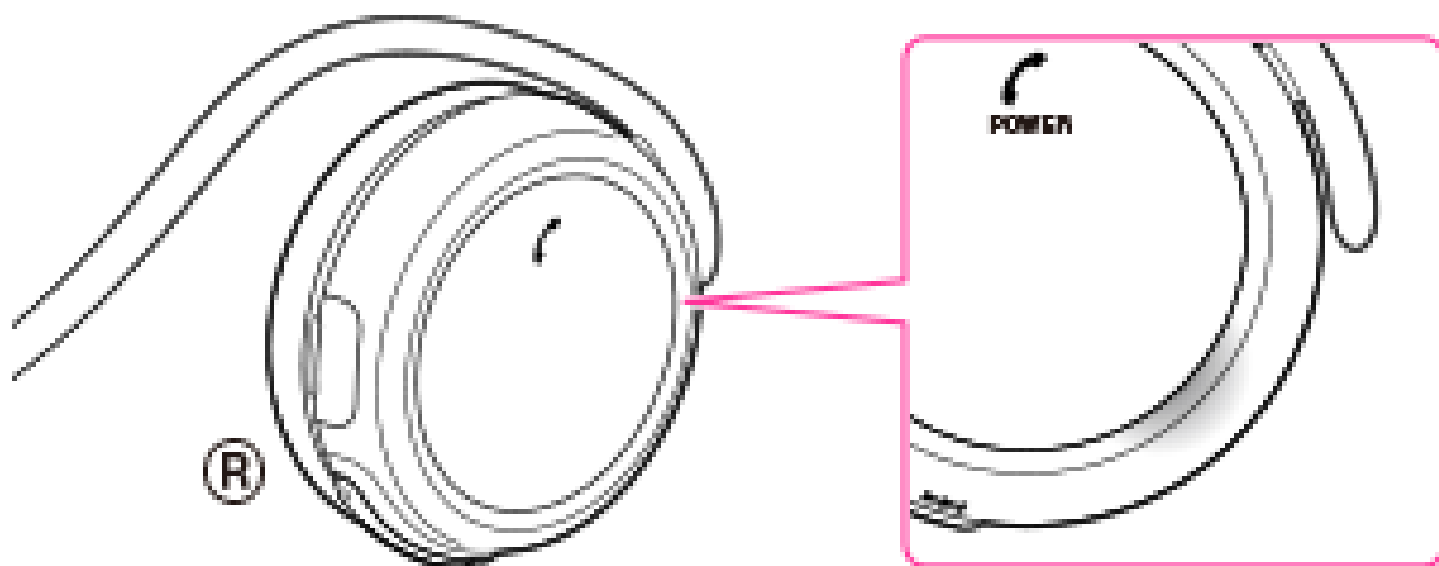

The headset may be connected with the BLUETOOTH device as soon as you turn on both devices.

Check the connecting status on the BLUETOOTH device. If not connected, proceed to step 2.

2. Make the BLUETOOTH connection from the BLUETOOTH device.
For details, refer to the manual supplied with your BLUETOOTH device.

→ [Indications of BLUETOOTH function](#)

Copyright 2013 Sony Corporation



Indications of BLUETOOTH function

The indicator flashes in red or blue to indicate the BLUETOOTH connection status.

Status	Flashing pattern ○ : blue/ ● : red
Pairing mode	○●○●○●○●○●○●...
Connectable	○--○--○--○--○--○--○--○...
Connecting	○○-○○-○○-○○-○○-○○-...
Connected (HFP/HSP or A2DP)	○-----○-----...
Connected (HFP/HSP and A2DP)	○-○-----○-○-----...
Playing music or During a call (Connected HFP/HSP or A2DP)	○○-----○○-----...
Playing music or During a call (Connected HFP/HSP and A2DP)	○○○-----○○○-----...
Incoming call	○○○○○○○○○○○○○○○○○○...

When the remaining battery power becomes low, the indicator turns from blue to red, except for pairing mode.



Compatible smartphones

NFC (Near Field Communication) is a technology enabling short-range wireless communication between various devices, such as mobile phones and IC tags. Thanks to the NFC function, data communication can be achieved easily just by touching the relevant symbol or designated location on NFC compatible devices. By using the NFC function, the headset is turned on automatically and then paired and connected with a BLUETOOTH device.

Compatible smartphones

- Smartphones with the NFC function built-in (OS: Android 2.3.3 or later, excluding Android 3.x)

→ [Preparation on the smartphone](#)



Preparation on the smartphone

1. Download and install the app “NFC Easy Connect” in your smartphone.

Access the following Web site:

<https://play.google.com/store/apps/details?id=com.sony.easyconnect>

The App may not be available in some countries and/or regions.

By the two-dimensional code:

Use a two-dimensional code reader app.



Tip

- If your smartphone has an NFC function, such as that of Android 4.1 or later, you may not need to install “NFC Easy Connect” to connect the headset with your smartphone by one touch. In that case, you do not need to perform step 1, above. The operation and specifications may be different from the description here. For details, refer to the manual supplied with your smartphone.

2. Set the smartphone so that the NFC function can be used.
For details, refer to the manual of the smartphone.

→ [About “NFC Easy Connect” App](#)

Copyright 2013 Sony Corporation



About “NFC Easy Connect” App

“NFC Easy Connect” is Sony’s original app for Android Phone available at Google Play Store.

To find out more about the functions, search for “NFC Easy Connect” and download the free app.

The App may not be available in some countries and/or regions.

→ [Connecting with a smartphone by one-touch functions](#)

Copyright 2013 Sony Corporation



Connecting with a smartphone by one-touch functions

By touching the headset with a smartphone, the headset is turned on automatically and then proceeds to pairing and BLUETOOTH connection.

1. Unlock the screen of the smartphone.

If you installed the “NFC Easy Connect” App in the smartphone, start the “NFC Easy Connect” App.

2. Touch the headset with the smartphone.

Touch the smartphone on the N marked part of the headset.

Refer to the manual of the smartphone for the designated location to be touched on the smartphone.

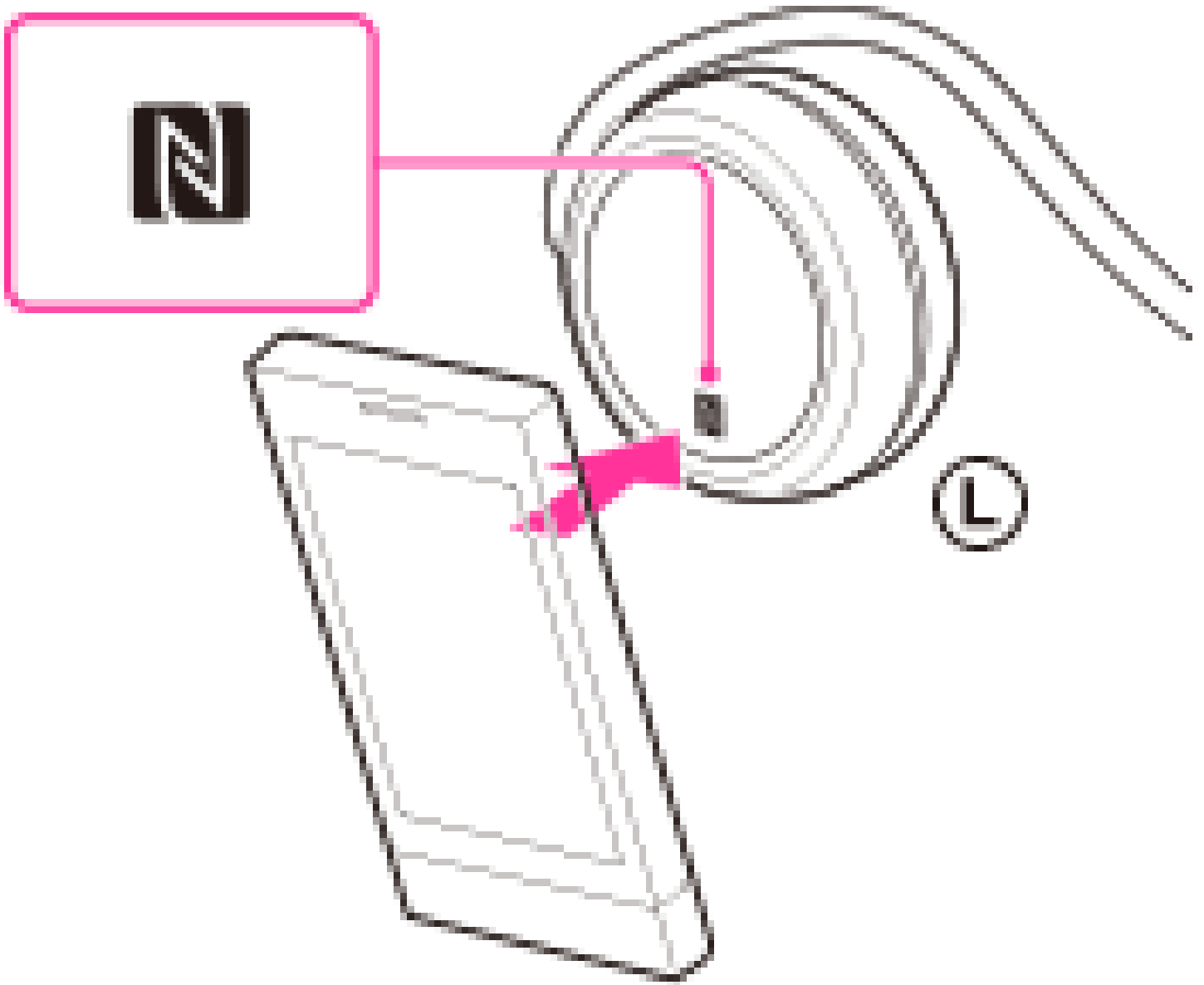

Follow the on-screen instructions to complete the connection.

→ [Disconnecting the smartphone by one-touch functions](#)

Copyright 2013 Sony Corporation



Disconnecting the smartphone by one-touch functions

You can disconnect the headset from the smartphone by touching the headset with it.

1. Unlock the screen of the smartphone.

If you installed the “NFC Easy Connect” App in the smartphone, start the “NFC Easy Connect” App.

2. Touch the headset with the smartphone.

Touch the smartphone on the N marked part of the headset.

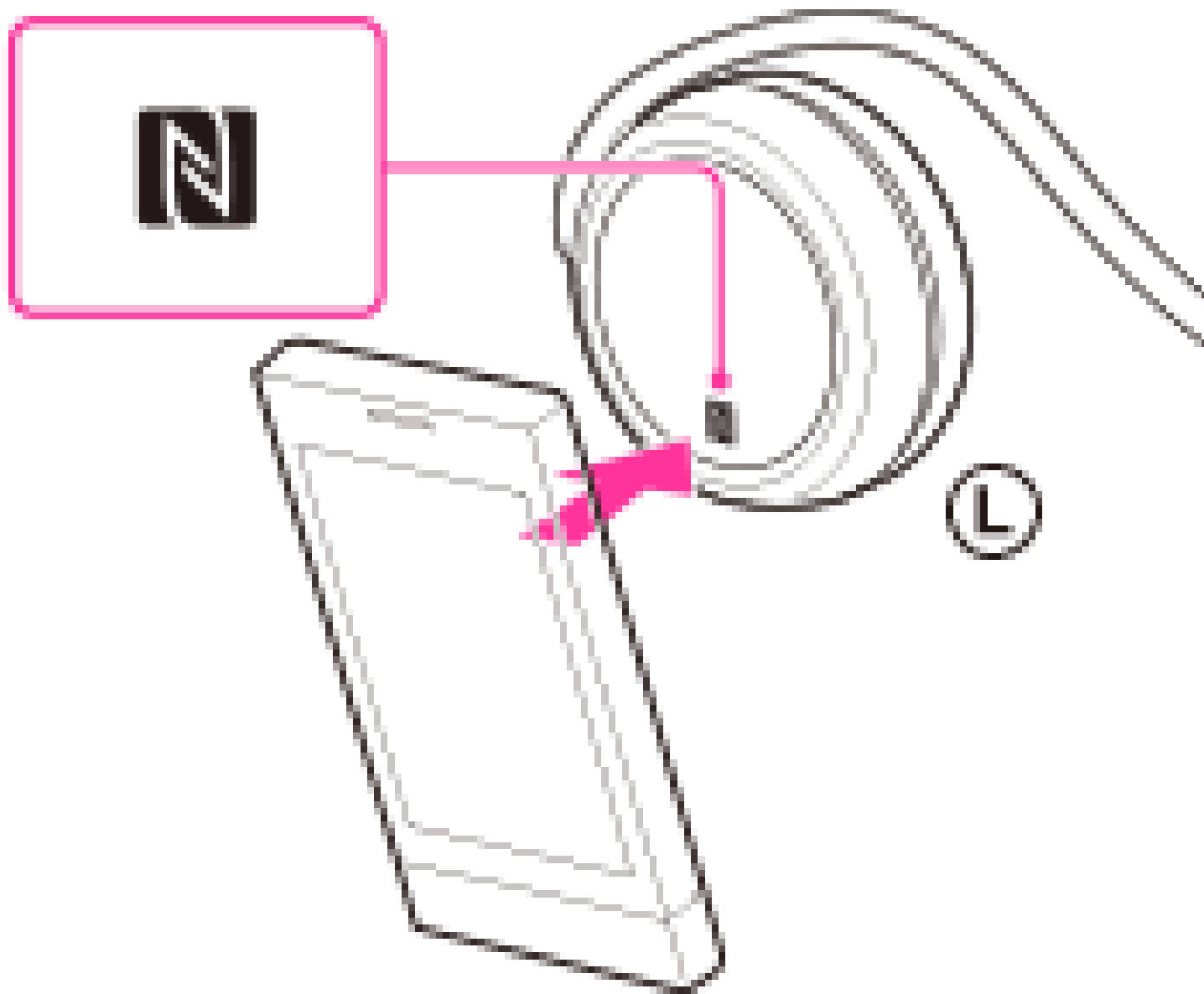

Note

- Even if you disconnect the headset from the smartphone, the headset is not turned off. To turn off the headset, press and hold the  POWER button for about 2 seconds. The indicator (blue) goes off and the headset turns off.

→ [Switching the device by one-touch functions](#)



Switching the device by one-touch functions

- When the headset is connected with a BLUETOOTH device, if you touch an NFC compatible smartphone on the headset, the headset is connected with the smartphone that touched on the headset most recently.
- If you touch the smartphone that is connected with the headset on another NFC compatible BLUETOOTH headset or BLUETOOTH speaker, the smartphone is disconnected from the headset, and connected with the BLUETOOTH device touched.

Note

- Unlock the screen of the smartphone beforehand. If you installed the “NFC Easy Connect” App in the smartphone, start the “NFC Easy Connect” App.



Listening to music



You can enjoy listening to music and basic remote control operation of a BLUETOOTH device via a BLUETOOTH connection. The BLUETOOTH device is required to support the following BLUETOOTH profiles.

- A2DP (Advanced Audio Distribution Profile): enables you to enjoy high-quality audio content wirelessly.
- AVRCP (Audio Video Remote Control Profile): enables you to enjoy basic remote control operation (play, stop, etc.) of a BLUETOOTH device.

The headset supports SCMS-T content protection. You can enjoy music, etc., from a device such as a mobile phone or portable TV that supports SCMS-T content protection.

The operation may vary depending on the BLUETOOTH device. Refer to the manual supplied with your BLUETOOTH device.

1. Connect the headset with a BLUETOOTH device.
2. Wear the headset.

Put the headset with  indication on your left ear and  indication on your right ear.

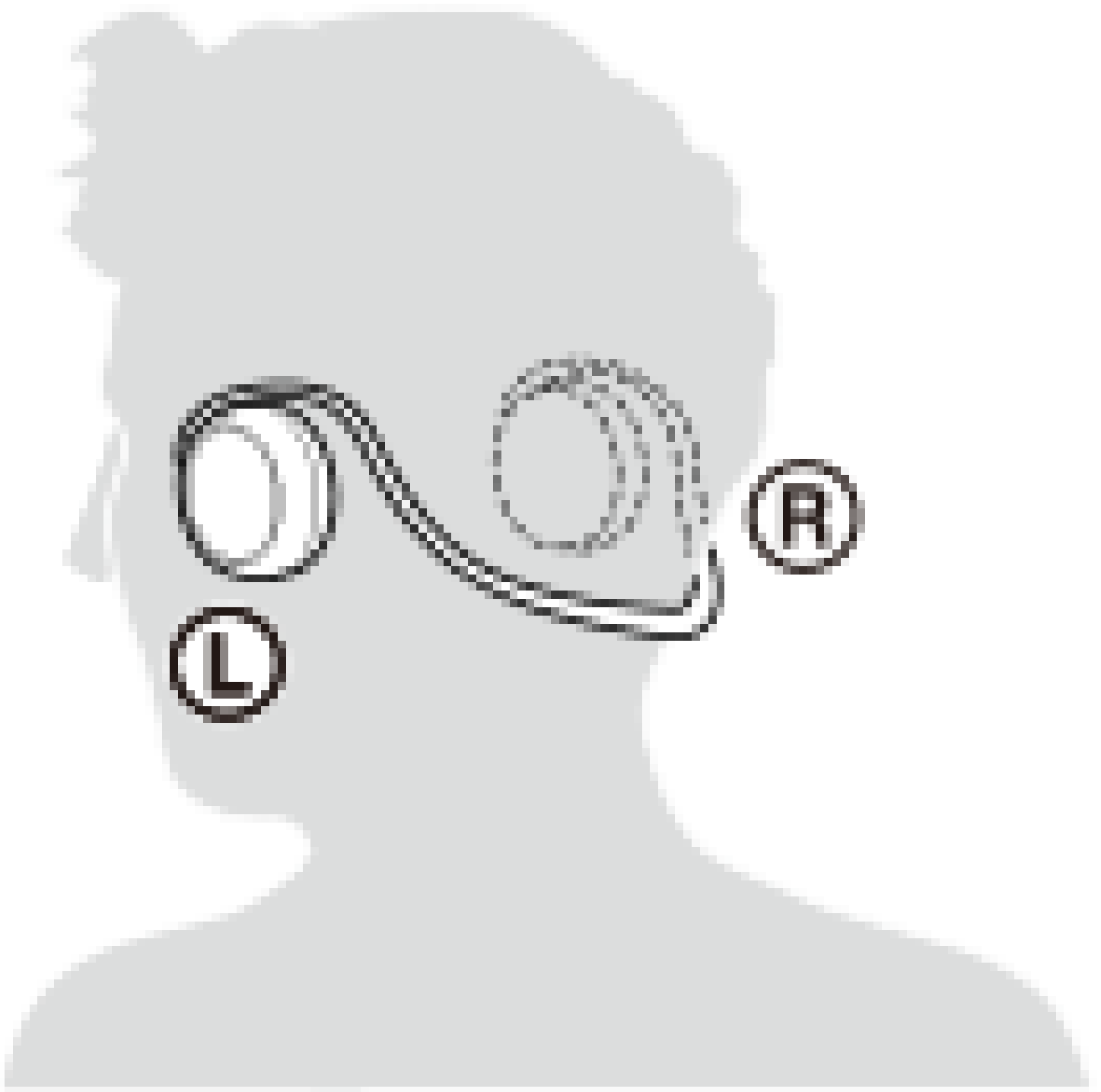

3. Play back music or video on the BLUETOOTH device.

Tip

- Depending on the BLUETOOTH device, it may be necessary to adjust the volume or set the audio output setting on the connected device.

After use

1. Terminate the BLUETOOTH connection by operating the BLUETOOTH device.

2. Press and hold the  POWER button for about 2 seconds.
The indicator (blue) goes off and the headset turns off.

Tip

- When you finish playing music, the BLUETOOTH connection may terminate automatically, depending on the BLUETOOTH device.

Related topic

[Pairing and connecting with an Android smartphone](#)

[Pairing and connecting with an iPhone](#)

[Pairing and connecting with other BLUETOOTH devices](#)

→ [Controlling the audio device](#)

Copyright 2013 Sony Corporation

Controlling the audio device

If the BLUETOOTH device supports AVRCP, you can control it by the buttons on the headset. The functions available may vary depending on the BLUETOOTH device. Refer to the manual supplied with your BLUETOOTH device.

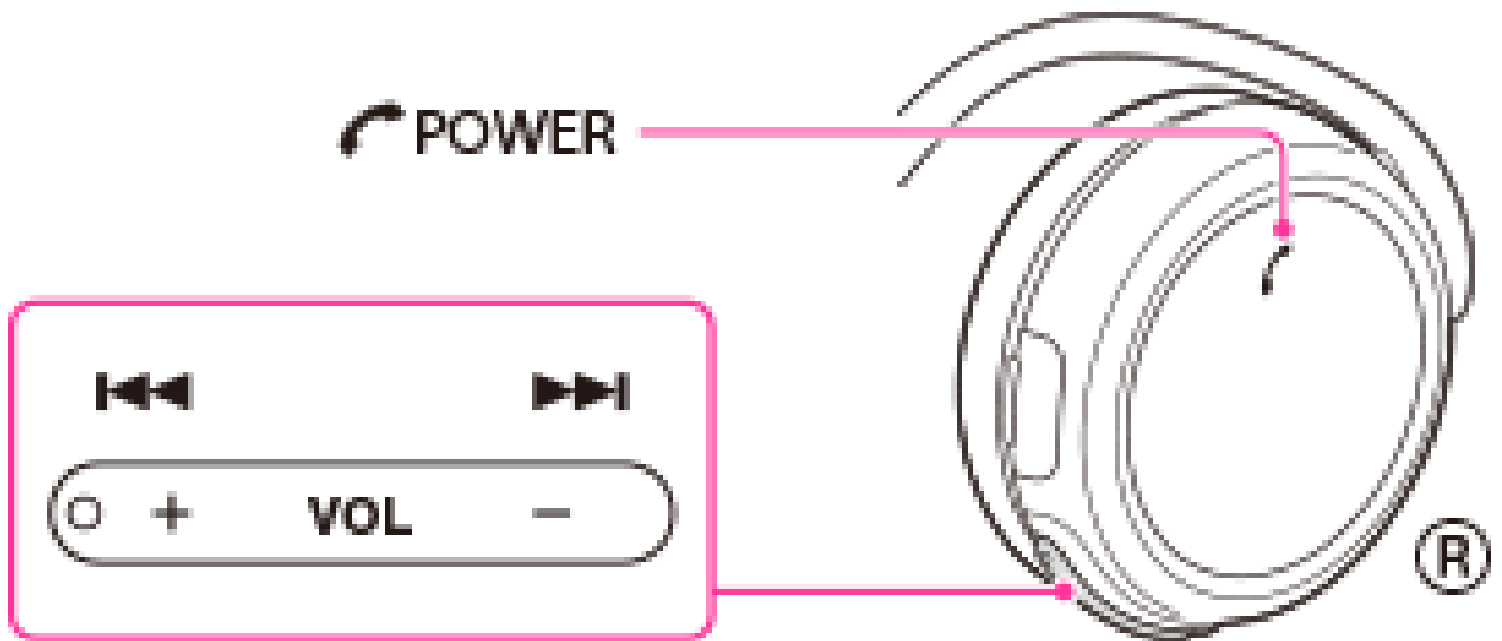

To play/pause

Press the POWER button.

To adjust the volume

Press the VOL +/- () button.

To skip to the next/previous song

Press and hold the VOL +/- () button. Release it when a beep sounds.

To fast-forward/fast-reverse

Press and hold the VOL +/- () button.

Note

- If the communication condition is poor, the BLUETOOTH device may react incorrectly to the operation on the headset.

→ [Selecting the sound quality mode of music playback](#)

Copyright 2013 Sony Corporation



Selecting the sound quality mode of music playback

The sound quality is set to the “Standard” mode (SBC high quality mode) as the default setting.

- When using an AAC compatible device, select the “Priority on sound quality” mode.
- If the connection is unstable, such as when producing only intermittent sound, select the “Priority on stable connection” mode.

Sound quality and the indicator (blue) of each mode

When the sound quality mode is switched, the headset indicates the remaining battery capacity by flashing the indicator in red first, and then in blue to indicate the sound quality mode. You can check the current sound quality mode by the number of flashes of the indicator (blue).

Mode	Sound quality	Number of flashes (blue)
Priority on sound quality	SBC (high quality) or AAC selected automatically	3 times
Standard	SBC (high quality)	Twice
Priority on stable connection	SBC	Once

Note

- When you turn on the headset by pressing the  POWER button only, the headset does not indicate the sound quality mode with flashes of the indicator

(blue).

Selecting the sound quality mode

Turn on the headset by pressing the  POWER button for more than 2 seconds while holding the VOL + or VOL – button down.

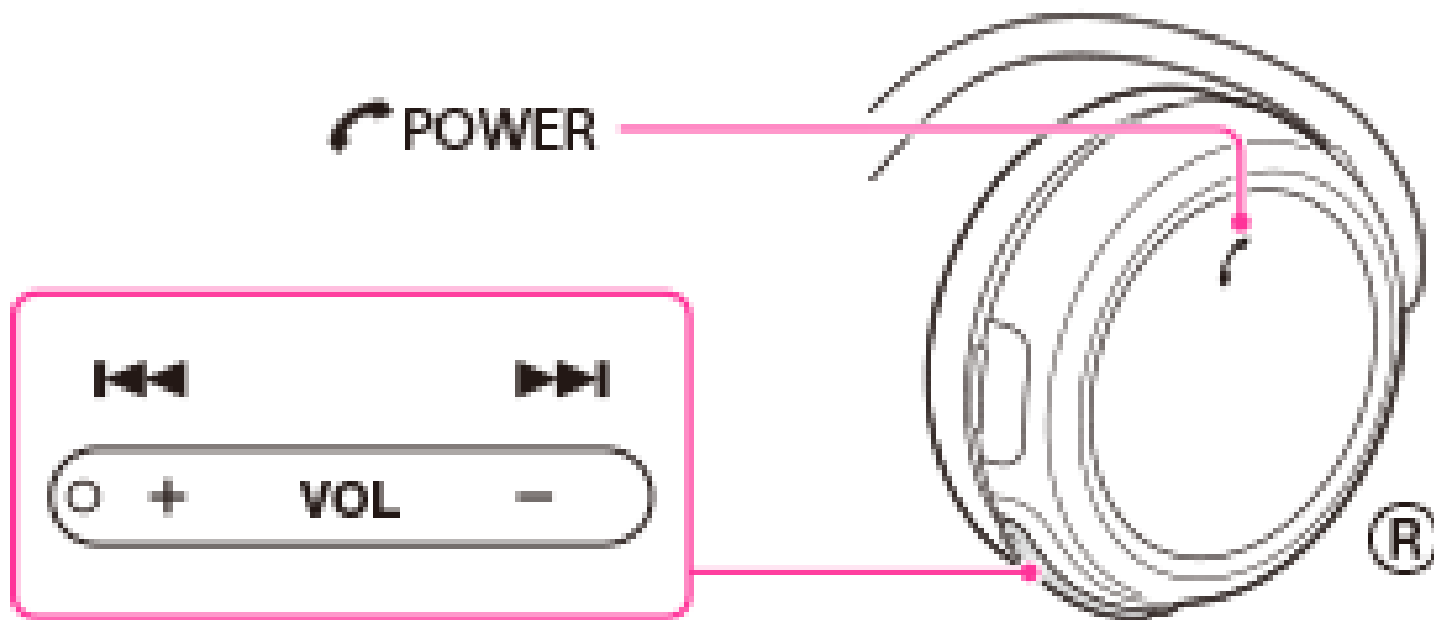

To select the “Priority on sound quality” mode

When the headset is in the “Standard” mode, turn it on while holding the VOL + button down. The “Priority on sound quality” mode is selected.

From the “Priority on stable connection” mode, turn on the headset while holding the VOL + button down. Turn off the headset once, then turn it on while holding the VOL + button down again.

To select the “Priority on stable connection” mode

When the headset is in the “Standard” mode, turn it on while holding the VOL – button down. The “Priority on stable connection” mode is selected.

From the “Priority on sound quality” mode, turn on the headset while holding the VOL – button down. Turn off the headset once, then turn it on while holding the VOL – button down again.

Notes

- The playback time may become shorter, depending on the sound quality and the conditions under which you are using the headset.

- Depending on the ambient conditions in the area where you are using the headset, intermittent sound may still occur, even if the “Priority on stable connection” mode is selected.
-

Copyright 2013 Sony Corporation



Making a call

You can enjoy a hands-free call with a BLUETOOTH smartphone or mobile phone that supports the BLUETOOTH profile HFP (Hands-free Profile) or HSP (Headset Profile), via a BLUETOOTH connection.

If your BLUETOOTH smartphone or mobile phone supports both HFP and HSP, set it to HFP.

1. Connect the headset with a BLUETOOTH smartphone or mobile phone.
2. Use the buttons on your smartphone or mobile phone when making a call.
If no dial tone is heard via the headset, switch the call device to the headset using your smartphone or mobile phone. With an HFP connection, you can do this by pressing the  POWER button on the headset for about 2 seconds. Refer to the manual supplied with your smartphone or mobile phone for the details of the operation.

 POWER

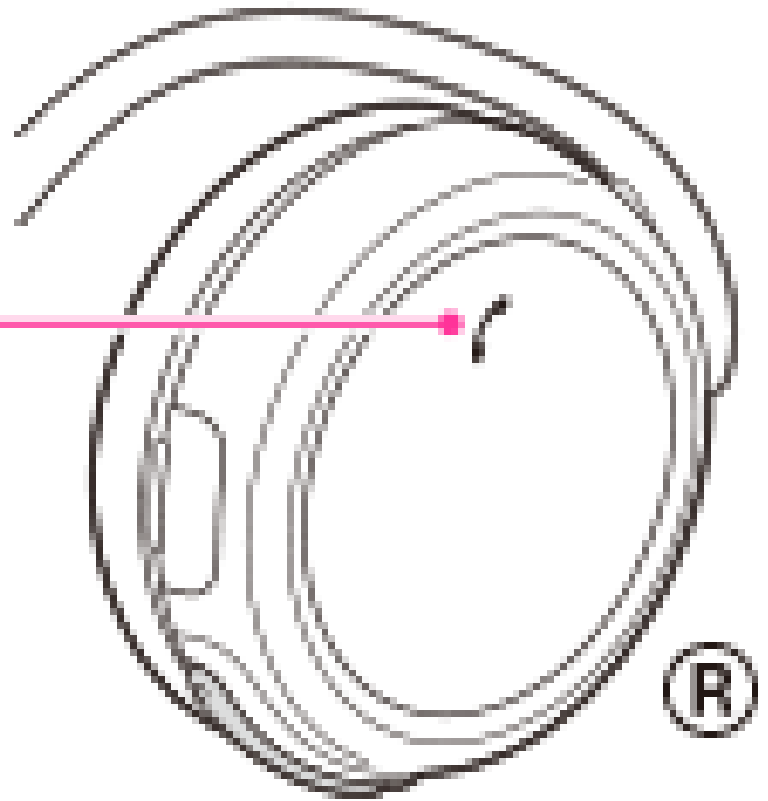

To adjust the volume
Press the VOL +/- button.

Tips

- You cannot adjust the volume when not talking.
- Volume for a call and listening to music can be adjusted independently. Even if you change the volume while playing back the music, the volume of a call does not change.

To end a call
Press the  POWER button on the headset.

After use

1. Disconnect the BLUETOOTH connection using the smartphone or mobile phone.
2. Press and hold the  POWER button on the headset for about 2 seconds. The indicator (blue) goes off, and the headset turns off.

Related topic

[Pairing and connecting with an Android smartphone](#)

[Pairing and connecting with an iPhone](#)

[Pairing and connecting with other BLUETOOTH devices](#)

→ [Receiving a call](#)

Copyright 2013 Sony Corporation



Receiving a call

1. Connect the headset with a BLUETOOTH device in advance.
2. When there was a call, press the  POWER button on the headset and receive the call.

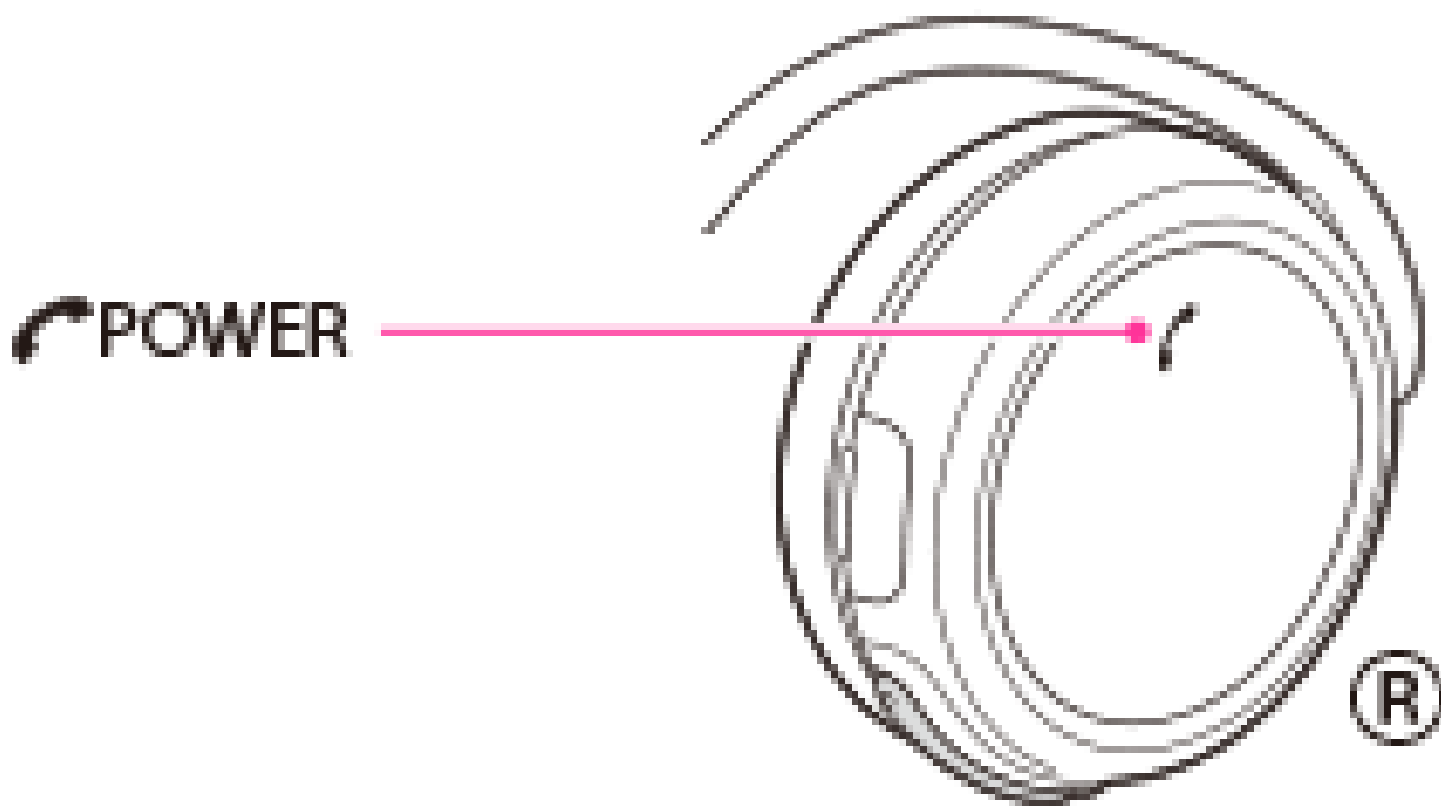

Receive a call in the same way when a call arrives while you are listening to music.

The music stops while you are talking, and resumes automatically when you end the call.

The ring tone differs in the following ways, depending on your smartphone or

mobile phone.

- ring tone set on the headset
- ring tone set on the smartphone or mobile phone
- ring tone set on the smartphone or mobile phone only for a BLUETOOTH connection

Note

- If you received a call using your smartphone or mobile phone, some smartphones or mobile phones may have handset use priority. In the case of the HFP connection, talk on the headset by pressing the  POWER button on the headset for about 2 seconds, or using your smartphone or mobile phone. For details, refer to the manual supplied with your smartphone or mobile phone.

To adjust the volume

Press the VOL +/- button.

Tips

- You cannot adjust the volume when not talking.
- Volume for a call and listening to music can be adjusted independently. Even if you change the volume while playing back the music, the volume of a call does not change.

To end a call

Press the  POWER button on the headset.

After use

1. Disconnect the BLUETOOTH connection using the smartphone or mobile phone.
2. Press and hold the  POWER button on the headset for about 2 seconds. The indicator (blue) goes off, and the headset turns off.

→ [Controlling the smartphone or mobile phone](#)



Controlling the smartphone or mobile phone

The function available may vary depending on the profile supported by your BLUETOOTH smartphone or mobile phone. Even if the phone has the same profile, functions may vary depending on the specifications. Refer to the manual supplied with your smartphone or mobile phone.

Supported profile: HFP

Status	POWER button
Outgoing call	<ul style="list-style-type: none"> • Press once to cancel outgoing call. • Press for about 2 seconds to change call device between the headset and the smartphone or mobile phone.
Incoming call	<ul style="list-style-type: none"> • Press once to answer call. • Press for about 2 seconds to reject call.
During call	<ul style="list-style-type: none"> • Press once to finish call. • Press for about 2 seconds to change call device between the headset and the smartphone or mobile phone.

Supported profile: HSP

Status	POWER button
Outgoing call	<ul style="list-style-type: none"> • Press once to cancel outgoing call.
Incoming call	<ul style="list-style-type: none"> • Press once to answer call.
During call	<ul style="list-style-type: none"> • Press once to finish call.

Copyright 2013 Sony Corporation



Connecting the headset with a music player and a smartphone (mobile phone)

To call using a BLUETOOTH smartphone or mobile phone while listening to music played on another BLUETOOTH compatible music player, the headset needs to be connected with each device with a BLUETOOTH connection.

1. Pair the headset with a BLUETOOTH music player and a smartphone (mobile phone), respectively.
2. Make an A2DP BLUETOOTH connection between the headset and the BLUETOOTH music player.
3. Make an HFP or HSP BLUETOOTH connection between the headset and the BLUETOOTH smartphone or mobile phone.

Note

- If you have previously connected this BLUETOOTH device, an HFP or HSP connection is made automatically when you turn on the headset. At the same time, an A2DP connection may also be made automatically. If this happens, disconnect the headset from the smartphone or mobile phone once using the phone, then connect the devices again by repeating the process from step 2.

To call during playback

Make a phone call by operating the smartphone or mobile phone.

If no dial tone is heard via the headset, switch the call device to the headset using your smartphone or mobile phone. With an HFP connection, you can do this by pressing the  POWER button on the headset for about 2 seconds.

To receive a call

When an incoming call arrives, the music playback pauses, and a ring tone is heard via the headset.

Press the  POWER button on the headset and talk using the microphone.

To end a call, press the  POWER button on the headset to switch back to music playback.

Note

- When no ring tone is heard even if an incoming call arrives, stop music playback. When ringing, press the  POWER button and talk.

To disconnect the call

Press the  POWER button on the headset to switch back to music playback.

Related topic

[Pairing and connecting with an Android smartphone](#)

[Pairing and connecting with an iPhone](#)

[Pairing and connecting with other BLUETOOTH devices](#)

[Connecting with a smartphone by one-touch functions](#)

→ [Connecting the headset with 2 Android smartphones](#)

Copyright 2013 Sony Corporation



Connecting the headset with 2 Android smartphones

When you connect the headset with a smartphone, usually the music playback function and the phone call function are both connected automatically. To make a multi point connection with 2 smartphones separately, one for listening to music and the other for making phone calls, change the settings of the smartphones so that only one of the functions is connected for each smartphone.

1. Pair the headset with both smartphones, respectively.
2. Use one of the smartphones to establish a BLUETOOTH connection with the headset.
3. On the smartphone connected to the headset, uncheck either [Phone audio] (HFP) or [Media audio] (A2DP).

Example: To connect "Media audio" (A2DP) only

Touch [Settings] → [Bluetooth] → the setting icon next to [MDR-AS700BT].

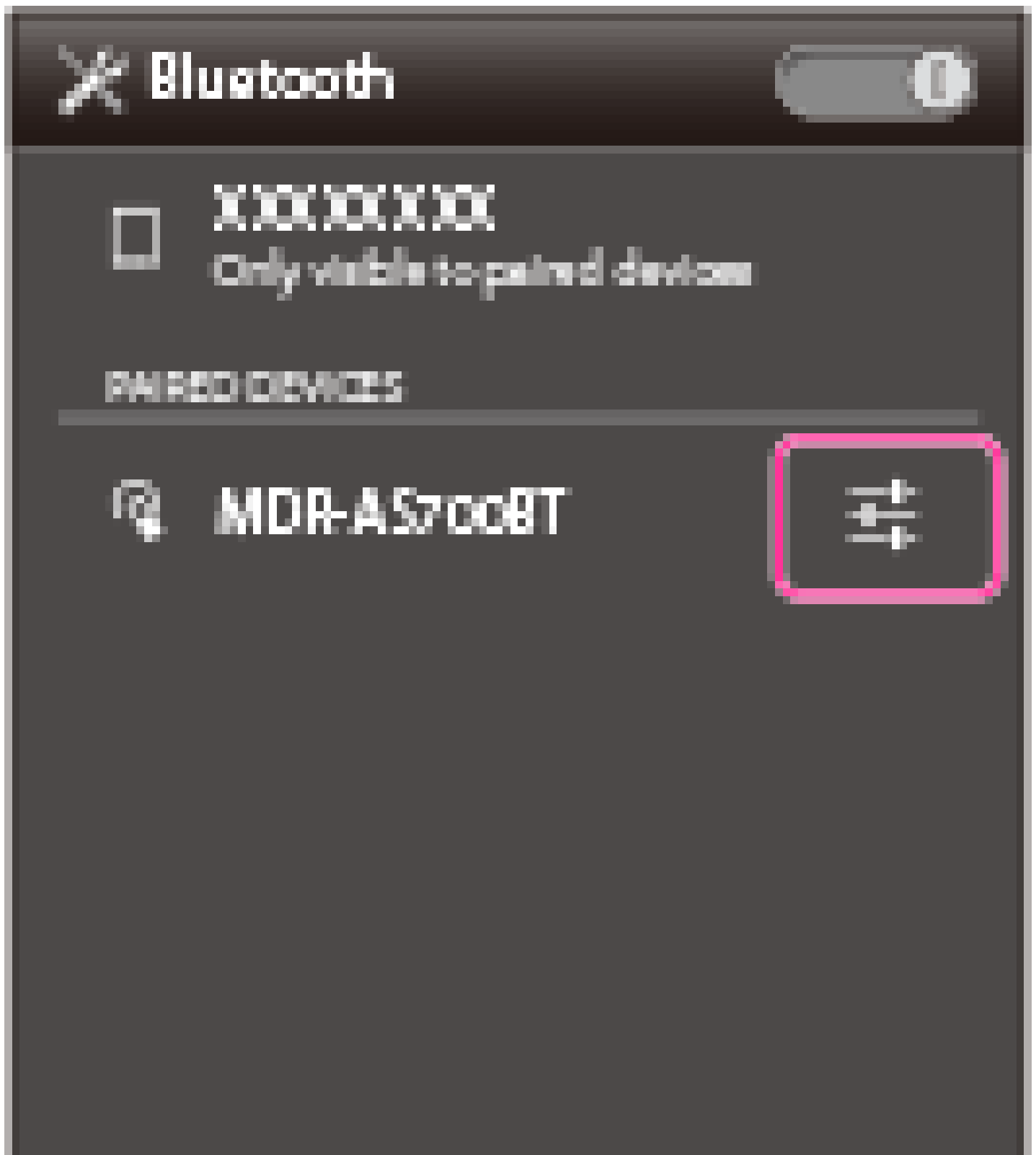

On the [Paired Bluetooth device] screen, uncheck [Phone audio].

Paired Bluetooth device

Pair name

HD4A2700 BT

Unpair

PROFILES



Phone audio

Use for phone audio



Media audio

Use for media audio



4. Terminate the BLUETOOTH connection of the smartphone.
5. Use the other smartphone to establish a BLUETOOTH connection with the headset.
6. In the same way, uncheck the function that you did not uncheck in step 3.

7. Use the first smartphone to establish a BLUETOOTH connection again.
Both smartphones are connected with the headset with only one function enabled.

To call during playback

Make a phone call using the smartphone designated for making a phone call.

If no dial tone is heard via the headset, switch the call device to the headset using your smartphone or mobile phone. With an HFP connection, you can do this by pressing the  POWER button on the headset for about 2 seconds.

To receive a call

When an incoming call arrives, the music playback pauses, and a ring tone is heard via the headset.

Press the  POWER button on the headset and talk using the microphone.

To end a call, press the  POWER button on the headset to switch back to music playback.

Note

- When no ring tone is heard even if an incoming call arrives, stop music playback. When ringing, press the  POWER button and talk.

To disconnect the call

Press the  POWER button on the headset to switch back to music playback.

Related topic

[Pairing and connecting with an Android smartphone](#)

[Pairing and connecting with an iPhone](#)

[Connecting with a smartphone by one-touch functions](#)

→ [Connecting the headset with an Android smartphone and an iPhone](#)



Connecting the headset with an Android smartphone and an iPhone

When you connect the headset with a smartphone, usually the music playback function and the phone call function are both connected automatically. To make a multi point connection using an Android smartphone and an iPhone separately for listening to music and making phone calls, change the settings on the Android smartphone so that only one of the functions is connected. Connect the Android smartphone first, and then connect the iPhone.

You cannot set the iPhone to connect one function only.

1. Pair the headset with both smartphones, respectively.
2. Use the Android smartphone to establish a BLUETOOTH connection with the headset.
3. On the smartphone connected to the headset, uncheck either [Phone audio] (HFP) or [Media audio] (A2DP).

Example: To connect “Media audio” (A2DP) only

Touch [Settings] → [Bluetooth] → the setting icon next to [MDR-AS700BT].

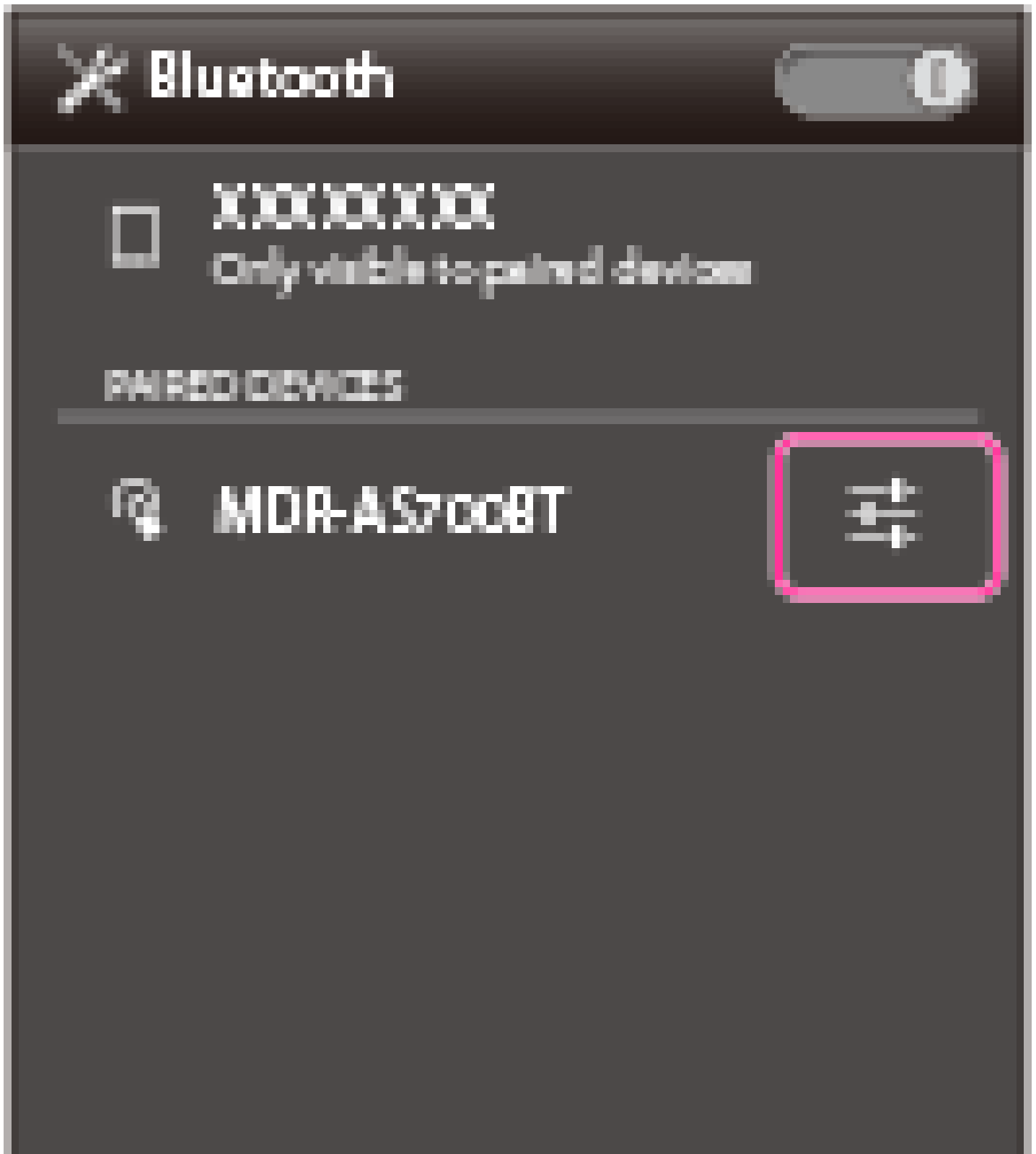

On the [Paired Bluetooth device] screen, uncheck [Phone audio].

Paired Bluetooth device

Pair name

HD4.42700 BT

Unpair

PROFILES



Phone audio

Use for phone audio



Media audio

Use for media audio



- Use the iPhone to establish a BLUETOOTH connection with the headset. The iPhone is connected with the headset with both functions, but you can only use the function that you did not uncheck in step 3.

To call during playback

Make a phone call using the smartphone designated for making a phone call.

If no dial tone is heard via the headset, switch the call device to the headset using your smartphone or mobile phone. With an HFP connection, you can do this by pressing the  POWER button on the headset for about 2 seconds.

To receive a call

When an incoming call arrives, the music playback pauses, and a ring tone is heard via the headset.

Press the  POWER button on the headset and talk using the microphone.

To end a call, press the  POWER button on the headset to switch back to music playback.

Note

- When no ring tone is heard even if an incoming call arrives, stop music playback. When ringing, press the  POWER button and talk.

To disconnect the call

Press the  POWER button on the headset to switch back to music playback.

Related topic

[Pairing and connecting with an Android smartphone](#)

[Pairing and connecting with an iPhone](#)

[Connecting with a smartphone by one-touch functions](#)

Copyright 2013 Sony Corporation



What can I do to solve a problem?

If the headset does not function as expected, try the following steps to resolve the issue.



1. Find the symptoms of the issue in this manual, and try any corrective actions listed. [\[Details\]](#)
2. Connect the headset to your computer to charge the battery. [\[Details\]](#)
You may be able to resolve some issues by charging the battery.
3. Reset the headset.
4. Initialize the headset.
This operation resets volume setting, etc. and deletes all pairing information.
5. Look up information on the issue on the customer support Web site.
<http://www.sony.net/>
6. If the approaches listed above fail to resolve the issue, consult your nearest Sony dealer.

Resetting the headset

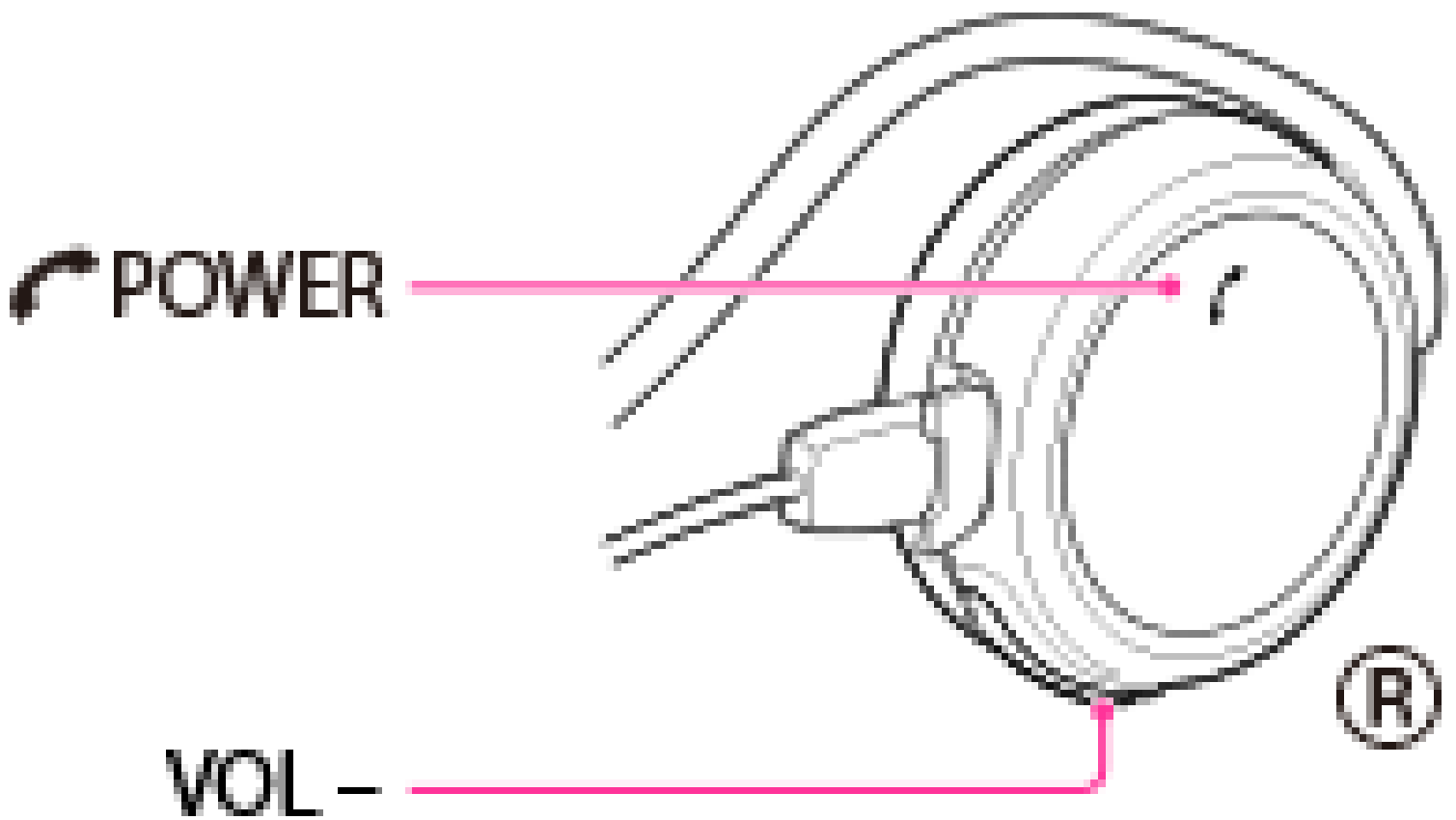
Set the headset in charging status, then press the  POWER and VOL – buttons simultaneously. The unit will be reset. Pairing information is not deleted.



Initializing the headset

1. Press and hold the  POWER button for about 2 seconds to turn off the headset.
2. Press and hold the  POWER button for about 15 seconds.
The indicator (blue) flashes 4 times, and the headset is reset to the default setting. All pairing information is deleted.

→ [Table of contents for symptoms and possible causes](#)

Copyright 2013 Sony Corporation



Table of contents for symptoms and possible causes

The following topics show possible causes and remedies for symptoms. See an appropriate topic according to your problem.

- [Power and charging](#)
- [BLUETOOTH connection](#)
- [One-touch connection \(NFC\)](#)
- [Music](#)
- [Phone calls](#)

→ [Power and charging](#)

Copyright 2013 Sony Corporation



Power and charging

- The headset is not turned on.
 - Charge the battery of the headset.
 - The headset cannot be turned on while charging the battery. Remove the micro-USB cable from the headset, and then turn on the headset again.
- Charging cannot be done.
 - Check that you are using the micro-USB cable supplied.
 - Check that the micro-USB cable is connected to the headset and the computer firmly.
 - Check that the computer is turned on.
 - Check that the computer is not in standby, sleep or hibernation mode.
- Charging time is too long.
 - Check that the headset and the computer are directly connected, not via a USB hub.
- The headset cannot be recognized by a computer.
 - The micro-USB cable is not connected properly to the USB port of the computer. Connect the micro-USB cable again.
 - Check that the headset and the computer are directly connected, not via a USB hub.
 - A problem may have occurred with the connected USB port of the computer. Connect to another USB port if it is available.
 - Try the USB connection procedure again in cases other than those stated above.

→ [BLUETOOTH connection](#)

Copyright 2013 Sony Corporation





BLUETOOTH connection

- Pairing cannot be done.
 - Bring the headset and the BLUETOOTH device closer together.
- Cannot make a BLUETOOTH connection.
 - Check that the headset is turned on.
 - Check that the BLUETOOTH device is turned on and the BLUETOOTH function is on.
 - Connection with the BLUETOOTH device may not be memorized on the headset. Make a BLUETOOTH connection from the BLUETOOTH device to the headset soon after pairing is complete.
 - The headset or the BLUETOOTH device is in sleep mode.
 - The BLUETOOTH connection is terminated. Make the BLUETOOTH connection again.
- Distorted sound
 - Make sure that the headset is not receiving interference from a wireless LAN, other 2.4 GHz wireless device, or microwave oven.
- The correspondence distance is short. (Sound skips.)
 - If a device that generates electromagnetic radiation, such as a wireless LAN, other BLUETOOTH device(s), or a microwave oven is nearby, move the headset away from such sources.
 - Point the antenna of the headset towards the BLUETOOTH device. Make sure no obstacles blocks the communication.
- The headset does not operate properly.
 - Reset the headset. Pairing information is not deleted by this operation.

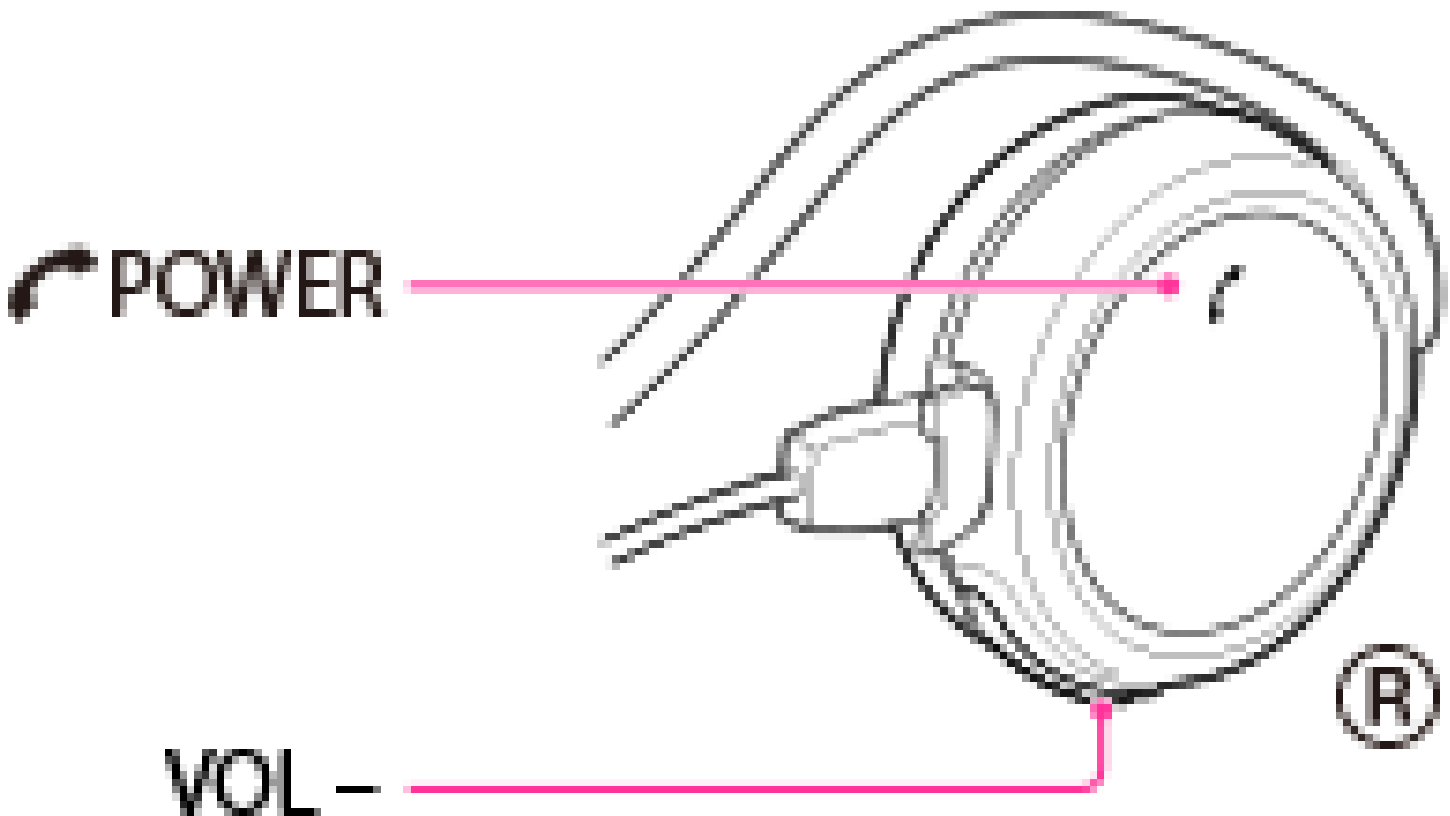
Set the headset in charging status, then press the  POWER and VOL – buttons simultaneously.



- If you cannot use the headset even after resetting it, initialize the headset.
 - ① Press and hold the  POWER button for about 2 seconds to turn off the headset.
 - ② Press and hold the  POWER button for about 15 seconds. The indicator (blue) flashes 4 times, and the headset is reset to the default setting. All pairing information is deleted.

→ [One-touch connection \(NFC\)](#)



One-touch connection (NFC)

- Cannot make the one-touch connection.
 - If the smartphone is in a case, the headset may not react to the touching. Remove the smartphone from the case.
 - If the smartphone does not vibrate, start the app on the smartphone, and move the designated location of the smartphone close to the N mark on the headset.
 - Depending on the smartphone or mobile phone you are using, the NFC sensitivity may not be strong enough to connect the headset with just one touch. In this case, follow the procedure described in “[Pairing and connecting with an Android smartphone.](#)”
 - You cannot make a one-touch connection while charging the battery because the headset cannot be turned on. Finish charging first, and then make the one-touch connection.

→ [Music](#)



Music

- No sound
 - Check that both the headset and the BLUETOOTH device are turned on.
 - An A2DP BLUETOOTH connection is not made between the headset and the BLUETOOTH device. Use the BLUETOOTH device and make an A2DP BLUETOOTH connection.
 - Check that music is being played back by the BLUETOOTH device.
 - Check that the volume of the headset is not set too low.
 - Turn up the volume on the connected device if necessary.
 - Pair the headset and the BLUETOOTH device again.
- Low sound level
 - Turn up the volume of the headset.
 - Turn up the volume on the connected device if necessary.
- Low sound quality
 - Use the BLUETOOTH device and switch the BLUETOOTH connection to A2DP (Advanced Audio Distribution Profile) when HFP (Hands-free Profile) or HSP (Headset Profile) is set.
 - If you have previously connected this BLUETOOTH device, only an HFP/HSP BLUETOOTH connection may be made when the headset is turned on. If this happens, use the BLUETOOTH device and make an A2DP BLUETOOTH connection.
- Sound skips frequently during playback.
 - Set the headset to the “Priority on stable connection” mode.
For details, refer to “[Selecting the sound quality mode of music playback.](#)”

→ Phone calls

Copyright 2013 Sony Corporation



Phone calls

- The caller's voice cannot be heard.
 - Check that both the headset and the BLUETOOTH smartphone or mobile phone are turned on.
 - Check the connection between the headset and the BLUETOOTH smartphone or mobile phone. Use the smartphone or mobile phone and make a BLUETOOTH connection (HFP or HSP) again.
 - Check that output of the BLUETOOTH smartphone or mobile phone is set for the headset.
 - Check that the volume of the headset is not set too low.
 - Turn up the volume on the BLUETOOTH smartphone or mobile phone if necessary.
 - If you are listening to music using the headset, stop playback, press the  POWER button and talk.
 - Low sound from the caller
 - Turn up the volume of the headset.
 - Turn up the volume on the BLUETOOTH smartphone or mobile phone if necessary.
-



License and trademark notice

- The BLUETOOTH word mark and logos are owned by the Bluetooth SIG, Inc. and any use of such marks by Sony Corporation is under license.
 - The N Mark is a trademark or registered trademark of NFC Forum, Inc. in the United States and in other countries.
 - Android is a trademark of Google Inc.
 - iPhone is a trademark of Apple Inc., registered in the U.S. and other countries.
 - Microsoft, Windows and Windows Vista are registered trademarks or trademarks of Microsoft Corporation in the United States and/or other countries.
 - Macintosh and Mac OS are trademarks of Apple Inc., registered in the U.S. and other countries.
 - Other trademarks and trade names are those of their respective owners.
-

Copyright 2013 Sony Corporation

Free Manuals Download Website

<http://myh66.com>

<http://usermanuals.us>

<http://www.somanuals.com>

<http://www.4manuals.cc>

<http://www.manual-lib.com>

<http://www.404manual.com>

<http://www.luxmanual.com>

<http://aubethermostatmanual.com>

Golf course search by state

<http://golfingnear.com>

Email search by domain

<http://emailbydomain.com>

Auto manuals search

<http://auto.somanuals.com>

TV manuals search

<http://tv.somanuals.com>