

# Singer 96-60

Form 18889  
JULY, 1935  
PRINTED IN U. S. A.

# LIST OF PARTS



**MACHINE No. 96-60**

---

**THE SINGER MANUFACTURING COMPANY**

## INSTRUCTIONS FOR OILING

Oil should be applied at the places indicated by the word "OIL" and when the machine is in continuous use it should be oiled at least four times each day. All wicking must be kept saturated with oil.

Use Only Singer "Manufacturing Sewing Machine Oil (Cloth and Leather)" for general use or "Manufacturing Sewing Machine Oil (Stainless for White Goods)" where a stainless oil is desired.

Copyright, U. S. A., 1917, 1921, 1922, 1933, 1934 and 1935  
by The Singer Manufacturing Co.  
All Rights Reserved for all Countries

Genuine Singer Needles should be used  
in Singer Machines.  
These Needles and their Containers  
are marked with the  
Company's Trade Mark "SIMANCO." 1

Needles in Containers marked  
"For Singer Machines"  
are not Singer made needles. 2

## I N D E X

	Page
Accessories.....	15
Bobbin Winders.....	15
Foot Lifter Parts.....	18
Knee Lifter Parts.....	19
Machine Base.....	15
Machine No. 96-60.....	7
Numerical List of Parts.....	21
Thread Unwinder.....	19

### INSTRUCTIONS FOR ORDERING

In ordering from this list, use ONLY the part NUMBER in the FIRST column.

The number stamped on a Sewing Machine Part is in every case the number of the single part only.

Every combination of parts sent out as such has its specific number, which, although not stamped on the parts, must be used when ordering the combination.

Each number always indicates the SAME PART in whatever list it appears, or for whatever machine.

The letters after some of the numbers indicate the style of finish only, as follows:

- A-Hardened, Polished, Nickel Plated and Buffed
- B-Polished, Nickel Plated and Buffed
- C-Hardened Only
- D-Polished Only
- E-Soft, Not Polished
- F-Hardened and Polished
- H-Blued
- J-Nickel Plated Only
- K-Hardened and Nickel Plated
- L-Brass Plated
- M-Oxidized
- N-Japanned, Dull
- P-Japanned, Bright
- R-Merlized
- T-Copper Plated
- T.A-Hardened, Polished, Copper and Nickel Plated and Buffed
- T.B-Copper and Nickel Plated and Polished
- T.J-Copper and Nickel Plated Only
- T.K-Hardened, Copper and Nickel Plated
- T.M-Copper Plated and Oxidized
- T.L-Copper and Brass Plated
- U-Zinc Plated
- V-Silver Plated
- W-Polished and Nickel Plated
- Y-Black Nickel Plated Only
- Z-Chromium Plated
- Z.B-Polished, Nickel Plated, Buffed and Chromium Plated
- Z.J-Nickel and Chromium Plated

These letters MUST BE USED when they appear in the list; and AFTER the number as in the list.

In this series:

- 1 to 1500 and 50001 to 51500 are Screw Numbers
- 1501 to 1800 and 51501 to 51800 are Nut Numbers
- 1801 to 2000 and 51801 to 52000 are Roller Numbers
- 2001 to 50000 and 52001 to 190000 are Sewing Machine Parts, 190001 and upward are numbers of Electrical Parts.

The figures in the second column refer only to the plates, illustrating the parts, and are NOT TO BE USED in ordering.

Parts marked with an asterisk (\*) are furnished only when repairs are made at factory.

### LIST OF PARTS COMPLETE FOR

7

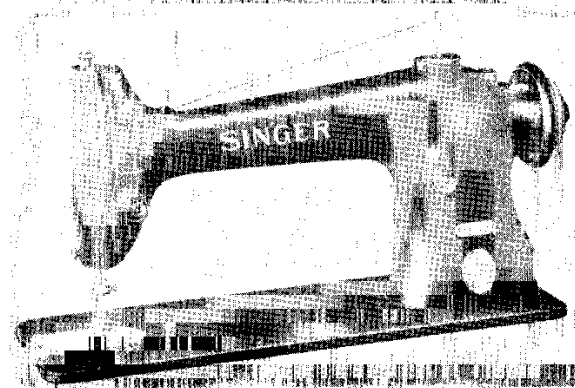

MACHINE NO. 98-60

FOR COATS, CLOTHING AND OTHER WORK IN CLOTH. MAXIMUM STITCH 5 1/2 TO THE INCH. DROP FEED. THE MACHINE IS FITTED WITH HEAVY GEAR SHAFTS, AND BALL BEARINGS FOR THE ARM SHAFT. THE GEARS ARE LUBRICATED WITH OIL INSTEAD OF GREASE. SPEED UP TO 4000.

No.	Plate	Name
*127218	----	Arm, with 15404 and two each 15405 and 56015.....
Note: Due to the accuracy required for gear alignment, arm cannot be supplied separately and can only be sent out as a unit, Arm and Bed assembled.		
16532	21801	Arm Dowel Pin.....
52182	21801	" Oil Tube with 52184, for oiling 52205.
52183	21801	" " " " 52184, for oiling 52024.
52180	21801	" " " (long) with 52184, for oiling 127182.....
52185	21801	Arm Oil Tube (short) with 42367, for oiling 127182.....
52186	21801	Arm Oil Tube with 52184, for oiling 127156 for 127193 and 150480.....
127187	21801	Arm Oil Tube with 42367, for oiling 127152 for 127193 and 150480.....
52148	21801	Arm Oil Tube for 52149.....
52149	----	" " " 52148 with 52150, for oiling 127073 and 127074.....
56015	21801	Arm Oil Tube for oiling 127058.....
52184	----	" " " Packing (wick) for 52180, 52182, 52183 and 52186.....
52150	21801	Arm Oil Tube Packing (braided cotton) for 52149.....



No.	Plate	Name
1518J	5910	Feed Connecting Link Hinge Screw Nut.....
52073	5910	" " " " Stud.....
50083C	5910	" " " " Set Screw.
44136	5805	" Dog, 15 teeth (16 teeth to the inch) for 44137 and 44138.....
50117E	7722	Feed Dog Screw.....
127202	7719	" and Feed Lifting Eccentric with 448C, 1299C, 52210 and 52211.....
52210	7723	Feed and Feed Lifting Eccentric Lubricat- ing Pad (wood) long.....
52211	7723	Feed and Feed Lifting Eccentric Lubricat- ing Pad (wood) short.....
1299C	21809	Feed and Feed Lifting Eccentric Position Screw.....
448C	7722	Feed and Feed Lifting Eccentric Set Screw.
127152	7719	" " " " Sleeve....
20284	7721	" Forked Connection.....
*52393	-----	" " " " 20284 with 375C, 1518E and 52165.....
375C	5910	Feed Forked Connection Hinge Screw.....
1518E	5910	" " " " " Nut....
52394	7724	" Lifting Rock Shaft.....
52385	-----	Feed Lifting Rock Shaft complete, Nos. 12376 and 52394.....
127156	7721	Feed Lifting Rock Shaft Connecting Rod with two 966E.....
966E	5899	Feed Lifting Rock Shaft Connecting Rod Cap Screw.....
375C	5910	Feed Lifting Rock Shaft Connecting Rod Hinge Screw.....
1518J	5910	Feed Lifting Rock Shaft Connecting Rod Hinge Screw Nut.....
12376	5910	Feed Lifting Rock Shaft Crank with 157J and 1813.....
157J	5910	Feed Lifting Rock Shaft Crank Clamping Screw.....
1813	5910	Feed Lifting Rock Shaft Crank Roller and Stud.....
50191C	5899	Feed Lifting Rock Shaft Screw Center.....
52097	-----	" " " " " 50191C with 1513J.....
1513J	7722	Feed Lifting Rock Shaft Screw Center Nut..
52074	5910	" Regulator with 50083C.....
52118	-----	" " " 52074 with 52073.....
1128E	5910	" " " Hinge Screw.....
818D	5910	" " " Thumb Screw.....
52386	7724	" Rock Shaft.....
29633	5910	" " " Crank with 157J.....
157J	5910	" " " Clamping Screw.....
52387	-----	Feed Rock Shaft complete, Nos. 29633 and 52386.....
50191C	5899	Feed Rock Shaft Screw Center.....

No.	Plate	Name
52097	-----	Feed Rock Shaft Screw Center 50191C with 1513J.....
1513J	7722	Feed Rock Shaft Screw Center Nut.....
25866	7721	Guide.....
50190J	5899	" Thumb Screw.....
127088	7721	Needle Bar (hollow).....
127116	-----	" " 127088 with 229J, 52306 and 52307.....
127188	7719	Needle Bar Bushing (lower).....
1133E	21809	" " " " Set Screw.....
52014	7721	" " " (upper).....
1133E	21809	" " " Set Screw.....
52205	21804	" " Connecting Link with 52207.....
52206	-----	" " " " 52205 with 24041.....
775E	21809	Needle Bar Connecting Link Cap Screw.....
52207	7723	" " " " Lubricating Pad (wood).....
24041	21804	Needle Bar Connecting Stud with 207E.....
207E	2834	" " " " Clamping Screw.
127198	7719	" " Crank with 1036C, 1037C and 1065C.....
127199	-----	Needle Bar Crank 127198 with 401E and 127009.....
1065C	7722	Needle Bar Crank Position Screw.....
52306	7723	" " Thread Guard.....
229J	7722	" " " Screw.....
52307	7723	" Clamp with 51460F.....
51460F	7722	" Screw.....
*52201	-----	Oil Absorbent Wick.....
52202	7721	" " " 52201 with 52203, for lower cavity in head of arm.....
*52203	-----	Oil Absorbent Wick Wire.....
127191	7723	" Tube with 52184.....
127091	7721	" " Bracket.....
127092	7721	" " " 127091 with 127191, for oiling Feed Connecting Link.....
52184	-----	Oil Tube Packing (wick).....
12391	7718	Presser Bar (hollow).....
52338	5936	" " Guide Bracket with 223C and 453C.....
453C	5936	Presser Bar Guide Bracket Set Screw.....
52016	5936	" " " Lifter.....
689C	5936	" " " Hinge Screw.....
1520J	5936	" " " " Nut.....
12327	5936	" " " Lifting and Releasing Lever Bracket.....
127108	7721	Presser Bar Spring.....
11170	5936	" " " Washer.....
7298	7723	" Foot Hinge Pin.....
19334	-----	" " Plate.....
19335	-----	" " Shank.....

## PARTS FOR MACHINE NO. 96-60

No.	Plate	Name
19336	7723	Presser Foot (hinged) complete, Nos. 7298, 19334 and 19335.....
176J	21809	Presser Foot Screw.....
688J	7722	Pressure Regulating Thumb Screw.....
127096	-----	Rotating Hook with three 1253C.....
127096	-----	" " 127095 with 127102 and four 1053D.....
*127119	-----	Rotating Hook 127096 with 40274, 127100 and three 1367D.....
127097	21808	Rotating Hook 127096 with 40274 and three 1367D (For Agents Only).....
127098	-----	Rotating Hook 127119 with 52473.....
40264	21808	" " Bobbin.....
52472	-----	" " " Case.....
52481	-----	" " " 52472 with 591F, 1380E and 40394.....
40392	21808	Rotating Hook Bobbin Case Latch.....
125320	21808	" " " " " Lever.....
2974	21808	" " " " " Fulcrum Pin.....
2975	21808	Rotating Hook Bobbin Case Latch Spring....
592E	21808	" " " " " Stop Screw
40393	-----	" " " " " Hinge, Nos. 2974, 40392 and 125320.....
591F	21808	Rotating Hook Bobbin Case Tension Regulating Screw.....
40394	21808	Rotating Hook Bobbin Case Tension Spring..
1380E	21808	" " " " " " Screw.....
52473	21808	Rotating Hook Bobbin Case complete, Nos. 592E, 2975, 40393 and 52481.....
127099	-----	Rotating Hook Bobbin Case 52473 with 127100 (For Agents Only).....
127100	21808	Rotating Hook Bobbin Case Holder with 52475 and two 52476.....
52018	21808	Rotating Hook Bobbin Case Holder Position Bracket.....
704J	21809	Rotating Hook Bobbin Case Holder Position Bracket Screw.....
*52475	-----	Rotating Hook Bobbin Case Locating Plate..
*52476	-----	" " " " " Rivet.....
40274	21808	Rotating Hook Section.....
1367D	21808	" " " " " Screw.....
1253C	21809	" " " " " Set Screw.....
127059	7724	" " " " " Shaft.....
127004	21804	" " " " " Bushing (back).....
127043	-----	" " " " " 127004 with 52045.....
52045	-----	Rotating Hook Shaft Bushing (back) Packing (wick).....
1143C	21809	Rotating Hook Shaft Bushing (back) Set Screw.....

## PARTS FOR MACHINE NO. 96-60

No.	Plate	Name
127005	21804	Rotating Hook Shaft Bushing (front).....
127044	-----	" " " " " 127005 with 52045.....
54897	21809	Rotating Hook Shaft Bushing (front) Oil Cup.....
52045	-----	Rotating Hook Shaft Bushing (front) Packing (wick).....
1148C	21809	Rotating Hook Shaft Bushing (front) Set Screw.....
127073	7719	Rotating Hook Shaft Bevel Gear with two 1259C.....
127007	7718	Rotating Hook Shaft Bevel Gear Case (two pieces) with 121E and 50234D.....
50234D	5899	Rotating Hook Shaft Bevel Gear Case Plug Screw.....
121E	5899	Rotating Hook Shaft Bevel Gear Case Screw.
1259C	21809	" " " " " Set Screw..
127102	21808	" " " " " Thread Guard.....
1053D	21809	" " " " " Screw.....
52337	5936	Slack Thread Regulator.....
223C	5936	" " " " " Set Screw.....
2102	3471	Tension Disc.....
1560C	21809	" " " " " Regulating Thumb Nut.....
32572	7723	" " " " " Releasing Disc.....
43944	5936	" " " " " Lever.....
12398	5936	" " " " " Hinge Pin.....
12329	5936	" " " " " Spring.....
32574	7723	" " " " " Pin.....
2103	5899	" " " " " Spring.....
50304C	5899	" " " " " Stud.....
52098	-----	" " " " " 50304C with 1560C.....
50305C	5899	" " " " " Set Screw.....
52397	-----	Tension complete, Nos. 2103, 32572, 32574, 52083, 52098, 52394 and two 2102.....
52027	7723	Thread Guard (side of arm).....
52454	21804	" " " " " Retainer.....
624C	21809	" " " " " Set Screw.....
127200	-----	Thread Take-up complete, Nos. 11204, 52217 and 127183.....
52216	21804	Thread Take-up Crank.....
52217	-----	" " " " " 52216 with 775E and 52206.....
1037C	21809	Thread Take-up Crank Position Screw.....
1036C	21809	" " " " " Set Screw.....
127182	7721	" " " " " Lever with 52130.....
52023	21809	" " " " " Hinge Pin.....
52024	21804	" " " " " Link.....
11204	21804	" " " " " Hinge Pin.....
435C	5899	" " " " " " " " Set Screw.....
52130	7723	Thread Take-up Lever Thread Eyelet Bushing
127183	-----	Thread Take-up Lever complete, Nos. 52023, 52024 and 127182.....



No.	Plate	Name
52394	7723	Thread Take-up Spring.....
52083	5899	" " " Regulator with 50305C.....
448C	7722	Thread Take-up Spring Regulator Set Screw.
44137	5806	Throat Plate, large needle hole, for 44138
44138	-----	" " small needle hole, for 44138
Note: Throat Plate No. 44137 is sent with this Machine unless otherwise stated on order.		
691F	7722	Throat Plate Screw.....
44212	7711	Drip Pan with four 1 in. wire nails.....
*15404	-----	Trade Mark.....
15405	-----	" " Rivet.....

Genuine Singer Needles should be used  
in Singer Machines.  
These Needles and their Containers  
are marked with the  
Company's Trade Mark "SIMANCO." 1

Needles in Containers marked  
"For Singer Machines"  
are not Singer made needles. 2

## MACHINE BASE

No.	Plate	Name
19219	7720	Bed Frame Cushion (leather).....
158C	5899	" " " Screw.....
19220	7721	" " " Spring.....
19226	7721	" " " Hinge Connection.....
19398	-----	" " " " 19226 with 211E and 19397.....
19397	7723	Bed Frame Hinge Connection Cap.....
211E	7722	" " " " " Screw.....
16555	7721	" " " " Plate.....
14010	7723	" " " " Rivet.....
20067	819	" " " with two each 16555, 19398, four each 19219, 19220, six each 14010, wood screws 1 1/4 in. No. 12 and eight 158C.

## ACCESSORIES

No.	Plate	Name
12361	7721	Machine Hinge Connection.....
44139	7721	" " " Plate.....
44140	-----	Machine Hinge complete, Nos. 12361, 44139 and merlized wood screws 1 1/4 in. No. 14.....
12405	7721	Machine Rest (felt).....
41400	6120	" " " Pin.....
120342	6120	Oiler (copper plated) with 120343.....
120343	6120	" Spout, 3 1/2 in. long.....
26026	6120	Screw Driver (large).....
26485	6120	" " (small).....
8909	6120	Wrench for 1513 and 1518.....
8908	7720	" " " 1519 and 1520.....

## BOBBIN WINDERS

BOBBIN WINDER  
(SWINGING AUTOMATIC, LEFT HAND)

No.	Plate	Name
41913	5902	Bracket with 457C.....
41583	5902	Frame with 457C.....
34105	5902	" Hinge Pin.....
457C	5899	" " " Set Screw.....
41914	5902	" Spring.....
41585	5902	Pulley with 171D.....
171D	5899	" Set Screw.....
41586	5902	Spindle.....
41587	5902	Stop Latch.....
42614	5902	" " Hinge Stud.....
457C	5899	" " " " Set Screw.....

## BOBBIN WINDER

No.	Plate	Name
7958	7723	Stop Latch Stop Pin.....
41588	5902	" " Tripping Arm with 185H.....
185H	5899	" " " Clamping Screw....
150459	7720	Tension Bracket with 460C.....
150460	7720	Tension Bracket complete, Nos.12403,41593 to 41595,52186,127187,150459 and two 2455.....
158J	5899	Tension Bracket Screw.....
12403	7719	" " Spool Pin and Thread Eye- let.....
8879	5936	Tension Bracket Spool Pin Washer (cloth)..
2455	2834	" Disc.....
41593	5936	" Spring.....
41594	5936	" Stud.....
460C	7722	" " Set Screw.....
41595	5936	" Thread Guide.....
60845	-----	Bobbin Winder, Nos.7958,34106,41583,41585 to 41588,41913,41914 and 42614.....
41915	5902	Bobbin Winder 60845 with 880E and 25446...
150461	-----	Bobbin Winder (swinging automatic, left hand) complete, Nos.41915 and 150460...
880E	5899	Bobbin Winder Screw.....
25446	7723	" " " Washer.....

BOBBIN WINDER  
(SWINGING AUTOMATIC, RIGHT HAND)

No.	Plate	Name
41339	2833	Base.....
41340	2833	Frame.....
1429D	2834	" Hinge Screw.....
41341	2833	" Spring.....
207D	2834	" " Screw.....
41342	2833	Pulley with 200F.....
200F	2834	" Set Screw.....
41343	2834	Spindle.....
27306	2834	Spool Pin.....
27307	2833	" Stand.....
27308	2833	Spool Stand complete, Nos.418E,1562J,2106, 10141,11241,27306,27307 and two each 2455 and wood screws 1 in. No. 10.....
11241	2833	Spool Washer (cloth).....
41344	2834	Stop Latch.....
41345	2834	" " Finger.....
152F	2834	" " Screw.....
1430D	2834	" " Hinge Screw.....
1550H	2834	" " " Nut.....
41346	2834	" " Lever.....
1430D	2834	" " Hinge Screw.....
2455	2834	Tension Disc.....
1562J	2834	" " Regulating Thumb Nut.....

## BOBBIN WINDER

No.	Plate	Name
418E	2834	Tension Disc Screw Stud.....
10141	2834	" Spring.....
2106	2834	" Thread Guide.....
60456	-----	Bobbin Winder, Nos.152F,207D,1429D,1550H, 41339 to 41346 and three 1430D.....
41347	2833	Bobbin Winder, Nos.60456 and two each 9331 and wood screws 1 in. No. 10 R.H.B.....
41348	-----	Bobbin Winder (swinging automatic, right hand) complete, Nos.27308 and 41347....
9331	2834	Bobbin Winder Washer.....

BOBBIN WINDER  
(SWINGING AUTOMATIC, RIGHT HAND)  
FOR POWER TABLE

No.	Plate	Name
225433	3469	Bobbin Winder and Tension Bracket Base....
225453	3470	Frame with 202277 and 225438.....
225454	3471	" Hinge Pin.....
202277	3471	" Oil Packing (wick).....
225438	3471	" " Well Cap.....
225455	3471	" Spring.....
225456	3471	" Plunger.....
202473	3470	Pulley with 200380C.....
200380C	3471	" Set Screw.....
225381	3470	Spindle.....
225444	3471	Stop Latch.....
200056E	3471	" " Screw.....
225458	3471	" " Thumb Lever.....
225459	3471	" " " Hinge Stud.....
225459	3471	" " " Joint Stud.....
202478	3471	" " Trip Lever.....
200299H	3471	" " " Hinge Screw.....
225461	3471	Tension Bracket with 201499B.....
200082D	3471	" " Screw.....
228026	-----	" " " Washer.....
2102	3471	" Disc.....
202407	3471	" Spring.....
201499B	3471	" Stud.....
201572B	3471	" " Thumb Nut.....
225462	-----	Tension Bracket complete, Nos.201572B, 202407,225461 and two 2102.....
225382	3469	Bobbin Winder complete, Nos.200056E,200082D 200299H,202473,202478,225381,225433, 225444,225453 to 225456,225458,225462, 228026, two each 225459 and wood screws 3/4 in. No. 12 R.H.B.....

## FOOT LIFTER PARTS

No.	Plate	Name
5596	7720	Bell Crank.....
56848	-----	" " 5596 with 5599 and 5601.....
5599	7720	" " Bracket.....
178E	7722	" " " Screw.....
5601	7723	" " Hinge Pin.....
5735	7720	" " Spring.....
5598	7720	Bell Crank complete, Nos. 5735 and 56848...
5670	-----	Chain, length 28 in. to 35 in., with 56864 and 56865.....
Note: When ordering No. 5670, state length required.		
56864	7720	Chain Hook (large).....
56865	7720	" " (small).....
4879	7720	" Connecting Link.....
12237	7720	Lifting Lever with 448C.....
52028	7720	" " Connecting Rod.....
12416	5936	" " " " Joint.....
78D	7722	" " " " " Hinge Screw.....
1521E	7722	Lifting Lever Connecting Rod Lock Nut....
802D	7722	" " Hinge Screw.....
12241	5936	" " Link.....
766D	7722	" " " Hinge Screw.....
12240	5936	" " Pin.....
448C	7722	" " " Set Screw.....
2763	819	Rock Shaft.....
12242	819	" " Hanger with two wood screws 1 in. No. 10.....
6337	819	Rock Shaft Lifting Bracket with two 356C..
12243	819	" " " " Hook.....
7125	819	" " " " Hook.....
356C	7722	" " " " Set Screw.....
356C	7722	" " " " Set Screw.....
2770	819	" " Stop Dog with 356C.....
356C	7722	" " " Set Screw.....
4880	819	Rock Shaft complete, Nos. 2763, 2770, 7125, 12243 and two each 6337 and 12242.....
4881	819	Treadle.....
4882	7720	" Shaft.....
4883	7720	" Spring.....
4884	819	" Stand.....
4885	819	Treadle complete, Nos. 4879, 4881 to 4884 and two wood screws 1 in. No. 16.....
58319	-----	Foot Lifter complete, Nos. 78D, 766D, 802D, 1521E, 4880, 4885, 5598, 5670, 12237, 12240, 12241, 12416, 52028 and two 178E.....

## KNEE LIFTER PARTS

No.	Plate	Name
5596	7720	Bell Crank.....
56848	-----	" " 5596 with 5599 and 5601.....
5599	7720	" " Bracket.....
178E	7722	" " " Screw.....
5601	7723	" " Hinge Pin.....
5735	7720	" " Spring.....
5598	7720	Bell Crank complete, Nos. 5735 and 56848...
12237	7720	Lifting Lever with 448C.....
52028	7720	" " Connecting Rod.....
12416	5936	" " " " Joint.....
78D	7722	" " " " " Hinge Screw.....
1521E	7722	Lifting Lever Connecting Rod Lock Nut....
802D	7722	" " Hinge Screw.....
12241	5936	" " Link.....
766D	7722	" " " Hinge Screw.....
12240	5936	" " Pin.....
448C	7722	" " " Set Screw.....
2763	819	Rock Shaft.....
7539	7711	" " Hanger with two wood screws 1 in. No. 10.....
2765	7711	Rock Shaft Knee Arm.....
2766	7711	" " " " Hub with 356C.....
356C	7722	" " " " Set Screw.....
2768	-----	Rock Shaft Knee Arm complete, Nos. 2765 to 2767.....
2767	7711	Rock Shaft Knee Arm Plate with 356C.....
356C	7722	" " " " Set Screw.....
6337	819	" " Lifting Bracket with two 356C..
2778	7711	" " " " Hook.....
356C	7722	" " " " Set Screw.....
356C	7722	" " " " Set Screw.....
2770	819	" " Stop Dog with 356C.....
356C	7722	" " " Set Screw.....
12260	7711	Rock Shaft complete, Nos. 2763, 2768, 2778, 6337 and two each 2770 and 7539.....
58320	-----	Knee Lifter complete (power table) Nos. 78D, 766D, 802D, 1521E, 5598, 12237, 12240, 12241, 12260, 12416, 52028 and two 178E.....

## THREAD UNWINDER

FOR TWO SPOOLS OR TWO LARGE CONES OF THREAD

No.	Plate	Name
225257	20336	Spool Rest with 201018C.....
150203	20336	" " Cushion (felt).....
225368	20336	" " Rod.....
200363C	7723	" " " Set Screw.....

## THREAD UNWINDER

No.	Plate	Name
201018C	7723	Spool Rest Set Screw.....
202490	20335	" Stand with 200383C.....
225391	20335	Thread Guide.....
201696J	7723	" " Lock Nut.....
225326	20335	" " Position Cup.....
225324	20335	" " Rod with 208E and 225322.....
208E	5899	" " " Screw.....
225322	7723	" " " Washer.....
225258	20335	Thread Unwinder complete, Nos. 201696J, 202490, 225257, 225324, 225326, 225388, two each 150203, 225391 and three wood screws 7/8 in. No. 12.....
27739	7234	Thread Cone (wood) for large cones.....
225390	7234	" " Holder, for inverted cones....

Note: Nos. 27739 and 225390 are used with, but not included in 225258.

Genuine Singer Needles should be used  
in Singer Machines.  
These Needles and their Containers  
are marked with the  
Company's Trade Mark "SIMANCO." 1

Needles in Containers marked  
"For Singer Machines"  
are not Singer made needles. 2

## NUMERICAL LIST OF PARTS

No.	Plate	Name
76D	7722	Lifting Lever Connecting Rod Joint Hinge Screw for 52319 and 52320.....
116E	7722	Arm Screw (back).....
121E	5899	" Shaft (horizontal) Bevel Gear Case Screw for 127070.....
121E	5899	Rotating Hook Shaft Bevel Gear Case Screw for 127007.....
144D	7722	Arm Shaft (horizontal) Screw.....
152F	2834	Bobbin Winder Stop Latch Finger Screw for 60456.....
157J	5910	Feed Lifting Rock Shaft Crank Clamping Screw for 12376.....
157J	5910	Feed Rock Shaft Crank Clamping Screw for 29633.....
158J	5899	Arm Top Cover Screw.....
158C	5899	Bed Frame Cushion Screw for 20067.....
158J	5899	Bobbin Winder Tension Bracket Screw.....
171D	5899	" " Pulley Set Screw for 41585..
176J	21809	Face Plate Screw.....
176J	21809	Presser Foot Screw.....
178E	7722	Bell Crank Bracket Screw for 52319 and 52320.....
185H	5899	Bobbin Winder Stop Latch Tripping Arm Clamping Screw for 41588.....
200F	2834	Bobbin Winder Pulley Set Screw for 41342..
207D	2834	" " Frame Spring Screw for 60456
207E	2834	Needle Bar Connecting Stud Clamping Screw for 24041.....
208E	5899	Thread Unwinder Thread Guide Rod Screw for 225324.....
211E	7722	Bed Frame Hinge Connection Cap Screw for 19398.....
219J	7722	Arm Shaft (horizontal) Ball Bearing (back) Cover Screw.....
219J	7722	Arm Side Cap Screw.....
223C	5936	Slack Thread Regulator Set Screw for 52338
226J	21809	Face Plate Thread Guard (lower) Screw for 52052.....
226J	21809	Face Plate Thread Guard (upper) Screw for 52052.....
229J	7722	Needle Bar Thread Guard Screw for 127116..
313C	7722	Feed Bar Screw Center for 56813.....
356C	7722	Rock Shaft Knee Arm Hub Set Screw for 2766
356C	7722	" " " " Plate Set Screw for 2767.....
356C	7722	Rock Shaft Lifting Bracket Hook Set Screw for 6337.....
356C	7722	Rock Shaft Lifting Bracket Set Screw for 6337.....
356C	7722	Rock Shaft Stop Dog Set Screw for 2770....
375C	5910	Feed Connecting Link Hinge Screw.....

## NUMERICAL LIST OF PARTS

No.	Plate	Name
375C	5910	Feed Forked Connection Hinge Screw for 52393.....
375C	5910	Feed Lifting Rock Shaft Connecting Rod Hinge Screw.....
401E	7722	Arm Shaft (horizontal) Ball Bearing(front) Cover Screw for 127199.....
418E	2834	Bobbin Winder Tension Disc Screw Stud for 27308.....
432C	21809	Arm Shaft (upright) Bushing (lower) Set Screw.....
435C	5899	Arm Shaft (upright) Bushing (upper) Set Screw.....
435C	5899	Thread Take-up Lever Link Hinge Pin Set Screw.....
446C	5899	Arm Shaft (horizontal) Ball Bearing (back) Locking Pin Cone Screw.....
448C	7722	Arm Shaft (horizontal) Flanged Bushing (back) Set Screw.....
448C	7722	Balance Wheel Set Screw for 52176.....
448C	7722	Feed and Feed Lifting Eccentric Set Screw for 127202.....
448C	7722	Lifting Lever Pin Set Screw for 12237.....
448C	7722	Thread Take-up Spring Regulator Set Screw.....
453C	5936	Presser Bar Guide Bracket Set Screw for 52338.....
457C	5899	Bobbin Winder Frame Hinge Pin Set Screw for 41583.....
457C	5899	Bobbin Winder Stop Latch Hinge Stud Set Screw for 41913.....
460C	7722	Bobbin Winder Tension Stud Set Screw for 150459.....
591F	21808	Rotating Hook Bobbin Case Tension Regulating Screw for 52481.....
592E	21808	Rotating Hook Bobbin Case Latch Stop Screw for 52473.....
624C	21809	Thread Retainer Set Screw.....
668J	7722	Pressure Regulating Thumb Screw.....
689C	5936	Presser Bar Lifter Hinge Screw.....
691F	7722	Throat Plate Screw.....
704J	21809	Rotating Hook Bobbin Case Holder Position Bracket Screw.....
725E	7722	Bed Slide Spring Screw for 12432.....
766D	7722	Lifting Lever Link Hinge Screw for 52319 and 52320.....
775E	21809	Needle Bar Connecting Link Cap Screw for 52217.....
802D	7722	Lifting Lever Hinge Screw for 52319 and 52320.....
818D	5910	Feed Regulator Thumb Screw.....
854E	7722	Arm Screw (front).....
880E	5899	Bobbin Winder Screw for 41915.....
966E	5899	Feed Lifting Rock Shaft Connecting Rod Cap Screw for 127156.....

## NUMERICAL LIST OF PARTS

No.	Plate	Name
1036G	21809	Arm Shaft (horizontal) Bevel Gear Set Screw for 127072.....
1036C	21809	Thread Take-up Crank Set Screw for 127198.....
1037C	21809	" " " Position Screw for 127198.....
1053D	21809	Rotating Hook Thread Guard Screw for 127096.....
1065C	7722	Needle Bar Crank Position Screw for 127198.....
1126E	5910	Feed Regulator Hinge Screw.....
1133E	21809	Needle Bar Bushing (lower) Set Screw.....
1133E	21809	" " " (upper) Set Screw.....
1143C	21809	Rotating Hook Shaft Bushing (back) Set Screw.....
1146C	21809	Rotating Hook Shaft Bushing (front) Set Screw.....
1253C	21809	Rotating Hook Set Screw for 127095.....
1259C	21809	Arm Shaft (upright) Bevel Gear (lower) Set Screw for 127073.....
1259C	21809	Arm Shaft (upright) Bevel Gear (upper) Set Screw for 127074.....
1259C	21809	Rotating Hook Shaft Bevel Gear Set Screw for 127073.....
1299C	21809	Feed and Feed Lifting Eccentric Position Screw for 127202.....
1367D	21808	Rotating Hook Section Screw for 127097 and 127119.....
1380E	21808	Rotating Hook Bobbin Case Tension Spring Screw for 52481.....
1429D	2834	Bobbin Winder Frame Hinge Screw for 60456.....
1430D	2834	" " Stop Latch Hinge Screw for 60456.....
1430D	2834	Bobbin Winder Stop Latch Lever Hinge Screw for 60456.....
1513J	7722	Feed Lifting Rock Shaft Screw Center Nut for 52097.....
1513J	7722	Feed Rock Shaft Screw Center Nut for 52097.....
1518J	5910	" Connecting Link Hinge Screw Nut.....
1518E	5910	" Forked Connection Hinge Screw Nut for 52393.....
1518J	5910	Feed Lifting Rock Shaft Connecting Rod Hinge Screw Nut.....
1519J	21809	Feed Bar Screw Center Nut for 56813.....
1520J	5936	Presser Bar Lifter Hinge Screw Nut.....
1521E	7722	Lifting Lever Connecting Rod Lock Nut for 52319 and 52320.....
1550H	2834	Bobbin Winder Stop Latch Hinge Screw Nut for 60456.....
1560C	21809	Tension Regulating Thumb Nut for 52098.....
1562J	2834	Bobbin Winder Tension Disc Regulating Thumb Nut for 27308.....
1613	5910	Feed Lifting Rock Shaft Crank Roller and Stud for 12376.....

## NUMERICAL LIST OF PARTS

No.	Plate	Name
2102	3471	Bobbin Winder Tension Disc for 225482.....
2102	3471	Tension Disc for 52397.....
2103	5899	" Spring for 52397.....
2106	2834	Bobbin Winder Tension Thread Guide for 27308.....
2455	2834	Bobbin Winder Tension Disc for 27308 and 150460.....
2763	819	Rock Shaft for 4880 and 12250.....
2765	7711	" " Knee Arm for 2768.....
2766	7711	" " " " Hub with 356C, for 2768
2767	7711	" " " " Plate with 356C, for 2768.....
2768	-----	Rock Shaft Knee Arm complete, Nos.2765 to 2767, for 12250.....
2770	819	Rock Shaft Stop Dog with 356C, for 4880 and 12250.....
2778	7711	Rock Shaft Lifting Bracket Hook for 12250.
2974	21808	Rotating Hook Bobbin Case Latch Lever Fulcrum Pin for 40393.....
2975	21808	Rotating Hook Bobbin Case Latch Spring for 52473.....
4307	7719	Bed Slide Spring for 12432.....
4879	7720	Chain Connecting Link for 4885.....
4880	819	Rock Shaft complete, Nos.2763,2770,7125, 12243 and two each 6337 and 12242, for 52319.....
4881	819	Treadle for 4885.....
4882	7720	" Shaft for 4885.....
4883	7720	" Spring for 4885.....
4884	819	" Stand for 4885.....
4885	819	Treadle complete, Nos.4879,4881 to 4884 and two wood screws 1 in. No. 16, for 52319.....
5596	7720	Bell Crank for 56848.....
5598	7720	Bell Crank complete, Nos.5735 and 56848, for 52319 and 52320.....
5599	7720	Bell Crank Bracket for 56848.....
5601	7723	" " Hinge Pin for 56848.....
5670	-----	Chain, length 26 in. to 35 in., with 56864 and 56865, for 52319.....
5735	7720	Bell Crank Spring for 5598.....
6337	819	Rock Shaft Lifting Bracket with two 356C, for 4880 and 12250.....
7125	819	Rock Shaft Lifting Bracket Hook for 4880..
7298	7723	Presser Foot Hinge Pin for 19336.....
7539	7711	Rock Shaft Hanger with two wood screws 1 in. No. 10, for 12250.....
7958	7723	Bobbin Winder Stop Latch Stop Pin for 60845.....
8879	5936	Arm Spool Pin Washer (cloth).....
8879	5936	Bobbin Winder Tension Bracket Spool Pin Washer (cloth).....

## NUMERICAL LIST OF PARTS

No.	Plate	Name
8908	7720	Wrench for 1519 and 1520.....
8909	6120	" " 1513 and 1518.....
9331	2834	Bobbin Winder Washer for 41347.....
10141	2834	" " Tension Spring for 27308....
11170	5936	Presser Bar Spring Washer.....
11204	21804	Thread Take-up Lever Link Hinge Pin for 127200.....
11241	2833	Bobbin Winder Spool Washer (cloth) for 27308.....
12237	7720	Lifting Lever with 448C, for 52319 and 52320.....
12240	5936	Lifting Lever Pin for 52319 and 52320.....
12241	5936	" " Link for 52319 and 52320....
12242	819	Rock Shaft Hanger with two wood screws 1 in. No. 10, for 4880.....
12243	819	Rock Shaft Lifting Bracket Hook for 4880..
12250	7711	Rock Shaft complete, Nos.2763,2768,2778, 6337 and two each 2770 and 7539, for 52320.....
12327	5936	Presser Bar Lifting and Releasing Lever Bracket.....
12329	5936	Tension Releasing Lever Spring.....
12361	7721	Machine Hinge Connection for 44140.....
12376	5910	Feed Lifting Rock Shaft Crank with 157J and 1813, for 52385.....
12391	7718	Presser Bar (hollow).....
12398	5936	Tension Releasing Lever Hinge Pin.....
12403	7719	Arm Spool Pin and Thread Eyelet for 127193
12403	7719	Bobbin Winder Tension Bracket Spool Pin and Thread Eyelet for 150460.....
12405	7721	Machine Rest (felt).....
12416	5936	Lifting Lever Connecting Rod Joint for 52319 and 52320.....
12431	-----	Bed Slide for 12432.....
12432	7719	Bed Slide complete, Nos.4307,12431 and two 725E.....
14010	7723	Bed Frame Hinge Plate Rivet for 20067.....
*15404	-----	Trade Mark for 127218.....
15405	-----	" " Rivet for 127218.....
16532	21801	Arm Dowel Pin.....
16555	7721	Bed Frame Hinge Plate for 20067.....
19219	7720	" " Cushion (leather) for 20067.....
19220	7721	" " " Spring for 20067.....
19226	7721	" " Hinge Connection for 19398.....
19334	-----	Presser Foot Plate for 19336.....
19335	-----	" " Shank for 19336.....
19336	7723	Presser Foot (hinged) complete, Nos. 7298, 19334 and 19335.....
19397	7723	Bed Frame Hinge Connection Cap for 19398..
19398	-----	" " " " 19226 with 211E and 19397, for 20067.....

## NUMERICAL LIST OF PARTS

No.	Plate	Name
20067	819	Bed Frame with two each 18555, 19398, four each 19219, 19220, six each 14010 wood screws 1 1/4 in. No. 12 and eight 1580.
20284	7721	Feed Forked Connection for 52393.....
24041	21804	Needle Bar Connecting Stud with 207E, for 52206.....
25446	7723	Bobbin Winder Screw Washer for 41915.....
25866	7721	Guide.....
26026	6120	Screw Driver (large).....
26485	6120	" (small).....
27306	2834	Bobbin Winder Spool Pin for 27308.....
27307	2833	" " " Stand for 27308.....
27308	2833	Bobbin Winder Spool Stand complete, Nos. 418E, 1562J, 2106, 10141, 11241, 27308, 27307 and two each 2455 and wood screws 1 in. No. 10, for 41348.....
27739	7234	Thread Unwinder Thread Cone (wood) for large cones for 22525G.....
29633	5910	Feed Rock Shaft Crank with 157J, for 52387
32572	7723	Tension Releasing Disc for 52397.....
32574	7723	" " Lever Pin for 52397.....
34105	5902	Bobbin Winder Frame Hinge Pin for 60845....
40264	21808	Rotating Hook Bobbin.....
40274	21808	" " Section for 127097 and 127119.....
40392	21808	Rotating Hook Bobbin Case Latch for 40393.
40393	-----	" " " Hinge, Nos. 2974, 40392 and 125320, for 52473.....
40394	21808	Rotating Hook Bobbin Case Tension Spring for 52481.....
41339	2833	Bobbin Winder Base for 60456.....
41340	2833	" " Frame for 60456.....
41341	2833	" " Spring for 60456.....
41342	2833	" " Pulley with 200F, for 60456.
41343	2834	" " Spindle for 60456.....
41344	2834	" " Stop Latch for 60456.....
41345	2834	" " Finger for 60456.
41346	2834	" " Lever for 60456..
41347	2833	" " Nos. 60456 and two each 9331 and wood screws 1 in. No. 10 R.H.B. for 41348.....
41348	-----	Bobbin Winder (swinging automatic, right hand) complete, Nos. 27308 and 41347....
41400	6120	Machine Rest Pin.....
41583	5902	Bobbin Winder Frame with 457C, for 60845..
41585	5902	" " Pulley with 171D, for 60845.
41586	5902	" " Spindle for 60845.....
41587	5902	" " Stop Latch for 60845.....
41588	5902	" " Tripping Arm with 185H, for 60845.....
41593	5936	Bobbin Winder Tension Spring for 150460...
41594	5936	" " Stud for 150460.....

## NUMERICAL LIST OF PARTS

No.	Plate	Name
41595	5936	Bobbin Winder Tension Thread Guide for 150460.....
41913	5902	Bobbin Winder Bracket with 457C for 60845.
41914	5902	" " Frame Spring for 60845.....
41915	5902	" " 60845 with 880E and 25446, for 150461.....
42367	21801	Arm Oil Tube Packing (braided cotton) for 52185 and 127187.....
42614	5902	Bobbin Winder Stop Latch Hinge Stud for 60845.....
43944	5936	Tension Releasing Lever.....
44136	5805	Feed Dog, 15 teeth (16 teeth to the inch) for 44137 and 44138.....
44137	5805	Throat Plate, large needle hole, for 44136
44138	-----	" " small needle hole, for 44136
44139	7721	Machine Hinge Plate for 44140.....
44140	-----	Machine Hinge complete, Nos. 12361, 44139 and merlized wood screws 1 1/4 in. No. 14.....
44212	7711	Drip Pan with four 1 in. wire nails.....
50053W	5899	Arm Side Cover Thumb Screw.....
50083C	5910	Feed Connecting Link Hinge Stud Set Screw for 52074.....
50117E	7722	Feed Dog Screw.....
50190J	5899	Face Plate Thumb Screw.....
50190J	5899	Guide Thumb Screw.....
50191C	5899	Feed Lifting Rock Shaft Screw Center for 52097.....
50191C	5899	Feed Rock Shaft Screw Center for 52097....
50234D	5899	Rotating Hook Shaft Bevel Gear Case Plug Screw for 127007.....
50304C	5899	Tension Stud for 52098.....
50305C	5899	" " Set Screw for 52083.....
51460F	7722	Needle Clamp Screw for 52307.....
52014	7721	" Bar Bushing (upper).....
52016	5936	Presser Bar Lifter.....
52018	21808	Rotating Hook Bobbin Case Holder Position Bracket.....
52023	21809	Thread Take-up Lever Hinge Pin for 127183.
52024	21804	" " Link for 127183.....
52027	7723	" Guard (side of arm).....
52028	7720	Lifting Lever Connecting Rod for 52319 and 52320.....
52045	-----	Rotating Hook Shaft Bushing (back) Packing (wick) for 127043.....
52045	-----	Rotating Hook Shaft Bushing (front) Packing (wick) for 127044.....
52051	-----	Face Plate for 52052.....
52052	7718	Face Plate complete, Nos. 52051, 52053, 52170 and two 226J.....
52053	7723	Face Plate Thread Guard (lower) for 52052.

## NUMERICAL LIST OF PARTS

No.	Plate	Name
52073	5910	Feed Connecting Link Hinge Stud for 52118.
52074	5910	" Regulator with 50083C, for 52118.....
52083	5899	Thread Take-up Spring Regulator with 50305C, for 52397.....
52097	-----	Feed Lifting Rock Shaft Screw Center 50191C with 1513J.....
52097	-----	Feed Rock Shaft Screw Center 50191C with 1513J.....
52098	-----	Tension Stud 50304C with 1560C, for 52397.
52118	-----	Feed Regulator 52074 with 52073.....
52130	7723	Thread Take-up Lever Thread Eyelet Bushing for 127182.....
52146	7723	Arm Shaft (horizontal) Back Bearing Oil Pad (braided cotton).....
52146	7723	Arm Shaft (horizontal) Front Bearing Oil Pad (braided cotton).....
52148	21801	Arm Oil Tube for 52149.....
52149	-----	" " " 52148 with 52150, for oiling 127073 and 127074.....
52150	21801	Arm Oil Tube Packing (braided cotton) for 52149.....
52165	7719	Feed Connecting Link for 52393.....
52170	7723	Face Plate Thread Guard (upper) for 52052.
52176	7718	Balance Wheel (power) 2 3/16 in. pulley with two 448C.....
52180	21801	Arm Oil Tube (long) with 52184, for oiling 127182.....
52182	21801	Arm Oil Tube with 52184, for oiling 52205.
52183	21801	" " " 52184, for oiling 52024.
52184	-----	" " " Packing (wick) for 52180, 52182, 52183 and 52186.....
52184	-----	Oil Tube Packing (wick) for 127191.....
52185	21801	Arm Oil Tube (short) with 42367, for oiling 127182.....
52186	21801	Arm Oil Tube with 52184, for oiling 127156 for 127193 and 150480.....
*52201	-----	Oil Absorbent Wick for 52202.....
52202	7721	" " " 52201 with 52203, for lower cavity in head of Arm.....
*52203	-----	Oil Absorbent Wick Wire for 52202.....
52205	21804	Needle Bar Connecting Link with 52207, for 52206.....
52206	-----	Needle Bar Connecting Link 52205 with 24041, for 52217.....
52207	7723	Needle Bar Connecting Link Lubricating Pad (wood) for 52205.....
52210	7723	Feed and Feed Lifting Eccentric Lubricating Pad (wood) long for 127202.....
52211	7723	Feed and Feed Lifting Eccentric Lubricating Pad (wood) short for 127202.....
52216	21804	Thread Take-up Crank for 52217.....
52217	-----	" " " 52216 with 775E and 52206, for 127200.....

## NUMERICAL LIST OF PARTS

No.	Plate	Name
52306	7723	Needle Bar Thread Guard for 127116.....
52307	7723	" Clamp with 51480F, for 127116.....
52319	-----	Foot Lifter complete, Nos. 76D, 766D, 802D, 1521E, 4880, 4885, 5598, 5670, 12237, 12240, 12241, 12416, 52028 and two 178E.....
52320	-----	Knee Lifter complete (power table) Nos. 76D, 766D, 802D, 1521E, 5598, 12237, 12240, 12241, 12250, 12416, 52028 and two 178E...
52337	5936	Slack Thread Regulator.....
52338	5936	Presser Bar Guide Bracket with 223C and 453C.....
*52383	-----	Bed.....
52384	7724	Feed Lifting Rock Shaft for 52385.....
52385	-----	Feed Lifting Rock Shaft complete, Nos. 12376 and 52384.....
52386	7724	Feed Rock Shaft for 52387.....
52387	-----	Feed Rock Shaft complete, Nos. 29633 and 52386.....
*52393	-----	Feed Forked Connection 20284 with 375C, 1518E and 52185.....
52394	7723	Thread Take-up Spring for 52397.....
52397	-----	Tension complete, Nos. 2103, 32572, 32574, 52083, 52098, 52394 and two 2102.....
52452	7719	Feed Bar.....
52454	21804	Thread Retainer.....
52472	-----	Rotating Hook Bobbin Case for 52481.....
52473	21806	Rotating Hook Bobbin Case complete, Nos. 592E, 2975, 40393 and 52481, for 127098 and 127099.....
*52475	-----	Rotating Hook Bobbin Case Locating Plate for 127100.....
*52476	-----	Rotating Hook Bobbin Case Locating Plate Rivet for 127100.....
52481	-----	Rotating Hook Bobbin Case 52472, with 591E 1360E and 40394 for 52473.....
52486	7723	Arm Shaft (horizontal) Ball Bearing (back) Locking Pin.....
52487	7723	Arm Shaft (horizontal) Ball Bearing (back) Locking Pin Cone.....
52490	7719	Arm Shaft (horizontal) Flanged Bushing (back).....
52492	21804	Arm Shaft (upright) Bushing (lower).....
52493	21804	" " " " (upper).....
54897	21809	" " (horizontal) Back Bearing Oil Cup.....
54897	21809	Arm Shaft (horizontal) Front Bearing Oil Cup.....
54897	21809	Rotating Hook Shaft Bushing (front) Oil Cup.....
56015	21801	Arm Oil Tube for oiling 127058, for 127218
56813	-----	Feed Bar Screw Center 313C with 1513J.....
56848	-----	Bell Crank 5596 with 5599 and 5601, for 5598.....





## NUMERICAL LIST OF PARTS

No.	Plate	Name
150460	7720	Bobbin Winder Tension Bracket complete, Nos. 12403, 41593 to 41595, 52186, 127187, 150459 and two 2455, for 150461.....
150461	-----	Bobbin Winder (swinging automatic, left hand) complete, Nos. 41915 and 150460....
200056E	3471	Bobbin Winder Stop Latch Screw for 225382.
200082D	3471	" " Tension Bracket Screw for 225382.....
200299H	3471	Bobbin Winder Stop Latch Trip Lever Hinge Screw for 225382.....
200380C	3471	Bobbin Winder Pulley Set Screw for 202473.
200383C	7723	Thread Unwinder Spool Rest Rod Set Screw for 202490.....
201018C	7723	Thread Unwinder Spool Rest Set Screw for 225257.....
201499B	3471	Bobbin Winder Tension Stud for 225461.....
201572B	3471	" " " " Thumb Nut for 225462.....
201696J	7723	Thread Unwinder Thread Guide Lock Nut for 225258.....
202277	3471	Bobbin Winder Frame Oil Packing (wick) for 225453.....
202407	3471	Bobbin Winder Tension Spring for 225462...
202473	3470	" " Pulley with 200380C, for 225382.....
202478	3471	Bobbin Winder Stop Latch Trip Lever for 225382.....
202490	20335	Thread Unwinder Spool Stand with 200383C, for 225258.....
225257	20335	Thread Unwinder Spool Rest with 201018C, for 225258.....
225258	20335	Thread Unwinder complete, Nos. 201696J, 202490, 225257, 225324, 225326, 225388, two each 150203, 225391 and three wood screws 7/8 in. No. 12.....
225322	7723	Thread Unwinder Thread Guide Rod Washer for 225324.....
225324	20335	Thread Unwinder Thread Guide Rod with 208E and 225322, for 225258.....
225326	20335	Thread Unwinder Thread Guide Position Cup for 225258.....
225381	3470	Bobbin Winder Spindle for 225382.....
225382	3469	Bobbin Winder complete, Nos. 200056E, 200082D, 200299H, 202473, 202478, 225381, 225433, 225444, 225453 to 225456, 225458, 225462, 228026, two each 225459 and wood screws 3/4 in. No. 12 R.H.B.....
225388	20335	Thread Unwinder Spool Rest Rod for 225258.
225390	7234	" " Thread Cone Holder, for inverted cones for 225258.....
225391	20335	Thread Unwinder Thread Guide for 225258...

## NUMERICAL LIST OF PARTS

No.	Plate	Name
225433	3469	Bobbin Winder and Tension Bracket Base for 225382.....
225438	3471	Bobbin Winder Frame Oil Well Cap for 225453.....
225444	3471	Bobbin Winder Stop Latch for 225382.....
225453	3470	" " Frame with 202277 and 225438 for 225382.....
225454	3471	Bobbin Winder Frame Hinge Pin for 225382..
225455	3471	" " " Spring for 225382.....
225456	3471	" " " Plunger for 225382.....
225458	3471	Bobbin Winder Stop Latch Thumb Lever for 225382.....
225459	3471	Bobbin Winder Stop Latch Thumb Lever Hinge Stud for 225382.....
225459	3471	Bobbin Winder Stop Latch Thumb Lever Joint Stud for 225382.....
225461	3471	Bobbin Winder Tension Bracket with 201499B for 225462.....
225462	-----	Bobbin Winder Tension Bracket complete, Nos. 201572B, 202407, 225461 and two 2102, for 225382.....
228026	-----	Bobbin Winder Tension Bracket Screw Washer for 225382.....

Genuine Singer Needles should be used in Singer Machines. These Needles and their Containers are marked with the Company's Trade Mark "SIMANCO." 1

Needles in Containers marked "For Singer Machines" are not Singer made needles. 2

Genuine Singer Needles should be used  
in Singer Machines.  
These Needles and their Containers  
are marked with the  
Company's Trade Mark "SIMANCO." 1

Needles in Containers marked  
"For Singer Machines"  
are not Singer made needles. 2

PLATE 819—ONE-FOURTH SIZE

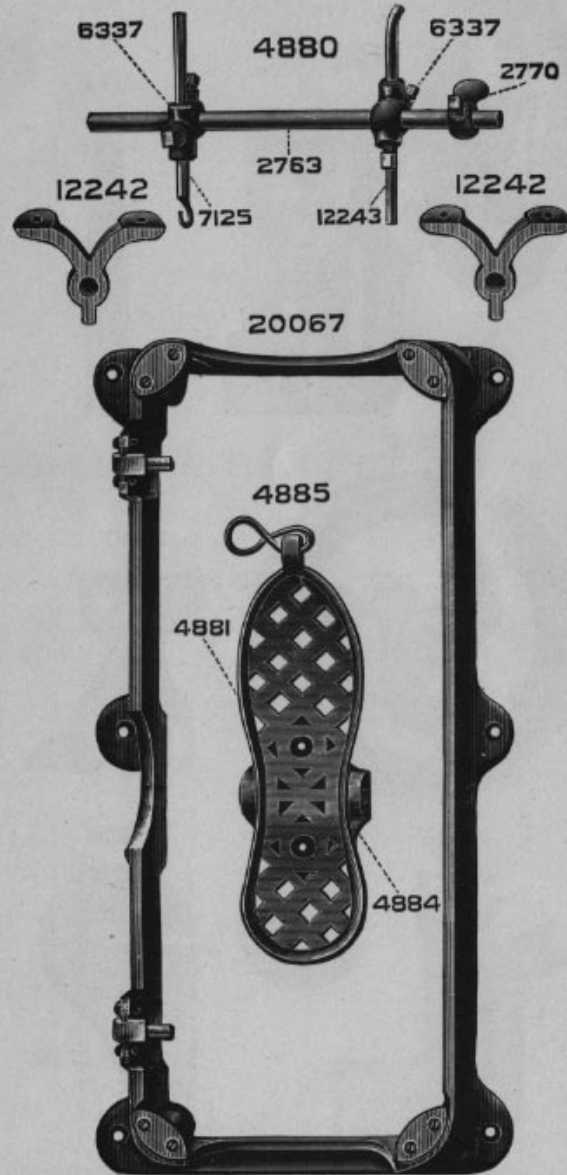

**PLATE 2833—ONE-HALF SIZE**

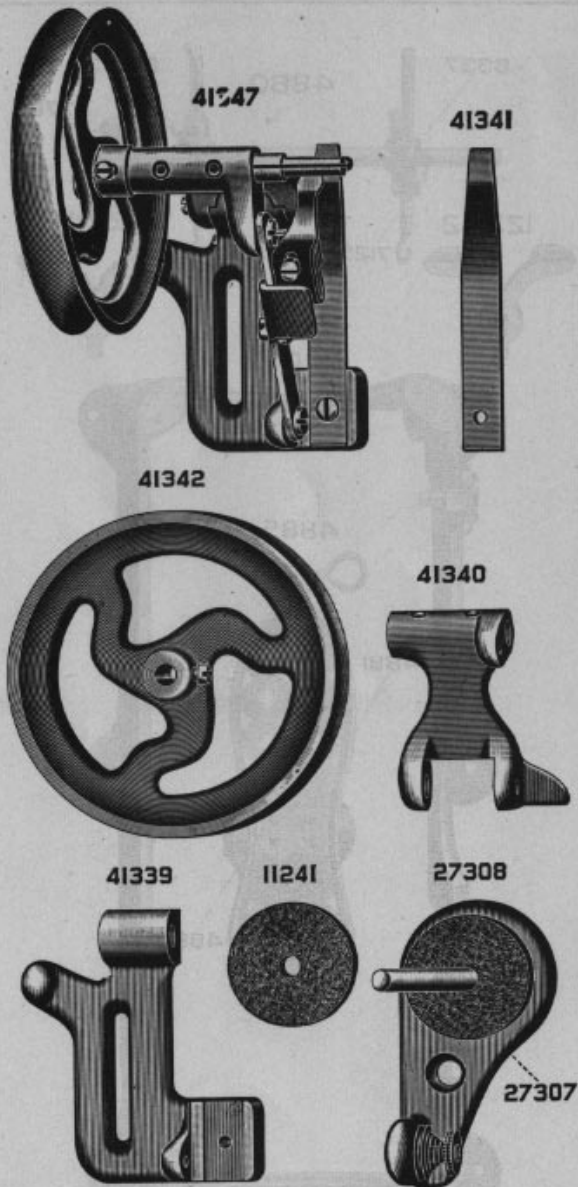

**PLATE 2834—FULL SIZE**

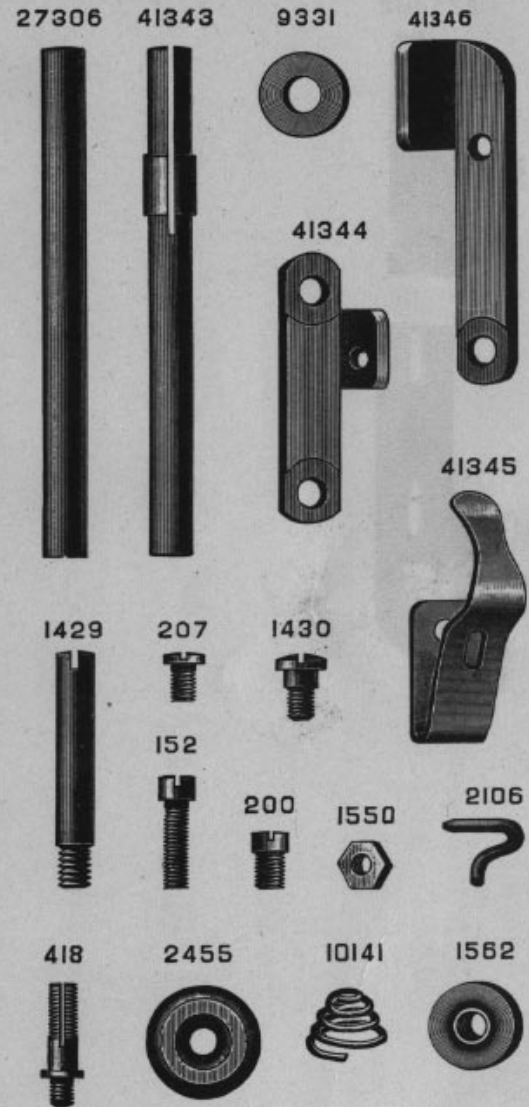

PLATE 3469—ONE-FOURTH SIZE

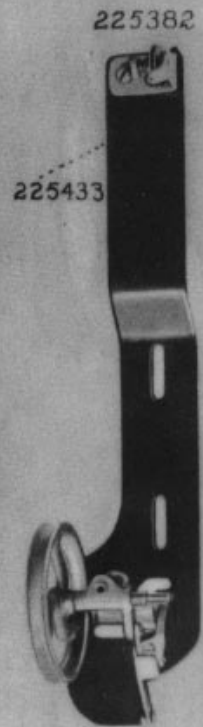

PLATE 3470—ONE-HALF SIZE

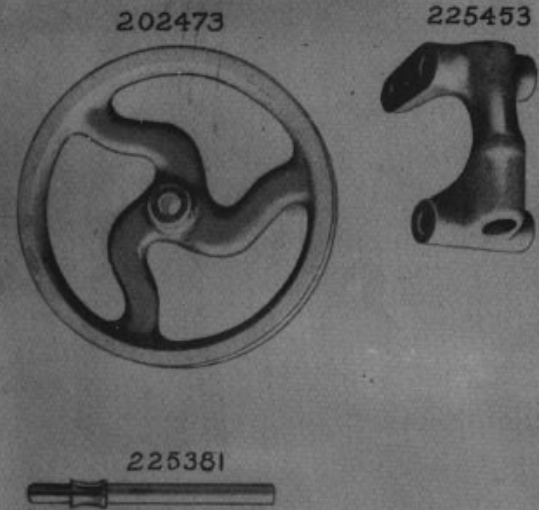

PLATE 3471—FULL SIZE

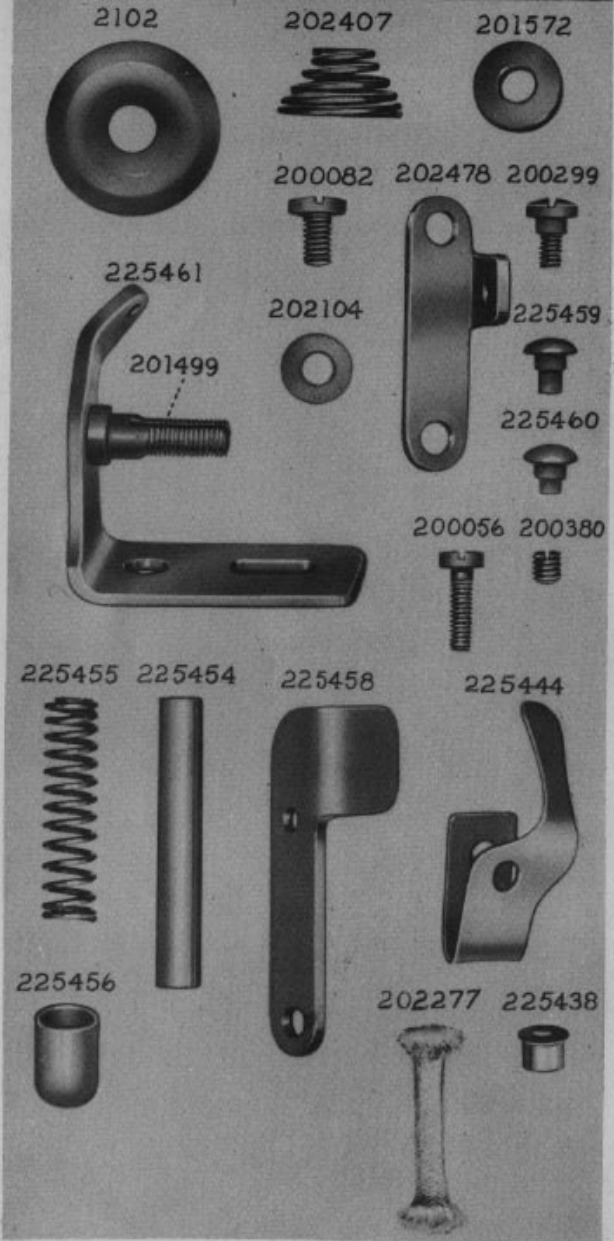

PLATE 5805—FULL SIZE

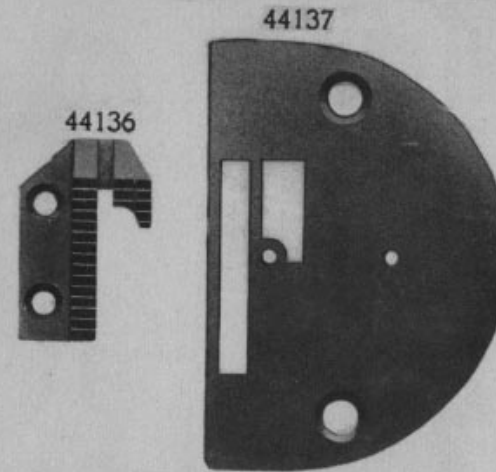

PLATE 5899—FULL SIZE

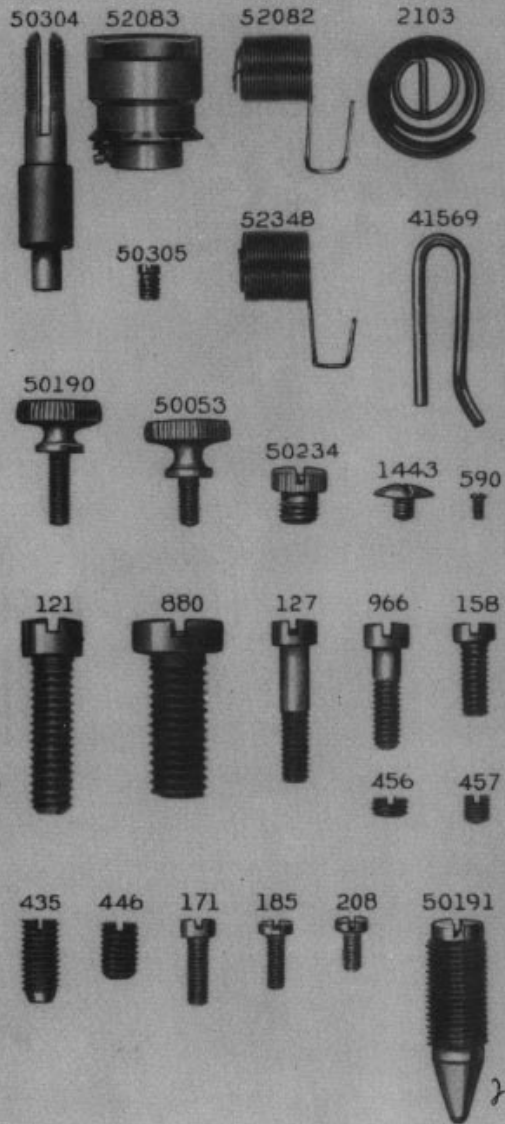

PLATE 5902—ONE-HALF SIZE

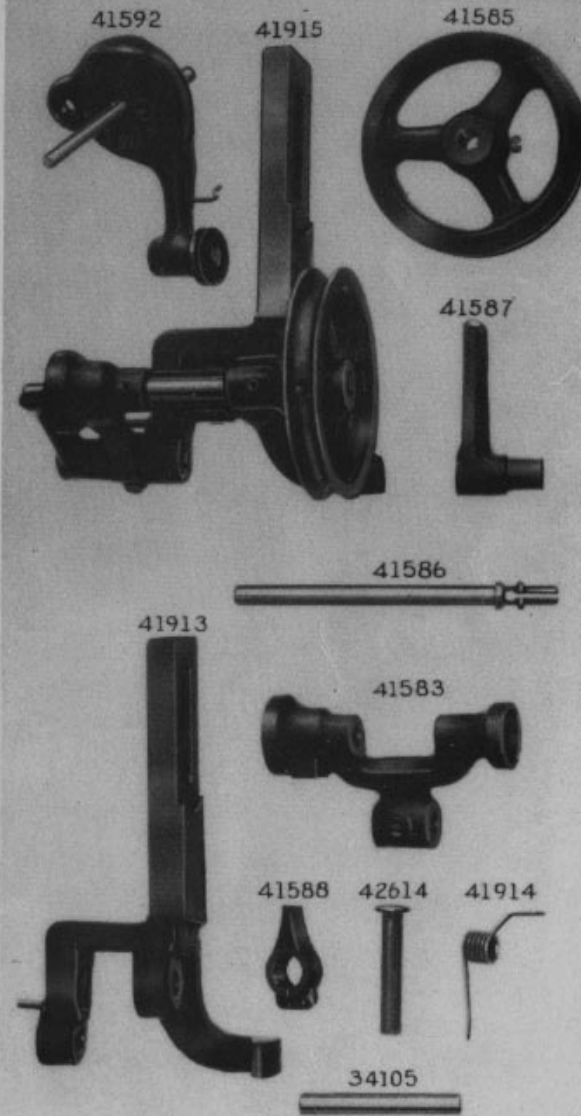



PLATE 5910—FULL SIZE

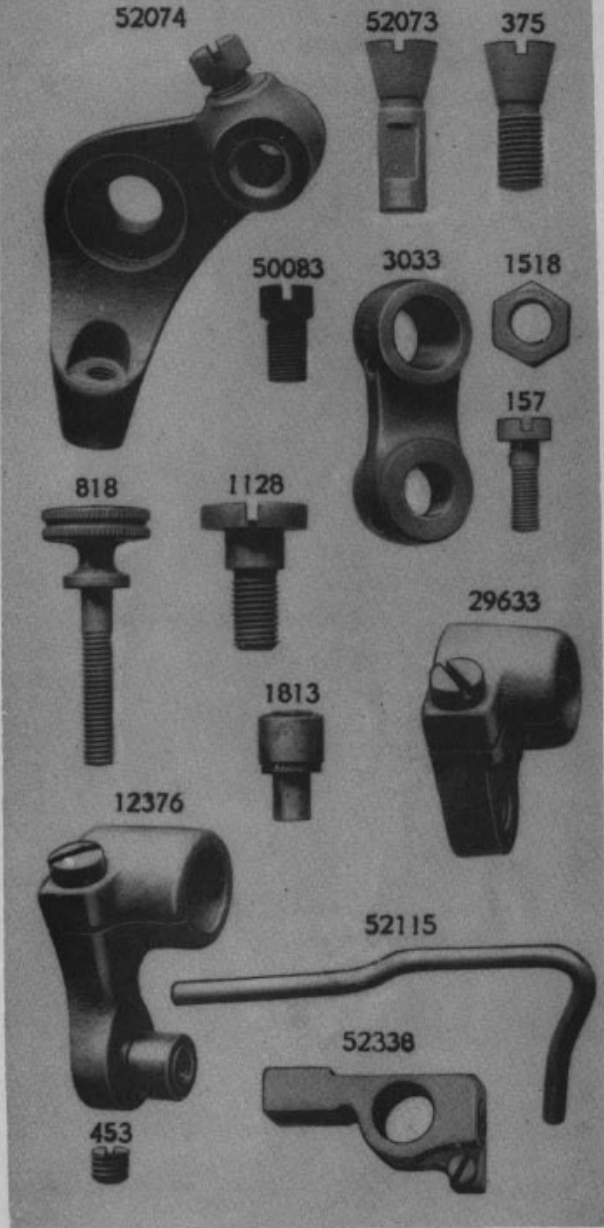
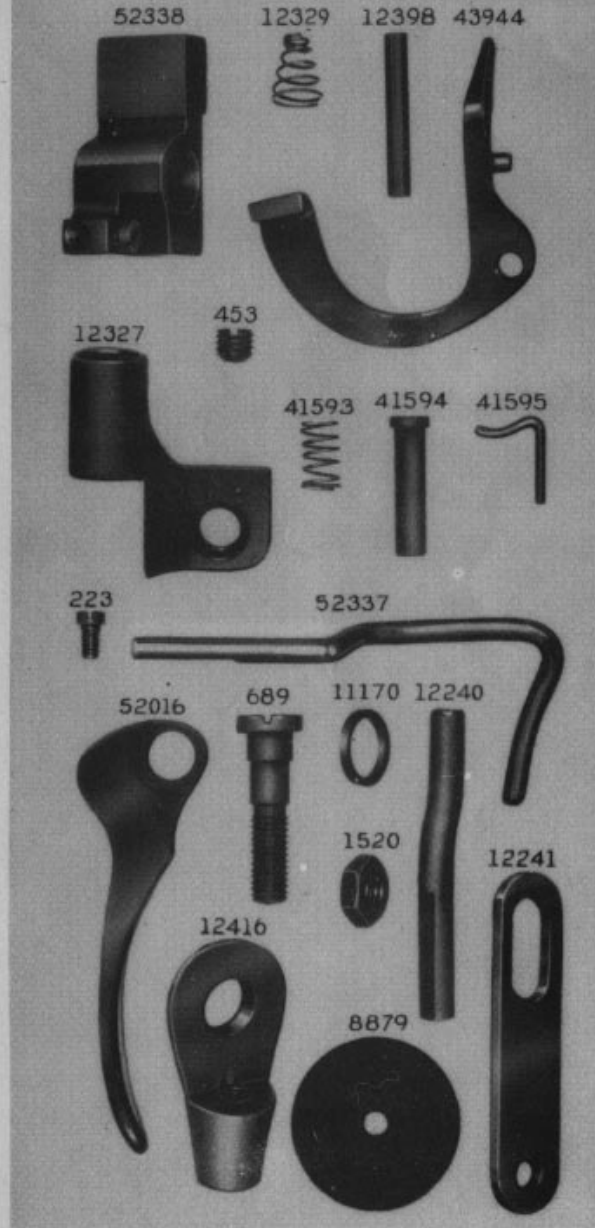
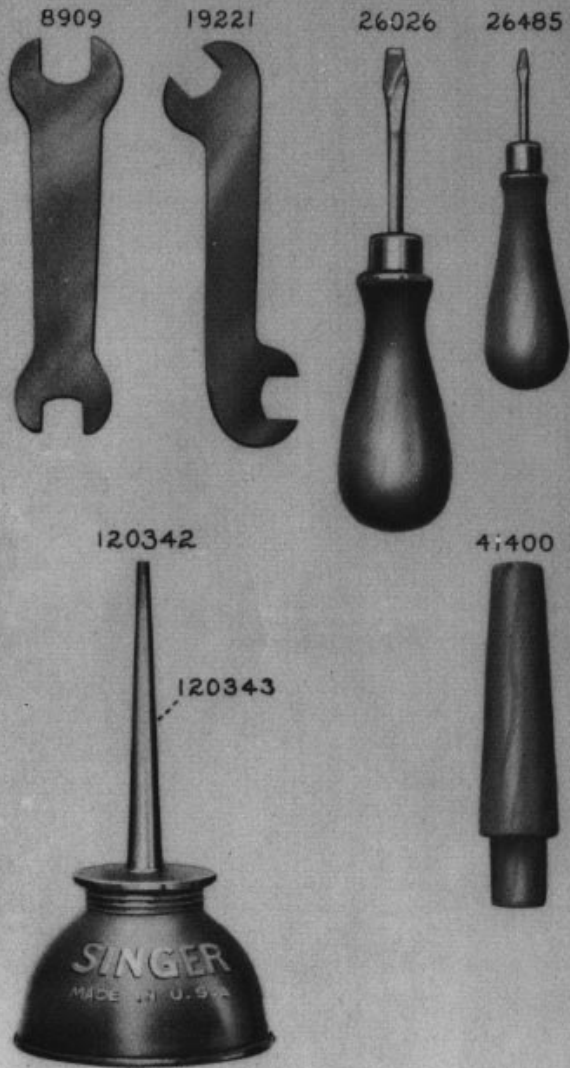

PLATE 5936—FULL SIZE



**PLATE 6120—ONE-HALF SIZE**



**PLATE 7234—ONE-HALF SIZE**

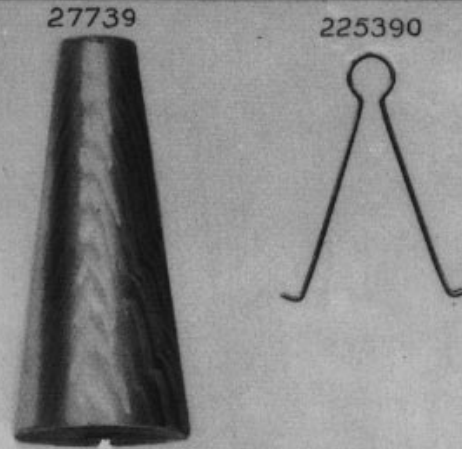

PLATE 7711—ONE-FOURTH SIZE

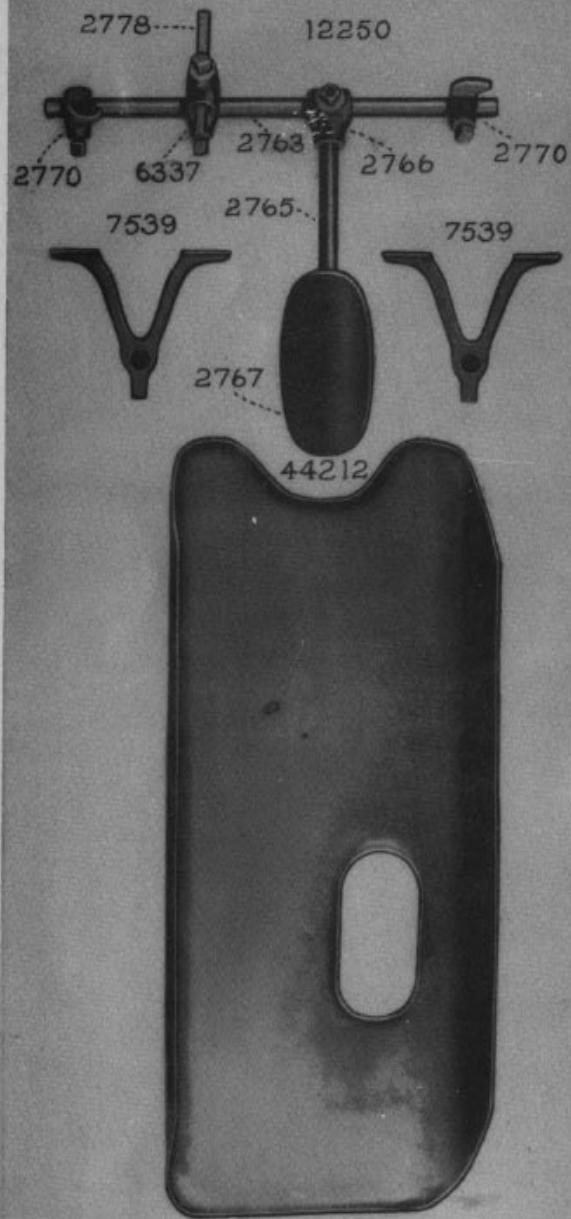

PLATE 7718—ONE-HALF SIZE

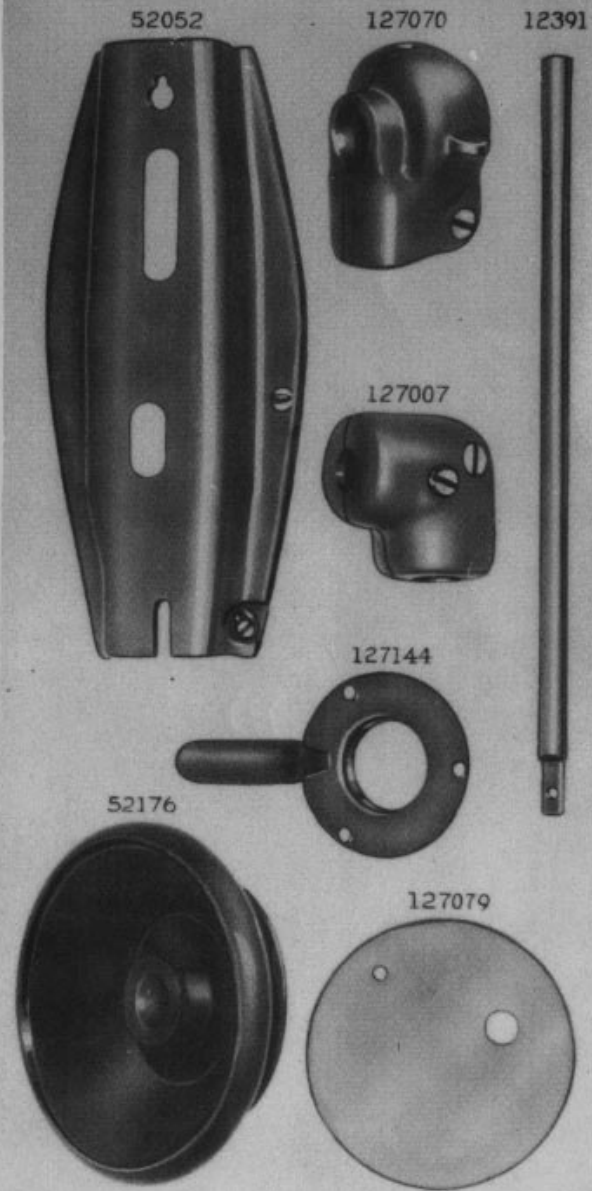

PLATE 7719—ONE-HALF SIZE

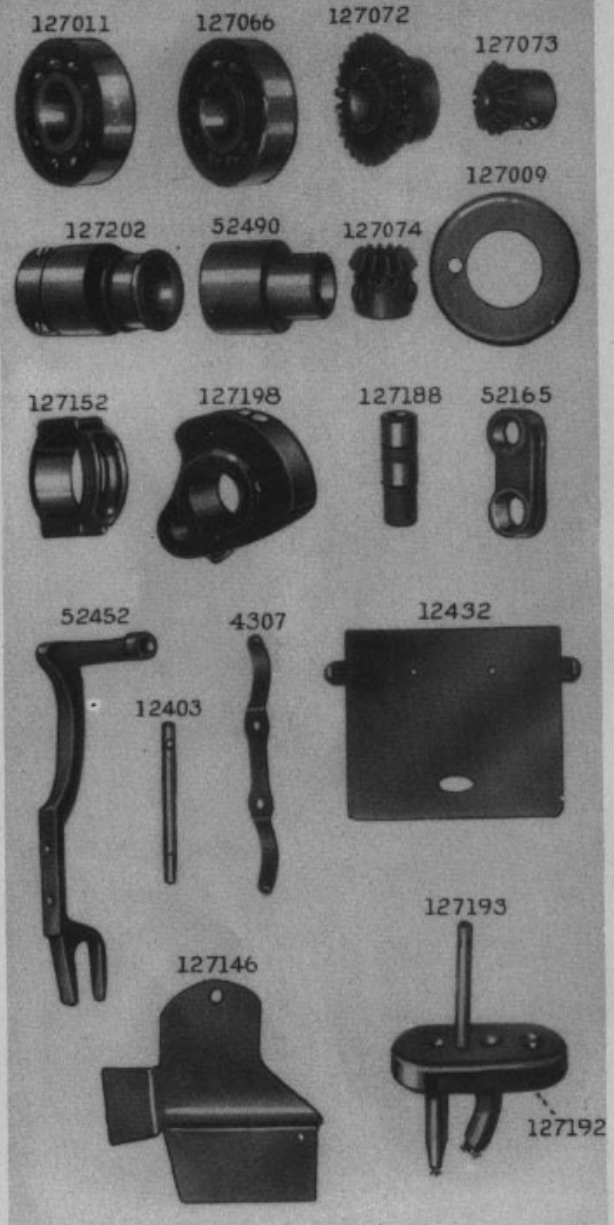

PLATE 7720—ONE-HALF SIZE

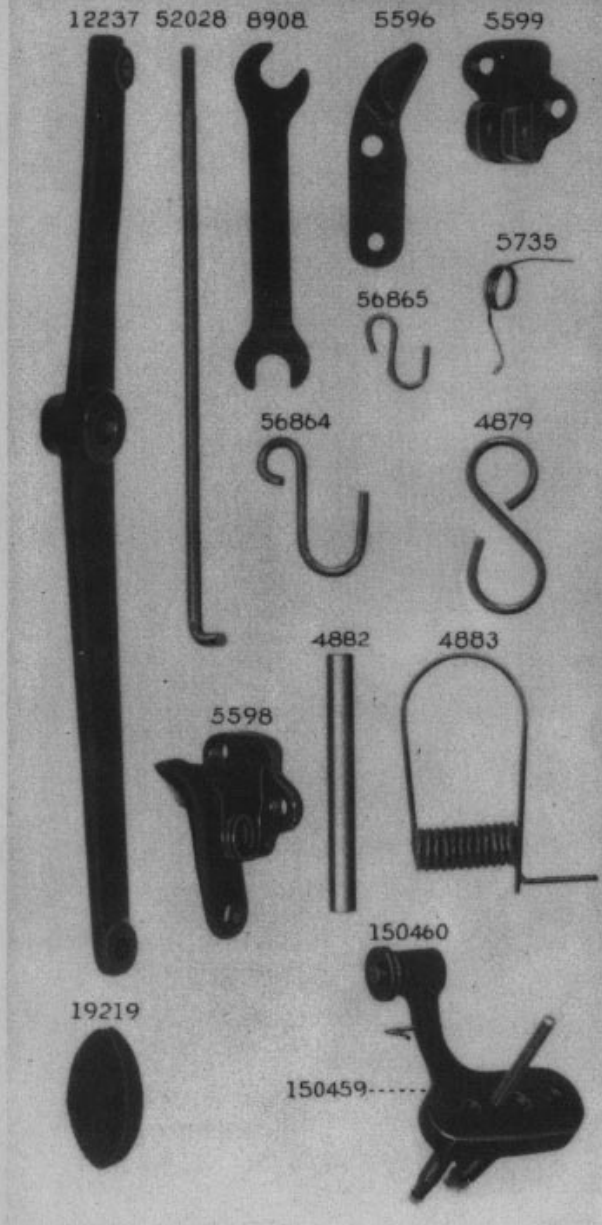

PLATE 7721—ONE-HALF SIZE

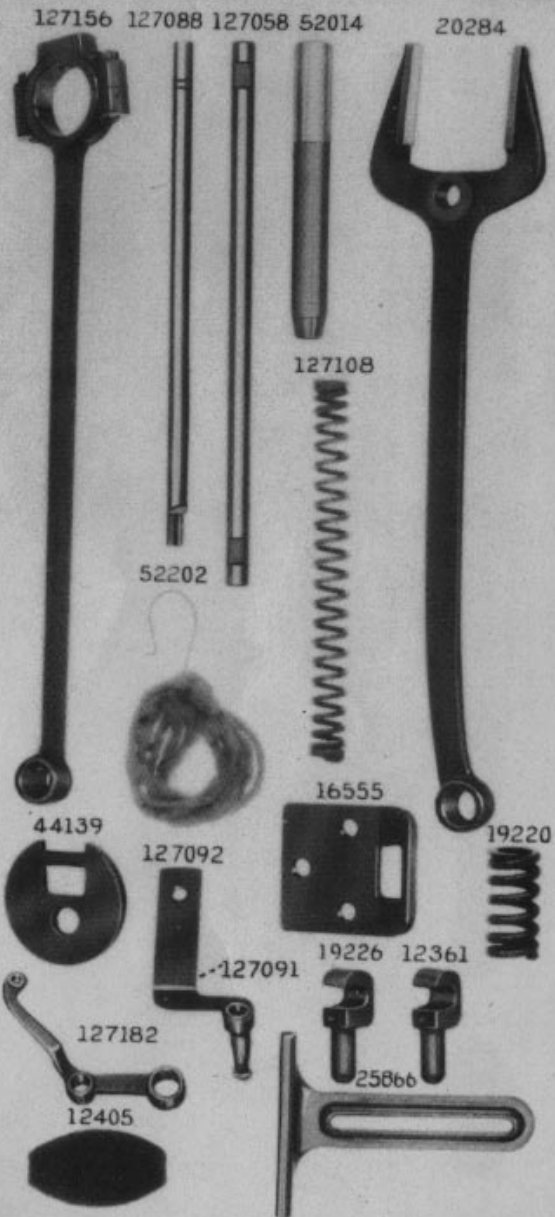

PLATE 7722—FULL SIZE

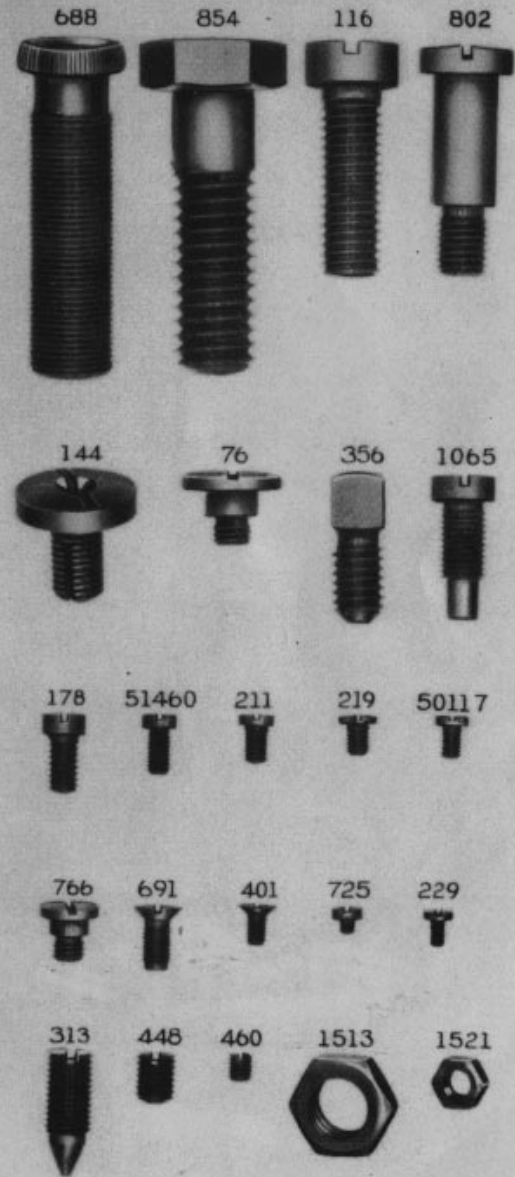
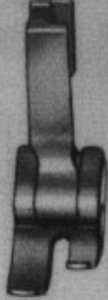
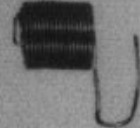

PLATE 7723—FULL SIZE

19336 127191 32574 7298 7958



52394



52487



52486



14010



5601



201018



52027

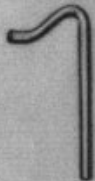

52306



52307



201696



52053



52170



52130



127067



200383



52207



52210



52211



52146



225322



32572



25446



19397



PLATE 7724—ONE-HALF SIZE

127068 127059 52386 52384

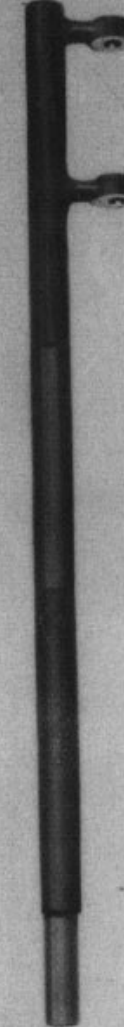

PLATE 20335—ONE-SIXTH SIZE

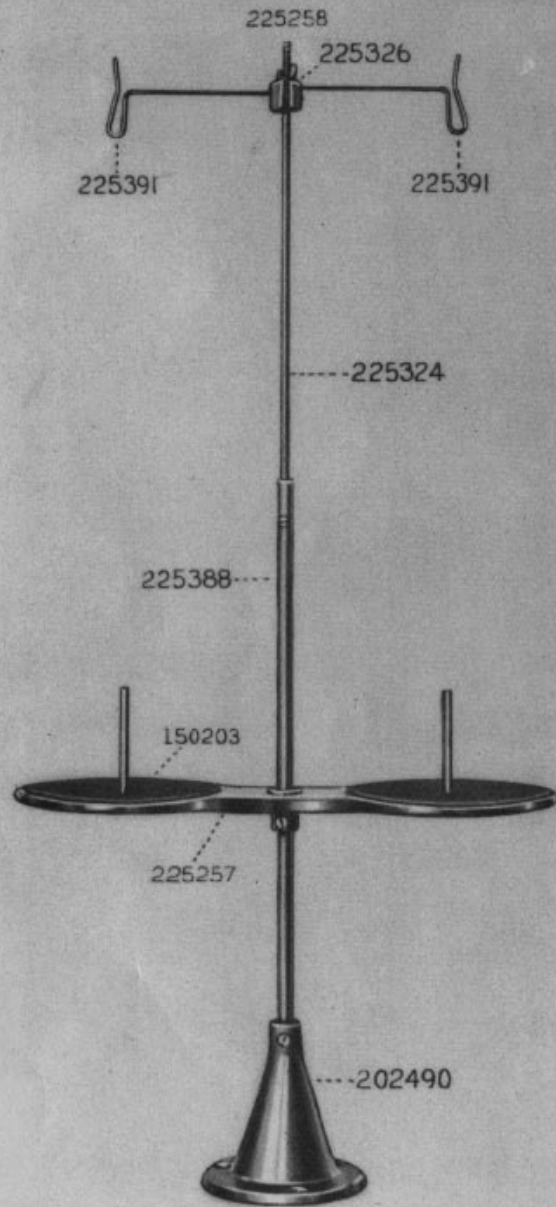

PLATE 21801—FULL SIZE

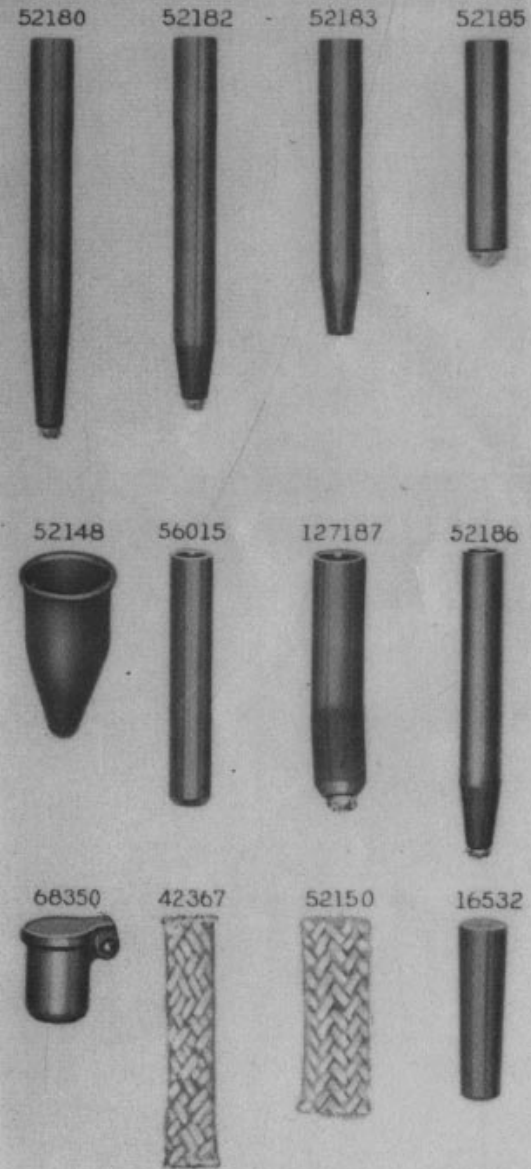

PLATE 21804—FULL SIZE

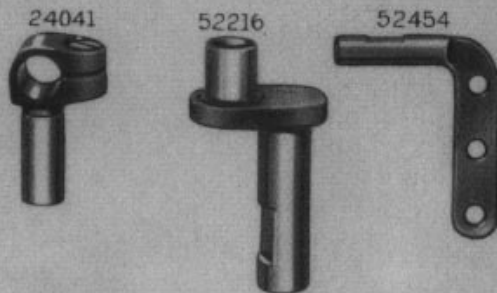
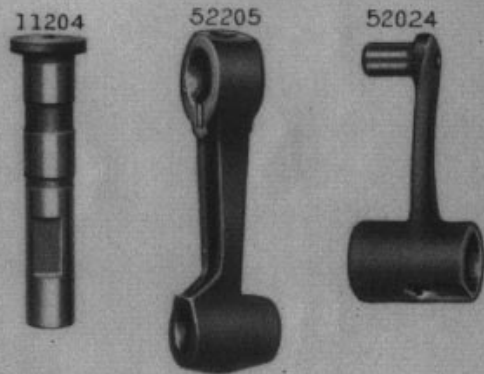
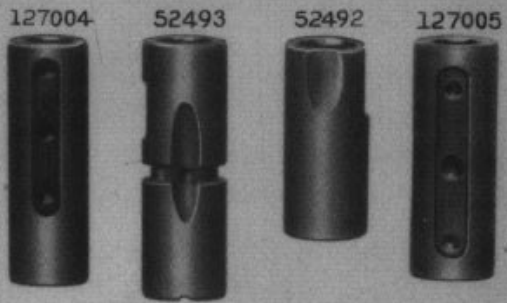

PLATE 21808—FULL SIZE

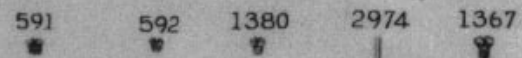
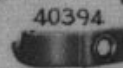
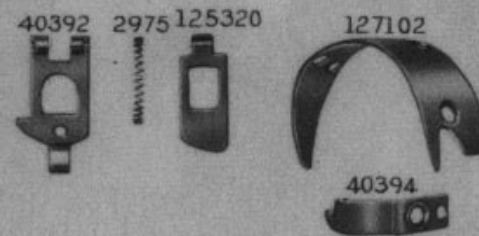
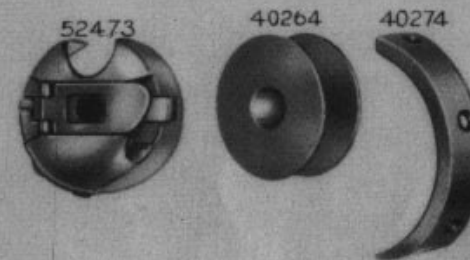
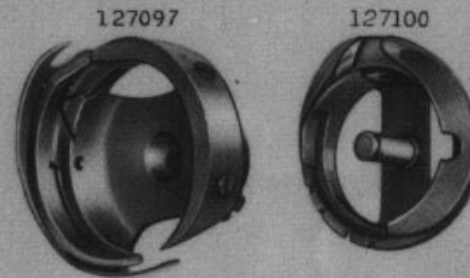
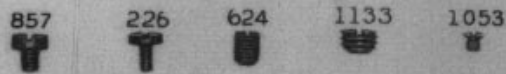



PLATE 21809—FULL SIZE

1148 1143 176 775 1253



## Free Manuals Download Website

<http://myh66.com>

<http://usermanuals.us>

<http://www.somanuals.com>

<http://www.4manuals.cc>

<http://www.manual-lib.com>

<http://www.404manual.com>

<http://www.luxmanual.com>

<http://aubethermostatmanual.com>

Golf course search by state

<http://golfingnear.com>

Email search by domain

<http://emailbydomain.com>

Auto manuals search

<http://auto.somanuals.com>

TV manuals search

<http://tv.somanuals.com>