

MX890 Wireless Desktop Base

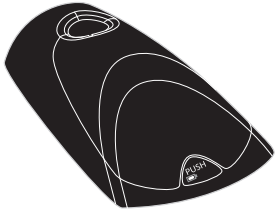

The Shure MX890 desktop base for MX405, MX410 and MX415 gooseneck microphones offers cable-free installation for corporate boardrooms or other applications requiring flexible microphone configurations and MX415 miniature gooseneck microphones are suitable for boardrooms and other sites where aesthetics are important. The MX890 operates within the 518–937 MHz band and is compatible with Shure SLX wireless systems.

MX690 Wireless Boundary Microphone



The Shure MX690 microphone offers cable-free installation for corporate boardrooms or other applications requiring flexible configurations. The MX690 operates within the 518–937 MHz band and is compatible with Shure SLX wireless systems.

Features

- Sleek, low profile design
- Frequency agile, microprocessor controlled transmitter
- IR link to SLX receiver for automatic frequency synchronization
- Programmable frequency Group/Channel display
- Programmable mute function
- Operates on two AA batteries
- Compatible with all Shure SLX Wireless systems
- MX890 Supports Shure MX405, MX410 and MX415 Mini Gooseneck Microphones
- Commshield® technology for protection from RF interference

Placement

MX890 Microphone Placement

Place the MX890 no more than 25 cm (1 ft.) from the edge of the table. Aim the microphone toward the talker and away from loudspeakers and noise sources. Use one microphone for each talker. Pickup angle with a cardioid cartridge is 130° at –3 dB. Pickup angle with a supercardioid cartridge is 115° at –3 dB.

Note: To minimize RF interference, maintain a distance of at least 0.3 m (1 ft.) between transmitters. In case of interference, increase the distance between transmitters or change channels.

MX690 Microphone Placement

Place the MX690 within 1.5 m (5 ft.) of a talker. Aim the microphone toward the talkers and away from loudspeakers and noise sources. Use one microphone for every two talkers. Pickup angle with a cardioid cartridge is 130° at –3 dB.

Note: To minimize RF interference, maintain a distance of at least 0.3 m (1 ft.)

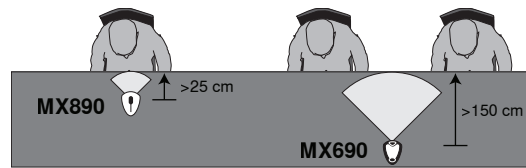

Receiver

Make sure the receiver is within sight of the transmitter. Do not place receiver behind a metal barrier or any reflective surface.

Refer to the SLX Wireless System User Guide for more information, or visit www.shure.com.

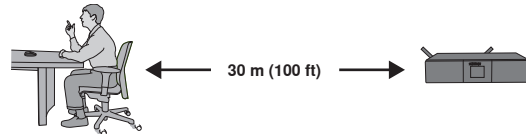

Power On/Off

1. With the battery door open, press and hold the ON/OFF button for approximately 2 seconds. Release the button when the LCD screen illuminates.
2. To turn off the transmitter, press and hold the ON/OFF button for approximately 2 seconds. Release the button when the LCD screen is blank. The LEDs on the outside of the microphone will also go dark.

Note: To power on the transmitter without opening the battery compartment, press and hold the plastic ON/OFF button on the battery door for approximately 2 seconds, then release it.

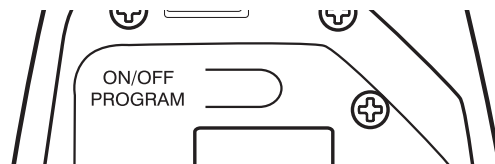

MX890 Connecting Gooseneck

1. Align the pin on the microphone flange with the slot on the desktop base.
2. Insert the gooseneck into the desktop base and lock it in place by rotating the gooseneck sleeve clockwise.

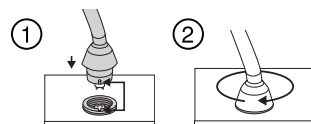

Low-Cut Filter

The low-cut filter attenuates frequencies below 150 Hz by 6 dB per octave.

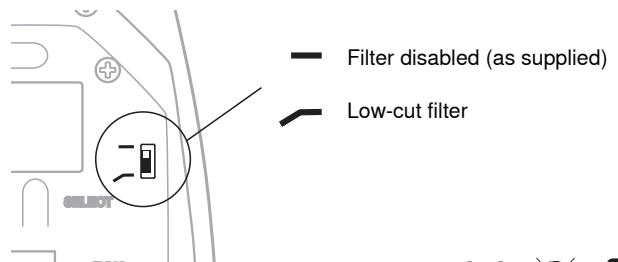

Battery

Installation

1. Open the battery compartment as shown.
2. Insert two 1.5 V "AA" batteries. Make sure the +/- terminals are properly oriented.

Note: Alkaline batteries last up to 8 hours. Rechargeable, carbon-zinc, and zinc-chloride batteries provide less operating time.

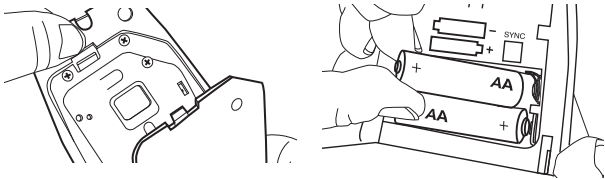

Power Meter

The battery meter on the LCD shows remaining battery life.

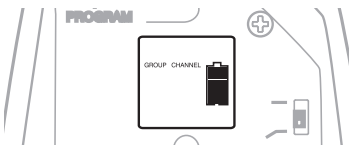

Low Power Indicator

Steady Red: Power low. Replace batteries immediately
Pulsing Red: Batteries dead. Transmitter cannot be turned on until batteries are replaced.

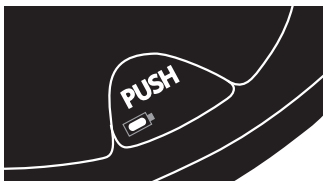

Mute Button

The mute button can be configured for toggle or momentary operation.

Toggle (as supplied)

The PUSH button toggles the microphone between active and muted states.

Note: The microphone always powers up in the active state.

Momentary

There are two types of momentary operation:

Push-to-Mute: The microphone is muted only while the button is pressed and held.

Push-to-Talk: The microphone is active only while the button is pressed and held.

To change between toggle and momentary:

Hold the PUSH button and press the SELECT button. (Test the microphone to confirm the change.)

Hold



To change between push-to-talk and push-to-mute:

1. Set the button for momentary operation.
2. Hold the SELECT button and press the PUSH button.

Hold



Mute Indicator

MX890

The desktop base illuminates the gooseneck microphone LED to indicate whether the microphone is active or muted. Refer to the following table:

MX890 Status Indicator

Microphone Status	MX405 / MX410 Indicator	MX405R / MX410R Light Ring
Active		
Muted	Red/Flashing Green*	Off/Flashing*

*To toggle between off and flashing, press PUSH and ON/OFF PROGRAM simultaneously.



MX690

The bi-color LED on the top of the microphone indicates whether the microphone is active or muted.

The LED can also be set to flash when muted.

MX690 Status Indicator

Display Mode	Status Indicator
Steady (as supplied)	Active = Green
	Muted = Red
Flashing	Active = Green
	Muted = Flashing Green

SHURE®

United States, Canada, Latin America, Caribbean:

Shure Incorporated
5800 West Touhy Avenue
Niles, IL 60714-4608 USA

Phone: 847-600-2000
Fax: 847-600-1212 (USA)
Fax: 847-600-6446
Email: info@shure.com

www.shure.com

©2013 Shure Incorporated

Europe, Middle East, Africa:

Shure Europe GmbH
Jakob-Dieffenbacher-Str. 12,
75031 Eppingen, Germany

Phone: 49-7262-92490
Fax: 49-7262-9249114
Email: info@shure.de

Asia, Pacific:

Shure Asia Limited
22/F, 625 King's Road
North Point, Island East
Hong Kong

Phone: 852-2893-4290
Fax: 852-2893-4055
Email: info@shure.com.hk

Locking Settings

Press ON/OFF and SELECT simultaneously to lock or unlock transmitter settings. When locked, the current settings cannot be manually changed.

Note: Locking the transmitter settings does not disable IR frequency synchronization or the High Pass/Low Cut filter.

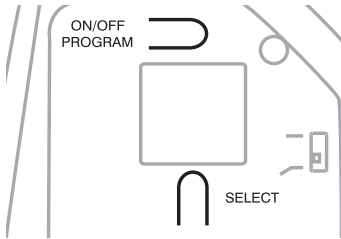

Logic Mode

To use with a logic enabled receiver, you must perform an automatic sync. The LCD flashes "log" during sync. Once in logic mode, the LCD flashes "log" when powered up.

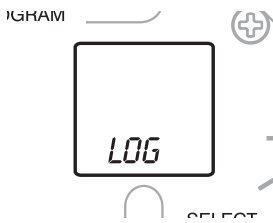

Automatic Frequency Synchronization

1. Power off all transmitters.
2. Begin with the first transmitter. Open the battery cover and power it on.
3. Begin with the first transmitter. Open the battery cover and power it on.
4. Aim the IR sensor at the first receiver IR port. The transmitter should be no more than 15 cm (6 in.) from the receiver. Press and hold the receiver SYNC button to send group and channel data to the transmitter. The red LED on the transmitter will stop flashing when programming is complete.
5. Power off the first transmitter and repeat the synchronization with each additional transmitter and receiver pair.

Manual Frequency Synchronization

1. Press and hold the transmitter SELECT button until the desired group number appears.
2. Press SELECT again and release it when the desired channel number appears.

Tips for Optimum Performance

- Maintain a direct line of sight between the transmitter and receiver antennas.
- Avoid placing the transmitter on metal surfaces.
- Avoid placing laptop computers or other obstructions in front of the microphone during use.
- Only use with a Shure SLX4L wireless receiver.

Troubleshooting

If you encounter difficulty with the SLX Wireless System

- Make sure both the transmitter and the receiver are turned on.
- Replace the battery if the battery LED is red.
- Make sure the Group/Channel settings for each transmitter-receiver pair are identical.
- Make sure there is an unobstructed line of sight between the transmitter and receiver.
- If necessary, reposition the receiver or decrease the distance between transmitter and receiver.
- Remove local sources of RF interference, such as computers or lighting equipment.
- Remove metal objects within 0.3 m (1 ft.) of the transmitter

Note: Refer to the SLX Wireless System User Guide for complete troubleshooting procedures.

Frequency Selection

Shure offers wireless systems in a selection of bands that conform to the different government regulations of specific nations or geographic regions. These regulations help limit radio frequency (RF) interference among different wireless devices and prevent interference with local public communications channels, such as television and emergency broadcasts.

The system's band and frequency range are identified on the receiver and transmitter. For example, "H4 518-578 MHz."

For information on bands available in your area, consult your local dealer or phone Shure. More information is also available at www.shure.com.

LICENSING INFORMATION

Licensing: A ministerial license to operate this equipment may be required in certain areas. Consult your national authority for possible requirements. Changes or modifications not expressly approved by Shure Incorporated could void your authority to operate the equipment. Licensing of Shure wireless microphone equipment is the user's responsibility, and licensability depends on the user's classification and application, and on the selected frequency. Shure strongly urges the user to contact the appropriate telecommunications authority concerning proper licensing, and before choosing and ordering frequencies.

Certifications

Certified under FCC Part 74.

Certified by IC in Canada under RSS-123 and RSS-102.

FCC: DD4MX890. **IC:** 616A-MX890.

This product meets the Essential Requirements of all relevant European directives and is eligible for CE marking.

The CE Declaration of Conformity can be obtained from: www.shure.com/europe/compliance

Authorized European representative:

Shure Europe GmbH

Headquarters Europe, Middle East & Africa

Department: EMEA Approval

Jakob-Dieffenbacher-Str. 12

75031 Eppingen, Germany

Phone: 49-7262-92 49 0

Fax: 49-7262-92 49 11 4

Email: EMEAsupport@shure.de

Specifications

Working Range

Line of Sight
30 m (100 ft)

Note: Actual range depends on RF signal absorption, reflection and interference.

Frequency Stability

±10 ppm

Modulation

FM, 45 kHz max. deviation

Power Requirements

2 LR6 AA batteries, 1.5 V, alkaline

Power Consumption

@3 V

Display backlight on	220 mA, ±30 mA
Display backlight off	175 mA, ±30 mA

Power Consumption (X4, X7)

@3 V

Display backlight on	245 mA, ±30 mA
Display backlight off	200 mA, ±30 mA

Battery Life

>8 hours (alkaline)

Operating Temperature Range

-18°C (0°F) to +57°C (135°F)

Note: Battery characteristics may limit this range.

Dimensions

43 mm x 87 mm x 148 mm (H x W x D)

Weight

	MX690	MX890
Net	319 g (11.2 oz.)	312 g (11 oz.)
Packaged	516 g (18.2 oz.)	530 g (18.7 oz.)

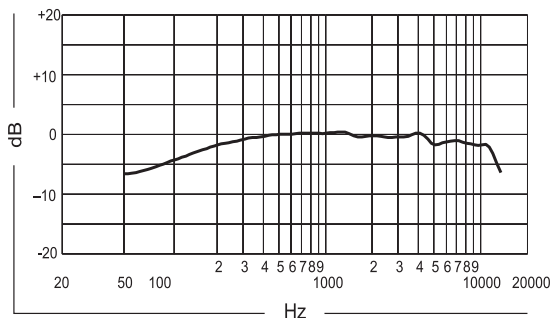
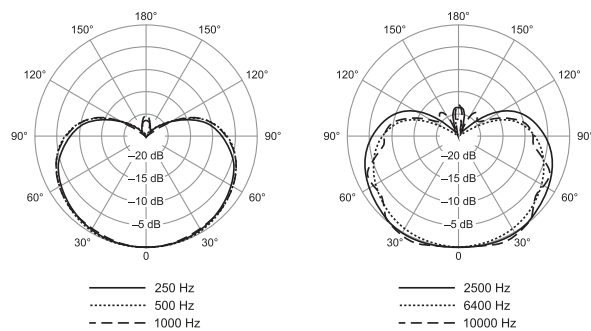

Frequency Range and Transmitter Output Level

Band	Range	Output Power
G4	470 to 494 MHz	30 mW
G5	494 to 518 MHz	30 mW
H5	518 to 542 MHz	30 mW
J3	572 to 596 MHz	30 mW
L4	638 to 662 MHz	30 mW
P4	702 to 726 MHz	30 mW
Q4	740 to 752 MHz	10 mW
R13	794 to 806 MHz	20 mW
R5	800 to 820 MHz	20 mW
JB	806 to 810 MHz	10 mW
S6	838 to 865 MHz	10 mW
X4	925 to 932 MHz	10 mW
X7	925 to 937.5 MHz	10 mW

IMPORTANT SAFETY INSTRUCTIONS

1. READ these instructions.
2. KEEP these instructions.
3. HEED all warnings.
4. FOLLOW all instructions.
5. DO NOT use this apparatus near water.
6. CLEAN ONLY with dry cloth.
7. DO NOT block any ventilation openings. Allow sufficient distances for adequate ventilation and install in accordance with the manufacturer's instructions.
8. DO NOT install near any heat sources such as open flames, radiators, heat registers, stoves, or other apparatus (including amplifiers) that produce heat. Do not place any open flame sources on the product.
9. DO NOT defeat the safety purpose of the polarized or grounding type plug. A polarized plug has two blades with one wider than the other. A grounding type plug has two blades and a third grounding prong. The wider blade or the third prong are provided for your safety. If the provided plug does not fit into your outlet, consult an electrician for replacement of the obsolete outlet.
10. PROTECT the power cord from being walked on or pinched, particularly at plugs, convenience receptacles, and the point where they exit from the apparatus.
11. ONLY USE attachments/accessories specified by the manufacturer.
12. USE only with a cart, stand, tripod, bracket, or table specified by the manufacturer, or sold with the apparatus. When a cart is used, use caution when moving the cart/apparatus combination to avoid injury from tip-over.
13. UNPLUG this apparatus during lightning storms or when unused for long periods of time.
14. REFER all servicing to qualified service personnel. Servicing is required when the apparatus has been damaged in any way, such as power supply cord or plug is damaged, liquid has been spilled or objects have fallen into the apparatus, the apparatus has been exposed to rain or moisture, does not operate normally, or has been dropped.
15. DO NOT expose the apparatus to dripping and splashing. DO NOT put objects filled with liquids, such as vases, on the apparatus.
16. The MAINS plug or an appliance coupler shall remain readily operable.
17. The airborne noise of the Apparatus does not exceed 70dB (A).
18. Apparatus with CLASS I construction shall be connected to a MAINS socket outlet with a protective earthing connection.
19. To reduce the risk of fire or electric shock, do not expose this apparatus to rain or moisture.
20. Do not attempt to modify this product. Doing so could result in personal injury and/or product failure.
21. Operate this product within its specified operating temperature range.

This symbol indicates that dangerous voltage constituting a risk of electric shock is present within this unit.

This symbol indicates that there are important operating and maintenance instructions in the literature accompanying this unit.

WARNING: Voltages in this equipment are hazardous to life. No user-serviceable parts inside. Refer all servicing to qualified service personnel. The safety certifications do not apply when the operating voltage is changed from the factory setting.

WARNING: This product contains a chemical known to the State of California to cause cancer and birth defects or other reproductive harm.

Free Manuals Download Website

<http://myh66.com>

<http://usermanuals.us>

<http://www.somanuals.com>

<http://www.4manuals.cc>

<http://www.manual-lib.com>

<http://www.404manual.com>

<http://www.luxmanual.com>

<http://aubethermostatmanual.com>

Golf course search by state

<http://golfingnear.com>

Email search by domain

<http://emailbydomain.com>

Auto manuals search

<http://auto.somanuals.com>

TV manuals search

<http://tv.somanuals.com>