

SHARP

MICRO COMPONENT SYSTEM

MODEL

XL-MP60

OPERATION MANUAL

COMPACT
disc
DIGITAL AUDIO

MP3

Thank you for purchasing this SHARP product.
To obtain the best performance from this product, please read this manual carefully. It will guide you in operating your SHARP product.

XL-MP60 Micro Component System consisting of XL-MP60 (main unit), CP-MP60F (front speakers) and CP-MP60SW (subwoofer).

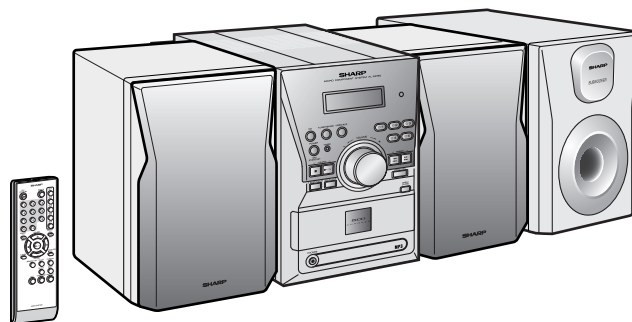

CD-R/RW
Playable 

5CD CHANGER

SPECIAL NOTES

Important Instruction



CAUTION
RISK OF ELECTRIC SHOCK
DO NOT OPEN



CAUTION: TO REDUCE THE RISK OF ELECTRIC SHOCK, DO NOT REMOVE COVER (OR BACK). NO USER-SERVICEABLE PARTS INSIDE. REFER SERVICING TO QUALIFIED SERVICE PERSONNEL.

Explanation of Graphical Symbols:



The lightning flash with arrowhead symbol, within an equilateral triangle, is intended to alert the user to the presence of uninsulated "dangerous voltage" within the product's enclosure that may be of sufficient magnitude to constitute a risk of electric shock to persons.



The exclamation point within an equilateral triangle is intended to alert the user to the presence of important operating and maintenance (servicing) instructions in the literature accompanying the appliance.

WARNING: TO REDUCE THE RISK OF FIRE OR ELECTRIC SHOCK, DO NOT EXPOSE THIS APPLIANCE TO RAIN OR MOISTURE.

Caution - use of controls or adjustments or performance of procedures other than those specified herein may result in hazardous radiation exposure.

Note:

This equipment has been tested and found to comply with the limits for a Class B digital device, pursuant to Part 15 of the FCC Rules. These limits are designed to provide reasonable protection against harmful interference in a residential installation.

This equipment generates, uses, and can radiate radio frequency energy and, if not installed and used in accordance with the instructions, may cause harmful interference to radio communications.

However, there is no guarantee that interference will not occur in a particular installation. If this equipment does cause harmful interference to radio or television reception, which can be determined by turning the equipment off and on, the user is encouraged to try to correct the interference by one or more of the following measures:

- Reorient or relocate the receiving antenna.
- Increase the separation between the equipment and receiver.
- Connect the equipment into an outlet on a circuit different from that to which the receiver is connected.
- Consult the dealer or an experienced radio/TV technician for help.

WARNING

FCC Regulations state that any unauthorized changes or modifications to this equipment not expressly approved by the manufacturer could void the user's authority to operate this equipment.

FOR YOUR RECORDS

For your assistance in reporting this unit in case of loss or theft, please record below the model number and serial number which are located on the rear of the unit.

Please retain this information.

Model number

Serial number

Date of purchase

Place of purchase

IMPORTANT SAFETY INSTRUCTIONS

- 1 Read Instructions** - All the safety and operating instructions should be read before the product is operated.
- 2 Retain Instructions** - The safety and operating instructions should be retained for future reference.
- 3 Heed Warnings** - All warnings on the product and in the operating instructions should be adhered to.
- 4 Follow Instructions** - All operating and use instructions should be followed.
- 5 Cleaning** - Unplug this product from the wall outlet before cleaning. Do not use liquid cleaners or aerosol cleaners. Use a damp cloth for cleaning.
- 6 Attachments** - Do not use attachments not recommended by the product manufacturer as they may cause hazards.
- 7 Water and Moisture** - Do not use this product near water - for example, near a bath tub, wash bowl, kitchen sink, or laundry tub; in a wet basement; or near a swimming pool; and the like.
- 8 Accessories** - Do not place this product on an unstable cart, stand, tripod, bracket, or table. The product may fall, causing serious injury to a child or adult, and serious damage to the product. Use only with a cart, stand, tripod, bracket, or table recommended by the manufacturer, or sold with the product. Any mounting of the product should follow the manufacturer's instructions, and should use a mounting accessory recommended by the manufacturer.
- 9** A product and cart combination should be moved with care. Quick stops, excessive force, and uneven surfaces may cause the product and cart combination to overturn.



- 10 Ventilation** - Slots and openings in the cabinet are provided for ventilation and to ensure reliable operation of the product and to protect it from overheating, and these openings must not be blocked or covered. The openings should never be blocked by placing the product on a bed, sofa, rug, or other similar surface. This product should not be placed in a built-in installation such as a bookcase or rack unless proper ventilation is provided or the manufacturer's instructions have been adhered to.
- 11 Power Sources** - This product should be operated only from the type of power source indicated on the marking label. If you are not sure of the type of power supply to your home, consult your product dealer or local power company. For products intended to operate from battery power, or other sources, refer to the operating instructions.
- 12 Grounding or Polarization** - This product may be equipped with a polarized alternating-current line plug (a plug having one blade wider than the other). This plug will fit into the power outlet only one way. This is a safety feature. If you are unable to insert the plug fully into the outlet, try reversing the plug. If the plug should still fail to fit, contact your electrician to replace your obsolete outlet. Do not defeat the safety purpose of the polarized plug.
Alternate Warnings - This product is equipped with a three-wire grounding-type plug, a plug having a third (grounding) pin. This plug will only fit into a grounding-type power outlet. This is a safety feature. If you are unable to insert the plug into the outlet, contact your electrician to replace your obsolete outlet. Do not defeat the safety purpose of the grounding-type plug.
- 13 Power-Cord Protection** - Power-supply cords should be routed so that they are not likely to be walked on or pinched by items placed upon or against them, paying particular attention to cords at plugs, convenience receptacles, and the point where they exit from the product.
- 14 Protective Attachment Plug** - The product is equipped with an attachment plug having overload protection. This is a safety feature. See Instruction Manual for replacement or resetting of protective device. If replacement of the plug is required, be sure the service technician has used a replacement plug specified by the manufacturer that has the same overload protection as the original plug.

IMPORTANT SAFETY INSTRUCTIONS (continued)

15 Outdoor Antenna Grounding - If an outside antenna or cable system is connected to the product, be sure the antenna or cable system is grounded so as to provide some protection against voltage surges and built-up static charges. Article 810 of the National Electrical Code, ANSI/NFPA 70, provides information with regard to proper grounding of the mast and supporting structure, grounding of the lead-in wire to an antenna discharge unit, size of grounding conductors, location of antenna discharge unit, connection to grounding electrodes, and requirements for the grounding electrode.

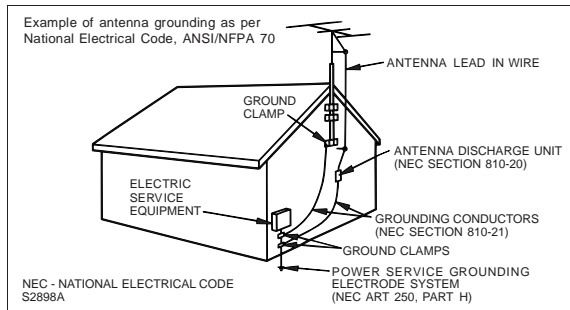

16 Lightning - For added protection for this product during a lightning storm, or when it is left unattended and unused for long periods of time, unplug it from the wall outlet and disconnect the antenna or cable system. This will prevent damage to the product due to lightning and power-line surges.

17 Power Lines - An outside antenna system should not be located in the vicinity of overhead power lines or other electric light or power circuits, or where it can fall into such power lines or circuits. When installing an outside antenna system, extreme care should be taken to keep from touching such power lines or circuits as contact with them might be fatal.

18 Overloading - Do not overload wall outlets, extension cords, or integral convenience receptacles as this can result in a risk of fire or electric shock.

19 Object and Liquid Entry - Never push objects of any kind into this product through openings as they may touch dangerous voltage points or short-out parts that could result in a fire or electric shock. Never spill liquid of any kind on the product.

20 Servicing - Do not attempt to service this product yourself as opening or removing covers may expose you to dangerous voltage or other hazards. Refer all servicing to qualified service personnel.

21 Damage Requiring Service - Unplug this product from the wall outlet and refer servicing to qualified service personnel under the following conditions:

- a) When the power-supply cord or plug is damaged,
- b) If liquid has been spilled, or objects have fallen into the product,
- c) If the product has been exposed to rain or water,
- d) If the product does not operate normally by following the operating instructions. Adjust only those controls that are covered by the operating instructions as an improper adjustment of other controls may result in damage and will often require extensive work by a qualified technician to restore the product to its normal operation,
- e) If the product has been dropped or damaged in any way, and
- f) When the product exhibits a distinct change in performance - this indicates a need for service.

22 Replacement Parts - When replacement parts are required, be sure the service technician has used replacement parts specified by the manufacturer or have the same characteristics as the original part. Unauthorized substitutions may result in fire, electric shock, or other hazards.

23 Safety Check - Upon completion of any service or repairs to this product, ask the service technician to perform safety checks to determine that the product is in proper operating condition.

24 Wall or Ceiling Mounting - The product should be mounted to a wall or ceiling only as recommended by the manufacturer.

25 Heat - The product should be situated away from heat sources such as radiators, heat registers, stoves, or other products (including amplifiers) that produce heat.

Contents

NOTES

- Licensed under one or more of U.S. Pat. 4,972,484, 5,214,678, 5,323,396, 5,530,655, 5,539,829, 5,544,247, 5,606,618, 5,610,985, 5,740,317, 5,777,992, 5,878,080 or 5,960,037.
- Supply of this product does not convey a license nor imply any right to distribute content created with this product in revenue-generating broadcast systems (terrestrial, satellite, cable and/or other distribution channels), revenue-generating streaming applications (via Internet, intranets and/or other networks), other revenue-generating content distribution systems (pay-audio or audio-on-demand applications and the like) or on revenue-generating physical media (compact discs, digital versatile discs, semiconductor chips, hard drives, memory cards and the like). An independent license for such use is required. For details, please visit <http://mp3licensing.com>.

MPEG Layer-3 audio coding technology licensed from Fraunhofer IIS and Thomson.

Accessories

Please confirm that the following accessories are included.

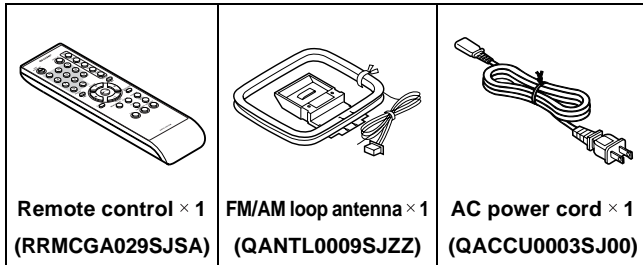

Caution:

Do not use the supplied AC power cord for other equipment. Fire or electric shock may result.

Note:

Only the above accessories are included.

	Page
General Information	
Precautions	6
Controls and indicators	7 - 9
Preparation for Use	
System connections	10 - 12
Remote control	13
Basic Operation	
General control	14
Setting the clock	15
Disc Playback	
Listening to a disc	16 - 18
Advanced disc playback	19 - 22
Radio	
Listening to the radio	23, 24
Advanced Features	
Timer and sleep operation	25 - 27
Enhancing your system	28
References	
Troubleshooting chart	29, 30
Maintenance	30
Specifications	31
CONSUMER LIMITED WARRANTY	Back cover

Precautions

■ General

- Please ensure that the equipment is positioned in a well-ventilated area and ensure that there is at least 4" (10 cm) of free space along the sides, top and back of the equipment.

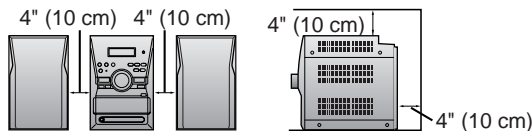

- Use the unit on a firm, level surface free from vibration.

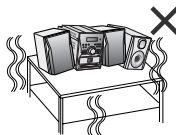

- Keep the unit away from direct sunlight, strong magnetic fields, excessive dust, humidity and electronic/electrical equipment (home computers, facsimiles, etc.) which generate electrical noise.



- Do not place anything on top of the unit.
- Do not expose the unit to moisture, to temperatures higher than 140°F (60°C) or to extremely low temperatures.
- If your system does not work properly, disconnect the AC power cord from the AC outlet. Plug the AC power cord back in, and then turn on your system.
- In case of an electrical storm, unplug the unit for safety.

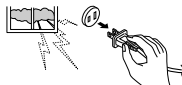

- Hold the AC power plug by the head when removing it from the AC outlet, as pulling the cord can damage internal wires.

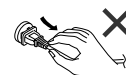

- Do not remove the outer cover, as this may result in electric shock. Refer internal service to your local SHARP service facility.

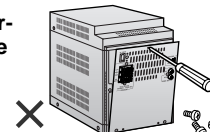

- This unit should only be used within the range of 41°F - 95°F (5°C - 35°C).

■ Warning:

The voltage used must be the same as that specified on this unit. Using this product with a higher voltage other than that which is specified is dangerous and may result in a fire or other type of accident causing damage. SHARP will not be held responsible for any damage resulting from use of this unit with a voltage other than that which is specified.

■ Volume control

The sound level at a given volume setting depends on speaker efficiency, location and various other factors. It is advisable to avoid exposure to high volume levels, which occurs while turning the unit on with the volume control setting up high, or while continually listening at high volumes.

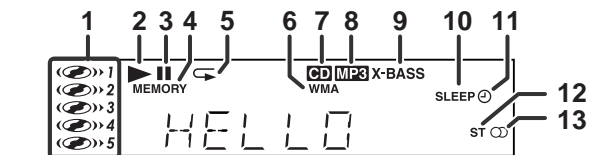
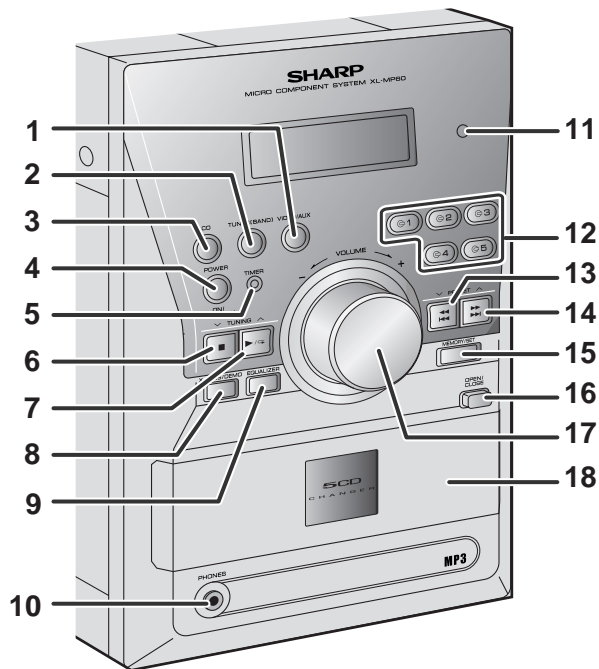

■ Front panel

Reference page

1. Video/Auxiliary Button	28
2. Tuner (Band) Button	23
3. CD Button	17
4. Power On/Stand-by Button	14
5. Timer Indicator	26
6. Disc Stop, Tuning Down Button	18, 23
7. Disc Play or Repeat, Tuning Up Button	17, 21, 23
8. Extra Bass/Demo Mode Button	12, 14
9. Equalizer Mode Select Button	14
10. Headphone Jack	28
11. Remote Sensor	13
12. Disc Number Select Buttons	20
13. Disc Track Down or Fast Reverse, Tuner Preset Down Button	18, 24
14. Disc Track Up or Fast Forward, Tuner Preset Up Button	18, 24
15. Memory/Set Button	22, 24
16. Disc Compartment Open/Close Button	17
17. Volume Control	14
18. Disc Compartment	17

■ Display

Reference page

1. Disc Number Indicators	20
2. Disc Play Indicator	17
3. Disc Pause Indicator	18
4. Memory Indicator	22
5. Disc Repeat Play Indicator	21
6. WMA Track Indicator	17
7. CD Indicator	17
8. MP3 Track Indicator	17
9. Extra Bass Indicator	14
10. Sleep Indicator	27
11. Timer Play Indicator	25
12. FM Stereo Mode Indicator	23
13. FM Stereo Receiving Indicator	23

Controls and indicators (continued)

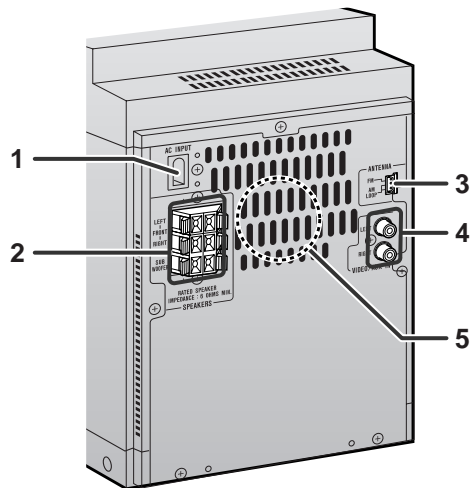

■ Rear panel

Reference page

- 1. AC Power Input Jack 12
- 2. Speaker Terminals 11
- 3. FM/AM Loop Antenna Jack 11
- 4. Video/Auxiliary (Audio Signal) Input Jacks 28
- 5. Cooling Fan 12

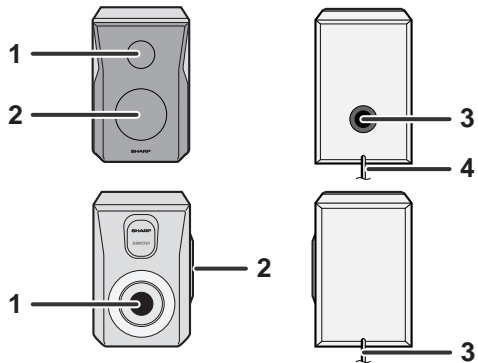

■ Front speaker

- 1. Tweeter
- 2. Woofers
- 3. Bass Reflex Duct
- 4. Speaker Wire

■ Subwoofer

- 1. Sub Duct Pipe
- 2. Subwoofer
- 3. Speaker Wire

Note:

The speaker grilles are not removable.

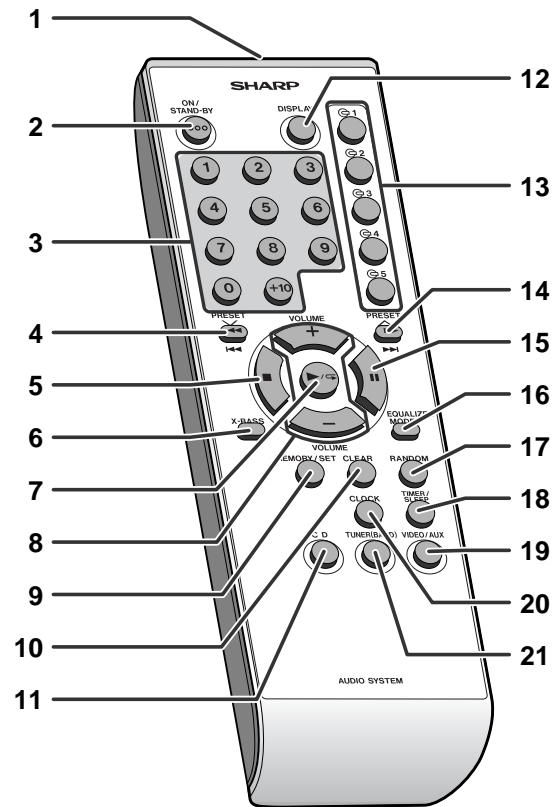

■ Remote control

Reference page

1. Remote Control Transmitter	13
2. Power On/Stand-by Button	14
3. Direct Track Search Buttons	20
4. Disc Track Down or Fast Reverse, Tuner Preset Down, Time Down Button	15, 18, 24
5. Disc Stop Button	18
6. Extra Bass Button	14
7. Disc Play or Repeat Button	17, 21
8. Volume Up and Down Buttons	14
9. Memory/Set Button	15, 22, 24, 25, 27
10. Disc Clear Button	22
11. CD Button	17
12. MP3/WMA Display Button	19
13. Disc Number Select Buttons	20
14. Disc Track Up or Fast Forward, Tuner Preset Up, Time Up Button	15, 18, 24
15. Disc Pause Button	18
16. Equalizer Mode Select Button	14
17. Disc Random Button	21
18. Timer/Sleep Button	25, 27
19. Video/Auxiliary Button	28
20. Clock Button	15
21. Tuner (Band) Button	23

System connections

Make sure to unplug the AC power cord before any connections.

■ FM/AM loop antenna connection (see page 11)

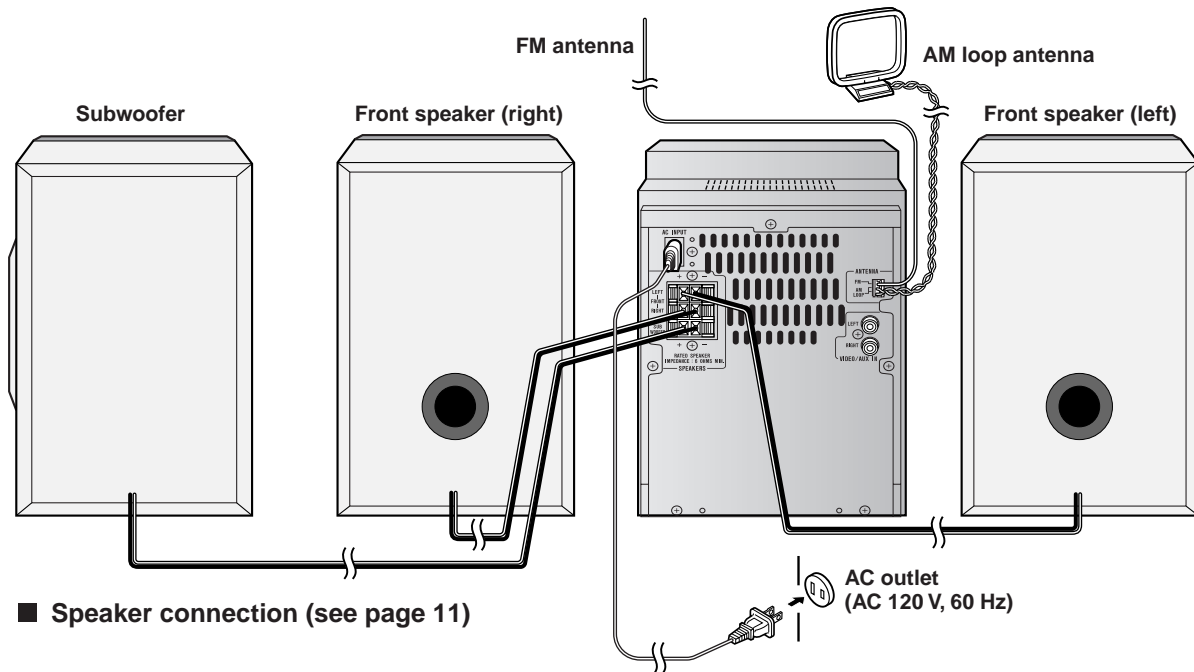

■ Speaker connection (see page 11)

■ Connecting the AC power cord (see page 12)

■ Speaker connection

Connect the black wire to the minus (-) terminal, and the red wire to the plus (+) terminal.

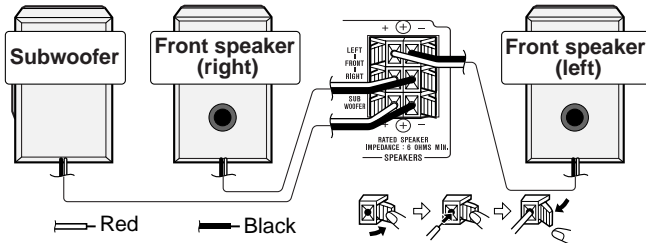

Caution:

- Use speakers with an impedance of 6 ohms or more, as lower impedance speakers can damage the unit.
- Do not mistake the right and the left channels. The right speaker is the one on the right side when you face the unit.
- **Do not let the bare speaker wires touch each other.**
- Do not allow any objects to fall into or to be placed in the bass reflex ducts.
- Do not stand or sit on the speakers. You may be injured.

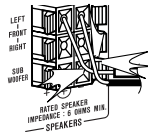

Incorrect

Notes:

- The speakers are magnetically shielded. Therefore, they do not affect the display even if you use them near the TV. However, some color variation may occur, depending on the type of TV used.

If color variation occurs...

Turn off the TV (from the power switch).
After 15 - 30 minutes, turn the TV on again.

If the color variation is still present...

Move the speakers further away from the TV.

- If any kind of magnet or an electromagnet is placed too close to the TV and the system, irregular colors may appear on the TV screen.

■ FM/AM loop antenna connection

Connect the FM/AM loop antenna to the ANTENNA jack.

Position the FM antenna wire and rotate the AM loop antenna for optimum reception. Place the AM loop antenna on a shelf, or attach it to a stand or a wall.

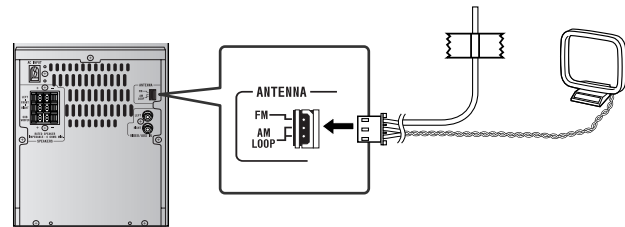

Notes:

- Placing the antenna on the stereo system or near the AC power cord may cause noise pickup. Place the antenna away from the stereo system for better reception.
- Do not connect the attached FM antenna to an external antenna as this may cause trouble.

Installing the AM loop antenna:

< Assembling >

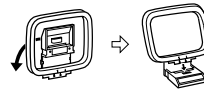

< Attaching to the wall >

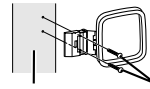

Wall Screws (not supplied)

System connections (continued)

■ Connecting the AC power cord

After checking all the connections have been made correctly, connect the AC power cord to the AC power input jack, then plug the AC power cord of this unit into the AC outlet. If you plug in the unit first, the unit will enter the demonstration mode.

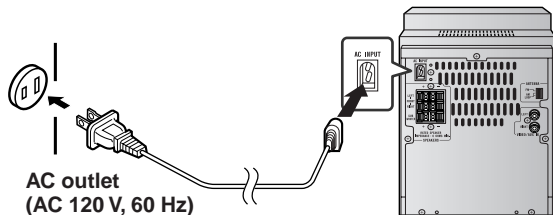

Notes:

- Never use a power cord other than the one supplied. Otherwise, a malfunction or an accident may occur.
- Unplug the AC power cord from the AC outlet if the unit will not be in use for a prolonged period of time.

Cooling fan:

This product is equipped with a cooling fan inside for better heat radiation.

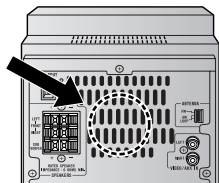

■ Demonstration mode

When you plug the unit in for the first time, the unit will enter the demonstration mode. You will see words scroll.



To cancel the demonstration mode:

When the unit is in the power stand-by mode (demonstration mode), press the X-BASS/DEMO button. The unit will enter the low power consumption mode.

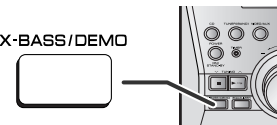

To return to the demonstration mode:

When the unit is in the power stand-by mode, press the X-BASS/DEMO button again.

Note:

When the power is on, the X-BASS/DEMO button can be used to select the extra bass mode.

Remote control

■ Battery installation

Use 2 "AA" size batteries (UM/SUM-3, R6, HP-7 or similar).
Batteries are not included.

- 1 Remove the battery cover.
- 2 Insert the batteries according to the direction indicated in the battery compartment.
When inserting or removing the batteries, push them toward the ⊖ battery terminals.
- 3 Replace the cover.

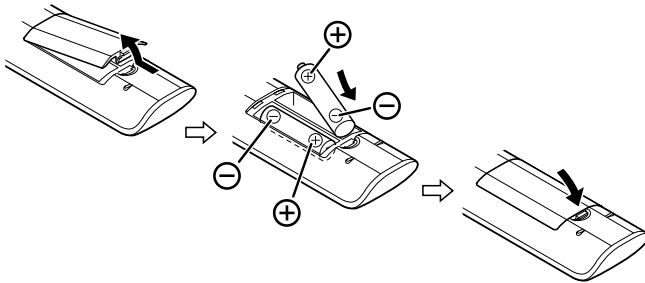

Precautions for battery use:

- Replace all old batteries with new ones at the same time.
- Do not mix old and new batteries.
- Remove the batteries if the unit will not be used for long periods of time. This will prevent potential damage due to battery leakage.

Caution:

- Do not use rechargeable batteries (nickel-cadmium battery, etc.).
- Installing the batteries incorrectly may cause the unit to malfunction.

Battery removal:

Remove the battery cover. Push each battery toward the ⊖ battery terminal and take them out.

Notes concerning use:

- Replace the batteries if the operating distance is reduced or if the operation becomes erratic.
- Periodically clean the transmitter on the remote control and the sensor on the unit with a soft cloth.
- Exposing the sensor on the unit to strong light may interfere with operation. Change the lighting or the direction of the unit if this occurs.
- Keep the remote control away from moisture, heat, shock, and vibrations.

■ Test of the remote control

Check the remote control after checking all the connections (see pages 10 - 12).
Point the remote control directly at the remote sensor on the unit.

The remote control can be used within the range shown below:

Press the ON/STAND-BY button. Does the power turn on? Now, you can enjoy music.

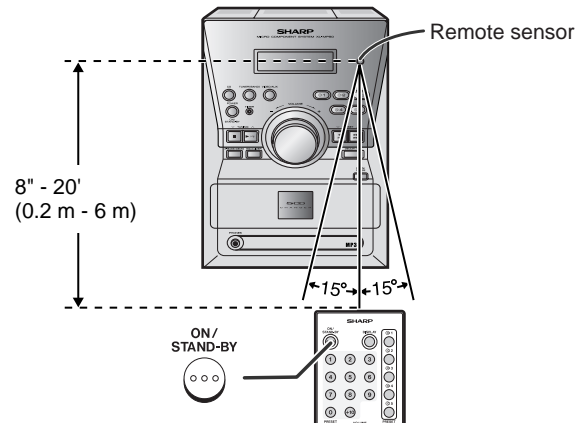

General control

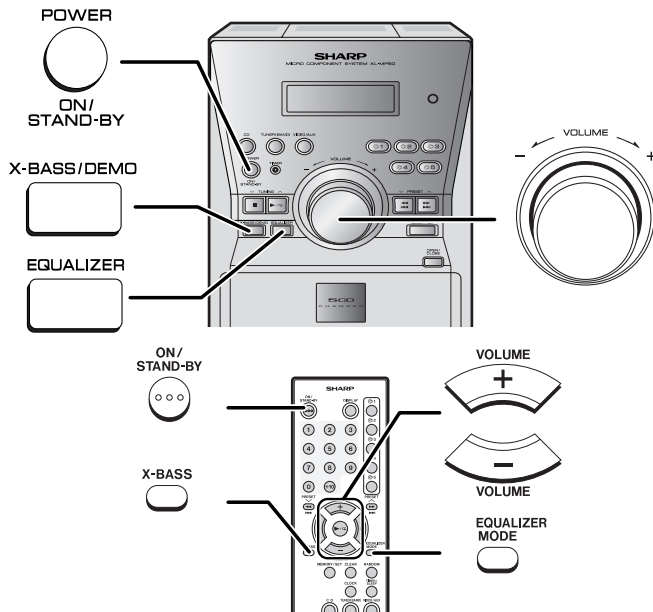

■ To turn the power on

Press the ON/STAND-BY button to turn the power on.

After use:

Press the ON/STAND-BY button to enter the power stand-by mode.

■ Volume control

Main unit operation:

When the VOLUME control is turned clockwise, the volume will increase. When it is turned counterclockwise, the volume will decrease.

Remote control operation:

Press the VOLUME (+ or -) button to increase or decrease the volume.

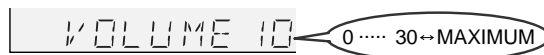

■ Bass control (X-BASS)

When the power is first turned on, the unit will enter the extra bass mode which emphasizes the bass frequencies, and "X-BASS" will appear. To cancel the extra bass mode, press the X-BASS/DEMO (X-BASS) button.

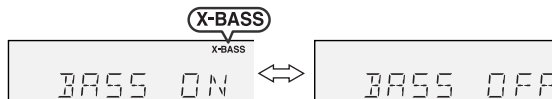

■ Equalizer

When the EQUALIZER (EQUALIZER MODE) button is pressed, the current mode setting will be displayed. To change to a different mode, press the EQUALIZER (EQUALIZER MODE) button repeatedly until the desired sound mode appears.

- FLAT The sound is not modified.
- ↓
- ROCK Bass and treble are emphasized.
- ↓
- CLASSIC Treble is cut a little.
- ↓
- POPS Bass and treble are slightly emphasized.
- ↓
- VOCAL Vocals (midrange tones) are emphasized.
- ↓
- JAZZ Treble is slightly emphasized.

Setting the clock

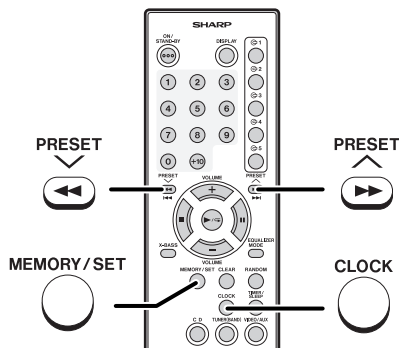

In this example, the clock is set for the 12-hour (AM 12:00) display.

- 1 Press the CLOCK button and within 8 seconds, press the MEMORY/SET button.**



- 2 Within 30 seconds, press the PRESET (∨ or ^) button to select 12-hour or 24-hour display and then press the MEMORY/SET button.**

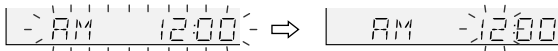

- "AM 12:00" → The 12-hour display will appear.
(AM 12:00 - PM 11:59)
- "0:00" → The 24-hour display will appear.
(0:00 - 23:59)

- 3 Within 30 seconds, press the PRESET (∨ or ^) button to adjust the hour and then press the MEMORY/SET button.**

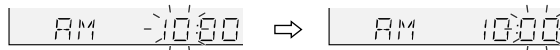

Press the PRESET (∨ or ^) button once to advance the time by 1 hour. Hold it down to advance continuously.

- 4 Within 30 seconds, press the PRESET (∨ or ^) button to adjust the minutes and then press the MEMORY/SET button.**



Press the PRESET (∨ or ^) button once to advance the time by 1 minute. Hold it down to advance continuously.

To confirm the time display:

Press the CLOCK button.

The time display will appear for about 8 seconds.



Note:

The "CLOCK" or time will flash at the push of the CLOCK button when the AC power supply is restored after a power failure or unplugging the unit.

Readjust the clock as follows.

To readjust the clock:

Perform "Setting the clock" from step 1. If the "CLOCK" is not flashing in step 1, step 2 (for selecting the 12-hour or 24-hour display) will be skipped.

To change the 12-hour or 24-hour display:

- 1 Clear all the programmed contents. [Refer to "Clearing all the memory (reset)" on page 30 for details.]
- 2 Perform "Setting the clock" from step 1.

Listening to a disc

This system can play back a standard CD, CD-R/RW in the CD format and CD-R/RW with MP3 or WMA files, but cannot record on them.

Some audio CD-R and CD-RW discs may not be playable due to the state of the disc or the equipment used for recording.

CD:

The CD indicator will light up when a normal CD is loaded.

MP3:

MP3 is a form of compression. It is an acronym which stands for MPEG Audio Layer 3.

MP3 is a type of audio code which is processed by significant compression from the original audio source with very little loss in sound quality.

- The MP3 track indicator will light up when an MP3 track is read.
- This system supports MPEG 1 Layer 3, MPEG 2 Layer 3, and VBR files.
- During VBR file playback, time counter in the display may differ from its actual playback time.

WMA:

WMA files are ASF (Advanced Systems Format) audio files which are compressed with Windows Media Audio codec. WMA is developed by Microsoft as an audio format file for Windows Media Player.

- The WMA track indicator will light up when a WMA track is read.
- Supported bit rates for WMA files range from 64 kbps to 160 kbps.

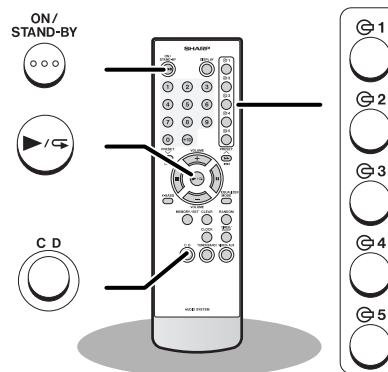
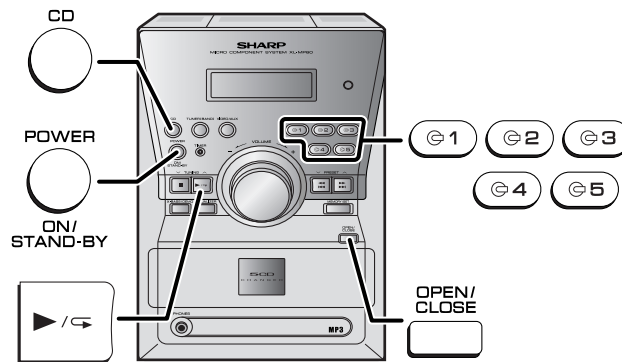

1 Press the ON/STAND-BY button to turn the power on.

2 Press the CD button.

3 Press the OPEN/CLOSE button to open the disc compartment.

All trays open in tiers.

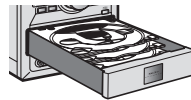

4 Place the disc on the disc tray 1, label side up.

Be sure to place 3" (8 cm) discs in the middle of the disc trays.

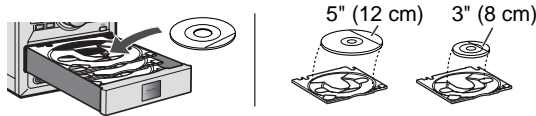

5 To place discs in the trays 2 - 5

1. Slide in the tray with a disc toward the unit.



2. Place a disc in an empty tray.

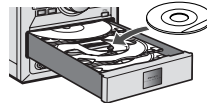

6 Press the OPEN/CLOSE button to close the disc compartment.

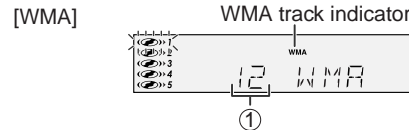
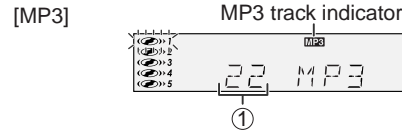
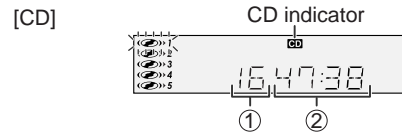

- ① Total number of tracks on the disc whose number is flashing.
- ② Total playing time of the CD whose number is flashing.

7 Press the ► / ◀ button to start playback.

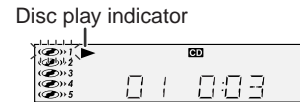

- Playback will begin from track 1 on disc 1. After that disc finishes playing, the next disc will automatically play.
- After the last track on the fifth disc is played, the CD player stops automatically.
- When there is no disc in one of the disc trays (1 - 5), the empty tray will be skipped to the next tray with a disc.
- Due to the structure of the disc information, it takes longer (approximately 20 to 90 seconds) to read a CD-R/RW disc recorded in the MP3 or WMA format than a normal CD.

Listening to a disc (continued)

To remove the discs:

- In the stop mode, press the OPEN/CLOSE button.
 - All trays open in tiers.
- Remove the disc in the tray 1.
- Slide in the tray 1 toward the unit. In the same way, remove discs in the trays 2 - 5.
- After removing the discs, press the OPEN/CLOSE button again.



















To specify a tray to open:

- In the stop mode, press the Ⓞ1 - Ⓞ5 button.
- Press the OPEN/CLOSE button.
- Remove the disc, then press the OPEN/CLOSE button again.

Caution:

- Do not place two discs in one disc tray.
- Do not play discs with special shapes (heart or octagon shaped) as it may cause malfunctions.
- Do not push the disc compartment while it is moving.
- If the power fails while the disc compartment is open, wait until the power is restored.
- If the disc compartment is stopped with force, the unit will not function. If this occurs, press the ON/STAND-BY button to enter the power stand-by mode and then turn the power on again.
- If TV or radio interference occurs during disc operation, move the unit away from it.
- If a disc is damaged, dirty, or loaded upside down, the disc will skip or not play.

■ Various disc functions

Function	Main unit	Remote control	Operation
Play 			Press in the stop mode.
Stop 			Press in the playback mode.
Pause 	—		Press in the playback mode. Press the ► / ◀ button to resume playback from the paused point.
Track up/ Track down	 	 	Press in the playback or stop mode. If you press the button in the stop mode, press the ► / ◀ button to start the desired track.
Fast forward/ Fast reverse	 	 	Press and hold down in the playback mode. Release the button to resume playback.

Notes:

- Track up/track down and fast forward/fast reverse are possible only within one disc.
- When the end of the last track is reached during fast forward, "×× END" will appear on the display and disc operation will be paused. When the beginning of the first track is reached during fast reverse, the unit will enter the playback mode.
(××: Last track number)
- CD sound is heard during fast forward/fast reverse, except for CD-R/RW in the MP3 or WMA format. (Check elapsed time on the display.)

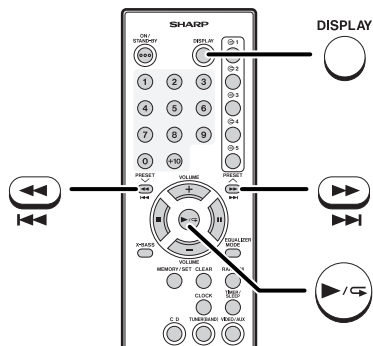

- **To select the desired folder or track by name (CD-R/RW discs recorded in the MP3 or WMA format only)**

<p>1 While in the stop mode, press the DISPLAY button on the remote control to display the folder name.</p>	
<p>2 Select the desired folder by pressing the ◀◀ or ▶▶ button.</p>	
<p>3 Press the DISPLAY button to display the track name.</p>	
<p>4 Select the desired track by pressing the ◀◀ or ▶▶ button.</p>	
<p>5 Press the ▶ / ⏸ button to begin playback.</p>	

- **To change the display (CD-R/RW discs recorded in the MP3 or WMA format only)**

While in the stop mode or playback mode, press the DISPLAY button.

Each time the button is pressed, the display will change as follows.

[When in the stop mode]

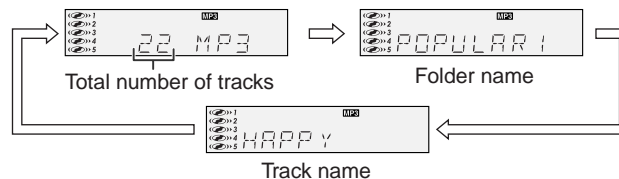

[When in the playback mode]

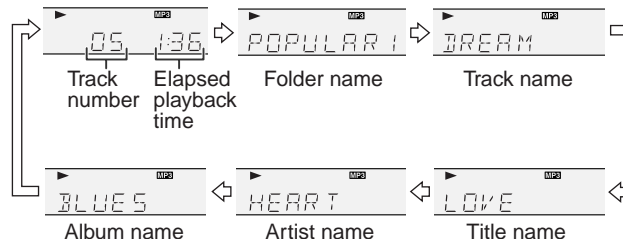

Advanced disc playback (continued)

■ To play from a specified disc

You can start playback from the desired disc by selecting the number.

1 Press one of the 1 - 5 buttons to select the desired disc.

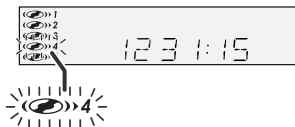

Selected disc number

2 Press the button.

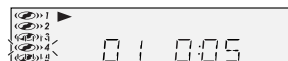

- Playback will begin from track 1 on the chosen disc. After that disc finished playing the next disc automatically play.
- After the last track on the fifth disc is played, the CD player stops automatically.

Note:

If a disc tray with no disc is selected, playback will not start and the disc indicator will go out.

To stop playback:

Press the button.

■ Direct track search

By using the direct search buttons, the desired tracks on the current disc can be played.

Use the direct search buttons on the remote control to select the desired track while playing the selected disc.



Selected track number

- The direct search buttons allow you to select up to number 9.
- When selecting number 10 or higher, use the +10 button.

A. For example, to choose 13

- 1 Press the "+10" button once.
- 2 Press the "3" button.

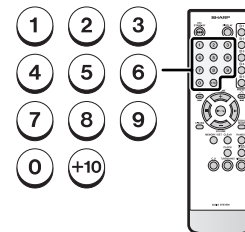

B. For example, to choose 30

- 1 Press the "+10" button three times.
- 2 Press the "0" button.

If the direct search buttons are pressed while the disc is stopped, press the button to start the desired track on the current disc.

Notes:

- A track number higher than the number of tracks on the disc cannot be selected.
- During random play, direct search is not possible.
- For CD-R/RW discs recorded in the MP3 or WMA format, you can select the track number but cannot select the folder by pressing the direct search buttons.

■ Repeat play

You can play up to 5 discs, or programmed tracks continuously.

To repeat all tracks on up to 5 discs:

Press the ► / ◀ button twice.



To repeat desired tracks:

Perform steps 1 - 4 in the "Programmed play" section on page 22 and then press the ► / ◀ button twice.

To repeat random play:

Press the ► / ◀ button during random play.

To cancel repeat play:

Press the ► / ◀ button again.
"C" will go out.

Caution:

After performing repeat play, be sure to press the ■ button. Otherwise, the disc(s) will play continuously.

■ Random play

The tracks on the disc(s) can be played in random order automatically.

To random play all tracks on up to 5 discs:

Press the RANDOM button on the remote control.

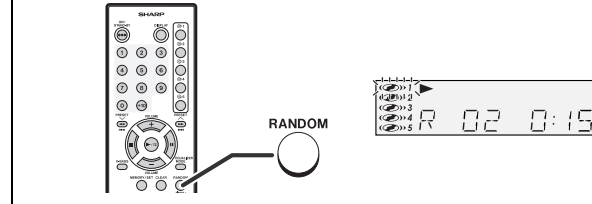

To cancel random play:

Press the ■ button.
"R" will go out.

Notes:

- Random play will stop automatically when all tracks are played once. (The same track will not be played back twice.)
- If you press the ►► button during random play, you can move to the next track by the random operation. On the other hand, the ◀◀ button does not allow you to move to the previous track. The beginning of the track being played will be located.
- In random play, the CD player will select and play tracks automatically. (You cannot select the order of the tracks.)

Advanced disc playback (continued)

■ Programmed play

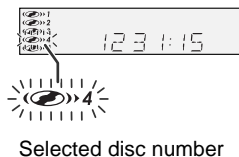

You can choose up to 32 selections for playback in the order you like.

- 1 While in the stop mode, press one of the  -  buttons to select the desired disc.



Selected disc number

- 2 Press the direct search buttons on the remote control to select the desired track.

You can also select a track by pressing the  or  button.

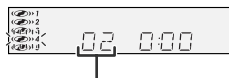

Selected track number

- 3 Press the MEMORY/SET button to save the track number.



- 4 Repeat steps 1 - 3 for other tracks. Up to 32 tracks can be programmed.

- 5 Press the  button to start playback.

To clear the programmed selections:

While the "MEMORY" indicator is lit, set the CD to the stop mode and then press the CLEAR button. Each time the button is pressed, one track will be cleared, beginning with the last track programmed.

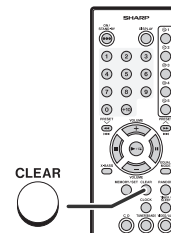

Adding tracks to the program:

If a program has been previously stored, the "MEMORY" indicator will be displayed. Then follow steps 1 - 3 to add tracks. The new tracks will be stored after the last track of the original program.

Notes:

- Opening the disc compartment automatically cancels the programmed sequence.
- If you press the ON/STAND-BY button to enter the stand-by mode or change the function from CD to another, the programmed selections will not be cleared.
- During the program operation, random play is not possible.
- For CD-R/RW discs recorded in the MP3 or WMA format, you can select the track number but cannot select the folder by pressing the direct search buttons.

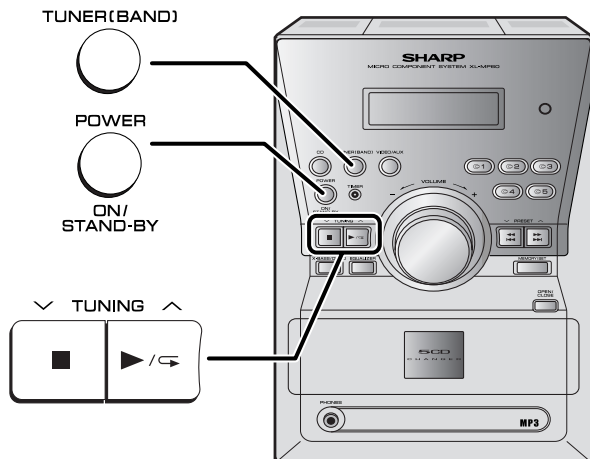

■ Tuning

- 1** Press the ON/STAND-BY button to turn the power on.
- 2** Press the TUNER (BAND) button repeatedly to select the desired frequency band (FM or AM).
- 3** Press the TUNING (∨ or ∧) button to tune in to the desired station.

Manual tuning:

Press the TUNING button as many times as required to tune in to the desired station.

Auto tuning:

When the TUNING button is pressed for more than 0.5 seconds, scanning will start automatically and the tuner will stop at the first receivable broadcast station.

Notes:

- When radio interference occurs, auto scan tuning may stop automatically at that point.
- Auto scan tuning will skip weak signal stations.
- To stop the auto tuning, press the TUNING button again.

To receive an FM stereo transmission:

Press the TUNER (BAND) button to display the "ST" indicator.

- "∞" will appear when an FM broadcast is in stereo.
- If the FM reception is weak, press the TUNER (BAND) button to extinguish the "ST" indicator. The reception changes to monaural, and the sound becomes clearer.

FM stereo mode indicator

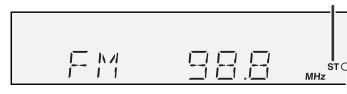

FM stereo receiving indicator

Listening to the radio (continued)

■ Memorizing a station

You can store 40 AM and FM stations in memory and recall them at the push of a button. (Preset tuning)

1 Perform steps 1 - 3 in "Tuning" on page 23.

2 Press the MEMORY/SET button to enter the preset tuning saving mode.

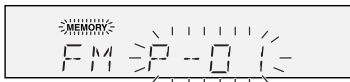

3 Within 30 seconds, press the PRESET (∨ or ∧) button to select the preset channel number.

Store the stations in memory, in order, starting with preset channel 1.

4 Within 30 seconds, press the MEMORY/SET button to store that station in memory.

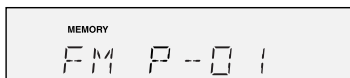

If the "MEMORY" and preset number indicators go out before the station is memorized, repeat the operation from step 2.

5 Repeat steps 1 - 4 to set other stations, or to change a preset station.

When a new station is stored in memory, the station previously memorized will be erased.

Note:

The backup function protects the memorized stations for a few hours should there be a power failure or the AC power cord get disconnected.

■ To recall a memorized station

Press the PRESET (∨ or ∧) button for less than 0.5 seconds to select the desired station.

■ To scan the preset stations

The stations saved in memory can be scanned automatically. (Preset memory scan)

- 1 Press the PRESET (∨ or ∧) button for more than 0.5 seconds. The preset number will flash and the programmed stations will be tuned in sequentially, for 5 seconds each.
- 2 Press the PRESET (∨ or ∧) button again when the desired station is located.

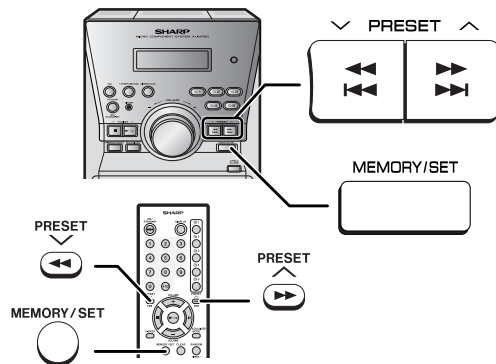

■ To erase entire preset memory

- 1 Press the ON/STAND-BY button to enter the stand-by mode.
- 2 While pressing down the TUNER(BAND) button and the ② button, press the ON/STAND-BY button until "TUNER CL" appears.

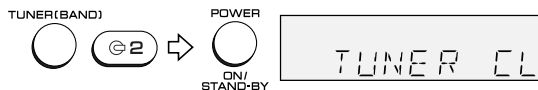

Timer and sleep operation

Timer playback:

The unit turns on and plays the desired source (CD, tuner) at the preset time.

Sleep operation:

The radio and compact disc can all be turned off automatically.

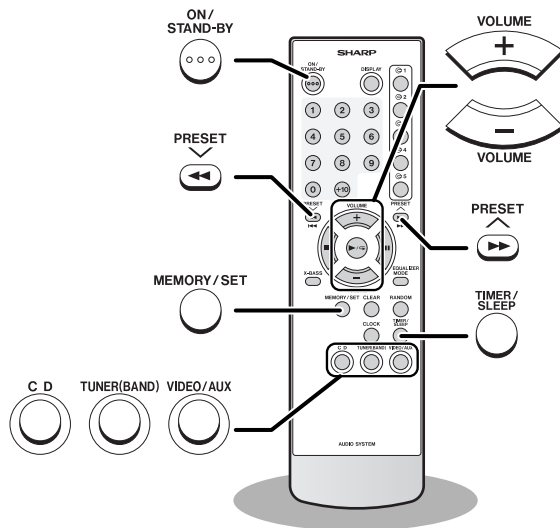

■ Timer playback

Before setting timer:

- 1 Press the CLOCK button to check that the clock is set to the correct time. (Refer to page 15.)
- 2 Load the discs to be played.



- 1 Press the ON/STAND-BY button to turn the power on.
- 2 Press the CD or TUNER (BAND) button to select the desired function.
When you select the TUNER (BAND), tune into the desired station.
- 3 Adjust the volume using the VOLUME buttons.
Do not turn the volume up too high.
- 4 Press the TIMER/SLEEP button repeatedly until "Ⓜ" is displayed and then within 8 seconds, press the MEMORY/SET button.



- 5 Within 30 seconds, press the PRESET (∨ or ∧) button to specify the hour to start, then press the MEMORY/SET button.

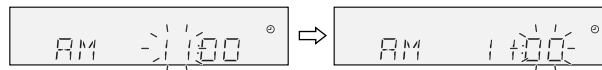

Continued to the next page

Timer and sleep operation (continued)

- 6** Within 30 seconds, press the PRESET (∨ or ∧) button to specify the minute to start, then press the MEMORY/SET button.

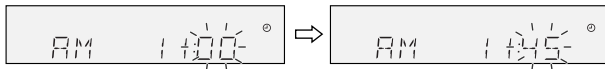

- Settings are displayed in order and the unit will enter the timer stand-by mode.
- Timer set indicator will light up.

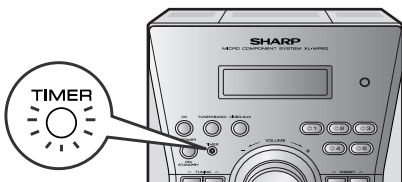

To cancel the timer playback:

Press the ON/STAND-BY button to turn the power on.

- 7** When the preset time is reached, playback will start.

The volume will increase gradually until it reaches the volume you were listening to before your system entered the timer stand-by mode.

- 8** The unit will enter the power stand-by mode one hour after the timer playback starts.

To reset or change the timer setting:

Perform "Timer playback" from the beginning.

Note:

When performing timer playback using another unit connected to the VIDEO/AUX IN jacks, select "VIDEO/AUX" in step 2.

At this time, only this unit will be turned on or enter the power stand-by mode automatically. It will enter the power stand-by mode 1 hour after the playback starts. However, the other unit will not be turned on or off.

■ Sleep operation

- 1 Play back the desired sound source.
- 2 Press the **TIMER/SLEEP** button repeatedly until "SLEEP" is displayed and then within 8 seconds, press the **MEMORY/SET** button.

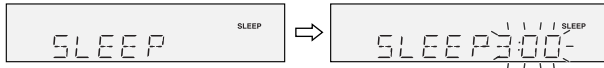

To change the sleep time:

While the sleep time is displayed, press the **PRESET** (∨ or ∧) button.

(Maximum: 3 hours - Minimum: 5 minutes)

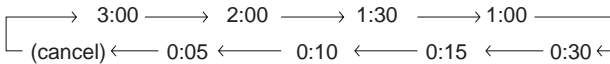

- 3 Within 30 seconds, press the **MEMORY/SET** button.
- 4 The unit will enter the power stand-by mode automatically after the preset time has elapsed.
The volume will be turned down 30 seconds before the sleep operation finishes.

To confirm the remaining sleep time:

Press the **TIMER/SLEEP** button while the sleep timer is set. The remaining sleep time is displayed for about 8 seconds.

To cancel the sleep operation:

Press the **ON/STAND-BY** button while the sleep timer is set.

■ To use timer and sleep operation together

Example: To fall asleep and wake up to the same radio station You can play back the same source only (the function cannot be switched).

- 1 Set the sleep time (see left, steps 1 - 3).
- 2 While the sleep timer is set, set the timer playback (steps 4 - 6, pages 25 - 26).

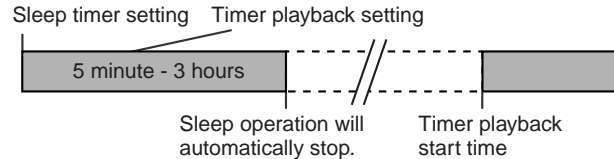

Enhancing your system

The connection cord is not included. Purchase a commercially available cord as shown below.

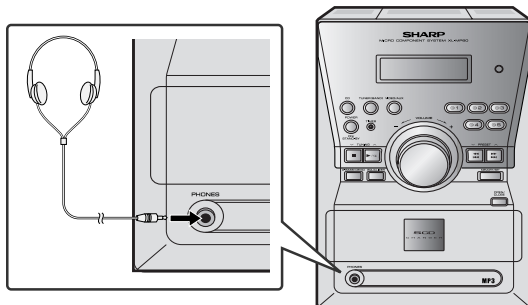
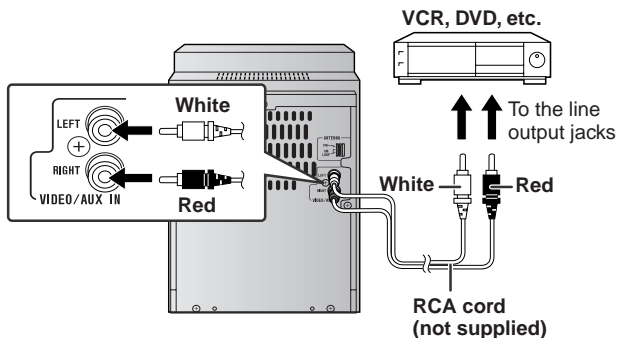

■ Listening to the playback sounds from VCR, DVD, etc.

- 1 Use a connection cord to connect the VCR, DVD, etc. to the VIDEO/AUX IN jacks.

When using video equipment, connect the audio output to this unit and the video output to a television.

- 2 Press the ON/STAND-BY button to turn the power on.
- 3 Press the VIDEO/AUX button.
- 4 Play the connected equipment.

Note:

To prevent noise interference, place the unit away from the television.

■ Headphones

- Before plugging in or unplugging the headphones, reduce the volume.
- Be sure your headphones have a 1/8" (3.5 mm) diameter plug and impedance between 16 and 50 ohms. The recommended impedance is 32 ohms.
- Plugging in the headphones disconnects the speakers automatically. Adjust the volume using the VOLUME control.

Troubleshooting chart

Many potential problems can be resolved by the owner without calling a service technician.

If something is wrong with this product, check the following before calling your authorized SHARP dealer or service center.

■ General

Symptom	Possible cause
<ul style="list-style-type: none">● The clock is not set to the correct time.	<ul style="list-style-type: none">● Did a power failure occur? Reset the clock. (Refer to page 15.)
<ul style="list-style-type: none">● When a button is pressed, the unit does not respond.	<ul style="list-style-type: none">● Set the unit to the power standby mode and then turn it back on.● If the unit still malfunctions, reset it. (Refer to page 30.)
<ul style="list-style-type: none">● No sound is heard.	<ul style="list-style-type: none">● Is the volume level set to "0"?● Are the headphones connected?● Are the speaker wires disconnected?

■ CD player

Symptom	Possible cause
<ul style="list-style-type: none">● Playback does not start.● Playback stops in the middle or is not performed properly.	<ul style="list-style-type: none">● Is the disc loaded upside down?● Does the disc satisfy the standards?● Is the disc distorted or scratched?
<ul style="list-style-type: none">● Playback sounds are skipped, or stopped in the middle of a track.	<ul style="list-style-type: none">● Is the unit located near excessive vibrations?● Is the disc very dirty?● Has condensation formed inside the unit?

■ Remote control

Symptom	Possible cause
<ul style="list-style-type: none">● The remote control does not operate.	<ul style="list-style-type: none">● Is the AC power cord of the unit plugged in?● Is the battery polarity correct?● Are the batteries dead?● Is the distance or angle incorrect?● Does the remote control sensor receive strong light?

■ Tuner

Symptom	Possible cause
<ul style="list-style-type: none">● The radio makes unusual noises continuously.	<ul style="list-style-type: none">● Is the unit placed near the TV or computer?● Is the FM antenna or AM loop antenna placed properly? Move the antenna away from the AC power cord if it's located nearby.

■ Condensation

Sudden temperature changes, storage or operation in an extremely humid environment may cause condensation inside the cabinet (CD pickup, etc.) or on the transmitter on the remote control. Condensation can cause the unit to malfunction. If this happens, leave the power on with no disc in the unit until normal playback is possible (about 1 hour). Wipe off any condensation on the transmitter with a soft cloth before operating the unit.

Troubleshooting chart (continued)

■ If trouble occurs

When this product is subjected to strong external interference (mechanical shock, excessive static electricity, abnormal supply voltage due to lightning, etc.) or if it is operated incorrectly, it may malfunction.

If such a problem occurs, do the following:

- 1 Set the unit to the stand-by mode and turn the power on again.
- 2 If the unit is not restored in the previous operation, unplug and plug in the unit, and then turn the power on.

Note:

If neither operation above restores the unit, clear all the memory by resetting it.

■ Clearing all the memory (reset)

- 1 Press the ON/STAND-BY button to enter the power stand-by mode.
- 2 While pressing down the CD button and the $\odot 2$ button, press the ON/STAND-BY button until "CLEAR" appears.

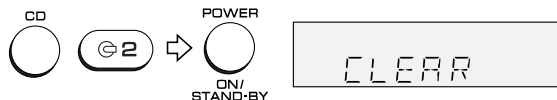

Caution:

This operation will erase all data stored in memory including clock, timer settings, tuner preset, and CD program.

■ Before transporting the unit

Remove all discs from the unit. Make sure there is no disc in the disc tray. Then, set the unit to the power stand-by mode. Carrying the unit with discs left inside can damage the unit.

■ Care of compact discs

Discs are fairly resistant to damage, however mistracking can occur due to an accumulation of dirt on the disc surface. Follow the guidelines below for maximum enjoyment from your disc collection and player.

- Do not write on either side of the disc, particularly the non-label side from which signals are read. Do not mark this surface.
- Keep your discs away from direct sunlight, heat, and excessive moisture.
- Always hold the discs by the edges. Fingerprints, dirt, or water on the discs can cause noise or mistracking. If a disc is dirty or does not play properly, clean it with a soft, dry cloth, wiping straight out from the center, along the radius.

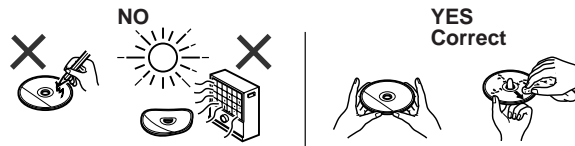

Maintenance

■ Cleaning the CD pickup lens

In order to ensure proper operation of the CD player, preventative maintenance (cleaning of the laser pickup lens) should be performed periodically. Lens cleaners are commercially available. Contact your local CD software dealer for options.

■ Cleaning the cabinet

Periodically wipe the cabinet with a soft cloth and a diluted soap solution, then with a dry cloth.

Caution:

- Do not use chemicals for cleaning (gasoline, paint thinner, etc.). It may damage the cabinet finish.
- Do not apply oil to the inside of the unit. It may cause malfunctions.

Specifications

As part of our policy of continuous improvement, SHARP reserves the right to make design and specification changes for product improvement without prior notice. The performance specification figures indicated are nominal values of production units. There may be some deviations from these values in individual units.

■ General

Power source	AC 120 V, 60 Hz
Power consumption	121 W
Dimensions	Width: 6-5/16" (160 mm) Height: 9-7/16" (240mm) Depth: 12-9/16" (319mm)
Weight	11.5 lbs. (5.2 kg)

■ Amplifier

Output power	Front speakers: 37.5 watts minimum RMS per channel into 6 ohms from 100 Hz to 20 kHz, 10% total harmonic distortion Subwoofer: 45 watts minimum RMS into 6 ohms from 70 Hz to 130 Hz, 10% total harmonic distortion
Output terminals	Front speakers and subwoofer: 6 ohms Headphones: 16 - 50 ohms (recommended: 32 ohms)
Input terminals	Video/Auxiliary (audio signal): 500 mV/47 k ohms

■ CD player

Type	5-disc multi-play compact disc player
Signal readout	Non-contact, 3-beam semiconductor laser pickup
D/A converter	1-bit D/A converter
Frequency response	20 - 20,000 Hz
Dynamic range	90 dB (1 kHz)

■ Tuner

Frequency range	FM: 87.5 - 108 MHz AM: 530 - 1,720 kHz
------------------------	---

■ Front speaker

Type	2-way type speaker system (magnetic shield) 1.5" (4 cm) tweeter 4" (10 cm) woofer
Maximum input power	75 W
Rated input power	37.5 W
Impedance	6 ohms
Dimensions	Width: 6-1/2" (165 mm) Height: 9-7/16" (240 mm) Depth: 8-3/16" (208 mm)
Weight	4.9 lbs. (2.2 kg)/each

■ Subwoofer

Type	5-1/8" (13 cm) subwoofer system (magnetic shield)
Maximum input power	90 W
Rated input power	45 W
Impedance	6 ohms
Dimensions	Width: 6-5/16" (160 mm) Height: 9-7/16" (240 mm) Depth: 11-1/4" (285mm)
Weight	7.3 lbs. (3.3 kg)

CONSUMER LIMITED WARRANTY

SHARP ELECTRONICS CORPORATION warrants to the first consumer purchaser that this Sharp brand product (the "Product"), when shipped in its original container, will be free from defective workmanship and materials, and agrees that it will, at its option, either repair the defect or replace the defective Product or part thereof with a new or remanufactured equivalent at no charge to the purchaser for parts or labor for the period(s) set forth below.

This warranty does not apply to any appearance items of the Product nor to the additional excluded item(s) set forth below nor to any Product the exterior of which has been damaged or defaced, which has been subjected to improper voltage or other misuse, abnormal service or handling, or which has been altered or modified in design or construction.

In order to enforce the rights under this limited warranty, the purchaser should follow the steps set forth below and provide proof of purchase to the servicer.

The limited warranty described herein is in addition to whatever implied warranties may be granted to purchasers by law. ALL IMPLIED WARRANTIES INCLUDING THE WARRANTIES OF MERCHANTABILITY AND FITNESS FOR USE ARE LIMITED TO THE PERIOD(S) FROM THE DATE OF PURCHASE SET FORTH BELOW. Some states do not allow limitations on how long an implied warranty lasts, so the above limitation may not apply to you.

Neither the sales personnel of the seller nor any other person is authorized to make any warranties other than those described herein, or to extend the duration of any warranties beyond the time period described herein on behalf of Sharp.

The warranties described herein shall be the sole and exclusive warranties granted by Sharp and shall be the sole and exclusive remedy available to the purchaser. Correction of defects, in the manner and for the period of time described herein, shall constitute complete fulfillment of all liabilities and responsibilities of Sharp to the purchaser with respect to the Product, and shall constitute full satisfaction of all claims, whether based on contract, negligence, strict liability or otherwise. In no event shall Sharp be liable, or in any way responsible, for any damages or defects in the Product which were caused by repairs or attempted repairs performed by anyone other than an authorized servicer. Nor shall Sharp be liable or in any way responsible for any incidental or consequential economic or property damage. Some states do not allow the exclusion of incidental or consequential damages, so the above exclusion may not apply to you.

THIS WARRANTY GIVES YOU SPECIFIC LEGAL RIGHTS. YOU MAY ALSO HAVE OTHER RIGHTS WHICH VARY FROM STATE TO STATE.

Model Specific Section

Your Product Model Number & Description:

XL-MP60 Micro Component System

(Be sure to have this information available when you need service for your Product.)

Warranty Period for this Product:

One (1) year parts and labor from the date of purchase.

Additional Item(s) Excluded from Warranty Coverage (if any):

Non-functional accessories, supplies, and consumable items.

Where to Obtain Service:

At a Sharp Authorized Servicer located in the United States.

To find a location of the nearest Sharp Authorized Servicer, call Sharp toll free at 1-800-BE-SHARP.

What to do to Obtain Service:

Ship prepaid or carry in your Product to a Sharp Authorized Servicer.

Be sure to have **Proof of Purchase** available. If you ship the Product, be sure it is insured and packaged securely.

TO OBTAIN SUPPLY, ACCESSORY OR PRODUCT INFORMATION, CALL **1-800-BE-SHARP**.

SHARP

SHARP ELECTRONICS CORPORATION

Sharp Plaza, Mahwah, New Jersey 07430-2135

SHARP CORPORATION

Printed in China
TINSEA043SJZZ
05B N HK ②

Free Manuals Download Website

<http://myh66.com>

<http://usermanuals.us>

<http://www.somanuals.com>

<http://www.4manuals.cc>

<http://www.manual-lib.com>

<http://www.404manual.com>

<http://www.luxmanual.com>

<http://aubethermostatmanual.com>

Golf course search by state

<http://golfingnear.com>

Email search by domain

<http://emailbydomain.com>

Auto manuals search

<http://auto.somanuals.com>

TV manuals search

<http://tv.somanuals.com>