

MODEL

HT-SB600

SOUND BAR SYSTEM

OPERATION MANUAL

Thank you for purchasing this SHARP product. To obtain the best performance from this product, please read this manual carefully. It will guide you in operating your SHARP product.

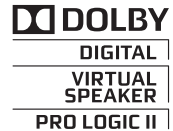
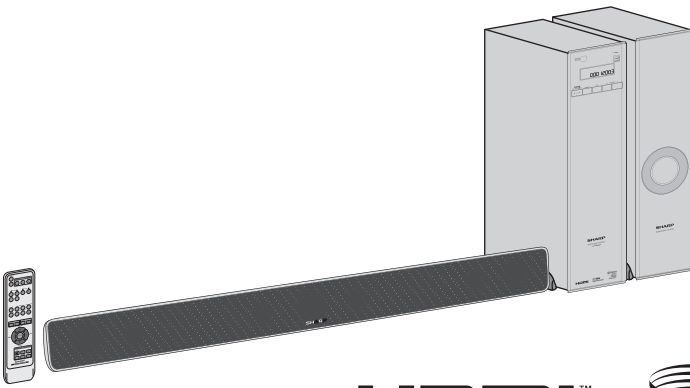

HT-SB600 Sound Bar system consisting of HT-SB600 (main unit), CP-SB600 (sound bar) and CP-SW600 (subwoofer).



Note:
This product is recommended for flat panel TV (LCD and plasma).

Accessories

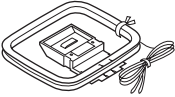
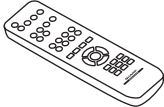
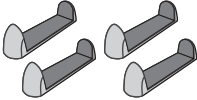
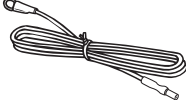
Please confirm that only the following accessories are included.

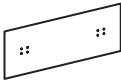
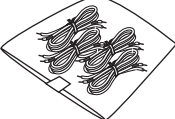
 <p>AM Loop Antenna (QANTLA004AWZZ)</p>	 <p>Remote Control (RRMCGA248AWSA)</p>	 <p>Stand x 4 (GITAUA004AW01)</p>	 <p>FM Antenna (92LFANT1535A)</p>
 <p>Wall Mount Angle x 2 (LANGKA167AWFW)</p>	 <p>Pattern Paper (TCAUHA025AWZZ)</p>	 <p>Speaker Wire (QCNWHA042AW01)</p>	



TINSEA352AWZZ

SHARP CORPORATION

Printed in Malaysia

10K B/KI ①

Special Notes



CAUTION

RISK OF ELECTRIC SHOCK
DO NOT OPEN



CAUTION: TO REDUCE THE RISK OF ELECTRIC SHOCK, DO NOT REMOVE COVER (OR BACK). NO USER-SERVICEABLE PARTS INSIDE. REFER SERVICING TO QUALIFIED SERVICE PERSONNEL.

Explanation of Graphical Symbols:



The lightning flash with arrowhead symbol, within an equilateral triangle, is intended to alert the user to the presence of uninsulated "dangerous voltage" within the product's enclosure that may be of sufficient magnitude to constitute a risk of electric shock to persons.



The exclamation point within an equilateral triangle is intended to alert the user to the presence of important operating and maintenance (servicing) instructions in the literature accompanying the appliance.

WARNING: TO REDUCE THE RISK OF FIRE OR ELECTRIC SHOCK, DO NOT EXPOSE THIS APPLIANCE TO RAIN OR MOISTURE.

FOR YOUR RECORDS

For your assistance in reporting this unit in case of loss or theft, please record below the model number and serial number which are located on the rear of the unit. Please retain this information.

Model number
 Serial number
 Date of purchase
 Place of purchase

NOTE

This equipment has been tested and found to comply with the limits for a Class B digital device, pursuant to Part 15 of the FCC Rules. These limits are designed to provide reasonable protection against harmful interference in a residential installation. This equipment generates, uses, and can radiate radio frequency energy and, if not installed and used in accordance with the instructions, may cause harmful interference to radio communications. However, there is no guarantee that interference will not occur in a particular installation. If this equipment does cause harmful interference to radio or television reception, which can be determined by turning the equipment off and on, the user is encouraged to try to correct the interference by one or more of the following measures:

- Reorient or relocate the receiving antenna.
- Increase the separation between the equipment and receiver.
- Connect the equipment into an outlet on a circuit different from that to which the receiver is connected.
- Consult the dealer or an experienced radio/TV technician for help.

WARNING

FCC Regulations state that any unauthorized changes or modifications to this equipment not expressly approved by the manufacturer could void the user's authority to operate this equipment.

Note to CATV system installer:

This reminder is provided to call the CATV system installer's attention to Article 820 of the National Electrical Code that provides guidelines for proper grounding and, in particular, specifies that the cable ground shall be connected to the grounding system of the building, as close to the point of cable entry as practical.

ENERGY STAR® Program Information



Products that have earned the ENERGY STAR® are designed to protect the environment through superior energy efficiency.

ENERGY STAR® is a U.S. registered mark.

Manufactured under license under U.S. Patent #: 5,451,942; 5,956,674; 5,974,380; 5,978,762; 6,487,535 & other U.S. and worldwide patents issued & pending. DTS and the Symbol are registered trademarks & DTS Digital Surround and the DTS logos are trademarks of DTS, Inc. Product includes software. © DTS, Inc. All Rights Reserved.

Manufactured under license from Dolby Laboratories. Dolby, Pro Logic, and the double-D symbol are trademarks of Dolby Laboratories.

HDMI, the HDMI Logo, and High-Definition Multimedia Interface are trademarks or registered trademarks of HDMI Licensing LLC in the United States and other countries.

Important Safety Instructions

Electricity is used to perform many useful functions, but it can also cause personal injuries and property damage if improperly handled. This product has been engineered and manufactured with the highest priority on safety. However, improper use can result in electric shock and/or fire. In order to prevent potential danger, please observe the following instructions when installing, operating and cleaning the product. To ensure your safety and prolong the service life of this product, please read the following precautions carefully before use.

- 1) Read these instructions.
- 2) Keep these instructions.
- 3) Heed all warnings.
- 4) Follow all instructions.
- 5) Do not use this apparatus near water.
- 6) Clean only with dry cloth.
- 7) Do not block any ventilation openings. Install in accordance with the manufacturer's instructions.

Important Safety Instructions (continued)

- 8) Do not install near any heat sources such as radiators, heat registers, stoves, or other apparatus (including amplifiers) that produce heat.
 - 9) Do not defeat the safety purpose of the polarized or grounding-type plug. A polarized plug has two blades with one wider than the other. A grounding type plug has two blades and a third grounding prong. The wide blade or the third prong are provided for your safety. If the provided plug does not fit into your outlet, consult an electrician for replacement of the obsolete outlet.
 - 10) Protect the power cord from being walked on or pinched particularly at plugs, convenience receptacles, and the point where they exit from the apparatus.
 - 11) Only use attachments/accessories specified by the manufacturer.
 - 12) Use only with the cart, stand, tripod, bracket, or table specified by the manufacturer, or sold with the apparatus. When a cart is used, use caution when moving the cart/apparatus combination to avoid injury from tip-over.
- 
- 13) Unplug this apparatus during lightning storms or when unused for long periods of time.
 - 14) Refer all servicing to qualified service personnel. Servicing is required when the apparatus has been damaged in any way, such as power-supply cord or plug is damaged, liquid has been spilled or objects have fallen into the apparatus, the apparatus has been exposed to rain or moisture, does not operate normally, or has been dropped.

Additional Safety Information

- 15) Power Sources - This product should be operated only from the type of power source indicated on the marking label. If you are not sure of the type of power supply to your home, consult your product dealer or local power company. For product intended to operate from battery power, or other sources, refer to the operating instructions.
- 16) Overloading - Do not overload wall outlets, extension cords, or integral convenience receptacles as this can result in a risk of fire or electric shock.
- 17) Object and Liquid Entry - Never push objects of any kind into this product through openings as they may touch dangerous voltage points or short-out parts that could result in a fire or electric shock. Never spill liquid of any kind on the product.
- 18) Damage Requiring Service - Unplug this product from the wall outlet and refer servicing to qualified service personnel under the following conditions:
 - a) When the AC cord or plug is damaged,
 - b) If liquid has been spilled, or objects have fallen into the product,
 - c) If the product has been exposed to rain or water,
 - d) If the product does not operate normally by following the operating instructions. Adjust only those controls that are covered by the operating instructions as an improper adjustment of other controls may result in damage and will often require extensive work by a qualified technician to restore the product to its normal operation,
 - e) If the product has been dropped or damaged in any way, and
 - f) When the product exhibits a distinct change in performance - this indicates a need for service.
- 19) Replacement Parts - When replacement parts are required, be sure the service technician has used replacement parts specified by the manufacturer or have the same characteristics as the original part. Unauthorized substitutions may result in fire, electric shock, or other hazards.
- 20) Safety Check - Upon completion of any service or repairs to this product, ask the service technician to perform safety checks to determine that the product is in proper operating condition.
- 21) Wall or ceiling mounting - When mounting the product on a wall or ceiling, be sure to install the product according to the method recommended by the manufacturer.
- 22) Power Lines - An outside antenna system should not be located in the vicinity of overhead power lines or other electric light or power circuits, or where it can fall into such power lines or circuits. When installing an outside antenna system, extreme care should be taken to keep from touching such power lines or circuits as contact with them might be fatal.
- 23) Protective Attachment Plug - The product is equipped with an attachment plug having overload protection. This is a safety feature. See Instruction Manual for replacement or resetting of protective device. If replacement of the plug is required, be sure the service technician has used a replacement plug specified by the manufacturer that has the same overload protection as the original plug.
- 24) Stand - Do not place the product on an unstable cart, stand, tripod or table. Placing the product on an unstable base can cause the product to fall, resulting in serious personal injuries as well as damage to the product. Use only a cart, stand, tripod, bracket or table recommended by the manufacturer or sold with the product. When mounting the product on a wall, be sure to follow the manufacturer's instructions. Use only the mounting hardware recommended by the manufacturer.

CONSUMER LIMITED WARRANTY

SHARP ELECTRONICS CORPORATION warrants to the first consumer purchaser that this Sharp brand product (the "Product"), when ship in its original container, will be free from defective workmanship and materials, and agrees that it will, at its option, either repair the defect or replace the defective Product or part thereof with a new or remanufactured equivalent at no charge to the purchaser for parts or labor for the period(s) set forth below.

This warranty does not apply to any appearance items of the Product nor to the additional excluded item(s) set forth below nor to any Product the exterior of which has been damaged or defaced, which has been subjected to improper voltage or other misuse, abnormal service or handling, or which has been altered or modified in design or construction.

In order to enforce the rights under this limited warranty, the purchaser should follow the steps set forth below and provide proof of purchase to the servicer.

The limited warranty described herein is in addition to whatever implied warranties may be granted to purchasers by law. ALL IMPLIED WARRANTIES INCLUDING THE WARRANTIES OF MERCHANTABILITY AND FITNESS FOR USE ARE LIMITED TO THE PERIOD(S) FROM THE DATE OF PURCHASE SET FORTH BELOW. Some states do not allow limitations on how long an implied warranty lasts, so the above limitation may not apply to you.

Neither the sales personnel of the seller nor any other person is authorized to make any warranties other than those described herein, or to extend the duration of any warranties beyond the time period described herein on behalf of Sharp.

The warranties described herein shall be the sole and exclusive warranties granted by Sharp and shall be the sole and exclusive remedy available to the purchaser. Correction of defects, in the manner and for the period of time described herein, shall constitute complete fulfillment of all liabilities and responsibilities of Sharp to the purchaser with respect to the Product, and shall constitute full satisfaction of all claims, whether based on contract, negligence, strict liability or otherwise. In no event shall Sharp be liable, or in any way responsible, for any damages or defects in the Product which were caused by repairs or attempted repairs performed by anyone other than an authorized servicer. Nor shall Sharp be liable or in any way responsible for any incidental or consequential economic or property damage. Some states do not allow the exclusion of incidental or consequential damages, so the above exclusion may not apply to you.

THIS WARRANTY GIVES YOU SPECIFIC LEGAL RIGHTS. YOU MAY ALSO HAVE OTHER RIGHTS WHICH VARY FROM STATE TO STATE.

Model Specific Section

Your Product Model Number & Description:

HT-SB600 Sound Bar System

(Be sure to have this information available when you need service for your Product.)

Warranty Period for this Product:

One (1) year parts and labor from the date of purchase.

Additional Item(s) Excluded from Warranty Coverage (if any):

Non-functional accessories, supplies, and consumable items.

Where to Obtain Service:

At a Sharp Authorized Servicer located in the United States. To find a location of the nearest Sharp Authorized Servicer, call Sharp toll free at 1-800-BE-SHARP.

What to do to Obtain Service:

Ship prepaid or carry in your Product to a Sharp Authorized Servicer. Be sure to have **Proof of Purchase** available. If you ship the Product, be sure it is insured and packaged securely.

TO OBTAIN SUPPLY, ACCESSORY OR PRODUCT INFORMATION, CALL **1-800-BE-SHARP**

SHARP ELECTRONICS CORPORATION

Sharp Plaza, Mahwah, New Jersey 07495-1163

Precautions

General

- Please ensure that the equipment is positioned in a well-ventilated area and ensure that there is at least 4" (10 cm) of free space along the sides, top and back of the equipment.

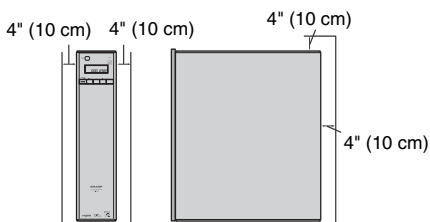

- Use the unit on a firm, level surface free from vibration.
- Keep the unit away from direct sunlight, strong magnetic fields, excessive dust, humidity and electronic/electrical equipment (home computers, facsimiles, etc.) which generate electrical noise.
- Do not place anything on top of the unit.
- Do not expose the unit to moisture, to temperatures higher than 140°F (60°C) or to extremely low temperatures.
- If your system does not work properly, disconnect the AC power cord from the AC outlet. Plug the AC power cord back in, and then turn on your system.
- In case of an electrical storm, unplug the unit for safety.
- Hold the AC power plug by the head when removing it from the AC outlet, as pulling the cord can damage internal wires.
- The AC power plug is used as a disconnect device and shall always remain readily operable.
- **Do not remove the outer cover, as this may result in electric shock. Refer internal service to your local SHARP service facility.**
- This unit should only be used within the range of 41°F - 95°F (5°C - 35°C).
- SHARP is not responsible for damage due to improper use. Refer all servicing to a SHARP authorised service center.

Warning:

The voltage used must be the same as that specified on this unit. Using this product with a higher voltage other than that which is specified is dangerous and may result in a fire or other type of accident causing damage. SHARP will not be held responsible for any damage resulting from use of this unit with a voltage other than that which is specified.

Volume control

The sound level at a given volume setting depends on speaker efficiency, location and various other factors. It is advisable to avoid exposure to high volume levels, which occurs while turning the unit on with the volume control setting up high, or while continually listening at high volumes.

Cooling fan

This unit is fitted with a cooling fan at the rear for improved cooling. Do not cover the opening in this section with any obstacles.



Caution:

- The unit will get warm while being used. Do not touch the warm areas of the unit for prolonged periods to avoid injuries.
- This unit is equipped with a special function which protects the amplifier circuit from damages. When it is activated, the sound switch is turned off. In this case, set the unit to the stand-by mode and turn on again.

Controls and indicators

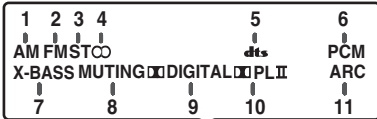
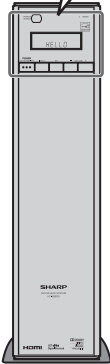
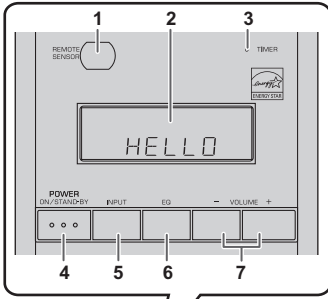

Front Panel

Reference page

- 1. Remote Sensor 15
- 2. Information Display 16
- 3. Timer Indicator 20
- 4. On/Stand-by Button 16, 18, 22
- 5. Input Button 12, 15, 17
- 6. Equalizer Button 16, 22
- 7. Volume Up/Down Button 16

Display

Reference page

- 1. AM Indicator 19
- 2. FM Indicator 18
- 3. FM Stereo Indicator 18
- 4. FM Stereo receiving Indicator 17
- 5. DTS Indicator 17
- 6. PCM Indicator 18
- 7. X-BASS Indicator 17
- 8. MUTING Indicator 16
- 9. Dolby Digital Indicator 17
- 10. Dolby Pro Logic II Indicator 17
- 11. Audio Return Channel Indicator 17

Rear Panel

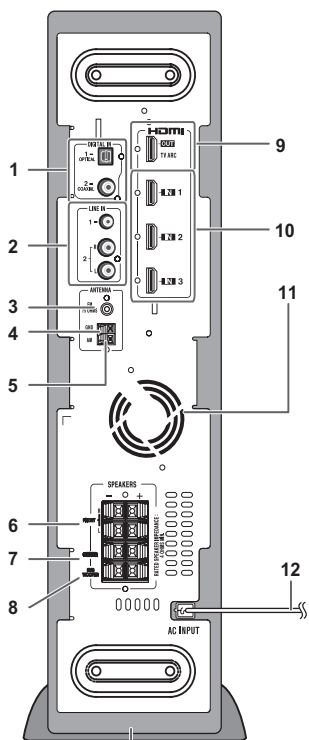

	Reference page
1. Digital Input Jack	13, 14
2. Line Input Jack	13, 14
3. FM 75 Ohms Antenna Jack	11, 12
4. AM Antenna Ground Terminal	11
5. AM Loop Antenna Terminal	11
6. Front Speaker Terminal	11
7. Center Speaker Terminal	11
8. Subwoofer Terminal	11
9. HDMI (TV ARC) Output Jack	12
10. HDMI input Jack	12
11. Cooling Fan	4
12. AC Power Cord	11

The spec label (*)

SHARP		MODEL NO. HT-SB600
SOUND BAR SYSTEM		<input type="checkbox"/>
AC 120V 60Hz 50W		
FREQUENCY RANGE : FM 87.5 - 108 MHz AM 530 - 1,710 kHz		
SHARP CORPORATION		MADE IN MALAYSIA
MARKETED BY: SHARP ELECTRONICS CORPORATION SHARP PLAZA, MAHWAH, NEW JERSEY 07430-1162		
	 CAUTION RISK OF ELECTRIC SHOCK DO NOT OPEN NOTICE: SEE OPERATOR MANUAL	
This device complies with Part 15 of the FCC Rules. Operation is subject to the following two conditions: (1) This device may not cause harmful interference, and (2) this device must accept any interference received, including interference that may cause undesired operation.		
Manufactured under license from Dolby Laboratories. Dolby, Pro Logic, and the double D symbol are trademarks of Dolby Laboratories.		
Manufactured under license under U.S. Patent #'s: 5,451,942; 5,956,674; 5,974,380; 5,978,762; 6,497,535 & other U.S. and worldwide patents issued & pending. DTS and the Symbol are registered trademarks & DTS Digital Surround and the DTS logos are trademarks of DTS, Inc. © DTS, Inc. All Rights Reserved.		

The spec label illustration may be different from the actual label used
 (*) Label is located at the bottom of the unit

Controls and indicators (continued)

■ Sound Bar

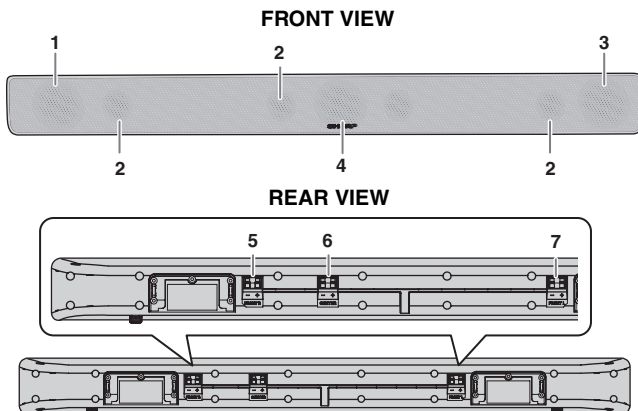

- 1. Left Front Speaker
- 2. Bass Reflex Duct
- 3. Right Front speaker
- 4. Center Speaker

- Reference page
- 5. Right Front Speaker terminal11
 - 6. Center Speaker terminal11
 - 7. Left Front Speaker terminal11

■ Subwoofer

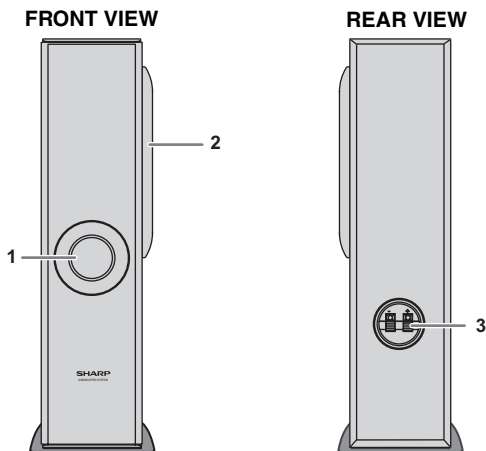

Reference page



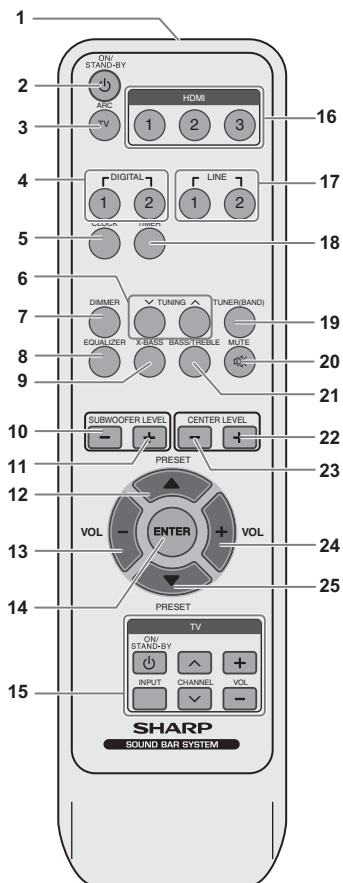

- 1. Bass Reflect Duct
- 2. Woofer
- 3. Speaker Terminals 11

Remote Control

Reference page



1. Remote Control Transmitter	15
2. On/Stand-by Button	16, 18
3. TV ARC Button	12, 17
4. DIGITAL 1-2 Button	15, 17
5. CLOCK Button	16, 19
6. TUNING Up/Down Button	18
7. Dimmer Button	16
8. EQUALIZER Button	16
9. X-BASS Button	17
10. Subwoofer Level Down Button	16
11. Subwoofer Level Up Button	16
12. Preset Up Button	18, 19
13. Volume Down Button	16, 17
14. ENTER Button	18, 19, 20
15. TV Operation Button	8, 20
16. HDMI 1-2-3 Button	12, 17
17. Line 1-2 Button	15, 17
18. TIMER Button	19, 20
19. TUNER(BAND) Button	17, 18
20. MUTE/Speaker Output Selection Button	16
21. Bass/Treble Button	17
22. Center Speaker Level Up Button	17
23. Center Speaker Level Down Button	17
24. Volume Up Button	16, 17
25. Preset Down Button	18, 19

TV Operation Buttons (Only SHARP TV):			
On/Stand-by Button 	Sets the TV power to "ON" or "STAND-BY".	Input Select Button (TV) 	Press the button to switch the input source.
Volume Up and Down Buttons 	Turn up/down the TV volume.	Channel Up and Down Buttons 	Switch up/down the TV channels.

Note:

Some models of SHARP TV may not be operable.

Speaker preparation

To mount the speaker on the wall

Caution:

- Be very careful to prevent the speaker [4.41 lbs. (2.0 kg)] from falling when mounting on the wall.
- Before mounting, check the wall strength. (Do not put on the veneer plaster or whitewashed wall. The speaker may fall.) If unsure, consult a qualified service technician.
- Mounting screws are not supplied. Use appropriate ones.
- Check all wall mount angle screws for looseness.
- Select a good location. If not, accidents may occur or the speaker may get damaged.
- **SHARP is not responsible for accidents resulting from improper installation.**

Driving screws

SHARP designed the speakers so you may hang them on the wall. Use proper screws (not supplied). See below for size and type.

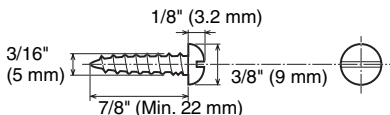

Fixing wall mount angle (Horizontal position)

- 1 Fix the pattern paper to the wall in horizontal position as below.

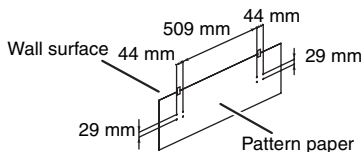

- 2 Make a hole on the wall following the screw point marks on the pattern paper by using a drill.

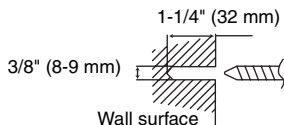

- 3 Fix a wall mount plug (not supplied) into the hole using a hammer, until it is flush with the wall surface.

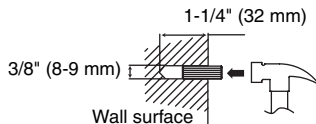

- 4 Screw the wall mount angle to the wall as shown in the illustration. (Total screw is 8 pieces)

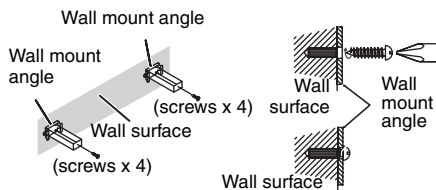

Note:

Make sure all screws are fully tightened. (screws are not supplied)

Installing the speaker

- 1 Align the wall mount slot at the speaker to the wall mount angle.

- 2 Slot the speaker into the wall mount angle.

- 3 Fix them securely.

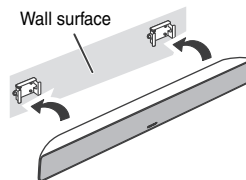

Falling prevention

Safety wires (not supplied) are useful to prevent the speaker from falling off the table.

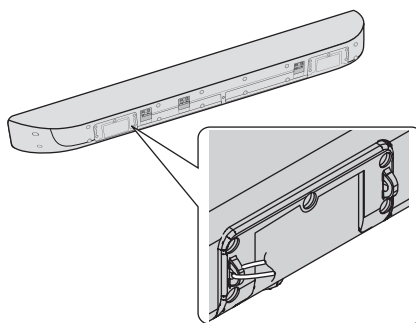

Loop the safety wires (not supplied) into each hole as shown and tie the safety wires to the LCD TV stand.

Placing the system

Installation image:

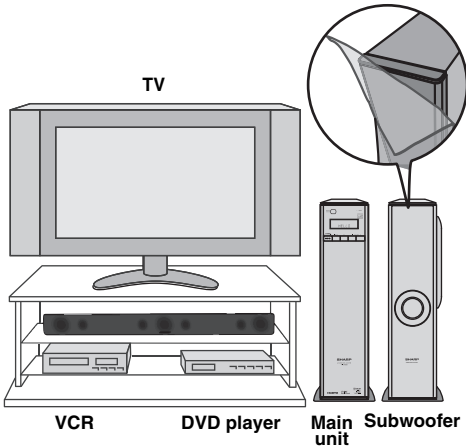

Place the system as shown.

Remove the protective film covering the main unit and subwoofer before turn on the system.

Notes:

- As the sound from the system is omni-directional, you can place the speaker anywhere you like. However, it is recommended to place it as close to the TV as possible.
- The front panel of the speaker is not removable.

Caution:

- Do not change the installation direction when the unit is turned on.
- Do not stand or sit on the main unit and speakers as you may be injured.

Placing the stand

Place the stand as shown.

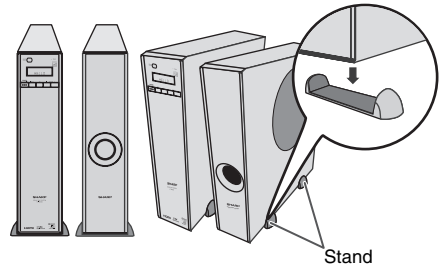

System connections

Make sure to unplug the AC power cord before making any connections.

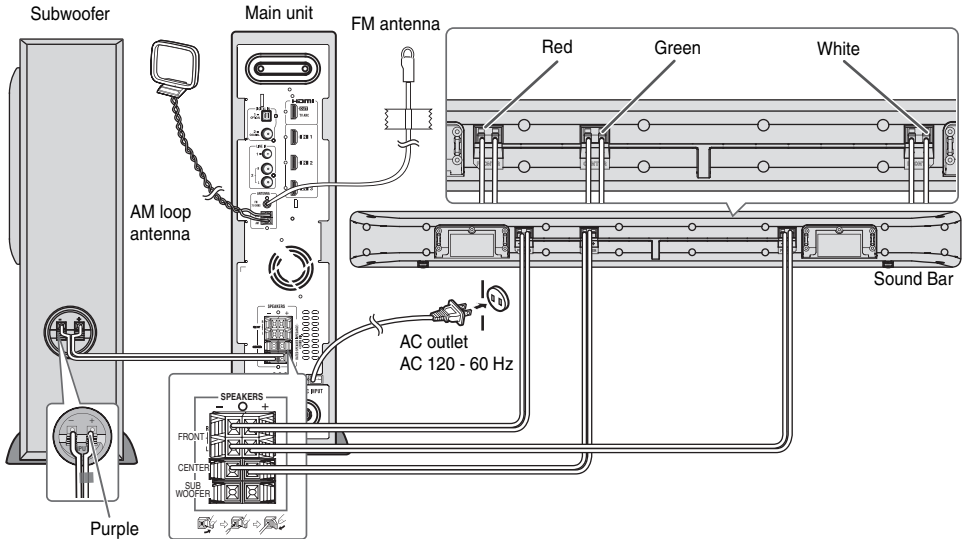

Speaker and Subwoofer connection

Connect the wire without insulation tube to the minus (-) terminal, and the wire with colored insulation tube to the plus (+) terminal. Make sure to match the colored insulation tube with terminal color before connection.

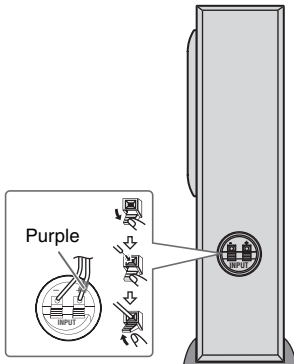

Caution

- Never mistake the FRONT, CENTER and the SUBWOOFER terminals. The main unit or the speakers may be damaged.
- If you use other speakers with an impedance lower than that specified, the main unit may be damaged. Front speakers: 4 ohms, Subwoofer: 4 ohms.
- Do not make a mistake when connecting the right and the left speakers. The right speaker is the one on the right side when you face the unit.
- **Do not let the bare speaker wires touch each other.**
- Do not allow any objects to fall into or to be placed in the bass reflex duct.
- Do not stand or sit on the subwoofer/speakers. You may be injured.

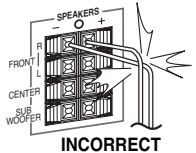

System connections (continued)

Antenna connection

Supplied FM antenna:

Connect the FM antenna wire to the FM 75 OHMS jack and position the FM antenna wire in the direction where the strongest signal can be received.

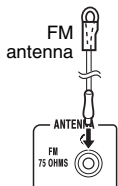

Supplied AM loop antenna:

Connect the AM loop antenna to the AM and GND (Ground) terminals. Position the AM loop antenna for optimum reception. Place the AM loop on a shelf, etc., or attach it to a stand or a wall with screws (not supplied).

Installing the AM loop antenna:

<Assembling> <Attaching to the wall>

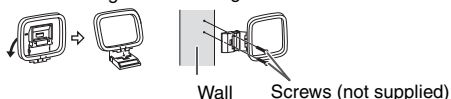

Note:

Placing the antenna on the unit or near the AC power cord may cause noise pickup. Place the antenna away from the unit for better reception.

Outdoor FM antenna

Use an outdoor FM antenna if you require better reception. Consult your dealer.

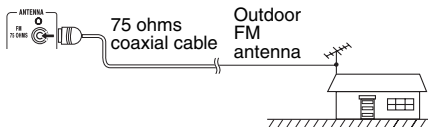

Note:

When an outdoor FM antenna is used, disconnect the supplied FM antenna wire.

HDMI Connection

Caution:

Turn off all other equipment before making this connection.

The illustration below shows the flows of the signals.

————— Audio and Video signal

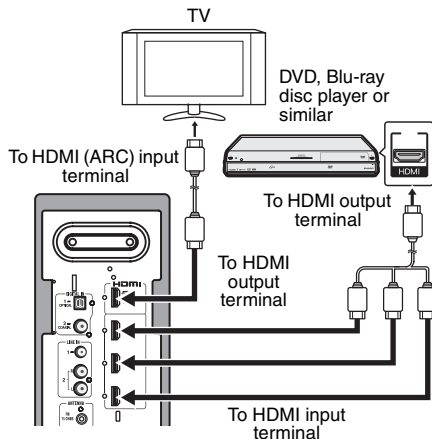
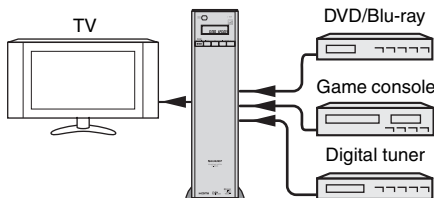

HDMI cables are not supplied

To select HDMI 1, 2, 3 or TV ARC function:

On main unit: Press INPUT button repeatedly until "HDMI1", "HDMI2", "HDMI3" or "TV ARC" appears on the display.

On remote control: Press HDMI1, HDMI2, HDMI3 or TV ARC button.

Notes:

- This unit supports HDMI which enables ARC (Audio Return Channel) function.
- To enable ARC function make sure to use High Speed HDMI cable.
- This structure also needs TV that supports ARC function.
- To listen to the sound from non-ARC-compatible TV, connect the digital output from TV to this system digital input terminal. (refer page 13)
- This unit can be operated (power on/off, volume up/down or switch input source) via a TV or similar component which supports HDMI CEC (Consumer Electronics Control) function. If this does not work, it does not mean this system is faulty. Refer to the operation manual of the respective component on how to activate the CEC function. Example: Go to the Menu of the component to search and turn on the CEC function. Different brands may have different naming for the CEC function. For Sharp LCD TV, it is named as AQUOS LINK.
- To watch 3D images, connect 3D-compatible TV and video component (Blu-ray Disc player, etc.) to this system.

Make sure to use High Speed HDMI cables and put on the 3D glasses, otherwise 3D images may not be viewed properly.

Audio connections to TVs, DVD players, VCRs, etc.

Other connection (without HDMI)

The illustration below shows the flows of audio and video signals.

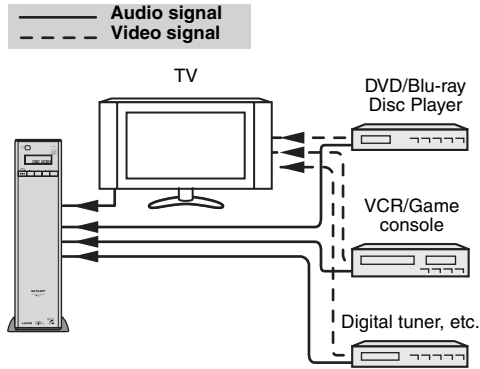

Notes:

- Refer to the operation manual of the equipment to be connected.
- Fully insert the plugs to avoid fuzzy pictures or noises.

Connecting a TV, etc.

Connect to the TV using an optical digital audio cable or an audio cable.

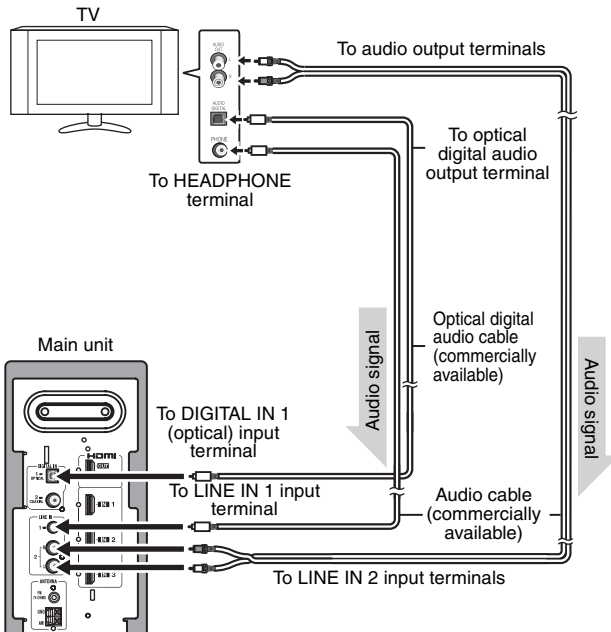

Audio connections to TVs, DVD players, VCRs, etc. (continued)

■ Connecting a DVD player, etc.

Connect to the DVD player with an optical digital audio cable or an audio cable.

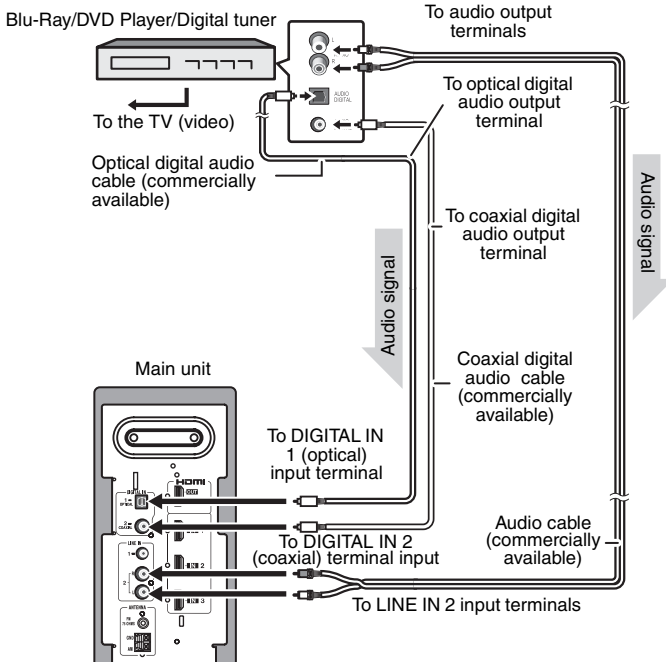

Note:

Connect the DVD video cable directly to the TV (refer to the operation manual for the DVD player).

■ Connecting a VCR, etc.

Connect to the VCR with an audio cable.

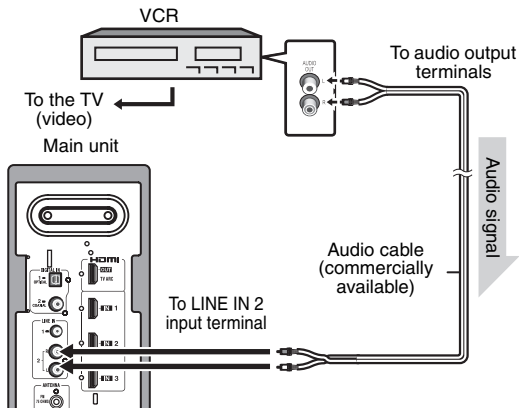

Note:

Connect the VCR video cable directly to the TV (refer to the operation manual for the VCR player).

Audio connections to TVs, DVD players, VCRs, etc. (continued)

To select **DIGITAL IN 1 (optical input)** or **DIGITAL IN 2 (coaxial input)** function:

On main unit: Press INPUT button repeatedly until "DIGITAL 1" or "DIGITAL 2" appears on the display.

On remote control: Press the "DIGITAL 1" or "DIGITAL 2" button.

To select **LINE IN 1** or **LINE IN 2** function:

On main unit: Press INPUT button repeatedly until "LINE 1" or "LINE 2" appears on the display.

On remote control: Press the "LINE 1" or "LINE 2" button.

Remote Control

Battery installation

Use 2 "AAA" size batteries (UM/SUM-4, R3, HP-16 or similar). Batteries are not included.

Plastic film covering can be removed or peeled off.

1 Open the battery cover.

2 Insert the batteries according to the direction indicated in the battery compartment.

When inserting or removing the batteries, push them toward the ⊖ battery terminals.

3 Close the battery cover.

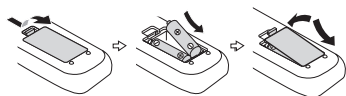

Caution:

- Replace all old batteries with new ones at the same time.
- Do not mix old and new batteries.
- Remove the batteries if the unit will not be used for a long period of time. This will prevent potential damage due to battery leakage.
- Do not use rechargeable batteries (nickel-cadmium battery, etc.).
- Installing the batteries incorrectly may cause the unit to malfunction.
- Batteries (battery pack or batteries installed) shall not be exposed to excessive heat such as sunshine, fire or the like.

Remote Control (continued)

Notes concerning use:

- Replace the batteries if the operating distance is reduced or if the operation becomes erratic.
- Periodically clean the transmitter on the remote control and the sensor on the unit with a soft cloth.
- Exposing the sensor on the unit to strong light may interfere with operation. Change the lighting or the direction of the unit.
- Keep the remote control away from moisture, heat, shock, and vibrations.

Test of the remote control

Point the remote control directly at the remote sensor on the main unit.

The remote control can be used within the range shown below:

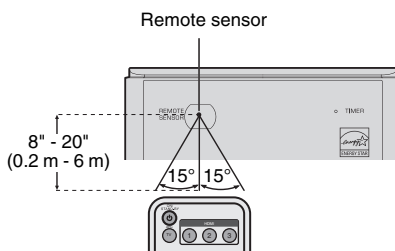

General control

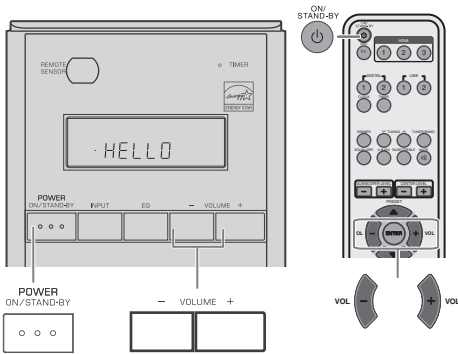

To turn the power on

Press the ON/STAND-BY button on the main unit or the remote control.

- The power turns on. If the power does not turn on, check whether the AC power cord is plugged in properly.

To set the unit to stand-by mode:

Press the ON/STAND-BY button again on the main unit or the remote control.

Display brightness control

Press the DIMMER button to adjust the brightness of the display.

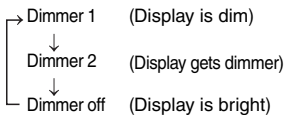

Clock display

Clock can be displayed during power On or standby mode.

Display clock:

Press the CLOCK button on the remote control. The time display will appear for about 5 seconds.

To cancel the time display manually press the clock button again within 5 seconds.

Note:

If clock not previously set, "ADJUST" will be displayed for a while. (Refer "setting the clock" on page 19)

Volume auto fade-in

If you turn off and on the unit with the volume set to 80 or higher, the volume starts at 40 and fades in to the last set level.

Volume control

Main unit operation:

Press the VOLUME + button to increase the volume and the VOLUME - button for decreasing.

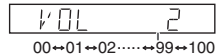

Remote control operation:

Press the VOL + button to increase the volume and the VOL - button to decrease the volume.

Muting

The volume is muted temporarily when pressing the MUTE button on the remote control. Press again to restore the volume.



Note:

When the unit is turned off and back on again, muting is canceled.

Equalizer

Press the EQ button on the main unit or EQUALIZER button on the remote control repeatedly to select the desired equalizer mode.

MUSIC	(for standard sound effect)
CINEMA /GAME	(for cinema/game sound effect)
SPORT	(for sport broadcasting)
NEWS	(for news)
DOLBY VS	(Dolby Virtual Speaker)

Subwoofer level control

The subwoofer level can be adjusted.

To increase the level, press the SUBWOOFER LEVEL + button.

To decrease the level, press the SUBWOOFER LEVEL - button.

Notes:

- When sound from the speaker is distorted, decrease the subwoofer level.
- When changing the subwoofer level, the output level of the Subwoofer is also changed.

Center speaker level control

The center speaker level can be adjusted.

To increase the level, press the CENTER LEVEL + button.

To decrease the level, press the CENTER LEVEL - button.

Speaker output selection (HDMI connection)

Press and hold MUTE button on the remote control until "TV SPK" or "SB SPK" appear on the display to toggle sound output between this unit or TV.

General control (continued)

Bass control

1. Press the BASS/TREBLE button to select "BASS".
2. Within 5 seconds, press the VOLUME (+ or -) button to adjust the bass.

BASS 0

Treble control

1. Press the BASS/TREBLE button to select "TREBLE".
2. Within 5 seconds, press the VOLUME (+ or -) button to adjust the treble.

TREBLE 0

X-Bass control

When the X-BASS button on the remote control is pressed, the unit will enter the extra bass mode which emphasizes the bass frequencies, and X-BASS indicator will appear. To cancel the extra bass mode, press the X-BASS or BASS/TREBLE button.

X-BASS
X-BASS

Function

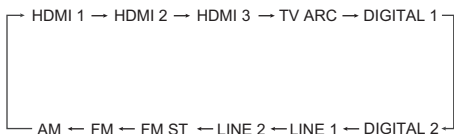

On the main unit:

When pressing the INPUT button, the input source will change. Press the INPUT button repeatedly to select desired input source.

On remote control:

Press the LINE 1 or 2 button to select LINE IN 1 input or LINE IN 2 input.
Press the DIGITAL 1 or 2 button to select DIGITAL IN 1 input or DIGITAL IN 2 input.
Press the HDMI 1 or 2 or 3 to select HDMI input.
Press the TUNER(BAND) button repeatedly to select tuner function (FM ST/FM Mono/AM).
Press TV ARC button to select TV ARC.

Note:

The backup function will protect the memorized function mode for a few hours should there be a power failure or the AC power cord becomes disconnected.

Auto power on function:

When you press any function button on the remote control, the unit will turn on.

Auto power off function:

The unit will automatically go to stand-by mode if:

1. No signal is detected within 20 minutes.
2. No reception of tuner broadcast signal within 20 minutes.

Audio Return Channel (ARC) (Audio Return Channel submenu)

The audio return channel (ARC) function enables an HDMI ARC-capable TV to send the audio stream to the HDMI OUT jack of the receiver. To use this function, you must select the TV ARC input and your TV must support the ARC function.

Dolby Virtual Speaker (DVS) sound mode

The Dolby Virtual Speaker (DVS) creates virtual surrounds comparable to the 5.1ch sound produced by the 3.1ch speaker.

When setting DVS to "ON" for 2 channel stereo signals, Dolby Pro Logic II brings out virtual sound effects through the signals converted into 5.1ch.

Notes:

- Monaural signals do not generate surround effects.
- DVS equalizer effect may not be obtained depending on signal types (the Dolby Virtual Speaker indicator blinks). In this case, set the DVS mode to OFF.

DVS

The Dolby Virtual Speaker creates multichannel-like sound effects.

Compared with the cinema mode, the bass sound level is slightly reduced.

The Dolby Pro Logic II indicator also lights up if 2ch sound signals are detected.

- The DVS can be turned OFF by selecting other preset equalizer modes.

This product incorporates decoders supporting the Dolby Digital system and DTS system.

DTS (Digital Theater Systems)	One of the digital audio systems for theatrical use. As the sound quality is emphasized, you can enjoy the realistic sound effect in the home theater system. Lights up when detecting DTS signal.
Dolby Digital	One of the digital audio systems for theatrical use. You can also enjoy the stereophonic effect in the home theater system. Lights up when detecting Dolby Digital signal.
Dolby Pro Logic II	System expanding 2ch stereo sound to more spacious sound. When setting Dolby Virtual speaker to "ON", Dolby Pro Logic II is activated to enjoy the stereo sound effect. Lights up when Dolby Pro Logic II is activated.
PCM (Pulse Code Modulation)	This is a general term for digitally encoded audio signals on a CD or DVD. This unit lets you enjoy playback of digital signals from sources such as CD or DVD. The indicator lights up when a PCM signal is detected.

Listening to the radio

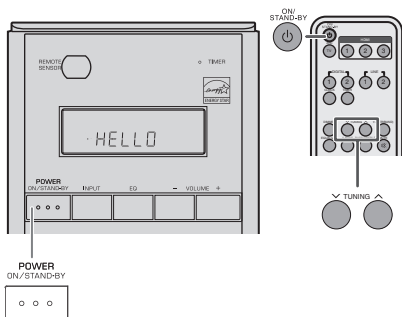

Notes:

This product can receive FM stereo/FM monaural/AM broadcasts.

■ Tuning

1 Press the ON/STAND-BY button to turn the power on.

2 Press the INPUT button on the main unit or TUNER(BAND) button on the remote control repeatedly to select the desired frequency band (FM Stereo/FM Mono/AM).

3 Press the (TUNING ^ or v) button to tune in to the desired station.

Manual tuning:

Press the (TUNING ^ or v) button as many times as required to tune in to the desired station.

Auto tuning:

When the (TUNING ^ or v) button is pressed for more than 0.5 seconds, scanning will start automatically and the tuner will stop at the first receivable broadcast station.

Notes:

- When radio interference occurs, auto scan tuning may stop automatically at that point.
- Auto scan tuning will skip weak signal stations.
- To stop the auto tuning, press the TUNING button again.

To receive an FM stereo transmission:

- "◻" will appear when an FM broadcast is in stereo.
- If the FM reception is weak, press the TUNER(BAND) button to extinguish the "ST" indicator. The reception changes to monaural, and the sound becomes clearer.

FM stereo mode indicator

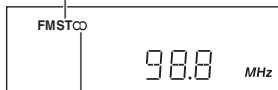

FM stereo receiving indicator

Listening to the radio (continued)

■ Memorizing a station

You can store 40 FM stations in memory and recall them at the push of a button. (Preset tuning)

1 Perform steps 1 - 3 in "Tuning" on page 18.

2 Press the ENTER button to enter the preset tuning saving mode.

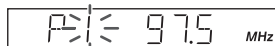

3 Within 5 seconds, press the PRESET (▼ or ▲) buttons to select the preset channel number.

Store the stations in memory, in order, starting with preset channel 1.

4 Within 5 seconds, press the ENTER button to store that station in memory.

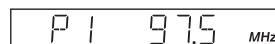

If the preset number indicators disappear before the station is memorized, repeat the operation from step 2.

5 Repeat steps 1 - 4 to set other stations, or to change a preset station.

When a new station is stored in memory, the station previously memorized will be erased.

Notes:

The backup function protects the memorized stations for a few hours should there be a power failure or the AC power cord become disconnected.

■ To recall a memorized station

Press the PRESET (▼ or ▲) button for less than 0.5 seconds to select the desired station.

■ To erase entire preset memory

1. Hold the TUNER(BAND) button on the remote control for 4 seconds or more.
2. While "CLEAR" is flashing, press the ENTER button.

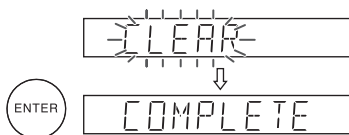

Setting the clock (Remote Control only)

By setting the unit to the correct time, you can use it not only as a clock but also for timer.

In this example, the clock is set for the 12-hour (AM 12:00) display.

- 1 Press the **CLOCK** button. If clock is not set "ADJUST" will blink. Within 5 seconds, press the **ENTER** button.

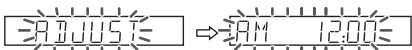

- 2 Press the **▼** or **▲** button to select 12-hour or 24-hour display and then press the **ENTER** button.

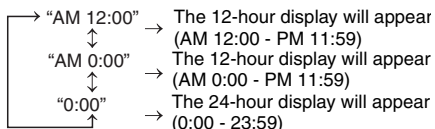

- 3 Press the **▼** or **▲** button to adjust the hour and then press the **ENTER** button.



- Press the **▼** or **▲** button once to advance the time by 1 hour. Hold it down to advance continuously.
- When the 12-hour display is selected, "AM" will change automatically to "PM".

- 4 Press the **▼** or **▲** button to adjust the minutes and then press the **ENTER** button.

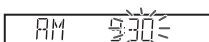

- Press the **▼** or **▲** button once to advance the time by 1 minute. Hold it down to advance continuously (5 minutes interval).
- The hour will not advance even if minutes advance from "59" to "00".
- The clock starts from "0" second (seconds are not displayed).
- The time display disappears after approx. 5 seconds.

To confirm the time display:

Press the **CLOCK** button. The time display will appear for about 5 seconds.

Note:

"ADJUST" will appear or time will be displayed if the **CLOCK** button is pressed when the AC power supply is restored after a power failure or unplugging the unit. If incorrect, readjust the clock as follows.

To readjust the clock:

Perform "Setting the clock" from step 1. If "ADJUST" does not appear, step 2 (for selecting the 12-hour or 24-hour display) will be skipped.

To change the 12-hour or 24-hour display:

1. Clear all the programmed contents. [Refer to "Factory reset, clearing all memory" on page 22 for details.]
2. Perform "Setting the clock" from step 1 onwards.

Timer operation (Remote Control only)

Setting the timer

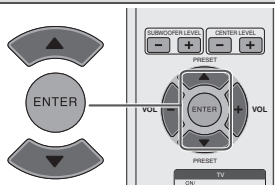

You can use the unit as an alarm clock by setting the timer.

Before setting timer:

1. Set the unit to the correct time (page 19). If it is not set, you cannot use the timer function.
2. Prepare the sound source for playback.
3. Store radio stations (page 18).

- 1 Turn the power on and press the **TIMER** button.

Set the unit to the correct time if "STANDBY" does not appear.



- 2 Within 10 seconds, press the **▲** or **▼** button to select "TIMER SET", and press the **ENTER** button.

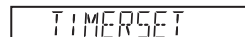

- 3 Press the **▲** or **▼** button to adjust the hour and then press the **ENTER** button.

- 4 Press the **▲** or **▼** button to adjust the minutes and then press the **ENTER** button.

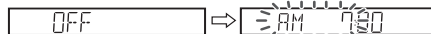
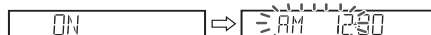

The start time is set and the finish time (1 hour later) will be displayed automatically.

- 5 Set the time to finish as in steps 3 and 4.

- 6 Switch input with the **▲** or **▼** buttons, and then press the **ENTER** button.

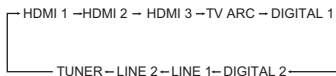

- When you select the tuner, select a station by pressing the **▲** or **▼** button, and then press the **ENTER** button.
- If a station has not been programmed, "NOPRESET" will be displayed.

- 7 Adjust the volume with the **▲** or **▼** button and press the **ENTER** button.

Settings are displayed in order, and the unit will enter the timer stand-by mode.

Caution:

This unit cannot set the timer of other equipment. To perform the timer playback using other equipment, you should also set the timer on the equipment separately.

Timer operation (Remote Control only) (continued)

After completing the setting

When the timer setting is completed:

The unit is in the timer playback stand-by mode.



To check the timer setting:

1. While in the timer playback stand-by mode, press the TIMER button.
2. Within 10 seconds, press the ▲ or ▼ button to select "TIMERCAL", and press the ENTER button.
The unit returns to the timer playback stand-by mode after the setting contents are displayed in order.

When the start time is reached:

Unit starts automatically and the volume increases gradually. The unit is operated by the timer.

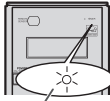

Timer LED indicator flashes

Canceling the timer playback:

Timer playback is canceled by turning the power on while in the timer playback stand-by mode. The same operation can be performed in the following procedure without turning the power on.

1. Press the TIMER button. "TIMEROFF" will appear.
2. Within 10 seconds, press the ENTER button. Timer playback will be canceled (the contents of the setting will not be canceled.)

When the finish time is reached:

The unit is set to the power stand-by mode automatically.

Reusing the timer:

Using the same setting;

The timer setting will be memorized once it is entered. To reuse the same setting, perform the following operations.

1. Turn the power on and press the TIMER button. "STANDBY" will appear. If it does not appear, set the unit to the correct time.
2. Within 10 seconds, press the ENTER button. After the setting contents are displayed in order, the unit is set to the timer playback stand-by mode.

Changing the setting;

Turn the power on, and repeat the operation from step 1 in "Setting the timer" (page 19).

The timer setting is canceled.

Operating the TV with the remote control

You can operate Sharp TVs with this system's remote control.

■ Watching TV

Point the remote control at the TV.

- 1 Press the TV ON/STAND-BY button to turn on the TV.
- 2 Pressing the TV CH ∨ or ∧ button enables TV channel switching.
- 3 Press the TV VOL. + or - button to adjust the TV volume.

Other operable button

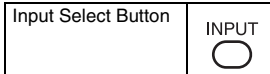

Troubleshooting chart

Many potential problems can be resolved by the owner without calling a service technician.

If something is wrong with this product, check the following before calling your authorized SHARP dealer or service center.

General

Symptom	Possible cause
<ul style="list-style-type: none"> No sound is heard. 	<ul style="list-style-type: none"> Is the input signal (selection) set properly? Is the volume level set to "0"? Is muting activated? Is HDMI compliant equipment being used? Is the HDMI cable connected correctly? Connect the HDMI cable correctly and then perform the reset procedure. (refer page 22) Do not connect or disconnect an HDMI cable while power is on. This may lead to operation problems.
<ul style="list-style-type: none"> The sound from subwoofer is not well balanced. 	<ul style="list-style-type: none"> Is the subwoofer level set to the minimum or maximum level?
<ul style="list-style-type: none"> Power turns off suddenly. 	<ul style="list-style-type: none"> Is the HDMI cable connected correctly? Connect the HDMI cable correctly and then perform the reset procedure.
<ul style="list-style-type: none"> Noise is heard during playback. 	<ul style="list-style-type: none"> Move the speaker away from any computers or mobile phones.
<ul style="list-style-type: none"> When a button is pressed, the unit does not respond. 	<ul style="list-style-type: none"> Set the unit to the stand-by mode and then turn it back on.
<ul style="list-style-type: none"> The power is not turned on. 	<ul style="list-style-type: none"> Is the unit unplugged? The protection circuit may be activated. Unplug and plug in the power cord again after 5 minutes or more.
<ul style="list-style-type: none"> 3D images not displayed on the TV. 	<ul style="list-style-type: none"> Depending on the TV and Video component, 3D images may not be displayed. Check the operation manual of the respective component. HDMI cable not support 3D image.

Remote control

Symptom	Possible cause
<ul style="list-style-type: none"> The remote control does not operate properly. 	<ul style="list-style-type: none"> Is the battery polarity correct? Is the battery dead? Is the distance or angle incorrect? Are there any obstructions in front of the unit? Is there a strong light shining on the remote sensor? Is the remote control for another equipment used simultaneously?
<ul style="list-style-type: none"> The unit cannot be turned on with the remote control. 	<ul style="list-style-type: none"> Is the AC power cord of the unit plugged in? Is the battery inserted?

Tuner

Symptom	Possible cause
<ul style="list-style-type: none"> The radio makes unusual noises continuously. 	<ul style="list-style-type: none"> Is the unit placed near the TV or computer? Is the FM antenna or AM loop antenna placed properly? Move the antenna away from the AC power cord if it is located nearby.

Condensation

Sudden temperature changes, storage or operation in an extremely humid environment may cause condensation inside the cabinet or on the transmitter on the remote control. Condensation can cause the unit to malfunction. If this happens, leave the power on until normal playback is possible (about 1 hour). Wipe off any condensation on the transmitter with a soft cloth before operating the unit.

If problem occurs during operation

When this product is subject to strong external interference (mechanical shock, excessive static electricity, abnormal supply voltage due to lightning, etc.) or if it is operated incorrectly, it may malfunction.

Troubleshooting chart (continued)

If such a problem occurs, do the following:

1. Set the unit to the stand-by mode and turn the power on again.
2. If the unit is not restored in the previous operation, unplug and plug in the unit again, and then turn the power on.

Factory reset, clearing all memory

Make sure to disconnect all output and input cables attached to the unit before performing the factory reset.

1. Press the ON/STAND-BY button to enter the power stand-by mode.
2. While pressing the EQ button, press and hold the ON/STAND-BY button until "RESET" appears.



Caution:

This operation will erase all data stored in memory including clock, timer settings and tuner preset.

Maintenance

Cleaning the cabinet

Periodically wipe the cabinet with a soft cloth.

Caution:

- Do not use chemicals for cleaning (gasoline, paint thinner, etc.). It may damage the cabinet finish.
- Do not apply oil to the inside of each component. It may cause malfunctions.

Error indicators and warnings

When you fail to perform operations properly, the following messages are displayed on the unit.

Display	Meaning
	<ul style="list-style-type: none"> ● Malfunction of the surround circuit. Place the speaker away from noise source and plug the AC power cord into another AC outlet. (*)
	<ul style="list-style-type: none"> ● When there is no input signal. Play back the connected equipment. ● Nonstandard signal. Cannot be recognized. ● Signals other than DOLBY DIGITAL, DTS, Linear PCM cannot be recognized. ● Poor connection of the digital audio input terminal. ● Turn off the unit and check if the cable is connected properly.
	<ul style="list-style-type: none"> ● When the protection circuit is activated.
	<ul style="list-style-type: none"> ● The cooling fan at the rear of the unit does not run. Unplug the AC power cord and check if foreign objects get caught around the cooling fan. (*)

(*): Should the same message appear even if the speaker is unplugged and plugged in, or is set to the stand-by mode and on again, contact your local dealer where you purchased the unit.

Specifications

As part of our policy of continuous improvement, SHARP reserves the right to make design and specification changes for product improvement without prior notice. The performance specification figures indicated are nominal values of production unit. There may be some deviations from these values in individual unit.

Main unit

Power source	AC 120 - 60 Hz
Power consumption	88 W
Dimension	Width: 4 - 1/2" (103 mm) Height: 16 - 9/16" (421 mm) Depth: 15 - 1/2" (395 mm)
Weight	12.34 lbs (5.6 kg)
Output power	RMS: Total 400 watts RMS: Front Left/Right: 100 watts per channel into 4 ohms at 1 kHz, 10% total harmonic distortion Center: 100 watts per channel into 4 ohms at 1 kHz, 10% total harmonic distortion Subwoofer: 100 watts per channel into 4 ohms at 100 Hz, 10% total harmonic distortion FTC: Front:(Left/Right/Center): Minimum 80 watts per channel into 4 ohms at 120 Hz to 20 kHz, 1% total harmonic distortion Subwoofer: Minimum 80 watts per channel into 4 ohms at 100 Hz, 1% total harmonic distortion
Output terminal	HDMI™ output: (audio/video support up to 1080p) x 1
Input terminal	Analog input (LINE 1): Stereo mini jack Ø 3.5 mm 100 mV / 47 kohms Analog input (LINE 2): RCA type x 1pair (L/R) 500 mV / 47 kohms Coaxial digital input (DIGITAL 2): RCA type x 1 Optical digital input (DIGITAL 1): Square type x 1 HDMI input: (audio/video support up to 1080p) x 3

Tuner

Frequency range	FM: 87.5 - 108.0 MHz AM: 530 - 1,710 kHz
------------------------	---------------------------------------------

Soundbar (Speaker Right / Center / Left)

Type	Full Range speaker system 2 - 1/2" (6.5 cm) speaker
Maximum input power	200 W
Rated input power	100 W
Impedance	4 ohms
Dimensions	Width: 36 - 1/4" (920 mm) Height: 3 - 3/8" (85mm) Depth: 3 - 1/8" (79 mm)
Weight	4.41 lbs. (2.0 kg)

Subwoofer

Type	Subwoofer system 6 - 5/16" (16 cm) woofer
Maximum input power	200 W
Rated input power	100W
Impedance	4 ohms
Dimensions	Width: 4 - 1/2" (114 mm) Height: 16 - 9/16" (421 mm) Depth: 15 - 1/2" (395 mm)
Weight	9.92 lbs. (4.5 kg)

Free Manuals Download Website

<http://myh66.com>

<http://usermanuals.us>

<http://www.somanuals.com>

<http://www.4manuals.cc>

<http://www.manual-lib.com>

<http://www.404manual.com>

<http://www.luxmanual.com>

<http://aubethermostatmanual.com>

Golf course search by state

<http://golfingnear.com>

Email search by domain

<http://emailbydomain.com>

Auto manuals search

<http://auto.somanuals.com>

TV manuals search

<http://tv.somanuals.com>