

SHARP

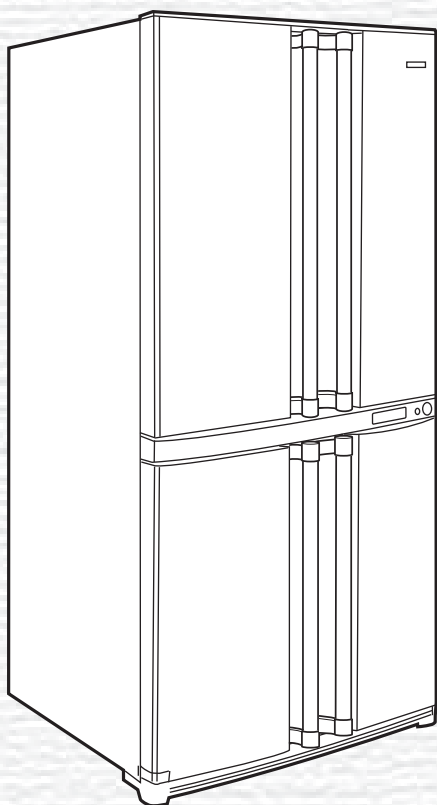

MODEL

SJ-F624ST

SJ-F676ST

REFRIGERATOR - FREEZER OPERATION MANUAL

CONTENTS

• WARNING	2
• CAUTION	2
• INSTALLATION	3
• DESCRIPTION	4
• OPERATION	5
• STORING FOOD	6
• CARE AND CLEANING	7
• BEFORE YOU CALL FOR SERVICE	8
• SPECIFICATION	9
• WARRANTY	10

Thank you very much for buying this SHARP product. Before using your SHARP refrigerator, please read this operation manual to ensure that you gain the maximum benefit from it.

- This refrigerator is for household only, with ambient temperature between +5°C and +43°C. The refrigerator should not be subjected to temperatures of -10°C or below for a long period of time.

Household use only

WARNING

- This refrigerator contains flammable refrigerant (R600a: isobutane) and insulation blowing gas (cyclopentane). Observe the following rules to prevent ignition and explosion.
 - The refrigeration system behind and inside the refrigerator contains refrigerant. Do not allow any sharp objects to come into contact with the refrigeration system.
 - Do not use mechanical devices or other means to accelerate the defrosting process. (This refrigerator has adopted automatic defrosting system.)
 - Do not use electric appliances inside the refrigerator.
 - Use only the specified parts for the refrigerator compartment light.
 - Do not block the openings on the circumference of the refrigerator.
 - Do not use flammable sprays, such as spray paint near the refrigerator. It may cause explosion or fire.
 - If the refrigeration system should get punctured, do not touch the wall outlet and do not use open flames. Open the window and air out the room. Then ask a service agent approved by SHARP for servicing.
 - This refrigerator should be disposed appropriately. Take the refrigerator to a recycling plant for flammable refrigerant and insulation blowing gases.
- Do not store highly volatile and flammable materials such as ether, petrol, propane gas, aerosol cans, adhesive agents and pure alcohol etc. These materials are liable to explode.
- Dust deposited on the power plug may cause fire. Wipe it off carefully.
- Do not attempt to change or modify this refrigerator. This may result in fire, electric shock or injury.
- Ensure that the refrigerator presents no danger to children while being stored for disposal. (e.g. remove the magnetic door seals to prevent child entrapment.)

CAUTION

- Attention about Power supply:
 - Do not use an extension cord or adapter plug.
 - Make sure that the power cord has not been damaged during installation or moving. If the power plug or cord is loose, do not insert the power plug. There is a risk of electric shock or fire.
 - Disconnect from the mains electricity supply by removing the mains plug from the electricity supply socket. Do not remove by pulling the mains lead. This may cause electric shock or fire.
 - Should the flexible supply cord be damaged, it must be replaced by a service agent approved by SHARP as a special cord is required.
- Do not touch the compressor unit or its peripheral parts, as they become extremely hot during operation and the metal edges may cause injury.
- Do not touch foods or metal containers in the freezer compartment with your wet hands. This may cause frostbite.
- Do not place bottled and canned drinks in the freezer as they may crack when frozen.
- In case of gas leak, ventilate the area by opening a window, etc. Do not touch the refrigerator or the power outlet.
- Do not place objects containing liquid or unsteady objects on top of refrigerator.
- This appliance can be used by children aged from 8 years and above and persons with reduced physical, sensory or mental capabilities or lack of experience and knowledge if they have been given supervision or instruction concerning use of the appliance in a safe way and understand the hazards involved. Children shall not play with the appliance. Cleaning and user maintenance shall not be made by children without supervision.

WARNING

- Do not install the refrigerator in a damp or wet location as this may cause damage to the insulation and a leakage. Condensation may also build on the outer cabinet and cause rust.

1 Keep adequate ventilation space around the refrigerator.

- The figure shows the minimum required space for installing the refrigerator. The amount of space around the refrigerator affects the amount of power consumption.
- Insufficient spacing will decrease cooling efficiency and increase energy consumption. This may reduce the life of the unit and void warranty.
- If using the refrigerator in the smaller space dimension than the below figure, it may cause the temperature rise in the unit, loud noise and failure.
- The space between the rear of the refrigerator and the wall should be 60mm or more and less than 75mm. If the space is wider than 75mm, you may get injured by touching compressor and its peripheral parts which are extremely hot during the operation.

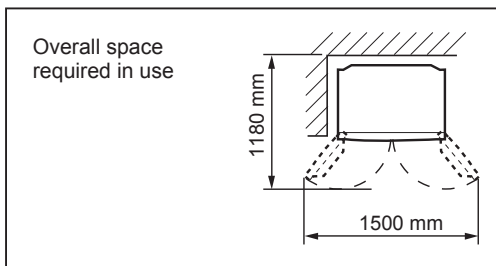
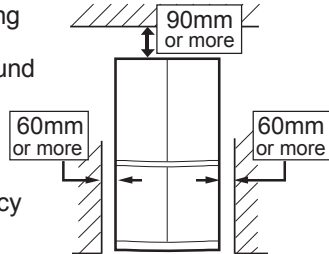

2 Use the two front adjustable feet, to ensure that the refrigerator is positioned firmly and flat on the floor.

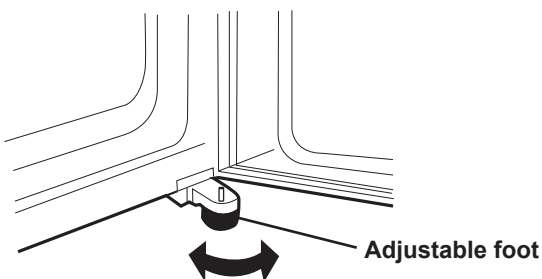

3 When right and left doors are not properly aligned, adjust using the adjustable feet.

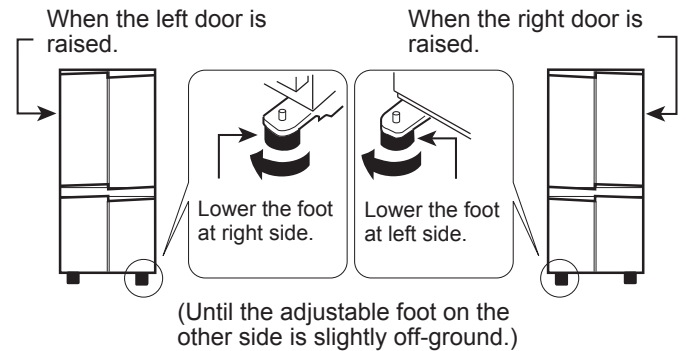

4 Remove the 4 screws of the cabinet lower part, and then set the foot cover (supplied inside the refrigerator compartment) with removed 4 screws.

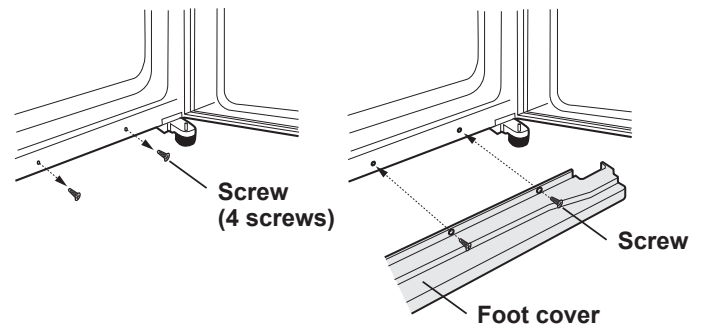

5 Connect the power plug to a 230/240 volt. 10 amp. power point.

NOTE

- Position your refrigerator so that the plug is accessible.
- Keep your refrigerator out of direct sunlight.
- Do not place next to heat generating appliance.
- Do not place directly on the ground. Provide suitable stand.
- If the mains power is switched on when the door is open, the door alarm will sound. Close the door to stop the alarm.

Before using your refrigerator

Clean the inside parts with a cloth soaked in warm water. If soapy water is used, wipe it off thoroughly with water.

DESCRIPTION

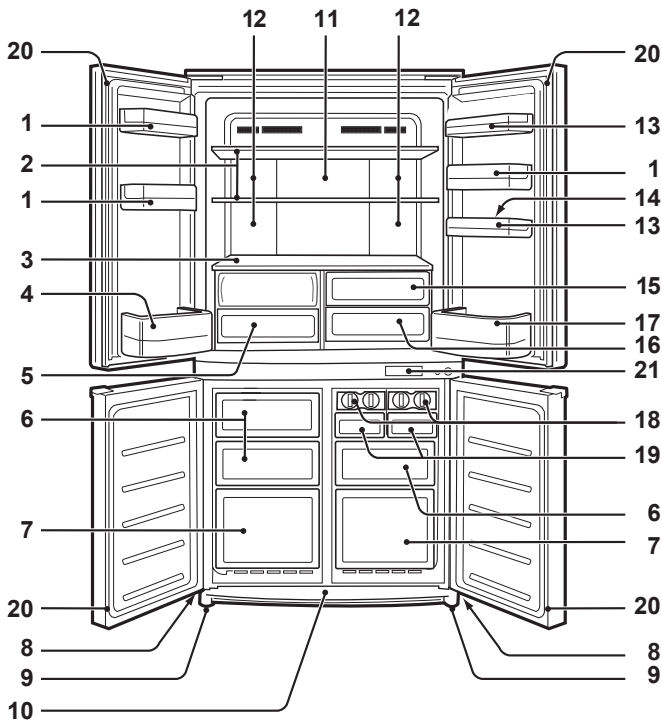

SJ-F676ST

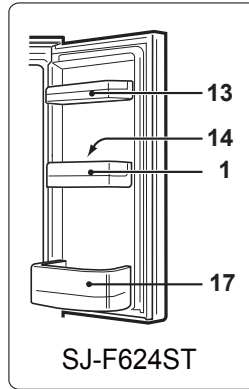

SJ-F624ST

21. Control panel and electronic display

- The preset temperature is displayed. (It is not an actual temperature in the compartment.)
- The display of the refrigerator compartment and the freezer compartment can be changed by pressing the CHOOSE button.

Refrigerator compartment preset temperature

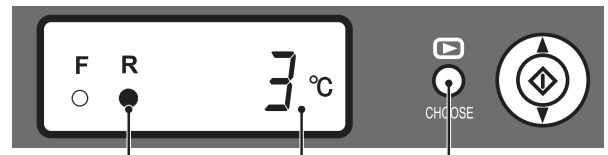

R lamp (lighting) LED display CHOOSE button
It suggests "Refrigerator".



Freezer compartment preset temperature

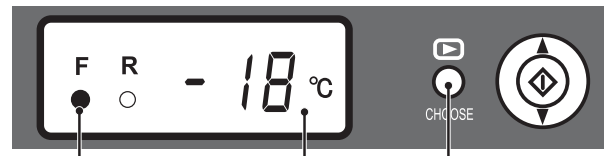

F lamp (lighting) LED display CHOOSE button
It suggests "Freezer".

NOTE

The LED lamp and the temperature display will turn off when there is no operation for 1 minute. (When either of buttons is pressed, it lights again.)

1. Door pocket
2. Adjustable glass shelf
3. Fixed glass shelf
4. Bottle pocket (left)
5. Vegetable crisper
6. Freezer case (small)
7. Freezer case (large)
8. Casters
9. Adjustable feet
10. Foot cover

11. Hybrid cooling panel

The panel is cooled from the rear, thus indirectly cooling the refrigerator compartment. In this way, food is refrigerated gently, without exposing it to cold air flow.

12. Light

13. Utility pocket

(SJ-F624ST ; 1 pocket, SJ-F676ST ; 2 pockets)

14. Egg tray

15. Fruit case

16. Fresh case

17. Bottle pocket (right)

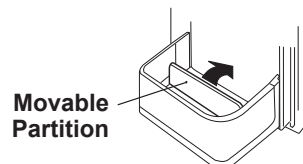

18. Ice cube maker

When the ice cubes are made, turn the lever clockwise to empty the ice into the Ice storage box. Do not overfill the tray.

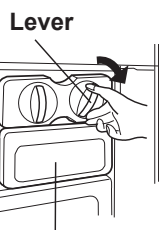

19. Ice cube box

20. Magnetic door seal

Ice storage box

If you wish to store large items within your freezer

You may remove any of the items numbered 6,7,18,19.

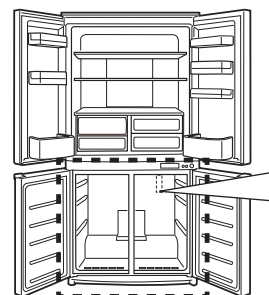

How to remove

To remove the partition, pull it to the front while pushing the claw.

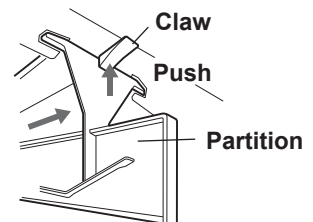

How to set

Insert the four projections into the upper parts.

OPERATION

Controlling Temperature

The refrigerator controls its temperature automatically. However, if needed, adjust the temperature as follows.

Refrigerator compartment

- 1 Press the CHOOSE button and make the R lamp to light.

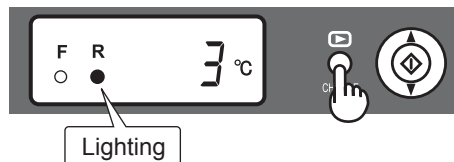

- 2 Press the ▲ / ▼ button and select the desired temperature.

[▲ : increase, ▼ : decrease]



- 3 Press the "◊" button.

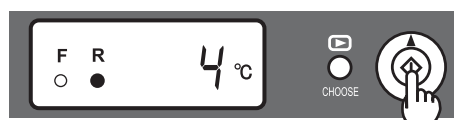

Adjustable between 0°C and 6°C in steps of 1°C.

↑ 6°C	When the refrigerator provides excessive cooling.
3°C	When the refrigerator provides excessive cooling.
↓ 0°C	For keeping foods fresher tasting. When the refrigerator does not provide sufficient cooling.

Deodorising unit

A built-in unit which requires no manual operation because it automatically starts operating when the refrigerator is powered on.

Defrosting

- The defrosting system incorporates a fully automatic energy efficient defrosting system.
- The defrost water collects in the evaporating pan, where it is evaporated by the heat of the compressor, etc.
- The evaporating pan does not require cleaning or maintenance.

Freezer compartment

- 1 Press the CHOOSE button and make the F lamp to light.

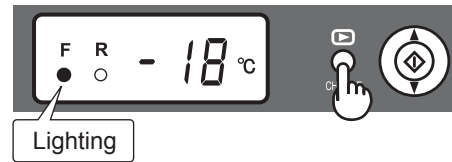

- 2 Press the ▲ / ▼ button and select the desired temperature.

[▲ : increase, ▼ : decrease]



- 3 Press the "◊" button.

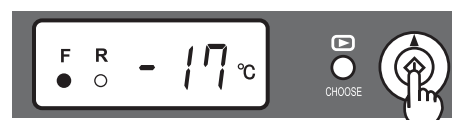

Adjustable between -13°C and -21°C in steps of 1°C.

↑ -13°C	When frozen food or ice cream is not stored.
-18°C	For normal freezing.
↓ -21°C	For making ice rapidly or fast freezing.

Door Alarm

When the refrigerator or freezer door is left open, the door alarm will sound.

- The door alarm will sound 1 minute after opening the door and again after 1 minute (once in each case).
- If the door is left open for approx. 3 minutes, the alarm will sound continuously.

To cancel operation

Press the "◊" button continuously 3 seconds or more while holding down the CHOOSE button.

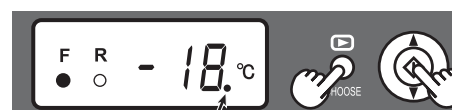

It shows the door alarm stop.

It is the same method also when restarting the operation.

STORING FOOD

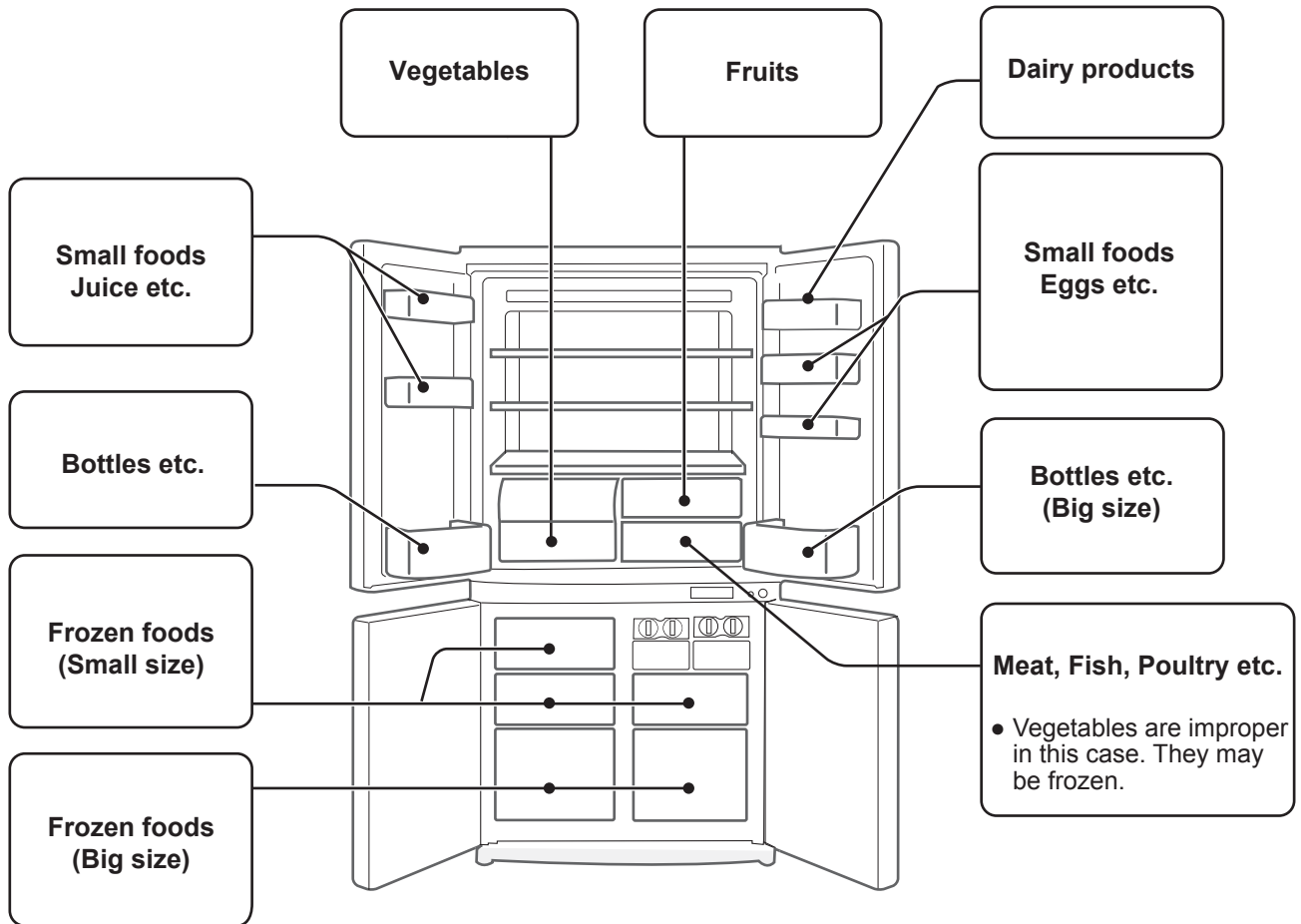

Refrigeration reduces the rate of food spoilage. To maximise the shelf life of perishable food products, ensure that the food is of the freshest possible quality. The following is a general guide to help promote longer food storage.

Fruit / Vegetables

To minimize moisture loss, fruit and vegetables should be loosely enclosed in a plastic material (e.g. wrap, bags) and place in the vegetable crisper and fruit case. If you store a lot of vegetables, dew may form. This has no effect on the operation or the performance. Use a dry cloth to remove the dew.

Dairy Products & Eggs

- Most dairy products have a use by date on the outer packaging which informs the recommended temperature and shelf life of the product.
- Eggs should be stored in the Egg tray.

Meats / Fish / Poultry

- Place on a plate or dish and cover with paper or plastic wrap.
- For larger cuts of meat, fish, or poultry, place to the rear of the shelves.
- Ensure all cooked food is wrapped securely or placed in an airtight container.

NOTE

- Evenly place the food on the shelves to allow the cooling air to circulate efficiently.
- Hot foods should be cooled before storing. Storing hot foods increases the temperature in the unit and increases the risk of food spoilage.
- Do not block the outlet and inlet of the cool air circulating circuit with foods or containers; otherwise the foods will not be evenly cooled throughout the refrigerator.
- Keep the door securely closed.

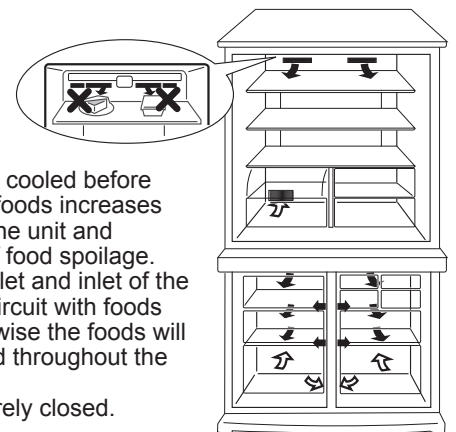

← IN
→ OUT

Do not place food directly in front of cold air outlet. This may lead to the food freezing.

For best freezing

- Quality of foods should be fresh.
- Freeze small quantities of food at a time to freeze them quickly.
- Food should be properly sealed, sealed tightly or covered.
- Evenly place the food in the freezer.
- Label bags or containers to keep an inventory of frozen food.

CARE AND CLEANING

WARNING

- Unplug the refrigerator first to prevent electric shock.
- Do not splash water directly on the outer cabinet or the interior. This may lead to rusting and deterioration of the electrical insulation.

IMPORTANT

To prevent cracking on inside surfaces and plastic components, follow these tips.

- Wipe any food oils adhered to plastic components.
- Some household chemicals may cause damage, so use only diluted washing-up liquid (soapy water).
- If undiluted detergent is used or soapy water is not wiped off thoroughly, cracking of plastic parts can result.
- Wipe any spills from the refrigerator immediately as acid or alkaline in the food can cause cracking and staining of plastic parts.

- 1 Remove the accessories e.g. shelves from the cabinet and door. Wash them in warm soapy dishwashing water; rinse in clean water and dry.
- 2 Clean the inside with a cloth soaked in warm soapy dishwashing water. Then, use cold water to wipe off soapy water.
- 3 Wipe the exterior with a soft cloth each time it is soiled.
- 4 Clean the Magnetic door seal with a toothbrush and warm soapy dishwashing water.
- 5 Wipe the control panel with the dry cloth.

NOTE

- Do not use hot water, household cleaning powders, creams or spray-on cleaning products, or any other cleaning products such as mineral turpentine, methylated spirits, thinners, petrol etc. These may damage your refrigerator and may void any warranty.
- If the power supply is disconnected, please wait for at least 5 minutes before re-connecting power.
- The glass shelves weigh approximately 3 kg each. Hold firmly when removing from the cabinet or carrying.
- Do not drop objects inside the refrigerator or strike the inner wall. This may cause the inner surface to crack.

Replacing method of the lamp bulb

1. Unplug the refrigerator first to prevent electric shock.
2. Remove the light cover.
3. Replace the lamp bulb with the same type.

Lamp cap E14, MAX 15W, 4 pieces

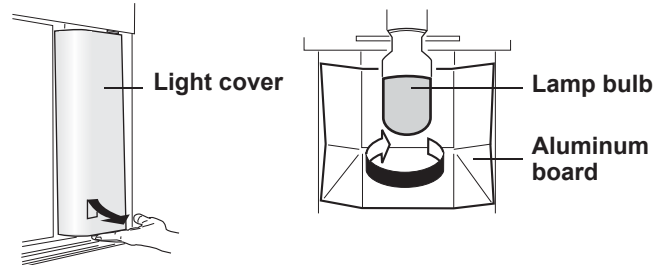

CAUTION

Do not touch the aluminum board around the lamp. The edge face of the metal may cause injury.

When transporting

- Wipe up water in the evaporating pan. Before wiping up the water, wait more than 1 hour after pulling out the plug because refrigeration cycle equipment is extremely hot. (The evaporating pan is located on the rear of the product.)

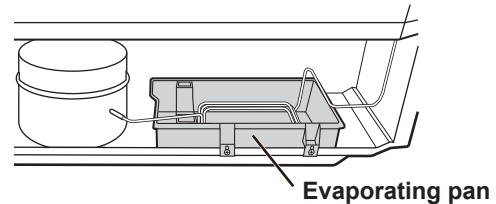

- The casters allow the refrigerator to move back and forth.

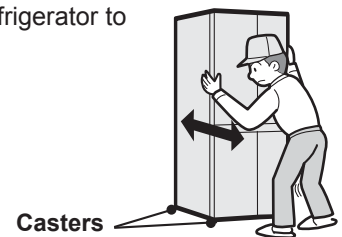

- Carry the refrigerator by holding the handles located on the rear and bottom.

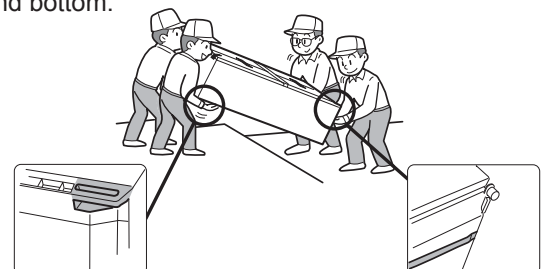

Switching off your refrigerator

If the refrigerator needs to be switched off for an extended period, the following steps should be taken to reduce the growth of mould:

1. Remove all food.
2. Remove the power plug from the power point.
3. Clean and dry the interior thoroughly.
4. Ensure that all the doors are wedged open slightly for air circulation.

BEFORE YOU CALL FOR SERVICE

Before you call for service, check the following points.

Problem	Solution
The outside of the cabinet is hot when touched.	This is normal. The hot pipe is in the cabinet in order to prevent condensation generation.
When there is refrigerator noise.	<p>It is normal for the refrigerator to produce the following sounds.</p> <ul style="list-style-type: none"> • Loud noise produced by the compressor when operation starts --- Sound becomes quieter after a while. • Loud noise produced once a day by the compressor --- Operating sound produced immediately after automatic defrost operation. • Sound of flowing fluid (gurgling sound, fizzing sound) --- Sound of refrigerant flowing in pipes (sound may become louder from time to time). • Cracking or crunching sound, squeaking sound --- Sound produced by expansion and contraction of inner walls and internal parts during cooling.
Frosting or condensation generation occurs inside or outside the refrigerator.	<p>This may occur in one of the following cases. Use a wet cloth for wiping frost and a dry cloth for wiping condensation.</p> <ul style="list-style-type: none"> • When the ambient humidity is high. • When the door is frequently opened and closed. • When food containing plenty of moisture is stored. (Wrapping is required.)
The foods in the refrigerator compartment freeze.	<ul style="list-style-type: none"> • Is the refrigerator operated for a long time with refrigerator temp. control set at 0°C? • Is the refrigerator operated for a long time with freezer temp. control set at -21°C? • Low ambient temperature may cause food to freeze even if refrigerator temp. control is set to 6°C.
Noticeable odours.	<ul style="list-style-type: none"> • Wrapping is required for food with strong odours.
The control panel does not work.	<p>This may occur in one of the following cases.</p> <ul style="list-style-type: none"> • The panel or your finger is soiled with dripping, oil and etc. • When you touch the panel with gloved hand, adhesive bandage on your finger, nail or objects. • Sticker or tape is affixed on the keys. • Touch position is slightly off from the keys. • Operate time is not enough for the keys to work.

If you still require service contact your SHARP Approved Service Centre.

SHARP Approved Service Centre locations can be found in the Support area of our website:

Australia : <http://www.sharp.net.au>

New Zealand : <http://www.sharp.net.nz>

SPECIFICATION

		SJ-F624ST	SJ-F676ST
Rated voltage (V~)		220 - 240	
Rated frequency (Hz)		50	
Rated current (A)		1.3 - 1.4	
Rated input of heating systems (W)		180- 210	
Defrosting input (W)		180- 210	
Climate class		T	
Internal input (W)		15max. × 4pcs.	
Refrigerant		R600a	
Charge (g)		77	
Insulation blowing gas		Cyclo pentane	
Rated storage volume (L)		552	600
Rated gross volume (L)		624	676
Group (AS / NZS 4474.1)		5B	
Net weight (kg)		104	107
Outer dimensions (mm)	Height	1720	1830
	Width	890	890
	Depth	770	770

SHARP

WARRANTY

Consumer Electronic Products

Congratulations on Your Purchase!

This Sharp product is warranted against faults in material and manufacture for the period as stated in the table below.

If service is required during the warranty period, please contact your nearest Sharp Approved Service Centre. These repairs would be carried out at no charge to the owner, subject to the conditions specified herein.

This warranty does not extend to defects or injuries caused by or resulting from causes not attributable to faulty parts or the manufacture of the product, including but not limited to, defect or injury caused by or resulting from misuse, abuse, neglect, lack of maintenance, accidental damage, improper voltage, liquid spillage, vermin infestation, software, or any alterations made to the product which are not authorised by Sharp.

Please retain your sales documentation, as this should be produced to validate a warranty claim. This warranty is in addition to and in no way limits, varies or excludes any implied rights and remedies under any relevant legislation in the country of sale.

This warranty does not cover transportation to and from the Sharp Approved Service Centre. Goods presented for repair may be replaced by refurbished goods of the same type rather than being repaired. Refurbished parts may be used to repair the goods. The repair of your goods may result in the loss of user generated data, please ensure that you have saved this data elsewhere prior to repair.

Australian customers: Our goods come with guarantees that cannot be excluded under the Australian Consumer Law. You are entitled to a replacement or refund for a major failure and for compensation for any other reasonably foreseeable loss or damage. You are also entitled to have the goods repaired or replaced if the goods fail to be of acceptable quality and the failure does not amount to a major failure. The criteria of a major failure is defined in the Australian Consumer Law. Should you require any assistance with a major failure please contact Sharp Customer Care.

WARRANTY PERIODS

Home Theatre Projector	12 months (excluding lamps and air filters)
Audio/Home Theatre	12 months
Microwave Oven	12 months
Steam Oven	12 months
Refrigerator	24 months
DVD/Blu-ray	12 months
Air Conditioner	60 months
Portable Air Conditioner	12 months
LCD Television	36 months
Air Purifier	12 months

SHARP
SHARP CORPORATION OF AUSTRALIA PTY. LIMITED
ABN 40 003 039 405
1 Huntingwood Drive
Huntingwood NSW 2148

SHARP CORPORATION OF NEW ZEALAND LIMITED
59 Hugo Johnston Drive
Penrose, Auckland

SPform 040 (AUGUST 2011)

IMPORTANT NOTICE: This warranty applies only to products sold in Australia & New Zealand

SHARP

FOR LOCATION ENQUIRIES WITHIN

AUSTRALIA

REGARDING YOUR LOCAL

SHARP APPROVED SERVICE CENTRE

VISIT OUR WEBSITE AT

www.sharp.net.au

OR CALL SHARP CUSTOMER CARE

1300 135 022

(LOCAL CALL COSTS APPLY WITHIN AUSTRALIA)

SHARP CORPORATION OF AUSTRALIA PTY LTD

SHARP

FOR LOCATION ENQUIRIES WITHIN

NEW ZEALAND

REGARDING YOUR LOCAL

SHARP APPROVED SERVICE CENTRE

VISIT OUR WEBSITE AT

www.sharp.net.nz

CONTACT YOUR SELLING DEALER/RETAILER

OR CALL

SHARP CUSTOMER SERVICES

TELEPHONE: 09 573 0111

FACSIMILE: 09 573 0113

SHARP CORPORATION OF NEW ZEALAND LIMITED

SHARP

SHARP CORPORATION OF AUSTRALIA PTY.LTD.

A. B. N. 40 003 039 405

1 HUNTINGWOOD DRIVE, HUNTINGWOOD, N.S.W. 2148

P.O.BOX 6827, BLACKTOWN. N.S.W. 2148

SHARP CORPORATION OF NEW ZEALAND LIMITED

59 HUGO JOHNSTON DRIVE P.O. BOX 12244, PENROSE, AUCKLAND

Printed in Thailand

TINS-B494CBRZ 13KK (TH) ①

Free Manuals Download Website

<http://myh66.com>

<http://usermanuals.us>

<http://www.somanuals.com>

<http://www.4manuals.cc>

<http://www.manual-lib.com>

<http://www.404manual.com>

<http://www.luxmanual.com>

<http://aubethermostatmanual.com>

Golf course search by state

<http://golfingnear.com>

Email search by domain

<http://emailbydomain.com>

Auto manuals search

<http://auto.somanuals.com>

TV manuals search

<http://tv.somanuals.com>