

SHARP

SJ-F602SP

SJ-F653SP

REFRIGERATOR - FREEZER OPERATION MANUAL

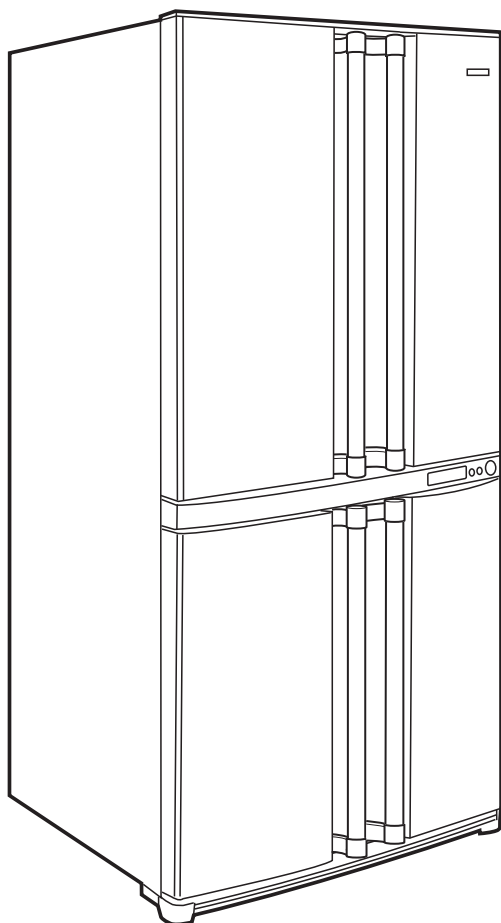

CONTENTS

• WARNING	2
• CAUTION	2
• INSTALLATION	2
• DESCRIPTION	3
• OPERATION (USING THE CONTROL PANEL)	5
• STORING FOOD	8
• CARE AND CLEANING	9
• BEFORE YOU CALL FOR SERVICE	9
• SPECIFICATION	10

• Plasmacluster is a trademark of SHARP Corporation.

Household use only
Free standing type

Thank you for buying this SHARP product. Before using your SHARP refrigerator, please read this operation manual to ensure that you gain the maximum benefit from it.

WARNING

- Highly volatile and flammable materials such as ether, petrol, propane gas, adhesive agents and pure alcohol etc. are liable to explode. Do not store these materials in the refrigerator.
- Dust deposited on the power plug may cause fire. Wipe it off carefully.
- Do not attempt to change or modify this refrigerator. This may result in fire, electric shock or injury.
- Ensure that the refrigerator presents no danger to children whilst being stored for disposal. (e.g. remove the door to prevent child entrapment.)
- This refrigerator should be disposed appropriately. Take the refrigerator to a recycling plant for flammable insulation blowing gases.

CAUTION

- Attention about Power supply:
 - Do not use an extension cord or adapter plug.
 - Make sure that the power cord has not been damaged during installation or moving. If the power plug or cord is loose, do not insert the power plug. There is a risk of electric shock or fire.
 - Disconnect from the mains electricity supply by removing the mains plug from the electricity supply socket. Do not remove by pulling the mains lead. This may cause electric shock or fire.
 - Should the flexible supply cord be damaged, it must be replaced by service agent approved by SHARP as a special cord is required.
- Do not touch food or metal containers in the freezer compartment with wet hands. This may cause frostbite.
- Do not place bottled and canned drinks in the freezer as they may crack when frozen.
- The refrigeration system behind and inside the refrigerator contains refrigerant. If this system is punctured it could result in serious damage to your refrigerator, therefore do not allow any sharp objects to come into contact with the refrigeration system.
- In case of gas leak, ventilate the area by opening a window, etc. Do not touch the refrigerator or the power outlet.
- Do not place objects containing liquid or unsteady objects on top of refrigerator.
- This refrigerator is not intended for use by persons (including children) with reduced physical, sensory or mental capabilities, or lack of experience and knowledge, unless they have been given supervision or instruction concerning use of the refrigerator by a person responsible for their safety. Young children should be supervised to ensure that they do not play with the refrigerator.

INSTALLATION

WARNING

- Do not install the refrigerator in a damp or wet location as this may cause damage to the insulation. Condensation may also build on the outer cabinet and cause rust.

- Keep adequate ventilation space around the refrigerator.
 - The figure shows the minimum required space for installing the refrigerator. The amount of space around the refrigerator affects the amount of power consumption.
 - Insufficient spacing will decrease cooling efficiency and increase energy consumption. This may reduce the life of the unit and void warranty.

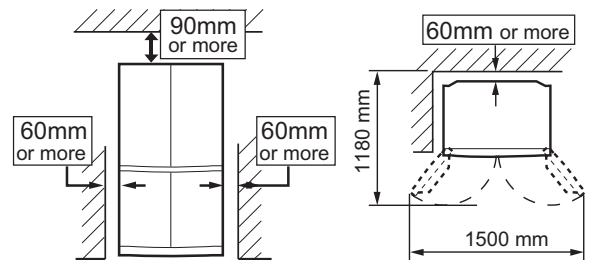

- Using the two front adjustable feet, ensure that the refrigerator is positioned firmly and level on the floor.

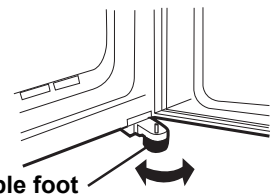

Adjustable foot

- Using the adjustable feet, raise the front of the unit so it leans back slightly, this will assist in door closing. Make final adjustments to ensure that the doors are correctly aligned.

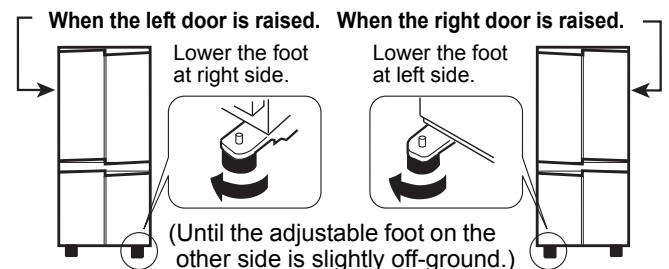

- Remove the 4 screws from the bottom of the refrigerator and use these to fit the foot cover (supplied inside the refrigerator compartment).

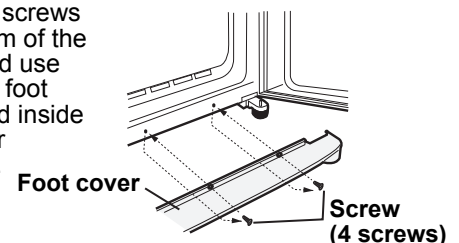

- Connect the power plug to a 230/240 volt. 10 amp. power point.

NOTE

- Position your refrigerator so that the plug is accessible.
- Keep your refrigerator out of direct sunlight.
- Do not place next to heat generating appliance.
- This refrigerator is designed for indoor use only, do not place the unit on an unsealed surface.
- To avoid vibration and misalignment of the doors, the unit must be level. Place the unit on a solid flat surface. Uneven floors eg. slate, tiles and floorboards, can cause the unit to sag over time causing the doors to become misaligned.
- If the mains power is switched on when the door is open, the door alarm will sound. Close the door to stop the alarm.

When transporting

- Using the casters, it is possible to move back and forth.
- Carry the refrigerator by holding the handles located on the rear and bottom.

Before using your refrigerator

Clean the inside parts with a cloth soaked in warm water. If soapy water is used, wipe it off thoroughly with water.

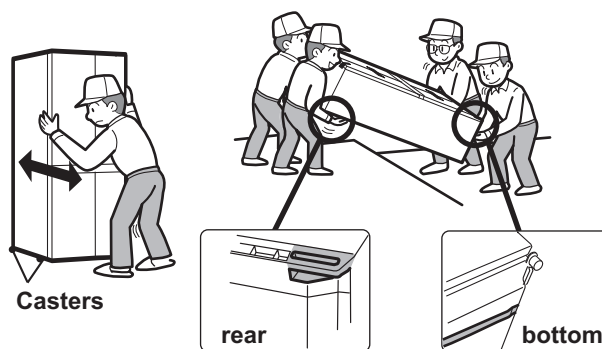

DESCRIPTION

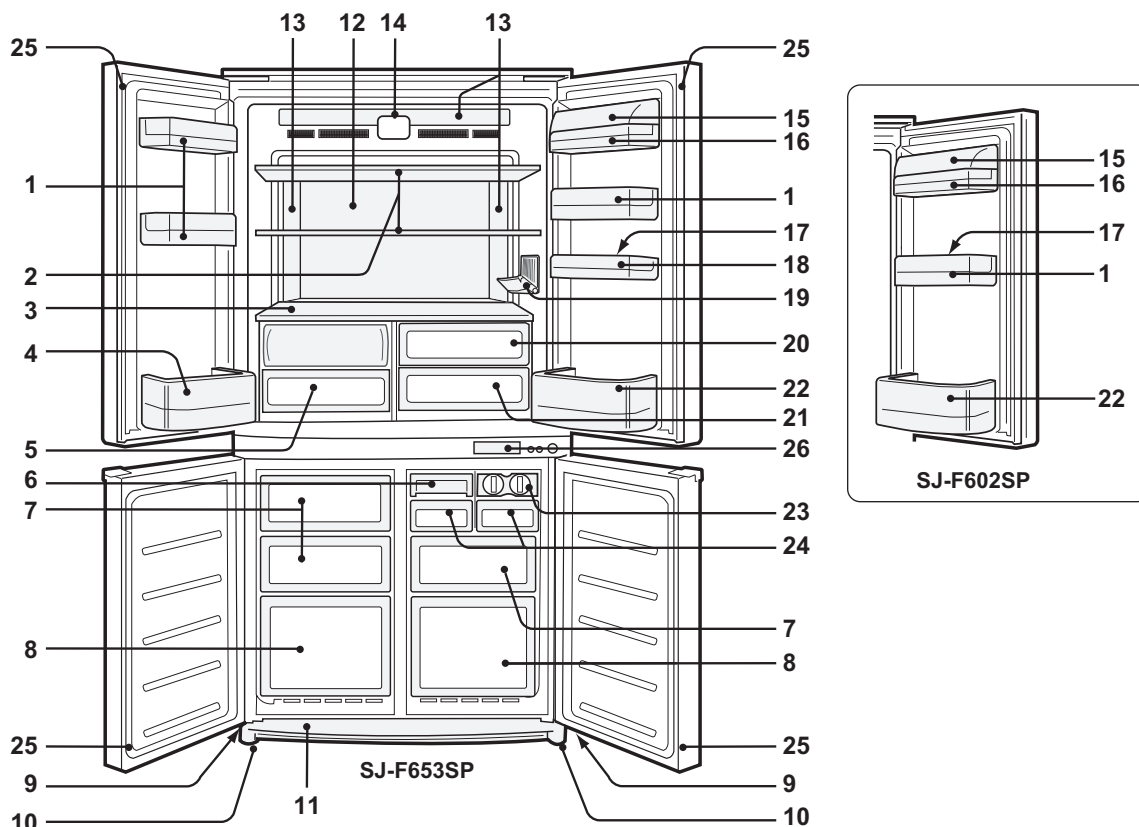

1. Door pocket
2. Adjustable glass shelf
3. Fixed glass shelf
4. Bottle pocket (left)
5. Vegetable crisper
6. Express ice box

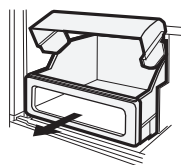

The bottom of the tray contains refrigerant material used in ice packs to speed up the ice making process. The tray can also be used to freeze small food items such as meat and fruits by removing the ice making partition.

7. Freezer case (small)
8. Freezer case (large)
9. Casters

10. Adjustable feet
11. Foot cover

12. Aluminum panel

The panel is cooled from the rear, thus indirectly cooling the refrigerator compartment. In this way, food is refrigerated gently, without exposing it to cold air flow.

13. Refrigerator LED light
14. Plasmacluster light

15. Utility pocket cover
16. Utility pocket
17. Egg tray
18. Egg pocket
19. Bottle rack
20. Fruit case
21. Fresh case
22. Bottle pocket (right)

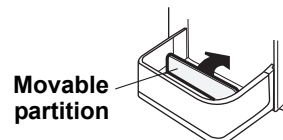
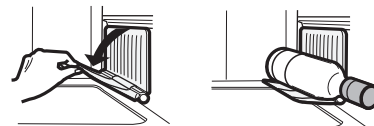

23. Ice cube maker

When the ice cubes are made, turn the lever clockwise to empty the ice into the Ice cube box. Do not overfill the tray.

24. Ice cube box

25. Magnetic door seal

26. Control panel and electronic display

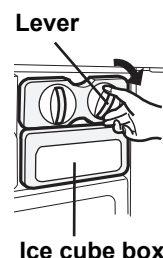

Control panel

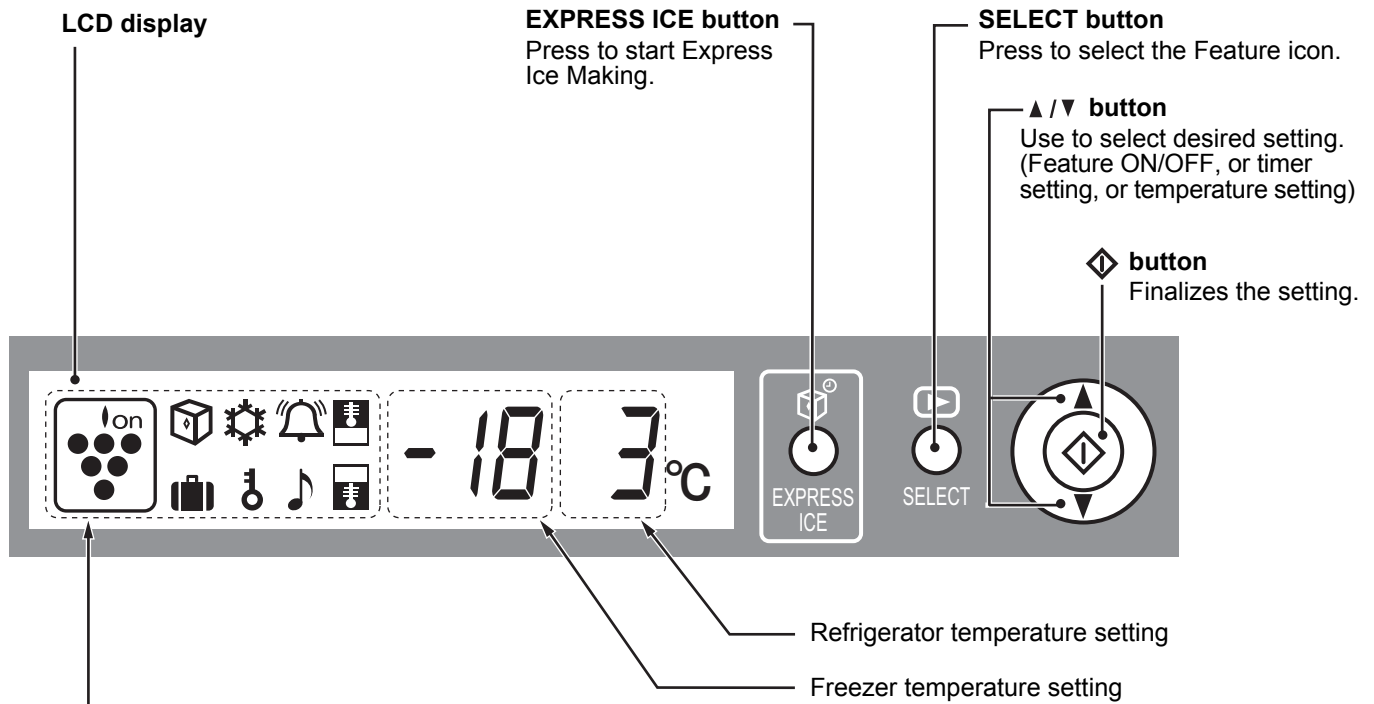

Each icon

Plasmacluster	Refrigerator temp. control
Express Ice Making	Freezer temp. control
Express Freezing	Door alarm
Timer	Child lock
	Holiday mode

• Features that default to “on” when power is applied are:

• In the event of a power failure, Express Ice Making, Express Freezing and Timer Feature are cancelled and will need to be re-entered if required.

NOTE

- When no operation is made for 30 seconds, the display will automatically return to the initial content. The backlight will become dark when there is no operation for 3 minutes. The backlight will turn off when there is no operation for 6 minutes.
- Do not hit or apply sharp object on to the LCD panel.

Deodorising unit

A deodorising catalyst is installed on the routes of cold air. No operation and cleaning required.

Defrosting

Defrosting is fully automatic due to a unique energy saving system.

OPERATION (USING THE CONTROL PANEL)



Controlling Temperature

The refrigerator controls its temperature automatically. However, if needed, adjust the temperature as follows.

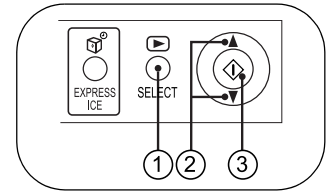

Refrigerator compartment

- Press the "SELECT" button and select the "Refrigerator temp." icon.

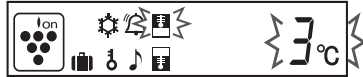

- Press the ▲ / ▼ button to select the desired temperature. [▲ : increase, ▼ : decrease]

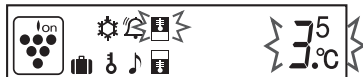

- Press the "◀▶" button.

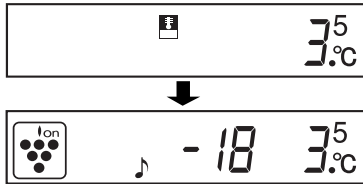

Adjustable between 0°C and 6°C in steps of 0.5°C.

↑ 6°C	When the refrigerator provides excessive cooling.
3°C	For normal operation.
↓ 0°C	For keeping foods fresher tasting. When the refrigerator does not provide sufficient cooling.

Freezer compartment

- Press the "SELECT" button and select the "Freezer temp." icon.

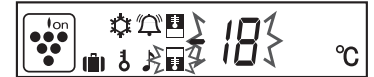

- Press the ▲ / ▼ button to select the desired temperature. [▲ : increase, ▼ : decrease]



- Press the "◀▶" button.

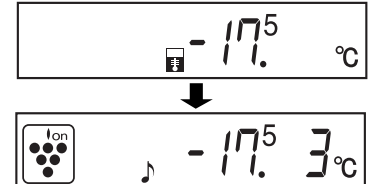

Adjustable between -13°C and -21°C in steps of 0.5°C.

↑ -13°C	When frozen food or ice cream is not stored.
-18°C	For normal freezing.
↓ -21°C	For making ice rapidly or fast freezing.



Express Ice Making

Ice cubes can be made quicker than normal.

- This feature cannot be used simultaneously with Express Freezing.

- Press the "EXPRESS ICE" button.



The icon appears and operation starts.

- When the ice is completed, remove the ice.

To cancel operation

Press the "EXPRESS ICE" button again.

NOTE

- Express Ice Making ends automatically in about 1 hour regardless of ice condition. (The icon disappears.)
- Express Ice Making may take a little longer if the refrigerator is automatically defrosting.
- Avoid opening the door as much as possible during operation of this feature.

How to use the Express ice box

- Cool the Express ice box beforehand in the freezer (for at least 1 day).
- When the ice cubes are made, remove the partition from the tray, after that twist both ends of the partition to release the ice.

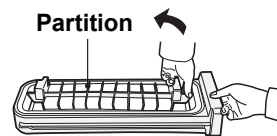

- Tips for making ice cubes in around 20* minutes.

- Use cold water from the refrigerator.
- Avoid unnecessary opening of the doors.
- Don't overfill the Express ice box.

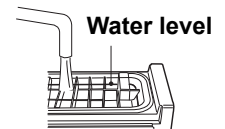

* At a room temperature of 30°C and with the refrigerator set to 3°C and the freezer to -18°C.

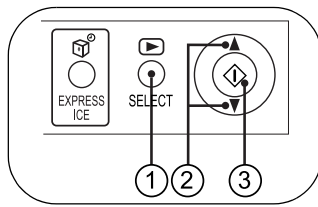

Plasmacluster

The Plasmacluster feature operates whenever the refrigerator is on. Plasmacluster light in the refrigerator compartment lights up blue during operation.

To cancel operation

- 1 Press the "SELECT" button and select the "Plasmacluster" icon.

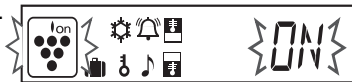

- 2 Press the ▲ / ▼ button and select "OFF".

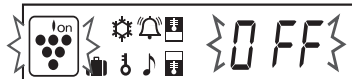

- 3 Press the "◀▶" button.

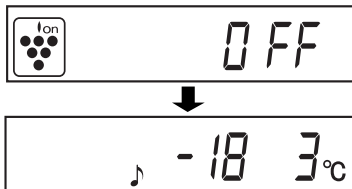

To turn the Plasmacluster back on

Select "ON" in step ②.

Notes about PLASMACLUSTER operation

The Plasmacluster feature inside your refrigerator releases clusters of positive and negative ions into the freezer and refrigerator compartment. These ion clusters help to reduce mould fungus.

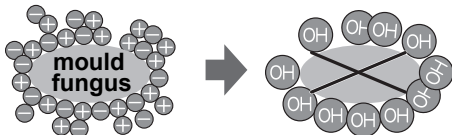

- There may be a slight odours in the refrigerator. This is the smell of ozone generated by the ionizer. The amount of ozone is minimal, and quickly dissipates in the refrigerator.



Express Freezing

High-quality frozen foods can be made using this feature. Convenient for home-freezing of small food items.

- This feature cannot be used simultaneously with Express Ice Making.

- 1 Press the "SELECT" button and select the "Express freezing" icon.



- 2 Press the ▲ / ▼ button and select "ON".



- 3 Press the "◀▶" button.

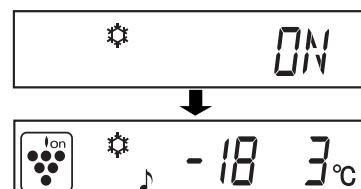

Timer

The timer can be set for up to 99 minutes and 30 seconds, in intervals of 30 seconds.

- 1 Press the "SELECT" button and select the "Timer" icon. The previous timer entry is displayed.

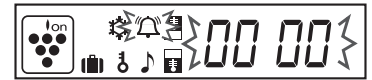

- 2 Press the ▲ / ▼ button and set the time.

[▲ : increase, ▼ : decrease]

Press the button continuously to set the timer quickly.



- 3 Press the "◀▶" button.



Timer starts. The remaining time is displayed.



When the set time is reached, the end tone will sound. (About 30 sec.)

To stop the end tone, press "◀▶".



To cancel the timer

- 1 Press "SELECT" to select the "Timer" icon.



- 2 Press the "◀▶" button.

Express Freezing ends automatically in approximately 2 hours. (The icon disappears.)

To cancel operation

Select "OFF" in step ②.

NOTE

- The time taken to freeze the item will depend on the size, shape and type. For best results, keep items as small as possible.
- Express Freezing may take a little longer if the refrigerator is automatically defrosting.
- Avoid opening the door as much as possible during operation of this feature.

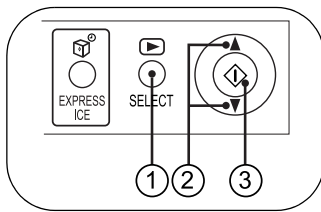

Door Alarm

An alarm will sound momentarily if a door is left open for 1 minute.

If the door is left open for more than 3 minutes, the alarm will sound continuously.

To cancel operation

- Press the "SELECT" button and select the "Door alarm" icon.



- Press the ▲ / ▼ button and select "OFF".



- Press the "◊" button.

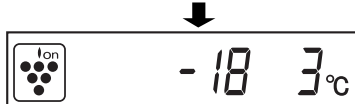

To start operation

Select "ON" in step ②.

Child Lock

The child lock can be turned on to prevent children tampering with the controls.

- Press the "SELECT" button and select the "Child lock" icon.

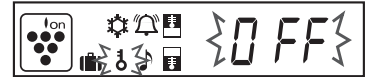

- Press the ▲ / ▼ button and select "ON".

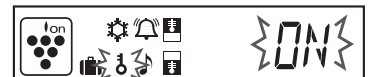

- Press the "◊" button.



To cancel operation

- Press the "SELECT" button continuously for 2 seconds or more.

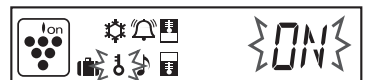

- Select "OFF" with the ▲ / ▼ button and press the "◊" button.

Holiday Mode

Use this power saving feature when going away for extended periods.

- Press the "SELECT" button and select the "Holiday mode" icon.



- Press the ▲ / ▼ button and select "ON".

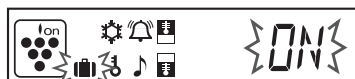

- Press the "◊" button.

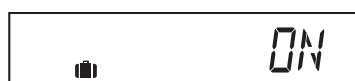

The temperature inside the refrigerator compartment will be adjusted to 10°C. This temperature cannot be modified. The temperature in the freezer is not changed.

To cancel operation

Select "OFF" in step ②.

NOTE

In Holiday Mode, the life of the food in the refrigerator compartment may be reduced to 1/2 or 1/3 of normal. Before going away for extended periods of time, we recommend removing all perishable foods from the refrigerator, before setting this feature.

STORING FOOD

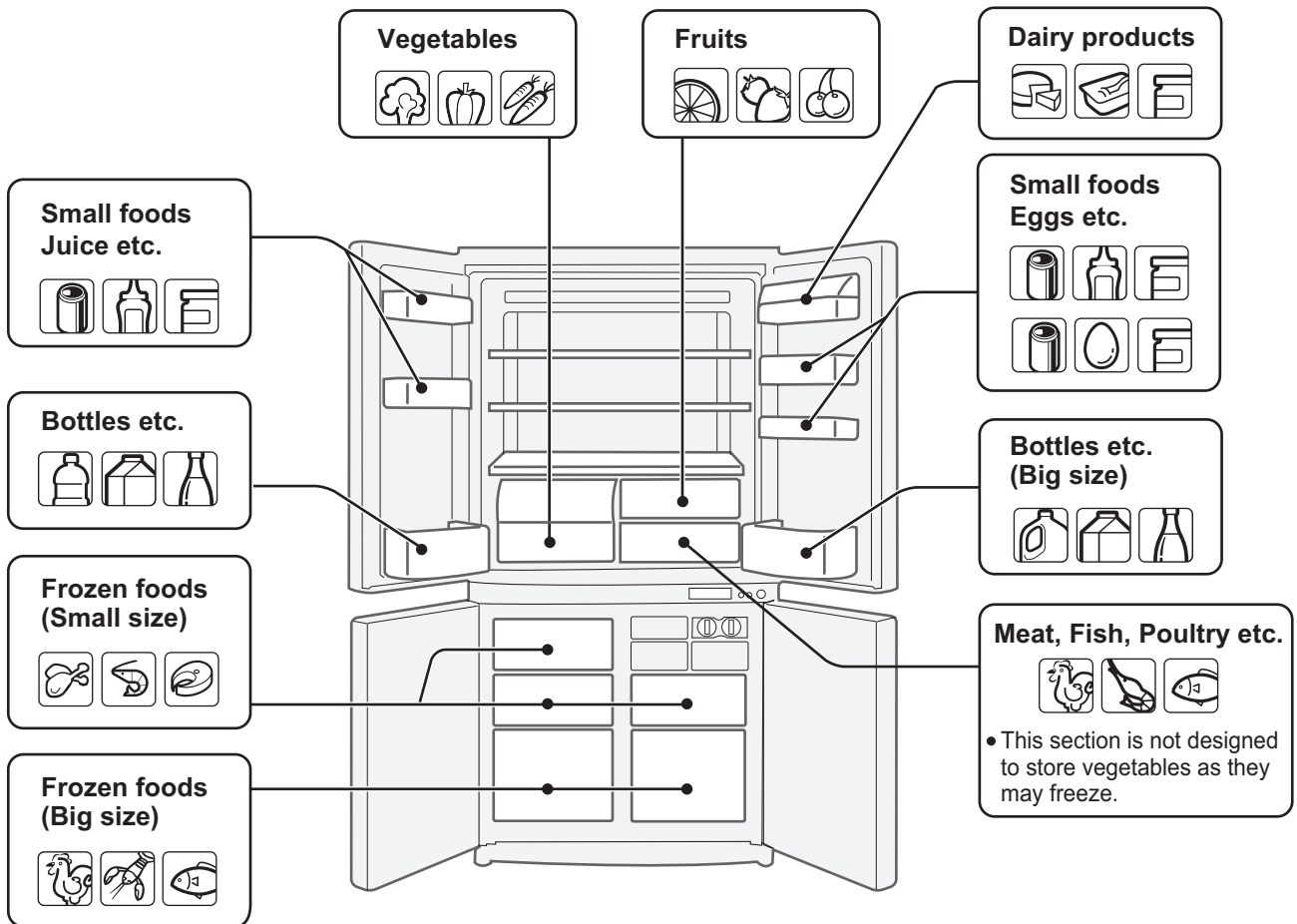

Refrigeration reduces the rate of food spoilage. To maximise the shelf life of perishable food products, ensure that the food is of the freshest possible quality. The following is a general guide to help promote longer food storage.

Fruit / Vegetables

To minimise moisture loss, fruit and vegetables should be loosely enclosed in a plastic material (e.g. wrap, bags) and place in the Vegetable crisper or the Fruit case. Fruits and vegetables with thick skins e.g. oranges do not require wrapping.

Dairy Products & Eggs

- Most dairy products have a use by date on the outer packaging which informs the recommended temperature and shelf life of the product.
- Eggs should be stored in the Egg tray.

Meat / Fish / Poultry

- Place on a plate or dish and cover with paper or plastic wrap.
- For larger cuts of meat, fish, or poultry, place to the rear of the shelves.
- Ensure all cooked food is wrapped securely or placed in an airtight container.

NOTE

- Evenly place the food on the shelves to allow the cooling air to circulate efficiently.
- Hot foods should be cooled before storing. Storing hot foods increases the temperature in the unit and increases the risk of food spoilage.
- Do not block the outlet and inlet of the cool air circulating circuit with food or containers; otherwise the food will not be evenly cooled throughout the refrigerator.
- Keep the door securely closed.

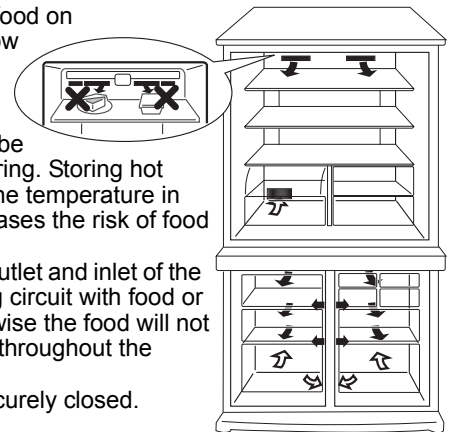

← IN
 → OUT

Do not place food directly in front of cold air outlet. This may lead to the food freezing.

For best freezing

- Quality of food should be fresh.
- Freeze small quantities of food at a time to freeze them quickly.
- Food should be properly stored or covered and the air should be removed to seal tightly.
- Evenly place the food in the freezer.
- Label bags or containers to keep an inventory of frozen food.

CARE AND CLEANING

WARNING

- **Unplug the refrigerator first to prevent electric shock.**
- **Do not splash water directly on the outer cabinet or the interior. This may lead to rusting and deterioration of the electrical insulation.**

IMPORTANT

To prevent cracking on inside surfaces and plastic components, follow these tips:

- Wipe any food oils adhered to plastic components.
- Some household chemicals may cause damage, so use only diluted washing-up liquid (soapy water).
- If undiluted detergent is used or soapy water is not wiped off thoroughly, cracking of plastic parts can result.
- Wipe any spills from the refrigerator immediately as acid or alkaline in the food can cause cracking and staining of plastic parts.

- 1** Remove the shelves and pockets from the cabinet and door. Wash them in warm soapy dishwashing water; rinse in clean water and dry.
- 2** Clean the inside with a cloth soaked in warm soapy dishwashing water. Then, use cold water to wipe off soapy water.
- 3** Wipe the exterior with a soft cloth each time it is soiled.
- 4** Clean the magnetic door seal with a toothbrush and warm soapy dishwashing water.
- 5** Wipe the control panel with a dry cloth.

NOTE

- Do not use hot water, household cleaning powders, creams or spray-on cleaning products, or any other cleaning products such as mineral turpentine, methylated spirits, thinners, petrol etc. These may damage your refrigerator and may void any warranty.
- If the power supply is disconnected, please wait for at least 5 minutes before re-connecting power.
- The glass shelves weigh approximately 3 kg each. Hold firmly when removing from the cabinet or carrying.
- Wipe any spills from the control panel immediately as liquid ingress can damage the electronics.
- Do not drop objects inside the refrigerator or strike the inner wall. This may cause the inner surface to crack.

When the compartment light is blown

Contact the service agent approved by SHARP to request a replacement compartment light. The compartment light is not to be removed other than by qualified service personnel.

Switching off your refrigerator

If the refrigerator needs to be switched off for an extended period, the following steps should be taken to reduce the symptom of mould:

- 1.** Remove all food.
- 2.** Remove the power plug from the power point.
- 3.** Clean and dry the interior thoroughly.
- 4.** Ensure that all the doors are wedged open slightly for air circulation.

BEFORE YOU CALL FOR SERVICE

Before you call for service, check the following points.

Problem	Solution
The outside of the cabinet is hot when touched.	This is normal. The hot pipe is in the cabinet in order to prevent condensation generation.
When there is refrigerator noise.	It is normal for the refrigerator to produce the following sounds: <ul style="list-style-type: none"> • Loud noise produced by the compressor when operation starts --- Sound becomes quieter after a while. • Loud noise produced once a day by the compressor --- Operating sound produced immediately after automatic defrost operation. • Sound of flowing fluid (gurgling sound, fizzing sound) --- Sound of refrigerant flowing in pipes (sound may become louder from time to time). • Cracking or crunching sound, squeaking sound --- Sound produced by expansion and contraction of inner walls and internal parts during cooling.
Frosting or condensation generation occurs inside or outside the refrigerator.	This may occur in one of the following cases. Use a wet cloth for wiping frost and a dry cloth for wiping condensation. <ul style="list-style-type: none"> • When the ambient humidity is high. • When the door is frequently opened and closed. • When food containing plenty of moisture is stored. (Wrapping is required.)
The foods in the refrigerator compartment freeze.	<ul style="list-style-type: none"> • Is the refrigerator operated for a long time with refrigerator temp. control set at 0°C? • Is the refrigerator operated for a long time with freezer temp. control set at -21°C? • Low ambient temperature may cause food to freeze even if refrigerator temp. control is set to 6°C.
Noticeable odours.	<ul style="list-style-type: none"> • Wrapping is required for food with strong odours. • Deodorising unit cannot remove all of the odours.

If you still require service contact your SHARP Approved Service Centre.

SHARP Approved Service Centre locations can be found in the Support area of our website:

Australia : <http://www.sharp.net.au>

New Zealand : <http://www.sharp.net.nz>

SPECIFICATION

		SJ-F602SP	SJ-F653SP
Rated voltage (V~)		230 - 240	
Rated frequency (Hz)		50	
Rated current (A)		1.0 - 1.1	
Rated input of heating systems (W)		190 - 206	
Defrosting input (W)		190 - 206	
Climate class		T	
Refrigerant		HFC - 134a	
Charge (g)		120	120
Insulation blowing gas		Cyclo pentane	
Rated storage volume (L)		556	605
Rated gross volume (L)		602	653
Group (AS / NZS 4474.1)		5B	
Net weight (kg)		107	110
Outer dimensions (mm)	Height	1720	1830
	Width	890	890
	Depth (Including the handle)	770 (790)	770 (790)

- If further depth reduction is required for site access/installation, the doors and control panel can be removed to reduce the overall depth from 790 mm to 685 mm. Only a SHARP Approved Service Centre can perform removal and replacement of the doors/control panel. The customer should obtain an estimate from a SHARP Approved Service Centre prior to purchase.

SHARP

SHARP CORPORATION OF AUSTRALIA PTY.LTD.

A. B. N. 40 003 039 405

1 HUNTINGWOOD DRIVE, HUNTINGWOOD, N.S.W. 2148

P.O.BOX 6827, BLACKTOWN. N.S.W. 2148

SHARP CORPORATION OF NEW ZEALAND LIMITED

59 HUGO JOHNSTON DRIVE PENROSE, AUCKLAND

Printed in Thailand

TINS-B007CBRZ 09GK (TH) ①

Free Manuals Download Website

<http://myh66.com>

<http://usermanuals.us>

<http://www.somanuals.com>

<http://www.4manuals.cc>

<http://www.manual-lib.com>

<http://www.404manual.com>

<http://www.luxmanual.com>

<http://aubethermostatmanual.com>

Golf course search by state

<http://golfingnear.com>

Email search by domain

<http://emailbydomain.com>

Auto manuals search

<http://auto.somanuals.com>

TV manuals search

<http://tv.somanuals.com>