

SHARP®

SLIM-AUDIO-SYSTEM
MICRO SYSTÈME SLIM
SISTEMA MICRO DELGADO
TUNT MIKROSYSTEM
SISTEMA MICRO
SLIM MICRO SYSTEEM
SISTEMA MICRO SUPER LEVE
MICRO STEREO JÄRJESTELMÄ
SLIM MICRO SYSTEM

MODELL
MODÈLE
MODELO
MODELL
MODELLO

MODEL
MODELO
MALLI
MODEL

DK-KP85PH

BEDIENUNGSANLEITUNG
MODE D'EMPLOI
MANUAL DE MANEJO

BRUKSANVISNING
MANUALE DI ISTRUZIONI
GEBRUIKSAANWIJZING

MANUAL DE OPERAÇÃO
KÄYTTÖOHJE
OPERATION MANUAL

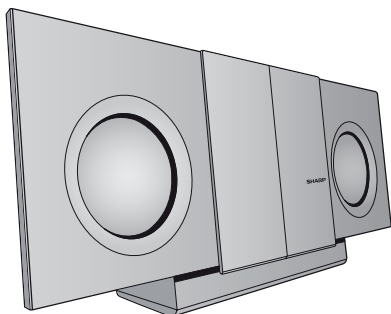

Made for

 iPod  iPhone  iPad

iPad, iPhone, iPod, iPod classic, iPod nano, and iPod touch are trademarks of Apple Inc., registered in the U.S. and other countries. Lightning is a trademark of Apple Inc..



MP3



X-BASS

DEUTSCH	...	Siehe Seiten i bis viii und D-1 bis D-24.
FRANÇAIS	...	Se reporter aux pages i à viii et F-1 à F-24.
ESPAÑOL	...	Consulte las páginas i a viii y S-1 a S-24.
SVENSKA	...	Hänvisa till sidorna i till viii och V-1 till V-24.
ITALIANO	...	Leggere le pagine i a viii e I-1 a I-24.
NEDERLANDS	...	Raadpleeg de bladzijden i t/m viii en N-1 t/m N-24.
PORTUGUÊS	...	Favor consultar as páginas i a viii e P-1 a P-24.
SUOMI	...	Sivut i - viii sekä SU-1 - SU-24.
ENGLISH	...	Please refer to pages i to viii and E-1 to E-24.

BESONDERE ANMERKUNGEN
REMARQUES SPÉCIALES
NOTAS ESPECIALES
SÄRSKILDA ANMÄRKNINGAR
NOTE PARTICOLARI
BIJZONDERE OPMERKINGEN
NOTAS ESPECIAIS
ERITYSHUOMAUTUS
SPECIAL NOTES



● Hiermit erklärt SHARP Electronics, dass sich das Gerät SHARP Slim-Audio-System DK-KP85PH in Übereinstimmung mit den grundlegenden Anforderungen und den übrigen einschlägigen Bestimmungen der Richtlinie 1999/5/EG befindet. Die Konformitätserklärung kann unter folgender Adresse gefunden werden:
<http://www.sharp.de/doc/DK-KP85PH.pdf>

● Par la présente, SHARP Electronics déclare que l'appareil SHARP Micro Système Slim DK-KP85PH est conforme aux exigences essentielles et aux autres dispositions pertinentes de la directive 1999/5/CE. La déclaration de conformité peut être consultée sur le site:
<http://www.sharp.de/doc/DK-KP85PH.pdf>

● Por la presente, SHARP Electronics, declara que este SHARP Sistema Micro Delgado DK-KP85PH cumple con los requisitos esenciales y otras exigencias relevantes de la Directiva 1999/5/EC. Pueden consultar la declaración de conformidad en:
<http://www.sharp.de/doc/DK-KP85PH.pdf>

● Härmed intygar SHARP Electronics att denna SHARP Tunt Mikrosystem DK-KP85PH står i överensstämmelse med de väsentliga egenskapskrav och övriga relevanta bestämmelser som framgår av direktiv 1999/5/EG. Deklaration om överensstämmelse är tillgänglig på web adressen:
<http://www.sharp.de/doc/DK-KP85PH.pdf>

● Con la presente SHARP Electronics dichiara che questo SHARP Sistema Micro DK-KP85PH è conforme ai requisiti essenziali ed alle altre disposizioni pertinenti stabilite dalla direttiva 1999/5/CE. La dichiarazione di conformità può essere consultata sul sito:
<http://www.sharp.de/doc/DK-KP85PH.pdf>

● **Dichiarazione di conformità**
 La società SHARP ELECTRONICS dichiara che il prodotto DK-KP85PH Sistema micro è costruito in conformità alle prescrizioni del D.M.no 548 del 28/8/95, pubblicato sulla G.U.no 301 del 28/12/95 ed in particolare è conforme a quanto indicato nell'art. 2, comma 1 dello stesso decreto.

● Hierbij verklaart SHARP Electronics dat het toestel SHARP Slim Micro Systeem DK-KP85PH in overeenstemming is met de essentiële eisen en de andere relevante bepalingen van richtlijn 1999/5/EG. De overeenstemmingsverklaring is beschikbaar op:
<http://www.sharp.de/doc/DK-KP85PH.pdf>

● Eu, SHARP Electronics, declaro que o SHARP Sistema Micro Super Leve DK-KP85PH cumpre os requisitos essenciais e outras provisões relevantes da Directiva 1999/5/EC. A Declaração de conformidade pode ser consultada em:
<http://www.sharp.de/doc/DK-KP85PH.pdf>

● SHARP Electronics vakuuttaa täten että SHARP Micro Stereo Järjestelmä DK-KP85PH tyyppinen laite on direktiivin 1999/5/EY oleellisten vaatimusten ja sitä koskevien direktiivin muiden ehtojen mukainen. Vakuutus on nähtävissä osoitteessa:
<http://www.sharp.de/doc/DK-KP85PH.pdf>

● Hereby, SHARP Electronics declares that this SHARP Slim Micro System DK-KP85PH is in compliance with the essential requirements and other relevant provisions of Directive 1999/5/EC. The declaration of conformity may be consulted at:
<http://www.sharp.de/doc/DK-KP85PH.pdf>

● Bei Einstellung der ON/STAND-BY-Taste auf STAND-BY ist die Netzspannung immer noch im Gerät vorhanden. Wenn die ON/STAND-BY-Taste auf STAND-BY eingestellt wird, kann das Gerät unter Verwendung der Timer-Betriebsart oder Fernbedienung in Betrieb gesetzt werden.

Warnung:

In diesem Gerät sind keine vom Benutzer wartbaren Teile vorhanden. Niemand Abdeckungen entfernen, außer wenn Sie dafür qualifiziert sind. In diesem Gerät sind gefährliche Spannungen vorhanden. Vor Ausführung von irgendwelchen Kundendienstarbeiten oder bei längerer Nichtverwendung des Gerätes stets den Netzstecker aus der Netzsteckdose ziehen.

● Lorsque la touche ON/STAND-BY est mise en STAND-BY, l'appareil est toujours sous tension. Lorsque la touche ON/STAND-BY se trouve sur la position STAND-BY, l'appareil est prêt à fonctionner par la minuterie ou la télécommande.

Avvertissement:

Cet appareil contient des pièces non réparables par l'utilisateur. Personne non qualifiée n'enlèvera jamais les couvercles. L'appareil contenant des organes portés à haute tension, débrancher l'appareil avant toute réparation ou en période de non-utilisation.

● Cuando el botón ON/STAND-BY está puesto en la posición STAND-BY, todavía hay tensión dentro del aparato. Cuando el botón ON/STAND-BY está puesto en la posición STAND-BY, el aparato puede ponerse en funcionamiento utilizando el modo del temporizador o el controlador remoto.

Avvertenza:

Tenga in cuenta que dentro de este aparato no hay piezas que pueda reparar. No quite nunca las tapas a menos que se esté cualificado para hacerlo. Este aparato tiene en su interior tensiones peligrosas. Desenchufe siempre la clavija de la red del tomacorriente antes de realizar cualquier servicio de mantenimiento y cuando no se use el aparato durante un largo período de tiempo.

● När ON/STAND-BY knappen är i läge STAND-BY, finns nätspänning i apparaten. Med ON/STAND-BY knappen i läge STAND-BY kan apparaten startas med timerfunktion eller fjärrkontrollen.

Varning:

Apparaten innehåller inga delar som kan fågärdas av kunden. Höljet får endast öppnas av kvalificerad personal. Apparaten innehåller farliga spänningar. Stickkontakten ska därför dras ut från nätuttaget före reparationsarbeten och bör dras ut om apparaten inte ska användas på mycket länge.

● Quando il tasto ON/STAND-BY si trova in posizione STAND-BY, all'interno dell'apparecchio c'è ancora la corrente. Se il tasto ON/STAND-BY si trova nella posizione STAND-BY, l'unità può essere accesa con il modo timer o con il telecomando.

Avvertenza:

L'apparecchio non contiene parti riparabili dall'utente. Non togliere mai i coperchi, a meno di non essere qualificati per farlo. All'interno dell'apparecchio ci sono tensioni pericolose, per cui si deve sempre staccare la spina del cavo d'alimentazione dalla presa di corrente prima di qualsiasi intervento di manutenzione e quando non si usa l'apparecchio per un lungo periodo di tempo.

<ul style="list-style-type: none"> ● Wanneer de ON/STAND-BY toets in de STAND-BY stand staat, loopt er nog steeds stroom (netspanning) in het toestel. Wanneer de ON/STAND-BY toets in de STAND-BY stand staat, kan het toestel ingeschakeld worden via de timerfunctie of de afstandsbediening. Waarschuwing: Dit toestel bevat geen door de gebruiker te repareren onderdelen. Verwijder de behuizing nooit tenzij u deskundig bent op dit gebied. In het toestel loopt een gevaarlijke spanning; haal de stekker altijd uit het stopcontact alvorens onderhoud uit te voeren of wanneer het toestel voor langere tijd niet gebruikt wordt.
<ul style="list-style-type: none"> ● Quando o botão ON/STAND-BY estiver ajustado na posição STAND-BY, a voltagem de alimentação ainda se encontra presente dentro do aparelho. Quando o botão ON/STAND-BY estiver ajustado na posição STAND-BY, o aparelho pode ser colocado em operação através do modo de programação horária ou pelo controle remoto. Advertência: Neste aparelho não há partes que podem ser consertadas pelo usuário. Nunca retire a tampa, a menos que você tenha qualificação para tal. Este aparelho contém voltagens perigosas. Remova sempre o cabo de alimentação da tomada antes de efetuar qualquer conserto ou quando deixar o aparelho muito tempo fora de uso.
<ul style="list-style-type: none"> ● Kun ON/STAND-BY -kytkin on STAND-BY-asenossa, laitteessa on yhä virta. Kun ON/STAND-BY -kytkin on STAND-BY-asenossa, laite voidaan kytkeä päälle kaukosäätimestä. Varoitus: Laitteen sisällä ei ole käyttäjän huollettavissa olevia osia. Kotelon saa irrottaa vain siihen pätevätyönyt henkilö. Laitteen sisällä on vaarallinen jännite. Laite on aina irrotettava verkkovirrasta ennen huoltotoimenpiteitä ja jos laite on pitkään käyttämättä.
<ul style="list-style-type: none"> ● When the ON/STAND-BY button is set at STAND-BY position, mains voltage is still present inside the unit. When the ON/STAND-BY button is set at STAND-BY position, the unit may be brought into operation by the timer mode or remote control. Warning: This unit contains no user serviceable parts. Never remove covers unless qualified to do so. This unit contains dangerous voltages, always remove mains plug from the socket before any service operation and when not in use for a long period.
<ul style="list-style-type: none"> ● Nir ON/STAND-BY-knappen er sat i STAND-BY positionen, er der stadig netspænding til stede i apparatet. Nir ON/STAND-BY-knappen er sat i STAND-BY position, kan apparatet startes v.h.j.a. timer-funktionen eller fjernbetjeningen. Advarsel: Apparatet indeholder ingen dele, der kan repareres af brugeren selv. Fjern aldrig kabinetet med mindre De er kvalificeret hertil. Apparatet indeholder farlig strømspænding. Træk altid stikket ud af stikkontakten før der foretages reparationer, eller hvis apparatet ikke er i brug i længere tid.

<p>PŘED SEJMUTÍM KRYTU NUTNO VYJMOUT VIDLICI ZE SÍTOVÉ ZÁSUVKY.</p>
<p>PRED ZLOŽENÍM KRYTU JE NUTNÉ ODPOJIT PRÍSTROJ ZO SIETE.</p>
<p>DENNA APPARAT ÄR ANSLUTEN TILL 230 V VÄXELSTRÖM NÄR STICKPROPPEN ÄR INSKJUTEN I VÄGGUTTAGET. FÖR ATT FULLSTÄNDIGT KOPPLA IFRÅN APPARATEN, V.G. DRAG UT STICKPROPPEN.</p>
<ul style="list-style-type: none"> ● Audio-visuelles Material kann Urheberrechte umfassen, die ohne Genehmigung des Eigentümers dieser Urheberrechte nicht aufgenommen werden dürfen. Siehe die entsprechenden nationalen Gesetze.
<ul style="list-style-type: none"> ● Le matériel audio-visuel peut comporter des oeuvres faisant l'objet de droits d'auteur qui ne peuvent être enregistrés sans l'autorisation du possesseur du droit d'auteur, veuillez vous référer aux réglementations nationales en vigueur.
<ul style="list-style-type: none"> ● El material audiovisual puede consistir en trabajos que tengan derechos de autor y que no deben grabarse sin la autorización del poseedor de dichos derechos de autor. Sírvase consultar las leyes aplicables en su país.
<ul style="list-style-type: none"> ● Audiovisuellt material kan innehålla upphovsrättsarbete som inte skall mångfaldigas utan tillstånd av copyrightinnehavaren. Se den tillämpliga lagen i ditt land.
<ul style="list-style-type: none"> ● Il materiale audio-visivo che fosse soggetto a copyright non può essere registrato senza l'autorizzazione del possessore del copyright. Si prega di attenersi alle leggi in vigore sul territorio nazionale.
<ul style="list-style-type: none"> ● Audio-visueel materiaal kan worden beschermd door auteursrechten, in welk geval het niet mag worden opgenomen zonder de toestemming van de auteursrechthouder. Zie voor nadere informatie de betreffende wetten in het land van gebruik.
<ul style="list-style-type: none"> ● O material audiovisual pode consistir de trabalhos de direitos autorias que não devem ser gravados sem autorização do proprietário dos direitos. Favor consultar as leis vigentes em seu país.
<ul style="list-style-type: none"> ● Audiovisuaalinen materiaali saattaa olla tekijänoikeudella suojattua, eikä sitä tällöin saa tallentaa ilman tekijänoikeuden haltijan lupaa. Lisätietoja on maassasi sovellettavassa tekijänoikeuslaissa.
<ul style="list-style-type: none"> ● Audio-visual material may consist of copyrighted works which must not be recorded without the authority of the owner of the copyright. Please refer to relevant law in your country.

<p>● Vorsicht: Das Gerät weder Tropf- noch Spritzwasser aussetzen. Ansonsten besteht die Gefahr eines Brandes oder elektrischen Schlages. Es dürfen keine mit Flüssigkeiten gefüllten Gegenstände wie Vasen auf dem Gerät abgestellt werden.</p>
<p>● Attention: Pour éviter un incendie ou une secousse électrique, mettre l'appareil à l'abri de l'eau (éclaboussure, goutte). Ne pas poser sur l'appareil un récipient contenant du liquide.</p>
<p>● Advertencia: Para evitar incendios y descargas eléctricas, no exponga el aparato a goteo o salpicadura de líquidos. No deberán ponerse encima del aparato objetos que estén llenos de líquido, como por ejemplo un florero.</p>
<p>● Warning: Utsätt inte enheten för dropp eller stänk för att förhindra brand eller elektriska stötar. Inga vätskefyllda föremål såsom vasor får placeras på enheten.</p>
<p>● Attenzione: Per prevenire incendi o scosse elettriche, non fare gocciolare nessun liquido sull'apparecchio e non bagnarlo. Non collocarvi sopra nessun oggetto riempito d'acqua, come per esempio vasi.</p>
<p>● Waarschuwing: Stel het toestel niet bloot aan druipend of spattend water om brand en elektrische schokken te voorkomen. Met vloeistoffen gevulde voorwerpen, zoals vazen, mogen niet op het toestel geplaatst worden.</p>
<p>● Cuidado: Para evitar incêndio ou choque elétrico, não exponha este aparelho a gotejamento ou salpicamento de água. Não coloque objetos com água como, por exemplo, um vaso de flores, em cima do aparelho.</p>
<p>● Varoitus: Tulipalon tai sähköiskun välttämiseksi laitetta ei saa altistaa tippuvalle tai roiskuvalle vedelle. Nestettä sisältäviä astioita kuten esim kukkamaljakoita ei saa asettaa laitteen päälle.</p>
<p>● Warning: To prevent fire or shock hazard, do not expose this appliance to dripping or splashing. No objects filled with liquids, such as vases, shall be placed on the apparatus.</p>
<p>● Advarsel: Til at forbygge ild og strålrisiko, lad vaere med at undsaette denne indretning for drypning eller overstaenkning. Der må ikke anbringes nogen genstande fyldt med vand, som for eksempel vaser, på dette apparat.</p>
<p>● Advarsel: For å unngå brann eller kortslutning, utsett ikke produktet for vann eller fuktighet. Gjenstander som inneholder væske, f.eks. en blomstervase, må ikke plasseres oppi apparatet.</p>
<p>● Varoitus: Älä vie laitetta sateeseen tai kosteisiin tiloihin. Jos laite on kostunut, anna sen kuivua ennen kuin käytät sitä verkkovirralla. Nestettä sisältäviä astioita kuten esim. kukkamaljakoita ei saa asettaa laitteen päälle.</p>

PRÍSTROJ NEVYSTAVUJTE KAPAJÍCÍ NEBO STŘÍKAJÍCÍ VODĚ.

PRÍSTROJ NEVYSTAVUJTE KVAPKAJÚČEJ ALEBO STRIEKAJÚČEJ VODE.

Urządzenie należy chronić przed zalaniem i wilgocią.

<p>● Dieses Produkt ist ein Laserprodukt der Klasse 1.</p>
<p>● Ce produit est classifié comme étant un LASER DE CLASSE 1.</p>
<p>● Este producto está clasificado como un PRODUCTO LASER DE CLASE 1.</p>
<p>● Denna produkt klassificeras som KLASS 1 LASERPRODUKT.</p>
<p>● Questo prodotto è classificato come CLASS 1 LASER PRODUCT.</p>
<p>● Dit product is geclassificeerd als een KLASSE 1 LASER PRODUCT.</p>
<p>● Este produto é classificado como PRODUTO LASER DE CLASSE 1.</p>
<p>● Tämä laite on luokiteltu LUOKAN 1 LASERLAITTEEKSI.</p>
<p>● This product is classified as a CLASS 1 LASER PRODUCT.</p>

<p>● Dette produktet er klassifisert som et KLASSE 1 LASERPRODUKT.</p>
<p>● Dette produkt er klassificeret som et KLASSE 1 LASERPRODUKT.</p>
<p>● Tämä laite on luokiteltu LUOKAN 1 LASERLAITTEEKSI.</p>
<p>● Denna produkt klassificeras som KLASS 1 LASERAPPARAT.</p>
<p>● Tento výrobek je klasifikován jako LASEROVÝ VÝROBEK TŘÍDY 1.</p>
<p>● Tento výrobok je klasifikovaný ako LASEROVÝ VÝROBOK TRIEDY 1.</p>

<p>● VORSICHT Dieses Gerät enthält Laser-Gerät geringer Leistung. Um nachhaltige Sicherheit zu gewährleisten entfernen Sie kein Gehäuse und versuchen Sie nicht Zugang zum Inneren des Produktes zu erhalten. Wenden Sie sich bei auftretenden Servicefällen immer an Fachpersonal.</p>
--

<p>● ATTENTION Ce produit contient un dispositif laser de puissance inférieure. Pour assurer une sécurité continue ne retirez pas le cache et n'essayez pas d'accéder l'intérieur du produit. Tout entretien doit être fait par du personnel qualifié.</p>

<p>● PRECAUCIÓN Este producto contiene un dispositivo láser de potencia más baja. Para garantizar una continua seguridad, no retire ninguna cubierta ni intente acceder al interior del producto. Solicite el servicio de personal cualificado.</p>
--

<p>● OBSERVERA Denna produkt innehåller en svagströmlaser. För att säkerställa fortsatt säkerhet ta inte bort något hölje eller försök få tillgång till insidan av produkten. Överlåt alla servicearbeten åt kvalificerad personal.</p>
--

● ATTENZIONE

Questo prodotto contiene un dispositivo laser a bassa potenza. Per garantire una sicurezza continua, non togliete alcuna protezione e non cercate di accedere all'interno del prodotto. Fate sempre riferimento ad un personale qualificato.

● LET OP

Dit product bevat een Lagervermogen-laser apparaat. Om een voortdurende veiligheid te waarborgen verwijder geen enkele beschermkap of probeer toegang te krijgen tot het binnenste van het apparaat. Laat alle reparaties over aan bevoegd personeel.

● CUIDADO

Este produto contém um dispositivo laser de baixa potencia. Para assegurar uma segurança contínua não remova nenhuma capa nem tente aceder ao interior do produto. Remeta todo o tipo de manutenção para pessoal qualificado.

● VAROITUS

Tämä tuote sisältää laser-juovapyyhkäyslaitteen. Varmistaakseen turvallisuutta älä poista kannta äläkä yritä korjata laitetta itse. Jätä huolto pätevän huoltohenkilön tehtäväksi.

● CAUTION

This product contains a lower power laser device. To ensure continued safety do not remove any cover or attempt to gain access to the inside of the product. Refer all servicing to qualified personnel.

VÝSTRAHA: VÝROBEK JE VYBAVEN LASEREM. PŘI NESPRÁVNÉ MANIPULACI S PŘÍSTROJEM V ROZPORNĚ S TÝMTO NÁVODEM MŮŽE DOJÍT K NEBEZPEČNÉMU OZÁŘENÍ. NEOTVÍREJTE A NESNÍMEJTE PRŮTO ŽÁDNÉ KRYTY A PŘÍSTROJ NEOPRAVUJTE. OPRAVU A SERVIS SVĚŘTE ODBORNÉMU SERVISU.

VÝSTRAHA: VÝROBEK JE VYBAVENÝ LASEROM. PRI NESPRÁVNOM MANIPULOVANÍ S PŘÍSTROJEM V ROZPORNĚ S TÝMTO NÁVODEM MŮŽE DŮJST K NEBEZPEČNÉMU OŽIARENÍU. NEODKRYVAJTE PRŮTO ŽIADNE KRYTY A PŘÍSTROJ NEOPRAVUJTE OPRAVU A SERVIS PRENECHAJTE ODBORNÉMU SERVISU.

„Made for iPod“, „Made for iPhone“ und „Made for iPad“ bedeutet, dass ein elektronisches Zubehörtel speziell für den Anschluss an einen iPod, iPhone oder iPad konzipiert wurde und der Entwickler sich dafür verbürgt, dass das Gerät den Leistungsstandards von Apple entspricht. Apple ist nicht verantwortlich für den Betrieb dieses Gerätes oder dafür, dass es Sicherheits- und Regulierungsstandards einhält. Bitte beachten Sie, dass die Nutzung dieses Zubehörtels mit einem iPod oder iPhone zu einer Beeinträchtigung der drahtlosen Leistung führen kann.

Les termes « Made for iPod », « Made for iPhone » et « Made for iPad » indiquent qu'un accessoire électronique a été spécifiquement conçu pour se raccorder respectivement à un iPod, iPhone ou iPad, et satisfait, sous certification du développeur, aux normes de performance d'Apple. Apple n'est pas responsable de l'emploi de cet appareil ni de sa conformité aux normes réglementaires et de sécurité. Veuillez noter que l'utilisation de cet accessoire avec l'iPod ou l'iPhone peut affecter les performances sans fil.

„Made for iPod“, „Made for iPhone“ y „Made for iPad“ significa que se ha diseñado un accesorio electrónico para conectar específicamente al iPod, iPhone o iPad, respectivamente, y el fabricante ha certificado que cumple con las normas de desempeño de Apple. Apple no se responsabiliza por el funcionamiento de este dispositivo ni por su cumplimiento con las normas de seguridad y regulatorias. Tenga en cuenta que el uso de este accesorio con el iPod o el iPhone puede afectar el funcionamiento del inalámbrico.

„Made for iPod“, „Made for iPhone“ och „Made for iPad“ innebär att ett elektroniskt tillbehör har designats för att kopplas specifikt till en iPod, iPhone eller iPad och har certifierats av utvecklaren för att tillfredsställa Apples prestandanormer. Apple ansvarar inte för användning av denna apparat eller dess överensstämmelse med säkerhetsnormer och föreskrifter. Observera att användning av detta tillbehör med iPod eller iPhone kan påverka den trådlösa prestandan.

„Made for iPod“, „Made for iPhone“ e „Made for iPad“ significano che un accessorio elettronico è stato progettato per essere specificamente collegato iPod, iPhone o iPad, rispettivamente; inoltre, il produttore ne ha certificato la conformità agli standard di funzionamento Apple. Apple non si ritiene responsabile circa il funzionamento del presente dispositivo o la sua conformità con gli standard normativi e relativi alla sicurezza. L'utilizzo di questo accessorio con iPod o iPhone potrebbe influire sulle prestazioni wireless.

„Made for iPod“, „Made for iPhone“ en „Made for iPad“ betekent dat een elektronische accessoire ontworpen is om specifiek aangesloten te worden op de iPod, iPhone of iPad respectievelijk en gecertificeerd is door de ontwerper om aan de Apple prestatie maatstaven te voldoen. Apple is niet verantwoordelijk voor de werking van dit apparaat of zijn naleving aan veiligheids- en regelgevende maatstaven. Realiseer u, dat het gebruik van dit accessoire een negatieve invloed kan hebben op draadloos gebruik van uw iPod of iPhone.

A indicação „Made for iPod“, „Made for iPhone“ e „Made for iPad“ significa que um acessório eletrônico foi concebido para se ligar especificamente ao iPod, iPhone ou iPad, respectivamente, e foi certificado pelo fabricante para satisfazer os padrões de desempenho da Apple. A Apple não é responsável pelo funcionamento deste aparelho ou pelo cumprimento das normas de segurança e regulamentares. De salientar que o uso deste acessório com o iPod ou iPhone pode afectar o desempenho sem fios.

„Made for iPod“, „Made for iPhone“ ja „Made for iPad“ tarkoittavat sitä, että elektroninen lisälaitte on suunniteltu nimenomaisesti iPod, iPhone tai iPad. Valmistaja on sertifioinut laitteen niin, että se vastaa Applen standardeja. Apple ei ole vastuussa laitteen toiminnasta tai sen yhdenmukaisuudesta turvallisuus- ja sääntelystandardien kanssa. Huomaa, että tämän lisälaitteen käyttö iPodin tai iPhoneen kanssa saattaa vaikuttaa langattoman verkon toimintaan.

„Made for iPod“, „Made for iPhone“, and „Made for iPad“ mean that an electronic accessory has been designed to connect specifically to iPod, iPhone, or iPad, respectively, and has been certified by the developer to meet Apple performance standards. Apple is not responsible for the operation of this device or its compliance with safety and regulatory standards. Please note that the use of this accessory with iPod, iPhone, or iPad may affect wireless performance.

Die Wortmarke *Bluetooth*® und die zugehörigen Logos sind Eigentum der Bluetooth SIG, Inc. und werden von SHARP unter Lizenz verwendet. Andere Marken und Produktnamen sind Eigentum der jeweiligen Rechteinhaber.

Le mot et les logos *Bluetooth*® sont des marques commerciales enregistrées par Bluetooth SIG, Inc. et toute utilisation de ces marques par SHARP est faite sous licence. Les autres marques et noms commerciaux appartiennent à leurs propriétaires respectifs.

La marca denominativa y los logotipos *Bluetooth*® son marcas comerciales registradas propiedad de Bluetooth SIG, Inc. y cualquier uso de dichas marcas por SHARP es bajo licencia. El resto de marcas registradas y nombres comerciales son de sus propietarios respectivos.

Bluetooth®-varumärket och logotyperna är registrerade varumärken som tillhör Bluetooth SIG, Inc. och all användning av sådana märken av SHARP sker under licens. Andra varumärken och varunamn tillhör deras respektive ägare.

La parola-marchio *Bluetooth*® e i loghi sono marchi registrati di possesso della Bluetooth SIG, Inc. e qualunque utilizzo di questi marchi da parte di SHARP è sotto licenza. Altri marchi e nomi commerciali sono dei relativi proprietari.

Het *Bluetooth*® woordmerk en logo's zijn geregistreerde handelsmerken eigendom van Bluetooth SIG, Inc. en gebruik van dergelijke merken door SHARP is onder licentie. Andere handelsmerken en handelsnamen zijn van hun respectievelijke eigenaren.

A marca e logo *Bluetooth*® são marcas registadas propriedade da Bluetooth SIG, Inc. e o uso de tais marcas pela SHARP é feito mediante licença. Outras marcas e nomes de marcas pertencem aos seus legítimos proprietários.

Bluetooth®-sanamerkki ja logot ovat Bluetooth-SIG, Inc. -yhtiön omistamia tavaramerkkejä ja kaikkien SHARPIN tällaisten merkkien käyttö on lisenssin alaista. muut tavaramerkit ja kauppamerkit ovat vastaavien omistajiensa omaisuutta.

The *Bluetooth*® word mark and logos are registered trademarks owned by Bluetooth SIG, Inc. and any use of such marks by SHARP is under license. Other trademarks and trade names are those of their respective owners.

Entsorgungsinformationen



A. Entsorgungsinformationen für Benutzer aus Privathaushalten

1. In der Europäischen Union

Achtung: Werfen Sie dieses Gerät zur Entsorgung bitte nicht in den normalen Hausmüll!

Gemäß einer neuen EU-Richtlinie, die die ordnungsgemäße Rücknahme, Behandlung und Verwertung von gebrauchten Elektro- und Elektronikgeräten vorschreibt, müssen elektrische und elektronische Altgeräte getrennt entsorgt werden.

Nach der Einführung der Richtlinie in den EU-Mitgliedsstaaten können Privathaushalte ihre gebrauchten Elektro- und Elektronikgeräte nun kostenlos an ausgewiesenen Rücknahmestellen abgeben! In einigen Ländern* können Sie Altgeräte u.U. auch kostenlos bei Ihrem Fachhändler abgeben, wenn Sie ein vergleichbares neues Gerät kaufen.

* Weitere Einzelheiten erhalten Sie von Ihrer Gemeindeverwaltung. Wenn Ihre gebrauchten Elektro- und Elektronikgeräte Batterien oder Akkus enthalten, sollten diese vorher entnommen und gemäß örtlich geltenden Regelungen getrennt entsorgt werden.

Durch die ordnungsgemäße Entsorgung tragen Sie dazu bei, dass Altgeräte angemessen gesammelt, behandelt und verwertet werden. Dies verhindert mögliche schädliche Auswirkungen auf Umwelt und Gesundheit durch eine unsachgemäße Entsorgung.

2. In anderen Ländern außerhalb der EU

Bitte erkundigen Sie sich bei Ihrer Gemeindeverwaltung nach dem ordnungsgemäßen Verfahren zur Entsorgung dieses Geräts. Für die Schweiz: Gebrauchte Elektro- und Elektronikgeräte können kostenlos beim Händler abgegeben werden, auch wenn Sie kein neues Produkt kaufen. Weitere Rücknahmesysteme finden Sie auf der Homepage von www.swico.ch oder www.sens.ch.

B. Entsorgungsinformationen für gewerbliche Nutzer

1. In der Europäischen Union

Wenn Sie dieses Produkt für gewerbliche Zwecke genutzt haben und nun entsorgen möchten:

Bitte wenden Sie sich an Ihren SHARP Fachhändler der Sie über die Rücknahme des Produkts informieren kann. Möglicherweise müssen Sie die Kosten für die Rücknahme und Verwertung tragen. Kleine Produkte (und kleine Mengen) können möglicherweise bei Ihrer örtlichen Rücknahmestelle abgegeben werden. Für Spanien: Bitte wenden Sie sich an das vorhandene Rücknahmesystem oder Ihre Gemeindeverwaltung, wenn Sie Fragen zur Rücknahme Ihrer Altgeräte haben.

2. In anderen Ländern außerhalb der EU

Bitte erkundigen Sie sich bei Ihrer Gemeindeverwaltung nach dem ordnungsgemäßen Verfahren zur Entsorgung dieses Geräts.

Informations sur la mise au rebut correcte



A. Informations sur la mise au rebut à l'intention des utilisateurs privés (ménages)

1. Au sein de l'Union européenne

Attention : si vous souhaitez mettre cet appareil au rebut, ne le jetez pas dans une poubelle ordinaire!

Les appareils électriques et électroniques usagés doivent être traités séparément et conformément aux lois en vigueur en matière de traitement, de récupération et de recyclage adéquats de ces appareils.

Suite à la mise en oeuvre de ces dispositions dans les Etats membres, les ménages résidant au sein de l'Union européenne peuvent désormais ramener gratuitement* leurs appareils électriques et électroniques usagés sur des sites de collecte désignés.

Dans certains pays*, votre détaillant reprendra également gratuitement votre ancien produit si vous achetez un produit neuf similaire.

* Veuillez contacter votre administration locale pour plus de renseignements. Si votre appareil électrique ou électronique usagé comporte des piles ou des accumulateurs, veuillez les mettre séparément et préalablement au rebut conformément à la législation locale en vigueur.

En veillant à la mise au rebut correcte de ce produit, vous contribuerez à assurer le traitement, la récupération et le recyclage nécessaires de ces déchets, et préviendrez ainsi les effets néfastes potentiels de leur mauvaise gestion sur l'environnement et la santé humaine.

2. Pays hors de l'Union européenne
Si vous souhaitez mettre ce produit au rebut, veuillez contacter votre administration locale qui vous renseignera sur la méthode d'élimination correcte de cet appareil.

Suisse : les équipements électriques ou électroniques usagés peuvent être raménagés gratuitement au détaillant, même si vous n'achetez pas un nouvel appareil. Pour obtenir la liste des autres sites de collecte, veuillez vous reporter à la page d'accueil du site www.swico.ch ou www.sens.ch.

B. Informations sur la mise au rebut à l'intention des entreprises

1. Au sein de l'Union européenne
Si ce produit est utilisé dans le cadre des activités de votre entreprise et que vous souhaitez le mettre au rebut:

Veuillez contacter votre revendeur SHARP qui vous informera des conditions de reprise du produit. Les frais de reprise et de recyclage pourront vous être facturés. Les produits de petite taille (et en petites quantités) pourront être repris par vos organisations de collecte locales. Espagne: veuillez contacter l'organisation de collecte existante ou votre administration locale pour les modalités de reprise de vos produits usagés.

2. Pays hors de l'Union européenne

Si vous souhaitez mettre ce produit au rebut, veuillez contacter votre administration locale qui vous renseignera sur la méthode d'élimination correcte de cet appareil.

Achtung: Ihr Produkt trägt dieses Symbol. Es besagt, dass Elektro- und Elektronikgeräte nicht mit dem Hausmüll entsorgt, sondern einem getrennten Rücknahmesystem zugeführt werden sollten.

Attention: votre produit comporte ce symbole. Il signifie que les produits électriques et électroniques usagés ne doivent pas être mélangés avec les déchets ménagers généraux. Un système de collecte séparé est prévu pour ces produits.

Información sobre la eliminación



A. Información sobre eliminación para usuarios particulares

1. En la Unión Europea

Atención: si quiere descharar este equipo, por favor no utilice el cubo de la basura habitual!

Los equipos eléctricos y electrónicos usados deberían tratarse por separado de acuerdo con la legislación que requiere un tratamiento, una recuperación y un reciclaje adecuados de los equipos eléctricos y electrónicos usados.

Tras la puesta en práctica por parte de los estados miembros, los hogares de particulares dentro de los estados de la Unión Europea pueden devolver sus equipos eléctricos y electrónicos a los centros de recogida designados sin coste alguno*.

En algunos países** es posible que también su vendedor local se lleve su viejo producto sin coste alguno si Ud. compra uno nuevo similar. * Por favor, póngase en contacto con su autoridad local para obtener más detalles.

Si sus equipos eléctricos o electrónicos usados tienen pilas o acumuladores, por favor deséchelos por separado con antelación según los requisitos locales.

Al descharar este producto correctamente, ayudará a asegurar que los residuos reciban el tratamiento, la recuperación y el reciclaje necesarios, previniendo de esta forma posibles efectos negativos en el medio ambiente y la salud humana que de otra forma podrían producirse debido a una manipulación de residuos inapropiada.

2. En otros países fuera de la Unión Europea

Si desea descharar este producto, por favor póngase en contacto con las autoridades locales y pregunte por el método de eliminación correcto.

Para Suiza: Los equipos eléctricos o electrónicos pueden devolverse a su vendedor sin coste alguno, incluso si no compra ninguno nuevo producto. Se puede encontrar una lista de otros centros de recogida en la página principal de www.swico.ch o www.sens.ch.

B. Información sobre Eliminación para empresas usuarias

1. En la Unión Europea

Si el producto se utiliza en una empresa y quiere deschararlo: Por favor póngase en contacto con su distribuidor SHARP quien le informará sobre la recogida del producto. Puede ser que le cobren los costes de recogida y reciclaje. Puede ser que los productos de tamaño pequeño (y las cantidades pequeñas) sean recogidos por sus centros de recogida locales.

Para España: por favor, póngase en contacto con el sistema de recogida establecido o con las autoridades locales para la recogida de los productos usados.

2. En otros países fuera de la Unión Europea

Si desea descharar este producto, por favor póngase en contacto con sus autoridades locales y pregunte por el método de eliminación correcto.

Información om återvinning



A. Information om återvinning av elektrisk utrustning för hushåll

1. EU-länder

OBS! Kasta inte denna produkt i soporna!
Förbrukad elektrisk utrustning mist hanteras i enlighet med gällande miljölagstiftning och återvinningsföreskrifter.

I enlighet med gällande EU-regler ska hushåll ha möjlighet att lämna in elektrisk utrustning till återvinningsstationer utan kostnad.*

I vissa länder** kan det även handa att man gratis kan lämna in gamla produkter till återförsäljaren när man köper en ny liknande enhet.

* Kontakta kommunen för vidare information.

Om utrustningen innehåller batterier eller ackumulatörer ska dessa först avlägsnas och hanteras separat i enlighet med gällande miljöföreskrifter.

Genom att hantera produkten i enlighet med dessa föreskrifter kommer den att tas om hand och återvinnas på tillämpligt sätt, vilket förhindrar potentiella negativa hälso- och miljöeffekter.

2. Länder utanför EU

Kontakta de lokala myndigheterna och ta reda på gällande sorterings- och återvinningsföreskrifter om du behöver göra dig av med denna produkt.

B. Information om återvinning för företag

1. EU-länder

Gör så här om produkten ska kasseras:
Kontakta SHARPs återförsäljare för information om hur man till väga för att lämna tillbaka produkten. Det kan handa att en avgift för transport och återvinning tillkommer. Eventuellt skrymmande produkter (som det rör sig om ett ftal) kan mivredt återlämnas till lokala återvinningsstationer.

2. Länder utanför EU
Kontakta de lokala myndigheterna och ta reda på gällande sorterings- och återvinningsföreskrifter om du behöver göra dig av med denna produkt.

OBS! Produkten är märkt med sym-bolen ovan. Denna symbol indikerar att elektroniska produkter inte ska kastas i det vanliga hushållsavfallet eftersom det finns ett separat avfallshante-rings-system för dem.

Informazioni per un corretto smaltimento



A. Informazioni sullo smaltimento per gli utenti (privati)

1. Nell'Unione europea

Attenzione: Per smaltire il presente dispositivo, non utilizzare il normale bidone della spazzatura!

Le apparecchiature elettriche ed elettroniche usate devono essere gestite a parte e in conformità alla legislazione che richiede il trattamento, il recupero e il riciclaggio adeguato dei suddetti prodotti.

Attenzione: Il dispositivo è contrassegnato da questo simbolo, che segnala di non smaltire le apparecchiature elettriche ed elettroniche insieme ai normali rifiuti domestici. Per tali prodotti è previsto un sistema di raccolta a parte.

In seguito alle disposizioni attuate dagli Stati membri, i privati residenti nella UE possono conferire gratuitamente le apparecchiature elettriche ed elettroniche usate a centri di raccolta designati*. In alcuni paesi**, anche il rivenditore locale può ritirare gratuitamente il vecchio prodotto se l'utente acquista un altro nuovo di tipologia simile.

*) Per maggiori informazioni si prega di contattare l'autorità locale competente.

Se le apparecchiature elettriche o elettroniche usate hanno batterie o accumulatori, l'utente dovrà smaltirli a parte preventivamente in conformità alle disposizioni locali.

Lo smaltimento corretto del presente prodotto contribuirà a garantire che i rifiuti siano sottoposti al trattamento, al recupero e al riciclaggio necessari prevenendone il potenziale impatto negativo sull'ambiente e sulla salute umana, che potrebbe derivare da un'adeguata gestione dei rifiuti.

2. In paesi che non fanno parte dell'UE

Se si desidera eliminare il presente prodotto, contattare le autorità locali e informarsi sul metodo di smaltimento corretto. Per la Svizzera: Le apparecchiature elettriche o elettroniche usate possono essere restituite gratuitamente al rivenditore, anche se non si acquista un prodotto nuovo. Altri centri di raccolta sono elencati sulle homepage di www.swico.ch o di www.sens.ch.

B. Informazioni sullo smaltimento per gli utenti commerciali

1. Nell'Unione europea

Se il prodotto è impiegato a scopi commerciali, procedere come segue per eliminarlo.

Contattare il proprio rivenditore SHARP che fornirà informazioni circa il ritiro del prodotto. Potrebbero essere addebitate le spese di ritiro e riciclaggio. Prodotti piccoli (e quantitativi ridotti) potranno essere ritirati anche dai centri di raccolta locali.

Per la Spagna: Contattare il sistema di raccolta ufficiale o l'ente locale preposto al ritiro dei prodotti usati.

2. In paesi che non fanno parte dell'UE

Se si desidera eliminare il presente prodotto, contattare le autorità locali e informarsi sul metodo di smaltimento corretto.

Informação sobre Eliminação de Produtos



A. Informações sobre a Eliminação de Produtos para os Utilizadores (particulares)

1. Na União Europeia

Atenção: Se quiser eliminar este equipamento, não o deve fazer juntamente com o lixo doméstico comum!

O equipamento eléctrico e electrónico deve ser tratado separadamente e ao abrigo da legislação aplicável que obriga a um tratamento, recuperação e reciclagem adequados de equipamentos eléctricos e electrónicos usados.

Após a implementação desta legislação por parte dos Estados-membros, todos os cidadãos residentes na União Europeia poderão entregar o seu equipamento eléctrico e electrónico usado em estações de recolha específicas a título gratuito*.

Em alguns países** o seu revendedor local também pode recolher o seu equipamento usado a título gratuito na compra de um novo equipamento.

*) Contacte as entidades locais para mais informações.

Se o seu equipamento eléctrico e electrónico usado funcionar a pilhas ou baterias, deverá eliminá-las em separado, conforme a legislação local, e antes de entregar o seu equipamento.

Ao eliminar este produto correctamente estará a contribuir para que o lixo seja submetido aos processos de tratamento, recuperação e reciclagem adequados. Desta forma é possível evitar os efeitos nocivos que o tratamento inadequado do lixo poderia provocar no ambiente e na saúde.

2. Em outros Países fora da UE

Se quiser eliminar este produto, contacte as entidades locais e informe-se sobre o método correcto para proceder à sua eliminação.

Na Suíça: O equipamento eléctrico e electrónico é aceite, a título gratuito, em qualquer revendedor, mesmo que não tenha adquirido um novo produto. Poderá encontrar uma lista das estações de recolha destes equipamentos na página da Web www.swico.ch ou www.sens.ch.

B. Informações sobre a Eliminação de Produtos para Utilizadores-Empresas

2. Na União Europeia

Se o produto for usado para fins comerciais e quiser eliminá-lo: Contacte o seu revendedor SHARP que irá informá-lo sobre a melhor forma de eliminar o produto. Poderá ter de pagar as despesas resultantes da recolha e reciclagem do produto. Alguns produtos mais pequenos (e em pequenas quantidades) poderão ser recolhidos pelas estações locais.

Na Espanha: Contacte o sistema de recolhas público ou as entidades locais para mais informações sobre a recolha de produtos usados.

2. Em outros Países fora da UE

Se quiser eliminar este produto, contacte as entidades locais e informe-se sobre o método correcto para proceder à sua eliminação.

Informatie over verantwoorde verwijdering



A. Informatie over afvalverwijdering voor gebruikers (particuliere huishoudens)

1. In de Europese Unie

Let op: Deze apparatuur niet samen met het normale huishoudelijk weggoeien!

Let op: Uw product is van dit merkteken voorzien. Dit betekent dat afgedankte elektrische en elektronische apparatuur niet samen met het normale huishoudelijk weggegooid. Er bestaat een afzonderlijk inzamelings-systeem voor deze producten.

Afgedankte elektrische en elektronische apparatuur moet gescheiden worden ingezameld conform de wetgeving inzake de verantwoorde verwijdering, terugwinning en recycling van afgedankte elektrische en elektronische apparatuur.

Na de invoering van de wet door de lidstaten mogen particuliere huishoudens in de lidstaten van de Europese Unie hun afgedankte elektrische en elektronische apparatuur kosteloos* naar hertoe aangewezen inzamelingsinrichtingen brengen*.

In sommige landen** kunt u bij de aanschaf van een nieuw apparaat het oude product kosteloos bij uw lokale distributeur inleveren.

*) Neem contact op met de plaatselijke autoriteiten voor verdere informatie.

Als uw elektrische of elektronische apparatuur batterijen of accumulators bevat dan moet u deze afzonderlijk conform de plaatselijke voorschriften weggoeien.

Door dit product op een verantwoorde manier weg te gooien, zorgt u ervoor dat het afval de juiste verwerking, terugwinning en recycling ondergaat en potentiële negatieve effecten op het milieu en de menselijke gezondheid worden voorkomen die anders zouden ontstaan door het verkeerd verwerken van het afval.

2. In andere landen buiten de Europese Unie

Als u dit product wilt weggoeien, neem dan contact op met de plaatselijke autoriteiten voor informatie omtrent de juiste verwijderingsprocedure. Voor Zwitserland: U kunt afgedankte elektrische en elektronische apparatuur kosteloos bij de distributeur inleveren, zelfs als u geen nieuw product koopt. Aanvullende inzamelingsinrichtingen zijn vermeld op de startpagina van www.swico.ch of www.sens.ch.

B. Informatie over afvalverwijdering voor bedrijven

1. In de Europese Unie

Als u het product voor zakelijke doeleinden heeft gebruikt en als u dit wilt weggoeien:

Neem contact op met uw SHARP distributeur die u inlichtingen verschafft over de terugname van het product. Het kan zijn dat u een afvalverwijderingsbijdrage voor de terugname en recycling moet betalen. Kleine producten (en kleine hoeveelheden) kunnen door de lokale inzamelingsinrichtingen worden verwerkt.

Voor Spanje: Neem contact op met de inzamelingsinrichting of de lokale autoriteiten voor de terugname van uw afgedankte producten.

2. In andere landen buiten de Europese Unie

Als u dit product wilt weggoeien, neem dan contact op met de plaatselijke autoriteiten voor informatie omtrent de juiste verwijderingsprocedure.

Tietoja laitteen hävittämisestä



A. Hävitysohjeet käyttäjälle (yksityiset kotitaloudet)

1. Euroopan unionissa

Huomio: Jos haluat hävittää tämän laitteen, älä käytä tavallista jätessäiliötä.

Käytetyt sähkö- ja elektroniikalaitteet pitää hävittää erikseen noudattaen lainsäädäntöä, joka takaa käytettyjen sähkö- ja elektroniikalaitteiden oikean käsittelyn, keräämisen ja kierrättämisen.

Jäsenvaltioiden täytäntöönpanoa seuraten yksityiset kotitaloudet EU:n jäsenvaltioissa voivat palauttaa käytetyt sähkö- ja elektroniikalaitteet määrättyihin keräyspaikkoihin ilmaiseksi*. Joissakin maissa** paikalliset hävittämissyöt voivat myös ottaa vastaan vanhan tuotteen ilmaiseksi, jos asiakas ostaa uuden tuotteen.

*) Pyydä lisätietoja paikallisviranomaisilta.

Jos käytetyissä sähkö- tai elektroniikalaitteissa käytetään paristoja tai akkuja, hävitä nämä tuotteet erikseen paikallisten paikallisten säästösten mukaisesti.

Hävittämällä tuotteen asianmukaisesti, autat varmistamaan, että jätteet käsitellään, kerätään ja kierrätetään asianmukaisella tavalla. Näin vähentää haitallista ympäristö- ja terveysvaikutuksia, joita saattaa olla seuraamuksena jätteen epäasianmukaisesta käsittelystä.

2. Muissa maissa EU:n ulkopuolella

Jos haluat hävittää tämän, ota yhteyttä paikallisiin viranomaisiin ja pyydä ohjeita tuotteen asianmukaiseen hävittämiseen.

B. Hävitysohjeet yritysikäyttäjille

2. Euroopan unionissa

Jos tuotetta on käytetty yrityskäytössä, ja haluat hävittää sen, ota yhteyttä SHARP-jälleenympärykseen, joka antaa sinulle lisäohjeita tai ottaa tuotteen vastaan. Sinulta saatetaan veloitaa tuotteen vastaanottamisesta ja kierrätyksestä johtuvat kustannukset.

Paikalliset keräyspisteet saattavat ottaa vastaan pienet tuotteet (ja pienet määrät).

2. Muissa maissa EU:n ulkopuolella

Jos haluat hävittää tuotteen, ota yhteyttä paikallisiin viranomaisiin ja pyydä ohjeita tuotteen asianmukaiseen hävittämiseen.

Information on Proper Disposal



A. Information on Disposal for Users (private households)

1. In the European Union

Attention: If you want to dispose of this equipment, please do not use the ordinary dustbin!

Used electrical and electronic equipment must be treated separately and in accordance with legislation that requires proper treatment, recovery and recycling of used electrical and electronic equipment.

Following the implementation by member states, private households within the EU states may return their used electrical and electronic equipment to designated collection facilities free of charge*.

In some countries* your local retailer may also take back your old product free of charge if you purchase a similar new one.

* Please contact your local authority for further details. If you use your electrical or electronic equipment has batteries or accumulators, please dispose of these separately beforehand according to local requirements.

By disposing of this product correctly you will help ensure that the waste undergoes the necessary treatment, recovery and recycling and thus prevent potential negative effects on the environment and human health which could otherwise arise due to inappropriate waste handling.

2. In other Countries outside the EU

If you wish to discard this product, please contact your local authorities and ask for the correct method of disposal.

For Switzerland: Used electrical or electronic equipment can be returned free of charge to the dealer, even if you don't purchase a new product. Further collection facilities are listed on the homepage of www.swico.ch or www.sens.ch.

B. Information on Disposal for Business Users

1. In the European Union

If the product is used for business purposes and you want to discard it:

Please contact your SHARP dealer who will inform you about the take-back of the product. You might be charged for the costs arising from take-back and recycling. Small products (and small amounts) might be taken back by your local collection facilities.

For Spain: Please contact the established collection system or your local authority for take-back of your used products.

2. In other Countries outside the EU

If you wish to discard of this product, please contact your local authorities and ask for the correct method of disposal.



Information on batteriavyttring

Batterier som följer med denna produkt kan innehålla spår av Bly.

För EU: Batterier är märkt med den överkosade sopptunnan vilket betyder att det inte ska kastas i det vanliga hushållsaffäret. Det finns ett separat samlingsystem för batterier för att underlätta korrekt behandling och återvinning enligt gällande lagstiftning. Kontakta kommunen för vidare information om insamling och återvinning.

För Schweiz: Använda batterier lämnas till inköpsstället.

För länder utanför EU: Kontakta de lokala myndigheterna för information om gällande sorterings- och återvinningsföreskrifter om du behöver göra dig av med ett använt batteri.

Informazioni sullo smaltimento della batteria

La batteria fornita con questo prodotto contiene tracce di Piombo. Per EU: Il cassonetto barrato indica che le batterie usate non devono essere gettate assieme ai rifiuti domestici. Vi è un sistema di raccolta differenziata per le batterie usate, che consente il loro corretto trattamento e riciclo secondo quanto previsto dalle leggi vigenti. Vi prego di contattare le locali autorità per i dettagli del sistema di raccolta e riciclaggio.

Per la Svizzera: Le batterie usate devono essere restituite al punto vendita.

Per altri Stati non-EU: Vi prego di contattare le autorità locali per conoscere il metodo corretto di conferimento delle batterie usate.

Informatie over afvalverwerking van batterijen

De batterij die bij dit toestel geleverd wordt bevat sporen van Lead.

För EU: De doorgestreepte vuilnisbak op wieltjes duidt aan dat de gebruikte batterijen niet mogen terechtkomen in het gewone huishoudelijke afval. Er bestaat een gescheiden ophaalsysteem voor deze gebruikte batterijen om eigen behandeling en recyclage volgens de wetgeving toe te laten. Gelieve de lokale autoriteiten te contacteren voor de details van ophaling en recyclage.

För Zwitterland: De gebruikte batterij moet bij hetverkooppunt teruggebracht worden.

Voor andere niet EU landen: Gelieve contact op te nemen met uw lokale autoriteiten voor de correcte methode van verwerking van de gebruikte batterijen.



Informação sobre Eliminação de Pilhas

A bateria fornecida com este produto contém traços de chumbo.

Para a União Europeia: O contenedor de rodas traçado significa que as baterias usadas não deverão ser colocadas junto com o lixo doméstico! Existe um sistema de separação próprio para baterias usadas; para permitir um tratamento e reciclagem própria de acordo com a legislação em vigor. Por favor contacte as autoridades locais para mais detalhes nos esquemas de recolha e reciclagem.

Para a Suíça: As baterias usadas deverão ser devolvidas ao ponto de venda.

Para os outros países fora da União Europeia: Por favor contacte a sua autoridade local para o método correcto de disposição das baterias usadas.

Tietoja paristojen hävittämisestä

Tämän tuotteen mukana oleva paristo/akku saattaa sisältää jätteitä lyijyä.

EU-maat: Paristo/akku on merkitty yliviivatun roskasäiliön symbolilla, mikä tarkoittaa, että sitä ei saa hävittää kotitalouden yleisjätteen kanssa. Paristolle/akulle on olemassa erillinen keräysjärjestelmä, joka helpottaa niiden asianmukaista käsittelyä ja lainnukaista kierrätystä. Ota yhteys kuntaviranomaisiin saadaksesi lisätietoa keräyksestä ja kierrätyksestä.

Sveitsi: Käytetyt paristot/akut palautetaan ostopaikkaan.

EU:n ulkopuoliset maat: Ota yhteys paikallisviranomaisiin saadaksesi lisätietoa voimassa olevista lajitelu- ja kierrätysäädöksistä ja ohjeet käytetyn pariston/akun hävittämiseen.



Information on Battery Disposal

The battery supplied with this product contains traces of Lead.

För EU: The crossed-out wheeled bin implies that used batteries should not be put to the general household waste! There is a separate collection system for used batteries, to allow proper treatment and recycling in accordance with legislation. Please contact your local authority for details on the collection and recycling schemes.

För Switzerland: The used battery is to be returned to the selling point.

För other non-EU countries: Please contact your local authority for correct method of disposal of the used battery.



Informationen zur Batterieentsorgung

Die für dieses Produkt mitgelieferte Batterie kann Spuren von Blei enthalten.

Für die EU: Die durchgestrichene Abfalltonne bedeutet, dass gebrauchte Batterien nicht mit dem Haushaltsmüll entsorgt werden sollten! Es gibt getrennte Sammelsysteme für gebrauchte Batterien, welche eine ordnungsgemäße Behandlung und Verwertung entsprechend gesetzlicher Vorgaben erlauben. Weitere Einzelheiten erhalten Sie von Ihrer Gemeindeverwaltung.

Für die Schweiz: Die gebrauchte Batterie kann an der Verkaufsstelle zurückgegeben werden.

Für andere Nicht-EU Staaten: Bitte erkundigen Sie sich bei Bedarf bei Ihrer Gemeindeverwaltung nach weiteren Informationen zur Entsorgung von gebrauchten Batterien.



Information sur la mise au rebut de la pile

Les piles/accus fournies avec ce produit peuvent contenir des traces de Plomb.

Au sein de l'Union Européenne: Le symbole de la poubelle sur roues barrée laisse supposer que les piles/accus usagés ne doivent pas être mélangés avec les déchets ménagers! Il existe un mode de collecte séparé pour les piles/accus usagés, ce qui permet d'effectuer un traitement et un recyclage en accord avec la législation. Veuillez contacter une autorité locale pour plus de renseignements sur le système mis en place.

Pour la Suisse: Les piles/accus usagés doivent être retournés chez votre détaillant.

Pour les pays hors Union Européenne: Veuillez contacter une autorité locale afin de connaître la bonne méthode à utiliser pour la collecte de vos piles/accus usagés.



Información sobre la eliminación de la batería

Las baterías suministradas con este producto contienen pequeñas cantidades de Plomo.

Para EU: El contenedor de basura con ruedas tachado indica que las baterías usadas no deberían mezclarse con los residuos domésticos generales. Existe un sistema de recogida independiente de baterías usadas, para permitir un correcto tratamiento y reciclado de acuerdo con la legislación vigente. Por favor póngase en contacto con el sistema de recogida establecido o con las autoridades locales para la recogida selectiva de las baterías usadas.

Para Suíza: Las baterías usadas deben ser retornadas al punto de venta.

Para otros países fuera de la Unión Europea: Por favor póngase en contacto con las autoridades locales para un correcto procedimiento de eliminación de las baterías usadas.



Introduction





Thank you for purchasing this SHARP product. To obtain the best performance from this product, please read this manual carefully. It will guide you in operating your SHARP product.

Special Note

Supply of this product does not convey a license nor imply any right to distribute content created with this product in revenue-generating broadcast systems (terrestrial, satellite, cable and/or other distribution channels), revenue-generating streaming applications (via Internet, intranets and/or other networks), other revenue-generating content distribution systems (pay-audio or audio-on-demand applications and the like) or on revenue-generating physical media (compact discs, digital versatile discs, semiconductor chips, hard drives, memory cards and the like). An independent license for such use is required. For details, please visit <http://mp3licensing.com>
MPEG Layer-3 audio coding technology licensed from Fraunhofer IIS and Thomson.

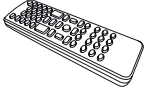
Accessories

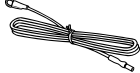
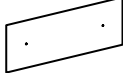
The following accessories are included.

 <p>Remote control x 1 (RRMCGA327AW01)</p>	 <p>"AA" size battery (UM/SUM-3, R6, HP-7 or similar) x 1</p>	 <p>FM aerial x 1</p>	 <p>Pattern Paper</p>
 <p>AM loop aerial x 1</p>	 <p>Stand for iPad x 1</p>		

CONTENTS

	Page		Page
General Information		USB	
Precautions.....	2	Listening to USB mass storage device/MP3 player	16
Controls and indicators	2 - 3	Advanced USB playback.....	17
Preparation for Use		Radio	
Wall mount preparation	4	Listening to the radio.....	17 - 18
System connections.....	5	Advanced Features	
Remote control	6	Using the Radio Data System (RDS)	18 - 20
Basic Operation		Timer and sleep operation (Remote control only)	21 - 22
General control	6 - 7	Enhancing your system	22
Setting the clock (Remote control only)	7	References	
Listening to Bluetooth enabled devices	8 - 9	Troubleshooting chart.....	22 - 24
iPod, iPhone and iPad		Maintenance.....	24
Listening to the iPod, iPhone or iPad	10 - 12	Specifications.....	24
CD or MP3/WMA disc Playback			
Listening to a CD or MP3/WMA disc	12 - 13		
Advanced CD or MP3/WMA disc playback.....	13 - 14		
MP3/WMA folder mode (only for MP3/WMA files)	15		

Precautions

■ General

- Please ensure that the equipment is positioned in a well ventilated area and ensure that there is at least 10 cm (4") of free space along the sides and top of the equipment.

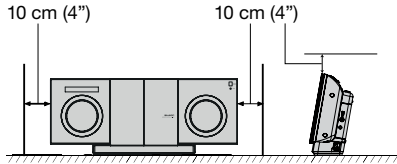

- Use the unit on a firm, level surface free from vibration.
- Place the unit at least 30 cm (12") away from any CRT TV to avoid colour variations across the TV screen. If the variations persist, move the unit further away from the TV. LCDTV is not prone to such variation.
- Keep the unit away from direct sunlight, strong magnetic fields, excessive dust, humidity and electronic/electrical equipment (home computers, facsimiles, etc.) which generate electrical noise.
- Do not place anything on top of the unit.
- Do not expose the unit to moisture, to temperatures higher than 40°C (104°F) or to extremely low temperatures.
- If your system does not work properly, disconnect the AC power lead from the wall socket. Plug the AC power lead back in, and then turn on your system.
- In case of an electrical storm, unplug the unit for safety.

- Hold the AC power plug by the head when removing it from the wall socket, as pulling the lead can damage internal wires.
- The AC power plug is used as a disconnect device and shall always remain readily operable.
- **Do not remove the outer cover, as this may result in electric shock. Refer internal service to your local SHARP service facility.**
- The ventilation should not be impeded by covering the ventilation openings with items, such as newspapers, tablecloths, curtains, etc.
- No naked flame sources, such as lighted candles, should be placed on the apparatus.
- Attention should be drawn to the environmental aspects of battery disposal.
- This unit should only be used within the range of 5°C - 35°C (41°F - 95°F).
- The apparatus is designed for use in moderate climates.

Warning:

The voltage used must be the same as that specified on this unit. Using this product with a higher voltage other than that which is specified is dangerous and may result in a fire or other type of accident causing damage. SHARP will not be held responsible for any damage resulting from use of this unit with a voltage other than that which is specified.

■ Volume control

The sound level at a given volume setting depends on speaker efficiency, location, and various other factors. It is advisable to avoid exposure to high volume levels. Do not turn the volume on to full at switch on. Listen to music at moderate levels. Excessive sound pressure from earphones and headphones can cause hearing loss.

Controls and indicators

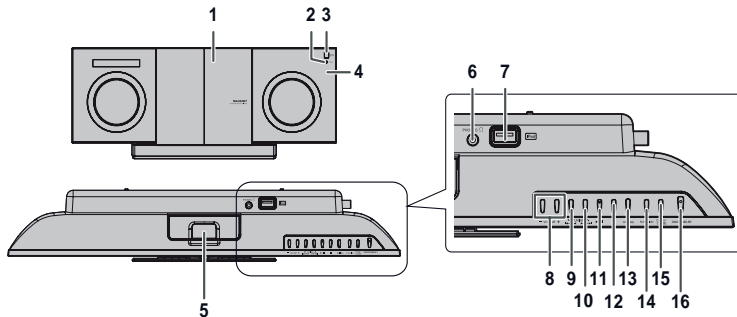

■ Front panel

	Page		Page
1. Disc Compartment	13	10. Tuning Up, CD/USB, iPod/iPhone/ Bluetooth Skip Up.....	12, 13, 16
2. Timer indicator.....	21	11. Disc/USB/iPod/iPhone/Bluetooth Play or Pause Button.....	12, 13
3. Remote sensor.....	6	12. Disc/USB Stop Button.....	13, 16
4. Pairing indicator	8	13. Pairing Button	8
5. Docking Station for iPod or iPhone.....	11	14. FUNCTION Button	12
6. Headphone Terminal	10, 22	15. Disc Compartment Open/Close Button	12, 13
7. USB Terminal	10, 16	16. On/Stand-by Button	11
8. Volume buttons.....	6		
9. Tuning Down, CD/USB, iPod/iPhone/ Bluetooth Skip Down.....	12, 13, 16		

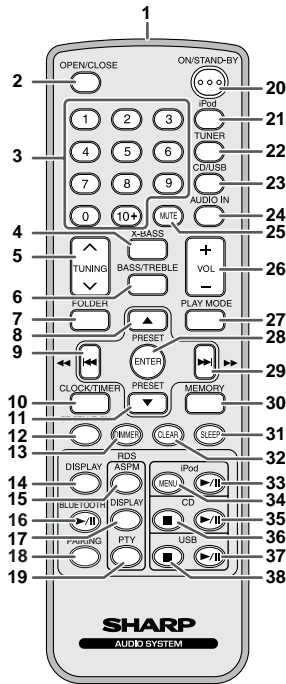

Remote control

	Page
1. Remote Control Transmitter	6
2. Open / Close Button	12, 13
3. Numeric Buttons	12
4. X-Bass Button	7
5. Tuning Up / Down Button	17
6. Bass / Treble Button	7
7. Folder Button	15, 16
8. Tuner Preset Up Button, iPod Cursor Up	11, 12, 15, 16, 18
9. Skip Down, Fast Reverse, Time Down Button	7, 12, 13, 15, 16, 21
10. Clock/Timer Button	7, 21
11. Tuner Preset Down Button, iPod Cursor Down	12, 15, 16, 18
12. Bluetooth Stand-by Button	5, 8
13. Dimmer Button	6
14. Display Button	15, 16
15. RDS ASPM Button	18, 19
16. Bluetooth Play/Pause Button	8
17. RDS Display Button	18
18. Pairing Button	8
19. RDS PTY Button	18, 19
20. On/Stand-by Button	6, 7, 11, 21
21. iPod Button	11
22. Tuner Button	17, 19
23. CD/USB Button	12, 16
24. Audio In Button	21, 22
25. Mute Button	7
26. Volume Up/Down Button	6
27. Play Mode Button	12, 13, 14
28. Enter Button	7, 11, 12, 16, 21
29. Skip Up, Fast Forward, Time Up Button	7, 12, 13, 15, 16, 21
30. Memory Button	14, 17
31. Sleep Button	22
32. Clear Button	14
33. iPod Play/Pause Button	11, 12
34. iPod Menu Button	11, 12
35. CD Play/Pause Button	13, 14
36. CD Stop Button	13, 14
37. USB Play/Pause Button	12, 16
38. USB Stop Button	16

Display

	Page
1. USB Indicator	16
2. iPod Indicator	10
3. CD Indicator	13
4. MP3 Indicator	12
5. WMA Indicator	12
6. RDM (Random) Indicator	14
7. MEM (Memory) Indicator	14
8. Repeat Indicator	13
9. Play/Pause Indicator	13
10. Tuning FM Indicator	17
11. FM Stereo Mode Indicator	17
12. Stereo Station Indicator	17
13. RDS Indicator	18
14. PTY Indicator	18
15. TP Indicator	18
16. TA Indicator	18
17. Muting Indicator	7
18. X-bass Indicator	7
19. Title Indicator	15
20. Artist Indicator	15
21. Folder Indicator	15
22. Album Indicator	15
23. File Indicator	15
24. Track Indicator	14
25. Daily Timer Indicator	21
26. Once Timer Indicator	21
27. Disc Indicator	13
28. Total Indicator	15
29. Sleep Indicator	22

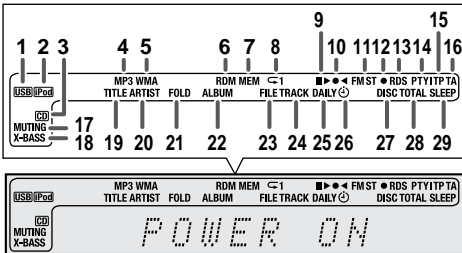

Wall mount preparation

To mount the unit on the wall

Caution:

- Be very careful to prevent the unit [2.45 kg (5.4 lbs.)] from falling when mounting on the wall.
- Before mounting, check the wall strength. (Do not put on the veneer plaster or whitewashed wall. The unit may fall.) If unsure, consult a qualified service technician.
- Mounting screws are not supplied. Use appropriate ones.
- Check all wall mount screws for looseness.
- Select a good location. If not, accidents may occur or the unit may get damaged.
- **SHARP is not responsible for accidents resulting from improper installation.**

■ Driving screws

SHARP designed the unit so you may hang it on the wall. Use proper screws (not supplied). See below for size and type.

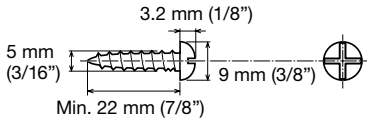

■ Installing the unit

- 1 Fix the pattern paper to the wall in horizontal position as below.

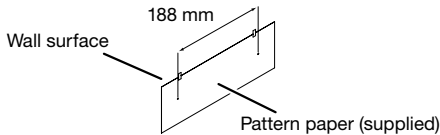

- 2 Make a hole on the wall following the screw point marks on the pattern paper by using a drill.

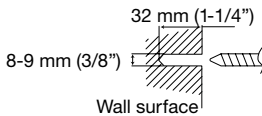

- 3 Fix a wall mount plug into the hole using a hammer, until it is flush with the wall surface.

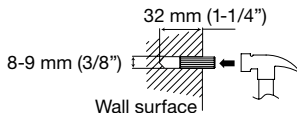

- 4 Fasten the screws to the wall as shown below. (Total screw is 2 pieces).

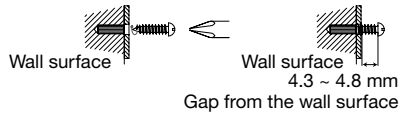

- 5 Hang the unit onto the screws.

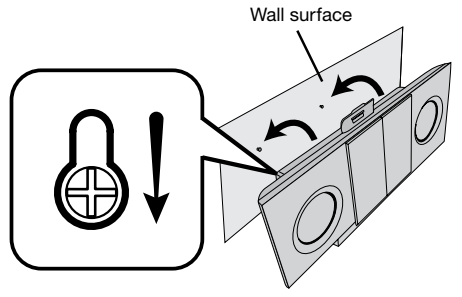

■ Falling prevention

Safety wires (not supplied) are useful to prevent the unit from falling off the wall.

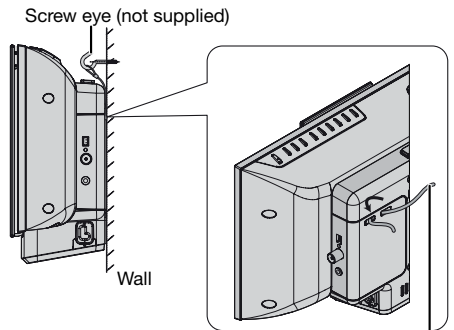

Loop the safety wires (not supplied) into each hole as shown and tie the safety wires to a hook (screw eye).

Ø wire > 1.5 mm

The diameter of wire/cable must be less than 1.5 mm.

System connections

Make sure to unplug the AC power lead before making any connections.

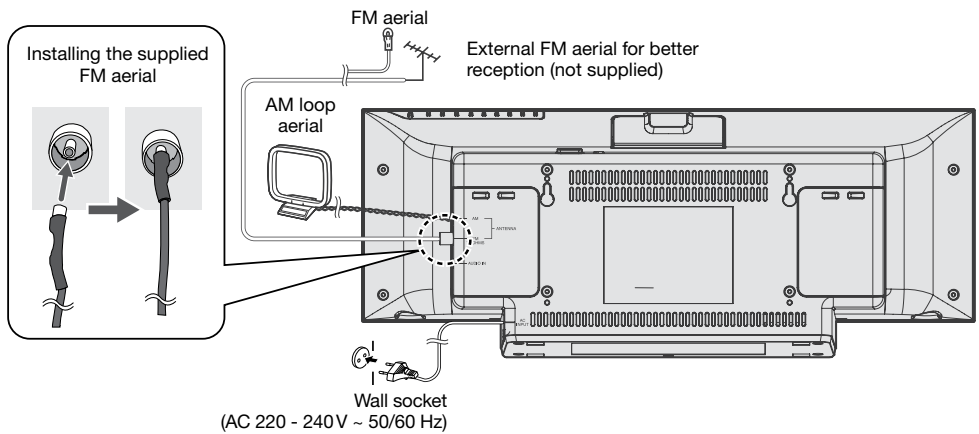

■ Aerial connection

Supplied FM aerial:

Connect the FM aerial wire to the FM 75 OHMS socket and position the FM aerial wire in the direction where the strongest signal can be received.

External FM aerial:

Use an external FM aerial (75 ohms coaxial cable) for better reception. When an external FM aerial is used, disconnect the supplied FM aerial wire.

Installing the AM loop aerial:

<Assembling>

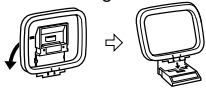

<Attaching to the wall>



Note:

Placing the aerial on the unit or near the AC power lead may cause noise pickup. Place the aerial away from the unit for better reception.

■ AC power connection

After checking all the connections have been made correctly, plug the AC power lead of this unit into the wall socket.

Note:

Unplug the AC power lead from the wall socket if the unit will not be in use for a prolonged period of time.

■ Bluetooth stand-by (Demonstration) mode

- The first time the unit is plugged in, the unit will enter the *Bluetooth* stand-by (demonstration) mode. "BT Standby" will be displayed.
- To cancel the *Bluetooth* stand-by (demonstration) mode, press the BT STAND-BY button (remote control) during power stand-by mode. The unit will enter the low power consumption mode.
- To return to the *Bluetooth* stand-by (demonstration) mode, press the BT STAND-BY button again.
- If iPod or iPhone is docked, the unit will begin charging. "Charge Mode" will be displayed. Demonstration mode is invalid during charge mode.

Remote control

Battery installation

- 1 Open the battery cover.
- 2 Insert the supplied battery according to the terminal indicated in the battery compartment.
When inserting or removing the battery, push it towards the (-) battery terminals.
- 3 Close the cover.

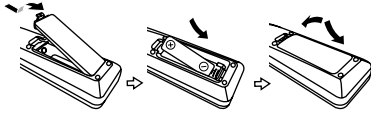

Caution:

- Remove the battery if the unit will not be used for a long period of time. This will prevent potential damage due to battery leakage.
- Do not use rechargeable battery (nickel-cadmium battery, etc.).
- Installing the battery incorrectly may cause the unit to malfunction.
- Batteries (battery pack or batteries installed) shall not be exposed to excessive heat such as sunshine, fire or the like.

Notes concerning use:

- Replace the battery if the operating distance is reduced or if the operation becomes erratic. Purchase an "AA" size battery (UM/SUM-3, R6, HP-7 or similar).
- Periodically clean the transmitter on the remote control and the sensor on the unit with a soft cloth.
- Exposing the sensor on the unit to strong light may interfere with operation. Change the lighting or the direction of the unit if this occurs.
- Keep the remote control away from moisture, heat, shock, and vibrations.

Test of the remote control

Check the remote control after checking all the connections. Point the remote control directly at the remote sensor on the unit. The remote control can be used within the range shown below:

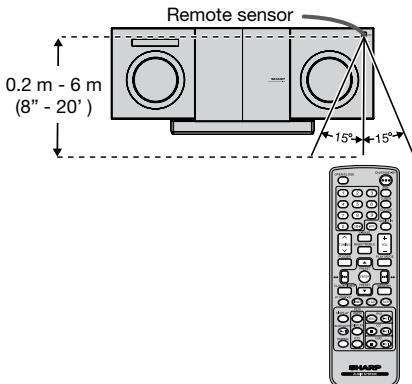

General control

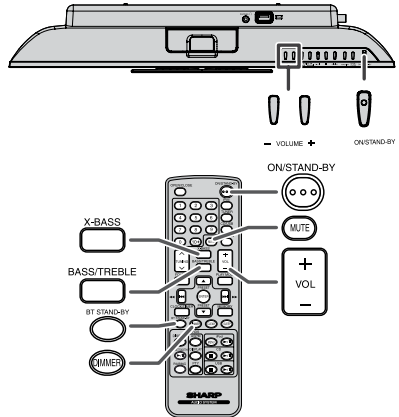

To turn the power on

Press the ON/STAND-BY button to turn the power on.

After use:

Press the ON/STAND-BY button to enter the power stand-by mode.

Display brightness control

To dim the display brightness, press the DIMMER button on the remote control.

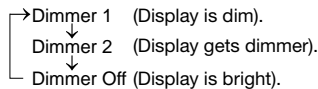

Volume auto fade-in

If you turn off and on the main unit with the volume set to 28 or higher, the volume starts at 16 and fades in to the last set level.

Volume control

Press VOLUME (+ or -) on the main unit or VOL +/- on the remote control to increase or decrease the volume.

Direct key power on function

When you press any of the following buttons, the unit turns on.

- iPod, CD/USB, AUDIO IN, TUNER, BLUETOOTH ►/II, iPod ►/II, CD ►/II, USB ►/II on the remote control: Selected function is activated.
- ►/II button on the main unit: The unit turns on and playback of the last function will start (CD, TUNER, USB, iPod, AUDIO IN, Bluetooth)

Auto power on

During BT Standby mode, when music is played from your device, the unit will automatically power on when:

- The Bluetooth connection has been set up between the main unit and your device and they remain connected.

General control (continued)

Auto power off function

The main unit will enter the stand-by mode (when iPad, iPod or iPhone is not connected) after 15 minutes of inactivity during:

iPod: Not docked.

Audio In: No detection of input signal.

CD: In the stop mode or no disc.

USB: In the stop mode or no media.

Bluetooth In the pause mode on not connected condition.

Note:

However, if iPod or iPhone is docked, the unit will begin charging.

“Charge Mode” will be displayed.

Muting

The volume is muted temporarily when pressing the MUTE button on the remote control. Press again to restore the volume.

X-Bass control

When the power is first turned on, the unit will enter the extra bass mode which emphasises the bass frequencies, and “X-BASS” indicator will appear. To cancel the extra bass mode, press the X-BASS button on the remote control.

Bass control

- 1 Press the BASS/TREBLE button to select “Bass”.
- 2 Within 5 seconds, press the VOLUME (+ or -) button to adjust the bass. “X-BASS” indicator will disappear.

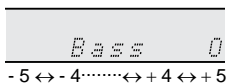

Treble control

- 1 Press the BASS/TREBLE button to select “Treble”.
- 2 Within 5 seconds, press the VOLUME (+ or -) button to adjust the treble. “X-BASS” indicator will disappear.

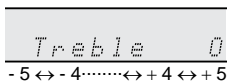

Function

When the FUNCTION button on main unit is pressed, the current function will change to different mode. Press the FUNCTION button repeatedly to select desired function.

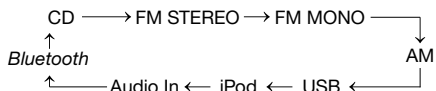

Note:

The backup function will protect the memorised function mode for a few hours should there be a power failure or the AC power lead becomes disconnected.

Setting the clock (Remote control only)

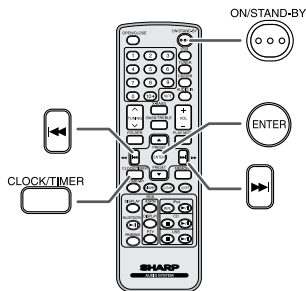

In this example, the clock is set for the 24-hour (0:00) display.

- 1 Press the ON/STAND-BY button to turn the power on.
- 2 Press the CLOCK/TIMER button.
- 3 Within 10 seconds, press the ENTER button. To adjust the day, press the left or right arrow button and then press the ENTER button.
- 4 Press the left or right arrow button to select 24-hour or 12-hour display and then press the ENTER button.

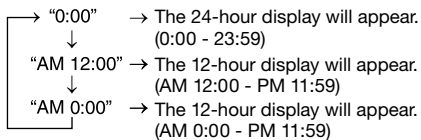

- 5 To adjust the hour, press the left or right arrow button and then press the ENTER button. Press the left or right arrow button once to advance the time by 1 hour. Hold it down to advance continuously.
- 6 To adjust the minutes, press the left or right arrow button and then press the ENTER button. Press the left or right arrow button once to advance the time by 1 minute. Hold it down to advance continuously.

To confirm the time display:

Press the CLOCK/TIMER button. The time display will appear for about 5 seconds.

Note:

When power supply is restored after unit is plugged in again or after a power failure, time display will be blinking. Reset the clock.

To readjust the clock:

Perform “Setting the clock” from step 1.

Listening to *Bluetooth* enabled devices

About *Bluetooth* technology

Bluetooth wireless technology is a short-range radio technology that enables wireless communication between various types of digital devices, such as mobile phone or computer. It operates within a range of about 10 meters (30 feet) without the hassle of having to use cables to connect these devices. Since the *Bluetooth* technology does not require line of sight between the communicating devices, it is not necessary to line up the transmitting device and the receiver, as in the case of infra red technology.

Communication System and *Bluetooth* Profile of this unit

There are many available *Bluetooth* Profiles describing the basic communication methods, specific functions and uses, to enable communication between devices.

This unit supports the following:

Communication System: *Bluetooth* Specification version 2.1 *Bluetooth* + *Enhanced Data Rate* (EDR) Profile : A2DP (Advanced Audio Distribution Profile)

A2DP enables audio streaming from an A2DP equipped *Bluetooth* stereo audio source device (eg mobile phone) to this unit. By converting wireless stereo audio signal to analogue audio signal, you can enjoy listening to the sound through this speaker system.

AVRCP (Audio/Video Remote Control Profile) is a technology that allows a single remote control to control all *Bluetooth* enabled Audio Video equipment to which a user has access.

Notes when using unit with a mobile phone

- This unit cannot be used to talk over the telephone even when there is a *Bluetooth* connection made to a mobile phone.
- Please refer to the operating manual supplied with the mobile phone for details on operation of your mobile phone while transmitting the sound using a *Bluetooth* connection.

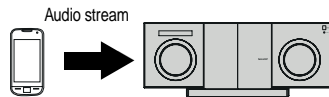

Bluetooth mobile phone or other *Bluetooth* Stereo audio source device

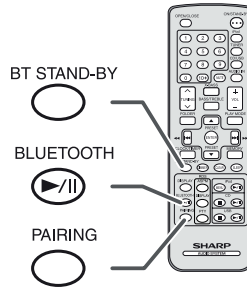
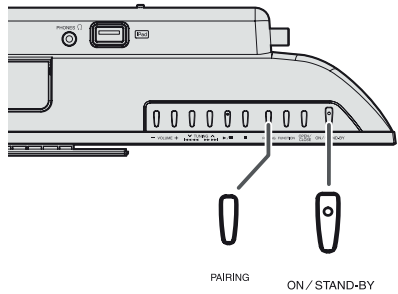

Pairing *Bluetooth* devices

Bluetooth devices need to be initially paired first before they can exchange data. Once paired, it is not necessary to pair them again unless:

- pairing is made with more than 8 devices. Pairing can only be made one device at a time. This unit can be paired to a maximum of 8 devices. If subsequent device is paired, the oldest device paired, will be deleted and replaced with the new one.
- this unit is reset. All pairing information is deleted when unit is reset.
- pairing information is deleted while re-pairing, etc.

On indicators

Status	PAIRING indicator (blue)
Unconnected	Blinks
Pairing mode	Blinks quickly
Connected	Lights up

Listening to *Bluetooth* enabled devices (continued)

■ Pairing with other *Bluetooth* source devices

- 1 Press the ON/STAND-BY button to turn the power on.
- 2 Press the BLUETOOTH ►/|| button (remote control) to select *Bluetooth* function. (PAIRING indicator blinks.)
- 3 Press and hold the PAIRING button for 3 seconds or more.
PAIRING indicator blinks quickly. The unit is now in pairing mode and is ready to be paired with other *Bluetooth* source device.
- 4 Perform pairing procedure on the source device to detect this unit. "SHARP DK-KP85" will appear in the detected devices list (if available) in the source device. (Refer the source device operating manual for details).

Notes:

- Place the devices to be paired within 1 meter (3 feet) of each other when pairing.
 - Some source devices are unable to display lists of detected devices. To pair this unit with the source device, refer to the source device operating manual for details.
- 5 Select "SHARP DK-KP85" from the source list. If Passcode* is required, enter "0000".
* Passcode may be called PIN Code, Passkey, PIN number or Password.
 - 6 Pairing indicator (blue) will stop blinking once the unit is successfully paired with the source device. (Pairing information is now memorised in the unit.)
Some audio source devices may connect with the unit automatically after pairing is completed, otherwise follow the instructions in the source device operating manual to start connection.
 - 7 Press the play button on main unit, remote control or source device to start *Bluetooth* connection.

Notes:

- If this unit or the source device is turned off before *Bluetooth* connection is completed, pairing will not be completed and the pairing information will not be memorised. Repeat step 1 onwards to start pairing again.
- To pair with other devices, repeat steps 1 - 5 for each device.
- Once a device is ousted or deleted from the pairing list, the pairing information for the device is also deleted. To listen to the sound from the device again, it needs to be re-paired. Perform steps 1 - 5 to pair the device again.
- When *Bluetooth* device is turned off, "Disconnected" is displayed briefly. Pairing LED turns off for a while and then will start blinking again.

■ Listening to the sound

Check that:

- The source device *Bluetooth* functionality is ON.
- Pairing of this unit and the source device is completed.
- Unit is in connected mode (pairing indicator (BLUE) lights up.)

- 1 Press the ON/STAND-BY button to turn the power on.
- 2 Press the FUNCTION button to select *Bluetooth* function.
- 3 Start the *Bluetooth* connection from the *Bluetooth* stereo audio source device.
- 4 Press play button (on main unit, remote control or source device).

Notes:

If the source device has an extra bass function or equalizer function, set them to off. If these functions are on, sound may be distorted.

Notes:

- You need to make the *Bluetooth* connection again if:
 - the source device is not turned on, or its *Bluetooth* functionality is off or is in sleep mode.
- During *Bluetooth* function, if the *Bluetooth* connected device and the one connected to the AUDIO IN are played simultaneously, only the *Bluetooth* sound can be heard.



■ To finish listening

Perform any of the followings.

- Disconnect the *Bluetooth* connection on the audio source device.
Refer the operating manual supplied with the device.
- Turn off the *Bluetooth* stereo audio source device.
- Turn off this unit.

Note:

The volume of this unit may not be controlled as intended depending on the device.

<i>Bluetooth</i> operation buttons (remote control only)	
BLUETOOTH 	Press the button to play or pause.
	Press the button to skip up. Press and hold to fast forward.
	Press the button to skip down. Press and hold to fast reverse.

Listening to the iPod, iPhone or iPad

Made for:

- iPhone 5
- iPhone 4S
- iPhone 4
- iPhone 3GS
- iPhone 3G
- iPhone
- iPad (4th generation)
- iPad mini
- iPad (3rd generation)
- iPad 2
- iPod
- iPod touch (5th generation)
- iPod touch (4th generation)
- iPod touch (3rd generation)
- iPod touch (2nd generation)
- iPod touch (1st generation)
- iPod classic
- iPod nano (7th generation)
- iPod nano (6th generation)
- iPod nano (5th generation)
- iPod nano (4th generation)
- iPod nano (3rd generation)
- iPod nano (2nd generation)

Caution:

Please update your iPod, iPhone and iPad unit to the latest software version before using it. Please visit Apple's homepage to download the latest version for your iPod, iPhone and iPad.

Notes:

- Charging terminal for iPod, iPhone and iPad:

CONDITION	DOCK	USB TERMINAL
USB function	NO	YES
Other function (iPod / CD / Tuner / Audio In)	YES	NO
Stand-by	YES	NO
BT Standby	YES	NO

- The message "This accessory is not made to work with iPhone" or similar, may appear on the iPhone screen when:
 - battery is low.
 - the iPhone is not properly docked (eg. slanting).
- If this occurs, remove and re-dock the iPhone.
- You may also experience brief audio interference during incoming calls.

■ iPod, iPhone and iPad connection (USB only)

- 1 Insert the connector to the iPod, iPhone or iPad.

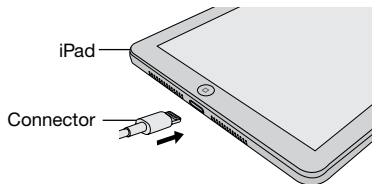

- 2 Place the iPad to the stand for iPad.

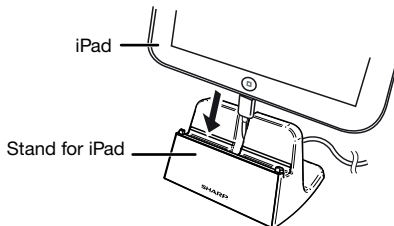

- 3 Connect the iPod, iPhone or iPad to the unit via USB connector.

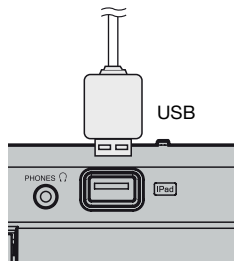

■ iPod, iPhone or iPad playback via USB terminal

- 1 Press the ON/STAND-BY button to turn the power on.
- 2 Press the CD/USB button on the remote control or FUNCTION button repeatedly on the main unit to select USB function.
- 3 Connect iPod, iPhone or iPad to the unit. "USB/iPod" will appear.

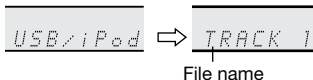

- 4 Press the ►/⏮ (USB ►/⏮) button to start playback.

Note:

Stop button (■) is invalid during iPod, iPhone or iPad playback

Listening to the iPod, iPhone or iPad (continued)

■ iPhone playback

- Sound will only switch from iPhone to the main unit after authentication process is completed in approximately 10 seconds.
- Incoming calls will pause the playback.
- Once the calls are answered, the conversation can only be heard through the built-in iPhone speaker. Turn on the iPhone speaker or undock the iPhone to start conversation.

■ iPod and iPhone connection (Dock only)

Caution:

Unplug all accessories from the iPod or iPhone before inserting it into the dock.

Note:

Docking station is for iPod touch (5th generation), iPod nano (7th generation) and iPhone 5 connection only. Other Apple products (iPod, iPhone and iPad) can be connected via USB terminal.

- 1 Open the docking station for iPod and iPhone by pulling up the cover.



- 2 Dock your iPod or iPhone into the unit.

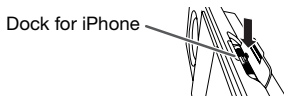
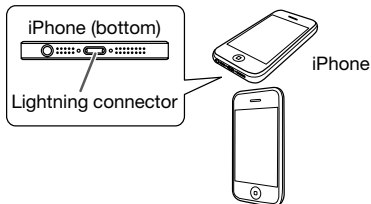

■ iPod or iPhone playback

- 1 Press the ON/STAND-BY button to turn the power on.
- 2 Press the iPod button on the remote control or FUNCTION button repeatedly on the main unit to select iPod function.
- 3 Insert iPod or iPhone unit into the dock of main unit. "Dock Ok" will appear.
- 4 Press the ▶/⏮ (iPod ▶/⏮) button to start playback.

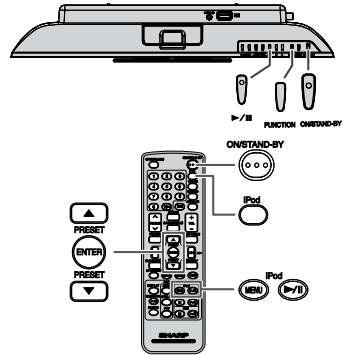

■ Navigating the iPod, iPhone or iPad menus

- 1 Press the MENU button to view the menu on iPod, iPhone or iPad unit. Press it again to go back to previous menu.
- 2 Use the PRESET (▼ or ▲) button to select an item on the menu and then press ENTER button.

Note:

When navigating the iPod, iPhone or iPad menu with remote control, do not operate any of the buttons on the iPod or iPhone unit. The volume level is adjusted by pressing the VOLUME (+ or -) on the main unit or VOL +/- on the remote control. Adjusting the volume on the iPod, iPhone or iPad units give no effect.

iPod, iPhone and iPad operations:

The operations described below depend on the generation of iPod, iPhone and iPad you are using.

System on operation:

When the main unit is powered on, the iPod, iPhone or iPad units will automatically power on when docked or connected in the unit.

System off (stand-by operation):

When the main unit is turned to stand-by mode, the docked iPod, iPhone or connected iPad unit will automatically turn to stand-by mode.

Listening to the iPod, iPhone or iPad (continued)

To disconnect iPod, iPhone or iPad

Simply remove the iPod or iPhone from the docking station or iPad connector from USB terminal. It is safe to do so even during playback.

Caution:

- Stop button (■) at main unit is invalid during iPod function.

Various iPod, iPhone and iPad functions

Function	Main unit	Remote control		Operation
	Dock/USB	Dock	USB	
Play		iPod	USB	Press in the pause mode.
Pause				Press in the playback mode.
Track up/down				Press in the playback or pause mode. If you press the button in the pause mode, press the ►/ button to start the desired track.
Fast forward/reverse				Press and hold down in the playback mode. Release the button to resume playback.
Repeat	—	PLAY MODE		Press to toggle repeat mode.
Shuffle	—			Press and hold to toggle shuffle mode.
Menu	—	iPod		Press to view the iPod menu during iPod function.
Enter	—			Press to confirm the selection.
Cursor Up/Down	—		PRESET	Press to select the iPod menu.

Listening to a CD or MP3/WMA disc

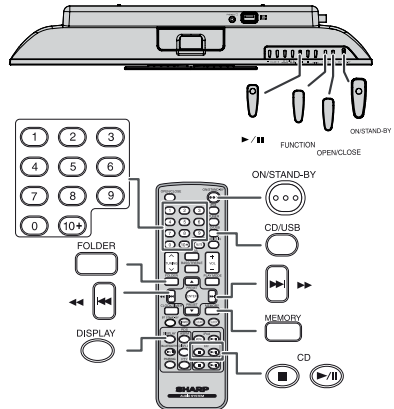

This system can play back a standard CD, CD-R/RW in the CD format and CD-R/RW with MP3 or WMA files, but cannot record on them. Some audio CD-R and CD-RW discs may not be playable due to the state of the disc or the device that was used for recording.

MP3:

MP3 is a form of compression. It is an acronym which stands for MPEG Audio Layer 3. MP3 is a type of audio code which is processed by significant compression from the original audio source with very little loss in sound quality.

- This system supports MPEG 1 Layer 3 and VBR files.
- During VBR file playback, time counter in the display may differ from its actual playback time.
- Bitrate which is supported by MP3 is 32 ~ 320 kbps.

WMA:

WMA files are Advanced System Format files that include audio files which are compressed with Windows Media Audio codec. WMA is developed by Microsoft as an audio format file for Windows Media Player.

- "MP3" and "WMA" indicator will light up after the unit reads information on an MP3 or WMA disc.
- Bitrate which is supported by WMA is 64 ~ 160 kbps.

Disc playback

- 1 Press the ON/STAND-BY button to turn the power on.
- 2 Press the CD/USB button on the remote control or FUNCTION button repeatedly on the main unit to select CD function.
- 3 Press the OPEN/CLOSE button to open the disc compartment.
- 4 Place the disc in the disc compartment, label side front.

Listening to a CD or MP3/WMA disc (continued)

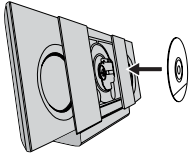

- 5 Press the OPEN/CLOSE button to close the disc compartment.
- 6 Press the ►/|| (CD ►/||) button to start playback. After the last track is played, the unit will stop automatically.

To stop playback:

- Press the ■ (CD ■) button.

Caution:

- Do not place two discs in the disc compartment.
- Do not play discs of special shapes (heart, octagon, etc). It may cause malfunctions.
- Do not push the disc compartment while it is moving.
- If the power fails while the compartment is open, wait until the power is restored.
- If TV or radio interference occurs during CD operation, move the unit away from the TV or radio.
- Be sure to place 8 cm (3") disc in the middle of the disc compartment.
- Due to the structure of the disc information, it takes longer to read an MP3/WMA disc than a normal CD (approximately 20 to 90 seconds).

Notes for CD or MP3/WMA disc:

- Rewritable multi-session discs with unfinished writing, can still be played.

■ Various disc functions

Function	Main unit	Remote control	Operation
Play 		CD 	Press in the stop mode.
Pause 			Press in the playback mode. Press the ►/ button to resume playback from the paused point.
Stop 		CD 	Press in the playback mode.
Track up/down			Press in the playback or stop mode. If you press the button in the stop mode, press the ►/ button to start the desired track.
Fast forward/reverse			Press and hold down in the playback mode. Release the button to resume playback.

Advanced CD or MP3/WMA disc playback

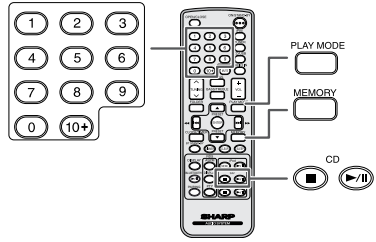

■ Direct track search

By using the Numeric buttons, the desired tracks on the current disc can be played.

Use the Numeric buttons on the remote control to select the desired track.

- The Numeric buttons allow you to select up to number 9.
- When selecting number 10 or higher, use the "10+" button.

A. For example, to choose 13

- 1 Press the "10+" button once.
- 2 Press the "1" button.
- 3 Press the "3" button.

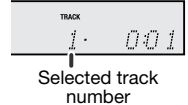

B. For example, to choose 130

- 1 Press the "10+" button twice.
- 2 Press the "1" button.
- 3 Press the "3" button.
- 4 Press the "0" button.

Notes:

- A track number higher than the number of tracks on the disc cannot be selected.
- During random play, direct search is not possible.

■ Repeat play

Repeat play can play one track, all tracks or a programmed sequence continuously.

To repeat one track:

Press the PLAY MODE button repeatedly until "Repeat One" appears. Press the ►/|| (CD ►/||) button.

To repeat all tracks:

Press the PLAY MODE button repeatedly until "Repeat All" appears. Press the ►/|| (CD ►/||) button.

To repeat desired tracks:

Perform steps 1 - 5 in "Programmed play" section on page 14 and then press the PLAY MODE button repeatedly until "Repeat All" appears.

To repeat one folder :

While in Folder mode on (MP3/WMA), press PLAY MODE button repeatedly until "Repeat Folder" appears. Press the ►/|| (CD ►/||) button.

To cancel repeat play:

Press the PLAY MODE button repeatedly until "Normal" appears and "☞" disappears.



Caution:

After performing repeat play, be sure to press the ■ (CD ■) button. Otherwise, the disc will play continuously.

Advanced CD or MP3/WMA disc playback (continued)

■ Random play

The tracks on the disc can be played in random order automatically.

To random play all tracks:

Press and hold the PLAY MODE button on the remote control until "Random" appears. Press the ►/II (CD ►/II) button.

To cancel random play:

Press the PLAY MODE button again. "RDM" indicator will disappear.



Notes:

- If you press the ►► button during random play, you can move to the track selected next by the random operation. On the other hand, the ◀◀ button does not allow you to move to the previous track. The beginning of the track being played will be located.
- In random play, the unit will select and play tracks automatically. (You cannot select the order of the tracks.)

■ Programmed play (CD)

You can choose up to 32 selections for playback in the order you like.

- 1 While in the stop mode, press the MEMORY button on the remote control to enter the programming save mode.



- 2 Press the ◀◀ or ►► button on the remote control to select the desired track.



Selected track number

- 3 Press the MEMORY button to save the track number.
- 4 Repeat steps 2 - 3 for other tracks. Up to 32 tracks can be programmed. If you want to check the programmed tracks, press the MEMORY button repeatedly. If you make a mistake, the programmed tracks can be cleared by pressing the CLEAR button.
- 5 Press the ►/II (CD ►/II) button to start playback.

■ Programmed play (MP3/WMA)

- 1 While in the stop mode, press the MEMORY button to enter the programming save mode.



- 2 Press the PRESET (▼ or ▲) button on the remote control to select the desired folder.



Then press the ◀◀ or ►► button on the remote control to select the desired tracks.



- 3 Press the MEMORY button to save the folder and track number.
- 4 Repeat steps 2 - 3 for other folder/tracks. Up to 32 tracks can be programmed.
- 5 Press the ►/II (CD ►/II) button to start playback.

To cancel the programmed play mode:

During programmed stop mode, press the ■ (CD ■) button. The display will show "Memory Clear" and all the programmed contents will be cleared.

Adding tracks to the programme:

If a programme has been previously stored, the "MEM" indicator will be displayed. Press the MEMORY button. Then follow steps 2 - 3 to add tracks.

Notes:

- When the disc compartment is opened, the programme is automatically cancelled.
- If you press the ON/STAND-BY button to enter the stand-by mode or change the function from CD to another, the programmed selections will be cleared.
- During the programme operation, random play is not possible.

MP3/WMA folder mode (only for MP3/WMA files)

To play back MP3/WMA (Windows Media Audio) file

There are many music sites on the internet that you can download MP3/WMA (Windows Media Audio) music files. Follow the instructions from the website on how to download the music files. You can then play back these downloaded music files by burning them to a CD-R/RW disc.

- Your downloaded song/files are for personal use only. Any other usage of the song without owner's permission, is against the law.

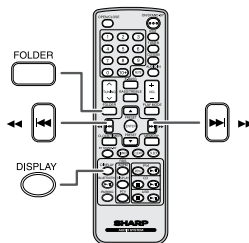

About folder playback order

If MP3/WMA files are recorded in several folders, a folder number will be set to each folder automatically. These folders can be selected by the FOLDER button on the remote control. If there is no supported file formats inside the selected folder, the folder is skipped and the next folder will be selected.

Example: How to set folder number if MP3/WMA format files are recorded as below figure.

- ROOT folder is set as folder 1.
- As for folders inside ROOT folder (Folder A and Folder B), the folder which is recorded earlier on the disc will be set as folder 2 and folder 6.
- As for folder inside Folder A (Folder C and Folder D), the folder which is recorded earlier on the disc will be set as folder 3 and folder 4.
- Folder E that is inside Folder D will be set as folder 5.

- The folder and file order information which is recorded on the disc depends on the writing software. There may be possibilities that this unit will playback the files not according to our expected playback order.
- For CD MP3/WMA, 999 numbers of folders and files inclusive of the folders which have non playable files can be read.

Folder mode on/off can be operated by the FOLDER button on the remote control. Files that are played when folder mode is set to the on position, may differ from those played back when folder mode is turned off.

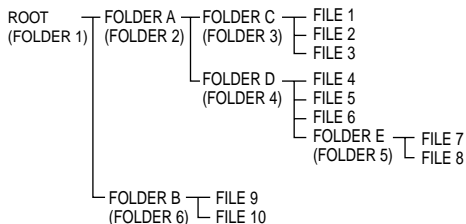

Procedure to playback MP3/WMA disc with folder mode on

To play back CD-R/RW.

- Press the CD/USB button on the remote control, and load an MP3/WMA disc. Press the FOLDER button and disc info will be displayed.

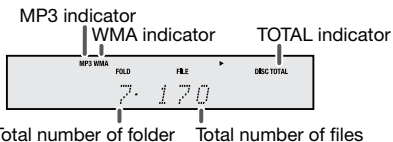

- Press the PRESET (▼ or ▲) button to select desired playback folder. (Folder mode on)

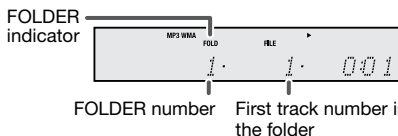

- Select desired file to be played back by pressing the ◀◀ or ▶▶ button.
- Press the ▶/|| (CD ▶/||) button. Playback will start and file name will be displayed.

- Title, Artist and Album name are displayed if they are recorded on the disc.
- In case of playback with the folder mode on, press the PRESET (▼ or ▲) button, and the folder can be selected even though it is in playback/pause mode. It will continue playback/pause mode in the 1st track of the selected folder.
- Display content can be changed by pressing the DISPLAY button.

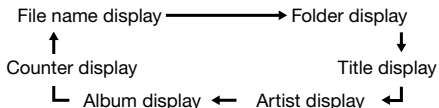

Note:

If "Not Support" is displayed, it means "Copyright protected WMA file" or "Not supported playback file" is selected.

Listening to USB mass storage device/MP3 player

Notes:

1. Remove the USB terminal cover before use. Keep it away from children as it may be swallowed.
2. Cover the USB terminal if it is not used for a long period of time to prevent dust or rust.

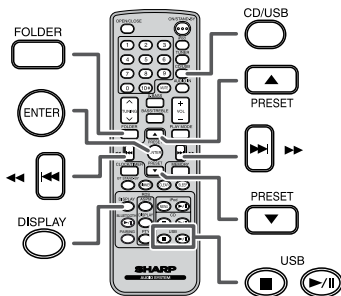
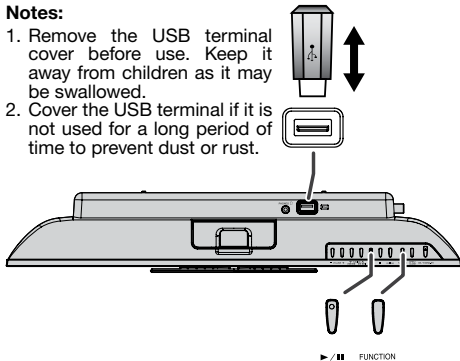

Note:

This product is not compatible with MTP and AAC file systems from USB mass storage device or MP3 player.

■ To play back USB/MP3 player with folder mode off

- 1 Press the CD/USB button on the remote control or FUNCTION button repeatedly on main unit to select USB function. Connect the USB memory device that has MP3/WMA format files on the unit. When the USB memory is connected to the main unit, the device information will be displayed.
- 2 Select desired file to be played back by pressing the ◀◀ or ▶▶ button.
- 3 Press the ▶/|| (USB ▶/||) button. Playback will start and the file name will be displayed.
 - Title, Artist and Album name are displayed if they are recorded in the USB memory device.
 - Display content can be changed by pressing the DISPLAY button.

Note:

To pause playback:
Press the ▶/|| (USB ▶/||) button.

■ To play back USB/MP3 player with folder mode on

- 1 Press the USB button on the remote control or FUNCTION button repeatedly on main unit to select USB function. Connect the USB memory device that has MP3/WMA format files on the unit. When the USB memory is connected to the main unit, the device information will be displayed.
- 2 Press the FOLDER button, and press the PRESET (▼ or ▲) button to select desired playback folder. To start playback with folder mode on, go to step 4. To change the playback folder, press the PRESET (▼ or ▲) button to select another folder.
- 3 Select desired file to be played back by pressing the ◀◀ or ▶▶ button.
- 4 Press the ▶/|| (USB ▶/||) button. Playback will start and the file name will be displayed.
 - Title, Artist and Album name are displayed if they are recorded in the USB memory device.
 - Display content can be changed by pressing the DISPLAY button.

■ To remove USB memory device

- 1 Press the ■ (USB ■) button to stop playback.
- 2 Disconnect USB memory device from the USB terminal.

Notes:

- SHARP will not be held liable for the loss of data while the USB memory device is connected to the audio system.
- Files compressed in MP3 and/or WMA format can be played back when connected to the USB terminal.
- This USB memory's format supports FAT 16 or FAT 32.
- SHARP cannot guarantee that all USB memory devices will work on this audio system.
- USB cable is not recommended for use in this audio system to connect to USB memory device. Use of the USB cable will affect the performance of this audio system. iPod, iPhone and iPad is not prone to this condition.
- This USB memory cannot be operated via USB hub.
- The USB terminal in this unit is not intended for a PC connection but is used for music streaming with a USB memory device.
- External HDD-storage cannot be played back via USB terminal.
- If the data inside the USB memory is large, it may take longer time for the data to be read.
- This product can play WMA and MP3 files. It will automatically detect the file type being played. If unplayable file is played on this product, "Not Support" is indicated and the file will be automatically skipped. This will take a few seconds. If abnormal indications appear on the display due to the unspecified file, turn off the unit and then turn it on again.
- This product relates to USB mass storage devices and MP3 players. It may however face some irregularities due to various unforeseen reasons from some devices. Should this happen, turn off the unit and then turn it on again.
- During CD function, MP3 player will not be charging.

The following functions are the same as CD operations:

	Page
Direct track search	13
Repeat play	13
Random play	14
Programmed play (MP3/WMA)	14

Note:

If USB memory device is not connected, "USB No Media" will be shown on the display.

Notes:

- This unit only supports "MPEG-1 Audio Layer-3" format. (Sampling Frequency is 32, 44.1, 48kHz)
- Playback order for MP3 files may differ depending on the writing software used during file download.
- Bitrate which is supported by MP3 is 32~320 kbps, WMA is 64~160 kbps.
- For MP3/WMA files, please put ".MP3" ".WMA" extension. Files cannot be played back if there is no MP3/WMA extension.
- Playlists are not supported on this unit.
- This unit can display Folder Name or File Name up to 32 characters.
- Maximum total number of MP3/WMA files is 65025.
- Total number of folders read is 999 including folder with non-playable file. However, the display shows only folder with MP3 files.
- The display playback time may not be displayed correctly when playing back a variable bitrate file.
- The ID3TAG information supported are TITLE, ARTIST and ALBUM only. Title name, artist name and album name can be displayed by pressing the DISPLAY button during file playback or pause mode.
- WMA meta tag also supports title, artist and album name which are recorded in WMA files. Copyright protected WMA files cannot be played back.

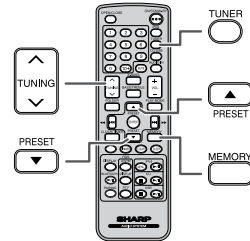
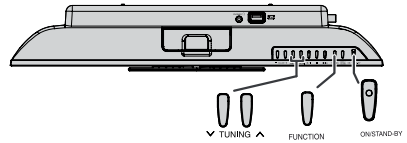

Tuning

- 1 Press the ON/STAND-BY button to turn the power on.
 - 2 Press the FUNCTION button on the main unit or TUNER button on the remote control repeatedly to select FM Stereo, FM Mono or AM.
 - 3 Press the TUNING (∨ or ∧) button on the main unit or remote control to tune in to the desired station.
- **Manual tuning:**
Press the TUNING (∨ or ∧) button repeatedly to tune in to the desired station.
 - **Auto tuning:**
When the TUNING (∨ or ∧) button is pressed for more than 0.5 seconds, scanning will start automatically and the tuner will stop at the first receivable broadcast station.

Notes:

- When radio interference occurs, auto scan tuning may stop automatically at that point.
- Auto scan tuning will skip weak signal stations.
- To stop the auto tuning, press the TUNING (∨ or ∧) button again.
- When an RDS (Radio Data System) station is tuned in, the frequency will be displayed first, and then the RDS indicator will light up. Finally, the station name will appear.
- Full auto tuning can be achieved for RDS stations "ASPM", see page 19.

To receive an FM stereo transmission:

- Press the TUNER button to select stereo mode and "ST" indicator will be displayed. "▶◀" and "◉" will appear when an FM broadcast is in stereo.
- If the FM reception is weak, press the TUNER button to extinguish the "ST" indicator. The reception changes to monaural, and the sound becomes clearer.

Listening to the radio (continued)

Memorising a station

You can store 40 AM and FM stations in memory and recall them at the push of a button. (Preset tuning)

- 1 Perform steps 2 - 3 in "Tuning".
- 2 Press the MEMORY button.



- 3 Within 30 seconds, press the PRESET (▼ or ▲) button to select the preset channel number. Store the stations in memory, in order, starting with preset channel 1.
- 4 Within 30 seconds, press the MEMORY button to store that station in memory. If the "MEM" and preset number indicators disappear before the station is memorised, repeat the operation from step 2.
- 5 Repeat steps 1 - 4 to set other stations, or to change a preset station. When a new station is stored in the memory, the station previously memorised for that preset channel number will be erased.

Note:

The backup function protects the memorised stations for a few hours should there be a power failure or the AC power lead becomes disconnected.

To recall a memorised station

Press the PRESET (▼ or ▲) button to select the desired station.

To scan the preset stations

The stations saved in the memory can be scanned automatically. (Preset memory scan)

- 1 Press and hold the PRESET (▼ or ▲). The preset number will flash and the programmed stations will be tuned in sequentially, for 5 seconds each.
- 2 Press the PRESET (▼ or ▲) button again when the desired station is located.

To erase entire preset memory

- 1 Press the ON/STAND-BY button to turn the power on.
- 2 Press the FUNCTION button (main unit) repeatedly or TUNER button (remote control) to select Tuner function.
- 3 In Tuner function, press and hold the CLEAR button (remote control) until "Tuner Clear" appears.

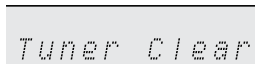

Using the Radio Data System (RDS)

RDS is a broadcasting service which a growing number of FM stations provide. These FM stations send additional signals along with their regular programme signals. They send their station names, and information about the type of programme such as sport, music, etc.

When tuned to an RDS station, "RDS" and the station name will be displayed.

"TP" (Traffic Programme) will appear on the display when the received broadcast carries traffic information, and "TA" (Traffic Announcement) will appear while a traffic information is on air.

"PTYI" (Dynamic PTY Indicator) will appear while the Dynamic PTY station is received.



You can control the RDS by using the buttons on the remote control only.

Information provided by RDS

Each time the RDS DISPLAY button is pressed, the display will switch as follows:

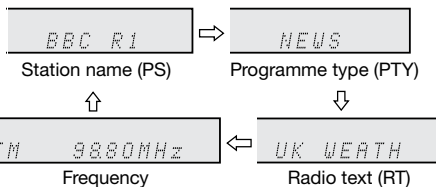
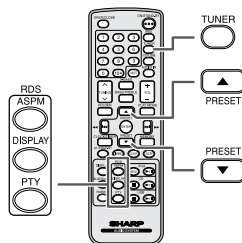

When tuning in to a station other than an RDS station or to an RDS station which sends weak signal, the display will change in the following order:

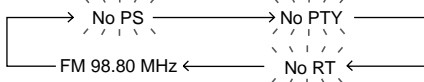

Using the Radio Data System (RDS) (continued)

■ Using the Auto Station Programme Memory (ASPM)

While in the ASPM operation mode, the tuner will automatically search for new RDS stations. Up to 40 stations can be stored.

If you have already stored some stations in memory, the number of new stations you can store will be less.

- 1 Press the TUNER button on the remote control or FUNCTION button repeatedly on the main unit to select TUNER function.
- 2 Press and hold down the RDS ASPM button on the remote control.
 - 1 After "ASPM" has flashed for about 4 seconds, scanning will start (87.50 - 108.00 MHz).

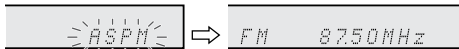

- 2 When an RDS station is found, "RDS" will appear for a short time and the station will be stored in memory.



- 3 After scanning, the number of stations stored in memory will be displayed for 4 seconds, and then "END" will appear for 4 seconds.

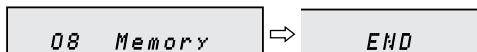

To stop the ASPM operation before it is complete:

Press the RDS ASPM button while it is scanning for stations. The stations which are already stored in memory will be kept there.

Notes:

- If the same station is broadcasting on different frequencies, the strongest frequency will be stored in memory.
- Any station which has the same frequency as the one stored in memory will not be stored.
- If 40 stations have already been stored in memory, the scan will be aborted. If you want to redo the ASPM operation, erase the preset memory.
- If no station has been stored in memory, "END" will appear for a short while.
- If the RDS signals are very weak, station names may not be stored in memory.
- The same station name can be stored in different channels.
- In a certain area or during certain time periods, the station names may temporarily be different.

■ Notes for RDS operation

If any of the following events occur, it does not mean that the unit is faulty:

- "PS", "No PS" and a station name appear alternately, and the unit does not operate properly.
- If a particular station is not broadcasting properly or a station is conducting tests, the RDS reception function may not work properly.
- When you receive an RDS station whose signal is too weak, information like the station name may not be displayed.
- "No PS", "No PTY" or "No RT" will flash for about 5 seconds, and then the frequency will be displayed.

Notes for radio text:

- The first 14 characters of the radio text will appear for 4 seconds and then they will scroll across the display.
- If you tune in to an RDS station which is not broadcasting any radio text, "No RT" will be displayed when you switch to the radio text position.
- While radio text data is received or when the text contents change, "RT" will be displayed.

■ To recall stations in memory

To specify programmed types and select stations (PTY search):

You can search a station by specifying the programme type (news, sports, traffic programme, etc. ...see page 20) from the stations in memory.

- 1 Press the TUNER button on the remote control or FUNCTION button repeatedly on the main unit to select TUNER function.
- 2 Press the RDS PTY button on the remote control.



"SELECT" and "PTY TI" will appear alternately for about 6 seconds.

- 3 Within 6 seconds, press the TUNING (✓ or ^) button to select the programme type.



Each time the button is pressed, the programme type will appear.

- 4 While the selected programme type is flashing (within 6 seconds), press the RDS PTY button again.



After the selected programme type has been lit for 2 seconds, "SEARCH" will appear, and the search operation will start.

Notes:

- If the display has stopped flashing, start again from step 2. If the unit finds a desired programme type, the corresponding channel number will lit for about 8 seconds, and then the station name will remain lit.
- If you want to listen to the same programme type of another station, press the RDS PTY button while the channel number or station name is flashing. The unit will look for the next station.
- If no station can be found, "Not Found" will appear for 4 seconds.

If you select the traffic programme:

If you select the traffic programme (TP) in step 3, "TP" will appear.

(This does not mean that you can listen to the traffic information at that time.)

When the traffic information is broadcast, "TA" will appear.

Using the Radio Data System (RDS) (continued)

Descriptions of the PTY (Programme Type) codes, TP (Traffic Programme) and TA (Traffic Announcement)

You can search for and receive the following PTY, TP and TA signals.

NEWS	Short accounts of facts, events and publicly expressed views, reportage and actuality.
AFFAIRS	Topical programme expanding or enlarging upon the news, generally in different presentation style or concept, including debate, or analysis.
INFO	Programmes whose purpose is to impart advice in the widest sense.
SPORT	Programme concerned with any aspect of sport.
EDUCATE	Programme intended primarily to educate, of which the formal element is fundamental.
DRAMA	All radio plays and serials.
CULTURE	Programmes concerned with any aspect of national or regional culture, including language, theatre, etc.
SCIENCE	Programmes about the natural sciences and technology.
VARIED	Used for mainly speech-based programmes usually of light-entertainment nature, not covered by other categories. Examples include: quizzes, panel games, personality interviews.
POP M	Commercial music, which would generally be considered to be of current popular appeal, often featuring in current or recent record sales charts.
ROCK M	Contemporary modern music, usually written and performed by young musicians.
EASY M	Current contemporary music considered to be "easy-listening", as opposed to Pop, Rock or Classical, or one of the specialised music styles, Jazz, Folk or Country. Music in this category is often but not always, vocal, and usually of short duration.
LIGHT M	Classical music for general, rather than specialist appreciation. Examples of music in this category are instrumental music, and vocal or choral works.
CLASSICS	Performances of major orchestral works, symphonies, chamber music, etc., and including Grand Opera.
OTHER M	Musical styles not fitting into any of the other categories. Particularly used for specialist music of which Rhythm & Blues and Reggae are examples.
WEATHER	Weather reports and forecasts and meteorological information.
FINANCE	Stock Market reports, commerce, trading, etc.
CHILDREN	For programmes targeted at a young audience, primarily for entertainment and interest, rather than where the objective is to educate.

SOCIAL	Programmes about people and things that influence them individually or in groups. Includes: sociology, history, geography, psychology and society.
RELIGION	Any aspect of beliefs and faiths, involving a God or Gods, the nature of existence and ethics.
PHONE IN	Involving members of the public expressing their views either by phone or at a public forum.
TRAVEL	Features and programmes concerned with travel to near and far destinations, package tours and travel ideas and opportunities. Not for use for announcements about problems, delays, or roadworks affecting immediate travel where TP/TA should be used.
LEISURE	Programmes concerned with recreational activities in which the listener might participate. Examples include, Gardening, Fishing, Antique collecting, Cooking, Food & Wine, etc.
JAZZ	Polyphonic, syncopated music characterised by improvisation.
COUNTRY	Songs which originate from, or continue the musical tradition of the American Southern States. Characterised by a straightforward melody and narrative story line.
NATION M	Current Popular Music of the Nation or Region in that country's language, as opposed to International "Pop" which is usually US or UK inspired and in English.
OLDIES	Music from the so-called "golden age" of popular music.
FOLK M	Music which has its roots in the musical culture of a particular nation, usually played on acoustic instruments. The narrative or story may be based on historical events or people.
DOCUMENT	Programme concerned with factual matters, presented in an investigative style.
TEST	Broadcast when testing emergency broadcast equipment or receivers.
ALARM	Emergency announcement made under exceptional circumstances to give warning of events causing danger of a general nature.
NONE	No programme type (receive only).
TP	Broadcasts which carry traffic announcements.
TA	Traffic announcements are being broadcast.

Timer and sleep operation (Remote control only)

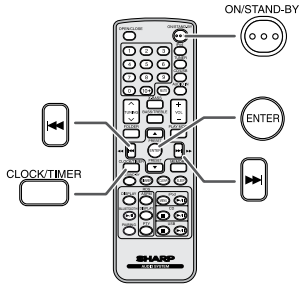

Timer playback:

The unit turns on and plays the desired source (CD, TUNER, USB, iPod, AUDIO IN) at a preset time.

This unit has 2 types of timer: ONCE TIMER and DAILY TIMER.

Once timer ("⊙" indicator):

Once timer play works for one time only at a preset time.

Daily timer ("DAILY" indicator):

Daily timer play works at the same preset time every day that we set. For example, set the timer as a wake-up call every morning.

Using the once timer and daily timer in combination:

For example, use the once timer to listen a radio programme, and use the daily timer to wake up.

- 1 Set the daily timer.
- 2 Set the once timer.

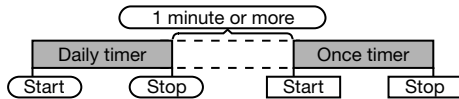

■ Timer playback

Before setting timer:

- Check that the clock is set to the correct time (refer to page 7). If it is not set, you cannot use the timer function.
- For timer playback: Plug in USB or load discs or dock iPod to be played.



- 1 Press the ON/STAND-BY button to turn the power on.
- 2 Press and hold the CLOCK/TIMER button.
- 3 Within 10 seconds, press the ◀ or ▶ button to select "Once" or "Daily", and press the ENTER button.
- 4 Within 10 seconds, press the ◀ or ▶ button to select "Timer Set", and press the ENTER button.
- 5 To select the timer playback source (CD, TUNER, USB, iPod, AUDIO IN), press the ◀ or ▶ button. Press the ENTER button.
When you select the tuner, select a station by pressing the ◀ or ▶ button, and then press the ENTER button. If a station has not been programmed, "No Preset" will be displayed and timer setting will be cancelled.
- 6 To adjust the day, press the ◀ or ▶ button and then press the ENTER button.
- 7 Press the ENTER button to adjust the hour. Press the ◀ or ▶ button and then press the ENTER button.

- 8 To adjust the minutes, press the ◀ or ▶ button and then press the ENTER button.
- 9 Set the time to finish as in steps 7 and 8 above.
- 10 Adjust the volume using the VOLUME (+ or -) on the main unit or VOL +/- on the remote control, and then press the ENTER button. Do not turn the volume up too high.
- 11 Press the ON/STAND-BY button to enter the power stand-by mode. The "TIMER" indicator lights up and the unit is ready for timer playback.

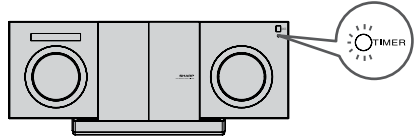

- 12 When the preset time is reached, playback will start. The volume will increase gradually until it reaches the preset volume. The timer indicator will blink during timer playback. When the timer end time is reached, the system will enter the power stand-by mode automatically.

Once timer:

The timer will be cancelled.

Daily timer:

The timer operates at the same time every selected day. It will continue until the daily timer setting is cancelled. Cancel the daily timer when it is not in use.

Notes:

- When performing timer playback using another unit connected to the USB terminal or AUDIO IN socket, select "USB" or "AUDIO IN" in step 5.
- This unit will turn on or enter the power stand-by mode automatically. However, the connected unit will not turn on or off. To stop the timer playback, follow step "Cancelling the timer setting" of this page.

Checking the timer setting:

- 1 Turn the power on and press and hold down the CLOCK/TIMER button.
- 2 Within 10 seconds, press the ◀ or ▶ button to select "Once" or "Daily", and press the ENTER button.
- 3 Within 10 seconds, press the ◀ or ▶ button to select "Timer Call", and press the ENTER button.

Cancelling the timer setting:

- 1 Turn the power on and press and hold down the CLOCK/TIMER button.
- 2 Within 10 seconds, press the ◀ or ▶ button to select "Once" or "Daily", and press the ENTER button.
- 3 Within 10 seconds, press the ◀ or ▶ button to select "Timer Off", and press the ENTER button. Timer will be cancelled (the setting will not be cancelled).

Reusing the memorised timer setting:

The timer setting will be memorised once it is entered. To reuse the same setting, perform the following operations.

- 1 Turn the power on and press and hold down the CLOCK/TIMER button.
- 2 Within 10 seconds, press the ◀ or ▶ button to select "Once" or "Daily", and press the ENTER button.
- 3 Within 10 seconds, press the ◀ or ▶ button to select "Timer On", and press the ENTER button.
- 4 Press the ON/STAND-BY button to enter the power stand-by mode.

Timer and sleep operation (Remote control only) (continued)

■ Sleep operation

The radio, compact disc, iPod, USB, Audio In can all be turned off automatically.

- 1 Play back the desired sound source.
- 2 Press the SLEEP button.
- 3 Within 5 seconds, press the Numeric buttons to set the time. (1 minute ~ 99 minutes)
- 4 "SLEEP" will appear.
- 5 The unit will enter the power stand-by mode automatically after the preset time has elapsed. The volume will be turned down 1 minute before the sleep operation finishes.

To confirm the remaining sleep time:

While "SLEEP" is indicated, press the SLEEP button.

To cancel the sleep operation:

Press the ON/STAND-BY button while "SLEEP" is indicated. To cancel the sleep operation without setting the unit to the stand-by mode, proceed as follows.

- 1 While "SLEEP" is indicated, press the SLEEP button.
- 2 Within 5 seconds, press the "0" button twice until "SLEEP 00" appears.

■ To use timer and sleep operation together

Sleep and timer playback:

For example, you can fall asleep listening to the radio and wake up to CD in the next morning.

- 1 Set the sleep time (see above, steps 1 - 5).
- 2 While the sleep timer is set, set the timer playback (steps 2 - 9, page 21).

Sleep timer setting Timer playback setting End time

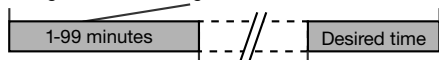

Sleep operation will automatically stop Timer playback start time

Enhancing your system

The connection lead is not included. Purchase a commercially available lead as shown below.

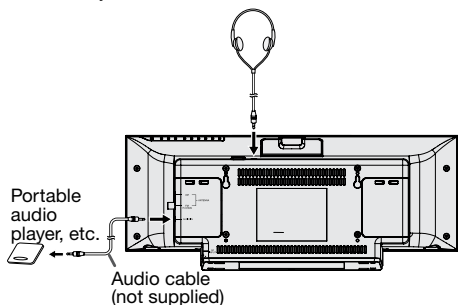

■ Listening to the playback sounds of portable audio player, etc.

- 1 Use a connection lead to connect the portable audio player etc. to the AUDIO IN socket. When using video equipment, connect the audio output to this unit and the video output to a television.

Enhancing your system (continued)

- 2 Press the ON/STAND-BY button to turn the power on.
- 3 Press the AUDIO IN button on the remote control or FUNCTION button repeatedly on main unit to select AUDIO IN function.
- 4 Play the connected equipment. If volume level of the connected device is too high, sound distortion may occur. Should this happen, lower the volume of the connected device. If volume level is too low, increase the volume of the connected device.

Note:

To prevent noise interference, place the unit away from the television.

■ Headphones

- Do not turn the volume on to full at switch on and listen to music at moderate levels. Excessive sound pressure from earphones and headphones can cause hearing loss.
- Be sure your headphone has a 3.5 mm (1/8") diameter plug and impedance between 16 and 50 ohms. The recommended impedance is 32 ohms.
- Before plugging in or unplugging the headphone, reduce the volume.
- Plugging in the headphone disconnects the speakers automatically. Adjust the volume using the VOLUME (+ or -) on the main unit or VOL +/- on the remote control.

Troubleshooting chart

Many potential problems can be resolved by the owner without calling a service technician.

If something is wrong with this product, check the following before calling your authorised SHARP dealer or service centre.

■ General

Symptom	Possible cause
● The clock is not set to the correct time.	● Did a power failure occur? ● Reset the clock. (Refer page 7)
● When a button is pressed, the unit does not respond.	● Set the unit to the power stand-by mode and then turn it back on. ● If the unit still malfunctions, reset it. (Refer page 23)
● No sound is heard.	● Is the volume level set to "Min"? ● Are the headphones connected? ● Is the unit too far from the Bluetooth stereo audio source device? ● Is the unit paired with the Bluetooth stereo audio source device?
● Bluetooth sound is interrupted or distorted.	● Is the unit too near to a device that generates electromagnetic radiation? ● Is there any obstacle between the unit and the Bluetooth stereo audio source device?

Troubleshooting chart (continued)

■ CD player

Symptom	Possible cause
<ul style="list-style-type: none"> ● Playback does not start. ● Playback stops in the middle or is not performed properly. 	<ul style="list-style-type: none"> ● Is the disc loaded face down? ● Does the disc satisfy the standards? ● Is the disc distorted or scratched?
<ul style="list-style-type: none"> ● Playback sounds are skipped, or stopped in the middle of a track. 	<ul style="list-style-type: none"> ● Is the unit located near excessive vibrations? ● Is the disc very dirty? ● Has condensation formed inside the unit?

■ Remote control

Symptom	Possible cause
<ul style="list-style-type: none"> ● The remote control does not operate. 	<ul style="list-style-type: none"> ● Is the AC power lead of the unit plugged in? ● Is the battery polarity correct? ● Is the battery dead? ● Is the distance or angle incorrect? ● Does the remote control sensor receive strong light?

■ Tuner

Symptom	Possible cause
<ul style="list-style-type: none"> ● The radio makes unusual noises continuously. 	<ul style="list-style-type: none"> ● Is the unit placed near the TV or computer? ● Is the FM aerial or AM loop aerial placed properly? Move the aerial away from the AC power lead if it is located nearby.

■ iPod, iPhone or iPad

Symptom	Possible cause
<ul style="list-style-type: none"> ● No sound is produced. 	<ul style="list-style-type: none"> ● The iPod, iPhone or iPad is not playing. ● The iPod, iPhone or iPad is not properly connected to the unit. ● Is the AC power lead of the unit plugged in?
<ul style="list-style-type: none"> ● iPod, iPhone or iPad will not charge. 	<ul style="list-style-type: none"> ● The iPod, iPhone or iPad is not making full contact with the connector. ● Using iPod (3rd generation). ● The iPod or iPhone is not supported. Refer to page 10 for compatible models.
<ul style="list-style-type: none"> ● "This accessory is not made to work with iPhone" or "This accessory is not supported by iPhone" appears on iPhone screen. 	<ul style="list-style-type: none"> ● The iPhone battery is low. Please charge the iPhone. ● iPhone is not properly docked.

■ USB

Symptom	Possible cause
<ul style="list-style-type: none"> ● Device cannot be detected. 	<ul style="list-style-type: none"> ● Is there any MP3/WMA file available? ● Is the device properly connected? ● Is it an MTP device? ● Does the device contain AAC file only?
<ul style="list-style-type: none"> ● Playback does not start. 	<ul style="list-style-type: none"> ● Is it a copyright protected WMA file? ● Is it a false MP3 file?
<ul style="list-style-type: none"> ● Wrong time display. ● Wrong file name display. 	<ul style="list-style-type: none"> ● Is Variable Bitrate file being played back? ● Is the File Name written in Chinese or Japanese characters?

■ Condensation

Sudden temperature changes, storage or operation in an extremely humid environment may cause condensation inside the cabinet (CD pickup, etc.) or on the transmitter on the remote control. Condensation can cause the unit to malfunction. If this happens, leave the power on with no disc in the unit until normal playback is possible (about 1 hour). Wipe off any condensation on the transmitter with a soft cloth before operating the unit.

■ If problem occurs

When this product is subjected to strong external interference (mechanical shock, excessive static electricity, abnormal supply voltage due to lightning, etc.) or if it is operated incorrectly, it may malfunction.

If such a problem occurs, do the following:

- 1 Set the unit to the stand-by mode and turn the power on again.
- 2 If the unit is not restored in the previous operation, unplug and plug in the unit again, and then turn the power on.

Note:

If neither operation above restores the unit, clear all the memory by resetting it.

■ Factory reset, clearing all memory

- 1 Press the ON/STAND-BY button to turn the power on.
- 2 Press FUNCTION button (main unit) repeatedly or AUDIO IN button (remote control) to enter Audio In mode.
- 3 Press ◀◀ button (main unit) once.
- 4 Press and hold ■ button (main unit) until "RESET" appears.



Caution:

This operation will erase all data stored in memory including clock, timer settings and tuner preset.

■ Before transporting the unit

Remove the iPod, iPhone, iPad, USB memory device and disc from the unit. Then, set the unit to the power stand-by mode. Carrying the unit with iPod, iPhone, iPad or USB memory device left connected or discs left inside might damage the unit.

Troubleshooting chart (continued)

Care of compact discs

Compact discs are fairly resistant to damage, however mistracking can occur due to an accumulation of dirt on the disc surface. Follow the guidelines below for maximum enjoyment from your CD collection and player.

- Do not write on either side of the disc, particularly the non-label side from which signals are read. Do not mark this surface.
- Keep your discs away from direct sunlight, heat, and excessive moisture.
- Always hold the CDs by the edges. Fingerprints, dirt, or water on the CDs can cause noise or mistracking. If a CD is dirty or does not play properly, clean it with a soft, dry cloth, wiping straight out from the centre, along the radius.

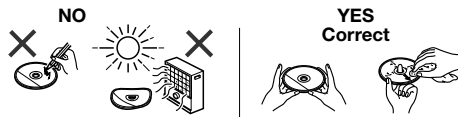

Maintenance

Cleaning the cabinet

Periodically wipe the cabinet with a soft cloth and a diluted soap solution, then with a dry cloth.

Caution:

- Do not use chemicals for cleaning (petrol, paint thinner, etc.). It may damage the cabinet.
- Do not apply oil to the inside of the unit. It may cause malfunctions.

Specifications

As part of our policy of continuous improvement, SHARP reserves the right to make design and specification changes for product improvement without prior notice. The performance specification figures indicated are nominal values of production units. There may be some deviations from these values in individual units.

General

Power source	AC 220 - 240 V ~ 50/60 Hz
Power consumption	Power on: 24 W Power stand-by: 0.4 W (*)
Speaker	1-way speaker system Speaker: 10 cm (4") - 6 ohms - Full Range
Speaker maximum input power	50 W/channel
Speaker rated input power	25 W/channel
Frequency band	2.400GHz - 2.480GHz
Compatible Bluetooth Profile	A2DP (Advanced Audio Distribution Profile), AVRCP (Audio/Video Remote Control Profile) Bluetooth 2.1 +EDR

Specifications (continued)

Dimensions	Width: 475 mm (18 - 11/16") Height: 191 mm (7 - 1/2") Depth: 83 mm (3 - 1/4")
Weight	2.45 kg (5.4 lbs.)

(*) This power consumption value is obtained when the demonstration mode is cancelled in the power stand-by mode. Refer to page 5 to cancel the demonstration mode.

Amplifier

Output power	PMPO: 100 W MPO: 50 W (25 W + 25 W) (10% T.H.D.) RMS: 50 W (25 W + 25 W) (10% T.H.D.) RMS: 40 W (20 W + 20 W) (1% T.H.D.)
Output terminals	Headphones: 16 ohms (recommended: 32 ohms)
Input terminals	Audio In (audio signal): 500 mV/47 k ohms

CD player

Type	Single disc multi-play compact disc player
Signal readout	Non-contact, 3-beam semiconductor laser pickup
D/A converter	Multi bit D/A converter
Frequency response	20 - 20,000 Hz
Dynamic range	90 dB (1 kHz)

USB (MP3 / WMA)

USB host interface	Complies with USB 1.1 (Full Speed)/2.0 Mass Storage Class. Support Bulk only and CBI protocol.
Support file	MPEG 1 Layer 3 WMA (Non DRM)
Bitrate support	MP3 (32 ~ 320 kbps) WMA (64 ~ 160 kbps)
Other	Maximum total number of MP3/WMA files is 65025. Maximum total number of folders is 999 INCLUSIVE of root directory. The ID3TAG information supported are TITLE, ARTIST and ALBUM only. Supports ID3TAG version 1 and version 2.
File system support	Support USB devices with Microsoft Windows/DOS/FAT 12/FAT 16/ FAT 32. 2 kbyte block length for sector.

Tuner

Frequency range	FM: 87.5 - 108 MHz AM: 522 - 1,620 kHz
Preset	40 (FM and AM station)

SHARP®

SHARP CORPORATION



TINSZB531AWZZ

13E R MW ①

Free Manuals Download Website

<http://myh66.com>

<http://usermanuals.us>

<http://www.somanuals.com>

<http://www.4manuals.cc>

<http://www.manual-lib.com>

<http://www.404manual.com>

<http://www.luxmanual.com>

<http://aubethermostatmanual.com>

Golf course search by state

<http://golfingnear.com>

Email search by domain

<http://emailbydomain.com>

Auto manuals search

<http://auto.somanuals.com>

TV manuals search

<http://tv.somanuals.com>