

# SHARP

Important

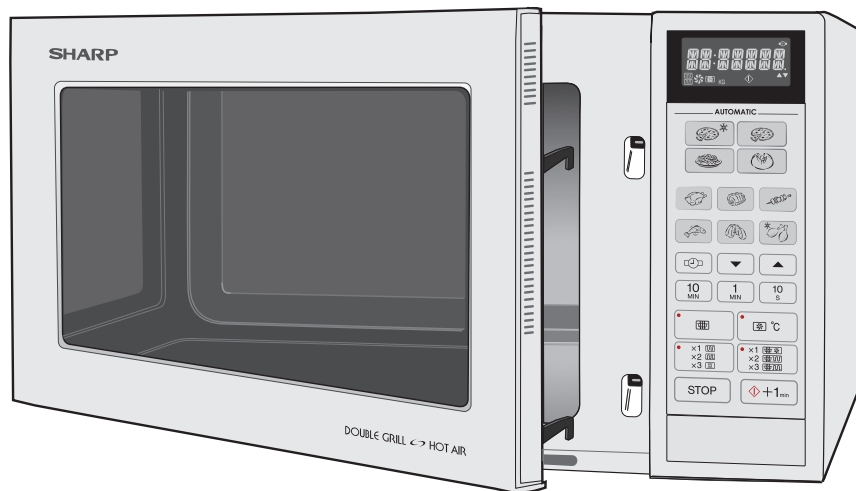

## R-85ST-A MICROWAVE OVEN WITH TOP & BOTTOM GRILLS AND CONVECTION

### OPERATION MANUAL WITH COOKBOOK

#### OPERATION MANUAL

This operation manual contains important information which you should read carefully before using your microwave oven.

**IMPORTANT:** There may be a serious risk to health if this operation manual is not followed or if the oven is modified so that it operates with the door open.

## 900 W (IEC 60705)

ENGLISH

**GB Dear Customer,**

Congratulations on acquiring your new combination microwave oven with top & bottom grill and convection, which from now on will make your kitchen chores considerably easier. You will be pleasantly surprised by the kinds of things you can do with your combined microwave oven. Not only can you use it for rapid defrosting or heating up of food, you can also prepare whole meals. The combination of microwave, convection and double grill means that food can cook and brown at the same time, and much faster, than by using the conventional method.

In our test kitchen our microwave team has gathered together a selection of the most delicious international recipes which are quick and simple to prepare.

Be inspired by the recipes we have included and prepare your own favourite dishes in your microwave oven.

There are so many advantages to having a microwave oven which we are sure you will find exciting:

- Food can be prepared directly in the serving dishes, leaving less to wash up.
- Shorter cooking times and the use of little water and fat ensure that many vitamins, minerals and characteristic flavours are preserved.

We advise you to read the cookery book guide and operating instructions carefully.

You will then easily understand how to use your oven.

**Enjoy using your combined microwave oven and trying out the delicious recipes.**

**Your Microwave-Team**

GB

**Attention:**

Your product is marked with this symbol. It means that used electrical and electronic products should not be mixed with general household waste. There is a separate collection system for these products.

## A. Information on Disposal for Users (private households)

### 1. In the European Union

Attention: If you want to dispose of this equipment, please do not use the ordinary dust bin!

Used electrical and electronic equipment must be treated separately and in accordance with legislation that requires proper treatment, recovery and recycling of used electrical and electronic equipment.

Following the implementation by member states private households within the EU states may return their used electrical and electronic equipment to designated collection facilities free of charge\*.

In some countries\* your local retailer may also take back your old product free of charge if you purchase a similar new one.

\*) Please contact your local authority for further details.

If your used electrical or electronic equipment has batteries or accumulators, please dispose of these separately beforehand according to local requirements.

By disposing of this product correctly you will help ensure that the waste undergoes the necessary treatment, recovery and recycling and thus prevent potential negative effects on the environment and human health which could otherwise arise due to inappropriate waste handling.

### 2. In other Countries outside the EU

If you wish to discard this product, please contact your local authorities and ask for the correct method of disposal.

For Switzerland: Used electrical or electronic equipment can be returned free of charge to the dealer, even if you don't purchase a new product. Further collection facilities are listed on the homepage of [www.swico.ch](http://www.swico.ch) or [www.sens.ch](http://www.sens.ch).

## B. Information on Disposal for Business Users

### 1. In the European Union

If the product is used for business purposes and you want to discard it:

Please contact your SHARP dealer who will inform you about the take-back of the product. You might be charged for the costs arising from take-back and recycling. Small products (and small amounts) might be taken back by your local collection facilities.

For Spain: Please contact the established collection system or your local authority for take-back of your used products.

### 2. In other Countries outside the EU

If you wish to discard of this product, please contact your local authorities and ask for the correct method of disposal.



## CONTENTS

### Operation manual

DEAR CUSTOMER .....	1
INFORMATION ON PROPER DISPOSAL .....	2
OVEN AND ACCESSORIES .....	4
CONTROL PANEL .....	5
IMPORTANT SAFETY INSTRUCTIONS .....	GB-1-3
INSTALLATION .....	GB-3
BEFORE OPERATION .....	GB-4
USING THE STOP KEY .....	GB-4
ENERGY SAVE MODE .....	GB-4
SETTING THE CLOCK .....	GB-5
MICROWAVE POWER LEVELS .....	GB-5
MICROWAVE COOKING .....	GB-6
HEATING WITHOUT FOOD .....	GB-6
GRILL COOKING .....	GB-7
CONVECTION COOKING .....	GB-8-9
DUAL COOKING .....	GB-10-11
OTHER CONVENIENT FUNCTIONS .....	GB-12-14
AUTOMATIC OPERATION .....	GB-15
AUTOMATIC COOKING CHART .....	GB-16-17
AUTOMATIC DEFROST CHART .....	GB-18
CARE AND CLEANING .....	GB-19
SERVICE CALL CHECK .....	GB-20

### Cookbook

WHAT ARE MICROWAVES? .....	GB-21
THIS IS WHAT YOUR NEW COMBINATION MICROWAVE OVEN CAN DO .....	GB-21
SUITABLE OVENWARE .....	GB-22-23
TIPS AND ADVICE .....	GB-23-25
HEATING .....	GB-26
DEFROSTING .....	GB-26
DEFROSTING AND COOKING .....	GB-27
COOKING MEAT, FISH AND POULTRY .....	GB-27
COOKING FRESH VEGETABLES .....	GB-27
SYMBOL EXPLANATION .....	GB-28
COOKING CHARTS .....	GB-29-31
RECIPES .....	GB-32-53
SERVICE ADDRESSES .....	6-12
SPECIFICATIONS .....	13

## OVEN AND ACCESSORIES

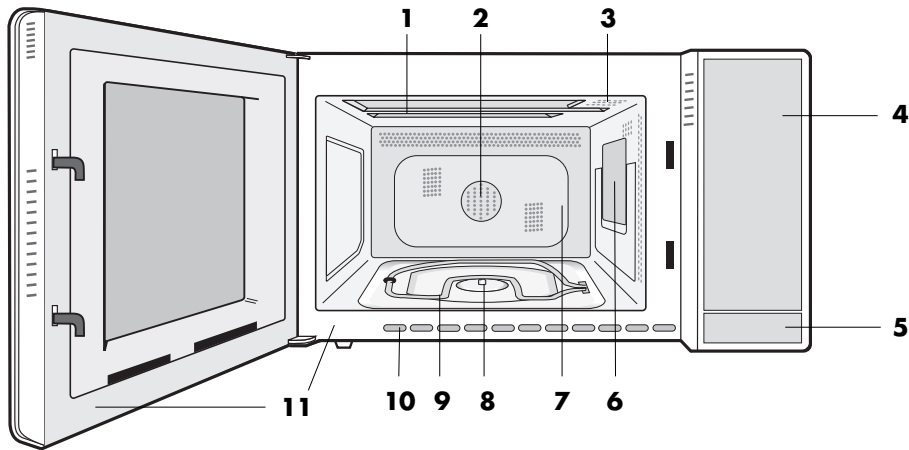

- 1 Grill heating element (top grill)
- 2 Convection Fan
- 3 Oven lamp
- 4 Control panel
- 5 Door open button
- 6 Waveguide cover
- 7 Oven cavity
- 8 Turntable motor shaft
- 9 Grill heating element (bottom grill)
- 10 Ventilation openings
- 11 Door seals and sealing surfaces
- 12 Power cord
- 13 Outer cabinet

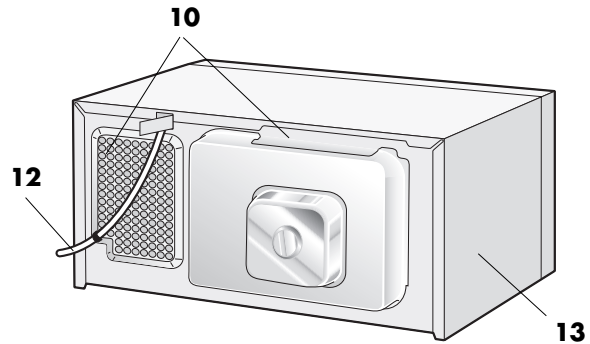

### ACCESSORIES:

Check to make sure the following accessories are provided:

- 14 Turntable
- 15 Low rack (height: 2,5 cm)
- 16 High rack (height: 10,5 cm)

Place the turntable over the turntable shaft in the floor of the cavity.

Before first using the turntable and racks, clean with mild soapy water.

Do not cut or scratch the turntable.

#### Warning:

The accessories (e.g. turntable) will become very hot during **GRILL, DUAL, CONVECTION** and **AUTOMATIC** (except Defrost) modes. Always use thick oven gloves when removing the food or turntable from the oven to prevent burns.

**NOTE:** When you order accessories, please mention the following two items: Part name and model name to your dealer or SHARP authorised service agent.

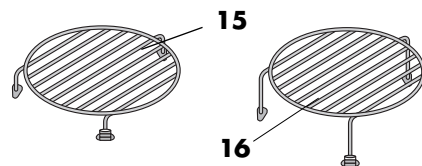
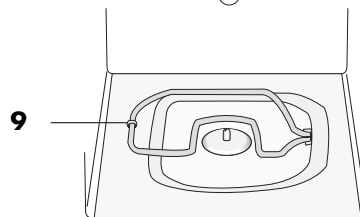
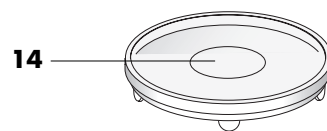

# CONTROL PANEL

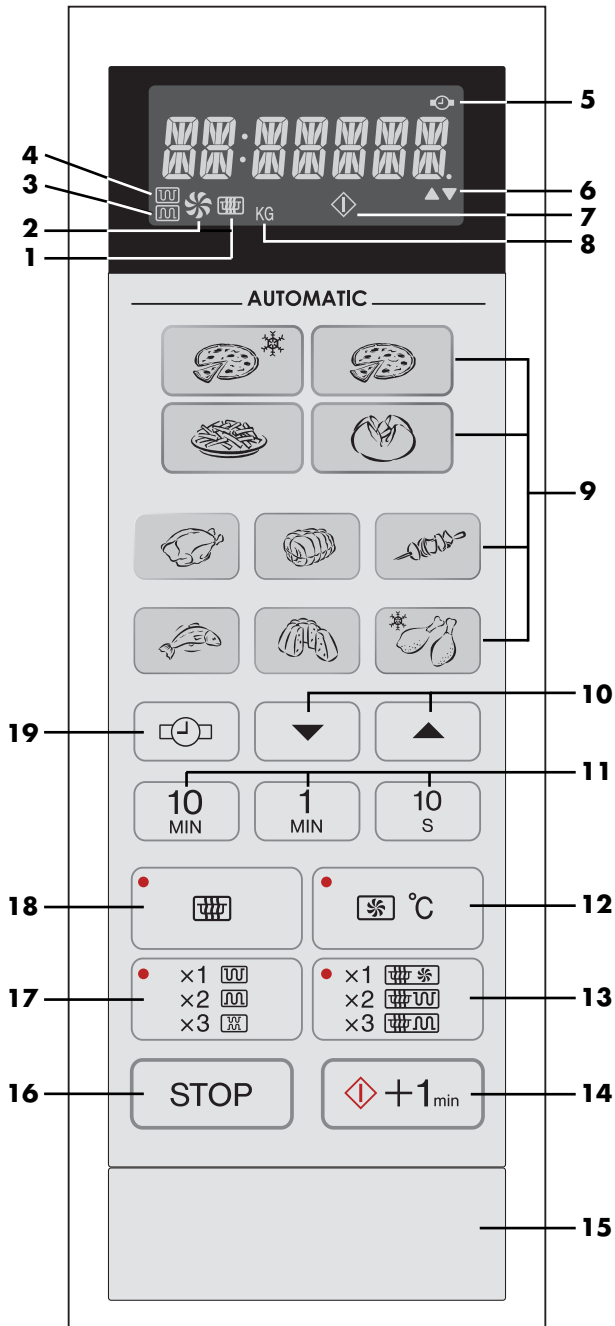

**Digital display and indicators:**

- 1. **MICROWAVE** indicator
- 2. **CONVECTION** indicator
- 3. **BOTTOM GRILL** indicator
- 4. **TOP GRILL** indicator
- 5. **CLOCK SET** indicator
- 6. **LESS/MORE** indicators
- 7. **COOKING IN PROGRESS** indicator
- 8. **WEIGHT (kg)** indicator

**Operating keys:**

- 9. **AUTOMATIC** keys
- 10. **LESS/MORE** keys
- 11. **TIME** keys
- 12. **CONVECTION** key  
Press to change the convection setting
- 13. **DUAL MODE** key:  
1 PRESS = MICROWAVE & CONVECTION  
2 PRESSES = MICROWAVE & TOP GRILL  
3 PRESSES = MICROWAVE & BOTTOM GRILL
- 14. **START/+ 1 min** key
- 15. **DOOR OPEN** button
- 16. **STOP** key
- 17. **GRILL MODE** key:  
1 PRESS = TOP GRILL  
2 PRESSES = BOTTOM GRILL  
3 PRESSES = TOP & BOTTOM GRILL
- 18. **MICROWAVE POWER LEVEL** key  
Press to change the microwave power setting
- 19. **CLOCK SETTING** key

## IMPORTANT SAFETY INSTRUCTIONS



### IMPORTANT SAFETY INSTRUCTIONS: READ CAREFULLY AND KEEP FOR FUTURE REFERENCE

#### To avoid the danger of fire.

**The microwave oven should not be left unattended during operation. Power levels that are too high, or cooking times that are too long, may overheat foods resulting in a fire.**

This oven is designed for counter top or built-in use. Do not place the oven in a cabinet. When the oven is to be built-in, the installation frame EBR-47ST licensed by SHARP must be used. This is available from your dealer. Refer to the frame installation instructions or ask your dealer for the proper instruction procedure. Only the use of this frame will guarantee the safety and quality of the product.

The electrical outlet must be readily accessible so that the unit can be unplugged easily in an emergency.

The AC power supply must be 230V, 50Hz, with a minimum 16A distribution line fuse, or a minimum 16A distribution circuit breaker.

A separate circuit serving only this appliance should be provided.

Do not place the oven in areas where heat is generated. For example, close to a conventional oven. Do not install the oven in an area of high humidity or where moisture may collect.

Do not store or use the oven outdoors.

**If smoke is observed, switch off or unplug the oven and keep the door closed in order to stifle any flames.**

**Utensils should be checked to ensure that they are suitable for use in the oven. See Page GB-27-28. Use only microwave safe containers and utensils on microwave modes.**

**When heating food in plastic or paper containers, keep an eye on the oven due to the possibility of ignition.**

**Clean the waveguide cover, the oven cavity and the turntable after use. These must be dry and free from grease. Built-up grease may overheat and begin to smoke or catch fire.**

Do not place flammable materials near the oven or ventilation openings.

Do not block the ventilation openings.

Remove all metallic seals, wire twists, etc., from food and food packages. Arcing on metallic surfaces may cause a fire.

Do not use the microwave oven to heat oil for deep frying. The temperature cannot be controlled and the oil may catch fire.

To make popcorn, use only special microwave popcorn makers.

Do not store food or any other items inside the oven.

Check the settings after you start the oven to ensure the oven is operating as desired.

To avoid overheating and fire, special care must be taken when cooking or reheating foods with a high sugar or fat content, for example, Sausage rolls, Pies or Christmas pudding.

See the corresponding hints in operation manual and the cookery book section.

#### To avoid the possibility of injury

##### WARNING:

Do not operate the oven if it is damaged or malfunctioning. Check the following before use:

- The door; make sure the door closes properly and ensure it is not misaligned or warped.
- The hinges and safety door latches; check to make sure they are not broken or loose.
- The door seals and sealing surfaces; ensure that they have not been damaged.
- Inside the oven cavity or on the door; make sure there are no dents.
- The power supply cord and plug; ensure that they are not damaged.

If the door or door seals are damaged, the oven must not be operated until it has been repaired by a competent person.

**Never adjust, repair or modify the oven yourself. It is hazardous for anyone other than a competent person to carry out any service or repair operation which involves the removal of a cover which gives protection against exposure to microwave energy.**

Do not operate the oven with the door open or alter the door safety latches in any way.

Do not operate the oven if there is an object between the door seals and sealing surfaces.

**Do not allow grease or dirt to build up on the door seals and adjacent parts. Clean the oven at regular intervals and remove any food deposits. Follow the instructions for "Care and Cleaning" on page GB-19. Failure to maintain the oven in a clean condition could lead to a deterioration of the surface that could adversely affect the life of the appliance and possibly result in a hazardous situation.**

Individuals with PACEMAKERS should check with their doctor or the manufacturer of the pacemaker for precautions regarding microwave ovens.

#### To avoid the possibility of electric shock

Under no circumstances should you remove the outer cabinet.

Never spill or insert any objects into the door lock openings or ventilation openings. In the event of a spill, turn off and unplug the oven immediately, and call an authorised SHARP service agent.

Do not immerse the power supply cord or plug in water or any other liquid.

Do not let the power supply cord hang over the edge of a table or work surface.

ENGLISH

GB-1



## IMPORTANT SAFETY INSTRUCTIONS

Keep the power supply cord away from heated surfaces, including the rear of the oven.

Do not attempt to replace the oven lamp yourself or allow anyone who is not an electrician authorised by SHARP to do so. If the oven lamp fails, please consult your dealer or an authorised SHARP service agent.

If the power supply cord of this appliance is damaged, it must be replaced with a special cord. The exchange must be made by an authorised SHARP service agent.

### To avoid the possibility of explosion and sudden boiling:

**WARNING: Liquids and other foods must not be heated in sealed containers since they are liable to explode. Microwave heating of beverages can result in delayed eruptive boiling, therefore care must be taken when handling the container.**

Never use sealed containers. Remove seals and lids before use. Sealed containers can explode due to a build up of pressure even after the oven has been turned off.

Take care when microwaving liquids. Use a wide-mouthed container to allow bubbles to escape.

**Never heat liquids in narrow necked containers such as baby bottles, as this may result in the contents erupting from the container when heated and cause burns.**

To prevent sudden eruption of boiling liquid and possible scalding:

1. Do not use excessive amount of time (See page GB-30).
2. Stir liquid prior to heating/reheating.
3. It is advisable to insert a glass rod or similar utensil (not metal) into the liquid whilst reheating.
4. Let liquid stand for at least 20 seconds in the oven at the end of cooking time to prevent delayed eruptive boiling.

**Do not cook eggs in their shells, and whole hard boiled eggs should not be heated in microwave ovens since they may explode even after microwave cooking has ended. To cook or reheat eggs which have not been scrambled or mixed, pierce the yolks and the whites, or the eggs may explode. Shell and slice hard boiled eggs before reheating them in the microwave oven.**

Pierce the skin of such foods as potatoes, sausages and fruit before cooking, or they may explode.

### To avoid the possibility of burns

**WARNING: The contents of feeding bottles and baby food jars must be stirred or shaken and the temperature checked before consumption, in order to avoid burns.**

Use pot holders or oven gloves when removing food from the oven to prevent burns.

Always open containers, popcorn makers, oven cooking bags, etc., away from the face and hands to avoid steam burns and eruption of boiling.

**To avoid burns, always test food temperature and stir before serving and pay special attention to the temperature of food and drink given to babies, children or the elderly. Accessible parts may become hot during use. Young children should be kept away.**

Temperature of the container is not a true indication of the temperature of the food or drink; always check the food temperature.

Always stand back from the oven door when opening it to avoid burns from escaping steam and heat.

Slice stuffed baked foods after heating to release steam and avoid burns.

### To avoid misuse by children

**WARNING: Only allow children to use the oven without supervision when adequate instructions have been given so that the child is able to use the oven in a safe way and understands the hazards of improper use.**

**When the appliance is operated in the GRILL, CONVECTION, DUAL, and AUTOMATIC modes (except AUTOMATIC DEFROST), children should only use the oven under adult supervision due to the temperature generated.**

**This appliance is not intended for use by persons (including children) with reduced physical, sensory or mental capabilities, or lack of experience and knowledge, unless they have been given supervision or instruction concerning use of the appliance by a person responsible for their safety.**

**Children should be supervised to ensure that they do not play with the appliance.**

Do not lean or swing on the oven door. Do not play with the oven or use it as a toy.

Children should be taught all important safety instructions: use of pot holders, careful removal of food coverings; paying special attention to packaging (e.g.



## IMPORTANT SAFETY INSTRUCTIONS

self-heating materials) designed to make food crisp, as they may be extra hot.

### Other warnings

Never modify the oven in any way.

Do not move the oven while it is in operation.

This oven is for home food preparation only and may only be used for cooking food. It is not suitable for commercial or laboratory use.

### To promote trouble-free use of your oven and avoid damage.

Never operate the oven when it is empty except where recommended in the operation manual, see Page GB-6. Doing so may damage the oven.

When using a browning dish or self-heating material, always place a heat-resistant insulator such as a porcelain plate under it to prevent damage to the turntable due to heat stress. The preheating time specified in the dish's instructions must not be exceeded.

Do not use metal utensils, which reflect microwaves and may cause electrical arcing. Do not put cans in the oven.

Use only the turntable designed for this oven. Do not use the oven without the turntable.

Do not place anything on the outer cabinet during operation.

Do not use plastic containers for microwaving if the oven is still hot from using the **GRILL**, **CONVECTION**, **DUAL** and **AUTOMATIC** modes (except AUTOMATIC DEFROST) because they may melt. Plastic containers must not be used during above modes unless the container manufacturer says they are suitable.

### NOTE:

If you are unsure how to connect your oven, please consult an authorised, qualified electrician.

Neither the manufacturer nor the dealer can accept any liability for damage to the oven or personal injury resulting from failure to observe the correct electrical connection procedure.

Water vapour or drops may occasionally form on the oven walls or around the door seals and sealing surfaces. This is a normal occurrence and is not an indication of microwave leakage or a malfunction.

## INSTALLATION

1. Remove all packing materials from the inside of the oven cavity. Discard the loose polythene sheet from between the door and cavity. Remove the feature sticker, if attached, from the outside of the door.

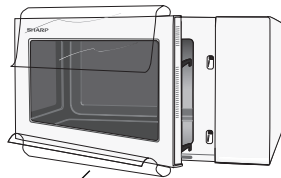

Remove this film

2. Check the oven carefully for any signs of damage.
3. Place the oven on a flat, level surface strong enough to support the oven's weight plus the heaviest item likely to be cooked.

This oven is designed to be used on a countertop or built into a kitchen cabinet. When building the oven into a kitchen cabinet, see "To avoid damage of the fire" on page GB-1.

4. The oven door may become hot during cooking. Place or mount the oven so that the bottom of the oven is 85 cm or more above the floor. Keep children away from the door to prevent them burning themselves.
5. Do not allow the power supply cord to run over any hot or sharp surfaces, such as the hot air vent area at the top rear of the oven.

6. Ensure there is a minimum of free space above the oven of 19 cm.

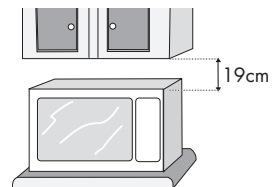

7. Securely connect the plug of the oven to a standard earthed (grounded) household electrical outlet.



## BEFORE OPERATION

Your oven has an energy save mode.

Plug in the oven. Nothing will appear on the display at this time.

1. Open the door.  
The oven display will show "ENERGY SAVE MODE".
2. Close the door.  
The display will show ".0".  
If you set the clock, "energy save mode" does not work.  
If you keep "energy save mode" go to step 4.
3. Set the clock (See page GB-5).
4. Heat the oven without food (See page GB-6).



## USING THE STOP KEY

STOP

Use the **STOP** key to:

1. Erase a mistake during programming.
2. Stop the oven temporarily during cooking.
3. Cancel a programme during cooking, press the **STOP** key twice.



## ENERGY SAVE MODE

Your oven comes set for the energy save mode. If you do nothing for 2 minutes after a preceding operation, i.e. plugging in or at the end of cooking, the power will go off automatically. To restore power on, open and then close the door. If you set the clock, energy save mode does not work.

To start energy save mode, follow the instructions below.

### Example:

To start the energy save mode, (the current time is 23:35):

1. Make sure the correct time appears on the display.
2. Press the **CLOCK SETTING** key.
3. Press the **1 MIN** key once.
4. Press **START/+1 min** key. The power will be off and the display will show nothing.



### Display:

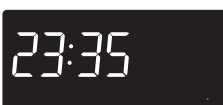

GB-4

## SETTING THE CLOCK



There are two setting modes: 12 hour clock and 24 hour clock.

1. To set the 12 hour clock, press the **CLOCK SETTING** key once, as in Step 1 opposite.
2. To set the 24 hour clock, press the **CLOCK SETTING** key twice, as in Step 2 opposite.

Step 1.



x1

Step 2.



x2

**Example:** To set the 24 hour clock to 23:35:

1. Choose the 24 hour clock by pressing the **CLOCK SETTING** key twice.
2. Set the hours:  
Press the **10 MIN** key twice.  
Press the **1 MIN** key three times.
3. Change from hours to mins by pressing the **CLOCK SETTING** key once.



x2



x2

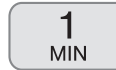

x3



x1

4. Set the minutes:  
Press **10 MIN** key three times.  
Press **1 MIN** key five times.



x3

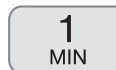

x5



x1

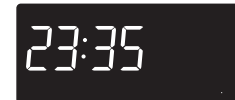

5. Start the clock.

**Check the display.**

### NOTES:

1. Press the **STOP** key if you make a mistake during programming.
2. If the oven is in cooking or minute timer mode and you wish to know the time of day, touch the **CLOCK SETTING** key. As long as your finger is touching the key, the time of day will be displayed.
3. If the electrical power supply to your microwave oven is interrupted, plug in the oven again, then open and close the door. The display will show "ENERGY SAVE MODE".
4. When you want to reset the time of day, follow the above example again.
5. If you do not set the clock, press the **STOP** key once will appear on the display. When the operation of the oven is finished, will reappear on the display instead of the time of day.
6. If you set the clock, energy save mode does not work.

If this occurs during cooking, the programme will be erased. The time of day will also be erased.

## MICROWAVE POWER LEVELS



Your oven has 5 power levels. To choose the power level, follow the advice given in the cookbook.

**900 WATT = 100 % output**

**630 WATT = 70 % output**

**450 WATT = 50 % output**

**270 WATT = 30 % output**

**90 WATT = 10 % output**

- To set the power, touch the **MICROWAVE POWER LEVEL** key until the desired level is displayed.
- If the **MICROWAVE POWER LEVEL** key is touched once, will be displayed. If you miss your desired level, continue touching the **MICROWAVE POWER LEVEL** key until you reach the level again.
- **If the level is not selected, the level 900 W (100 %) is automatically set.**

ENGLISH

GB-5



## MICROWAVE COOKING

Your oven can be programmed for up to 99.90 minutes. (99.90).

**Example:** Suppose you want to heat soup for 2 minutes and 30 seconds on 630 W microwave power.

1. Set the time:  
Press **1 MIN** key twice and the **10 SEC** key three times.
  2. Choose desired power  
630 W by pressing **MICROWAVE POWER LEVEL** key twice.
  3. Start cooking.
- Check the display**

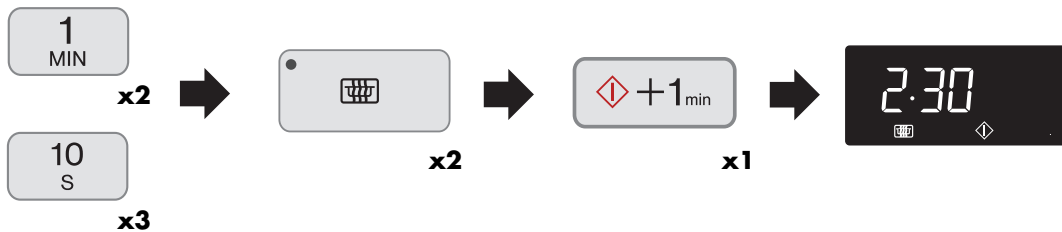

### NOTES:

1. When the door is opened during the cooking process, the cooking time on the digital display stops automatically. The cooking time starts to count down again when the door is closed and the **START/+1 min** key is pressed.
2. If you wish to know the power level during cooking, press the **MICROWAVE POWER LEVEL** key. As long as your finger is pressing the **MICROWAVE POWER LEVEL** key, the power level will be displayed.
3. When the operation of the oven is finished, the time of day will reappear, if set, on the display.

### NOTE FOR REHEATING READY MEALS:

Place the ready meal in a heat-resistant flan dish on the low rack.



## HEATING WITHOUT FOOD

You may detect smoke or a burning smell when using the grill(s), dual grill or convection for the first time. This is normal and not a sign that the oven is out of order.

To avoid this problem, when first using the oven, operate both top and bottom grills without food for 20 minutes.

**IMPORTANT:** During grill operation, to allow smoke or smells to disperse open a window or switch the kitchen ventilation on. Make sure there is no food in the oven.

1. Enter the required heating time (20 min) by pressing the **10 MIN** key twice.
  2. Press the **GRILL MODE** key three times.
  3. Start heating.
- Check the display**



The oven will count down. When the oven has finished cooking, open the door to cool the oven cavity.

### WARNING:

**The oven door, outer cabinet and oven cavity will become hot. Take care to avoid burns when cooling the oven down after operation.**

## GRILL COOKING



Your oven has 2 grill heating elements, and a combination of 3 grill cooking modes. Input the time first then select the desired grill mode by pressing the **GRILL MODE** key as indicated below.

Press <b>GRILL MODE</b> key	GRILL HEATING ELEMENT IN USE	SYMBOL
	Top Grill	
	Bottom Grill	
	Top & Bottom Grill together	

### Example:

Suppose you want to cook for 5 minutes using the TOP GRILL only.

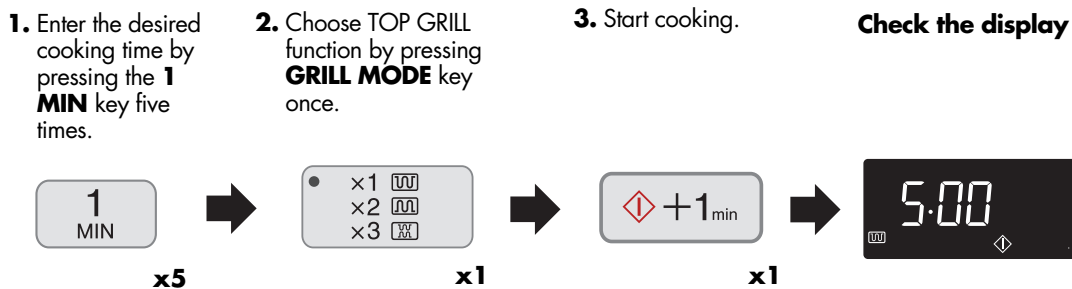

### NOTES:

- The high or low racks are recommended when grilling.
- You may detect smoke or a burning smell when using the grill for the first time, this is normal and not a sign that the oven is out of order. Please see heating without food on the previous page.
- After cooking using TOP GRILL and BOTTOM GRILL the display may show 'NOW COOLING'.

**WARNING:** The oven cavity, door, outer cabinet, turntable, racks, dishes and especially the bottom grill will become very hot, always use thick oven gloves when removing the food or turntable from the oven to prevent burns.



## CONVECTION COOKING

This microwave oven has 10 pre-set oven temperatures which use a combination of the top and bottom grills.

Press <b>CONVECTION</b> key	1	2	3	4	5	6	7	8	9	10
Oven Temperature (° C)	250	230	220	200	180	160	130	100	70	40

### Note:

Temperature measurements taken whilst the oven is in convection mode will differ from the displayed level. This is due to the grill elements turning on and off in order to regulate the oven temperature. This will not affect the cooking results as long as the operation manual and cook book are followed correctly.

### Example 1: To cook with preheating

Suppose you want to pre-heat to 180° C and cook for 20 minutes at 180° C.

- 1.** Enter the desired convection temperature by pressing the **CONVECTION** key five times. The display will show 180° C.

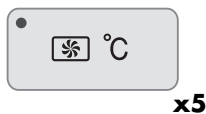

- 2.** Press the **START/+ 1 min** key to start pre-heating. The display shows "PREHEAT".



When the pre-heated temperature has been reached the audible signal sounds. The display will show "180C". Open the door and place the food inside the oven. Close the door.

- 3.** Enter the cooking time. Press the **10 MIN** key twice.



- 4.** Press the **START/+ 1 min** key.



### Check the display



### NOTES:

- After preheating, if you want to cook at a different temperature press the **CONVECTION** key until the desired setting appears on the display. In the example above, to change the temperature you would press the **CONVECTION** key after entering the cooking time.
- When the oven reaches the programmed temperature, it will automatically hold at the pre-heated temperature for 30 minutes. After 30 minutes the display will change to time of day, if set and the convection temperature will be cancelled.
- After cooking, the display may show "NOW COOLING".

**WARNING:** The oven cavity, door, outer cabinet, turntable, racks, dishes and especially the bottom grill will become very hot, always use thick oven gloves when removing the food or turntable from the oven to prevent burns.

## CONVECTION COOKING



### Example 2: To cook without preheating

Suppose you want to cook at 250° C for 20 minutes.

1. Enter the desired cooking time (20 min.) by pressing the **10 MIN** key twice.
2. Select the desired cooking temperature. (250° C).
3. Press the **START/+ 1 min** key.



#### NOTES:







1. After cooking, the oven will automatically cool and the display may show "NOW COOLING".
2. To change the convection temperature, press the **CONVECTION** key until the desired temperature appears on the display.

**WARNING:** The oven cavity, door, outer cabinet, turntable, racks, dishes and especially the bottom grill will become very hot, always use thick oven gloves when removing the food or turntable from the oven to prevent burns.

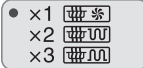

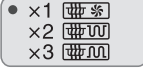
## DUAL COOKING

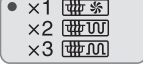
Your oven has 3 **DUAL** cooking modes combining the heat of the grill(s) with the power of the microwave. To select the **DUAL** cooking mode, press the **DUAL MODE** key until the desired setting appears in the display. Generally, dual cooking time shortens the total cooking time.

Press <b>DUAL MODE</b> key	Cooking method	Microwave Power Range	Symbol
<b>DUAL 1</b>  x1	MICRO 270 W CONV 250° C	90 W - 450 W	
<b>DUAL 2</b>  x2	MICRO 270 W TOP GRILL	90 W - 900 W	
<b>DUAL 3</b>  x3	MICRO 270 W BOTTOM GRILL	90 W - 900 W	

### NOTES:

- To adjust the microwave power, press the **MICROWAVE POWER LEVEL** key.
- To adjust the convection temperature, press the **CONVECTION** key until the desired temperature appears on the display.
- For **DUAL 1** the oven temperature can be changed from 40° C to 250° C in ten levels.

### Example 1:

Suppose you want to cook for 20 minutes using DUAL 1 (90 W microwave power and 200° C CONVECTION).

1. Enter the desired cooking time (20 min.) by pressing the **10 MIN** key twice.
2. Press the **DUAL MODE** key once.
3. Press the **MICROWAVE POWER LEVEL** key once (90 W).
4. Press **CONVECTION** key three times (200° C).

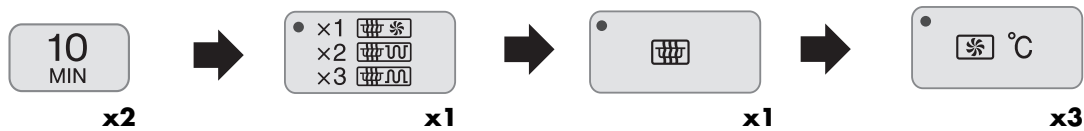

**NOTE:** After cooking, the display may show "NOW COOLING".



## DUAL COOKING



### Example 2:

Suppose you want to cook for 20 minutes on DUAL 2, using 90 W microwave power and TOP GRILL.

**1.** Enter the desired cooking time by pressing the **10 MIN** key twice.



x2

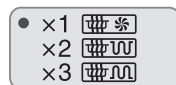

x2



x1



**4.** Start cooking.



x1



**Check the display**



**NOTE:** After cooking, the display may show "NOW COOLING".

**WARNING:** The oven cavity, door, outer cabinet, turntable, racks, dishes and especially the bottom grill will become very hot, always use thick oven gloves when removing the food or turntable from the oven to prevent burns.



## OTHER CONVENIENT FUNCTIONS

### 1. MULTIPLE SEQUENCE COOKING.

A sequence of 4 stages (maximum) can be programmed which may combine the **MICROWAVE, GRILL, DUAL** or **CONVECTION** modes.

#### EXAMPLES OF SEQUENCE COOKING:

1. Micro or Preheat + Micro + Micro + Dual or Convection or Grill or Micro
2. Micro or Preheat + Dual or Convection or Grill or Micro + Dual or Convection or Grill or Micro
3. Dual or Convection or Grill or Micro + Micro + Dual or Convection or Grill or Micro

#### Example:

**Stage 1:** 10 minutes at 450 W power

**Stage 2:** 5 minutes Dual 2 at 90 W

**Stage 3:** 20 minutes using the TOP GRILL.

#### STAGE 1

1. Enter the desired cooking time (10 minutes) by pressing the **10 MIN** key once.
2. Select 450 W microwave power by pressing the **MICROWAVE POWER LEVEL** key three times.



#### STAGE 2

3. Enter the desired cooking time (5 minutes) by pressing the **1 MIN** key five times.
4. Select DUAL MODE 2 only, by pressing the **DUAL MODE** key twice.
5. Select 90 W low power by pressing the **MICROWAVE POWER LEVEL** key once.

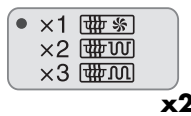

#### STAGE 3

6. Enter the desired cooking time (20 minutes) by pressing the **10 MIN** key twice.
  7. Select TOP GRILL by pressing the **GRILL MODE** key once.
  8. Start to cook by pressing the **START/+ 1 min** key.
- Check the display**

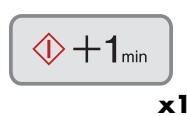
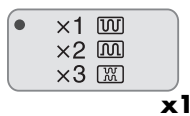

GB-12

## OTHER CONVENIENT FUNCTIONS



### 2. LESS / MORE keys.

The **LESS** (▼) and **MORE** (▲) keys allow you to easily decrease or increase programmed setting times, (for a less well or more well cooked result), used for **AUTOMATIC** operations or when cooking is underway.

#### a) Changing the pre-programmed time setting.

##### Example:

Suppose you want to cook 0,9 kg Roast chicken using the **AUTOMATIC** and **MORE** (▲) keys.

1. Choose the **AUTOMATIC** menu for Roast chicken by pressing the **AUTOMATIC** key once.



x1



2. Choose the desired result (well cooked) by pressing the **MORE** key once within 2 seconds.



x1



3. The oven will start to cook automatically.



##### NOTES:

To cancel **LESS** or **MORE** press the same key again.

To change **MORE** to **LESS** simply press the **LESS** (▼) key.

To change **LESS** to **MORE** simply press the **MORE** (▲) key.

#### b) Changing the heating time while the oven is operating:-

The cooking time can be decreased or increased in 1 minute steps each time the **LESS** (▼) and **MORE** (▲) keys are pressed.

### 3. +1 min function

The **+1 min** function allows you to operate the following functions:

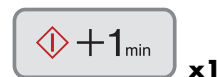

#### a) Direct Start

You can start to cook directly on full microwave power (900 W) and in 1 minute steps by pressing the **START/+1 min** key.

**NOTE:** To avoid children's misuse, the **START/+1 min** key can be used only within 2 minutes after a preceding operation, i.e., closing the door or pressing the **STOP** key.

#### b) Extending the cooking time.

You can extend the cooking time in multiples of 1 minute, by pressing the **START/+1 min** key, during the cooking process.



## OTHER CONVENIENT FUNCTIONS

### 4. TO CHECK SETTINGS WHILE THE OVEN IS OPERATING

You can check the power level, oven temperature, the programmed and actual oven temperatures ie: when pre-heating.

#### TO CHECK THE POWER LEVEL:

To check the microwave power level during cooking press the **MICROWAVE POWER LEVEL** key. The oven continues to count down, although the display shows the power level.

As long as your finger is pressing the key, the power level will be displayed.



#### TO CHECK THE CONVECTION TEMPERATURE:

To check the convection temperature during cooking press the **CONVECTION** key. When the oven is preheating, you can check the actual oven temperature.

As long as your finger is pressing the key, the convection temperature in °C will be displayed.

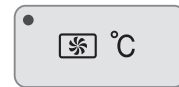

#### TO CHECK THE TIME OF DAY:

Firstly, the clock must already be set, see page GB-5. To check the time of day during cooking, press the **CLOCK SETTING** key.

As long as your finger is pressing the key, the time of day will be displayed.



## AUTOMATIC OPERATION



The **AUTOMATIC** keys automatically work out the correct cooking mode and cooking time of the foods illustrated below.

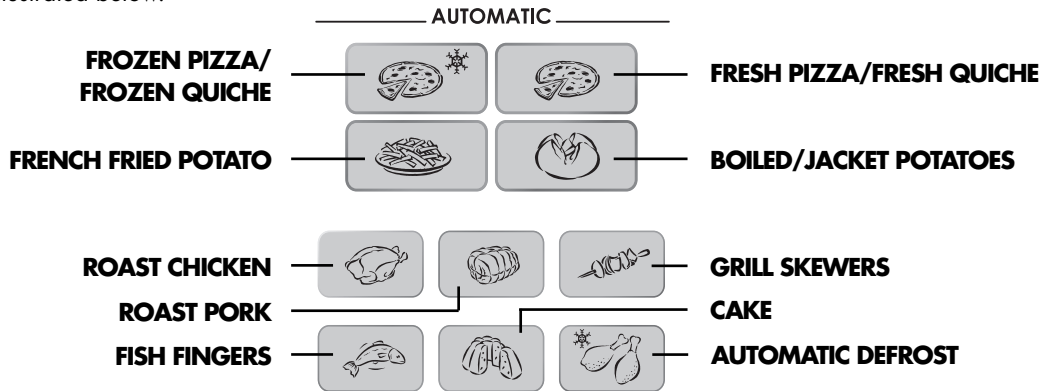

What you need to know when using the **AUTOMATIC** keys:

1. Input the menu by pressing the desired key. The **AUTOMATIC** keys can only be input within 2 minutes after cooking completion, closing the door or pressing the **STOP** key.
2. To increase the weight press the selected key until the desired weight is displayed. Enter the weight of the food only. Do not include the weight of the container.  
For food weighing more or less than the weights/quantities given in the cooking charts (see cookery book section) cook using manual operation.
3. The programmed cooking times are average times. If you want to alter the cooking times of **AUTOMATIC** programmes, use the **LESS (▼)** or **MORE (▲)** keys.  
For best results use the cooking chart instructions (see cookery book section).
4. The oven will start to cook instantly after the weight has been input.

**WARNING:** The oven cavity, door, outer cabinet, turntable, racks, dishes and especially the bottom grill will become very hot, always use thick oven gloves when removing the food or turntable from the oven to prevent burns.

### NOTE:

When manipulation is required (eg: to turn food over) the oven will stop and the audible signal will sound, the display will show the necessary action. To continue cooking, press the **START/+1 min** key. The final temperature of the food will vary according to its initial temperature. Check food is piping hot after cooking. If necessary, you can extend the cooking time. Always refer to the cooking charts given in the cookery book section.

**Example:** Suppose you want to cook 200 g of French Fried Potatoes.

Choose the menu and quantity by pressing the **FRENCH FRIED POTATO** key once.

The oven will instantly begin to cook.







GB-15

ENGLISH







## AUTOMATIC COOKING CHART

KEY	MENU	WEIGHT (Increasing Unit) / UTENSILS	PROCEDURE
	Frozen Pizza "Stone oven" Pizza (thin base, pre-baked)/ Frozen Quiche	0,15 - 0,60 kg (50 g) for Pizza 0,15 - 0,40 kg (50 g) for Quiche (Initial temp. -18° C) Directly on the turntable	<ul style="list-style-type: none"> <li>Remove the ready prepared frozen pizza/quiche from the packaging.</li> <li>Place directly on the turntable. For thick base pizzas and ready prepared frozen quiches, press the <b>MORE (▲)</b> key before pressing the <b>FROZEN PIZZA/FROZEN QUICHE</b> key.</li> <li>After cooking, place on a plate for serving. For thick base pizza and quiche, let stand for 2 minutes.</li> </ul>
	Fresh Pizza/ Fresh Quiche	0,7 - 1,0 kg (100 g) for Pizza 0,7 kg for Quiche (Initial temp. 20° C) Directly on the turntable	<ul style="list-style-type: none"> <li>Prepare the pizza/quiche following the recipes on page GB-17.</li> <li>Place directly on the turntable. For quiche, press the <b>MORE (▲)</b> key before pressing the <b>FRESH PIZZA/FRESH QUICHE</b> key.</li> <li>After cooking, place on a plate for serving.</li> </ul>
	French fried Potatoes (recommended for conventional ovens) e.g. French fried potatoes, potato croquettes	0,20 - 0,40 kg (50 g) (Initial temp. -18° C) Directly on the turntable	<ul style="list-style-type: none"> <li>Remove the frozen, French-fried potatoes from the package and place them in one layer on the turntable.</li> <li>For thick French fried potatoes, use the <b>MORE (▲)</b> key, for potato croquettes use the <b>LESS (▼)</b> key.</li> <li>After cooking, remove from the turntable and put on a plate for serving.</li> </ul>
	Boiled potatoes/ Jacket potatoes	0,1 - 0,8 kg (100 g) (Initial temp. 20° C) Bowl & lid	<p>Boiled Potatoes: Peel the potatoes and cut them into similar sized pieces. Jacket Potatoes: Choose potatoes of similar size and wash them.</p> <ul style="list-style-type: none"> <li>Put the boiled or jacket potatoes into a bowl.</li> <li>Add the required amount of water (per 100g approx 2 tbsp) and a little salt.</li> <li>Cover with a lid.</li> <li>When the audible signals sound, stir and re-cover.</li> <li>After cooking, let the potatoes stand covered for 1-2 minutes.</li> </ul>
	Roast Chicken  Ingredients for 1,2 kg roast chicken: Salt and Pepper, 1 tsp sweet paprika, 2 tbsp oil	0,9 - 1,8 kg (100 g) (Initial temp. 5° C) Low rack	<ul style="list-style-type: none"> <li>Mix the ingredients and spread on the chicken.</li> <li>Pierce the skin of the chicken.</li> <li>Put chicken breast side down on the low rack.</li> <li>When the audible signals sound, turn the chicken over.</li> <li>After cooking, leave for approx. 3 minutes in the oven, remove and put on a plate for serving.</li> </ul>

## AUTOMATIC COOKING CHART



KEY	MENU	WEIGHT (Increasing Unit) / UTENSILS	PROCEDURE
	Roast Pork  Ingredients for 1,0 kg rolled lean pork: 1 garlic clove crushed, 2 tbsp oil, 1 tsp sweet paprika, a little cumin powder, 1 tsp salt	0,6 - 2,0 kg (100 g) (Initial temp. 5° C) Low rack	<ul style="list-style-type: none"> <li>Lean roast pork is recommended.</li> <li>Mix all ingredients and spread them onto the pork.</li> <li>Place the pork on the low rack.</li> <li>When the audible signals sound, turn over.</li> <li>After cooking, let the food stand wrapped in aluminium foil for approx. 10 minutes.</li> </ul>
	Grill skewers  See recipe on page GB-37	0,2 - 0,8 kg (100 g) (Initial temp. 5° C) High rack	<ul style="list-style-type: none"> <li>Prepare the grill skewers.</li> <li>Place on the high rack and cook.</li> <li>When the audible signals sound, turn over.</li> <li>After cooking, remove and put on a plate for serving. (No standing time necessary).</li> </ul>
	Fish Fingers, Poultry meat pieces (e.g. chicken nuggets)	0,2 - 0,5 kg (100 g) (Initial temp. -18° C) Directly on the turntable	<ul style="list-style-type: none"> <li>Grease the turntable lightly.</li> <li>Remove deep frozen fish fingers/chicken nuggets from the packaging and place them on the turntable.</li> <li>After cooking, place on a plate for serving. (No standing time is necessary).</li> </ul>
	Cake  See recipes on pages GB-47-49	0,5 - 1,5 kg (100 g) (Initial temp. 20° C) Cake dish	<ul style="list-style-type: none"> <li>Prepare the cake.</li> <li>Place the cake dish directly on the turntable.</li> <li>Let the cakes stand for approximately 10 minutes after baking.</li> </ul> <p><b>HINT:</b> You can use ordinary black metal cake tins. If arcing occurs, put a saucer between the turntable and tins.</p>

### PIZZA RECIPE

Ingredients:

- 300 g approx. Ready prepared dough (Ready mix or roll out dough)
- 200 g approx. Tinned tomatoes
- 150 g Topping as desired (eg. corn, ham, salami, pineapple)
- 50 g Grated cheese
- Basil, oregano, thyme, salt, pepper

Procedure:

- Prepare the dough according to the manufacturer's instructions. Roll out to the size of the turntable.
- Lightly grease the turntable and place the pizza base on it and pierce the dough.
- Drain the tomatoes and cut them into pieces. Season the tomatoes with the spices and spread on the dough. Put all other ingredients on the pizza and finally cover with the cheese.
- Cook the pizza using the **FRESH PIZZA/FRESH QUICHE** key.

### QUICHE RECIPE

Ingredients:

- 200 g Puff pastry (frozen or chilled)
- 3 Eggs (size medium)
- 200 g Cream or milk
- 100 g Grated cheese (Emmenthal)
- 50 g Ham

Procedure:



- Defrost the pastry and roll it out to the size of the turntable. Place on the turntable and pierce the dough.
- Mix the eggs with the cream and the cheese together. Season with salt and pepper, and pour over the pastry.
- Sprinkle the ham over and cook the quiche using the **FRESH PIZZA/FRESH QUICHE** key and the **MORE (▲)** key.

GB-17

ENGLISH



## AUTOMATIC DEFROST CHART

KEY	MENU	WEIGHT (Increasing Unit) / UTENSILS	PROCEDURE
	Automatic Defrost: Poultry	0,9 - 2,0 kg (100 g) (Initial temp. -18° C) (See note below)	<ul style="list-style-type: none"> <li>Place a plate upside down on the turntable and put the poultry breast side down on the plate.</li> <li>When the oven stops and the audible signal sounds, turnover and shield the thin parts and warm spots with aluminium foil.</li> <li>After defrosting, cover with aluminium foil and stand for 30 - 90 minutes until thoroughly defrosted.</li> <li>Finally clean the poultry under running water.</li> </ul>
	Automatic Defrost: Chicken Legs	0,2 - 1,0 kg (100 g) (Initial temp. -18° C) (See note below)	<ul style="list-style-type: none"> <li>Place the food on a plate in the centre of the turntable.</li> <li>When the oven stops and the audible signals sound, turn the food over, rearrange and separate. Shield the thin parts and warm spots with aluminium foil.</li> <li>After defrosting, wrap in aluminium foil for 10 - 30 minutes, until thoroughly defrosted.</li> </ul>
	Automatic Defrost: Steaks, Chops, Fish Fillets	0,2 - 1,0 kg (100 g) (Initial temp. -18° C) (See note below)	<ul style="list-style-type: none"> <li>Place the food in a single layer on a plate in the centre of the turntable. If portions are frozen together, try to separate before defrosting.</li> <li>When the oven stops and the audible signals sound, turn the food over, rearrange and separate. Shield the thin parts and warm spots with aluminium foil.</li> <li>After defrosting, wrap in aluminium foil for 10 - 30 minutes, until thoroughly defrosted.</li> </ul>

### NOTE:

- Steaks, Chops, Fish fillets and Chicken legs should be frozen in one layer.
- For shielding the defrosted parts, use small, flat pieces of aluminium foil.
- The poultry should be cooked immediately after defrosting.
- Arrange the food in the oven as shown below:

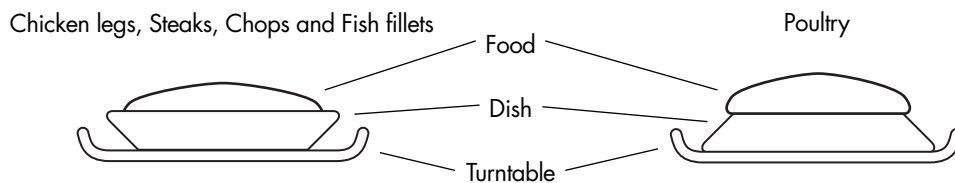

GB-18



## CARE AND CLEANING



**CAUTION: DO NOT USE COMMERCIAL OVEN CLEANERS, STEAM CLEANERS, ABRASIVE, HARSH CLEANERS, ANY THAT CONTAIN SODIUM HYDROXIDE OR SCOURING PADS ON ANY PART OF YOUR MICROWAVE OVEN.**

**Before cleaning, make sure the oven cavity, door, oven cabinet and accessories are completely cool.**

**CLEAN THE OVEN AT REGULAR INTERVALS AND REMOVE ANY FOOD DEPOSITS - Keep the oven clean, or the oven could lead to a deterioration of the surface. This could adversely affect the life of the appliance and possibly result in a hazardous situation.**

### Oven exterior

The outside of your oven can be cleaned easily with mild soap and water. Make sure the soap is wiped off with a moist cloth, and dry the exterior with a soft towel.

### Oven controls

Open the door before cleaning to de-activate the oven controls. Care should be taken when cleaning the oven control. Using a cloth dampened with water only, gently wipe the panel until it becomes clean. Avoid using excessive amounts of water. Do not use any sort of chemical or abrasive cleaner.

### Oven Interior

1. For cleaning, wipe any splatters or spills with a soft damp cloth or sponge after each use while the oven is still warm. For heavier spills, use a mild soap and wipe several times with a damp cloth until all residues are removed. Built-up splashes may overheat and begin to smoke or catch fire, and cause arcing. Do not remove the waveguide cover.

2. Make sure that mild soap or water does not penetrate the small vents in the walls which may cause damage to the oven.
3. Do not use spray type cleaners on the oven interior.
4. Heat up your oven regularly by using the convection and grill, refer to "Heating without food" on page GB-6. Remaining food or fat splashed can cause smoke or bad smell.

### Accessories

The accessories should be washed in a mild washing up liquid solution and dried. They are dishwasher safe.

### Door

To remove all trace of dirt, regularly clean both sides of the door, the door seals and adjacent parts with a soft, damp cloth. Do not use harsh abrasive cleaners or sharp metal scrapers to clean the oven door glass since they can scratch the surface, which may result in shattering of the glass.

**NOTE:** Keep the waveguide cover and accessories clean at all times. If you leave grease or fat in the cavity or accessories, it may overheat, cause arcing, smoke or even catch fire when next using the oven.



## SERVICE CALL CHECK

### PLEASE CHECK THE FOLLOWING BEFORE CALLING FOR SERVICE:









1. Power Supply:  
 Check the power plug is properly connected to a suitable wall outlet.  
 Check the line fuse/circuit breaker is functioning properly.
2. When the door is opened, does the oven lamp light? YES \_\_\_\_\_ NO \_\_\_\_\_
3. Place a cup of water (approx. 150 ml) in the oven and close the door securely.  
 Set the cooking mode to microwave cooking mode.  
 Programme the oven for one minute on full power (900 W) and start the oven.  
 Does the oven lamp light? YES \_\_\_\_\_ NO \_\_\_\_\_  
 Does the turntable rotate? YES \_\_\_\_\_ NO \_\_\_\_\_  
**NOTE:** The turntable turns in either direction.  
 Does the ventilation work? YES \_\_\_\_\_ NO \_\_\_\_\_  
 (Place your hand over the ventilation openings and check for air flow.)  
 After 1 minute does the signal sound? YES \_\_\_\_\_ NO \_\_\_\_\_  
 Does the cooking in progress indicator go off? YES \_\_\_\_\_ NO \_\_\_\_\_  
 Is the cup of water warm after the above operation? YES \_\_\_\_\_ NO \_\_\_\_\_
4. Set the GRILL cooking mode using the top grill and bottom grill for 3 minutes.  
 After 3 minutes do both GRILL heating elements become red? YES \_\_\_\_\_ NO \_\_\_\_\_
5. Set the CONVECTION cooking mode for 3 minutes on 180° C.  
 Is the inside of the oven hot after 3 minutes? YES \_\_\_\_\_ NO \_\_\_\_\_

If you answer "NO" to any of the above questions, call a Service Technician appointed by SHARP and report the results of your check. See inside back cover for details of address.

**IMPORTANT:** If the display shows nothing even if the power plug is properly connected, the energy save mode should carry on. To release it, open and then close the oven door. See page GB-4.

### NOTES:

1. If you cook the food over the standard time with only the same cooking mode, the power of the oven will lower automatically to avoid overheating. (The microwave power level will be reduced and the grill heating elements will begin to light on and off.)

Cooking mode	Standard time
Microwave 100 % cooking	20 min.
Grill cooking	
TOP GRILL 	30 min.
BOTTOM GRILL 	45 min.
TOP and BOTTOM GRILL  	Top grill - 15 min. Bottom grill - 15 min.
Dual 2  	Micro - 20 min. Top grill - 15 min.
Dual 3  	Micro - 20 min. Bottom grill - 15 min.

2. After the **GRILL, DUAL, CONVECTION** and **AUTOMATIC** (except Automatic Defrost), the cooling fan will run until the oven has cooled down. Also, when you press the **STOP** key and open the door during the **GRILL, DUAL, CONVECTION** and **AUTOMATIC** (except Automatic Defrost), the cooling fan will run; you may, therefore, feel air blowing from the ventilation openings.
3. If the display shows messages for "DEMO MODE", or the time in the display is counting down very rapidly, the oven may be set in the demo mode. To cancel the demo mode, unplug the oven from the wall outlet and replug.

## WHAT ARE MICROWAVES?



Like radio and television waves, microwaves are electromagnetic waves.

Microwaves are produced by a magnetron inside the microwave oven, and these vibrate the molecules of water present in the food. The friction this causes produces heat, which ensures that the food is defrosted, heated or cooked through.

The secret of the reduced cooking times is the fact that the microwaves penetrate the food from every direction. Energy is used to the full. In comparison, the energy from a conventional hob passes from the burner through the pan and so to the food. This method wastes a great deal of energy.

Microwaves penetrate all non-metal objects made of glass, china, earthenware, plastic, wood or paper. This is why the microwaves never make these materials hot. Dishes become hot only because the food inside them is hot.

The food absorbs the microwaves and is heated.

Microwaves cannot pass through objects made of metal and so they are deflected. For this reason metal objects are not normally suitable for microwave cookery. There are exceptions where you can actually make use of the fact that the microwaves cannot pass through metal. If you cover food with aluminium foil at specific points while it is defrosting or cooking, you can prevent those parts from getting too warm, too hot, or overcooked. Please check out the advice given in the guide.

### THE CHARACTERISTICS OF MICROWAVES

## THIS IS WHAT YOUR NEW COMBINATION MICROWAVE OVEN CAN DO



### MICROWAVE OPERATION

By using the microwave facility in your new combination microwave oven you can, for example, quickly heat up ready-prepared meals or drinks, or melt butter or chocolate in no time at all. The microwave oven is equally good at defrosting food.

Sometimes, however, it is better to combine the microwave with convection heating or grilling (combined operation). You can then cook the food rapidly and brown it at the same time. Cooking times are generally much shorter than in conventional food preparation.

### COMBINED OPERATION (MICROWAVE OPERATION WITH CONVECTION OR GRILL)

By combining two modes of operation the benefits of your oven are cleverly linked together.

You are able to choose between

- microwave + convection (ideal for joints of meat, poultry, puddings, bread and cakes) and
- microwave + grill (ideal for pizzas, snacks, quick fry-ups, joints, poultry, chicken legs, kebabs, Welsh rarebit and cooking au gratin).

Using the combination facility you can cook and brown food at the same time.

The advantage is that the convected heat or the heat from the grill quickly seals the pores in the outer layers of the food. The microwaves ensure a short and gentle cooking period. The juices are preserved inside the food and the outside is crisp.

### CONVECTION MODE

You can use the convection facility by itself without microwave operation. The results are the same as those provided by a conventional oven.

### GRILL OPERATION

Your microwave oven is fitted with a quartz grill above the cooking area. Like any conventional grill it can be used without operating the microwave. Dishes can be rapidly browned or grilled in this mode.

In addition your oven has a second grill under the turntable. This facility can be used to brown food from below.

GB-21

ENGLISH



## SUITABLE OVENWARE

### SUITABLE OVENWARE FOR MICROWAVE COOKING

#### GLASS AND CERAMIC GLASS

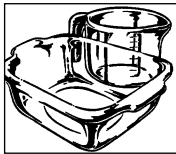

Heat-resistant glass utensils are very suitable. The cooking process can be observed from all sides. They must not, however, contain any metal (e.g. lead crystal), nor have a metallic overlay (e.g. gold edge, cobalt blue finish).

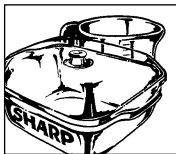

#### CERAMICS

Generally very suitable. Ceramics must be glazed, since with unglazed ceramics moisture can get into the ceramic. Moisture causes the material to heat up and may make it shatter. If you are not certain whether your utensil is suitable for the microwave, carry out the utensil suitability test. (see page GB-23).

#### PORCELAIN

Very suitable. Ensure that the porcelain does not have a gold or silver overlay and that it does not contain any metal.

#### PLASTIC AND PAPER UTENSILS

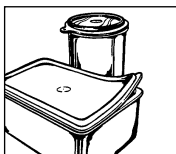

Heat resistant plastic utensils which are suitable for use in the microwave can be used to thaw, heat and cook food. Follow the manufacturer's recommendations.

Heat-resistant paper made for use in a microwave oven is also suitable.

Follow the manufacturer's recommendations.

#### KITCHEN PAPER

can be used to absorb any moisture which occurs in short heating methods, e.g. of bread or products in bread crumbs. Insert the paper between the food and the revolving plate. The surface of the food will stay crispy and dry. Covering greasy food with kitchen paper will catch splashes.

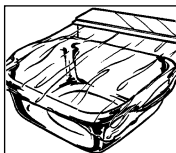

#### MICROWAVE FOIL

This, or heat-resistant foil, is very suitable for covering or wrapping. Please follow the manufacturer's recommendations.

#### ROASTING BAGS

Can be used in a microwave oven. Metal clips are not suitable for fastening them since the roasting bag foil might melt. Fasten the roasting bag with string and pierce it several times with a fork. Non heat-resistant food wraps are not recommended for use in a microwave oven.

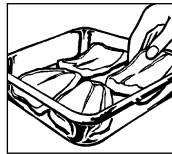

#### METAL



Generally speaking, metal should not be used, since microwaves do not pass through metal and therefore cannot reach the food.

There are, however, exceptions: small strips of aluminium foil may be used to cover certain parts of the food, so that these do not thaw too quickly or begin to cook (e.g. chicken wings). Small metal skewers and aluminium containers (e.g. of ready-cooked meals) can be used. They must, however, be small in relation to the food, e.g.



aluminium containers must be at least  $\frac{2}{3}$  to  $\frac{3}{4}$  filled with food. It is

recommended that you transfer the food into a dish suitable for use in the microwave. When using aluminium containers or other metal utensils there must be a gap of approx. 2 cms between them and the walls of the cooking area, otherwise the walls could be damaged by possible arcing.

**NO UTENSIL SHOULD HAVE A METAL OVERLAY** metal parts such as screws, bands or handles.

## SUITABLE OVENWARE



### UTENSIL SUITABILITY TEST

If you are not sure whether your utensil is suitable for use in your microwave oven, carry out the following test: Place the utensil into the oven. Place a glass container filled with 150 ml of water on or next to the utensil. Switch on the oven at 900 W power for 1 to 2 minutes. If the utensil stays cool or just warm to the touch, it is suitable. Do not use this test on a plastic utensil. It could melt.

### SUITABLE UTENSILS FOR COMBINED OPERATION

Generally heatproof microwave utensils (e.g. porcelain, ceramic(s) or glass) are also suitable for the combination operation (microwave and hot-air, microwave and grill).

Note however that the utensils become very hot by hot-air or grill. Plastic utensils and foil are not suitable for the combination operation. Do not use kitchen or baking paper. It could overheat and catch fire.

### METAL

should not usually be used. Exceptions are coated baking tins, where-by the outer areas are well covered by the food e.g. bread, cake and piquant cakes. Consider the notes for the suitable ovenware in the microwave operation. If it begins sparking, a heat-resistant insulating material, e.g. a small porcelain plate, should be placed between the metal tin and the rack. Do not use these materials for cooking with the combination operation when sparking occurs.

### SUITABLE UTENSILS FOR CONVECTION AND GRILL OPERATION

When cooking with convection and grill, without microwave mode, you can use the same utensils you would use for any conventional oven or grill cookery.

## TIPS AND ADVICE



### BEFORE YOU START....

To make it as easy as possible to use the microwave oven we have put together a few hints and tips for you. Only switch on the oven when the food is already inside.

### SETTING THE COOKING TIME

Defrosting, re-heating and cooking times are generally much shorter than in a conventional oven or hob. So you will need to consult this book for the recommended cooking times. It is better to set shorter rather than longer cooking times. Always test the food after the cooking time has elapsed. It is better then to continue cooking it for a little longer, than to have overcooked food.

### STARTING TEMPERATURE

Defrosting, re-heating and cooking times depend on the temperature of the food when you start. For example, deep frozen and re-fridgerated food will need longer than food that is at room temperature. Standard storage temperatures of food are assumed for re-heating and cooking times (refridgerator temperature of 5° C, Room temperature of approximately 20° C). For defrosting food a starting temperature of -18° C is assumed.

Cook **popcorn** only in special microwave safe containers. Refer exactly to the manufacturer's instructions. Do not use a normal paper or glass container.



Do not cook **eggs** in the unbroken shells. Pressure builds up inside the shell and this may result in the egg exploding.

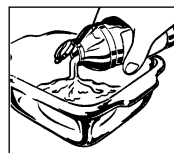

Do not heat **oil or fat** for deep-frying inside the microwave oven. It is impossible to control the temperature of the oil and it may suddenly splash out of the pan.

Do not heat **sealed containers** such as jars or tins. The pressure inside the container could cause the container to explode. (The exception is when you are making preserves).

GB-23

ENGLISH



## TIPS AND ADVICE

### COOKING TIMES

All the times given in this cookery book are guidelines, which can be varied according to the initial temperature, weight and condition of the food (water or fat content etc.).

### SALT, SPICES AND HERBS

Food cooked in your microwave retains its individual flavour better than it does when conventional preparation methods are used. For this reason you should use salt sparingly and normally add it only after cooking. Salt absorbs liquid and dries out the outer layer of food. Herbs and spices can be used as normal.

### TESTING THE FOOD

You can test whether food is cooked in the same way as conventional cookery.

- Using a food thermometer. After cooking or reheating all foods have a certain internal temperature. You can use a food thermometer to test whether the food is hot enough, or 'done'.
- Using a fork. Test fish with a fork. If the flesh is not transparent and comes off the bone easily, it is done. If it is overcooked, it will be brittle and dry.
- Wooden skewer. Test cakes and bread by sticking in a wooden skewer. If the skewer comes out clean and dry, the food is ready.

### USING A FOOD THERMOMETER TO DETERMINE COOKING TIME

Once cooked, every drink and every foodstuff has a certain internal temperature at which the cooking process can be switched off and the food will be cooked. The internal temperature can be ascertained with a food thermometer. The most important temperatures are specified in the temperature table.

### TEMPERATURE TABLE

Drink / Food	Internal temperature once cooked	Internal temp. after 10 - 15 mins standing time
Heating drinks (Coffee, Water, Tea, etc.)	65-75° C	
Heating milk	60-65° C	
Heating soup	75-80° C	
Heating stew	75-80° C	
Poultry	80-85° C	85-90° C
Lamb		
Pink	70° C	70-75° C
Well done	75-80° C	80-85° C
Roast beef		
Rare	50-55° C	55-60° C
Medium	60-65° C	65-70° C
Well done	75-80° C	80-85° C
Pork, Veal	80-85° C	80-85° C

### ADDITION OF WATER

Vegetables and other foods with a high water content can be cooked in their own juice or with the addition of a little water. This ensures that many vitamins and minerals are preserved.

### FOOD IN SKINS OR SHELLS

Foods such as sausages, chickens, chicken legs, baked potatoes, tomatoes, apples, egg yolks or such like should be pricked or pierced with a fork or small wooden skewer. This will enable the steam which forms to dissipate without splitting the skin or shell.

### FATTY FOODS

Fatty meat and layers of fat cook better than lean portions of meat. Before cooking, cover the fatty portions with a piece of aluminium foil or place the food with the fat side down.

### BLANCHING VEGETABLES

Before they are frozen vegetables should be blanched. This is the best way of retaining the quality and flavour. How to blanch vegetables:

Wash and chop the vegetable, place 250g of the vegetable in a bowl with 275ml of water, cover and heat for 3-5 minutes.

Plunge into cold water immediately after the blanching process to prevent further cooking, and then allow it to drain. Pack and freeze the vegetable in airtight containers.

## TIPS AND ADVICE



### PRESERVING FRUIT AND VEGETABLES

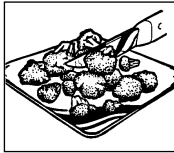

Preserving fruit and vegetables using the microwave is a quick and easy process. You can buy preserving jars, seals and preserving jar clamps specially designed for microwave use. Precise instructions are provided by the manufacturers of these items.

### LARGE AND SMALL QUANTITIES

Microwave times are directly dependent upon the amount of food which you would like to thaw, heat or cook. This means that small portions cook more quickly than larger ones. As a rule of thumb:  
 TWICE THE AMOUNT = ALMOST TWICE THE TIME  
 HALF THE AMOUNT = HALF THE TIME

### DEEP AND SHALLOW CONTAINERS

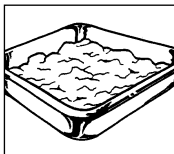

Both containers have the same capacity, but the cooking time is longer for the deeper one. You should therefore choose as flat a container as possible with a large surface area. Only use deep containers for dishes where there is a danger of overcooking, e.g. for noodles, rice, milk etc..

### ROUND AND OVAL CONTAINERS

Food cooks more evenly in round or oval containers than in containers with corners, since the microwave energy concentrates in the corners and the food in these areas could become overcooked.

### COVERING

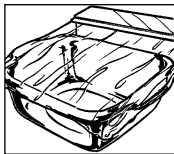

Covering the food retains the moisture within it and shortens the cooking time. Use a lid, microwave foil or a cover. Foods which are to be crispy, e.g. roasts or chickens, should not be covered. As a general rule, whatever would be covered in a conventional oven should also be covered in a microwave oven. Whatever would be uncovered in a conventional oven can also be left uncovered in a microwave oven.

### IRREGULAR SHAPED FOOD

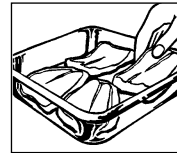

Place the thicker, more compacted end of the food pointing towards the outside. Place vegetables (such as broccoli) with the stalks pointing outward. Thicker parts will require a longer cooking time and will receive more microwave energy when placed on outside. The food will be cooked more evenly.

### STIRRING



Stirring the food is necessary, since the microwaves begin by heating the outer areas. The temperature is thereby equalised and the food heats up evenly.

### ARRANGEMENT OF FOOD

Place a number of individual portions, such as small pudding moulds, cups or potatoes in their jackets, in a circle on the turntable. Keep the portions at a distance from each other so that the microwave energy can reach the food from all sides.

### TURNING

Medium-sized items, such as hamburgers and steaks, should be turned over once during cooking, in order to shorten the cooking process. Large items, such as roasts and chickens, must be turned, since the upper side receives more microwave energy and could dry out if not turned.

### STANDING TIME

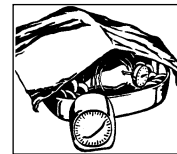

Keeping to the standing time is one of the most important rules with microwaves. Almost all foods, which are thawed, heated or cooked in the microwave, require a certain amount of time to stand, during which temperature equalisation takes place and the moisture in the food is evenly distributed.



## HEATING

- Ready-prepared meals in aluminium containers should be removed from the aluminium container and heated on a plate or in a dish.
- Remove the lids from firmly closed containers.
- Food should be covered with microwave foil, a plate or cover (obtainable from stores), so that the surface does not dry out. Drinks need not be covered.
- When boiling liquids such as water, coffee, tea or milk, place a glass stirrer in the container.
- If possible, stir large quantities from time to time, to ensure that the temperature is evenly distributed.
- The times are for food at a room temperature of 20° C. The heating time for food stored in a refrigerator should be increased slightly.
- After heating allow the food to stand for 1-2 minutes, so that the temperature inside the food can be evenly distributed (standing time).
- The times given are guidelines which can be varied according to the initial temperature, weight, water content, fat content or the result which you wish to achieve.



## DEFROSTING

Your microwave is ideal for thawing. Thawing times are usually considerably shorter than in traditional methods. Here are a few tips. Take the frozen item out of its packaging and place on a plate for thawing.

### BOXES AND CONTAINERS

Boxes and containers suitable for microwaves are particularly good for thawing and heating food, since they can withstand temperatures in a deep freeze (down to approx. -40° C) as well as being heat-resistant (up to approx. 220° C). You can therefore use the same container to freeze, thaw, heat and even cook the food, without having to transfer it.

### COVERING



Cover thin parts with small strips of aluminium foil before thawing. Thawed or warm parts should likewise be covered with aluminium strips during thawing. This stops the thin parts becoming too hot while thicker parts are still frozen.

### CORRECT SETTING

It is better to choose a setting which is too low rather than one which is too high. By so doing you will ensure that the food thaws evenly. If the microwave setting is too high, the surface of the food will already have begun to cook while the inside is still frozen.

### TURNING/STIRRING

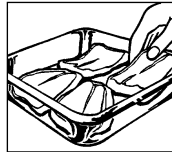

Almost all foods have to be turned or stirred from time to time. As early as possible, separate parts which are stuck together and rearrange them.

### SMALL AMOUNTS...

thaw more quickly and evenly than larger ones. We recommend that you freeze portions which are as small as possible. By so doing you will be able to prepare whole menus quickly and easily.

### FOODS REQUIRING CAREFUL HANDLING

Foods such as gateaux, cream, cheese and bread should only be partially thawed and then left to thaw completely at room temperature. By so doing you will avoid the outer areas becoming too hot while the inside is still frozen.

### STANDING TIME

This is particularly important after thawing food, as the thawing process continues during this period. In the thawing table you will find the standing times for various foods. Thick, dense foods require a longer standing time than thinner foods or food of a porous nature. If the food has not thawed sufficiently, you may continue thawing it in the microwave oven or lengthen the standing time accordingly. At the end of the standing time you should process the food as soon as possible and not re-freeze it.



## DEFROSTING AND COOKING



Deep-frozen dishes can be thawed and cooked at the same time in one process in your microwave. You will find some examples in the table. (see page GB-29). Do take note, however, of the general advice given on "heating" and "thawing" food.

Please refer to the manufacturer's instructions on the packaging when preparing deep-frozen dishes. These usually contain precise cooking times and offer advice on preparation.

## COOKING MEAT, FISH AND POULTRY



- When buying food items, try to ensure that, as far as possible, they are of similar size. This will ensure that they are cooked properly.
- Before preparation wash meat, fish and poultry thoroughly under cold running water and pat them dry with kitchen paper. Then continue as normal.
- Beef should be well hung and have little gristle.
- Even though the pieces may be of a similar size, cooking results may vary. This is due, amongst other things, to the kind of food, variations in the fat and moisture content as well as the temperature before cooking.
- Turn large pieces of meat, fish or poultry half way through the cooking time, so that they are cooked evenly from all sides.
- After cooking cover roasts with aluminium foil and allow them to stand for approx. 10 minutes (standing time). During this period the roast carries on cooking and the liquid is evenly distributed, so that when it is carved a minimum amount of juice is lost.

## COOKING FRESH VEGETABLES



- When buying vegetables try to ensure that, as far as possible, they are of similar size. This is particularly important when you want to cook the vegetables whole (e.g. boiled potatoes).
- Wash the vegetables before preparing them, clean them and only then weigh the required quantity for the recipe and chop them up.
- Season them as you would normally, but as a rule only add salt after cooking.
- Add about 5 tbsps of water for 500 g of vegetables. Vegetables which are high in fibre require a little more water. You will find information about this in the table. (see page GB-30).
- Vegetables are usually cooked in a dish with a lid. Those with a high moisture content, e.g. onions or boiled potatoes, can be cooked in microwave foil without adding water.
- After half the cooking time has elapsed vegetables should be stirred or turned over.
- After cooking allow the vegetables to stand for approx. 2 minutes, so that the temperature disperses evenly (standing time).
- The cooking times given are guidelines and depend upon the weight, initial temperature and condition of the type of vegetable in question. The fresher the vegetables, the shorter the cooking times.



## SYMBOL EXPLANATION

### MICROWAVE POWER

Your microwave has a power of 900 W and five power settings. To select the required power level consult the recipe guide.

In general we recommend the following:

#### **100 % Power = 900 Watt**

Used to cook or heat up quickly, e.g. ready meals, hot drinks, vegetables, fish etc.

#### **70 % Power = 630 Watt**

Reduce the power to achieve longer cooking times when compact food such as roasts, or delicate foods such as cheese sauce. At the lower power setting liquids do not boil over, and meat cooks evenly, without overcooking at the edges.

#### **50 % Power = 450 Watt**

For compact foods that require longer cooking times by conventional methods, e.g. beef casseroles, we recommend that you reduce the power and increase the cooking time. This makes the meat more tender.

#### **30 % Power = 270 Watt**

Select this power level to defrost. This ensures that the food defrosts evenly. This level is also ideal for simmering rice, noodles and dumplings.

#### **10 % Power = 90 Watt**

This level is used for defrosting delicate foods (which must not get hot) e.g. cream cakes.

**W = WATT**

### Symbol Explanation

#### **Top Grill**

A versatile attachment for browning and grilling meat, poultry and fish.

#### **Bottom Grill**

This mode can be used to brown food from below.

#### **Top and Bottom Grill**

Simultaneous operation of the grill from above and from below. This combination is particularly suitable for e.g. toasted bread, quiches and rissoles.

#### **Convection**

In this mode you can choose between 10 heat settings (40° C - 250° C).

#### **DUAL: Microwave and Convection**

In this mode you can combine certain microwave power settings with a selected convected air temperature (40° C - 250° C).

Microwave power is limited to 50 % in combination mode.

#### **DUAL: Microwave and Top Grill**

#### **DUAL: Microwave and Bottom Grill**

In these two modes a variety of microwave power settings can be combined with the top grill or bottom grill.

## COOKING CHARTS



### TABLE : DEFROSTING BY MICROWAVE

Food	Quantity -g-	Output Watts	Defrost time -Min-	Instructions	Stand time -Min-
Sausages	300	270 W	3-5	place sausages side by side, turn halfway through defrost period	5-10
Crab	300	270 W	6-8	turn halfway through the defrost period and remove defrosted parts	5
Bread, sliced	250	270 W	2-3	place slices side by side, first stage of defrost only	5
Bread, whole loaf	1000	270 W	8-10	turn halfway through defrost period	15
Cake, per piece	150	270 W	1-3		5
Gateau, whole 24cm		270 W	8-10		60-90
Butter	250	270 W	2-3	first stage of defrost only	15
Fruit, eg. strawberries, raspberries, cherries plums	250	270 W	2-4	place side by side at equal intervals and turn halfway through defrost time	5

Please use the auto defrost program for poultry, chicken legs, chops, steak and fish fillets.

### TABLE : DEFROSTING AND COOKING

Food	Quantity -g-	Setting	Output Watts	Cook time -Min-	Added water	Instructions	Standing time -Min-
Fish fillets	400		900 W	10-12	-	cover	1-2
Trout x 1	250		900 W	6-8	-	cover	1-2
Pre-prepared meal	400		900 W	8-10	-	cover, stir after 5 minutes	2
Vegetable	300		900 W	7-9	5 EL	cover, stir halfway through cooking period	2
Vegetable	450		900 W	9-11	5 EL	cover, stir halfway through cooking period	2
Herbal bread,	175	 	630 W	app. 3 app. 2		place on the turntable	3-4
Pre-baked Bread Rolls x 4	80	 	900 W 180° C	1/2 8-10		place on the turntable, start defrosting and crisp up	



## COOKING CHARTS

**TABLE : HEATING UP DRINKS AND MEALS**

Drink/meal	Quantity -g/ml-	Output Watt	Time -Min-	Instructions
Drink, 1 cup	150	900 W	app. 1	do not cover
Ready-prepared meal (vegetables, meat and side dishes)	400	900 W	3-5	sprinkle water over the sauce, cover, stir during cooking
Stew, soup	200	900 W	1-3	cover, stir after heating
Side dishes	200	900 W	app. 2	sprinkle with a little water, cover, stir, during cooking
Meat, 1 slice <sup>1</sup>	200	900 W	2-3	sprinkle with a little sauce, cover,
Sausages, x 2	180	450 W	app. 2	prick the skin several times
Baby food, 1 glass	190	450 W	1/2-1	remove the lid, stir well after heating and test the temperature
To melt butter or margarine <sup>1</sup>	50	900 W	app. 1/2	cover
To melt chocolate	100	450 W	app. 3	stir during cooking
To dissolve 6 sheets of gelatine	10	450 W	1/2-1	soak in water, squeeze dry and place in a soup bowl; stir during cooking

<sup>1</sup>straight from the refrigerator

**TABLE : COOKING FRESH VEGETABLES**

Food	Quantity -g-	Output Watts	Cooking time -Mins-	Instructions	Water -tbsp-
Vegetables (eg. cauliflower, leeks, fennel broccoli, peppers, courgettes)	300	900 W	5-7	prepare as normal, cover and stir during cooking	5
	500	900 W	8-10		5

GB-30

# COOKING CHARTS



## TABLE : COOKING, GRILLING, BROWNING

Dish	Quantity -g-	Setting	Output Watts	Cooking time -Min-	Instructions	Standing time -Min-
Roast pork	600 - 2000				Use Auto-program for Roast pork	10
Roast beef medium	1000		630 W	5-8	Season to taste, place on the low rack with the fat side downwards, turnover after (*)	10
			630 W	7-10 (*)		
			630 W	2-5		
Roast beef medium	1500		630 W	12-14	Season to taste, place on the low rack with the fat side downwards, turnover after (*)	10
			630 W	12-14 (*)		
			630 W	4-5		
Cooked mince	700		450 W	20-23	Prepare mince (half pork/ half beef), place in an oven-proof dish on the turntable	10
			450 W	6-9		
Chicken	1200				Use Auto-program for Roast chicken	3
Chicken legs	200		270 W	4-6 (*)	Season to taste, place on the low rack with the skin downwards, turnover after (*)	3
			270 W	ca. 4		
Chicken legs	600		450 W	7-9 (*)	Season to taste, place on the low rack with the skin downwards, turnover after (*)	3
				7-9		
Trout	250		90 W	6-8 (*)	Wash, sprinkle with lemon juice, salt the fish inside and outside, brush with melted butter roll in flour, place on the high rack, turnover after (*)	3
			90 W	3-5		
Rump steak	200			10-11 (*)	Place on the high rack, turnover after (*)	-
				6-8		
Grilled sausages 5 pieces	400			9-11 (*)	Place on the high rack, turnover after (*)	-
				6-7		
To brown puddings etc.				10-12	Place oven-proof dish on the low rack	-
Welsh rarebit			450 W	1/2	Toast the bread and spread it with butter; top with a slice of cooked ham, a slice of pineapple and a slice of cheese. Prick the centre and place on the high rack.	-
				5-7		



## RECIPES

### ADAPTING RECIPES FOR THE MICROWAVE OVEN

If you would like to adapt your favourite recipes for the microwave, you should take note of the following:

Shorten cooking times by a third to a half. Follow the example of the recipes in this cookery book.

Foods which have a high moisture content such as meat, fish, poultry, vegetables, fruit, stews and soups can be prepared in your microwave without any difficulty. Foods which have little moisture, such as platters of food, should have the surface moistened prior to heating or cooking.

The amount of liquid to be added to raw foods, which are to be braised, should be reduced to about two thirds of the quantity in the original recipe. If necessary, add more liquid during cooking.

The amount of fat to be added can be reduced considerably. A small amount of butter, margarine or oil is sufficient to flavour food. For this reason your microwave is excellent for preparing low-fat foods as part of a diet.

### FOR COMBINED OPERATION

In general the same rules apply as for microwave operation. The following additional tips should be borne in mind:

1. Refer to the appropriate recipe in this cookbook when selecting the convection temperature. Do not select too high a temperature for long cooking times, otherwise the food will brown too quickly on the outside and the inside will not be cooked.
2. The microwave power setting must match the type of food and the cooking time. Consult the recipes in this cookbook.

3. When preparing food in microwave-grill combination mode remember that microwave times are longer for large, bulky food, such as roast pork, than for small flat food. As far as grilling is concerned the situation is quite the opposite. The nearer the food is to the grill, the quicker it browns. This means that when you cook large pieces of meat, for example, in combination mode, the grilling time needs to be shorter than for smaller pieces of meat.
4. For cooking in combination mode or by convection only the bottom rack is generally used. Use the top rack for normal grilling to get quick and even browning (exceptions are large, bulky foods and puddings, which are also grilled on the bottom rack).

### HOW TO USE RECIPES

- All the recipes in this cookery book are calculated on the basis of 4 servings - unless otherwise stated.
- Recommendations relating to suitable utensils and the total cooking times are given at the beginning of every recipe.
- As a rule the quantities shown are assumed to be wholly consumable, unless specifically indicated otherwise.
- When eggs are given in the recipes they are assumed to have weight of approx. 55 g (medium).

### ABBREVIATIONS USED

tbsp = tablespoon  
tsp = teaspoon  
Cup = cupful  
kg = kilogram  
g = gram

l = litre  
ml = millilitre  
cm = centimetre  
DFC = dry fat content  
DF = deep frozen

min = minutes  
sec = seconds  
dm = diameter  
app. = approximate  
sach. = sachet

## Soup and Starters

France

### Onion soup

*Soupe à l'oignon et au fromage*

Total cooking time: approx. 15-18 minutes

Utensils required: bowl with lid (2 litres size)  
4 soup bowls (x 200 ml)

#### Ingredients

- 1 *tblsp* butter or margarine
- 2 *onions* (100 g), sliced
- 800 *ml* meat stock
- salt & pepper*
- 2 *slices of bread* for toasting
- 4 *tblsp* grated cheese

#### Preparation

- Place the butter cut up into pieces in the bowl. Add the sliced onion, the meat stock and the seasoning. Cover and microwave.

9-11 min.  900 W

- Toast the slices of bread, cut them into cubes and divide them among the soup bowls. Pour the soup over the toast cubes and sprinkle on the cheese.
- Place the bowls on the turntable, use the top grill and brown the cheese topping.

6-7 min. 

Sweden

### Crab soup

*Kräftsoppa*

Total cooking time: approx. 11-15 minutes

Utensils required: bowl with lid (2 litres size)

#### Ingredients

- 1 *onion* (50 g), finely chopped
- 50 *g* carrots, sliced
- 3 *tblsp* butter or margarine (30 g)
- 500 *ml* meat stock
- 100 *ml* white wine & 100 *ml* Madeira wine
- 200 *g* tinned crab meat
- 1/2 *bay leaf*
- 3 *white peppercorns*
- thyme*
- 3 *tblsp* flour (30 g)
- 100 *ml* cream

#### Preparation

- Place the vegetables with 2 *tblsp* of the fat in the bowl. Cover and microwave.

2-3 min.  900 W

- Add the meat stock, wine and Madeira together with the crab meat and the seasoning to the vegetables. Cover and microwave.

7-9 min.  450 W

- Remove the bay leaf and the peppercorns from the soup. Blend the flour with a little cold water and add to the soup. Add the cream, stir it in and reheat.

2-3 min.  900 W

- Stir the soup and leave it to stand for about 5 minutes. Add the butter shortly before serving.

Switzerland

### Barley soup from the Grisons Canton

*Bündner Gerstensuppe*

Total cooking time: approx. 27-34 minutes

Utensils required: bowl with lid (3 litres size)

#### Ingredients

- 2 *tblsp* butter or margarine (20 g)
- 1 *onion* (50 g), finely chopped
- 1-2 *carrots* (130 g), sliced
- 15 *g* celery, diced
- 1 *leek* (130 g), cut in rings
- 3 *white cabbage leaves* (100 g), shredded
- 200 *g* veal bones
- 50 *streaky bacon*, shredded
- pepper*
- 50 *g* barleycorns
- 700 *ml* meat stock
- 4 *frankfurters*

#### Preparation

- Put the butter and the onion in the bowl. Cover and cook.

1-2 min.  900 W

- Put the vegetables in the bowl. Add the bones, streaky bacon and barley and top up with meat stock. Season with salt. Cover and microwave.

1. 9-11 min.  900 W

2. 17-21 min.  450 W

- Cut up the sausages in small pieces and heat them in the bowl for the last 5 minutes.
- Let the soup stand for about 5 minutes after cooking. Remove the bones from the soup shortly before serving.

GB-33

## Recipes

**Soup and Starters**

Germany

**Mushrooms on toast***Champignon toast*

Total cooking time: approx. 3-4 minutes

Utensils required: high rack

**Ingredients**

- 2 *tbsp* butter or margarine  
 2 *garlic* cloves, crushed  
 salt  
 4 *slices of bread* for toasting  
 75 *g* mushrooms, sliced  
 salt & pepper  
 75 *g* grated cheese  
 4 *tbsp* parsley, finely chopped  
 sweet paprika

**Preparation**

- Combine the butter, garlic and salt.
- Toast the bread and spread with the garlic butter. Lay the mushrooms on top and season with salt and pepper.
- Mix the cheese and parsley and arrange on top of the mushrooms. Sprinkle with paprika.
- Place the toast and mushrooms on the high rack and microwave.

---

 3-4 min.  270 W
 

---

Spain

**Mushrooms with rosemary***Champiñonés rallenos al romero*

Total cooking time: approx. 11-17 minutes

 Utensils required: bowl with lid (1 litre size)  
 shallow round oven-proof dish  
 (dm. approx. 26 cm),  
 microwave foil
**Ingredients**

- 8 *large mushrooms* (app. 500 g), whole  
 2 *tbsp* butter or margarine (20 g)  
 1 *onion* (50 g), finely chopped  
 50 *g* ham, cut into small cubes  
 milled black pepper  
 rosemary, bruised  
 125 *ml* dry white wine  
 125 *ml* cream  
 2 *tbsp* flour (20 g)

**Preparation**

- Remove the stalks from the mushrooms and chop the stalks into small pieces.
- Put the butter in the bowl and spread it over the bottom. Add the onions and the diced ham and the mushroom stalks and season with pepper and rosemary. Cover and microwave.

---

 3-5 min.  900 W
 

---

Allow to cool.

- Heat 100 ml of the wine and the cream in the ovenproof dish covered with microwave foil.

---

 1-3 min.  900 W
 

---

- Blend the flour with the rest of the wine, stir into the heated liquid, cover and microwave. Stir once during cooking.

---

 app. 1 min.  900 W
 

---

- Fill the mushrooms with the ham mixture, add them to the sauce and cook using the high rack.

---

 6-8 min.  630 W
 

---

Let the mushrooms stand for approx. 2 minutes when cooked.

Germany

**Spicy Turkey***Pikante Putenpfanne*

(for 2 servings)

Total cooking time: approx. 22-27 minutes

 Utensils required: shallow oval oven-proof dish with  
 lid (26 cm)
**Ingredients**

- 1 *cup long-grain rice*, parboiled (120 g)  
 1 *sachet of saffron* strands  
 300 *g* turkey breast, diced  
 250 *ml* meat stock  
 1 *onion* (50 g), sliced  
 1 *red pepper* (100 g), shredded  
 1 *small leek* (100 g), shredded  
 pepper and paprika  
 2 *tbsp* butter or margarine (20 g)

**Preparation**

- Mix the rice with the saffron and put it in the oven-proof dish with the diced meat. Pour the meat stock over, cover and microwave.

---

 4-6 min.  900 W
 

---

- Add the vegetables and seasoning and stir. Distribute the butter over the top. Cover and microwave.

---

 1. 1-2 min.  900 W
 

---



---

 2. 17-19 min.  270 W
 

---

Allow the Spicy Turkey to stand for 2-3 minutes after cooking.







## Meat, Fish and Poultry



Greece

### Aubergines stuffed with minced meat

Melitsénes jemistés mé kimá

Total cooking time: approx. 17-22 minutes  
 Utensils required: bowl with lid (1 litre size)  
 shallow oval oven-proof dish with lid  
 (approx. 32 cm long)

#### Ingredients

- 2 aubergines, less stalks (app. 250 g)
- 3 tomatoes (app. 200 g)
- 1 tbsp olive oil to grease the dish
- 2 onions (100 g), chopped
- 4 mild green chillies
- 200 g mince (beef or lamb)
- 2 garlic cloves, crushed
- 2 tbsp parsley, chopped
- salt & pepper
- pink paprika
- 60 g Feta cheese, diced

#### Tip:

You can substitute courgettes for the aubergines.

#### Preparation

1. Cut the aubergines in half lengthways. Scoop out the flesh with a teaspoon to leave a shell about 1 cm thick. Sprinkle the aubergines with salt and dice the scooped-out flesh.
2. Remove the skin from two of the tomatoes and chop them up, having first cut out the stalks.
3. Grease the bottom of the bowl with the olive oil. Add the onions. Cover and cook.

app. 2 min. 900 W

4. Remove the stalks and seeds from the chillies and cut them into rings. Retain a third for the garnish. Mix the minced meat with the diced aubergines, onions and tomatoes, the chilli rings, the crushed garlic clove and the parsley. Season to taste.
5. Dry the aubergine halves. Fill with half of the mince mixture, spread the sheep's cheese on top, and then add the rest of the filling.
6. Arrange the aubergine halves in the greased oven-proof dish, place the dish on the turntable and cook using bottom grill and microwave.

11-13 min. 630 W

Garnish the aubergine halves with the chilli rings and slices of tomato and continue cooking.

4-7 min. 630 W

Allow the aubergines to stand for about 2 minutes after cooking.



GB-35

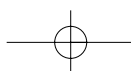

Spain

### Stuffed ham

Jamón relleno

Total cooking time: approx. 13-16 minutes  
 Utensils required: bowl with lid (2 litres size)  
 shallow oval oven-proof dish  
 (approx. 26 cm long)  
 8 small wooden skewers

#### Ingredients

- 150 g leaf spinach with stalks removed
- 150 g quark, 20 % fat content
- 50 g grated Emmenthal cheese
- pepper
- sweet paprika
- 8 slices of cooked ham (400 g)
- 125 ml water
- 125 ml cream
- 2 tbsp flour (20 g)
- 2 tbsp butter or margarine (20 g)
- 1 tsp butter or margarine to grease dish

#### Preparation

1. Cut up the spinach finely, blend it with the quark and the cheese and season to taste.
2. Cover each slice of cooked ham with a tablespoon of the filling and roll it up. Insert a skewer into each roll.
3. To make a béchamel sauce, pour the liquid into the bowl, cover and heat.

2-4 min. 900 W

Mix the butter with the flour, add it to the liquid and stir with a whisk until smooth and dissolved. Cover and bring it to the boil so that it thickens.

app. 1 min. 900 W

Stir and taste.

4. Place the rolls of ham in the greased oven-proof dish, pour the sauce over and microwave on the turntable.

10-11 min. 630 W

Allow the rolls to stand for about 5 minutes after cooking.

#### Tip:

You can also use shop-bought ready-made béchamel sauce.



Recipes

**Meat, Fish and Poultry**

Italy

**Quails in cheese and herb sauce***Quagile in salsa vellutata*

Total cooking time: approx. 16-19 minutes

Utensils required: thread  
shallow square oven-proof dish  
(approx. 20 x 20 x 6 cm)  
bowl with lid

**Ingredients**

4 quails (600 g)  
salt & pepper  
200 g streaky bacon, thinly sliced  
1 tsp butter or margarine to grease dish  
per 1 tbsp fresh parsley  
sage, rosemary  
basil, finely chopped  
150 ml port wine  
250 ml meat stock  
2 tbsp butter or margarine (20 g)  
2 tbsp flour (20 g)  
50 g grated Emmenthal cheese

**Preparation**

1. Wash the quails and carefully dry them. Apply salt and pepper to the inside and outside of the quails. Wrap them in slices of bacon and secure with thread.
2. Place the quails on the low rack and grill.

---

8-10 min.  630 W

---

3. Place the quails into the greased dish with the grilled side downwards. Finely chop the herbs, scatter over the quails and pour over the port wine. Place on the turntable and cook.

---

4-5 min.  630 W

---

Remove the quails from the broth and wrap them in aluminium foil.

4. To make the sauce, heat the meat stock in the covered bowl.

---

app. 2 min.  900 W

---

Mix the butter into the flour, stir it into the liquid, bring it to the boil and microwave.  
Stir once during cooking.

---

app. 2 min.  900 W

---

5. Stir the cheese into the sauce. Add the cheese sauce to the broth and mix everything thoroughly together. Add the quails to the sauce and serve.



Switzerland

**Zurich creamed meat***Züricher Geschnetzeltes*

Total cooking time: approx. 9-14 minutes

Utensils required: bowl with lid (2 litres size)

**Ingredients**

600 g fillet of veal  
1 tbsp butter or margarine  
1 onions (50 g), finely chopped  
100 ml white wine  
dark sauce binder with seasoning for about half litre of sauce  
300 ml cream  
1 tbsp parsley, chopped

**Preparation**

1. Cut the fillet into finger-sized strips.
2. Spread the butter evenly over the dish. Put the onion and the meat in the dish. Cover and microwave. Stir once during cooking.

---

6-9 min.  900 W

---

3. Add the white wine, sauce binder and cream and stir. Cover and microwave further. Stir once during cooking.

---

3-5 min.  900 W

---

4. Taste, stir once more and leave standing for about 5 minutes. Serve garnished with parsley.



GB-36

## Meat, Fish and Poultry

Italy

### Veal cutlet with mozzarella

Scalope all pizzalola

Total cooking time: approx. 24-31 minutes

Utensils required: shallow square oven-proof dish with lid (approx. 25 cm long)

#### Ingredients

- 2 mozzarella cheese (x 150 g)
- 400 g peeled tinned tomatoes (less liquid)
- 4 veal cutlets (600 g)
- 20 ml olive oil
- 2 cloves of garlic, sliced
- freshly milled pepper
- 2 tbsp capers (20 g)
- oregano, salt

#### Preparation

1. Cut the mozzarella into slices. Puree the tomatoes with the puree attachment of a hand mixer.
2. Wash the cutlets, dry them and beat them flat. Distribute the oil and the garlic slices over the bottom of the oven-proof dish. Add the cutlets and pour over the tomato puree. Sprinkle with pepper, capers and oregano and cover and cook.

14-16 min.  630 W

Turn the meat slices.

3. Place a few slices of mozzarella on each piece of meat, add salt and grill uncovered on the top grill.

9-11 min. 

After cooking allow to stand for about 5 minutes.

#### Tip:

Spaghetti and a fresh salad can be served with this dish.

Germany

### Pork kebabs

Bunte Fleischspiesse

Total cooking time: approx. 17-18 minutes

Utensils required: high rack  
four wooden skewers  
(app. 25 cm long)

#### Ingredients

- 400 g escalope of pork
- 100 g smoked belly of pork
- 2 onions (100 g), in quarters
- 4 tomatoes (250 g), in quarters
- 1/2 green pepper (100 g), in eight pieces

- 4 tbsp oil
- 2 tsp sweet paprika
- salt
- 1/2 tsp cayenne pepper
- 1 tsp worcester sauce

#### Preparation

1. Cut the escalope of pork and the pork belly into 2-3 cm cubes.
2. Thread meat and vegetables alternately on four wooden skewers.
3. Combine the oil with the spices and brush over the kebabs. Place the kebabs on the High Rack and cook.

AUTOMATIC "GRILL SKEWERS" 

Netherlands

### Meat loaf

Gehackschotel

Total cooking time: approx. 20-23 minutes

Utensils required: bowl with lid (2 litres size)

#### Ingredients

- 500 g minced meat (half pork, half beef)
- 3 onions (150 g), finely chopped
- 1 egg
- 50 g breadcrumbs
- salt & pepper
- 350 ml meat stock
- 70 g tomato puree
- 2 potatoes (200 g), diced
- 2 carrots (200 g), diced
- 2 tbsp parsley, chopped

#### Preparation

1. Knead the minced meat, onion cubes, egg and breadcrumbs into a dough and season with salt and pepper. Place the meat loaf in the dish.
2. Mix the meat stock with the tomato puree.
3. Arrange the potatoes and carrots around the meat loaf together with the liquid. Cover and microwave. Turn once during cooking.

20-23 min.  900 W

Give the contents of the dish a final adjustment and leave to stand for about 5 minutes. Serve sprinkled with parsley.

Recipes

**Meat, Fish and Poultry**

France

**Fillets of sole***Filets de sole*

(for 2 servings)

Total cooking time: approx. 12-14 minutes

Utensils required: shallow oval oven-proof dish with lid (approx. 26 cm long)

**Ingredients**

- 400 g sole fillets  
 1 lemon, untreated  
 2 tomatoes (150 g)  
 1 tsp butter or margarine to grease dish  
 1 tbsp vegetable oil  
 1 tbsp parsley, chopped  
 salt & pepper  
 4 tbsp white wine (30 ml)  
 2 tbsp butter or margarine (20 g)

**Preparation**

1. Wash the sole fillets and dab them dry. Remove bones.
2. Thinly slice the lemon and the tomatoes.
3. Grease the oven-proof dish with butter. Place the fish fillets in the dish and sprinkle vegetable oil over them.
4. Sprinkle the parsley over the fish fillets, arrange the tomato slices on them and season. Top the tomatoes with the slices of lemon and pour over the white wine.
5. Dot the lemons with flakes of butter. Cover and microwave.

---

 12-14 min.  630 W
 

---

Allow the fish fillets to stand for about 2 minutes after cooking.

You can also use bass, halibut, grayling, plaice or cod for this dish.

Switzerland

**Fish fillets with cheese sauce***Fischfilet mit Käsesauce*

Total cooking time: approx. 20-24 minutes

Utensils required: bowl with lid (1 litre size)  
shallow oval oven-proof dish (approx. 25 cm long)**Ingredients**

- 4 fish fillets (app. 800 g)  
 (e.g. perch, flounder or cod)  
 2 tbsp lemon juice  
 salt  
 1 tbsp butter or margarine  
 1 onion (50 g), finely chopped  
 2 tbsp flour (20 g)  
 100 ml white wine  
 1 tsp vegetable oil to grease the dish  
 100 ml grated Emmental cheese  
 2 tbsp chopped parsley

**Preparation**

1. Wash the fillets, dry them and sprinkle with lemon juice. Leave to stand for about 15 min., dry them again and sprinkle with salt.
2. Spread the butter on the bottom of the bowl. Add the chopped onion, cover and cook.

---

 1-2 min.  900 W
 

---

3. Coat the onion with flour and stir. Pour on the white wine and mix together.
4. Grease the oven-proof dish and put in the fillets. Pour the sauce over the fillets and sprinkle with cheese. Place on the turntable and cook.

---

 1. 8-9 min.  450 W
 

---



---

 2. 11-13 min.  450 W
 

---

Let the fish fillets stand for about 2 minutes after cooking. Serve garnished with chopped parsley.



## Meat, Fish and Poultry

Germany

### Almond trout

Mandelforellen

Total cooking time: approx. 16-19 minutes  
Utensils required: shallow oval oven-proof dish  
(approx. 30 cm long)

#### Ingredients

- 4 trout (x 200 g), trimmed  
juice of one lemon  
salt
- 30 g butter or margarine
- 5 tbsp flour (50 g)
- 1 tsp butter or margarine to grease dish
- 50 g almond flakes

#### Preparation

- Wash and dry the trout and sprinkle with lemon juice. Apply salt to the interior and exterior of the fish and leave to stand for 15 minutes.
- Melt the butter.

1 min.  900 W

- Dry the fish, spread on the butter and roll in the flour.
- Grease the dish. Put the trout in the dish and cook on the low rack.

15-18 min.  450 W

After two-thirds of the time, turn the trout and scatter the almonds over them.  
Allow the almond trout to stand for 2 minutes after cooking.

#### Tip:

Suitable accompanying dishes are parsley potatoes and a green salad.

France

### Toasted ham and cheese sandwich

Croque monsieur

Total cooking time: approx. 10 minutes

#### Ingredients

- 2 slices of toast
- 20 g butter
- 1-2 cheese slices  
(depending on the size of the toast)
- 1 slice of cooked ham
- 1 tbsp crème fraîche
- ca. 30 g grated cheese

#### Preparation

- Spread butter on the slices of toast.
- Place the cheese on a slice of toast followed by the ham. Spread with crème fraîche.
- Top with the other slice of toast and sprinkle with the grated cheese.  
Place the sandwich on the turntable and cook.

1. ca. 5 Min.  90 W

2. ca. 5 Min. 

France

### Prawn quiche

Quiche aux crevettes

Total cooking time: 22-27 minutes  
Utensils required: bowl with lid (1 litre)

#### Ingredients

- 200 g flour
- 120 g butter or margarine
- 4 tbsp cold water
- 2 tbsp butter or margarine
- 2 onions (100 g), finely chopped
- 100 g bacon, finely diced
- 150 g prawns, less shells
- 2 eggs
- 100 ml thick sour cream
- salt, pepper & nutmeg
- 1 tbsp parsley, chopped

#### Preparation

- Knead together the flour, butter and water and leave the pastry in a cool place for 30 minutes.
- Divide the butter in the dish. Put the onions, bacon and prawns in the dish. Cover and cook. Stir once during cooking.

4-6 min.  900 W

- Pour off the liquid when it has cooled. Beat the eggs with the sour cream and the herbs and spices.
- Roll out the pastry a little larger than the turntable. Place it on the turntable. Fold the excess pastry to form the sides of the quiche. Prick the base of the pastry several times with a fork.
- Mix the ingredients for the filling, distribute it over the base and bake.

1. 13-15 min.  270 W

2. 5-6 min. 



GB-39

## Recipes

**Snacks**

Germany

**Scrambled egg with onions and bacon***Rührei mit Zwiebeln und Speck*

Total cooking time: 4-5 minutes

**Ingredients**

5-10 g margarine  
 25 g onion, finely chopped  
 40 g bacon  
 3 eggs  
 3 tbsp milk  
 salt & pepper

**Preparation**

1. Distribute the fat, onion and bacon over the turntable and lightly braise.

2-3 min.  450 W

2. Beat the eggs with the milk and the seasoning. Pour the egg and milk mixture over the onion and bacon and microwave to set it.

app. 2 min.  900 W

Stir the scrambled egg once during cooking.

**Hamburgers***Hamburger*

Total cooking time: 13-16 minutes

**Ingredients**

400 g minced beef  
 salt & pepper

**Preparation**

1. Knead the ingredients into a smooth meat loaf mixture. With cold hands divide the mixture into four similarly sized, flat meat patties. Place the patties on the turntable and cook.

10-12 min.  270 W

2. Turn the meat patties.

3-4 min. 

Italy

**Artichoke pizza***Pizza al carciofi*

Total cooking time: 12-13 minutes

Utensils required: turntable

**Ingredients**

150 g flour  
 4 g dried yeast  
 1 tsp sugar  
 salt  
 2 tsp oil  
 90 ml lukewarm water  
 300 g tinned tomatoes, drained  
 100 g artichoke hearts  
 1 tsp olive oil to grease the turntable  
 basil, oregano, thyme  
 salt & pepper  
 1 tbsp tomato puree  
 30 g salami, sliced  
 50 g cooked ham  
 10 olives  
 100 g grated cheese

**Preparation**

1. Mix the flour with the dried yeast, sugar and salt (1/2 tsp). Add the oil and water and knead to make a workable dough. Place in the microwave oven and cook.

2-3 min.  90 W

Then let the dough stand covered for a further 10-15 minutes.

2. Chop the peeled tomatoes and cut the artichoke hearts in quarters.
3. Grease the turntable with the oil. Roll out the bread dough and place it on the turntable.
4. Spread the tomato puree on the dough and cover it with the tomatoes.

Season to taste and top with the remaining ingredients. Finally arrange the olives on the pizza and sprinkle on the cheese.

The recipe yields approx. 0.9 kg.

FRESH PIZZA 

GB-40

## Snacks

France

### Onion tart

Tarte à l'oignon

Total cooking time: approx. 26-32 minutes  
Utensils required: bowl with lid (2 litres)

#### Ingredients

15 g yeast  
185 g flour  
60 ml oil  
1 tsp salt  
30 g margarine or butter  
600 g onions, chopped  
2 eggs  
150 g crème fraîche  
salt & paprika  
freshly milled nutmeg  
50 g streaky bacon  
marjoram or thyme

#### Preparation

1. Crumble the yeast and dissolve in 75 ml of lukewarm water. Put the flour, oil, salt and dissolved yeast into a bowl and knead it to a smooth dough. Place in the microwave oven.

approx. 2 min.  90 W

- Then let the dough stand for 10-15 minutes.
2. Divide the margarine in another bowl and sweat the onions until transparent. Stir halfway through the cooking period.

7-9 min.  900 W

3. Allow the onions to cool and then pour off the liquid. Gradually mix in the eggs and the crème fraîche. Season with salt, pepper and nutmeg.
4. Roll out the dough on a floured surface the size of the turntable. Grease the turntable. Place the dough on the turntable and fold up the edges. Leave the dough for a further 10 minutes.
5. Cut the bacon into small cubes. Spread the onion mixture over the dough and dot with cubes of bacon, sprinkle over marjoram or thyme, and cook.

1. 8-9 min.  630 W

2. 5-6 min. 

3. 4-5 min. 

Austria

### Baked spinach

Spinatauflauf

Total cooking time: approx. 37-42 minutes  
Utensils required: bowl with lid (1 litre size)  
shallow oval oven-proof dish  
(approx. 25 cm long)

#### Ingredients

2 tbsp butter or margarine (20 g)  
1 onion (50 g), finely chopped  
600 g leaf spinach, frozen  
salt & pepper  
nutmeg  
garlic powder  
1 tsp butter or margarine to grease dish  
400 g boiled potatoes, sliced  
200 g cooked ham, diced  
3 eggs  
100 ml cream (crème fraîche)  
100 g grated cheese (e.g. gouda)  
paprika

#### Preparation

1. Divide the butter on the bottom of the bowl, add the chopped onion, cover and lightly cook.

2-3 min.  900 W

2. Add the spinach, cover the bowl and microwave. Stir once or twice during cooking.

12-14 min.  900 W

- Pour off the liquid and season the spinach.
3. Grease the oven-proof dish. Place the slices of potato, the diced ham and the spinach alternately in the dish in layers, finishing with potatoes.
  4. Blend the eggs with the cream, season and pour over the vegetables. Sprinkle grated cheese over the dish and top with a sprinkling of paprika.

23-25 min.  450 W + 220°C

Allow the dish to stand for approx. 10 minutes after cooking.

#### Tip:

You can vary the ingredients for this dish according to taste, e.g. with broccoli, salami or pasta.

## Recipes

**Vegetables, Noodles, Rice and Pasta**

Germany

**Baked broccoli and potato with mushrooms***Broccoli-Kartokkelauf mit Champignons*

Total cooking time: approx. 34-38 minutes  
 Utensils required: bowl with lid (2 litres size)  
 round oven-proof dish (dm. 26 cm)

**Ingredients**

350 g potatoes, peeled and optionally halved  
 350 g broccoli, in florets  
 6 tbsp water (60 ml)  
 1 tsp butter or margarine to grease dish  
 350 g mushrooms, sliced  
 1 tbsp parsley, finely chopped  
 salt & pepper  
 3 eggs  
 120 ml cream  
 120 ml milk  
 salt & pepper  
 nutmeg  
 80 g grated gouda cheese

**Preparation**

- Put the potatoes and broccoli in the bowl. Add the water, cover and microwave. Stir once during cooking.

11-13 min.  900 W

- Grease the oven-proof dish. Put in the broccoli, the mushrooms and the potatoes alternately in layers. Sprinkle over parsley and season with salt and pepper.
- Combine the eggs with the liquid and seasoning and pour over the vegetables. Sprinkle the cheese over the dish and microwave.

23-25 min.  450 W + 220°C

Allow the dish to stand for approx. 10 minutes after cooking.

Germany

**Baked courgettes and pasta***Zucchini-Nudel-Auflauf*

Total cooking time: approx. 32-37 minutes  
 Utensils required: bowl with lid (2 litres size)  
 oven-proof dish  
 (approx. 26 cm long)

**Ingredients**

500 ml water  
 1/2 tsp oil  
 80 g macaroni  
 400 g tinned tomatoes, chopped  
 3 onions (150 g), finely chopped  
 basil, thyme, salt, pepper  
 1 tbsp oil to grease the dish  
 450 g courgettes, sliced  
 150 g sour cream  
 2 eggs  
 100 g grated cheddar cheese

**Preparation**

- Put the water, oil and salt in the bowl, cover and bring to the boil.

3-4 min.  900 W

- Break the macaroni into pieces and add them to the dish. Stir and allow to soak.

9-11 min.  270 W

Drain the pasta and allow to cool.

- Mix the tomatoes with the onions and season well. Add the macaroni and pour over the tomato sauce. Divide the courgette slices on top.
- Beat the sour cream and the eggs and pour over the dish. Sprinkle the grated cheese on top and cook.

1. 19-20 min.  450 W + 220°C

2. 1-2 min. 

Allow the dish to stand for about 5-10 minutes after cooking.



GB-42



**Vegetables, Noodles, Rice and Pasta**

Austria

**Bread dumplings**

Semmelknödel

(for 5 servings)

Total cooking time: approx. 7-10 minutes

Utensils required: bowl with lid (1 litre size)  
6 cups or blancmange moulds**Ingredients**

2 *tblsp* butter or margarine (20 g)  
1 *onion* (50 g), finely chopped  
500 *ml* milk  
200 *g* dried bread cubes  
(from approx. 5 bread rolls)  
3 *eggs*

**Preparation**

1. Cut the bread rolls into small cubes and soak in the milk.
2. Divide the fat on the bottom of the bowl and add the chopped onion. Cover and cook.

1-2 min.  900 W

3. Add the onion to the bread cubes. Beat the eggs, add them and mix well to form a workable paste. If necessary add a little milk.
4. Divide the paste equally into 5 cups or blancmange moulds, cover with microwave foil, arrange on the edge of the turntable and cook.

6-8 min.  900 W

Allow the dumplings to stand for about 2 minutes after cooking. Turn the dumplings into a plate before serving.

Italy

**Oven-baked lasagne**

Lasagne al forno

Total cooking time: approx. 17-21 minutes

Utensils required: bowl with lid (2 litres size)  
shallow square oven-proof dish  
(approx. 20 x 20 x 6 cm)**Ingredients**

300 *g* tinned tomatoes  
50 *g* ham, finely diced  
1 *onion* (50 g), finely chopped  
1 *garlic* clove, crushed  
250 *g* beef mince  
2 *tblsp* tomato puree  
salt & pepper  
oregano  
thyme  
basil  
150 *ml* cream (*crème fraîche*)  
100 *ml* milk  
50 *g* grated parmesan cheese  
1 *tsp* mixed chopped herbs  
1 *tsp* olive oil  
salt & pepper  
nutmeg  
1 *tsp* vegetable oil to grease the dish  
125 *g* lasagne verde (*green sheet pasta*)  
1 *tblsp* grated parmesan cheese (5 g)  
1 *tblsp* butter or margarine

**Preparation**

1. Slice the tomatoes, mix with the diced ham and chopped onion, the garlic, the beef mince and the tomato puree. Season, cover and lightly braise.

6-8 min.  900 W

2. Combine the cream with the milk, parmesan cheese, herbs and oil and season.
3. Grease the oven-proof dish. Lay a third of the pasta on the base of the dish. Cover the pasta with one half of the minced beef and pour on a little of the sauce. Form a layer with the second third of the mince, some sauce and the remainder of the pasta. Finally cover the pasta thoroughly with sauce and top with a sprinkling of parmesan cheese. Dot with flakes of butter and cook on the low rack.

11-13 min.  450 W + 220° C

Allow the lasagne to stand about 5 to 10 minutes after cooking.

Recipes

**Vegetables, Noodles, Rice and Pasta**

Italy

**Tagliatelle with cream and basil***Tagliatelle alla panna e basilico* (for 2 servings)

Total cooking time: approx. 16-23 minutes  
 Utensils required: bowl with lid (2 litres size)  
 round soufflé dish (dm. app. 20 cm)

**Ingredients**

1 l water  
 1 tsp salt  
 200 g tagliatelle (ribbon pasta)  
 1 garlic clove  
 15-20 basil leaves  
 200 g cream (crème fraîche)  
 30 g grated parmesan cheese  
 salt & pepper

**Preparation**

- Put the water and salt in the bowl, cover and bring to the boil.

8-10 min.  900 W

- Add the pasta, bring once more to the boil and simmer.

1. 1-2 min.  900 W

2. 6-9 min.  270 W

- Meanwhile rub the soufflé dish with the clove of garlic. Cut up the basil leaves. Set some of the basil aside for garnishing.
- Drain the pasta thoroughly. Stir in the cream and sprinkle the basil on the pasta.
- Add the parmesan cheese, salt and pepper. Put the mixture into the soufflé dish and give it a stir. Reheat the pasta.

1-2 min.  900 W

Finally garnish with the remaining basil.

Austria

**Cauliflower with cheese sauce***Karfiol mit Käsesauce*

Total cooking time: approx. 18-21 minutes  
 Utensils required: bowl with lid (2 litres size)  
 bowl with lid (1 litre size)

**Ingredients**

800 g cauliflower (1 head)  
 1 cup of water (150 ml)  
 125 ml milk  
 125 ml cream  
 75-100 g cooking cheese  
 2-3 tbsp light sauce binder (20-30 g)

**Preparation**

- Cut through the stalks of the cauliflower. Place the cauliflower upright in one of the bowls. Add water, cover and microwave.

15-17 min.  900 W

Let the cauliflower stand covered for several minutes and then drain the liquid.

- Put the milk and the cream in the other bowl. Grate the cheese coarsely and add to the bowl. Cover and microwave.

2-3 min.  900 W

- Stir in the sauce binder, cover and reheat.

app. 1 min.  900 W

Stir the sauce thoroughly and pour over the cauliflower.

**Tip:**

You can sprinkle the cauliflower with chopped parsley before serving.

France

**Dauphine potatoes***Gratin dauphinois*

Total cooking time: approx. 28-30 minutes  
 Utensils required: shallow oval oven-proof dish  
 (approx. 26 cm long)

**Ingredients**

1 tbsp butter or margarine  
 500 g potatoes, peeled and thinly sliced  
 salt & pepper  
 2 garlic cloves, crushed  
 300 g cream (crème fraîche)  
 150 ml milk  
 50 g grated cheese (gouda)

**Preparation**

- Divide the butter in the dish. Put in the potato slices in layers. Season each layer with salt, pepper and garlic.
- Blend the cream and the milk and pour over the potatoes. Sprinkle with cheese and bake on the bottom grill.

28-30 min.  450 W + 160° C

Allow to stand for 10 minutes after cooking.



GB-44



## Vegetables, Noodles, Rice and Pasta



Switzerland

### Ticino risotto

Tessiner risotto

Total cooking time: approx. 20-25 minutes  
 Utensils required: bowl with lid (2 litres size)

#### Ingredients

- 50 g streaky bacon
- 2 tbsp butter or margarine (20 g)
- 1 onion (50 g), finely chopped
- 200 g round-grain (Arborio) rice
- 400 ml meat stock
- 70 g Brienzi cheese, grated (an alternative is grated Emmental cheese)
- pinch of saffron
- 1 salt & pepper

#### Preparation

1. Dice the bacon. Spread the butter on the bottom of the bowl. Put in the chopped onion and the bacon, cover and lightly braise.

2-3 min.  900 W

2. Add the rice and meat stock, bring to the boil and allow to simmer.

1. 3-5 min.  900 W

2. 15-17 min.  270 W

Leave the rice to stand for about 2 minutes after cooking.

3. Mix in the cheese and the saffron and taste.

#### Tip:

Suitable accompaniments are braised chanterelles or button mushrooms and a mixed salad.

Switzerland

### Kohlrabi in dill sauce

Kohlrabi in Dillsauce

(2 servings)

Total cooking time: approx. 10<sup>1</sup>/<sub>2</sub>-11<sup>1</sup>/<sub>2</sub> minutes  
 Utensils required: 2 bowls with lids (1 l. size)

#### Ingredients

- 400 g kohlrabi, sliced (approx. 2 heads)
- 4-5 tbsp water
- 2 tbsp butter or margarine (20 g)
- 150 ml cream (crème fraîche)
- salt, pepper, nutmeg & paprika
- a few drops of lemon juice
- 1 bunch of dill, finely chopped

#### Preparation

1. Put the kohlrabi with the water in one of the bowls, cover and cook. Stir once during cooking.

9-10 min.  900 W

Drain the liquid.

2. Divide the butter in the other bowl, add the cream and heat uncovered. Do not let it boil!

ca. 1<sup>1</sup>/<sub>2</sub> min.  900 W

3. Season the sauce to taste with the salt, spice and lemon juice. Fold in the dill and pour the sauce over the kohlrabi. Leave the kohlrabi to stand for about 2 minutes after cooking.

#### Tip:

Salsify can be substituted for the kohlrabi.



GB-45

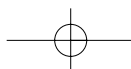

Recipes

**Cakes, Bread, Desserts and Drinks**

Great Britain

**Cherry cake**

Total cooking time: approx. 25-27 minutes  
 Utensils required: flan ring (dm. approx. 28 cm)

**Ingredients**

1 tsp butter or margarine to grease tin  
 200 g butter  
 200 g sugar  
 3 eggs  
 200 g flour  
 1 level tsp baking powder  
 1 glass morello cherries (350 g)

**Preparation**

- Grease the tin.
- Soften the butter in a mixing bowl.

1/2-1 min.  630 W

- Add the sugar and stir it in until it has completely dissolved and no longer sounds crunchy. Gradually stir in the eggs. Mix the flour and baking powder and add it a spoonful at a time.
- Drain the cherries in a sieve.
- Spread the cake mix evenly in the flan ring. Arrange the cherries evenly on top. Place the cake on turntable and bake.

24-26 Min.  270 W + 180° C

Germany

**Cherry layer cake**

Kirschenmichel

Total cooking time: approx. 23-25 min.  
 Utensils required: deep round oven-proof dish (dm. approx. 20 cm)

**Ingredients**

4 stale bread rolls (160 g)  
 375 ml milk  
 60 g butter or margarine  
 8 tbsp sugar (80 g)  
 4 egg yolks  
 1 tbsp flour  
 30 g chopped almonds  
 grated lemon peel  
 4 egg whites  
 1 tsp butter or margarine to grease dish  
 500 g stoned sour cherries  
 2 tbsp breadcrumbs  
 1 tbsp butter or margarine

**Preparation**

- Cut the bread into small pieces and soak in the milk.
- Beat the butter, sugar and egg yolks to a creamy consistency with a hand mixer. Soak and squeeze out the bread rolls. Add them with the flour, almonds, lemon peel and the bread rolls and stir.
- Beat the egg whites until stiff and fold them in.
- Grease the dish. Put the bread mixture and the drained cherries alternately in layers in the dish, finishing with the bread mixture.
- Sprinkle breadcrumbs over the dish and dot with flakes of butter and cook.

23-25 min.  450 W + 200° C

Allow the dish to stand for about 5-10 minutes after cooking.



GB-46



## Cakes, Bread, Desserts and Drinks



Germany

### Advocaat gateau

Eierlikör-Torte

Total cooking time: approx. 21-23 minutes  
 Utensils required: flan ring (dm. approx. 28 cm)

#### Ingredients

100 g cooking chocolate  
 5 eggs  
 100 g butter or margarine  
 100 g sugar  
 1 pack. vanilla sugar  
 200 g ground hazel nuts  
 1 pack. baking powder  
 1 tbsp rum

#### Topping:

400 g cream  
 2 tbsp sugar  
 1 pack. cream setting agent  
 4-5 tbsp advocaat  
 30 g chocolate strands

#### Preparation

1. Line the baking tin with greaseproof paper.
2. Finely grate the cooking chocolate. Separate the eggs and beat the egg whites until they form stiff peaks.
3. Soften the butter in a mixing bowl.

1 min. 450 W

4. Add the sugar and vanilla sugar to the butter and stir until creamy. Gradually mix in the egg yolks. Stir the chocolate, hazel nuts, baking powder and rum into the mixture. Carefully fold in the beaten white of egg.
5. Spread the mix evenly in the baking tin. Place the cake on turntable and bake.  
 (The recipe yields approx. 0.8 kg of cake mix.)

AUTO COOK "CAKE"

Allow the cake to cool.

6. Beat the cream with the sugar and setting agent until stiff. Carefully fold the advocaat into the cream mixture. Spread the mixture evenly over the cake and finish with a sprinkling of chocolate strands.
7. Allow the gateau to cool before serving.



France

### Apple tart with Calvados

Tarte aux pommes avec calvados About 12-16 portions

Total cooking time: approx. 29-30 minutes  
 Utensils required: flan ring (dm. approx. 28 cm)

#### Ingredients

200 g flour  
 1 tsp baking powder  
 100 g sugar  
 1 pack. vanilla sugar  
 1 pinch salt  
 1 egg  
 3-4 drop bitter almond oil  
 125 g butter  
 1 tsp butter or margarine to grease tin  
 50 g ground hazel nuts  
 600 g apples (russets x 3-4)  
 cinnamon  
 2 eggs  
 1 pinch salt  
 4 tbsp sugar  
 1 pack. vanilla sugar  
 4 tbsp Calvados (apple liqueur)  
 1 1/2 tbsp cornflour  
 125 g double cream  
 icing sugar for dusting

#### Preparation

1. Mix the flour with the baking powder. Add the sugar, vanilla sugar, salt, the egg, bitter almond oil and butter and knead to a paste with the kneading hook of a hand mixer. Cover the pastry dough and leave in a cool place for about 30 minutes.
2. Line the tin with greaseproof paper. Roll out the pastry dough between two sheets of foil and place it in the tin. Form an edge to the pastry dough approx. 3 cm high.
3. Distribute the hazel nuts over the pastry shell.
4. Peel the apples, cut them in quarters, remove the core and cut them in slices. Arrange the slices to overlap each other on top of the hazel nuts and lightly dust them with cinnamon.
5. Separate the eggs. Beat the egg whites until stiff, gradually trickling in a pinch of salt and 1 tbsp sugar. Stir the egg yolk, the remaining sugar and the vanilla sugar until creamy. Add Calvados, cornflour and double cream and mix them in. Fold in the beaten egg whites and spread the mixture evenly over the apple slices. Place the tart on turntable and bake.  
 (The recipe yields approx. 1.3 kg).

MORE (▲) key and  
 AUTO COOK "CAKE"

#### Tip:

Allow the tart to cool in the tin and dust it with icing sugar.



GB-47

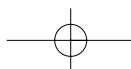

Recipes

**Cakes, Bread, Desserts and Drinks**

Austria

**Hazelnut cake**

Nusskuchen

Total cooking time: approx. 22-27 minutes  
 Utensils required: square baking tin 30 cm

**Ingredients**

250 g butter or margarine  
 175 g sugar  
 1 pack. vanilla sugar  
 4 eggs  
 200 g ground hazel nuts  
 1 tbsp almond liqueur  
 250 g flour  
 2 level tsp baking powder  
 100 g chocolate glaze with a few hazel nuts  
 1 tsp butter or margarine to grease the tin  
 breadcrumbs

**Preparation**

- Grease the tin and sprinkle it with breadcrumbs.
- Put the butter in a mixing bowl to soften.

1 min.  900 W

- Add the sugar and vanilla sugar to the butter and mix to a creamy consistency. Put in the eggs, stirring well as each one is added. Fold in the ground nuts and the liqueur. Mix the flour and the baking powder together and fold them in. Spread the mixture evenly in the baking tin. Place the cake on the turntable and bake.

1. 11-13 Min.  270 W + 200° C

2. 7-9 Min.  270 W + 160° C

- Allow the cake to cool for about 5 minutes. Put the glaze in a bowl and melt it.

3-4 min.  270 W

- Coat the cake with the glaze and garnish with hazel nuts.



Holland

**Double crust apple tart**

Total cooking time: approx. 24-25 minutes  
 Utensils required: flan ring (dm. approx. 28 cm)

**Ingredients**

90 g butter or margarine  
 90 g sugar  
 1 pack. vanilla sugar  
 1 tbsp lemon peel (natural)  
 1 pinch salt  
 2 eggs  
 200 g flour  
 1/2 pack. baking powder  
 4-5 medium-sized apples  
 lemon juice  
 50 g sugar  
 1 tsp cinnamon  
 50 g rum raisins  
 1 egg yolk  
 1 tbsp milk

**Preparation**

- Cream the butter for about half a minute in the mixer at the highest setting.
- Fold in the sugar, vanilla sugar, lemon peel and salt to give a creamy consistency. Fold in the eggs one by one. Combine the flour and the baking powder and fold it in.
- Line the flan ring with greaseproof paper and fill it with 2/3 of the pastry dough.
- Peel the apples, cut them in quarters and remove the cores. Cut into thin slices and sprinkle with lemon. Mix in the sugar and cinnamon and leave to stand for about 10 minutes. Add the raisins and cover the pastry dough with the fruit.
- Combine the remaining pastry dough and 50 g of the flour and roll it out to the size of the flan ring. Lay it on the apple filling and press it down lightly. Prick the pastry top with a fork several times.
- Beat the egg yolk with the milk and brush the pastry top with it.  
(The recipe yields approx. 1.1 kg).
- Place the tart on the turntable and cook.

AUTO COOK "CAKE" 



## Cakes, Bread, Desserts and Drinks

Switzerland

### Carrot cake

Möhrentorte

Total cooking time: approx. 22-24 minutes

Utensils required: round baking tin  
(dm. approx. 28 cm)

#### Ingredients

5 egg yolks  
250 g sugar  
250 g carrots, finely grated  
juice of a lemon  
250 g ground almonds  
80 g flour  
1 tbsp baking powder  
5 egg whites

#### Preparation

- Line the tin with greaseproof paper.
- Cream the egg yolks and sugar with a hand mixer. Add the carrots, lemon juice and almonds. Combine the flour and the baking powder, add it and give it a good stir.
- Beat the egg white until stiff and carefully fold it in. Put the mixture in the baking tin, place it on the turntable and bake.  
(The recipe yields approx. 1.1 kg).

AUTO COOK "CAKE"



- Allow to cool in the tin for 5 minutes after baking.

France

### Pear tart

Tarte aux poires

about 12-14 servings

Total cooking time: approx. 17-22 minutes

Utensils required: round baking tin (dm. app. 28 cm)  
bowl with lid (2 litres size)  
small bowl with lid

#### Ingredients

150 g flour  
75 g butter or margarine  
30 g icing sugar  
1 pinch salt  
1 egg  
1 tsp butter or margarine  
250 ml milk  
1 pinch salt  
2 egg yolks  
20 g sugar  
1/2 pack. vanilla sugar  
1 tbsp cornflour  
540 g tinned pears, drained  
120 g gooseberry jelly  
1 tbsp candied fruits  
1 tbsp almond flakes

#### Preparation

- Knead together the flour, butter, icing sugar, salt and egg with a kneading hook in a hand mixer. Cover and leave in a cool place for 30 minutes.
- Grease the baking tin. Roll out the pastry dough and place it in the tin. Turn up the edges of the pastry and prick it several times with a fork. Bake on the turntable.

1. 8-10 min. 270 W + 200° C

2. 5-7 min. 200° C

- Take the pastry case out of the tin and let it cool on a rack.
- Heat the milk and salt in a covered bowl.

app. 2 min. 900 W

- Stir the egg yolk with the sugar and vanilla sugar to a light creamy consistency. Mix in the cornflour. Slowly pour in the hot milk. Pour the mixture back into the bowl, cover and microwave. Stir during and after cooking.

1-2 min. 900 W

- Spread the cream over the pastry case. Arrange the drained pears on top. Put the gooseberry jelly in the small bowl, cover and heat.

app. 1 min. 900 W

- Drip the hot jelly over the pears and garnish with the candied fruits and almond flakes.

#### Tip:

Do not fill the pastry case until shortly before serving to avoid it becoming soggy.



GB-49

Recipes

**Cakes, Bread, Desserts and Drinks**

Denmark

**Party bread**

Total cooking time: 18-20 minutes

Utensils needed: pizza tin (dm. approx. 30 cm)

**Ingredients**

190 g wheat flour  
 190 g rye flour  
 40 g yeast  
 1/4 l buttermilk  
 125 g quark  
 1 1/2 tsp salt  
 ca. 50 ml buttermilk  
 poppy, sesame and caraway seeds

**Preparation**

1. Make a bread dough from the above ingredients. Cover it and let it rise for about 30 minutes.
2. Line the pizza tin with greaseproof paper.
3. Knead the dough and divide it into 2-3 rolls. Cut into 19 similarly sized pieces and shape them into bread rolls. Place one roll at the centre and the others in a circular pattern around it. Brush the rolls with buttermilk and sprinkle over alternately with poppy seeds, sesame seeds and caraway seeds.
4. Let the dough prove for another 30 minutes or so.
5. Preheat the oven to 230° C. Place the baking tin on the turntable in the oven and bake.

---

 18-20 min.  90 W + 230° C
 

---



Great Britain

**Raisin bread**

Total cooking time: approx. 25-29 minutes

Utensils required: rectangular baking tin (approx. 25 x 11 x 8 cm)

**Ingredients**

15 g fresh yeast  
 1 tbsp sugar  
 275 ml lukewarm water  
 450 g wheat flour  
 1 tsp salt  
 25 g margarine or butter  
 100 g raisins  
 200 ml water  
 2 tbsp rum (or a few drops of rum essence)  
 1 tsp butter to grease the baking tin

**For coating**

1 egg yolk  
 1 tbsp water

**Preparation**

1. Dissolve the yeast in the lukewarm water.
2. Mix the flour and salt in a large bowl. Make a depression in the centre and pour in the yeast mixture. Stir in a little flour. Dot the flour around the edges with flakes of butter. Work all the ingredients into a smooth dough.
3. Cover the bowl with a tea-towel and leave to rise in a warm place for 30 minutes.
4. Meanwhile wash the raisins and soak them for 5-10 minutes in water and dry them thoroughly. Stir the rum into the raisins and let it permeate them. Thoroughly knead the dough once more, working the raisins into it.
5. Put the bread dough in the greased baking tin, cover it and let it prove in a warm spot for 15 minutes.
6. Combine the egg yolk and the water. Make a single cut lengthways in the top of the raisin bread and brush with the egg yolk mixture.
7. Place the tin on the turntable and cook.

---

 1. 21-23 min.  90 W + 200° C
 

---



---

 2. 4-6 min.  200° C
 

---



GB-50



## Cakes, Bread, Desserts and Drinks

Germany

### Multigrain bread

Dreikornbrot

Total cooking time: 24-26 minutes

Utensils required: pizza tin (dm. approx. 30 cm)

#### Ingredients

100 g rye flour  
 550 g wheat flour  
 100 g linseed  
 100 g sesame seeds  
 60 g fresh yeast  
 1/2 l water  
 1 tbsp salt

#### Preparation

1. Make bread dough from the ingredients and let it rise for approx. 30 minutes.
2. Lightly grease the pizza tin and dust with a little flour.
3. Thoroughly knead the dough once more and form it into an elongated shape. Place it on the pizza tin, cover it and let it prove for approx. 30-40 minutes. Preheat the oven to 230<sup>o</sup> C.
4. Brush the bread with a little water and prick it several times with a fork.
5. Place the bread on the low rack in the preheated oven.

24-26 min.  90 W + 230° C

Allow the bread to cool before slicing.



Denmark

### Fruit jelly with vanilla sauce

Rødgrød med vanille sous

Total cooking time: approx. 8-12 minutes

Utensils required: bowl with lid (2 litres size)

#### Ingredients

150 g redcurrants, washed and sorted  
 150 g strawberries, washed and sorted  
 150 g raspberries, washed and sorted  
 250 ml white wine  
 100 g sugar  
 50 ml lemon juice  
 8 sheets of gelatine  
 300 ml milk  
 pith of half a vanilla pod  
 30 g sugar  
 15 g cornflour

#### Preparation

1. Retain some of the fruit for garnishing. Puree the remaining berries with the white wine. Put the mixture in the bowl, cover and heat.

5-7 min.  900 W

2. Fold in the sugar and lemon juice.
2. Soak the gelatine sheets in cold water for approx. 10 minutes, then take them out and squeeze them dry. Stir the gelatine into the hot fruit puree until it dissolves. Put the jelly in the refrigerator to set.
3. For the vanilla sauce pour the milk into a bowl. Slit open the vanilla pod and scrape out the pith.. Stir the vanilla pith, the sugar and the cornflour into the milk, cover and microwave. Stir it again once during and after cooking.

3-5 min.  900 W

4. Turn the jelly out on to a plate and garnish with the whole fruits. Serve with the vanilla sauce.

#### Tip:

An excellent accompaniment to the fruit jelly is chilled cream or yoghurt.



Recipes

**Cakes, Bread, Desserts and Drinks**

Germany

**Semolina pudding with raspberry sauce***Griessflammeri mit Himbeersauce*

Total cooking time: approx. 15-20 minutes  
 Utensils required: bowl with lid (2 litres size)

**Ingredients**

500 ml milk  
 40 g sugar  
 15 g chopped almonds  
 50 g semolina  
 1 egg yolk  
 1 tbsp water  
 1 egg white  
 250 g raspberries  
 50 ml water  
 40 g sugar

**Preparation**

- Put the milk, sugar and almonds into the bowl, cover and heat.

3-5 min.  900 W

- Add the semolina and stir. Cover and microwave. Stir once during cooking.

10-12 min.  270 W

- Mix the egg yolk with the water in a cup and fold into the hot semolina. Beat the egg white until stiff and lightly fold it in. Transfer the pudding to small bowls.
- For the sauce wash the raspberries, dry carefully and put into a bowl with water and sugar. Cover and heat.

2-3 min.  900 W

- Puree the raspberries and serve either hot or cold with the semolina pudding.

Sweden

**Pistachio rice with strawberries***Pistaschris med zordgubbe*

Total cooking time: approx. 23-30 minutes  
 Utensils required: bowl with lid (2 litres size)

**Ingredients**

125 g long grain rice  
 150 ml milk  
 175 ml water  
 1 vanilla pod  
 1 salt  
 50 g sugar  
 250 g strawberries  
 40 g sugar  
 40 ml Cointreau (orange liqueur, 40 vol - %)  
 200 ml cream  
 1 egg white  
 50 g pistachio

**Preparation**

- Put the rice and the liquid in the bowl. Slit open the vanilla pod and add it to the rice with the salt and sugar. Cover and microwave. Stir once during cooking.

1. 3-5 min.  900 W

2. 20-25 min.  270 W

Leave the rice to stand for 5 minutes after cooking.

- Cut the strawberries in half and mix with sugar and the orange liqueur.
- Remove the vanilla pod from the rice and cool the rice by stirring it in a bain-marie. Beat the cream and the egg white separately until stiff. Fold first the pistachios, then the cream and finally the egg white into the cold rice.
- Put the rice in a large bowl, make a depression in the rice and fill it with strawberries.



GB-52

## Cakes, Bread, Desserts and Drinks

France

### Pears in chocolate sauce

Poires au chocolat

Total cooking time: approx. 8-14 minutes  
 Utensils required: bowl with lid (2 litres size)  
 bowl with lid (1 litre size)

#### Ingredients

4 pears (500 g)  
 60 g sugar  
 1 pack. vanilla sugar (10 g)  
 1 tbsps pear liqueur, 30 vol - %  
 150 ml water  
 130 g plain chocolate  
 100 g cream (crème fraîche)

#### Preparation

1. Peel the pears whole.
2. Put the sugar, the vanilla sugar, the liqueur and the water in the larger bowl and stir. Cover and heat.

1-2 min.  900 W

3. Lay the pears in the liquid, cover and microwave.

6-10 min.  900 W

Remove the pears from the liquor and leave to cool.

4. Put 50 ml of the pear liquor in the smaller bowl. Add the grated chocolate and the cream and stir. Cover and heat.

1-2 min.  900 W

5. Give the sauce a good stir. Pour it over the pears and serve.

#### Tip:

Can be served with a scoop of vanilla ice-cream.

Austria

### Chocolate with Cream

"Schokolade mit Schlagobers"

makes 1 serving

Total cooking time: approx. 1 minute  
 Utensils: Large cup (200 ml content)

#### Ingredients

150 ml Milk  
 30 g Block chocolate, shredded  
 30 ml Heavy whipping cream  
 Chocolate granules

#### Preparation

1. Pour milk into cup. Add block chocolate to the milk, stir and heat. Stir occasionally during heating.

approx. 1 min.  900 W

2. Beat cream until stiff, place on top of chocolate, garnish with chocolate granules and serve.

Netherlands

### Fiery potion

Vuurdrank

10 servings

Total cooking time: approx. 8-10 minutes  
 Utensils required: bowl with lid (2 litres size)

#### Ingredients

500 ml white wine  
 500 ml dry red wine  
 500 ml rum, 54 vol - %  
 1 fresh orange  
 3 sticks of cinnamon  
 75 g sugar  
 10 tsp rock candy

#### Preparation

1. Pour the alcohol into the bowl. Thinly peel the orange and add the orange peel to the alcohol with the cinnamon and the sugar. Cover and heat.

8-10 min.  900 W

2. Remove the orange peel and the cinnamon. Put a teaspoonful of rock candy into each grog glass, add some of the fiery potion and serve.

- SEULEMENT VALIDE POUR L'ALLEMAGNE ET L'AUTRICHE • SLECHTS GELDIG VOOR DUITSLAND EN OOSTENRIJK •
- SOLTANTO VALIDO PER LA GERMANIA E L'AUSTRIA • SOLAMENTE VÁLIDO PARA ALEMANIA Y AUSTRIA •
- ONLY VALID FOR GERMANY AND AUSTRIA •

#### Vorgehensweise bei Vorliegen eines Produktmangels:

- Wurde Ihr Gerät durch einen Fachbetrieb mit einem von Sharp genehmigten Einbaurahmen oder rahmenlos ein-/untergebaut, können Sie die unter Ziffer 1. aufgeführten Garantieansprüche im Rahmen des Quick 48 Vor-Ort-Service geltend machen und sich direkt an den KUNDEN-SERVICE wenden oder Sachmängel gegenüber Ihrem Verkäufer geltend machen.
- Für alle übrigen Geräte können Sie die unter Ziffer 2. aufgeführten Garantieansprüche ohne Quick 48 Stunden Vor-Ort-Service oder Sachmängel gegenüber Ihrem Verkäufer geltend machen.

**DER SHARP KUNDEN-SERVICE**



**Sie erreichen die Service-Hotline:**  
 montags bis freitags zwischen 8 und 18 Uhr  
 in Österreich: **0820 - 240 496** (€ 0,145/Min.)  
 in Deutschland: **0180 - 523 46 74**  
 (€ 0,14/Min. aus dem Festnetz der T-Com)

## 1. Garantie mit Quick 48 Stunden Vor-Ort-Service Gilt für Deutschland und Österreich

### Haushalts-Mikrowellengeräte im Quick 48 Stunden Vor-Ort-Service

#### Sehr geehrter Sharp Kunde,

alle ein-/ untergebauten Haushalts-Mikrowellengeräte, die durch einen Fachbetrieb fachgerecht mit einem von SHARP genehmigten Einbaurahmen oder rahmenlos ein-/ bzw. untergebaut worden sind, werden im Quick 48 Vor-Ort-Service abgewickelt. Die in dieser Garantie beschriebenen Ansprüche stehen Ihnen zusätzlich neben den gesetzlichen Sachmängelansprüchen gegen Ihren Verkäufer zu.

**Umfang der Garantie:** Sollte Ihr Mikrowellengerät trotz sorgfältiger Herstellung und Endkontrolle einen Mangel aufweisen, können Sie innerhalb der Garantiezeit, Garantieleistungen gegen Sharp Electronics (Europe) GmbH in Anspruch nehmen. Diese stehen Ihnen zu, wenn ein herstellungsbedingter Material- und/oder Verarbeitungsmangel (nachfolgend „Mangel“) bei dem Mikrowellengerät oder Teilen davon - mit Ausnahme der Garraum-Glühlampe - innerhalb von 24 Monaten auftritt. Die Garantie umfasst nicht Mängel, die durch unsachgemäße Behandlung, Bedienungsfehler oder durch Fremdeinwirkung entstanden sind. Transportschäden bei Neugeräten müssen Sie bei Ihrem Verkäufer geltend machen. Die Garantiefrist von 24 Monaten beginnt mit dem Tag, an dem Sie das fabrikneue Gerät von einem Händler gekauft haben. Die Erbringung von Garantieleistungen verlängert nicht die Garantiezeit.

**Garantieleistungen:** Sharp Electronics (Europe) GmbH erfüllt seine Garantiepflichtungen für Mängel durch kostenlose Reparatur und einen **Quick 48 Stunden Vor-Ort-Service**. Etwa anfallende Transportkosten innerhalb Deutschlands und Österreich übernehmen wir.

Im Quick 48 Stunden Vor-Ort-Service werden alle Reklamationen, die montags bis freitags zwischen 8:00 und 18:00 Uhr beim Quick 48 Deutschland, **Tel.: 0180 / 5 23 46 74** \*(€ 0,14/Min) und in Österreich **Tel.: 0820 / 240 496** \*(€ 0,145/Min) eingehen, ab dem darauffolgenden Werktag gerechnet, im Regelfall innerhalb 48 Stunden bei Ihnen im Vor-Ort-Service repariert.

**Geltendmachung der Garantie:** Der Mangel des Gerätes muss innerhalb der Garantiefrist unter Angabe des Kaufdatums, der Modellbezeichnung und der Seriennummer des Gerätes unter den oben aufgeführten Telefonnummern geltend gemacht werden. Bei der Vor-Ort-Reparatur ist dann der Kaufbeleg, aus dem sich das Kaufdatum, die Modellbezeichnung und die Seriennummer des Gerätes ergibt, vorzulegen.

#### Achtung:

Wird dieser Service für von Ihnen selbst ein-/untergebaute Geräte in Anspruch genommen, sind für Aus-/und Einbau, Fahrzeit und Km die entstehenden Kosten von Ihnen zu tragen!

Bitte erkundigen Sie sich vor Anforderung des Kundendienstes bei diesem über die anfallenden Kosten. Den für Sie nächstgelegenen Kundendienst nennt Ihnen gern unsere o.g. Hotline.

#### Als Nachweis für Sachmängel-/ Garantiarbeiten dient Ihr Kaufbeleg / Rechnung.

Selbstverständlich können Sie unseren QUICK 48 Vor-Ort-Service für Mikrowellengeräte auch nach Ablauf der Verjährungsfristen für Sachmängel-/Garantiefristen in Anspruch nehmen, dann jedoch gegen Aufwandsberechnung des jeweiligen Kundendienstes.

**Garantiegeber: SHARP Electronics (Europe) GmbH, Sonninstraße 3, 20097 Hamburg**  
[www.sharp.de](http://www.sharp.de)

• SEULEMENT VALIDE POUR L'ALLEMAGNE ET L'AUTRICHE • SLECHTS GELDIG VOOR DUITSLAND EN OOSTENRIJK •  
 • SOLTANTO VALIDO PER LA GERMANIA E L'AUSTRIA • SOLAMENTE VÁLIDO PARA ALEMANIA Y AUSTRIA •  
 ONLY VALID FOR GERMANY AND AUSTRIA •

#### Vorgehensweise bei Vorliegen eines Produktmangels:

- Wurde Ihr Gerät durch einen Fachbetrieb mit einem von Sharp genehmigten Einbaurahmen oder rahmenlos ein-/untergebaut, können Sie die unter Ziffer 1. aufgeführten Garantieansprüche im Rahmen des Quick 48 Vor-Ort-Service geltend machen und sich direkt an den KUNDEN-SERVICE wenden oder Sachmängel gegenüber Ihrem Verkäufer geltend machen.
- Für alle übrigen Geräte können Sie die unter Ziffer 2. aufgeführten Garantieansprüche ohne Quick 48 Stunden Vor-Ort-Service oder Sachmängel gegenüber Ihrem Verkäufer geltend machen.

## 2. Garantie ohne Quick 48 Stunden Vor-Ort-Service

### Gilt für Deutschland und Österreich

#### Haushalts - Mikrowellengeräte

**Wichtiger Endkunden – Hinweis:** Serviceabwicklung nur über den Verkäufer. Die in dieser Garantie beschriebenen Ansprüche stehen Ihnen zusätzlich neben den gesetzlichen Sachmängelansprüchen gegen Ihren Verkäufer zu.

#### Sehr geehrter SHARP Kunde,

SHARP-Geräte sind Markenartikel, die mit Präzision und Sorgfalt nach modernen Fertigungsmethoden hergestellt werden. Bei sachgemäßer Handhabung und unter Beachtung der Bedienungsanleitung wird Ihnen Ihr Gerät lange Zeit gute Dienste leisten. Das Auftreten von Fehlern ist aber nie auszuschließen. Sollte Ihr Gerät innerhalb der gesetzlichen oder mit Ihrem Verkäufer vereinbarten Verjährungsfristen für Sachmängel-/Garantiefristen einen Mangel aufweisen und das Gerät wurde **nicht von Ihrem Handelspartner ein-/untergebaut**, so wenden Sie sich bitte an den Verkäufer, bei dem Sie das Gerät erworben haben und geben Sie das defekte Gerät dort ab, denn dieser ist Ihr Ansprechpartner für Sachmängel.

**Umfang der Garantie:** Sollte Ihr Mikrowellengerät trotz sorgfältiger Herstellung und Endkontrolle einen Mangel aufweisen, können Sie innerhalb der Garantiezeit, Garantieleistungen gegen Sharp Electronics (Europe) GmbH in Anspruch nehmen. Diese stehen Ihnen zu, wenn ein herstellungsbedingter Material- und/oder Verarbeitungsmangel (nachfolgend „Mangel“) bei dem Mikrowellengerät oder Teilen davon - mit Ausnahme der Garraum-Glühlampe - innerhalb von 24 Monaten auftritt. Die Garantie umfasst nicht Mängel, die durch unsachgemäße Behandlung, Bedienungsfehler oder durch Fremdeinwirkung entstanden sind. Transportschäden bei Neugeräten müssen Sie bei Ihrem Verkäufer geltend machen. Die Garantiefrist von 24 Monaten beginnt mit dem Tag, an dem Sie das fabrikneue Gerät von einem Händler gekauft haben. Die Erbringung von Garantieleistungen verlängert nicht die Garantiezeit.

#### Garantieleistung:

Sharp Electronics (Europe) GmbH erfüllt seine Garantieverpflichtung für Mängel nach seiner Wahl durch kostenlose Reparatur oder durch Austausch des mangelhaften Gerätes gegen ein mangelfreies. Etwa anfallende Transportkosten innerhalb Deutschlands und Österreich werden von uns übernommen.

#### Geltendmachung der Garantie:

Um die Garantie in Anspruch nehmen zu können, benötigen Sie den Kaufbeleg (Rechnung, Quittung) aus dem sich das Kaufdatum, die Modellbezeichnung und Seriennummer des Gerätes ergibt. Der Mangel des Gerätes muss innerhalb der Garantiefrist von Ihnen gegenüber einem Sharp Service-Partner oder einem autorisierten Händler von Sharp Electronics (Europe) GmbH geltend gemacht werden. Bei weiteren Fragen wenden Sie sich bitte von montags bis freitags zwischen 8:00 und 18:00 Uhr an **unsere Service-Hotline 01805-29 95 29 \*** (€ 0,14/Min)

Selbstverständlich können Sie unseren Kundendienst für Sharp-Mikrowellengeräte auch nach Ablauf der Verjährungsfristen für Sachmängel-/Garantiefristen in Anspruch nehmen, dann jedoch gegen Aufwandsberechnung des jeweiligen Kundendienstes.

**Garantiegeber: SHARP Electronics (Europe) GmbH, Sonninstraße 3, 20097 Hamburg**  
[www.sharp.de](http://www.sharp.de)

• ADDRESSES D'ENTRETIEN • ONDERHOUDSADRESSEN • DIRECCIONES DE SERVICIO • INDIRIZZI DI SERVIZIO •

**BELGIUM** - <http://www.sharp.be>

**En cas d'une réclamation concernant une four a micro-onde SHARP, nous vous prions de vous adresser à votre spécialiste ou à une adresse des SHARP Services suivantes.**

**Indien uw magnetron problemen geeft kunt u zich wenden tot uw dealer of een van de onderstaande Sharp service centra.**

**SHARP ELECTRONICS**, Phone: 0900-10158

**AVTC**, Kleine Winkellaan 54,1853 Strombeek-Bever, 02/2674019 / **ETS HENROTTE**, Rue Du Campinaire 154, 6240 Farciennes, 071/396290 / **Nouvelle Central Radio (N.C.R.)**, Rue des Joncs 15 L-1818 HOWALD, 00352404078 / **Service Center Deinze**, Kapellestraat, 95, 9800 DEINZE, 09-386.76.67

**NEDERLAND** - <http://www.sharp.nl>

**Indien uw magnetron problemen geeft kunt u zich wenden tot uw dealer of naar onderstaand Sharp Service Centrum.**

**SHARP ELECTRONICS BENELUX BV**, - Helpdesk -,Postbus 900, 3990 DW Houten, 0900-7427723

**FRANCE** - <http://www.sharp.fr>

**En cas de réclamation pour les fours micro-ondes SHARP, nous vous prions de vous adresser à votre spécialiste ou à l'une des stations techniques agréées SHARP suivantes:**

**A.A.V.I.**, 1 rue du Mont de Terre, 59818 Lesquin Cedex, 03.20.62.18.98 / **A.A.V.I. (Point d'Accueil)**, 9-11 rue Léon Trulin, 59000 Lille, 03.20.14.96.20 / **A. P. F.**, 1 rue Gracchus Babeuf 93130 Noisy le Sec, 01.48.43.33.08 / **ATELIER ROUSSEL**, 12 Bld Flandre Dunkerque, 56100 Lorient, 02.97.83.07.41 / **BASTIA TELE VIDEO**, Immeuble Le Béarn - Av. de la libération, 20600 Bastia, 04.95.30.81.29 / **C.M.T.S.**, 38 rue des Ormeaux, 75020 Paris, 01.43.70.20.00 / **ELECTRONIC SERVICE PLUS**, 5 bd LOUIS XI - ZI le Menneçon, 37000 Tours, 02.47.77.90.90 / **ELECTRO SERVICE**, 21 rue de Mulhouse- B.P 122, 68313 Illzach, 03.89.62.50.00

**ELECTRO TECH**, 26 rue Cyrano 69003 Lyon, 0892.691.032 / **M.R.T.**, 74 Rue Albert Einstein - 72021 Le Mans Cedex, 02.43.28.52.20 /

**SETELEC**, 23 rue de la L'Argilière 76420 Bihorel 02.35.60.64.39 / **S.T.E.**, 3 chemin de l'Industrie, 06110 Le Cannet Rocheville, 04.93.46.05.00 / **TECH SERVICE**, 15 rue du Château de Ribaute, ZA Ribaute 2, 31130 Quint Fonsegrives, 05.62.57.63.90

**ITALIA** - <http://www.sharp.it>

**Nel caso si verificassero problemi alla vostra apparecchiatura potrete rivolgervi presso un nostro centro di assistenza autorizzato sharp**

**ABRUZZO: C.A.T. di BELLONE**, VIA DELL AREOPORTO,76, TERAMO TE 0861-415745 0861-212117 / **CTR di de Berardinis Vincenzo**, Via G. Cacchi, 18 L'Aquila AQ, 0862-315407 0862-315407 / **CTR di De Berardinis Vincenzo Filiale Avezzano**, Via P. Gobetti, 10 Avezzano AQ, 0862-315407 0862-315407 / **ELETTROVIDEO SNC**, VIA TIBURTINA, 64 PESCARA PE, 085-52020 085-52020 / **MARINANGELI FABRIZIO**, VIA ROCCO CARABBA, 27 L'AQUILA AQ, 0862-310279 0862-322408 / **MARINANGELI FABRIZIO FILIALE DI AVEZZANO**, VIA F.LLI ROSSELLI, 4/A AVEZZANO AQ, 0863-25207 0863-25207

**BASILICATA: LD SERVICE**, via Viviani 2 Potenza PZ, 0971-472578 0971-472578 / **MATERA ELETRONICA SNC DI BUONO E. & C.**, VIA E. MAIORANA, 86/88 MATERA MT, 0835-389310 0835-389310

**CALABRIA: ATER SNC DI DOMENICO & AURELIO CATALANO**, Via Naz. Pentimele 159/a-b Reggio Calabria RC, 0965-47051 0965-47855 / **AUDIOVIDEO SNC DI VARRESE & COSTANTINI**, VIA A. DE GASPERI, 44 VIBO VALENTIA VV, 0963-45571 0963-45572 / **BATTAGLIA SAVERIO**, VIA C. COLOMBO, 85 CATANZARO LIDO CZ, 0961-33824 0961-737337 / **CIANO GIUSEPPE**, VIA SECONDA TRAVERSA, 16 TAURIANOVA RC, 0966-643483 0966-614946 / **COZZUPOLI & CRUPI SNC**, VIA R. CAMPI PRIMO TRONCO, 103 REGGIO CALABRIA RC, 0965-24022 0965-310778 / **EUROTRADING SAS DI AIELLO GAETANO**, VIA TORINO, 121/123 CROTONA KR, 0962-20889 0962-24254 / **S.A.T.E di DODARO & GERVASI SNC**, VIA DEGLI STADI, 28/F COSENZA CS, 0984-482337 0984-482337 / **FAG SERVICE SRL**, VIA MAGENTA, 7 CARIATI MARINA CS, 0983-91843 0983-91943

**CAMPANIA: CONGESTRI' IGNAZIO**, Via G. Bruno, 8 Maddaloni CE, 0823-437704 0823-437704 / **DRF ELETR. di RUBBO**, ZONA INDUSTRIALE PEZZAPIANABENEVENTO BN, 0824-21831 0824-21831 / **ELETRONICA D'ARGENIO**, VIA NAZION. TORRETTE,195 MERCOGLIANO AV, 0825-681590 0825-681590 / **ELETRONICA NASTI DI BRUNO NASTI**, VIA FERRARECCE PAL. ETA 173/175 CASERTA CE, 0823-443099 0823-356006 / **ELETRONICA NASTI DI BRUNO NASTI FILIALE**, VIA CILEA, 52 AVERSA CE 081-8113163 / **ELETRONICA SERVICE SNC**, VIALE EUROPA, 15 CASTELL. DI STABIA NA, 081-8728280 081-8728280 / **ERREDESSE SERVICE SRL**, VIA P. MASCAGNI, 74/76 NAPOLI NA 081-5794825 081-5791899 / **M.C. ELETRONICA SNC DI MILITO M.**, Via dei Mille, 138 Salerno SA 089-330591 06233244764 / **NETTI GIANFRANCO**, Via Magna Grecia, 137/139 Capaccio Scalo SA 0828-730071 0828-730071 / **S.A.RI.EL. SAS**, VIA DIOCLEZIANO, 177 NAPOLI NA 081-7628155 081-7628155 / **SE.RI.EL.CO**, V.DELLE MEDAGLIE D'ORO,163 COSENZA CS, 0984-33152 0984-33152

**EMILIA ROMAGNA: AUDIO VIDEO CENTER SNC**, VIA F. VANDELLI, 23/29 MODENA MO, 059-235219 059-210265 / **BARGELLINI ORAZIO**, VIA LOCCHI, 3/C FORLI' FO, 0543-701446 0543-701446 / **CASALIGGI F.LLI SNC**, VIA BOSELLI, 77 PIACENZA PC, 0523-615740 0523-602014 / **ELECTRON SERVICE SNC**, VIA F.LLI AVENTI, 59 FERRARA FE, 0532-903250 0532-903250 / **MA.PI. SNC DI MAURIZI & CAMPAGNOLI**, VIA T.AZZOLINI, 3 BOLOGNA BO, 051-6414115 051-406848 / **NOVATECNICA**, Via Giovenale, 78/A - Viserba di Rimini Rimini RN, 0541-736361 0541-1831497 / **NUOVA CRT DI AUGUSTO BOERI**, VIA MOLINARI, 40 PIACENZA PC, 0523-592345 0523-592345 / **NUOVA TECNOCOOP**, VIA ARMELLINI 28/30/32 BELLARIA RIMINI RN, 0541-370812 0541-370812 / **PARMASERVICE SAS**, VIA BENEDETTA, 47/A PARMA PR, 0521-2171666 0521-271666 / **RAVSERVICE DI RAVEZZI ANGELO**, VIA AVOGADRO, 6/10 BELLARIA RN, 0541-347714 0541-324413 / **RTE SNC DI I. CATELLANI & C. SNC**, Via Premuda, 38/V Reggio Emilia RE, 0522-381277 / **TERMOSERVICE SAS DI BARTOLETTI IMERIO**, VIA DISMANO, 114/N PONTE NUOVO RAVENNA RA, 0544-472001 0544-67837 / **VIDEO 2000 SRL**, VIA DELL-INDUSTRIA, 26 BOLOGNA BO, 051-531581 051-19931146 / **P. & L. DI LELLI MAURO E C. SNC**, VIA TOSCANA, 7 MONTALE RANGONE MO, 059-530300 059-530300 / **REM SNC**, VIA MANFREDI, 110/A PIACENZA PC, 0523 716361 0523 716361

**FRIULI VENEZIA GIULIA: A.V.R. SERVICE DI FOCESATO IVAN MOSE'**, VIA COLONNA, 20/8 PORDENONE PN, 0434-27669 0434-523661 / **ELECTRONIC SERVICENTER SAS**, VIA GATTERI, 12 TRIESTE TS, 040-3478423 040-3478423 / **STARACE ELIO TECNICASA DI BRANDOLIN DARIO**, Via Caprin, 4 Trieste TS, 040-773718 040-773718

**LAZIO: A.P. RIP. ARDUINI PIERO**, VIA LICINIO REFICE, 192 FROSINONE FR, 0775-291267 0775-291267 / **CENTRO E.L.VA. SNC**, VIA ATTILIO MORI, 19/21 ROMA RM, 06-2148641 06-2753048 / **CTS centro tecnico specializzato di Rita De Renzi**, Via Rialto, 38/42 Roma RM, 06-39729748 06-39733315 / **ELETRONICA 81 SNC**, VIA EZIO, 56/58 LATINA LT, 0773-694608 0773 414612 / **ITALREG SRL**, SS FORMIA-CASSINO KM 30,200 LOC PENITRO FORMIA LT 0771-738011 0771-738061 / **PALMIERI F.**, VIA S.POLLEDRARA, 219 FROSINONE FR 0775-291485 0775-291485 / **PANASERVICE SRL**, VIA BARBANA, 35 ROMA RM 06-5403384 06-5401221 / **PANASERVICE SRL FILIALE**, VIA TARENTO, 27/29 ROMA RM 06-25204806 / **VIDEO**

• ADDRESSES D'ENTRETIEN • ONDERHOUDSADRESSEN • DIRECCIONES DE SERVICIO • INDIRIZZI DI SERVIZIO •

**SERVICE SAS DI G. CALABRESE & C.**, Str. Teverina, Km. 2,400 Loc. Pantanese Viterbo VT, 0761-251557 0761-251558 / **VITECART 99 DI TRIPPINI PAOLO**, VIA DELLA PALAZZINA, 103/H VITERBO VT, 0761-220522 0761-220522

**LIGURIA: C.R.E. DI ARATELE FABRIZIO**, VIA CAMOZZINI, 189R GENOVA VOLTRI GE, 010-6121754 0106100154 / **ELETTRICITÀ DI RECUFFO MARCO**, REGIONE VALLUVAIA, 13 SAN BARTOLOMEO AL MARE IM, 0183-400102 / **MICHELIS SANDRO**, Via Giannetti, 8/10 Imperia IM, 0183-275891 0183-275891 / **RIEN SNC**, Via Valle, 17/19 La Spezia SP, 0187-21925 0187-21925 / **TELESERVICE DI SCALVO N. & C. snc**, VIA PONCHIELLI 27R SAVONA SV 019-810058 019-019-852596 / **TOGNETTI SERVICES DI TOGNETTI MASSIMILIANO**, VIA LUNIGIANA, 589 LA SPEZIA SP 0187-507656 0187-507656 / **VILL@ SNC DI R. VILLA E M.T. ADAMO**, VIA S. CHIARA, 6 R GENOVA GE 010-5740318 010-8630203

**LOMBARDIA: 2M DIGITECH SRL**, via Rossini 102 DESIO MI, 0362-306557 0362-306148 / **AE CLIMA SERVICE SRL**, VIA GUIDO DA VELATE, 3 MILANO MI, 02-6466930 02-6466930 / **BACCINELLI MARZIO E C. SNC**, VIA BRANZE, 22 BRESCIA BS, 030-2006411 030-2006411 / **CREL SNC**, VIA CARDUCCI SONDRIO SO, 0342-216538 0342-216538 / **EUROTECNICA DI RONCHI**, VIA MILANO, 74/B BRESCIA BS, 030-317673 030-317673 / **F.G.R. ELECTRONIC SAS**, VIA R. PELLEGGATTA, 34/A VIMERCATE MI, 039-6082592 039-6085034 / **GRANDINI E TORCHIO SNC**, VIA FASOLO, 4 PAVIA PV, 0382-471360 0382-471360 / **MARKET RICAMBI SERVICE SNC**, VIA SAVONA, 43 MILANO MI, 02-48952866 02-4239820 / **MORINI DANIELE**, VIA MAIOCCHI, 10 VOGHERA PV, 0383-368740 0383-368740 / **S.T.A.R.T. VIDEO HI-FI**, VIA ORTI ROMANI, 16/A CREMONA CR, 0372-38731 0372-38731 / **SA.MO di Sacchetto Teresio e c. snc**, Via Spalato, 4 Vigevano PV, 0381-42353 0381-42353 / **TECNOVIDEO SNC**, P.ZZA DE GASPERI, 28 MANTOVA MN, 0376-321554 0376-321554 / **TELETENICA 2000**, VIA TORINO, 21 GALLARATE VA, 0331-775519 0331-775519 / **TELETENICA 2000 FIL. VARESE**, VIALE VALGANNA, 178 VARESE VA, 0332-499365 0332-499365 / **VIDEO SERVICES SNC DI VALENTI F. E C.**, Via Locatelli, 2 Seriate BG, 035-296883 035-300076 / **Z BIT SRL**, VIA CHIOGGIA 3 MILANO MI 02-26822804 02-26110301 / **PAGANINI GRAZIANO**, VIA TOLMEZZO, 6 BUSTO GAROLFO MI 0331-566379 0331-566603

**MARCHE: CAT DI SCHIARATURA E MORBIDELLI SNC**, VIA A. CECCHI, 25 PESARO PS, 0721-25608 0721-25608 / **CENTER SERVICE DI TESTAFERRI**, VIA MATTEO RICCI, 8 ANCONA AN, 071-889660 071-2181171 / **MARCONI LANFRANCO**, VIA M.BIANCO, 10 S.BENEDETTO DEL TRONTO AP, 0735-659230 0375-751155 / **S.A.T. RADIO TV**, VIA D. ROSSI, 32-34 MACERATA MC, 0733-231304 0733-230492 / **SAT RADIO TV FIL. ASCOLI**, VIA TEBALDINI, 2 SAN BENEDETTO AP, 0733-231304 0733-230492

**MOLISE: TELECOM AUDIO VIDEO SERVICE DI MANOCCHIO G.**, VIA V. EMANUELE, 67/69 RICCIA CB 0874-716783 0874-716783 / **TELECOM AUDIO VIDEO SERVICE DI MANOCCHIO G. FILIALE**, VIA XXIV MAGGIO, 73 CAMPOBASSO CB 0874-484440 0874-484440

**PIEMONTE: ALPILAB DI GIORDANO**, CORSO GIOVANNI XXIII, 11 CUNEO CN, 0171-690384 0171-648063 / **ARTE E TECNICA SNC**, VIA FALLETTI, 22 BIELLA BI, 015-8496250 015-8496250 / **ELEKTRO di FIORE F.**, C.SO XXVI APRILE, 26 VERCELLI VC, 0161-250071 0161-255843 / **ELTE SNC DI CONTESTABILE NICOLA**, Via Ugo Foscolo, 26 Torino TO, 011-6503786 011-6503786 / **GUIDA di GUIDA ALESSIO**, VIA ROGGIOLO, 5 TRECATE NO 0321-71608 0321-777003 / **MORINI D. SUCCURSALE - A.R. ELETTRONICA SAS**, PIAZZA TORIANI, 12 ALESSANDRIA AL 0131-226212 0131-226212 / **REAT DI FRISINA RITA**, C.SO UNIONE SOVIETICA, 584 TORINO TO, 011-3979817 011-3979817 / **SIRAGUSA E ROAGNA SNC**, C.SO MATTEOTTI, 41 ASTI AT 0141-531131 0141-531131 / **VIDEOTEXT DI OBERTO STEFANO**, P.ZZA TRENTO E TRIESTE, 51 CANALE CN, 0173-95878 0173-979638

**PUGLIA: ARNESANO FAUSTINO**, VIA M.MOSCARDINO, 10 LECCE LE, 0832-318277 0832-318277 / **ASTROTEC P.S.C.A.R.L.**, VIA DEL FEUDO D'ASCOLI, 37 FOGGIA FG, 0881-720921 0881-567123 / **DBF ELETTRONICA DI DI BIASE FARINA EUTERIO**, VIALE OFANTO, 209/D FOGGIA FG, 0881-331126 0881-331126 / **Lamorgese Paolo**, Via Sabotino, 89/91 Bari BA, 080-5421281 080-5428359 / **MICROKEY SRL**, Via Giammatteo, 22 Lecce LE, 0832-399398 0832-399600 / **MICROKEY SRL SUCCURSALE**, Via de Giuseppe, 73 Maglie LE, 0836-424813 / **SANTORO ATTILIO**, VIA MARCHE 24 TARANTO TA, 099-335884 099-335884 / **SAT DI PARTIPILO**, VIA BORSELLINO E FALCONE, 17 BIS BARI BA, 080-5022999 080-5022992 / **STEAR DI PICI VINCENZO**, VIA NANNARONE, 2/A FOGGIA FG, 0881-778483 0881-778483 / **TAURISANO SERVICE SRL**, VIA NUMA POMPILIO, 49/55 BRINDISI BR, 0831-564069 0831-522021

**SARDEGNA: AS.TEC ELETTRONICA SNC**, VIA RIVA VILLASANTA, 227 CAGLIARI CA, 070-524153 070-504109 / **CO.RI.FR.EL. SNC DI AMICO A. & C.**, VIA MONASTIR, 112 CAGLIARI CA, 070-282354 070-272727 / **FLORIS SERGIO**, VIA MAZZINI, 56 GONNESCA CA, 0781-45436 0781-469198 / **G.S. ELETTRONICA DI PORCU**, VIA DELLA RESISTENZA, S.N. NUORO NU, 0784-203084 0784-203084 / **LA VIDEO ELETTRONICA SNC DI FAEDDA**, VIA SARDEGNA, 91 ORISTANO OR, 0783-300026 0783-777599 / **VIDEOELETTRONICA SNC DI PEDOL E SABA**, VIA TORINO, 18 SASSARI SS 079-276616 079-273239 / **BRACCU GAVINO**, VIA DE SIMONE, 9 OLBIA SS, 0789-50114 0789-50114

**SICILIA: A.V.S. Elettronica snc**, VIA SASSARI, 2/C CATANIA CT, 095-446696 095-434337 / **ADAMO & C. SNC**, VIA G. FERRARIS, 20 RAGUSA RG, 0932-624553 0932-627191 / **ALAMIA SERVICE PICCOLA COOPERATIVA**, C.SO PISANI, 310/312 PALERMO PA, 091-6570502 091-6575761 / **ARTE TV sas**, VIA G.CENTORBI, 17 MAZARA DEL VALLO TP, 0923-908160 0923-670035 / **AUDIO VIDEO SRL**, VIA DON MINZONI, 52/54 CALTANISSETTA CL, 0934-552111 0934-552111 / **C.T.A. SERVICE PALERMO**, VIA RAPISARDI, 44 PALERMO PA, 091-343431 091-346488 / **CUPPARI ELECTRONICS**, VIA S.AGOSTINO IS, 265 MESSINA ME, 090-672064 672065 090-672065 / **CUPPARI ELECTRONICS SUCCURSALE**, VIA LIBERTA', 95 Capo D'Orlando ME 0941-911785 0941-912552 / **ELETTRONICA DI TULLIO MARIA**, VIA CARLENTINI, 40/A SIRACUSA SR, 0931-758602 0931-758602 / **ELETTROSERVICE DI COLOMBO PIERO & C. SNC**, VIA VARIANTE SS 115 KM 338, 400 N. 28 MODICA RG, 0932-46169 0932-456169 / **EUROSERVICE 2000**, VIA DEGLI ATLETI 61/C MARSALA TP, 0923-956475 0923-956475 / **G & B CAT DI GABRIELE BARRACO SNC**, VIA COSENZA, 141/151 ERICE TP, 0923-568611 0923-568642 / **GUASTELLA GIUSEPPE**, VIA OLANDA, 11 GELA CL 0933-933976 0933-933976 / **S.A.T.E.L. SERVICE SNC**, CORSO SICILIA, 55 A-C CATENANUOVA EN, 0935-75085 0975-75085 / **SILVESTRO MATTEO DI SILVESTRO ROBERTO E C. SAS**, VIA C. BATTISTI IS 74 MESSINA ME, 090-2932105 090-2932105 / **TRISCARI BARBERI GIUSEPPE**, Via Pindemonte, 97 PRIORO GARGALLO SR, 333 5848485 1782276341 / **VIDEO SERVICE SNC DI DE FRANCISCI E NOLENTINI**, Via P. Nenni, 1 Agrigento AG, 0922-595881 0922-595881

**TOSCANA: A.T.E.S. di ZAPPALÀ L.**, VIA TORINO, 3/A LIVORNO LI, 0586-859566 0586-859566 / **ARRIGHI RIPARAZIONI DI ARRIGHI SERENA**, VIA F.LLI CERVI, 26/28 P.A. ELSA EMPOLI FI 0571-931327 0571-931327 / **ATER DI MUSTACCHIA ANGELO E C. SAS**, VIA AURELIA, 288 ROSIGNANO SOLVAY LI, 0586-762102 0586-768056 / **BARDAZZI PAOLO**, via E. Forlanini 8DR Firenze FI, 055-4376776 055-431956 / **BELCARI ENRICO**, VIA J. GAGARIN, 70 - FORNACETTE PISA PI, 0587-420273 0587420911 / **CATE SNC DI BALDI M. E BUONAMICI G. FIL. CECINA**, C.so Matteotti, 320/a-b Cecina LI, 0586-635071 / **CATE SNC DI BALDI M. E BUONAMICI G. FIL. PRATO**, Via Fiorentina, 76/a-b Prato PO, 0574-632652 0574-4632690 / **CATE SNC DI BALDI M. E BUONAMICI G. SEDE**, Via Segantini, 2 Empoli FI, 0571-80652 0571-944115 / **DBS Elettronica snc di Aldovardi S. & c.**, Via Simon Musico, 2/c Massa MS, 0585-489893 0585-886122 / **ELETTRONICA RNP DI PUCCETTI PAOLO**, VIA ROMANA, 731 LUCCA LU, 0583-956225 0583-956225 / **ERRE TV SERVICE SNC**, VIA GUIDO TARLATI, 11/13 AREZZO AR, 0575-300986 0575-259434 / **LAB.RIPARAZ. FALCHI M.**, VIA A. GARIBALDI, 35/37 PIOMBINO LI, 0565-49400 0565-227161 / **M2 ELETTRONICA DI MORELLI MASSIMO**, VIA DANIMARCA, 3 GROSSETO GR, 0564-454571 0564-454571 / **MGM SERVICE SNC DI MARTINELLI**, Via Paolinelli, 26 - Marlia Capannori LU, 0583-30382 0583-30382 /

• ADDRESSES D'ENTRETIEN • ONDERHOUDSADRESSEN • DIRECCIONES DE SERVICIO • INDIRIZZI DI SERVIZIO •

**PARIELS SRL**, Via B. Tolomei, 8 Siena SI, 0577-51159 0577-589454 / **TELESERVICE DI BENVENUTI STEFANO**, Via E.Fermi 9/13 Prato PO, 0574-580840 / **TELESERVICE DI D'AMICIS E. & V. SNC**, VIA P. PISANA, 71 LIVORNO LI, 0586-400564 0586-409724 / **VIDEO SERVICE DI GENUARDI**, VIA BORGACCIO, 72 POGGIBONSI SI, 0577-983181 0577-996382

**TRENTINO ALTO ADIGE: MELONE MICHELE**, VIA ZARA, 44 TRENTO TN, 0461-235166 0461-267210 / **SIGHEL MAURO**, VIA A. VOLTA, 92 TRENTO TN, 0461-935919 0461-935919 / **TECNOSERVICE SNC**, VIA SAN VIGILIO, 64/b-c-d BOLZANO BZ, 0471-289062 0471-261559

**UMBRIA: QUONDAM C. STEFANO**, VIA DEL RIVO, 33 TERNI TR 0744-301512 0744-301512 / **SAT 2000 SNC DI SPARAMONTI PIERO E C.**, Via di Vittorio, 81 Terni TR 0744-279090 0744-279090 / **TECNOCONSULT ELETTRONICA SNC**, VIA MAD.ALTA, 185 PERUGIA PG 075-5003089 075-5003089

**VALLE D'AOSTA: CAT DI D'ISANTO**, C.SO IVREA, 82/A AOSTA AO, 0165-364056

**VENETO: ANDRIOLO SAS DI ANDRIOLO MONICA E NICOLA**, VIA VOLONTARI DELLA LIBERTA', 39/A GAMBARARE FR. PIAZZA VECCHIA VE, 041-5675614 041-5675190 / **ASS.ELETR.CAMPI SNC**, VIA E.REGINATO, 7 TREVISO TV, 0422-436245 0422-435996 / **ASSISTENZA ELETTRON. CAMPI FILIALE MESTRE**, VIA GIUSTIZIA, 32 MESTRE VE, 041-914832 / **ASSISTENZA TECNICA DI MIRCO DE BONA**, VIA MONDINI, 11 BELLUNO BL, 0437-30240 0437-939916 / **DL SERVICE DI DAL LAGO LORENZO**, Via Giaretta, 33 Vicenza VI, 0444 / 966239 0444 / 966239 / **EPS SNC DI TREVISAN E C.**, V.LE GRAMSCI, 134 ROVIGO RO, 0425-33221 0425-30217 / **FRANCHINO GIANFRANCO**, VIA ZERMANESE 6B TREVISO TV, 0422-321054 0422-321054 / **GLOBAL SERVICE IMPIANTI DI Cerpelloni & c. snc**, Piazza Plebiscito, 9/A AVESA VR, 045-8342935 045-8342935 / **PIERENZA CARLO**, VIA BARROCCIO DAL BORGO, 4 PADOVA PD, 049-681592 049-8829059 / **SPEEDY SERVICE DI CORRA' & GIARETTA**, V.le Europa, 42/b Thiene VI, 0445-3'68235 0445-379028 / **VIDEO TV1732**, Via San Marco, 1818 Sottomarina VE, 041-5541675 041-5541675 / **VIDEOSERVICE SNC DI SALVATORI & C.**, VIA VITRUVIO, 11 VERONA VR, 045-566299 045-573865 / **ZAFFALON URBANO**, Via Santa Croce, 2040 VENEZIA VE, 041-2750670 041-2757273

**ESPAÑA** - <http://www.sharp.es>

**En caso de una reclamación con vuestra SHARP Microwave, preguntan por favor la casa dónde han comprado su máquina o infórmense en una de las SHARP Service casas siguientes.**

**ALAVA: MERINO NICOLAS JOSE A.**, AV JUDIZMENDI 24, 01003 VITORIA-GASTEIZ , 945/ 25.18.92

**ALBACETE: JUMAN**, CL IGNACIO MONTURIOL 8, 02005 ALBACETE, 967/ 22.40.78 / **JOSE ANT. PARREÑO**, CL FRANCISCANOS 40 , 02003 ALBACETE, 967/ 22.62.49

**ALICANTE: ELECTRONICA GOMEZ**, CL CAPITAN GASPAS ORTIZ 116 (B), 03204 ELCHE, 96/ 663.42.70 / **TELE-COLOR**, CL DEL VENT 9, 03500 BENIDORM, 96/ 585.24.60 / **ANGEL AVELLAN PUIG**, CL POETA QUINTANA 13, 03004 ALICANTE, 965/ 21.32.55 / **UNISAT**, CL DUQUE DE TAMAMES 9, 03300 ORIHUELA, 96/ 674.11.94 / **TRINITARIO GEA**, CL JAIME POMARES JAVALOYES 47, 03202 ELCHE, 96/ 545.56.25 / **ELECTROSERVICIOS PLAZA**, PZ SANTIAGO 5 , 03300 ORIHUELA, 96/ 828.45.67 / **E.ELECTROSAX**, CL RIO TURIA 1, 03630 SAX, 96/ 547.42.32 / **ASISTEL**, AV DE LA CONSTITUCION 185 D, 03400 VILLENA, 965/ 80.02.31 / **VIDEO ELECTRONICA NOGUERA**, CL CASTELLON 17, 03590 ALTEA, 965/ 84.41.58 / **JOAQUIN SAEZ SERVICIOS**, CL ESCORPION 6-8, 03006 ALICANTE, 96/ 528.73.33 / **MATEO BELDA S.L.**, CL CONCORDIA 120, 03180 TORREVIEJA, 966/ 70.49.78 / **EUROSAT SUR**, CL MONTERO RIOS 33, 03012 ALICANTE, 96/ 525.80.40 / **SERVIELECTRO BENIDORM**, CL MARQUES DE COMILLAS 12, 03501 BENIDORM / **IMECLIMA**, CL CAVALLER MERITA 21, 03801 ALCOI

**ALMERIA: TELEVIDEO**, CL VELAZQUEZ 7 LOCALA, 04770 ADRA, 950/ 40.18.63 / **SERVIRAP**, CL ANGEL OCHOTONERA 11, 04005 ALMERIA, 950/ 27.40.67 / **SERVICIO TECNICO PONCE**, PLG PS MARITIMO E- EUROPA 1, 04630 GARRUCHA, 950/ 13.28.37 / **SONIVITEL S.L.**, CL POETA PACO AQUINO 51, 04005 ALMERIA, 950/ 22.97.55

**ASTURIAS: ELECTRONICA EDIMAR, S.A.**, CL CANGAS DE ONIS 4, 33207 GIJON, 98/ 535.34.51 / **ALVAREZ OLIVAR CASILDA**, CL SAN JOSE 12, 33003 OVIEDO, 98/ 522.37.39 / **SANTIAGO VALDERREY**, AV DE LOS EMIGRANTES 34, 33710 NAVIA, 98/ 563.18.61 / **G.A.M.I.F.E.L.**, CL RICARDO MONTES 6, 33012 OVIEDO, 98/ 528.43.60 / **ASTUSETEL S.L.**, CL CEA BERMUDEZ 9, 33208 GIJON, 98/ 539.10.11 / **ASTURSERVICE**, CL SANCHEZ CALVO 6 BJOS., 33401 AVILES, 98/ 556.83.87 / **JUAN MORILLON DEL CORRO**, CL NORTE EDIF. SETSA 5, 33930 LA FELGUERA, 98/ 567.40.24 / **S.A.T. JUAN-MANUEL**, CL URIA 60, 33800 CANGAS DE NARCEA, 98/ 581.22.48 / **MANUEL ALEA VILLA**, CL LLANO MORGOLLES S/N, 33550 CANGAS DE ONIS, 98/ 592.26.40

**AVILA: DANIEL SERRANO LABRADO**, CL JOSE GOCHICOA 16, 05400 ARENAS DE S.PEDRO, 920/ 37.15.16 / **ELECTRONICA GREDOS**, CL EDUARDO MARQUINA 24, 05001 AVILA, 920/ 22.48.39 / **REPARACIONES SAN SEGUNDO**, CL SORIA 6, 05003 AVILA, 920/ 22.33.21

**BADAJOS: ELECTRONICA BOTE**, PZ PORTUGAL 2, 06001 BADAJOZ, 924/ 22.17.40 / **C.E. VILANOVENSE C.B.**, CL CAMINO MAGACELA 4 LOCAL-5, 06700 VILLANUEVA SERENA, 924/ 84.59.92 / **ELECTRONICA CENTENO S.L.**, AV DEL ZAFRA 1, 06310 PUEBLA SANCHO PEREZ, 924/ 57.53.08 / **INDALECIO AMAYA SANCHEZ**, CL CARRERAS 11, 06200 ALMENDRALEJO, 924/ 66.47.01 / **PATRICIO ELECTRONICA**, CL REYES HUERTAS 7, 06800 MERIDA, 924/ 33.04.13

**BALEARES (MENORCA): INSAT, CB**, CL PINTOR CALBO 30, 07703 MAHON, 971/ 36.53.18

**BALEARES (IBIZA): REPARACIONES ORTEGA**, CL VIA ROMANA 17, 07800 IBIZA, 971/ 39.01.55

**BALEARES (FORMENTERA) : ELECTRO-SAT**, CL EIVISSA 12-16, 07860 S. FCESC. DE FORMENTERA, 971/ 32.27.62

**BALEARES (MALLORCA): INSTALACIONES MAES, S.L.**, CL SON NADAL 63, 07008 PALMA DE MALLORCA, 971/ 27.49.47

**BARCELONA: VIDEOCOLOR**, CL VILLARROEL 44, 08011 BARCELONA, 93/ 454.99.08 / **ESTARLICH**, CL INDUSTRIA 131, 08370 CALELLA, 93/ 766.22.33 / **CE.VA.SAT**, PS RUBIO I ORS 105, 08203 SABADELL, 93/ 710.76.13 / **LAUREA S.A.T.**, CL GUILLERIES BIS 20, 08500 VIC, 93/ 889.02.48 / **CE. VA. SAT, S.C.**, CR MATADEPERA 87, 08225 TERRASSA, 93/ 785.51.11 / **ELDE**, CL BRUCH 55, 08240 MANRESA, 93/ 872.85.42 / **SERVINTERS, S.C.C.L.**, PZ CASAGEMES 20, 08911 BADALONA, 93/ 389.44.60 / **4 EN 1 REPARACIONES**, CL TAQUIGRAFO MARTI 19, 08028 BARCELONA, 93/ 430.97.26 / **FERMO**, AV MORERA 5, 08915 BADALONA, 93/ 465.22.00 / **TEELCO**, AV BALMES 90, 08700 IGUALADA, 93/ 805.11.90 / **ELECTRONICA MATEOS**, CR DE CALDAS (BAJOS) 76, 08400 GRANOLLERS, 93/ 849.28.77 / **TOP ELECTRONICA**, CL MISSER RUFET 4 Bjos, 08720 VILAFRANCA PENEDES, 93/ 890.35.91 / **TOTVISIO ELECTRONICA S.L.**, PJ FERRER 14, 08240 MANRESA, 93/ 873.88.81 / **LA CLINICA DEL ELECTROD.**, CL BALMES 160, 08008 BARCELONA, 93/ 236.44.11 / **PULGAR I EDO S.L.**, CL CASANOVA 46, 08011 BARCELONA, 93/ 436.44.11 / **SERVEI TECNIC FERRER**, CL SARDA 37, 08203 SABADELL, 93/ 710.51.38 / **FRED VILAFRANCA**, CL PROGRES 42, 08720 VILAFRANCA DEL PENEDES, 93/ 890.48.52 / **DOMOTICA**, AV DIAGONAL 296, 08013 BARCELONA, 93/ 408.66.22 / **SALJA & MAT**, CL LA RASETA 15 L-3, 08750 MOLINS DE REY, 93/ 668.13.61 / **JOAQUIN CASAJOANA PAGES**, CL MAJOR 19 (TIENDA), 08860 CASTELLDEFELS, 93/



• ADDRESSES D'ENTRETIEN • ONDERHOUDSADRESSEN • DIRECCIONES DE SERVICIO • INDIRIZZI DI SERVIZIO •

664.43.60 / **ESTARLICH**, CL AUQUEBISBE CREUS 12, 08301 MATARO, 93/790.22.89 / **TECNOSPLIT S.L.**, CL SANT FRANCESC XAVIER 40, 08950 ESPLUGUES DE LL., 93/473.57.41 / **SERVITEC**, AV PIUS XII 24, 08500 VIC, 93/883.25.11 / **MOVILFRIT**, CL OSCA 11 POL. SALINAS, 08830 SANT BOI DE LL., 96/630.14.53

**BURGOS: SERVITEC BURGOS S.L.**, CL VICENTE ALEXANDRE 23-25, 09007 BURGOS, 947/22.41.68

**CACERES: RUIZ GARCIA JOSE**, CL ECUADOR 5-B, 10005 CACERES, 927/22.48.86 / **ARSENIO SANCHEZ, C.B.**, CL TORNAVACAS 9, 10600 PLASENCIA, 927/41.11.21 / **RADIO SANCHEZ C.B.**, AV DE MIAJADAS S/N, 10200 TRUJILLO, 927/32.06.88

**CADIZ: ELECTRONICA Y CLIMATIZACION JEDA**, CL DIVINA PASTORA E-1 L-4,5,6, 11402 JEREZ LA FRONTERA, 956/33.64.99 / **JOSE M. BORJA PRADOS**, PS VICTORIA EUGENIA 17 Local-1, 11207 ALGECIRAS, 956/66.60.53 / **NOVOMAM-SAT**, POL. URBISUR, JORGE JUAN 4, 11130 CHICLANA DE LA FRONTERA, 956/40.12.09 / **GALAN SAT S.L.**, CL CRUZ ROJA ESPAÑOLA 11, 11009 CADIZ, 956/20.14.17 / **GALAN SAT S.L.**, CL FACTORIA MATAGORDA 52, 11500 PUERTO REAL, 956/83.35.35 / **ELECTROGAN**, CL DURANGO 54, 11500 PTO. STA. MARIA, 956/87.07.05 / **SERVITEL**, CL PORVENIR 11 LOCAL, 11401 JEREZ LA FRONTERA, 956/33.76.55 / **ROTA ELECTROSUR**, CL MALAGA 11, 11520 ROTA, 956/81.59.60 / **J. J. COLLADO NORIEGA**, CL ALMIRANTE M. VIERNA, 11009 CADIZ

**CANTABRIA: ELECTRONICA SEYMA**, CL CAMILO ALONSO VEGA 48, 39006 SANTANDER, 942/32.50.60

**CASTELLON: ASISTE, S.L.**, AV DE VALENCIA NAVE 19, 12006 CASTELLON, 964/21.57.69 / **ELECTRONICA MAESTRAT**, PS FEBRER SORIANO 65, 12580 BENICARLO, 964/46.03.08

**CEUTA: PEDRO A. CARCAÑO LOPEZ**, CL URANO (LOCAL 7), 51002 CEUTA, 956/50.43.99

**CIUDAD REAL: ELECTRONICA ARELLANO**, CL LORENZO RIVAS 14, 13600 ALCAZAR DE SAN JUAN, 926/54.78.95 / **ELECTRODIAZ S.L.**, CL BUENSUCESO 10, 13300 VALDEPENAS, 926/32.23.24 / **TELE-NUOVA**, CL CAMPO 56, 13700 TOMELLOSO, 926/50.59.96 / **CLIMATEC**, CL POZO 3 4º A, 13500 PUERTOLLANO, 652/79.03.60 / **SANTIAGO GARRIDO CHAMORRO**, CL LIRIO 41 LOCAL 3, 13004 CIUDAD REAL, 926/25.16.05 / **ANJAMA**, AV REY SANTO 28, 13001 CIUDAD REAL, 926/92.01.91

**CORDOBA: TEODORO DUEÑAS CAÑAS**, CL HERMANO JUAN FDEZ 15, 14014 CORDOBA, 957/26.35.06 / **SERPRIEGO S.L.**, CL SAN LUIS 4 BJO. IZDA., 14800 PRIEGO DE CORDOBA, 957/54.15.11 / **CAYRO**, CL HERMANO JUAN FDEZ. 15, 14014 CORDOBA, 957/26.35.06 / **ELECTRONICA SALES**, CL ANDALUCIA 37, 14920 AGUILAR FRONTERA, 957/66.09.04 / **ANTONIO GONZALEZ ESQUINAS**, CL GRAL PRIMO RIVERA 61, 14200 PEÑARROYA, 957/57.10.50 / **SONICOR ELECTRONICA**, AV OLLERIAS 43, 14001 CORDOBA

**CUENCA: SERVI-TRASGU**, CL ALFARERIA 12, 16630 MOTA DEL CUERVO, 967/18.10.50 / **INTELCO S.L.**, CL RAMON Y CAJAL 17, 16004 CUENCA, 969/23.39.87

**GIRONA: RIERA DAVIU**, CL TORRAS Y BAGES 19, 17600 FIGUERES, 972/50.32.64 / **NEW MERESA**, CL SURERA BERTRAN 23, 17200 PALAFRUGELL, 972/30.44.54 / **FISATEC**, CL SANT ANTONI 126, 17600 FIGUERES, 972/50.09.84

**GRANADA: ELECTRONICA WENCESLAO**, CL FONTIVEROS 42, 18008 GRANADA, 958/81.16.16 / **DIGIMAT ELECTRONICA**, AV JOSE DE MORA 16, 18800 BAZA, 958/70.04.52 / **FERMASA**, CL AZORIN 7, 18004 GRANADA, 958/25.64.77 / **SERVIGON**, CL HOSPITAL DE LA VIRGEN 22, 18015 GRANADA, 958/20.52.81 / **SERVICOSTA**, PZ DR. ALVAREZ RIOSOL 1, 18690 ALMUNECAR, 958/63.11.43

**GUADALAJARA: TELE-VIDEO MARVI**, AV EJERCITO 23, 19004 GUADALAJARA, 949/24.86.96

**GUIPUZCOA: TEKNIBAT ELECTRONICA**, CL ZEENBIDE 4, 20600 EIBAR, 943/70.24.37 / **ELECTRONICA GUIPUZCOANA**, CL BALLENEROS 2 BJS., 20011 SAN SEBASTIAN

**HUELVA: TELEJARA**, POL. POLIRROSA CLA NAVE-27, 21007 HUELVA, 959/22.60.74 / **TELESONID HUELVA, S.C.A.**, CL FCO.VAZQUEZ LIMON 4, 21002 HUELVA, 959/24.38.60 / **AIRSEXT HUELVA**, PS DE LA GLORIETA 6, 21002 HUELVA, 959/22.88.13

**JAEN: ELECTRONICA GONZALEZ**, CORREDERA SAN BARTOLOME 11, 23740 ANDUJAR, 953/50.33.82 / **MANUEL TRILLO**, CL GOYA 1, 23400 UBEDA, 953/75.14.19 / **ELECTRO HIMEGA, S.A.**, CL ADARVES BAJOS 4-C, 23001 JAEN, 953/24.22.56 / **ELECTR. MARTINEZ PADILLA**, CL DON LUIS 10, 23700 LINARES, 953/69.52.03

**LA CORUÑA: ZENER ELECTRONICA**, CL RONDA DE MONTE ALTO 15, 15002 LA CORUÑA, 981/22.07.00 / **S.T. MENDEZ**, CL GIL VICENTE 13, 15011 LA CORUÑA, 981/27.52.52 / **BANDIN AUDIO**, CL URB. A MARTELA 16, 15920 RIANXO, 981/86.60.23 / **RAMSAT**, AV FINISTERRE 117-B, 15270 CEE, 981/74.74.61 / **VICTOR PEREZ QUINTELA**, CL ENTRERIOS 35, 15705 SANTIAGO DE COMPOSTELA, 981/58.43.92

**LA RIOJA: ELECTRONICA MUSAND**, CL REY PASTOR 60-62, 26005 LOGROÑO, 941/22.84.52 / **TOP SERVICE**, CL ACHUTEGUI DE BLAS 17, 26500 CALAHORRA, 941/13.50.35 / **AGUADO SAT**, CL VELEZ DE GUEVARA 26 BAJO, 26005 LOGRONO, 941/25.25.53

**LEON: TECNYSER ELECTRO**, CL RELOJERO LOSADA 25, 24009 LEON, 987/22.77.87 / **ASIST. TECNICA MARCOS**, CL CONDE DE TORENO 5, 24006 LEON, 987/20.01.01 / **PROSAT (ELECTROBAZAR)**, CL JAIME BALMES 8, 24007 LEON, 987/22.37.30

**LLEIDA: JORDI DURO FORT**, CL INDUSTRIA 6 3º 3º, 25620 TREMP, 973/65.25.15 / **IELSA ELECTRONICA**, CL TARRAGONA 15, 25005 LLEIDA, 973/24.71.27 / **CRISTEL**, CL VALLCALENT 32, 25006 LLEIDA, 973/27.08.26 / **SATEF**, CL SANT PELEGRI 54, 25300 TARRAGA, 973/50.08.48 / **ELECTRONICA GUIRAO**, CL SANT PERE CLAVER 16 B-2, 25300 TARRAGA, 973/50.02.34 / **ELECTRO FRED PALLARS**, AV ESTACIO 12, 25500 POBLA DE SEGUR, 973/68.04.77

**LUGO: ELECTRONICA FOUCES**, CL BENITO VICETTO 34, 27400 MONFORTE DE LEMOS, 982/40.24.38 / **TELEVEOX S.L.**, CL NOSA SRA. DO CARMEN 70, 27880 BURELA, 982/58.18.57 / **ELECTRONICA PENELO**, CL SERRA GANIDOIRA 63, 27004 LUGO, 982/21.47.43 / **SERVICIO TECNICO PASFER**, AV ARCADIO PARDINAS 77, 27880 BURELA, 696/17.86.458

**MADRID: CROMADELTA**, CL ALFONSO XII 31, 28934 MOSTOLES, 91/664.16.41 / **GARMAN C.B.**, CL CARLOS SOLE 38 LOCAL, 28038 MADRID, 91/380.33.49 / **ELECTRONICA BARAJAS**, PZ DEL JUBILADO 8, 28042 BARAJAS, 91/305.48.90 / **ELECTRONICA GARMAN, C.B.**, CL MANDARINA 15, 28027 MADRID, 91/368.01.79 / **ELECTRONICA ANSAR**, CL TOMASA RUIZ 4, 28019 MADRID, 91/460.47.45 / **TEC-NORTE**, CL SANTIAGO APOSTOL 5, 28400 COLLADO VILLALBA, 91/851.63.47 / **VARIOSAT, S.L.**, CL ISLA DE CORCEGA 24, 28100 ALCOBENDAS, 91/662.04.68 / **VIDEO SERVICE ELECTRONIC**, CL ERA HONDA 9, 28803 ALCALA DE HENARES, 91/880.27.87 / **UGENASA**, CL LA CANALEJA 4, 28921 ALCORCON, 91/611.52.51 / **ELBESERVI, S.A.**, CL DR.R. CASTROVIEJO 19, 28029 MADRID, 91/386.27.11 / **GARMAN C.B.**, CL MANDARINA 15, 28027 MADRID, 91/368.01.79 / **ELBESERVI**, CL DR. R. CASTROVIEJO 19, 28029 MADRID,

**MALAGA: ELECTRONICA GARCIA CAMPOY**, AV VELAZQUEZ 1, 29003 MALAGA, 952/32.00.77 / **ELECTRONICA BG**, CL ANDALUCIA 2, 29670 SAN PEDRO ALCANTARA, 952/78.50.09 / **ELECTRONICA RAMA**, PZ DE LAS DESCLZAS 1, 29200 ANTEQUERA, 952/84.42.40 / **REMEDIOS CAMARGO**, CL JUNCO 5, 29130 ALHAURIN DE LA TORRE

• ADDRESSES D'ENTRETIEN • ONDERHOUDSADRESSEN • DIRECCIONES DE SERVICIO • INDIRIZZI DI SERVIZIO •

**MELILLA:** SONITEV, CL EJERCITO ESPAÑOL 3, 52001 MELILLA, 952/ 68.30.80

**MURCIA:** CARO PORLAN RAIMUNDO, CL JOSE MOULIAA 45, 30800 LORCA, 968/ 46.18.11 / **REG., C.B.**, CL RAMON Y CAJAL 27, 30205 CARTAGENA, 968/ 51.00.06 / **ELECTROSERVICIOS SEBA,C.B.**, CL ISAAC ALBENIZ 4 BJOS, 30009 MURCIA, 968/ 29.85.93 / **VISATEL**, CL TORRE ALVAREZ S/N, 30007 MURCIA, 968/24.16.47 / **ELECTRO SERVICIOS PLAZA**, CL SIERRA DE PENARRUBIA 7, 30009 MURCIA, 968/ 29.25.23 / **ANGEL LOPEZ ALCARAZ**, CL SIERRA DEL ESPARTAL 6 (EDIF. ANA), 30009 MURCIA, 968/ 29.39.10 / **RAFAEL GOMEZ YELO**, PS CORBERA 17, 30002 MURCIA, 968/ 26.14.67 / **LA SEDA REPARACIONES**, CL LA SEDA EDIF. LAS TERRAZAS ESC. 3, 30800 LORCA, 968/ 47.18.79 / **ELECTRO SERVICIOS PLAZA**, CL MONSEÑOR ESPINOSA 3, 03300 ORIHUELA, 96/ 674.18.67

**NAVARRA:** UNITEC, CL FUENTE CANONIGOS 5, 31005 TUDELA, 948/ 82.74.34 / **ELECTRO REPARACIONES 2000**, CL MONASTERIO FITERO 26, 31011 PAMPLONA, 948/ 26.79.12

**ORENSE:** FERNANDEZ GONZALEZ JOSE, AV BUENOS AIRES 75 BJOS, 32004 ORENSE, 988/ 23.48.53 / **ANTONIO RODRIGUEZ ALVAREZ**, CL CABEZA DE MANZANEDA 7, 32005 ORENSE, 988/ 22.40.98

**PALENCIA:** ELECTRONICA JAVIER, AV CASTILLA 77, 34005 PALENCIA, 979/ 75.03.74

**PONTEVEDRA:** CENTRAL DE SERVICIOS, CL ASTURIAS 10 BJOS, 36206 VIGO, 986/ 37.47.45 / **IMASON**, CL LOUREIRO CRESPO 43, 36004 PONTEVEDRA, 986/ 84.16.36 / **SIAL-ALVIMO S.L.**, C/ C.TORRECEDEIRA 92 BJOS, 36202 VIGO, 986/ 29.93.01 / **ELECTRONICA CAMBADOS**, CL CAMILO JOSE CELA 13, 36600 VILAGARCIA AROUSA, 986/ 50.83.27

**SALAMANCA:** J. DANIEL MARTINEZ, CL ABRAHAM LACUT 11-15, 37003 SALAMANCA, 923/ 19.16.10

**SEGOVIA:** GUIJO S.T., CL TEOFILO AYUSO 2 LOCAL, 40002 SEGOVIA, 921/ 42.94.18

**SEVILLA:** ELECTRONICA TRIANA, CL EVANGELISTA 69-71 L-25, 41010 SEVILLA, 95/ 433.83.03 / **LUIS RIVAS CALDAS**, CL FEBO 16, 41010 SEVILLA, 95/ 451.73.55 / **INTERSAT SEVILLA**, CL BEETHOVEN 5, 41008 SEVILLA, 95/ 443.02.26 / **ELECTRONICA BERSABE**, PASAJE MERINOS 62 A, 41400 ECIIJA, 95/ 483.33.93 / **ELECTRO 93 S.L.**, CL MELLIZA 1, 41700 DOS HERMANAS, 95/ 472.37.16 / **ELECTRONICA GUILLEN**, CL LA CILLA 70, 41640 OSUNA, 954/ 81.12.96 / **JOAQUIN VILLASANTE GARCIA**, CL PABLO NERUDA 5, 41927 MAIRENA DEL ALJARAFE, 95/ 417.06.24 / **SERYVEN CANTILLANA**, CL JUAN XXIII 60, 41320 CANTILLANA, 95/ 573.11.69 / **ELECTRO 93**, CL P. IGLESIAS B-4, CONJ. 1, L-7, 41008 SEVILLA, 954/ 42.01.43 / **SONOMAT**, CL JUAN CURIEL 22, 41005 SEVILLA, 954/ 58.10.66

**SORIA:** MEMQUESI S.L., CL REYES CATOLICOS 1, 42110 OLVEGA, 976/ 64.58.54 / **TECO**, CL ANTOLIN DE SORIA 10, 42003 SORIA, 975/ 22.61.25

**TARRAGONA:** EURO TECNICS, CL MONESTIR DE POBLET 4, 43205 REUS, 977/ 32.24.89 / **ELECTRONICA S. TORRES**, CL ERNEST VILCHES 4-B L-2, 43005 TARRAGONA, 977/ 21.21.48 / **TECNO SERVEIS MORA**, CL PAU PICASSO 1, 43740 MORA D'EBRE, 977/ 40.08.83 / **SELECCO S.L.**, CL CALDERON DE LA BARCA 11, 43870 AMPOSTA, 977/ 70.00.12 / **SERTECS, S.C.**, CL CAPUTXINS 22 BJOS, 43001TARRAGONA, 977/ 22.18.51 / **ELECTRO SERVEI C.B.**, PS MOREIRA 10, 43500 TORTOSA, 977/ 51.04.42 / **MAÑE GRIFOLLS**, CL JESUS 21, 43820 CALAFELL, 977/ 69.04.39

**TERUEL:** TELESERVICIO BAJO ARAGON, CL ROMUALDO SOLER 4, 44600 ALCANIZ, 978/ 87.08.10 / **ALEJANDRO HERNANDEZ**, CR ALCANIZ 1 BJOS, 44003 TERUEL, 978/ 60.85.51

**TOLEDO:** ELECTRONICA RIVAS, CL BARRIO SAN JUAN 1, 45600 TALAVERA LA REINA, 925/ 80.55.46 / **ELECTRONICA FE-CAR, S.L.**, AV SANTA BARBARA 30, 45006 TOLEDO, 925/ 21.21.45 / **ELECTRONICA JOPAL S.L.**, AV PURISIMA CONCEPCION 31, 45006 TOLEDO, 925/ 25.04.42 / **ELECTRO ANAYA**, CL VERTEDERA ALTA 14, 45700 CONSUEGRA, 925/ 48.09.81

**VALENCIA:** SERVICIOS ELECTRONICOS, CL DOCTOR OLORIZ 3, 46009 VALENCIA, 96/ 340.20.34 / **TECNO HOGAR**, CL DOS DE MAYO 41, 46700 GANDIA, 96/ 286.53.35 / **ALBERTO GORIAN ZANETTI**, CL MARQUES DE CACERES 58, 46183 L'ELIANA, 96/ 274.17.47 / **VIDEOSERVITE**, PZ DE LA SAFOR 2 (B DCHA), 46014 VALENCIA, 96/ 377.90.90 / **TECNITOT REPARACIONES**, CL PRIMER DE MAIG 51, 46700 GANDIA, 96/ 286.04.69

**VALLADOLID:** ASIST. TECNICA MARCOS, CL PIO DEL RIO HORTEGA 2-4, 47014 VALLADOLID, 983/ 29.78.66 / **ELECTRONICA VITELSON**, PZ DEL MERCADO 9, 47400 MEDINA DEL CAMPO, 983/ 80.43.56 / **TEODORO NEGRO HERNANDEZ**, GLORIETA DESCUBRIMIENTO 4, 47005 VALLADOLID, 983/ 39.17.81

**VIZCAYA:** SERVITELE, CL AUTONOMIA 24 Galerías, 48012 BILBAO, 94/ 444.89.02 / **NEGREDO MARTIN DANIEL**, CL PADRE PERNET 8, 48004 BILBAO, 94/ 411.22.82 / **COLLANTES MARTIN ONOFRE**, CL ORTUÑO DE ALANGO 7, 48920 PORTUGALETE, 94/ 483.21.22 / **TELNOR**, PZ JUANENE 5 TRAS., 48950 ERANDIO, 94/ 417.04.97

**ZAMORA:** R.T.V. BLANCO, CL EDUARDO JULIAN PEREZ 9, 49018 ZAMORA, 980/ 51.14.41

**ZARAGOZA:** AGUSTIN RENALES SOLER, CL SAN ADRIAN SASABE 56, 50002 ZARAGOZA, 976/ 59.01.28 / **ARAGON TELEVIDEO, S.C.**, CL BATALLA CLAVIJO 18, 50010 ZARAGOZA, 976/ 32.97.12

**SWITZERLAND** - <http://www.sharp.ch>

**Sharp Electronics (Schweiz) AG, Moosstrasse 2, CH-8803 Rüslikon, +41 1 846 61 11**

**SWEDEN** - <http://www.sharp.se> Helpdesk 013-353900

**Bild&Ljudservice**, Roxviksgatan 8, 582 73 Linköping, 013-356250 **Tomi Elektronik**, Svandammsplan 2, 126 47 Hågersten, 08-186170 / **Tv Trim**, St Pauligatan 37, 416 90 Göteborg, 031-847200

**NORWAY**

**Service Eksperten**, Trondheimsvn 436B, N-0962 Oslo, 22 90 19 30

**ICELAND**

**Braedurnir Ormsson Ltd**, PO box 8790, IS-128 Reykjavik, +354-5332800 / **Hjólmtækni Ehf**, Skeifar, IS-108 Reykjavik, +354-5332150

**DENMARK**

**Elektronik Centret**, Literbuen 10A, DK2740 Skovlunde, 44 50 30 00

**SUOMI**

**Theho Video Oy**, Niityläntie 3, SF-0620 Helsinki, +35-891461500

## SPECIFICATIONS

GB

GB

AC Line Voltage	: 230 V, 50 Hz, single phase
Distribution line fuse/circuit breaker	: Minimum 16 A
AC Power required:	Microwave : 1,45 kW Top Grill : 1,00 kW Microwave / Top Grill : 2,40 kW Bottom Grill : 0,55 kW Microwave / Bottom Grill : 1,95 kW Top & Bottom Grills : 1,50 kW Convection : 1,525 kW Microwave / Convection : 2,90 kW
Output power:	Microwave : 900 W (IEC 60705) Top Grill : 0,95 kW Bottom Grill : 0,5 kW Convection : 1,45 kW
Microwave Frequency	: 2450 MHz * (Group 2/Class B)
Outside Dimensions	: 520 mm (W) x 309 mm (H) x 488 mm (D)
Cavity Dimensions	: 343 mm (W) x 209 mm (H) x 357 mm (D) **
Oven Capacity	: 26 litres **
Turntable	: ø325 mm, metal
Weight	: 20 kg
Oven lamp	: 25 W/240 - 250 V

- \* This Product fulfils the requirement of the European standard EN55011.  
 In conformity with this standard, this product is classified as group 2 class B equipment.  
 Group 2 means that the equipment intentionally generates radio-frequency energy in the form of electromagnetic radiation for the heat treatment of food.  
 Class B equipment means that the equipment is suitable to be used in domestic establishments.
- \*\* Internal capacity is calculated by measuring maximum width, depth and height.  
 Actual capacity for holding food is less.



As part of a policy of continuous improvement, we reserve the right to alter design and specifications without notice.

# SHARP

**SHARP ELECTRONICS (Europe) GmbH**  
SonninstraÙe 3, D-20097 Hamburg

TINS-A710WRRZ-H83

Gedruckt in Thailand  
Imprimé au Thaïlande  
Gedruckt in Thailand  
Stampato in Thailandia  
Impresso en Thailandia  
Printed in Thailand

## Free Manuals Download Website

<http://myh66.com>

<http://usermanuals.us>

<http://www.somanuals.com>

<http://www.4manuals.cc>

<http://www.manual-lib.com>

<http://www.404manual.com>

<http://www.luxmanual.com>

<http://aubethermostatmanual.com>

Golf course search by state

<http://golfingnear.com>

Email search by domain

<http://emailbydomain.com>

Auto manuals search

<http://auto.somanuals.com>

TV manuals search

<http://tv.somanuals.com>