

MICROWAVE COOKING GUIDE

MODEL R-2120J/2130J

Follow by letter indicating color

K = Black, W = White

Q = Bisque, S = Stainless Steel



SHARP®

FOR CUSTOMER ASSISTANCE

To aid in reporting this microwave oven in case of loss or theft, please record below the model number and serial number located on the unit. We also suggest you record all the information listed and retain for future reference.

MODEL NUMBER _____	SERIAL NUMBER _____
DATE OF PURCHASE _____	
DEALER _____	TELEPHONE _____
SERVICER _____	TELEPHONE _____

TO PHONE:

DIAL 1-800-BE-SHARP (237-4277) for :
SERVICE (for your nearest Sharp Authorized Servicer)
PARTS (for your authorized parts distributor)
ADDITIONAL CUSTOMER INFORMATION

DIAL 1-800-642-2122 for :
ACCESSORIES and COOKBOOK

TO WRITE:

Sharp Electronics Corporation
Customer Assistance Center
1300 Naperville Drive
Romeoville, IL 60446-1091

TO ACCESS INTERNET: www.sharpsusa.com

Please provide the following information when you write or call: model number, serial number, date of purchase, your complete mailing address (including zip code), your daytime telephone number (including area code) and description of the problem.

PRECAUTIONS TO AVOID POSSIBLE EXPOSURE TO EXCESSIVE MICROWAVE ENERGY

- (a) Do not attempt to operate this oven with the door open since open-door operation can result in harmful exposure to microwave energy. It is important not to defeat or tamper with the safety interlocks.
- (b) Do not place any object between the oven front face and the door or allow soil or cleaner residue to accumulate on sealing surfaces.
- (c) Do not operate the oven if it is damaged. It is particularly important that the oven door close properly and that there is no damage to the: (1) door (bent), (2) hinges and latches (broken or loosened), (3) door seals and sealing surfaces.
- (d) The oven should not be adjusted or repaired by anyone except properly qualified service personnel.

CONTENTS

For Customer Assistance	2	Reheat	22-23
Precautions to Avoid Possible Exposure to Excessive Microwave Energy	2	Cook	23-24
Contents	3	Popcorn	24
Consumer Limited Warranty	4	Meal Time	25
Product Information Card	4	Breakfast Bar	25-26
Important Safety Instructions	5	Lunch on the Run	26
Unpacking and Installation Instructions .	6-14	Dinner Delights	27
Unpacking and Examining Your Oven	6	Dinner Delights Recipes	27-28
Installation Instructions	6-14	Easy Defrost	28-29
Optional Accessories	14	Keep Warm Plus	29
Information You Need to Know	15-17	Short Cuts	30
About Your Oven	15	Other Convenient Features	31-32
About Food	15	Custom Help	31
About Utensils and Coverings	16	Multiple Sequence Cooking	31
About Children and the Microwave	16	Demonstration Mode	32
About Microwave Cooking	17	Minute Plus	32
About Safety	17	Help	32
Part Names	18-19	Timer	32
Before Operating	20	More or Less Time Adjustment	32
To Set the Clock	20	Light Hi/Lo	32
Stop/Clear	20	Fan Hi/Lo	32
Manual Operation	21	Cleaning and Care	33
Time Cooking	21	Replacing Parts	34
To Set Power Level	21	Service Call Check	35
Using the Rack	21	Cookbook Information	35
Manual Defrost	21	Specifications	36
Special Features	22-30	Guia Auto-Touch	37-38
Sensor Center	22	Auto-Touch Guide	39-Back Cover

CONSUMER LIMITED WARRANTY

SHARP ELECTRONICS CORPORATION warrants to the first consumer purchaser that this Sharp brand product (the "Product"), when shipped in its original container, will be free from defective workmanship and materials, and agrees that it will, at its option, either repair the defect or replace the defective Product or part thereof with a new or remanufactured equivalent at no charge to the purchaser for parts or labor for the period(s) set forth below.

This warranty does not apply to any appearance items of the Product nor to the additional excluded item(s) set forth below nor to any Product the exterior of which has been damaged or defaced, which has been subjected to misuse, abnormal service or handling, or which has been altered or modified in design or construction.

In order to enforce the rights under this limited warranty, the purchaser should follow the steps set forth below and provide proof of purchase to the servicer.

The limited warranty described herein is in addition to whatever implied warranties may be granted to purchasers by law. ALL IMPLIED WARRANTIES INCLUDING THE WARRANTIES OF MERCHANTABILITY AND FITNESS FOR USE ARE LIMITED TO THE PERIOD(S) FROM THE DATE OF PURCHASE SET FORTH BELOW. Some states do not allow limitations on how long an implied warranty lasts, so the above limitation may not apply to you.

Neither the sales personnel of the seller nor any other person is authorized to make any warranties other than those described herein, or to extend the duration of any warranties beyond the time period described above on behalf of Sharp.

The warranties described herein shall be the sole and exclusive warranties granted by Sharp and shall be the sole and exclusive remedy available to the purchaser. Correction of defects, in the manner and for the period of time described herein, shall constitute complete fulfillment of all liabilities and responsibilities of Sharp to the purchaser with respect to the Product, and shall constitute full satisfaction of all claims, whether based on contract, negligence, strict liability or otherwise. In no event shall Sharp be liable, or in any way responsible, for any damages or defects in the Product which were caused by repairs or attempted repairs performed by anyone other than an authorized servicer. Nor shall Sharp be liable or in any way responsible for any incident or consequential economic or property damage. Some states do not allow the exclusion of incidental or consequential damages, so the above exclusion may not apply to you. THIS WARRANTY GIVES YOU SPECIFIC LEGAL RIGHTS. YOU MAY ALSO HAVE OTHER RIGHTS WHICH VARY FROM STATE TO STATE.

Your Product Model Number & Description:

R-2120J and R-2130J Home Use Microwave Oven. (Be sure to have this information available when you need service for your Product.)

Warranty Period for this Product:

One (1) year parts and labor in-home service. The warranty period continues for an additional six (6) years, for a total of seven (7) years, with respect to the magnetron tube in the Product for parts only. Labor and the servicer trip charge are not provided free of charge for this additional period.

Additional Item(s) Excluded from Warranty Coverage (if any):

Non-functional accessories and light bulbs.

Where to Obtain Service:

From a Sharp Authorized Servicer located In the United States. Be sure to have **Proof of Purchase** available. For in-home service, the servicer will come to the unit's location. If it is necessary to remove the unit for repair, the servicer will reinstall the unit at no extra charge, provided it was installed according to Sharp's Installation Instructions. To find the location of the nearest Sharp Authorized Servicer, call Sharp toll free at 1-800-BE-SHARP (1-800-237-4277).

TO OBTAIN SUPPLY, ACCESSORY OR PRODUCT INFORMATION, CALL **1-800-BE-SHARP** OR VISIT www.sharppusa.com.
SAVE THE PROOF OF PURCHASE AS IT IS NEEDED SHOULD YOUR OVEN EVER REQUIRE WARRANTY SERVICE.

PRODUCT INFORMATION CARD

The product information card should be completed within ten days of purchase and returned. It is necessary to write the model and serial numbers, found on the nameplate in the oven cavity, on the product information card. We will keep it on file and help you access the information in case of loss, damage or theft. This will also enable us to contact you in the unlikely event that any adjustments or modifications are ever required for your oven.

IMPORTANT SAFETY INSTRUCTIONS

When using electrical appliances basic safety precautions should be followed, including the following:

WARNING - To reduce the risk of burns, electric shock, fire, injury to persons or exposure to excessive microwave energy:

1. **READ ALL INSTRUCTIONS BEFORE USING THE APPLIANCE.**
2. Read and follow the specific **“PRECAUTIONS TO AVOID POSSIBLE EXPOSURE TO EXCESSIVE MICROWAVE ENERGY”** on inside front cover.
3. This appliance must be grounded. Connect only to properly grounded outlet. See **“ELECTRICAL GROUNDING INSTRUCTIONS”** on page 7.
4. Install or locate this appliance only in accordance with the provided installation instructions.
5. Some products such as whole eggs and sealed containers—for example, closed glass jars—are able to explode and should not be heated in this oven.
6. Use this appliance only for its intended use as described in this manual. Do not use corrosive chemicals or vapors in this appliance. This type of oven is specifically designed to heat, cook or dry food. It is not designed for industrial or laboratory use.
7. As with any appliance, close supervision is necessary when used by children.
8. Do not operate this appliance if it has a damaged cord or plug, if it is not working properly or if it has been damaged or dropped.
9. This appliance should be serviced only by qualified service personnel. Contact nearest Sharp Authorized Servicer for examination, repair or adjustment.
10. Do not cover or block any openings on the appliance.
11. Do not store or use this appliance outdoors. Do not use this product near water—for example, near a kitchen sink, in a wet basement or near a swimming pool, or similar locations.
12. Do not immerse cord or plug in water.
13. Keep cord away from heated surfaces.
14. Do not let cord hang over edge of table or counter.
15. See door surface cleaning instructions on page 33.
16. To reduce the risk of fire in the oven cavity:
 - a. Do not overcook food. Carefully attend appliance when paper, plastic or other combustible materials are placed inside the oven to facilitate cooking.
 - b. Remove wire twist-ties from paper or plastic bags before placing bag in oven.
 - c. **If materials inside the oven should ignite, keep oven door closed, turn oven off and disconnect the power cord or shut off power at the fuse or circuit breaker panel.**
 - d. Do not use the cavity for storage purposes. Do not leave paper products, cooking utensils or food in the cavity when not in use.
17. Liquids, such as water, coffee or tea are able to be overheated beyond the boiling point without appearing to be boiling. Visible bubbling or boiling when the container is removed from the microwave oven is not always present. **THIS COULD RESULT IN VERY HOT LIQUIDS SUDDENLY BOILING OVER WHEN A SPOON OR OTHER UTENSIL IS INSERTED INTO THE LIQUID.**

To reduce the risk of injury to persons:

 - a. Do not overheat the liquid.
 - b. Stir the liquid both before and halfway through heating it.
 - c. Do not use straight-sided containers with narrow necks. Use a wide-mouthed container.
 - d. After heating, allow the container to stand in the microwave oven at least for 20 seconds before removing the container.
 - e. Use extreme care when inserting a spoon or other utensil into the container.
18. Clean ventilation openings and grease filters frequently—Grease should not be allowed to accumulate on ventilation openings, louver or grease filters.
19. Use care when cleaning the louver and the grease filters. Corrosive cleaning agents, such as lye-based oven cleaners, may damage the louver and the grease filters.
20. When flaming food under the hood, turn the fan on.
21. This appliance is suitable for use above both gas and electric cooking equipment 36” wide or less.

SAVE THESE INSTRUCTIONS

UNPACKING AND INSTALLATION INSTRUCTIONS

UNPACKING AND EXAMINING YOUR OVEN

Open the bottom of the carton, bend the carton flaps back and tilt the oven over to rest on plasticfoam pad. Lift carton off oven and remove all packing materials, WALL and TOP CABINET TEMPLATES. SAVE THE CARTON AS IT MAY MAKE INSTALLATION EASIER.

1. Remove the feature sticker from the outside of the door, if there is one.
2. Check to see that there is a WALL TEMPLATE and TOP CABINET TEMPLATE.
Read enclosures and SAVE the Operation Manual.

Check the oven for any damage, such as misaligned or bent door, damaged door seals and sealing surfaces, broken or loose door hinges and latches and dents inside the cavity or on the door. If there is any damage, do not operate the oven and contact your dealer or SHARP AUTHORIZED SERVICER. See Installation Instructions for more details.

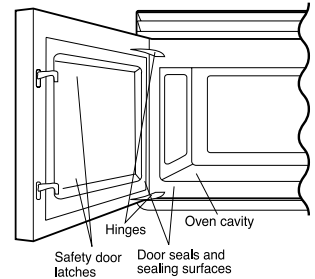

INSTALLATION INSTRUCTIONS

Please read all instructions thoroughly before installing the Over the Range Microwave Oven/Hood System. Two people are recommended to install this product.

If a new electrical outlet is required, its installation should be completed by a qualified electrician before the Microwave Oven/Hood is installed. See 3 ELECTRICAL GROUNDING INSTRUCTIONS on page 7.

1 MOUNTING SPACE

This Microwave Oven/Hood requires a mounting space on a wall as shown in Figure 1. It is designed to be used with standard 12-inch wall cabinets.

There needs to be least 2 inches from the top of the range backsplash to the bottom of the over the range.

If the space between the wall cabinets is 36 or 42 inches, a Filler Panel Kit can be used to fill the gap. The metal filler panels come in 3-inch wide pairs. One set is needed for a 36-inch opening and 2 sets for a 42-inch opening. The Filler Panel Kit should be installed before the Microwave Oven/Hood is installed. See page 14 for ordering informations.

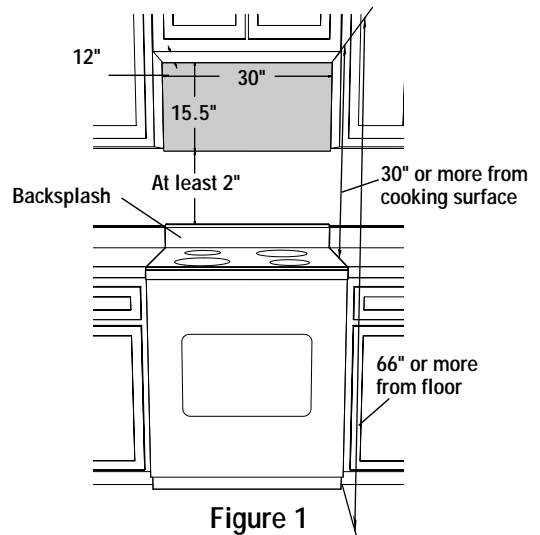

2 WALL CONSTRUCTION

This Microwave Oven/Hood should be mounted against and supported by a flat vertical wall. The wall must be flat for proper installation. If the wall is not flat, use spacers to fill in the gaps. Wall construction should be a minimum of 2" x 4" wood studding and 3/8" or more thick dry wall or plaster/lath. The mounting surfaces must be capable of supporting weight of 110 pounds—the oven and contents—AND the weight of all items which would normally be stored in the top cabinet above the unit.

The unit should be attached to a minimum of one 2" x 4" wall stud.

To find the location of the studs, one of the following methods may be used:

- A. Use a stud finder, a magnetic device which locates the nails in the stud.
- B. Use a hammer to tap lightly across the mounting surface to find a solid sound. This will indicate stud location.

The center of the stud can be located by probing the wall with a small nail to find the edges of the stud and then placing a mark halfway between the edges. The center of any adjacent studs will normally be 16" or 24" to either side of this mark.

UNPACKING AND INSTALLATION INSTRUCTIONS

3 ELECTRICAL GROUNDING INSTRUCTIONS

This appliance must be grounded. This oven is equipped with a cord having a grounding wire with a grounding plug. It must be plugged into a wall receptacle that is properly installed and grounded in accordance with the National Electrical Code and local codes and ordinances. In the event of an electrical short circuit, grounding reduces risk of electric shock by providing an escape wire for the electric current.

WARNING - Improper use of the grounding plug can result in a risk of electric shock.

Electrical Requirements

The oven is equipped with a 3-prong grounding plug. **DO NOT UNDER ANY CIRCUMSTANCES CUT OR REMOVE THE GROUNDING PIN FROM THE PLUG.**

The Power Supply Cord and plug must be connected to a separate 120 Volt AC, 60 Hz, 15 Amp, or more branch circuit, single grounded receptacle. The receptacle should be located inside the cabinet directly above the Microwave Oven mounting location as shown in Figure 2.

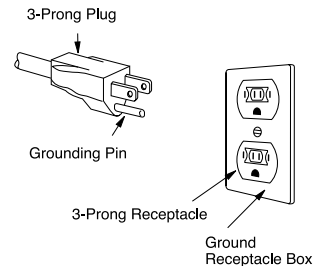

NOTE:

1. If you have any questions about the grounding or electrical instructions, consult a qualified electrician or serviceperson.
2. Neither Sharp nor the dealer can accept any liability for damage to the oven or personal injury resulting from failure to observe the correct electrical connection procedures.

Radio or TV Interference

Should there be any interference caused by the microwave oven to your radio or TV, check that the microwave oven is on a different electrical circuit, relocate the radio or TV as far away from the oven as feasible or check position and signal of receiving antenna.

Figure 2

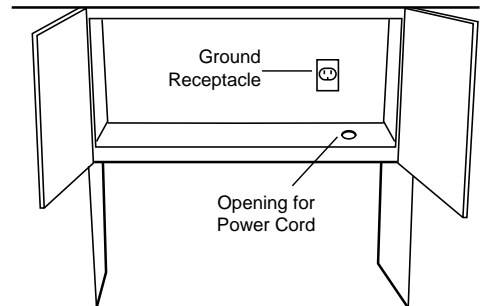

4 HOOD EXHAUST DUCT

When the hood is vented to the outside, a hood exhaust duct is required. All ductwork must be metal; absolutely do not use plastic duct. Check that all connections are made securely. Please read the following carefully:







Exhaust connection: The hood exhaust has been designed to connect to a standard 3-1/4" X 10" rectangular duct. If round duct is required, a rectangular-to-round adapter must be used.

Rear exhaust: If a rear or horizontal exhaust is to be used, care should be taken to align the exhaust with the space between the studs, or wall should be prepared at the time it is constructed by leaving enough space between wall studs to accommodate exhaust.

Maximum duct length: For satisfactory air movement, the total duct length of 3-1/4" X 10" rectangular or 6" diameter round duct should not exceed 140 feet.

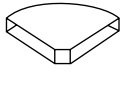
Elbows, adapters, wall caps, roof caps, etc. present additional resistance to air flow and are equivalent to a section of straight duct which is longer than their actual physical size. When calculating the total length, add the equivalent lengths of all transitions and adapters plus the length of all straight duct sections. Figure 3 shows the approximate feet of equivalent length of some typical ductwork parts. Use the values in parentheses for calculating air flow resistance equivalent, which should total less than 140 feet.

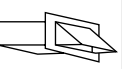
Figure 3

 90° ELBOW (10 FT.)	 45° ELBOW (5 FT.)	 ADAPTOR (5 FT.)	 10" WIDE ELBOW (10 FT.)
 90° ELBOW (25 FT.)	 45° ELBOW (5 FT.)	 WALL CAP (40 FT.)	 ROOF CAP (24 FT.)

UNPACKING AND INSTALLATION INSTRUCTIONS

5 TOOLS RECOMMENDED FOR INSTALLATION

- Phillips Screwdriver
- Electric Drill
- 1/2", 5/8" and 3/32" Drill Bits
- 1-1/2" Wood Bit or Metal Hole Cutter (if metal cabinet is used)
- Saw to cut exhaust opening (if needed)
- Protective Drop Cloth for product and range - you may also use carton for protection
- Scissors
- Pencil
- Measure
- Tape

6 INSTALLATION HARDWARE

The INSTALLATION HARDWARE items ① - ⑦ are in a small bag. Items ⑧ - ⑪ are packed separately. All items are in a small carton packed below the oven.

ITEM	NAME	QUANTITY	PART CODE
①	Wood Screw 5 X 30 mm	6*	XTSSD50P35000
②	Toggle Bolt with nuts #10 - 24 X 50 mm	4**	LX-BZ0195WRE0
③	Top Cabinet Screw 5 X 60 mm	2	XBRSD50P60000
④	Power Cord Hanger	1	LX-MZB001MRE0
⑤	Tapping Screw 4 x 12 mm	8	XOTSE40P12000
⑥	Flat Washer 30 mm diameter	2	XWHSD50-16300
⑦	Grommet	1	LBSHC0040MRE0
⑧	Rear Cushion	1	PCUSUB059MRP0
⑨	Exhaust Damper Assembly	1	FFTA-B005MRK0
⑩	Scale Plate	2	LANG-B004MRP0
⑪	Grease Filter	2	PFIL-B008MRE0
⑫	Bottom Sash	1	HDEC-B001MRF0

* Must use two - may use remaining four.

**May not use all depending on stud location.

Figure 4

Parts shown not to common scale.

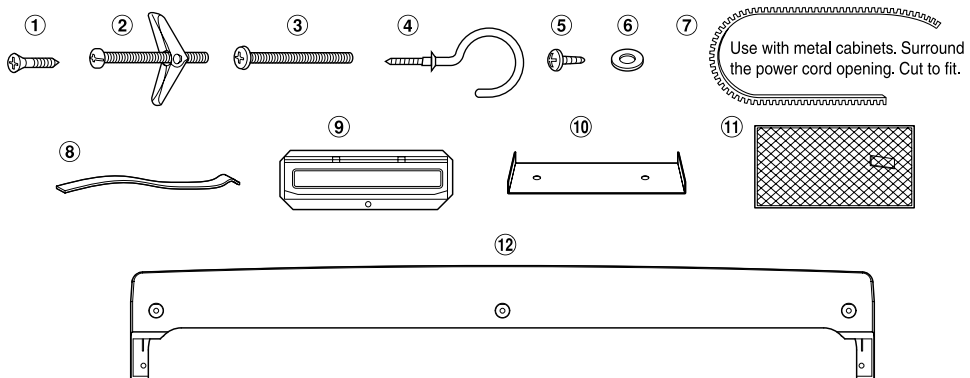

7 PREPARATION OF THE OVEN

1. Turn oven on the side. See Figure 5.
2. Follow steps (A)-(D) to remove mounting plate from the back of the oven as shown in Figure 5.
 - (A) Release mounting plate by pulling out the lever that is on the bottom of the oven. See Figure 6.
 - (B) When lever is out, pull that side of the mounting plate away from the oven. See Figure 5.
 - (C) Repeat step (A) on other side.
 - (D) Repeat step (B) on other side.

Figure 5

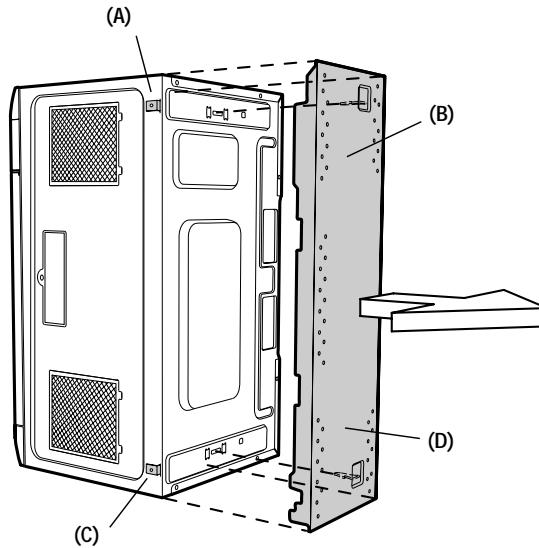
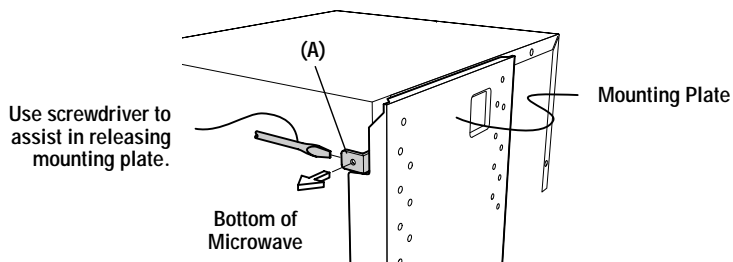

Figure 6



UNPACKING AND INSTALLATION INSTRUCTIONS

8 VENTILATION SYSTEM (PREPARING OVEN FOR INSTALLATION)

This Microwave Oven/Hood is designed for adaptation to three types of hood ventilation systems. Select the type required for your installation.

Recirculating — non-vented, ductless. Follow installation procedure (A). Recirculating requires the use of the Charcoal Filter, which has already been installed in the oven.

Horizontal Exhaust — outside ventilation. Follow installation procedure (B).

Vertical Exhaust — outside ventilation. Follow installation procedure (C).

(A) RECIRCULATING: Non-Vented, Ductless Operation

The unit is shipped assembled for recirculating.

- NOTE:
1. The Exhaust Damper Assembly ⑨ is not required for recirculating operation.
 2. The Charcoal Filter should be replaced every 6 to 12 months, depending on use.
 3. The Charcoal Filter RK-260 is also sold as an accessory. See Page 14 for ordering information.

(B) HORIZONTAL EXHAUST: OUTSIDE VENTILATION

1. Remove 2 screws from back edge and 3 screws from the top center of Fan Cover Bracket. Save 2 screws to be used later and discard remaining 3. Remove Fan Cover Bracket by sliding it in the opposite direction of the arrow on the Fan Cover Bracket, as shown in Figure 7.
2. Lift Hood Fan Unit carefully and slip wires out of cavity. See Figure 8. CAUTION: Do not pull or stretch hood fan wiring.
3. Rotate the Hood Fan Unit 180° so that the fan blade openings are facing the back of the oven. See Figure 9 (A). Replace Hood Fan Unit into the oven. Be careful not to pinch the wire and the Hood Fan Unit. See Figure 9 (B).
4. Put the wire back into the cavity. See Figure 10.

Figure 7

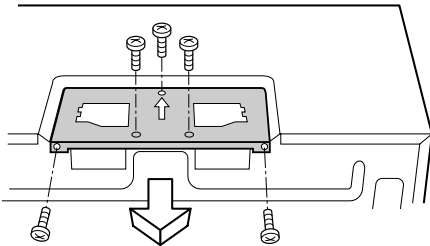

Figure 8

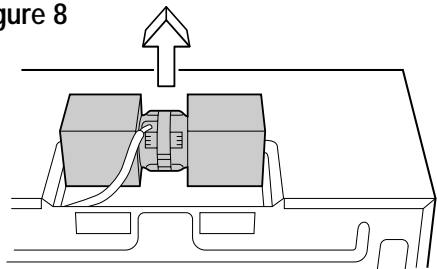

Figure 9

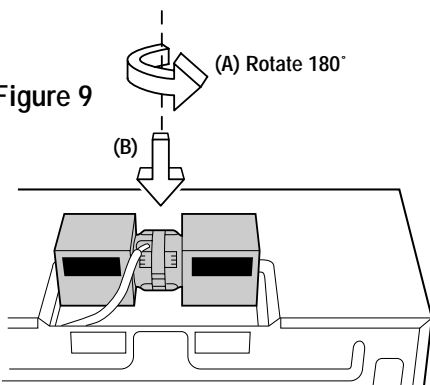
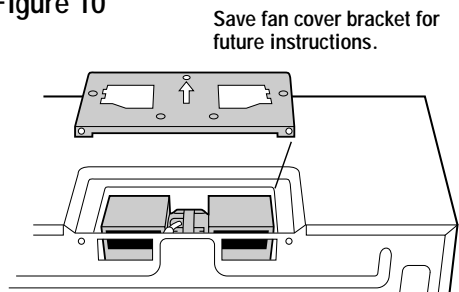

Figure 10



UNPACKING AND INSTALLATION INSTRUCTIONS

(C) VERTICAL EXHAUST: OUTSIDE VENTILATION

1. Remove and save 2 screws from back edge and 3 screws from the top center of the Fan Cover Bracket. Remove Fan Cover Bracket by sliding it in the opposite direction of the arrow on the Fan Cover Bracket as shown in Figure 11.
2. Lift Hood Fan Unit carefully and slip wires out of cavity. See Figure 12. CAUTION: Do not pull or stretch hood fan wiring.
3. Rotate the Hood Fan Unit 90° so that the fan blade openings are facing the top of the oven. See Figure 13 (A). Replace Hood Fan Unit into the oven. Be careful not to pinch the lead wire between the inner bracket and the Hood Fan Unit. Put the lead wire into Wire Box. See Figure 13 (B).
4. Replace the Fan Cover Bracket by sliding it into the slits in the same direction as the arrow on the Fan Cover Bracket. Make sure the fan blades are visible through the top openings in the oven before proceeding.
5. Attach the Fan Cover Bracket to unit with the 2 screws from back edge and 3 screws from the top center of the Fan Cover Bracket, which were removed in Step 1 above. See Figure 14. The Hood Fan Unit is now rotated for vertical exhaust operation.
6. Attach the Exhaust Damper Assembly ⑨ to the fan cover on the top of the outercase cabinet by sliding it into the slits in the same direction as the arrow. Use 1 Tapping Screw 4 X 12 mm ⑤ from the INSTALLATION HARDWARE and tighten into place. See Figure 15.

Figure 11

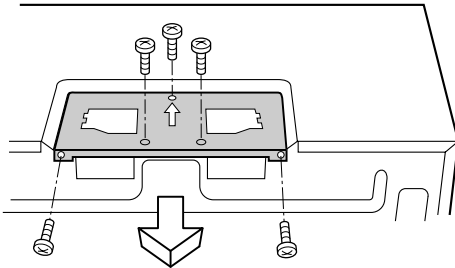

Figure 12

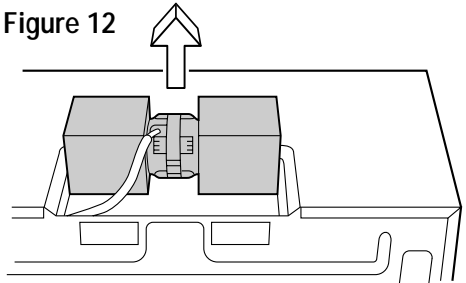

Figure 13

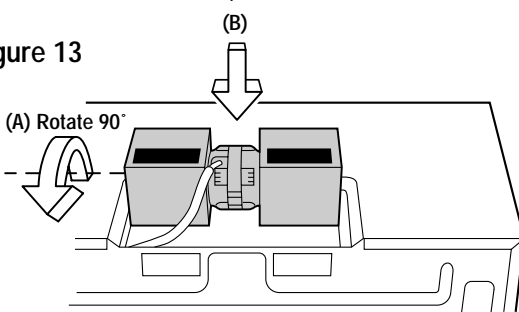

Figure 14

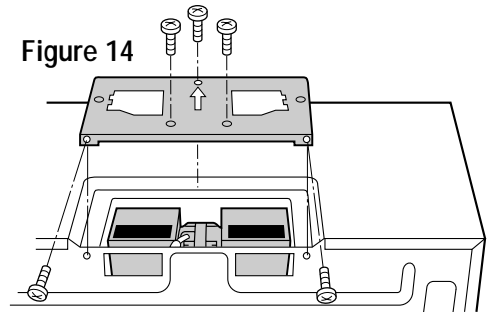
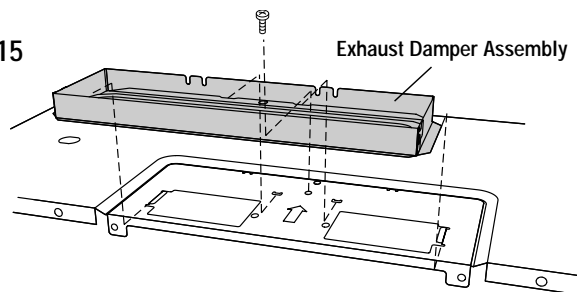

Figure 15



UNPACKING AND INSTALLATION INSTRUCTIONS

9 OVEN INSTALLATION

THIS OVEN CANNOT BE PROPERLY INSTALLED WITHOUT REFERRING TO THE MOUNTING INSTRUCTIONS FOUND ON WALL AND TOP CABINET TEMPLATES.

THE NEXT STEP IS TO READ AND FOLLOW MOUNTING INFORMATION ON WALL AND TOP CABINET TEMPLATES. **THIS OVEN MUST BE ATTACHED TO AT LEAST ONE WALL STUD. SEE WALL CONSTRUCTION ON PAGE 6.**

WHEN DONE WITH TEMPLATES, PROCEED TO MOUNTING SCALE PLATE SECTION.

MOUNTING SCALE PLATE

Attach 2 Scale Plates ⑩ with tape (not included). See Figure 16 and WALL TEMPLATE for locations.

Figure 16

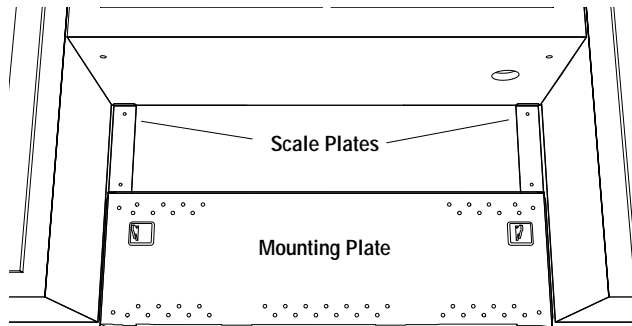

MOUNTING PLATE

1. Separate 4 Toggle Bolts ②, packed in the INSTALLATION HARDWARE, from the Toggle Nuts.
2. Match 5/8" holes (not in studs), drilled through WALL TEMPLATE into wall to corresponding holes on Mounting Plate.
3. Insert Toggle Bolts into matched openings on Mounting Plate. Put Toggle Nuts on Toggle Bolts. See Figure 17.
4. Position the Mounting Plate with the Toggle Bolts attached at the wall location and insert Toggle Nuts and Bolts through the holes in the wall with the Toggle Nuts closed. Figure 18. Use Wood Screws ① to attach the Mounting Plate to studs.

NOTE: Before insertion, be sure you leave a space more than the thickness of the wall between the Mounting Plate and the end of each of the Toggle Nuts (in the closed position). If you do not leave enough space, the Toggle Nut will not be able to open on the other side of the wall. **Also, once a Toggle Nut opens, it cannot be withdrawn from the hole; therefore make sure all of the Toggles are in the correct position before insertion.**

5. Align the Mounting Plate carefully and hold in position while tightening Toggle Bolts. Pull Toggle Bolt toward you and turn clockwise to tighten. Figure 19.

Figure 17

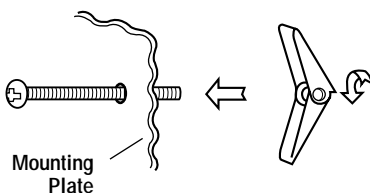

Figure 18

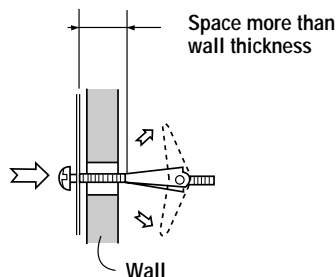
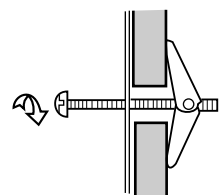

Figure 19



10 PREPARATION AND USE OF THE CARTON TO ASSIST IN THE INSTALLATION OF THE MICROWAVE OVEN

Utilization of the carton may make installation easier.

1. Place carton upside down. See Figure 20.
2. Using cutting line around the carton, cut into two pieces (A) and (B). See Figure 21.
3. Position oven to assist in mounting to the wall. See Figure 22.

Figure 20

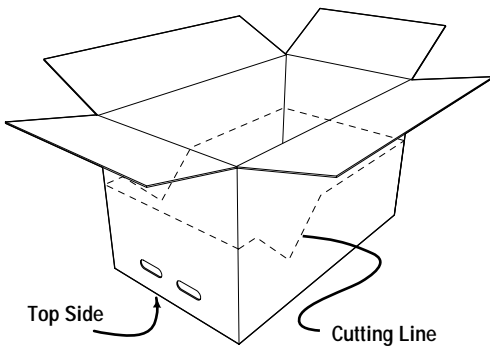

Figure 21

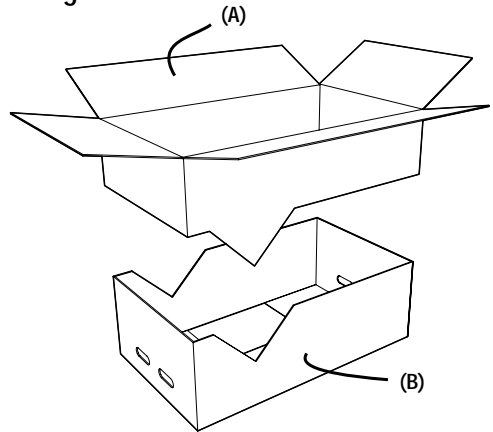
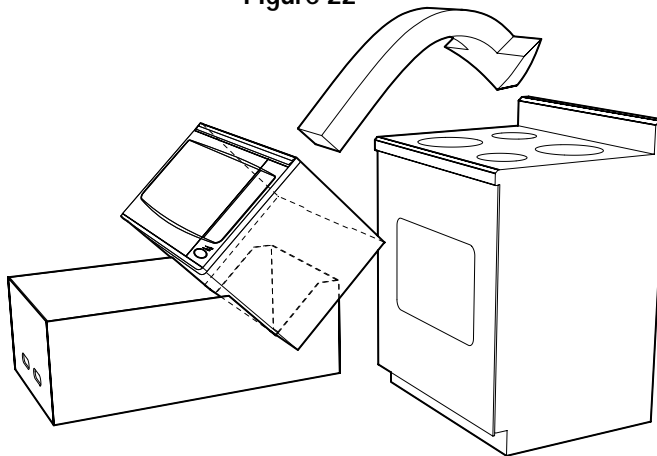

Figure 22



UNPACKING AND INSTALLATION INSTRUCTIONS

MOUNTING OVEN TO THE WALL

Two people are recommended to attach the Microwave Oven/Hood to the Mounting Plate.

1. Thread the Power Supply Cord through the hole made in the bottom of the top cabinet. Install the oven by snapping it onto the Mounting Plate. See Figure 23.
2. Use two Tapping Screws ⑤ to secure the levers that are on the bottom of the oven. See Figure 24.
3. Use two Top Cabinet Screws ③ and two Flat Washers ⑥, supplied in the INSTALLATION HARDWARE, to attach the unit to the top cabinet. See Figure 25.
4. Make a bundle of the Power Supply Cord and attach it to the inside of the cabinet using the Power Cord Hanger ④. See Figure 25.
5. Attach the bottom sash ⑫ to the oven by sliding the two tabs into the rectangular openings located on the bottom front of the oven. See figure 26 (A).
6. Use 5 Tapping Screws 4 x 12mm ⑤ from the INSTALLATION HARDWARE and tighten into place. See Figure 26 (B).

Figure 23

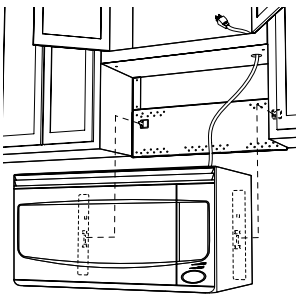

Figure 24

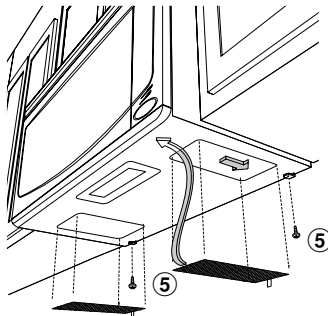

Figure 25

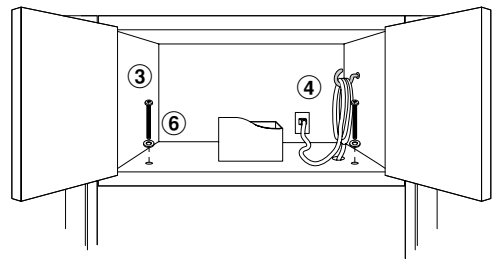
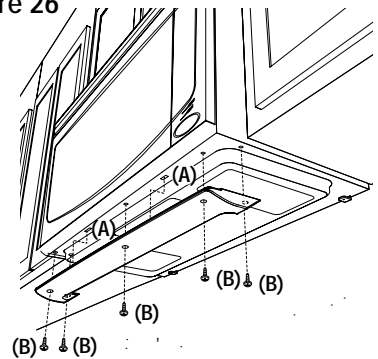

Figure 26



CHECKLIST FOR INSTALLATION

1. Make sure the unit has been installed according to all of the Installation Instructions and the Wall and Top Cabinet Templates.
2. Plug in the power cord.
3. Keep the Operation Manual.

OPTIONAL ACCESSORIES

Two optional accessories are available for this oven.

1. Charcoal Filter (RK-260). This is required when hood exhaust is recirculated. See Charcoal Filter on page 34. If dealer does not stock this item, it can be ordered by calling 1-800-642-2122.
2. Filler Panel Kit. For use when the oven is installed in a 36-inch or 42-inch wide opening. The metal filler panels come in 3-inch wide pairs. One set is needed for a 36-inch opening and 2 sets for a 42-inch opening. White, black, stainless and bisque are available.

To purchase contact: Imperial Cal Products, Inc.
1141 S. Acacia Ave.
Fullerton, CA 92831
Phone: (714) 446-7440 Fax: (714) 446-7444

INFORMATION YOU NEED TO KNOW

ABOUT YOUR OVEN

This Operation Manual is valuable: read it carefully and always save it for reference.

A good microwave cookbook is a valuable asset. Check it for microwave cooking principles, techniques, hints and recipes. See pages 35 and 36 for ordering the Sharp Carousel Microwave Cookbook.

ALWAYS have food in the oven when it is on to absorb the microwave energy.

When using the oven at power levels below 100%, you may hear the magnetron cycling on and off. It is normal for the exterior of the oven to be warm to the touch

when cooking or reheating.

Condensation is a normal part of microwave cooking. Room humidity and the moisture in food will influence the amount of moisture that condenses in the oven. Generally, covered foods will not cause as much condensation as uncovered ones. Ventilation openings must not be blocked.

The oven is for food preparation only. It should not be used to dry clothes or newspapers.

Your oven is rated 1200 watts by using the IEC Test Procedure. In using recipes or package directions, check food a minute or two before the minimum time and add time accordingly.

ABOUT FOOD

FOOD	DO	DON'T
Eggs, sausages, nuts, seeds, fruits & vegetables	<ul style="list-style-type: none">• Puncture egg yolks before cooking to prevent "explosion".• Pierce skins of potatoes, apples, squash, hot dogs and sausages so that steam escapes.	<ul style="list-style-type: none">• Cook eggs in shells.• Reheat whole eggs.• Dry nuts or seeds in shells.
Popcorn	<ul style="list-style-type: none">• Use specially bagged popcorn for the microwave oven.• Listen while popping corn for the popping to slow to 1 or 2 seconds or use special POPCORN pad.	<ul style="list-style-type: none">• Pop popcorn in regular brown bags or glass bowls.• Exceed maximum time on popcorn package.
Baby food	<ul style="list-style-type: none">• Transfer baby food to small dish and heat carefully, stirring often. Check temperature before serving.• Put nipples on bottles after heating and shake thoroughly. "Wrist" test before feeding.	<ul style="list-style-type: none">• Heat disposable bottles.• Heat bottles with nipples on.• Heat baby food in original jars.
General	<ul style="list-style-type: none">• Cut baked goods with filling after heating to release steam and avoid burns.• Stir liquids briskly before heating and allow to stand 20 seconds after heating before stirring or drinking to avoid eruption.• Use deep bowl, when cooking liquids or cereals, to prevent boilovers.	<ul style="list-style-type: none">• Heat or cook in closed glass jars or air tight containers.• Can in the microwave as harmful bacteria may not be destroyed.• Deep fat fry.• Dry wood, gourds, herbs or wet papers.

ABOUT UTENSILS AND COVERINGS

It is not necessary to buy all new cookware. Many pieces already in your kitchen can be used successfully in your new microwave oven. Make sure the utensil does not touch the interior walls during cooking.

Use these utensils for safe microwave cooking and reheating:

- glass ceramic (Pyroceram®), such as Corningware®.
- heat-resistant glass (Pyrex®)
- microwave-safe plastics
- paper plates
- microwave-safe pottery, stoneware and porcelain
- browning dish (Do not exceed recommended preheating time. Follow manufacturer's directions.)

These items can be used for short time reheating of foods that have little fat or sugar in them:

- wood, straw, wicker

DO NOT USE

- metal pans and bakeware
- dishes with metallic trim
- non-heat-resistant glass
- non-microwave-safe plastics (margarine tubs)
- recycled paper products
- brown paper bags
- food storage bags
- metal twist-ties

Should you wish to check if a dish is safe for microwaving, place the empty dish in the oven and microwave on HIGH for 30 seconds. A dish which becomes very hot should not be used.

ABOUT CHILDREN AND THE MICROWAVE

Children below the age of 7 should use the microwave oven with a supervising person very near to them. Between the ages of 7 and 12, the supervising person should be in the same room.

The child must be able to reach the oven comfortably; if not, he/she should stand on a sturdy stool.

At no time should anyone be allowed to lean or swing on the oven door.

The following coverings are ideal:

- Paper towels are good for covering foods for reheating and absorbing fat while cooking bacon.
- Wax paper can be used for cooking and reheating.
- Plastic wrap that is specially marked for microwave use can be used for cooking and reheating. DO NOT allow plastic wrap to touch food. Vent so steam can escape.
- Lids that are microwave-safe are a good choice because heat is kept near the food to hasten cooking.
- Oven cooking bags are good for large meats or foods that need tenderizing. DO NOT use metal twist ties. Remember to slit bag so steam can escape.

How to use aluminum foil in your microwave oven:

- Small flat pieces of aluminum foil placed smoothly on the food can be used to shield areas that are either defrosting or cooking too quickly.
- Foil should not come closer than one inch to any surface of the oven.

Should you have questions about utensils or coverings, check a good microwave cookbook or follow recipe suggestions.

ACCESSORIES There are many microwave accessories available for purchase. Evaluate carefully before you purchase so that they meet your needs. A microwave-safe thermometer will assist you in determining correct doneness and assure you that foods have been cooked to safe temperatures. Sharp is not responsible for any damage to the oven when accessories are used.

Children should be taught all safety precautions: use potholders, remove coverings carefully, pay special attention to packages that crisp food because they may be extra hot.

Don't assume that because a child has mastered one cooking skill he/she can cook everything.

Children need to learn that the microwave oven is not a toy. See page 31 for Child Lock feature.

ABOUT MICROWAVE COOKING

- Arrange food carefully. Place thickest areas towards outside of dish.
- Watch cooking time. Cook for the shortest amount of time indicated and add more as needed. Food severely overcooked can smoke or ignite.
- Cover foods while cooking. Check recipe or cook-book for suggestions: paper towels, wax paper, microwave plastic wrap or a lid. Covers prevent spattering and help foods to cook evenly.
- Shield with small flat pieces of aluminum foil any thin areas of meat or poultry to prevent overcooking before dense, thick areas are cooked thoroughly.
- Stir foods from outside to center of dish once or twice during cooking, if possible.
- Turn foods over once during microwaving to speed cooking of such foods as chicken and hamburgers. Large items like roasts must be turned over at least once.
- Rearrange foods such as meatballs halfway through cooking both from top to bottom and from the center of the dish to the outside.
- Add standing time. Remove food from oven and stir, if possible. Cover for standing time which allows the food to finish cooking without overcooking.
- Check for doneness. Look for signs indicating that cooking temperatures have been reached.

Doneness signs include:

- Food steams throughout, not just at edge.
- Center bottom of dish is very hot to the touch.
- Poultry thigh joints move easily.
- Meat and poultry show no pinkness.
- Fish is opaque and flakes easily with a fork.

ABOUT SAFETY

- Check foods to see that they are cooked to the United States Department of Agriculture's recommended temperatures.
- ALWAYS use potholders to prevent burns when handling utensils that are in contact with hot food. Enough heat from the food can transfer through utensils to cause skin burns.
- Avoid steam burns by directing steam away from the face and hands. Slowly lift the farthest edge of a dish's covering and carefully open popcorn and oven cooking bags away from the face.
- Stay near the oven while it's in use and check cooking progress frequently so that there is no chance of overcooking food.
- NEVER use the cavity for storing cookbooks or other items.
- Select, store and handle food carefully to preserve its high quality and minimize the spread of foodborne bacteria.
- Use care when removing items from the oven so that the utensil, your clothes or accessories do not touch the safety door latches.

TEMP	FOOD
160°F	... for fresh pork, ground meat, boneless white poultry, fish, seafood, egg dishes and frozen prepared food.
165°F	... for leftover, ready-to-reheat refrigerated, and deli and carry-out "fresh" food.
170°F	... white meat of poultry.
180°F	... dark meat of poultry.

To test for doneness, insert a meat thermometer in a thick or dense area away from fat or bone. NEVER leave the thermometer in the food during cooking, unless it is approved for microwave oven use.

PART NAMES

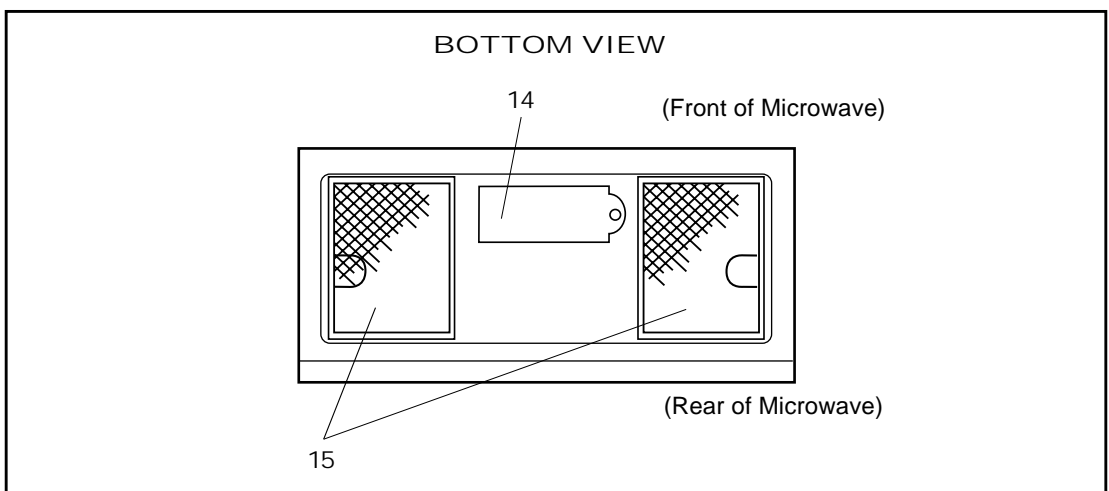
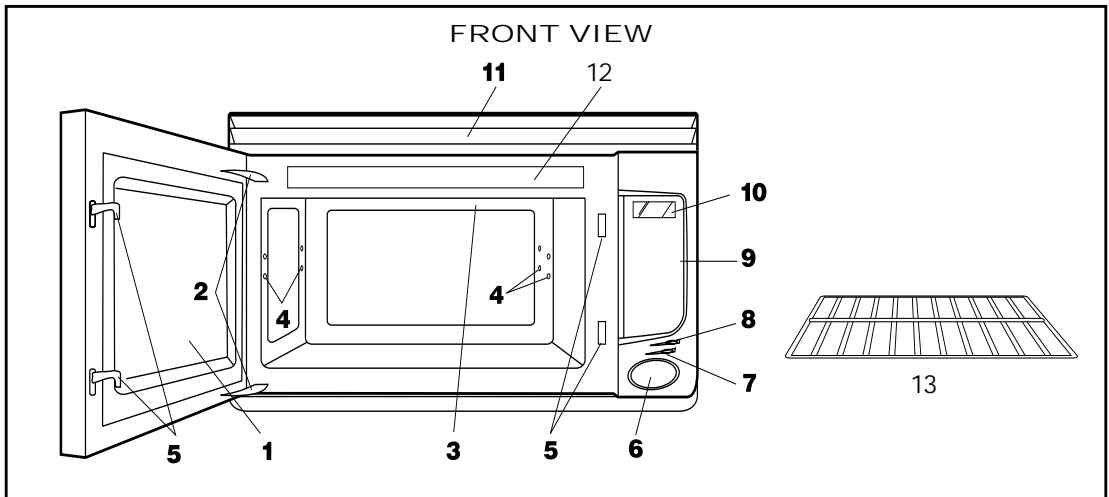

- | | |
|--|---|
| <p>1 Oven door with see-through window</p> <p>2 Door hinges</p> <p>3 Oven light
It will light when oven is operating or door is open.</p> <p>4 Rack holders for two rack positions.</p> <p>5 Safety door latches
The oven will not operate unless the door is securely closed.</p> <p>6 One touch DOOR OPEN button
Push to open door.</p> <p>7 LIGHT HI/LO pad
Press the LIGHT HI/LO pad one time for high, twice for low and three times to turn off.</p> | <p>8 FAN HI/LO pad
Press the FAN HI/LO pad to turn on the fan. Press again for low speed. Press a third time to turn the fan off.</p> <p>9 Auto-Touch control panel</p> <p>10 Time display: Digital interactive display, 99 minutes, 99 seconds</p> <p>11 Ventilation openings</p> <p>12 Menu label</p> <p>13 Rack for 2-level cooking/reheating</p> <p>14 Light cover</p> <p>15 Grease filters</p> |
|--|---|

CONTROL PANEL

Words in the lower portion of the display will light to indicate what function is in progress.

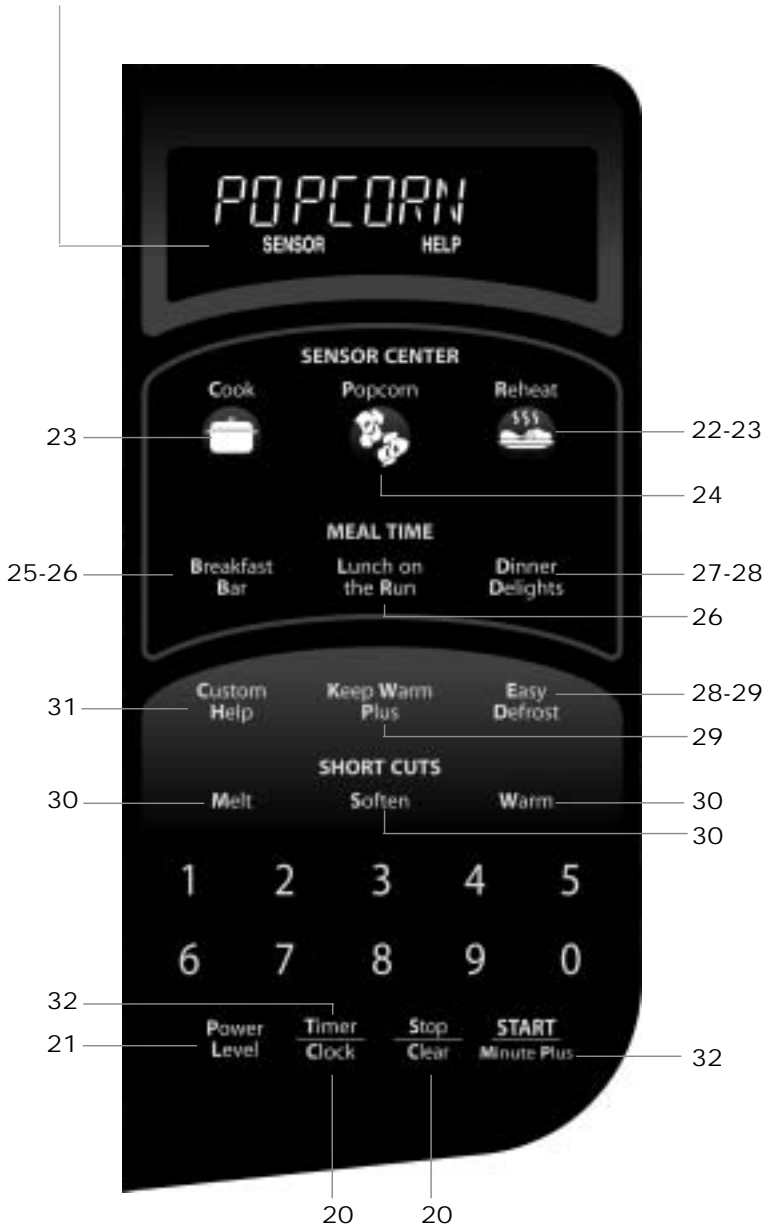

Number next to the control panel illustration indicates pages on which there are feature descriptions and usage information.

BEFORE OPERATING

- Before operating your new microwave oven make sure you read and understand this operation manual completely.
 - Before the oven can be used, follow these procedures:
1. Plug in the oven. Close the door. The oven display will show **ENJOY YOUR OVEN PRESS CLEAR AND PRESS CLOCK**.
 2. Touch the **Stop/Clear** pad. **:** will appear.
 3. Set clock.

TO SET THE CLOCK

- Suppose you want to enter the correct time of day 12:30 (A.M. or P.M.).

PROCEDURE	DISPLAY
1 Touch Timer/Clock pad and number 2 .	TO SET CLOCK PRESS 2
2 Enter the correct time of day by touching the numbers in sequence.	ENTER TIME

3

**Timer
Clock**

12:30

Touch **Timer/Clock** pad again.

This is a 12 hour clock. If you attempt to enter an incorrect clock time, **ERROR** will appear in the display. Touch the **Stop/Clear** pad and re-enter the time.

- If the electrical power supply to your microwave oven should be interrupted, the display will intermittently show after the power is reinstated. If this occurs during cooking, the program will be erased. The time of day will also be erased. Simply touch **Stop/Clear** pad and reset the clock for the correct time of day.

NOTE: Your oven can be programmed with the door open except for **START/Minute Plus** and **Popcorn**.

STOP/CLEAR

Touch the **Stop/Clear** pad to:

1. Erase if you make a mistake during programming.
2. Cancel timer.
3. Stop the oven temporarily during cooking.
4. Return the time of day to the display.
5. Cancel a program during cooking, touch twice.

MANUAL OPERATION

TIME COOKING

Your oven can be programmed for 99 minutes 99 seconds (99.99). Always enter the seconds after the minutes, even if they are both zeros.

- Suppose you want to cook for 5 minutes at 100%.

PROCEDURE	DISPLAY
1 Enter cooking time 5,0,0.	5:00
2 START Minute Plus Touch START/Minute Plus pad.	

TO SET POWER LEVEL

There are eleven preset power levels.

Using lower power levels increases the cooking time which is recommended for foods such as cheese, milk and long slow cooking of meats. Consult cookbook or recipes for specific recommendations.

TOUCH POWER LEVEL PAD NUMBER OF TIMES FOR DESIRED POWER	APPROXIMATE PERCENTAGE OF POWER	COMMON WORDS FOR POWER LEVELS
POWER LEVEL x 1	100%	High
POWER LEVEL x 2	90%	
POWER LEVEL x 3	80%	
POWER LEVEL x 4	70%	Medium High
POWER LEVEL x 5	60%	
POWER LEVEL x 6	50%	Medium
POWER LEVEL x 7	40%	
POWER LEVEL x 8	30%	Med Low/Defrost
POWER LEVEL x 9	20%	
POWER LEVEL x 10	10%	Low
POWER LEVEL x 11	0%	

- Suppose you want to defrost for 5 minutes at 30%.

PROCEDURE	DISPLAY
1 Enter defrosting time 5, 0, 0.	5:00
2 Power Level x 8 Touch Power Level pad eight times to enter a power level of 30%.	P-30
3 START Minute Plus Touch START/Minute Plus pad.	5:00 COOK

When the defrost time is complete, a long tone will sound and **END** will appear in the display.

USING THE RACK

The rack allows several foods to be cooked or reheated at one time. There are two available rack positions. Select the rack position that maximizes space around and between the foods. Follow directions in Sensor Reheat for using the rack for reheating two stirrable casseroles. Otherwise set time and power level manually. Pay close attention to the cooking/reheating progress. Reposition the foods and reverse them from rack to oven bottom at least once during any cooking or reheating time. Using a lower power level will assist in better cooking/reheating uniformity.

AVOID:

- Storing the rack in the microwave oven when not in use.
- Popping popcorn with the rack in the microwave oven.
- Using any browning dish on the rack.
- Using special features, except Sensor Reheat with the rack.
- Cooking directly on the rack—use microwave-safe cookware.

MANUAL DEFROST

If the food that you wish to defrost is not listed on the EASY DEFROST CHART or is above or below the limits in the AMOUNT column on the EASY DEFROST CHART (see pages 28-29), you need to defrost manually.

You can defrost any frozen food, either raw or previously cooked, by using Power Level for 30%. Follow the exact 3-step procedure found under TO SET POWER LEVEL. Estimate defrosting time and press **Power Level** pad eight times for 30% power.

For either raw or previously cooked frozen food the rule of thumb is approximately 4 minutes per pound. For example, defrost 4 minutes for 1 pound of frozen spaghetti sauce.

Always stop the oven periodically to remove or separate the portions that are defrosted. If food is not defrosted at the end of the estimated defrosting time, program the oven in 1 minute increments on Power Level 30% until totally defrosted.

When using plastic containers from the freezer, defrost only long enough to remove from the plastic in order to place in a microwave-safe dish.

SPECIAL FEATURES

SENSOR CENTER

Sharp's Sensor is a semi-conductor device that detects the vapor (moisture and humidity) emitted from the food as it heats. The sensor adjusts the cooking times and power level for various foods and quantities.

Using Sensor Settings:

1. After oven is plugged in, wait 2 minutes before using Sensor Center.
2. Be sure the exterior of the cooking container and the interior of the oven are dry. Wipe off any moisture with a dry cloth or paper towel.
3. The oven works with foods at normal storage temperature. For example, popcorn would be at room temperature.
4. Any Sensor Center selection can be programmed with More or Less Time Adjustment. See page 32.
5. More or less food than the quantity listed in the chart should be cooked following the guidelines in any microwave cookbook.
6. During the first part of any sensor cooking or reheating, food name will appear on the display. Do not open the oven door or touch **Stop/Clear** during this part of the cycle. The measurement of vapor will be interrupted. If this occurs, an error message will appear. To continue cooking, touch the **Stop/Clear** pad and cook manually.

When the sensor detects the vapor emitted from the food, remainder of cooking time will appear. Door may be opened when remaining cooking time appears on the display. At this time, you may stir or season food, as desired.

7. If the sensor does not detect vapor properly when popping popcorn, the oven will turn off, and the correct time of day will be displayed. If the sensor does not detect vapor properly when cooking other foods, **ERROR** will be displayed, and the oven will turn off.
8. Check food for temperature after cooking. If additional time is needed, continue to cook manually.
9. Each food has a cooking hint. Touch **Custom Help** pad when the HELP indicator is lighted in the display.

Covering Foods:

Some foods work best when covered. Use the cover recommended in the food charts.

1. Casserole lid.
2. Plastic wrap: Use plastic wrap recommended for microwave cooking. Cover dish loosely; allow approximately 1/2 inch to remain uncovered to allow steam to escape. Plastic wrap should not touch food.
3. Wax paper: Cover dish completely; fold excess wrap under dish to secure. If dish is wider than paper, overlap two pieces at least one inch to cover.

Be careful when removing any covering to allow steam to escape away from you.

REHEAT

REHEAT allows you to reheat many of your favorite foods. You don't need to calculate cooking time or power level.

- Suppose you want to reheat lasagna.

PROCEDURE

1

Reheat

3

Touch **Reheat** pad, **3** for NO STIR dishes, and then press **START/Minute Plus** pad. When vapors are detected from the food, remainder of reheating time will appear.

2 At end, follow the directions in the display.

NOTE: Sensor Reheat and Popcorn have choices. Follow directions in the Interactive Display to choose desired option.

REHEAT CHART

FOOD

AMOUNT

PROCEDURE

- | | | |
|------------|-----------|---|
| 1. REGULAR | 4 - 36 oz | Place in dish or casserole slightly larger than amount to be reheated. Flatten, if possible. Cover with lid, plastic wrap or wax paper. Use covers such as plastic wrap or lids with larger quantities of more dense foods such as stews. After reheating, stir well, if possible. Re-cover and allow to stand 2 to 3 minutes. Foods should be very hot. If not, continue to heat with variable power and time. |
|------------|-----------|---|

SPECIAL FEATURES

REHEAT CHART CONT.

FOOD	AMOUNT	PROCEDURE
2. WITH STIR	13 x 9 x 2" glass utility casserole	Ideal for reheating stirrable casseroles, such as macaroni and cheese or stew. Cover with vented plastic wrap or wax paper. Place on oven floor. Touch Reheat , the number 2 and START . At signal, stir casserole and rotate dish. Touch START/Minute Plus . At end, stir and allow to stand covered, for 5 to 10 minutes.
3. NO STIR	13 x 9 x 2" glass utility casserole	Ideal for reheating non-stirrable casseroles, such as lasagna. Cover with vented plastic wrap or wax paper. Place on oven floor. Touch Reheat , the number 3 and START . At signal, rotate dish. Touch START/Minute Plus . At end, stir and allow to stand covered, for 5 to 10 minutes.
4. WITH STIR, 2 LEVELS	2-13 x 9 x 2" glass utility casseroles	Ideal for reheating stirrable casseroles, such as macaroni and cheese or stew. Cover with vented plastic wrap or wax paper. Touch Reheat , the number 4 and START . At signal, stir casserole and rotate dishes. Touch START/Minute Plus . At end, stir and allow to stand covered, for 5 to 10 minutes.

COOK

COOK will automatically compute the microwave power and cooking time for foods shown in the chart below. You don't need to enter the weight or quantity of the food.

- Suppose you want to cook a baked potato.

PROCEDURE

1 Cook 1

Touch **Cook** pad and the number **1** for **Baked Potatoes**.

2 At end, follow the directions in the display.

3 START
Minute Plus Touch **START/Minute Plus** pad.

COOK CHART

FOOD	AMOUNT	PROCEDURE
1. Baked Potatoes	1 - 8 med.	Pierce. Place inside oven on a paper-towel. After cooking, remove from oven, wrap in aluminum foil and let stand 5 to 10 minutes.
2. Fresh Vegetables: soft		Wash and place in casserole. Add no water if vegetables have just been washed. Cover with lid for tender vegetables. Use plastic wrap for tender-crisp vegetables. Touch Cook pad and the number 2 . After cooking, stir, if possible. Let stand, covered, for 2 to 5 minutes.
Broccoli	.25 - 2.0 lb	
Brussels sprouts	.25 - 2.0 lb	
Cabbage	.25 - 2.0 lb	
Caulif. (flowerets)	.25 - 2.0 lb	
Cauliflower (whole)	1 med.	
Spinach	.25 - 1.0 lb	
Zucchini	.25 - 2.0 lb	
Baked apples	2 - 4 med.	
3. Fresh Vegetables: hard		Place in casserole. Add 1-4 tbsp water. Cover with lid for tender vegetables. Use plastic wrap cover for tender-crisp vegetables. Touch Cook pad and the number 3 . After cooking, stir, if possible. Let stand, covered, for 2 to 5 minutes.
Carrots, sliced	.25 - 1.5 lb	
Corn on the cob	2 - 4	
Green beans	.25 - 1.5 lb	
Winter squash:		
diced	.25 - 1.5 lb	
halves	1 - 2	

SPECIAL FEATURES

COOK CHART CONT.

FOOD	AMOUNT	PROCEDURE															
4. Frozen Vegetables	.25 - 1.25 lb	Add no water. Cover with lid or plastic wrap. After cooking, stir and let stand covered for 3 minutes.															
5. Frozen Entrees	1 or 2 (6 - 17 oz)	Use this pad for frozen, convenience foods. It will give satisfactory results for most brands. You may wish to try several and choose your favorite. Remove package from outer wrapping and follow package directions for covering. After cooking, let stand, covered for 1 to 3 minutes.															
6. Ground Meat	.25 - 2.0 lb	Use this setting to cook ground beef or turkey as patties or in a casserole to be added to other ingredients. Place patties on a microwave-safe rack and cover with wax paper. Place ground meat in a casserole and cover with wax paper or plastic wrap. When oven stops, turn patties over or stir meat in casserole to break up large pieces. Re-cover and touch START/Minute Plus . After cooking, let stand, covered, for 2 to 3 minutes.															
7. Rice	.5 - 2.0 cups	Place rice into a deep casserole dish and add double quantity of water. Cover with lid or plastic wrap. After cooking, stir, cover and let stand 3 to 5 minutes or until all liquid has been absorbed.															
<table border="1"> <thead> <tr> <th>Rice</th> <th>Water</th> <th>Size of casserole dish</th> </tr> </thead> <tbody> <tr> <td>.5 cup</td> <td>1 cup</td> <td>1.5 quart</td> </tr> <tr> <td>1 cup</td> <td>2 cups</td> <td>2 quart</td> </tr> <tr> <td>1.5 cups</td> <td>3 cups</td> <td>2.5 or 3 quart</td> </tr> <tr> <td>2 cups</td> <td>4 cups</td> <td>3 quart or larger</td> </tr> </tbody> </table>			Rice	Water	Size of casserole dish	.5 cup	1 cup	1.5 quart	1 cup	2 cups	2 quart	1.5 cups	3 cups	2.5 or 3 quart	2 cups	4 cups	3 quart or larger
Rice	Water	Size of casserole dish															
.5 cup	1 cup	1.5 quart															
1 cup	2 cups	2 quart															
1.5 cups	3 cups	2.5 or 3 quart															
2 cups	4 cups	3 quart or larger															
8. Fish/Seafood	.25 - 2.0 lb	Arrange in ring around shallow glass dish (roll fillet with edges underneath). Cover with plastic wrap. After cooking, let stand, covered, 3 minutes.															
9. Chicken Breast	.25 - 2.0 lb	Cover with vented plastic wrap. When oven stops, turn over. Shield with small, flat pieces of aluminum foil any areas that are cooking too rapidly. Re-cover and touch START/Minute Plus . After cooking, let stand, covered 3 to 5 minutes. Chicken should be 160°F.															

POPCORN

POPCORN will automatically compute the microwave power time for popcorn amounts shown in the chart below.

POPCORN CHART

FOOD	AMOUNT	PROCEDURE
Popcorn	2.85 - 3.5 oz bag (Regular or Regular Light)	Use only popcorn packaged for the microwave. Try several brands to decide which you like. Do not try to pop unpoped kernels.
	1.2 - 1.75 oz bag (Mini or Snack)	Touch Popcorn pad once for regular size, touch again for mini or snack size.

PROCEDURE		
1	Popcorn	Touch Popcorn pad once for Regular or Regular Light.
2	Popcorn x 2	Touch Popcorn again for Mini or Snack.

SPECIAL FEATURES

MEAL TIME

Your oven has 3 convenient pads to assist with meal preparation. There are some foods under Breakfast Bar and Lunch on the Run that use the sensor. See the Sensor Center information on page 22. For foods not using the sensor, follow the directions in the Interactive Display to enter quantity.

NOTE FOR SPECIAL FEATURES:

1. All Meal Time features can be programmed with More or Less Time Adjustment. Touch the **Power Level** pad once or twice before touching **START/Minute Plus** pad. See page 32.
2. Each food has a cooking hint. Touch **Custom Help** pad when the HELP indicator is lighted in the display.
3. Should you attempt to enter more or less than the allowed amount, an error message will appear in the display.
More or less than the quantity listed in the chart should be cooked following the guidelines in any microwave cookbook.
4. The final cooking result will vary according to the food condition (e.g. initial temperature, shape, quality). Check food for temperature after cooking. If additional time is needed, continue to cook manually.

1. BREAKFAST BAR

BREAKFAST BAR is for preparing popular breakfast foods.

- Suppose you want to use Breakfast Bar to cook 2 servings of hot cereal.

PROCEDURE	DISPLAY
1 Breakfast Bar 5	HOT CEREAL
Touch Breakfast Bar pad and 5 , for hot cereal.	
2 2	ENTER NUMBER
If you want to cook 2 servings, touch 2 pad.	
3 START Minute Plus	Touch START/Minute Plus pad
4 After cooking, follow the directions in display.	

BREAKFAST BAR CHART

FOOD	AMOUNT	PROCEDURE
1. Beverage	.5 - 2.0 cups	This setting is good for restoring a cool beverage to a better drinking temperature. Touch Breakfast Bar pad and number 1 for beverage. Touch number 1 pad for a 0.5 cup increase per touch and press START/Minute Plus pad. Stir after heating.
2. Rolls/ Muffins:	1 - 10 pieces	Use this pad to warm rolls, muffins, biscuits, bagels etc. Large items should be considered as 2 or 3 regular size. Arrange on plate: cover with paper towel. For refrigerated rolls or muffins, it may be necessary to double the entered amount to ensure the proper serving temperature. For example, enter quantity of 2 for 1 refrigerated muffin. To warm fresh rolls and muffins, touch Breakfast Bar pad and touch number 2 for rolls and muffins. Then enter desired quantity and touch START/Minute Plus pad.
3. Frozen Breakfast*	1 or 2 (3 - 6 oz)	This setting works well for frozen breakfast entrees, pancakes, waffles, burritos etc. Follow manufacturer's directions for how to prepare for microwaving. Allow to stand 1 or 2 minutes after cooking.

* IT IS NOT NECESSARY TO ENTER AMOUNT OR NUMBER.

SPECIAL FEATURES



BREAKFAST BAR CHART CONT.

FOOD	AMOUNT	PROCEDURE
4. Scrambled Eggs	1 - 8 eggs	For each egg, use 1 teaspoon of butter or margarine and 1 tablespoon of milk. Place butter or margarine in dish, measuring cup or casserole large enough for the egg to expand. Mix egg and milk together. Pour on to butter or margarine in dish. Place in oven and program. When audible signals are heard, stir egg mixture moving the cooked portion to the center of the dish and uncooked portion to the outside. After cooking, stir and let stand, covered, until set. Note that eggs will be slightly undercooked when removed from the oven.
5. Hot Cereal	1 - 6 servings	Use individual packets or bulk cereal in your favorite variety: oatmeal, oat bran, cream of wheat, farina or wheatena. Follow package directions for the correct amount of water or milk. To prevent boilovers, it is very important to choose a large container because microwave cooking of cereal causes high boiling. When oven stops, stir and touch START/Minute Plus . After cooking, stir and let stand, covered, for 2 minutes.

2. LUNCH ON THE RUN

LUNCH ON THE RUN is for cooking/heating foods that take a short amount of time!

- Suppose you want to use Lunch on the Run to heat 2 cups of soup.

PROCEDURE	DISPLAY
1  	
Touch Lunch on the Run pad and  for soup.	

2   	Touch START/Minute Plus pad.
3 After cooking, follow the directions in display.	

LUNCH ON THE RUN CHART

FOOD	AMOUNT	PROCEDURE
1. Chicken Nuggets	0.3 - 1 lb	Place frozen chicken nuggets on a flat plate allowing space between each. It is not necessary to cover them.
2. Frozen Snacks*	1 or 2 (3 - 8 oz)	Use for frozen poppers, cheese sticks, appetizers, chicken wings, etc. Remove from outer package. Follow package directions for how to wrap or cover. Be careful when removing from the oven as snack may be very hot.
3. Pizza	1 (6 - 8 oz)	Use for frozen microwave pizza. Remove from package and unwrap. Follow package directions for use of package and/or silver crisping disk.
4. Hot dogs* in buns	1 - 6	Place hot dog in bun. Wrap each with paper towel or napkin.
5. Soup*	1 - 8 cups	Place in bowl or casserole. Cover with lid or plastic wrap. At end, stir, re-cover and let stand 1 to 3 minutes.

* IT IS NOT NECESSARY TO ENTER AMOUNT OR NUMBER.

SPECIAL FEATURES

3. DINNER DELIGHTS

DINNER DELIGHTS will cook any of the dinners listed in the chart by simply following the directions in the Interactive Display and on the Recipe Card. Follow Recipe Card for ingredients and instructions.

- Suppose you want to use DINNER DELIGHTS to cook Yellow Rice and Chicken.

PROCEDURE		DISPLAY	
1	Dinner Delights [1]	YELLOW	RICE
Touch Dinner Delights pad and [1], for Yellow Rice and Chicken.			
2	See recipe card for directions.		
3	START Minute Plus	PRESS	START
Touch START/Minute Plus pad.			

DINNER DELIGHT RECIPES (RECIPES SERVE 6)

1. YELLOW RICE AND CHICKEN

Place in a 3 quart casserole:

- 1 package (5 - 8 ounces) yellow rice mix with flavor packet
- 2 cups chicken broth

Stir well and cover. Touch **DINNER DELIGHTS**, number [1] and touch **START/Minute Plus**.

At pause, stir well and add:

- 1 cup frozen peas
- 1 red pepper, diced
- 1 1/4 pounds boneless chicken cutlets, sliced into thin strips

Re-cover. Touch **START/Minute Plus**.

At end, garnish with parsley.

2. DRESSED-UP MEAT LOAF

Mix together well:

- 1 1/2 pounds lean ground beef
- 1/2 cup soft bread crumbs
- 1/2 cup red wine
- 1 egg, beaten
- 2 tablespoons chopped onion
- 1/2 teaspoon salt
- 1/2 teaspoon dry mustard
- 1/4 teaspoon pepper
- 1 teaspoon instant beef bouillon
- 2 tablespoons chopped green pepper

Place in a 9 x 5-inch glass loaf dish.

Touch **DINNER DELIGHTS**, number [2] and touch **START/Minute Plus**.

If desired, spread top of meat loaf with 1/2 cup catsup during last 2 minutes of cooking time.

At end, remove from oven, cover with foil and allow to stand 3 to 5 minutes before serving.

3. HERB ROAST PORK

Combine in small dish:

- 1 tablespoon butter, melted
- 2 cloves garlic, minced
- 1 teaspoon dried marjoram leaves, crushed
- 1/2 teaspoon dried oregano leaves, crushed
- 1/2 teaspoon pepper

Stir well. Brush on:

- 1 (3 pound) boneless, pork loin, center cut

Place loin in a 13 x 9 x 2-inch casserole. Cover with vented plastic wrap.

Touch **DINNER DELIGHTS**, number [3] and touch **START/Minute Plus**.

4. CREAMY SEAFOOD PASTA

Place in a 3 quart casserole:

- 8 - 9 ounces fresh tortellini
- 2 cups water

Stir well and cover. Touch **DINNER DELIGHTS**, number [4] and touch **START/Minute Plus**.

At pause, stir well and add:

- 1 jar (17 ounces) creamy Alfredo sauce or 1 3/4 cups of medium, white cheese sauce
- 1 1/4 pounds combination raw shellfish, fresh or thawed (shrimp, bay scallops, crabmeat)
- 3 cups mixed, fresh vegetables (sliced mushrooms, thinly julienned carrots, green beans)

Re-cover. Touch **START/Minute Plus**.

At end, garnish with:

- 1/3 cup grated Parmesan cheese

SPECIAL FEATURES

5. ORZO VEGETARIAN MEDLEY

Place in a 3 quart casserole:

- 1 cup orzo or other tiny shaped pasta
- 3 1/2 cups vegetable or chicken broth
- 1/4 cup pesto sauce (fresh or reconstituted from dry)
- 1/2 cup small pieces of sundried tomatoes
- 1 tablespoon minced garlic
- 1 tablespoon Italian seasoning

Stir well and cover. Touch **DINNER DELIGHTS**, number **5** and touch **START/Minute Plus**.

At pause, stir well and add:

- 3 cups chopped green, red, orange or yellow peppers
- 1 onion, thinly sliced
- 1 can (14 ounces) artichoke hearts, drained and quartered
- 1 can (3 ounces) pitted, ripe olives, drained and halved

Re-cover. Touch **START/Minute Plus**.

At end, stir and garnish top with:

- 1/2 cup freshly shredded Parmesan cheese
- 1/4 cup pine nuts

EASY DEFROST

EASY DEFROST automatically defrosts all the foods found in the EASY DEFROST CHART below.

- Suppose you want to defrost a 2.0 pound steak.

PROCEDURE	DISPLAY
1	<div style="display: flex; align-items: center; gap: 10px;"> <div style="border: 1px solid black; padding: 2px;">Easy Defrost</div> <div style="border: 1px solid black; padding: 2px;">2</div> <div style="border: 1px solid black; padding: 2px;">STEAKS</div> <div style="border: 1px solid black; padding: 2px;">CHOPS</div> </div> <p>Touch Easy Defrost pad and 2, for steak.</p>
2	<div style="display: flex; align-items: center; gap: 10px;"> <div style="border: 1px solid black; padding: 2px;">2</div> <div style="border: 1px solid black; padding: 2px;">0</div> <div style="border: 1px solid black; padding: 2px;">ENTER</div> <div style="border: 1px solid black; padding: 2px;">WEIGHT</div> </div> <p>Enter weight by touching the number pads 2 and 0. (Ex: 2.0 lb steak.)</p>
3	<p>Touch START/Minute Plus pad. The oven will stop so the food can be checked. The display will show:</p> <div style="display: flex; align-items: center; gap: 10px;"> <div style="border: 1px solid black; padding: 2px;">COVER</div> <div style="border: 1px solid black; padding: 2px;">EDGES</div> </div>
4	<div style="display: flex; align-items: flex-start;"> <div style="border: 1px solid black; padding: 2px; margin-right: 10px;"> START Minute Plus </div> <p>After the 1st stage, open the door. Turn steak over and shield any warm portions. Close the door. Touch START/Minute Plus pad.</p> </div>

5 **START Minute Plus** After the 2nd stage, open the door. Shield any warm portions. Close the door. Touch **START/Minute Plus** pad.

6 After defrost cycle ends, let stand, covered.

NOTE:

1. To defrost other food or foods above or below the weights allowed on the EASY DEFROST CHART, use time and 30% power. See Manual Defrost on page 21.
2. EASY DEFROST can be programmed with More or Less Time Adjustment. Touch the **Power Level** pad once or twice before touching **START/Minute Plus** pad.
3. Touch **Custom Help** pad when the HELP indicator is lighted in the display for a helpful hint.
4. If you attempt to enter more or less than the amount as indicated in the chart below, an error message will appear in the display.

EASY DEFROST CHART

FOOD	AMOUNT	PROCEDURE
1. Ground Meat	.5 - 2.0 lb	Remove any thawed pieces after each stage. Let stand, covered, for 5 to 10 minutes.
2. Steaks/Chops	.5 - 3.0 lb	After each stage, rearrange and if there are warm or thawed portions, shield with small flat pieces of aluminum foil. Remove any meat or fish that is almost defrosted. Let stand, covered, for 10 to 20 minutes.
3. Rolls/Muffins	1 - 10	Use this pad to defrost rolls, muffins, biscuits, bagels etc. Large items should be considered as 2 or 3 regular size. Arrange on plate; cover with paper towel.

SPECIAL FEATURES

EASY DEFROST CHART CONT.

FOOD	AMOUNT	PROCEDURE
4. Boneless Poultry	.5 - 2.0 lb	Use boneless breast of chicken or turkey. After each stage, if there are warm or thawed portions, rearrange or remove. Let stand, covered, for 5 to 10 minutes.
5. Bone-in Poultry	.5 - 3.0 lb	Arrange pieces with meatiest portions toward outside of glass dish or microwave safe rack. After each stage, if there are warm or thawed portions, rearrange or remove. Let stand, covered, for 5 to 15 minutes.

NOTE: Check foods when oven signals. After final stage, small sections may still be icy. Let stand to continue thawing. Do not defrost until all ice crystals are thawed.

Shielding prevents cooking from occurring before the center of the food is defrosted. Use small smooth strips of aluminum foil to cover edges and thinner sections of the food.

KEEP WARM PLUS

KEEP WARM PLUS allows you to keep food warm for 30 minutes.

DIRECT USE

- Suppose you want to keep a cup of soup warm for 30 minutes.

PROCEDURE	DISPLAY
1 Keep Warm Plus Touch Keep Warm Plus pad.	ENTER TIME
2 3 0 0 0 Enter the desired time. (30:00)	
3 START Minute Plus Touch START/Minute Plus pad.	

The oven will start. The display will show **30:00** and count down. **KEEP WARM** will be displayed during the countdown.

You can program Keep Warm Plus with manual cooking to keep food warm continuously after cooking.

WITH MANUAL COOKING

- Suppose you want to cook a cup of soup for 2 minutes at 70% and keep the soup warm for 15 minutes.

PROCEDURE	DISPLAY
1 2 0 0 Enter cooking time.	
2 Power Level x 4 Touch Power Level pad 4 times for 70% power.	P-70
3 Keep Warm Plus Touch Keep Warm Plus pad.	
4 1 5 0 0 Enter the desired time. (15:00)	ENTER TIME
5 START Minute Plus Touch START/Minute Plus pad.	

The operation will start. When the cooking time is complete, a long tone will sound and Keep Warm Plus will start. **KEEP WARM** will appear in the display every 10 seconds and count down for 15 minutes.

NOTE: Keep Warm Plus cannot be programmed with SPECIAL FEATURES.

SPECIAL FEATURES

SHORT CUTS

SHORT CUTS automatically compute the correct heating time and microwave power level for melting, softening and warming foods shown in the chart.

- Suppose you want to melt 1 square of chocolate.

PROCEDURE	DISPLAY
1 Melt Touch Melt once.	
2 2 Select desired food by touching number pad. (Ex: Touch 2 for chocolate.)	CHOCO- LATE

3 **2** x 2 **SELECT** **QTY**

Repeat touching same number pad to select quantity. (Ex: Touch **2** two more times for 1 square.)

4 **START** **Minute Plus** Touch **START/Minute Plus** pad.

NOTE:

1. To melt, soften or warm other food or foods except the quantity listed in the SHORT CUTS CHART, use manual operation.
2. Short Cuts can be programmed with More or Less Time Adjustment. See page 32.

SHORT CUTS CHART

FOOD	AMOUNT	PROCEDURE
Melt		Use a Pyrex measuring cup. Cover with plastic wrap.
1. Butter	2 tbsp 1/2 cup	After touching MELT , touch 1 two times for 2 tbsp. After touching MELT , touch 1 three times for 1/2 cup.
2. Chocolate	1 cup chips 1 square	After touching MELT , touch 2 two times for 1 cup chips. After touching MELT , touch 2 three times for 1 square.
Soften		DO NOT COVER.
1. Ice cream	1 pint 1/2 gallon	After touching SOFTEN , touch 1 two times for 1 pint. After touching SOFTEN , touch 1 three times for 1/2 gallon.
2. Cream cheese	3 oz. 8 oz.	After touching SOFTEN , touch 2 two times for 3 oz. After touching SOFTEN , touch 2 three times for 8 oz.
Warm		Use a Pyrex measuring cup. DO NOT COVER.
1. Syrup	1/4 cup 1/2 cup	After touching WARM , touch 1 two times for 1/4 cup. After touching WARM , touch 1 three times for 1/2 cup.
2. Dessert topping	1/4 cup 1/2 cup	After touching WARM , touch 2 two times for 1/4 cup. After touching WARM , touch 2 three times for 1/2 cup.

OTHER CONVENIENT FEATURES

CUSTOM HELP

CUSTOM HELP provides 4 features that make using your oven easy because specific instructions are provided in the interactive display.

1. CHILD LOCK

The CHILD LOCK prevents unwanted oven operation such as by small children. The oven can be set so that the control panel is deactivated or locked. To set, touch **Custom Help**, the number **1** and then touch the **START/Minute Plus** pad. Should a pad be touched, **CHILD LOCK ON** will appear in the display.

To cancel, touch **Custom Help** and **Stop/Clear** pad.

2. AUDIBLE SIGNAL ELIMINATION

If you wish to have the oven operate with no audible signals, touch **Custom Help**, the number **2** and **Stop/Clear**.

To cancel and restore the audible signal, touch **Custom Help**, the number **2** and **START/Minute Plus**.

3. AUTO START

If you wish to program your oven to begin cooking automatically at a designated time of day, follow this procedure:

- Suppose you want to start cooking a stew for 20 minutes on 50% at 4:30. Before setting, check to make sure the clock is showing the correct time of day.

PROCEDURE	
1 Touch Custom Help pad.	Custom Help
2 Touch number 3 .	3
3 Enter the start time.	4 3 0
4 Touch Clock pad.	Timer Clock
5 Touch Power Level pad six times for 50% power.	2 0 0 0 Power Level x 6
6 Touch START/Touch On pad.	START Minute Plus

NOTE:

- Auto Start can be used for manual cooking if clock is set.
- If the oven door is opened after programming Auto Start, it is necessary to touch the **START/Minute Plus** pad for Auto Start time to appear in the readout so that the oven will automatically begin programmed cooking at the chosen Auto Start time.

- Be sure to choose foods that can be left in the oven safely until the Auto Start time. Acorn or butternut squash are often a good choice.
- If you wish to know the time of day, simply touch the **Timer/Clock** pad. As long as your finger is touching the **Timer/Clock** pad, the time of day will be displayed.

4. LANGUAGE SELECTION

The oven comes set for English and U.S. Customary Unit-pounds. To change, touch **Custom Help** and the number **4**. Continue to touch the number **4** until your choice is selected from the table below. Then, touch **START/Minute Plus** pad.

NUMBER	LANGUAGE	DISPLAY
Once	English	ENGLISH
Twice	Spanish	ESPANOL

MULTIPLE SEQUENCE COOKING

Your oven can be programmed for up to 4 automatic cooking sequences, switching from one power level setting to another automatically.

Sometimes cooking directions tell you to start on one power level and then change to a different power level. Your oven can do this automatically.

- Suppose you want to cook roast beef for 5 minutes at 100% and then continue to cook for 30 minutes at 50%.

- First enter cooking time. Then touch **Power Level** once for 100% power.
- Then enter second cooking time. Touch **Power Level** pad 6 times for 50% power.
- Touch **START/Minute Plus** pad.

NOTE:

- If **Power Level** pad is touched, **P-HI** will be displayed.
- If 100% is selected as the final sequence, it is not necessary to touch the **Power Level** pad.
- Keep Warm Plus can be programmed even if 4 cooking sequences have been set.

OTHER CONVENIENT FEATURES

DEMONSTRATION MODE

To demonstrate, touch **Timer/Clock**, the number **0** and then touch the **START/Minute Plus** pad and hold for three seconds. **DEMO ON** will appear in the display. Cooking operations and specific special features can now be demonstrated with no power in the oven. For example, touch **Minute Plus** pad and the display will show **1:00** and count down quickly to **END**.

To cancel, touch **Timer/Clock**, the number **0** and **Stop/Clear** pads. If easier, unplug the oven from the electrical outlet and replug.

MINUTE PLUS

MINUTE PLUS allows you to cook for a minute at 100% by simply touching the **START/Minute Plus** pad. You can also extend cooking time in multiples of 1 minute by repeatedly touching the **START/Minute Plus** pad during manual cooking.

- Suppose you want to heat a cup of soup for one minute.

PROCEDURE	
1	Touch START/MINUTE PLUS pad. 

NOTE:

1. To use **Minute Plus**, touch pad within 3 minutes after cooking, closing the door, touching the **Stop/Clear** pad or during cooking.
2. Minute Plus cannot be used with special features.

LIGHT HI/LO

Press the **Light Hi/Lo** pad one time for high, twice for low and three times to turn off.

FAN HI/LO

The fan will automatically start when heat rises from range surface units or burners. This protects the microwave oven from excessive temperature rise. The fan will stay on until the temperature decreases. It cannot be turned off manually during this time.

For other uses, press **Fan Hi/Lo** pad one time for high, twice for low and three times to turn off.

MORE OR LESS TIME ADJUSTMENT

Should you discover that you like any of the Sensor Center, Meal Time, Short Cuts or Easy Defrost settings slightly **more** done, touch the **Power Level** pad **once** after touching your choice of pads or before touching **START/Minute Plus** pad.





The display will show **MORE**.

Should you discover that you like any of the Sensor Center, Meal Time, Short Cuts or Easy Defrost settings slightly **less** done, touch the **Power Level** pad **twice** after touching your choice of pads or before touching **START/Minute Plus** pad.

The display will show **LESS**.

TIMER

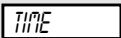
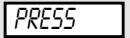
- Suppose you want to time a 3-minute long distance phone call.

PROCEDURE	DISPLAY
1  1	 
Touch Timer/Clock pad and number 1 .	
2 3 0 0	 
Enter time.	
3 	Touch Timer/Clock pad. The timer will count down. To cancel the timer, touch the Stop/Clear pad once.

HELP

Each setting has a cooking hint. If you wish to check, touch **Custom Help** whenever HELP is lighted in the Interactive Display for these and other manual operation hints.

CLEANING AND CARE

Disconnect the power cord before cleaning or leave the door open to inactivate the oven during cleaning.

Exterior

The outside surface is precoated steel and plastic. Clean the outside with mild soap and water; rinse and dry with a soft cloth. Do not use any type of household or abrasive cleaner.

Door

Wipe the window on both sides with a damp cloth to remove any spills or splatters. Metal parts will be easier to maintain if wiped frequently with a damp cloth. Avoid the use of spray and other harsh cleaners as they may stain, streak or dull the door surface.

Touch Control Panel

Wipe the panel with a cloth dampened slightly with water only. Dry with a soft cloth. Do not scrub or use any sort of chemical cleaners. Close door and touch **Stop/Clear**.

Interior

Cleaning is easy because little heat is generated to the interior surfaces; therefore, there is no baking and setting of spills or spattering. To clean the interior surfaces, wipe with a soft cloth and warm water. **DO NOT USE ABRASIVE OR HARSH CLEANERS OR SCOURING PADS.** For heavier soil, use baking soda or a mild soap; rinse thoroughly with hot water. The rack can be cleaned with hot soapy water, rinsed and dried.

Odor Removal

Occasionally, a cooking odor may remain in the oven. To remove, combine 1 cup water, grated peel and juice of 1 lemon and several whole cloves in a 2-cup glass measuring cup. Boil for several minutes using 100% power. Allow to set in oven until cool. Wipe interior with a soft cloth.

Grease Filters

Filters should be cleaned at least once a month. Never operate the fan or oven without the filters in place.

1. Pull down slightly on the tab toward the center of the oven and remove the filter. Repeat for the other filter.
2. Soak the filters in a sink or dish pan filled with hot water and detergent. **DO NOT** use ammonia or other alkali; they will react with the filter material and darken it.
3. Agitate and scrub with a brush to remove embedded dirt.
4. Rinse thoroughly and shake dry.
5. Replace by fitting the filter back into the opening.

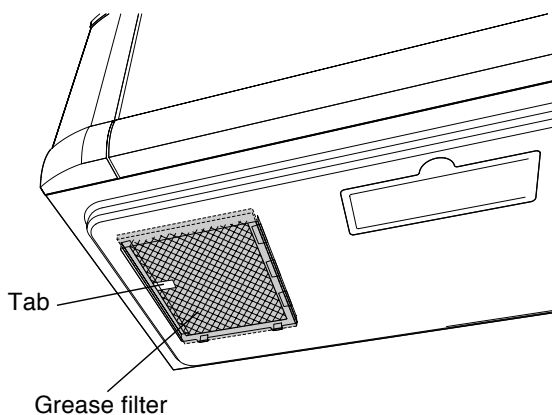

REPLACING PARTS

CHARCOAL FILTER

Charcoal Filter, Sharp part number RK-260 which was installed in your oven, is used for nonvented, recirculated installation. The filter should be changed every 6 to 12 months depending on use. See page 14 for ordering information.

1. Disconnect power to the oven at the circuit breaker panel or by unplugging.
2. Remove the three louver mounting screws and push down carefully on the tab at each end of the louver to disengage it. (See illustration.)
3. Pull the louver away from the unit.
4. Change the charcoal filter.
5. Carefully push the louver back into place (engaging both the bottom and top tabs) and replace the screws removed in step 2.

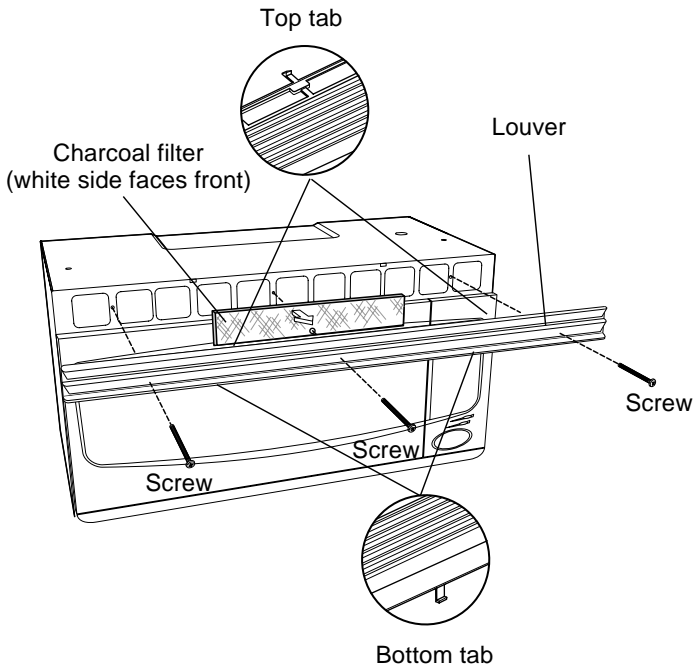

LIGHT BULBS

1. To replace light bulbs, first disconnect power to the oven at the circuit breaker panel or by unplugging.
2. To release cover, remove the screw on the light cover. (See illustration.)
3. Replace light bulbs with equivalent watt bulb available from your Sharp Authorized Servicer or parts distributor. Bulbs are also available at most hardware stores or lighting centers. **DO NOT USE A BULB LARGER THAN 30 WATTS.**
4. Close light cover and secure with screw removed in step 2.

CAUTION: Light cover may become very hot. Do not touch glass when light is on.

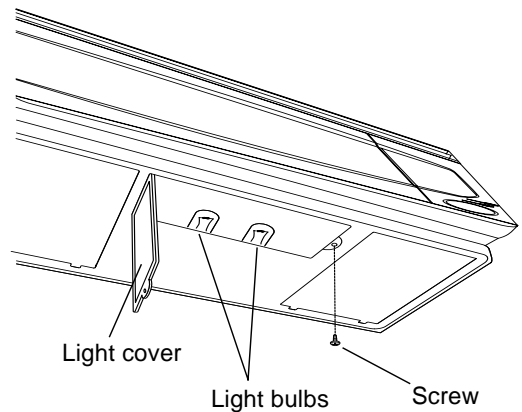

SERVICE CALL CHECK

Please check the following before calling for service:

Place one cup of water in a glass measuring cup in the oven and close the door securely.
Operate the oven for one minute at HIGH 100%.

- A Does the oven light come on? YES _____ NO _____
- B Does the cooling fan work? YES _____ NO _____
(Put your hand over the left side of louver.)
- C Is the water in the oven warm? YES _____ NO _____

If “NO” is the answer to any of the above questions, please check electrical outlet, fuse and/or circuit breaker. If they are functioning properly, CONTACT YOUR NEAREST SHARP AUTHORIZED SERVICER. A microwave oven should never be serviced by a “do-it-yourself” repair person.

NOTE: If time appearing in the display is counting down very rapidly, check Demonstration Mode on page 32 and cancel.

COOKBOOK INFORMATION

- ✦ Great recipes
- ✦ Reliable microwave reference guide
- ✦ Many color photos
- ✦ Step-by-step instructions
- ✦ Nutritional information for each recipe
- ✦ Durable wipe-clean soft cover with 128 8 1/2 x 11 pages
- ✦ Helpful tips and special techniques

SHARP® CAROUSEL MICROWAVE COOKBOOK

TO ORDER

Simply call this toll-free number : **1-800-642-2122**. Please have your credit card ready.

If you prefer to order by mail, complete and return the order form on page 36. Please include check or money order (payable to Sharp Accessories & Supplies Center) for \$6.00 plus \$4.25 shipping & handling and tax, if applicable, per book.

SATISFACTION GUARANTEED

You must be completely satisfied with the Sharp Carousel Microwave Cookbook. If, within 14 days, you are dissatisfied for any reason, simply return the book and we'll gladly refund your \$6.00 plus tax.

(SOLAMENTE ESCRITO EN INGLES!)

SPECIFICATIONS

R-2120J / R-2130J

AC Line Voltage:	Single phase 120V, 60Hz, AC only
AC Power Required:	1400 watts, 12.0 amps.
Output Power:*	1200 watts
Frequency:	2450 MHz
Outside Dimensions:	29 7/8"(W) x 17 3/8"(H) x 15 5/8"(D)
Cavity Dimensions:	22 9/16"(W) x 10 9/16"(H) x 15"(D)
Oven Capacity:	2.1 Cu. Ft.
Weight:	Approx. 50 lb

★ The International Electrotechnical Commission's standardized method for measuring output wattage. This test method is widely recognized.

In compliance with standards set by:

FCC – Federal Communications Commission Authorized.

DHHS – Complies with Department of Health and Human Services (DHHS) rule, CFR, Title 21, Chapter I, Subchapter J.



– This symbol on the nameplate means the product is listed by Underwriters Laboratories, Inc.

----- Cut along this line. -----

COOKBOOK ORDER FORM

Please send me _____ cookbooks at \$10.25 each \$ _____

Illinois sales tax, (if applicable) per book \$.44 no. of books _____ \$ _____

Other tax, (if applicable) no. of books _____ \$ _____

TOTAL ORDER AMOUNT \$ _____

I have enclosed a check made payable to Sharp Accessories & Supplies Center.

Please bill my VISA MASTERCARD AMERICAN EXPRESS

Acct. No. _____ Expiration date ____ / ____

Signature _____

(All credit card orders must be signed.)

Name _____

Address _____

City _____ State _____ Zip _____

Daytime Phone No. () _____

Mail to: SHARP Accessories & Supplies Center
2130 Townline Road
Peoria, Illinois 61615-1560

Price is subject to change without notice.

GUIA AUTO-TOUCH

Para mayor informacion y precauciones de seguridad, consulte el Manual de Operaciones.

PONER LA HORA (CLOCK)

Si el indicador dice **ENJOY YOUR OVEN PRESS CLEAR** **AND PRESS CLOCK** toque primero el botón **Stop/Clear**.

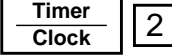
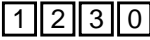
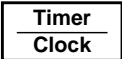
- 1 Toque el botón que dice **Timer/Clock** y número **2**. 
- 2 Ajuste el reloj en la hora correcta oprimiendo los botones numéricos en el orden respectivo. (Ej: 12:30) 
- 3 Toque nuevamente el botón que dice **Timer/Clock**. 



COCCIÓN (COOK)

- 1 Pulse la tecla **SENSOR CENTER Cook** y el numero **6** para Carne Molida. 
- 2 Pulse la tecla **START/Minute Plus**. 

COCCIÓN TABLA

TIPO DE COMIDA	CANTIDAD
1. Papa Asada	1 a 8 med.
2. Verdura: (suave)	0,25 a 2,0 libras
3. Verdura: (firme)	0,25 a 1,5 libras
4. Verdura Congel.	0,25 a 1,25 libras
5. Plato Fuerte Congel.	1 o 2 (6 a 17 onzas)
6. Carne Molida	0,25 a 2,0 libras
7. Arroz	0,5 a 2,0 tazas
8. Pescado/Mariscos	0,25 a 2,0 libras
9. Pechuga de Pollo	0,25 a 2,0 libras

RECALENTAR (REHEAT)

- 1 Pulse la tecla **Reheat** y el numero **3** para Lasagna. 
- 2 Pulse la tecla **START/Minute Plus**. 



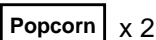

RECALENTAR TABLA

TIPO DE COMIDA	CANTIDAD
1. Regular	4 a 36 onzas
2. Revolver	caseroles de vidrio de 13 x 9 x 2"
3. No Revolver	caseroles de vidrio de 13 x 9 x 2"
4. Revolver 2 Niveles	2 - caseroles de vidrio de 13 x 9 x 2"

PALOMITAS DE MAÍZ

- 1 Pulse el botón **Popcorn** una vez para regular y ligero regular. 
- 2 Pulse el botón **Popcorn** dos veces para mini y bocadillos. 



BREAKFAST BAR

- 1 Pulse el botón **Breakfast Bar**. 
- 2 Seleccione la comida deseada. (Ej: toque el botón **5** para volver a cereal caliente.) 
- 3 Toque el botón número **2** para dos raciones. 
- 4 Pulse la tecla **START/Minute Plus**. 

BREAKFAST BAR TABLA

TIPO DE COMIDA	CANTIDAD
1. Bebida	0,5 a 2,0 tazas
2. Pan/Molletes	1 a 10
3. Desayunos Congelados	1 a 2 (3 a 6 onzas)
4. Huevos Revueltos	1 a 8 huevos
5. Cereal Caliente	1 a 6 porciones

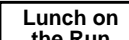
LUNCH ON THE RUN

- 1 Pulse el botón **Lunch on the Run**. 
- 2 Seleccione la comida deseada. (Ej: toque el botón **5** para sopa.) 
- 3 Pulse la tecla **START/Minute Plus**. 



LUNCH ON THE RUN TABLA

TIPO DE COMIDA	CANTIDAD
1. Nuggets de Pollo	0,3 a 1,0 libras
2. Bocadillos Congelados	1 a 2 (3 a 8 onzas)
3. Pizza	1 (6 a 8 onzas)
4. Hot Dog en su pan	1 a 6
5. Sopa	1 a 8 tazas

MINUTE PLUS

- Oprima **START/Minute Plus** para obtener un minuto al 100% de energia o para agregar otro minuto durante el cocimiento manual. Vuelva a oprimirlo para obtener minutos adicionales. 

PLACERES DE LA CENA (DINNER DELIGHTS)

- 1 Pulse el botón **Dinner Delights**. 
- 2 Seleccione la comida deseada.
(Ej: toque el botón  para carne picada.)
- 3 Pulse la tecla **START/Minute Plus**. 





DINNER DELIGHTS TABLA

Placeres de la Cena Receta (Todos menús para 6 raciones)

1. Arroz Amarillo y Pollo
2. Carne Dres Especial
3. Cerdo a las Finas Hierbas
4. Pasta Cremosa con Mariscos
5. Platillo Vegetariano

CONSULTE LA TARJETA DE RECETAS PARA CONOCER DETALLES.

FACIL DE DESCONGELAR (EASY DEFROST)

- 1 Pulse el botón **Easy Defrost** una vez que y el numero  para Bistec/Costillas. Incorpore el peso. (Ej: toque 2,0 libras) Pulse a tecla **START/Minute Plus**.    

El horno se detendrá automáticamente y en la pantalla podrá observar diversas indicaciones. Siga los mensajes indicados.

- 2 Después de concluir la 1ra etapa, abra la puerta y levante el bistec, limpie el agua, coloque nuevamente el bistec. Cierre la puerta. Pulse la tecla **START/Minute Plus**. 















- 3 Después de la 2 da etapa, abra la puerta y repita el proceso del paso 2. Cierre la puerta. Pulse la tecla **START/Minute Plus**. 

- 4 Después que el ciclo de descongelamiento concluya, deje reposar el alimento.





EASY DEFROST TABLA

TIPO DE COMIDA	CANTIDAD
1. Carne Molida	0,5 a 2,0 libras
2. Bistec/Chuleta	0,5 a 3,0 libras
3. Pan/Molletes	1 a 10
4. Pollo sin Hueso	0,5 a 2,0 libras
5. Pollo con Hueso	0,5 a 3,0 libras

KEEP WARM PLUS

- 1 Pulse la tecla **Keep Warm Plus**, esta funcion trabaja hasta por 30 minutos. 
 - 2 Capture el tiempo deseado.
(Ej: 25:00)    
 - 3 Pulse la tecla **START/Minute Plus**. 
- Cocimiento Con del Manual   
- 1 Marque el tiempo de cocimiento. 
 - 2 Pulse el botón **Power Level** cuatro veces para la energía 70%.
 - 3 Pulse la tecla **Keep Warm Plus**. 
 - 4 Capture el tiempo deseado.
(Ej: 25:00)    
 - 5 Pulse la tecla **START/Minute Plus**. 

PEQUEÑOS CORTES (SHORT CUTS)

- 1 Pulse el botón **Melt** una vez que. 
- 2 Seleccione el alimento deseado oprimir los numero. (Ej: toque el botón  para chocolate.)
- 3 Repita tocando el mismo numero para seleccionar la Cantidad. (Ej: toque dos veces el botón  para uno cuadrado.)  x 2
- 4 Pulse la tecla **START/Minute Plus**. 

SHORT CUTS TABLA

TIPO DE COMIDA	CANTIDAD
Derrita	
1. Mantequilla	2 tbsp o 1/2 taza
2. Chocolate	1 taza cuadritos o 1 cuadro
Suavice	
1. Helado	1 pinta o 1/2 galón
2. Crema de Queso	3 o 8 oz.
Caliente	
1. Jarabe	1/4 o 1/2 taza
2. Cubierta de Postre	1/4 o 1/2 taza

AUTO-TOUCH GUIDE



For more complete information and safety precautions, refer to your Operation Manual.

SET CLOCK

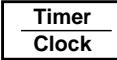
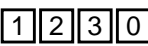
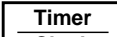
If **ENJOY YOUR OVEN** **PRESS CLEAR AND PRESS** **CLOCK** is in the display, first touch **Stop/Clear**.

- 1 Touch **Timer/Clock** pad and number **2**.  **2**
- 2 Enter correct time of the day by touching numbers in sequence. (Ex: 12:30) 
- 3 Touch **Timer/Clock** pad again. 



COOK

- 1 Touch **SENSOR CENTER Cook** pad and number **6** for Ground Meat.  **6**
- 2 Touch **START/Minute Plus** pad. 

COOK CHART

FOOD	AMOUNT
1. Baked Potatoes	1 - 8 med
2. Fresh Vegetables (soft)	.25 - 2.0 lb
3. Fresh Vegetables (hard)	.25 - 1.5 lb
4. Frozen Vegetables	.25 - 1.25 lb
5. Frozen Entrees	1 or 2 (6 - 17 oz)
6. Ground Meat	.25 - 2.0 lb
7. Rice	.5 - 2.0 lb
8. Fish/Seafood	.25 - 2.0 lb
9. Chicken Breast	.25 - 2.0 lb

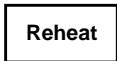
REHEAT

- 1 Touch **Reheat** pad and number **3** for Lasagna.  **3**
- 2 Touch **START/Minute Plus** pad. 



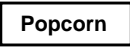

REHEAT CHART

FOOD	AMOUNT
1. Regular	4 - 36 oz.
2. With Stir	13 x 9 x 2" glass utility casserole
3. No Stir	13 x 9 x 2" glass utility casserole
4. With Stir, 2 Levels	2 - 13 x 9 x 2" glass utility casseroles

POPCORN

- 1 Touch **Popcorn** pad once for Regular or Regular Light. 
- 2 Touch **Popcorn** pad twice for Mini or Snack.  x 2



BREAKFAST BAR

- 1 Touch **Breakfast Bar** pad. 
- 2 Select desired food. (Ex: touch **5** for hot cereal.) 
- 3 Touch number **2** pad for 2 servings. 
- 4 Touch **START/Minute Plus** pad. 

BREAKFAST BAR CHART

FOOD	AMOUNT
1. Beverage	.5 - 2 cups
2. Rolls/Muffins	1 - 10 pieces
3. Frozen Breakfast	1 - 2 (3 - 6 oz)
4. Scrambled Eggs	1 - 8 eggs
5. Hot Cereal	1 - 6 servings

LUNCH ON THE RUN

- 1 Touch **Lunch on the Run** pad. 
- 2 Select desired food. (Ex: touch **5** for soup.) 
- 3 Touch **START/Minute Plus** pad. 

LUNCH ON THE RUN CHART



FOOD	AMOUNT
1. Chicken Nuggets	.3 - 1 lb
2. Frozen Snacks	1 - 2 (3 - 8 oz)
3. Pizza	1 (6 - 8 oz)
4. Hot Dogs in buns	1 - 6
5. Soup	1 - 8 cups

MINUTE PLUS

- Touch **START/Minute Plus** for one minute at 100% power or to add a minute during manual cooking. Continue to touch for additional minutes. 

AUTO-TOUCH GUIDE

DINNER DELIGHTS

- 1 Touch **Dinner Delights** pad. 
- 2 Select desired food.
(Ex: touch  for Dressed-up Meat Loaf.)
- 3 Touch **START/Minute plus** pad. 







DINNER DELIGHTS CHART

Dinner Delight Recipes (All are for 6 servings)

1. Yellow Rice and Chicken
2. Dressed-up Meat Loaf
3. Herb Roast Pork
4. Creamy Seafood Pasta
5. Orzo Vegetarian Medley

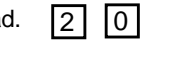
SEE RECIPE CARD FOR DETAILS.









EASY DEFROST

- 1 Touch **Easy Defrost** pad once and number  to select Steaks/Chops. Enter weight. (Ex: 2.0 lb.) Touch **START/Minute Plus** pad.   
The oven will stop and directions will be displayed. Follow the indicated message.
- 2 After the 1st stage, open the door, turn steak over and shield any warm portions. Close the door. Touch **START/Minute Plus** pad. 
- 3 After the 2nd stage, open the door and shield any warm portions. Close the door. Touch **START/Minute Plus** pad. 
- 4 After defrost cycle ends, cover and let stand. 



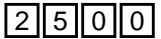

EASY DEFROST CHART

FOOD	AMOUNT
1. Ground Meat	.5 - 2.0 lb
2. Steaks/Chops	.5 - 3.0 lb
3. Rolls/Muffins	1 - 10
4. Boneless Poultry	.5 - 2.0 lb
5. Bone-in Poultry	.5 - 3.0 lb

KEEP WARM PLUS

- 1 Touch **Keep Warm Plus** pad to keep food warm for up to 30 minutes. 
 - 2 Enter the desired time.
(Ex: 25:00) 
 - 3 Touch **START/Minute Plus** pad. 
- With Manual Cooking**
- 1 Enter cooking time. 
 - 2 Touch **Power Level** pad 4 times for 70% power. 
 - 3 Touch **Keep Warm Plus** pad. 
 - 4 Enter the desired time.
(Ex: 25:00) 
 - 5 Touch **START/Minute Plus** pad. 

SHORT CUTS

- 1 Touch **Melt** pad once. 
- 2 Select desired food by touching number pad. (Ex: Touch  for chocolate.)
- 3 Repeat touching same number pad to select quantity. (Ex: Touch  x 2 two more times for 1 square.)
- 4 Touch **START/Minute Plus** pad. 

SHORT CUTS CHART

FOOD	AMOUNT
Melt	
1. Butter	2 tbsp or 1/2 cup
2. Chocolate	1 cup chips or 1 square
Soften	
1. Ice Cream	1 pint or 1/2 gallon
2. Cream Cheese	3 or 8 oz.
Warm	
1. Syrup	1/4 or 1/2 cup
2. Dessert Topping	1/4 or 1/2 cup

Free Manuals Download Website

<http://myh66.com>

<http://usermanuals.us>

<http://www.somanuals.com>

<http://www.4manuals.cc>

<http://www.manual-lib.com>

<http://www.404manual.com>

<http://www.luxmanual.com>

<http://aubethermostatmanual.com>

Golf course search by state

<http://golfingnear.com>

Email search by domain

<http://emailbydomain.com>

Auto manuals search

<http://auto.somanuals.com>

TV manuals search

<http://tv.somanuals.com>