

SHARP®

OPERATION MANUAL

LIQUID CRYSTAL TELEVISION

ENGLISH

LC-13SH6U/LC-15SH6U/LC-20SH6U



Products that have earned the ENERGY STAR® are designed to protect the environment through superior energy efficiency.

ENHANCED DEFINITION TELEVISION

EDTV MONITOR

Model No.:



Serial No.:

IMPORTANT:

To aid reporting in case of loss or theft, please record the TV's model and serial numbers in the space provided. The numbers are located at the rear of the TV.

IMPORTANT INFORMATION

WARNING: TO REDUCE THE RISK OF FIRE OR ELECTRIC SHOCK, DO NOT EXPOSE THIS PRODUCT TO RAIN OR MOISTURE.

	CAUTION RISK OF ELECTRIC SHOCK DO NOT OPEN	
<p>CAUTION: TO REDUCE THE RISK OF ELECTRIC SHOCK, DO NOT REMOVE COVER (OR BACK). NO USER-SERVICEABLE PARTS INSIDE. REFER SERVICING TO QUALIFIED SERVICE PERSONNEL.</p>		



The lightning flash with arrow-head symbol, within an equilateral triangle, is intended to alert the user to the presence of uninsulated "dangerous voltage" within the product's enclosure that may be of sufficient magnitude to constitute a risk of electric shock to persons.

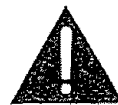

The exclamation point within a triangle is intended to alert the user to the presence of important operating and maintenance (servicing) instructions in the literature accompanying the product.

CAUTION: TO PREVENT ELECTRIC SHOCK, MATCH WIDE BLADE OF PLUG TO WIDE SLOT, FULLY INSERT.

CAUTION:

DO NOT PLACE THIS PRODUCT ON AN UNSTABLE CART, STAND, TRIPOD, BRACKET, OR TABLE. THE PRODUCT MAY FALL CAUSING SERIOUS PERSONAL INJURY AND SERIOUS DAMAGE TO THE PRODUCT. USE ONLY WITH A CART, STAND, TRIPOD, BRACKET, OR TABLE RECOMMENDED BY THE MANUFACTURER OR SOLD WITH THE PRODUCT. FOLLOW THE MANUFACTURER'S INSTRUCTIONS WHEN INSTALLING THE PRODUCT AND USE MOUNTING ACCESSORIES RECOMMENDED BY THE MANUFACTURER. A PRODUCT AND CART COMBINATION SHOULD BE MOVED WITH CARE. QUICK STOPS, EXCESSIVE FORCE, AND UNEVEN SURFACES MAY CAUSE THE PRODUCT AND CART COMBINATION TO OVERTURN.

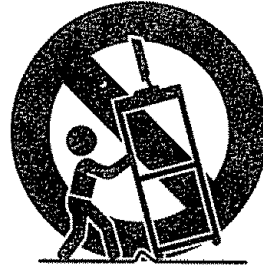

WARNING: FCC Regulations state that any unauthorized changes or modifications to this equipment not expressly approved by the manufacturer could void the user's authority to operate this equipment.

U.S.A. ONLY

"Note to CATV system installer: This reminder is provided to call the CATV system installer's attention to Article 820-40 of the National Electrical Code that provides guidelines for proper grounding and, in particular, specifies that the cable ground shall be connected to the grounding system of the building, as close to the point of cable entry as practical."

U.S.A. ONLY

This product utilizes tin-lead solder, and fluorescent lamp containing a small amount of mercury. Disposal of these materials may be regulated due to environmental considerations. For disposal or recycling information, please contact your local authorities or the Electronic Industries Alliance; www.eia.org

DEAR SHARP CUSTOMER

Thank you for your purchase of the Sharp Liquid Crystal Television. To ensure safety and many years of trouble-free operation of your product, please read the Important Safety Precautions carefully before using this product.

IMPORTANT SAFETY PRECAUTIONS

Electricity is used to perform many useful functions, but it can also cause personal injuries and property damage if improperly handled. This product has been engineered and manufactured with the highest priority on safety. However, improper use can result in electric shock and/or fire. In order to prevent potential danger, please observe the following instructions when installing, operating and cleaning the product. To ensure your safety and prolong the service life of your LCD color TV product, please read the following precautions carefully before using the product.

- Read instructions—All operating instructions must be read and understood before the product is operated.
- Keep this manual in a safe place—These safety and operating instructions must be kept in a safe place for future reference.
- Observe warnings—All warnings on the product and in the instructions must be observed closely.
- Follow instructions—All operating instructions must be followed.
- Attachments—Do not use attachments not recommended by the manufacturer. Use of inadequate attachments can result in accidents.
- Power source—This product must operate on a power source specified on the specification label. If you are not sure of the type of power supply used in your home, consult your dealer or local power company. For units designed to operate on batteries or another power source, refer to the operating instructions.
- AC cord protection—The AC cords must be routed properly to prevent people from stepping on them or objects from resting on them. Check the cords at the plugs and product.
- Overloading—Do not overload AC outlets or extension cords. Overloading can cause fire or electric shock.
- Entering of objects and liquids—Never insert an object into the product through vents or openings. High voltage flows in the product, and inserting an object can cause electric shock and/or short internal parts. For the same reason, do not spill water or liquid on the product.
- Servicing—Do not attempt to service the product yourself. Removing covers can expose you to high voltage and other dangerous conditions. Request a qualified service person to perform servicing.
- Repair—If any of the following conditions occurs, unplug the AC cord from the AC outlet, and request a qualified service person to perform repairs:
 - a. When the AC cord or plug is damaged.
 - b. When a liquid was spilled on the product or when objects have fallen into the product.
 - c. When the product has been exposed to rain or water.
 - d. When the product does not operate properly as described in the operating instructions.
Do not touch the controls other than those described in the operating instructions. Improper adjustment of controls not described in the instructions can cause damage, which often requires extensive adjustment work by a qualified technician.
 - e. When the product has been dropped or damaged.
 - f. When the product displays an abnormal condition. Any noticeable abnormality in the product indicates that the product needs servicing.
- Replacement parts—In case the product needs replacement parts, make sure that the service person uses replacement parts specified by the manufacturer, or those with the same characteristics and performance as the original parts. Use of unauthorized parts can result in fire, electric shock and/or other danger.
- Safety checks—Upon completion of service or repair work, request the service technician to perform safety checks to ensure that the product is in proper operating condition.
- Wall or ceiling mounting—When mounting the product on a wall or ceiling, be sure to install the product according to the method recommended by the manufacturer.
- Polarization—This AC cord may be equipped with a polarized alternating current line plug (a plug having one blade wider than the other). This plug will fit into the power outlet only one way. This is a safety feature. If you are unable to insert the plug fully into the outlet, try reversing the plug. If the plug should still fail to fit, contact your electrician to replace your obsolete outlet.
Do not defeat the safety purpose of the polarized plug.
- Cleaning—Unplug the AC cord from the AC outlet before cleaning the product. Use a damp cloth to clean the product. Do not use liquid cleaners or aerosol cleaners.
- Water and moisture—Do not use the product near water, such as bathtub, washbasin, kitchen sink and laundry tub, swimming pool and in a wet basement.
- Stand—Do not place the product on an unstable cart, stand, tripod or table. Placing the product on an unstable base can cause the product to fall, resulting in serious personal injuries as well as damage to the product. Use only a cart, stand, tripod, bracket or table recommended by the manufacturer or sold with the product. When mounting the product on a wall, be sure to follow the manufacturer's instructions. Use only the mounting hardware recommended by the manufacturer.

- ⊠ When relocating the product placed on a cart, it must be moved with utmost care. Sudden stops, excessive force and uneven floor surface can cause the product to fall from the cart.
- ⊠ Ventilation—The vents and other openings in the cabinet are designed for ventilation. Do not cover or block these vents and openings since insufficient ventilation can cause overheating and/or shorten the life of the product. Do not place the product on a bed, sofa, rug or other similar surface, since they can block ventilation openings. This product is not designed for built-in installation; do not place the product in an enclosed place such as a bookcase or rack, unless proper ventilation is provided or the manufacturer's instructions are followed.
- ⊠ The Liquid Crystal panel used in this product is made of glass. Therefore, it can break when the product is dropped or applied with impact. Be careful not to be injured by broken glass pieces in case the Liquid Crystal panel breaks.
- ⊠ Heat sources—Keep the product away from heat sources such as radiators, heaters, stoves and other heat-generating products (including amplifiers).
- ⊠ The Liquid Crystal panel is a very high technology product with 921,600 thin film transistors, giving you fine picture details.



Occasionally, a few non-active pixels may appear on the screen as a fixed point of blue, green or red. Please note that this does not affect the performance of your product.

- ⊠ If an outside antenna is connected to the television equipment, be sure the antenna system is grounded so as to provide some protection against voltage surges and built-up static charges. Section 810 of the National Electrical Code provides information with respect to proper grounding of the mast and supporting structure, grounding of the lead-in wire to an antenna discharge unit, size of grounding conductors, location of antenna-discharge unit, connection to grounding electrodes, and requirements for the grounding electrode.



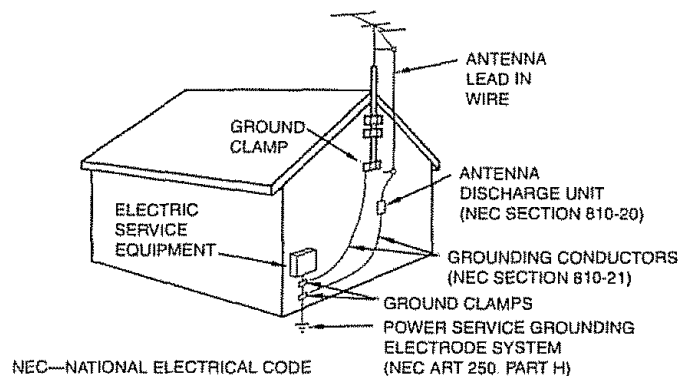

EXAMPLE OF ANTENNA GROUNDING AS PER
NATIONAL ELECTRICAL CODE

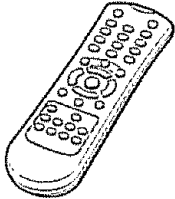

- ⊠ Lightning — For added protection for this television equipment during a lightning storm, or when it is left unattended and unused for long period of time, unplug it from the wall outlet and disconnect the antenna. This will prevent damage to the equipment due to lightning and power-line surges.
- ⊠ Power Lines — An outside antenna system should not be located in the vicinity of overhead power lines or other electric light or power circuits, or where it can fall into such power lines or circuits. When installing an outside antenna system, extreme care should be taken to keep from touching such power lines or circuits as contact with them might be fatal.
- ⊠ To prevent fire, never place any type of candle or flames on the top or near the TV set.
- ⊠ To prevent fire or shock hazard, do not expose this product to dripping or splashing. No objects filled with liquids, such as vases, should be placed on the product.
- ⊠ To prevent fire or shock hazard, do not place the AC cord under the TV set or other heavy items.
- ⊠ Do not display a still picture for a long time, as this could cause an afterimage to remain.
- ⊠ Install the product on the place where the AC cord can be unplugged easily from the AC outlet, or from the AC INPUT terminal on the rear of the product.

Supplied Accessories

Make sure the following accessories are provided with the LCD TV set

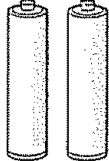
Wireless remote control	Cable clamp	AC cord	"AAA" size batteries (x2)
		 (LC-13SH6U)  (LC-15SH6U/LC-20SH6U)	

Preparation

Installing Batteries in the Remote Control

Before using the LCD TV set for the first time, install the two "AAA" size batteries (supplied) in the remote control. When the batteries become depleted and the remote control fails to operate, replace the batteries with new "AAA" size batteries

- 1 Open the battery cover
- 2 Insert two "AAA" size batteries
- 3 Close the battery cover

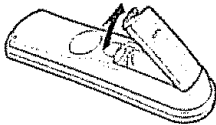

- Detach the cover while pressing the (▼) part.

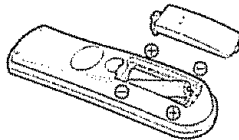

- Place batteries with their terminals corresponding to the (+) and (-) indications in the battery compartment

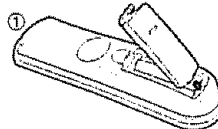

- Align the tab on the battery cover (①) and place it while pressing the tab (②) to close it.

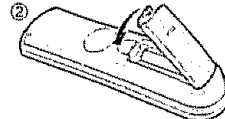

⚠ Caution!

Precautions regarding batteries

Improper use of batteries can result in a leakage of chemicals and/or explosion. Be sure to follow the instructions below.

- Place batteries with their terminals corresponding to the (+) and (-) indications
- Different types of batteries have different characteristics. Do not mix batteries of different types
- Do not mix old and new batteries. Mixing old and new batteries can shorten the life of new batteries and/or cause old batteries to leak chemicals.
- Remove batteries as soon as they are depleted. Chemicals that leak from batteries can cause a rash. If chemical leakage is found, wipe it off with a cloth.
- The batteries supplied with the LCD TV set may have a shorter operating time due to storage conditions.
- If the remote control is not to be used for an extended period of time, remove the batteries from the remote control.

Using the Remote Control

Use the remote control by pointing it towards the remote sensor window of the main unit. Objects between the remote control and sensor window may prevent proper operation.

Cautions regarding use of the remote control

- Do not apply shock to the remote control. In addition, do not expose the remote control to liquids, and do not place it in an area with high humidity.
- Do not install or place the remote control under direct sunlight. The heat may cause deformation of the unit.
- The remote control may not work properly if the remote sensor window is under direct sunlight or strong lighting. In such a case, change the angle of the lighting or main unit, or operate the remote control closer to the remote sensor window.

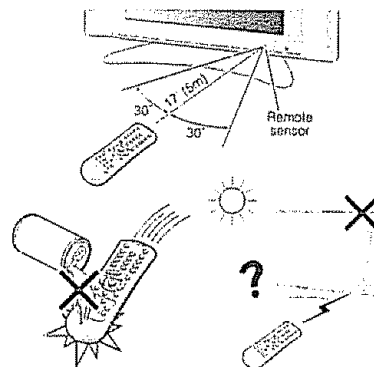

Antenna Connection

ANTENNAS

- The antenna requirements for good color television reception are more important than those for black & white television reception. For this reason, a good quality outdoor antenna is strongly recommended. The following is a brief explanation of the type of connections that are provided with the various antenna systems.

1 A 75-ohm system is generally a round cable with F-type connector that can easily be attached to a terminal without tools (not supplied).

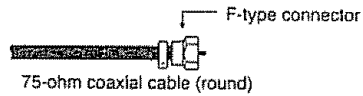

2 A 300-ohm system is a flat "twin-lead" cable that can be attached to a 75-ohm terminal through a 300/75-ohm adapter (not supplied).

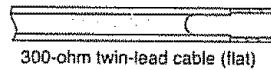

OUTDOOR ANTENNA CONNECTION

- Use one of the following two diagrams if you connect an outdoor antenna.
 - A: Using a VHF/UHF combination outdoor antenna
 - B: Using separate VHF and/or UHF outdoor antennas
- Connect the outdoor antenna cable lead-in to ANT (Antenna terminal) on the rear of the main unit.

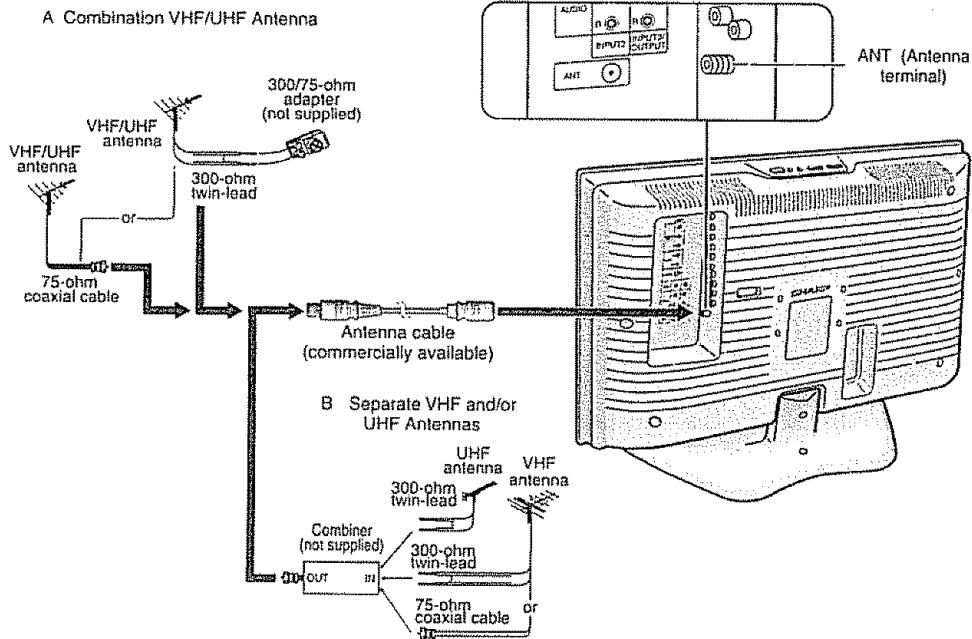

NOTICE

F-type connector

F-type connector should be finger-tightened only.



When connecting the RF cable to the LCD TV set, do not tighten F-type connector with tools. If tools are used, it may cause damage to your LCD TV set. (The breaking of internal circuit, etc.)

Antenna Connection (Continued)

CABLE TV (CATV) CONNECTION

- A 75-ohm coaxial cable connector is built into the set for easy hookup. When connecting the 75-ohm coaxial cable to the set, screw the 75-ohm cable to the ANT terminal.
- Some cable TV companies offer "premium pay channels." Since the signals of these premium pay channels are scrambled, a cable TV converter/descrambler is generally provided to the subscriber by the cable TV company. This converter/descrambler is necessary for normal viewing of the scrambled channels. (Set your TV to channel 3 or 4, typically one of these channels is used. If this is unknown, consult your cable TV company.) For more specific instructions on installing cable TV, consult your cable TV company. One possible method of utilizing the converter/descrambler provided by your cable TV company is explained below. Please note: An RF switch provided with two inputs (A and B) is required (not supplied).

"A" position on the RF switch (not supplied): You can view all unscrambled channels by using the TV's channel keys.
"B" position on the RF switch (not supplied): You can view the scrambled channels via the converter/descrambler by using the converter's channel keys.

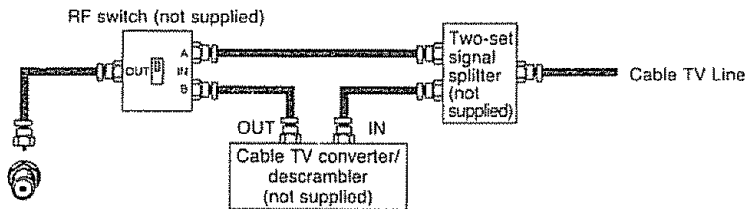

NOTE

- Consult your SHARP Dealer or Service Center for the type of splitter, RF switch or combiner that might be required.

Power Connection

Connect to the POWER INPUT terminal of the LCD TV set using the AC cord (supplied)

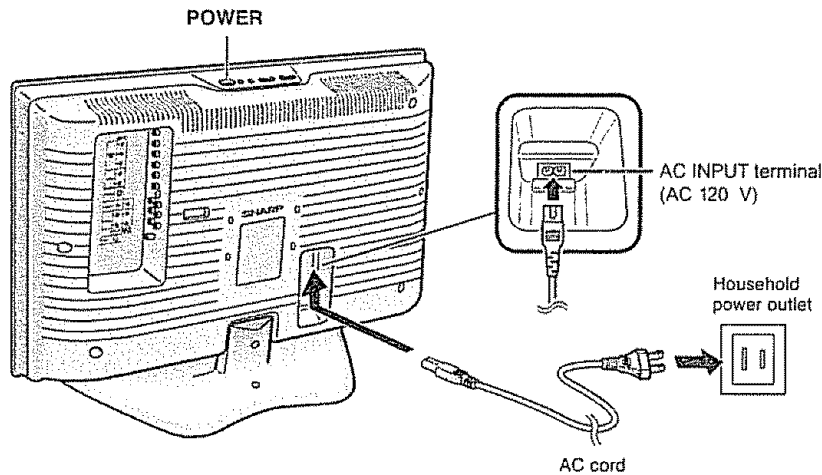

NOTE

- Unplug the AC cord from the power outlet when the LCD TV set is not to be used for a long period of time.

Part Names of Main Unit

The examples used throughout this manual are based on the LC-20SH6U model.

Controls

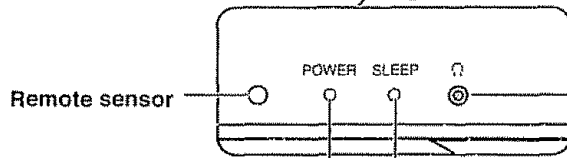
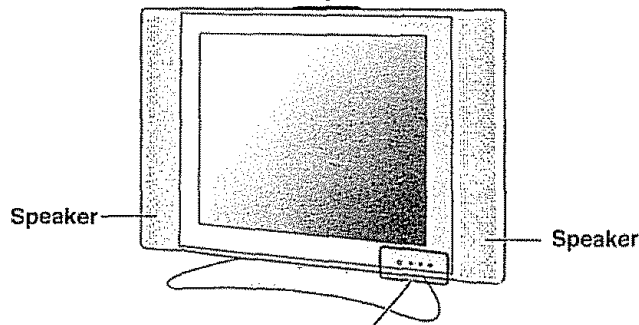
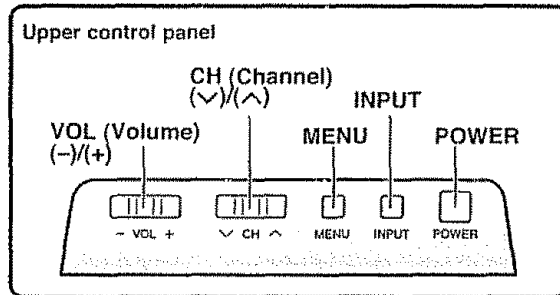

POWER indicator
The POWER indicator lights up green when the power is on, and red when in the standby mode (the indicator will not light up when the main power is off)

Headphone jack
Plug the headphone mini-plug into the headphone jack located on the front of the main unit

SLEEP TIMER indicator
The SLEEP TIMER indicator lights up red when the SLEEP TIMER is set to "ON".

How to adjust the angle

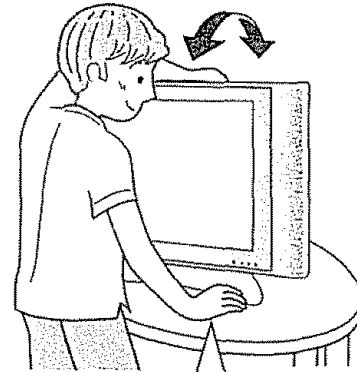

Tilt the display by holding the upper part while securely holding down the stand with your other hand

To change the vertical angle of the LCD TV set, tilt the screen up to 2.5 degrees forwards or 10 degrees backwards. Please adjust the angle so that the LCD TV set can be watched most comfortably.

NOTE

- INPUT, CH (v)/(^), VOL (-)/(+) and MENU on the main unit have the same functions as the same buttons on the remote control. Fundamentally, this operation manual provides a description based on operation using the remote control.

Listening with Headphones

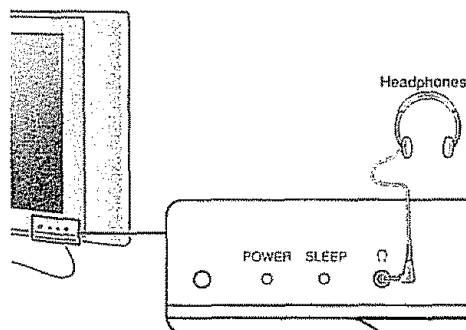

Plug the headphone mini-plug into the headphone jack located on the front of the LCD TV set. Adjust the sound volume using VOL (+)/(-) on the remote control.

On-screen display



NOTE

- Headphones are not included in the supplied accessories.
- No sound is heard from the main unit speakers when a headphone mini-plug is connected into the headphone jack.
- Do not set the volume at a high level. Hearing experts advise against extended listening at high volume levels.

Terminals

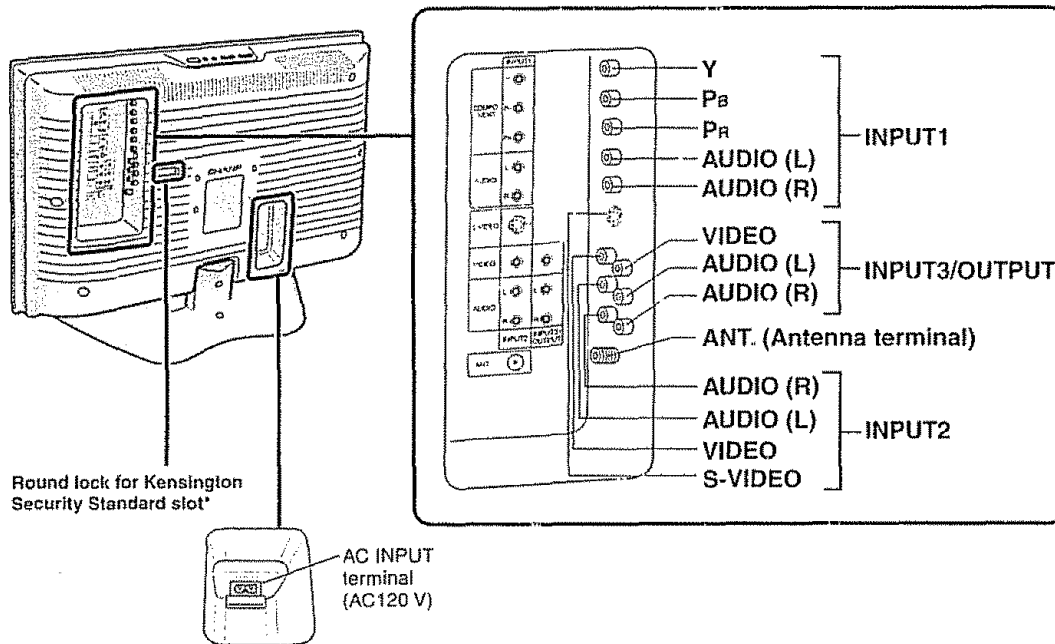

- Using the Kensington Lock
- This LCD TV set has a Kensington Security Standard slot for use with a Kensington MicroSaver Security System. Refer to the information that came with the system for instructions on how to use it to secure the LCD TV set.

How to Fix the Cables

Be sure to secure the cables and AC cord with the supplied cable clamp

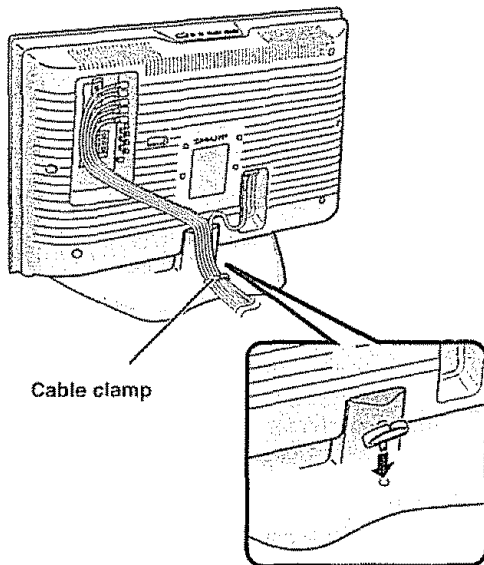

Part Names of Remote Control

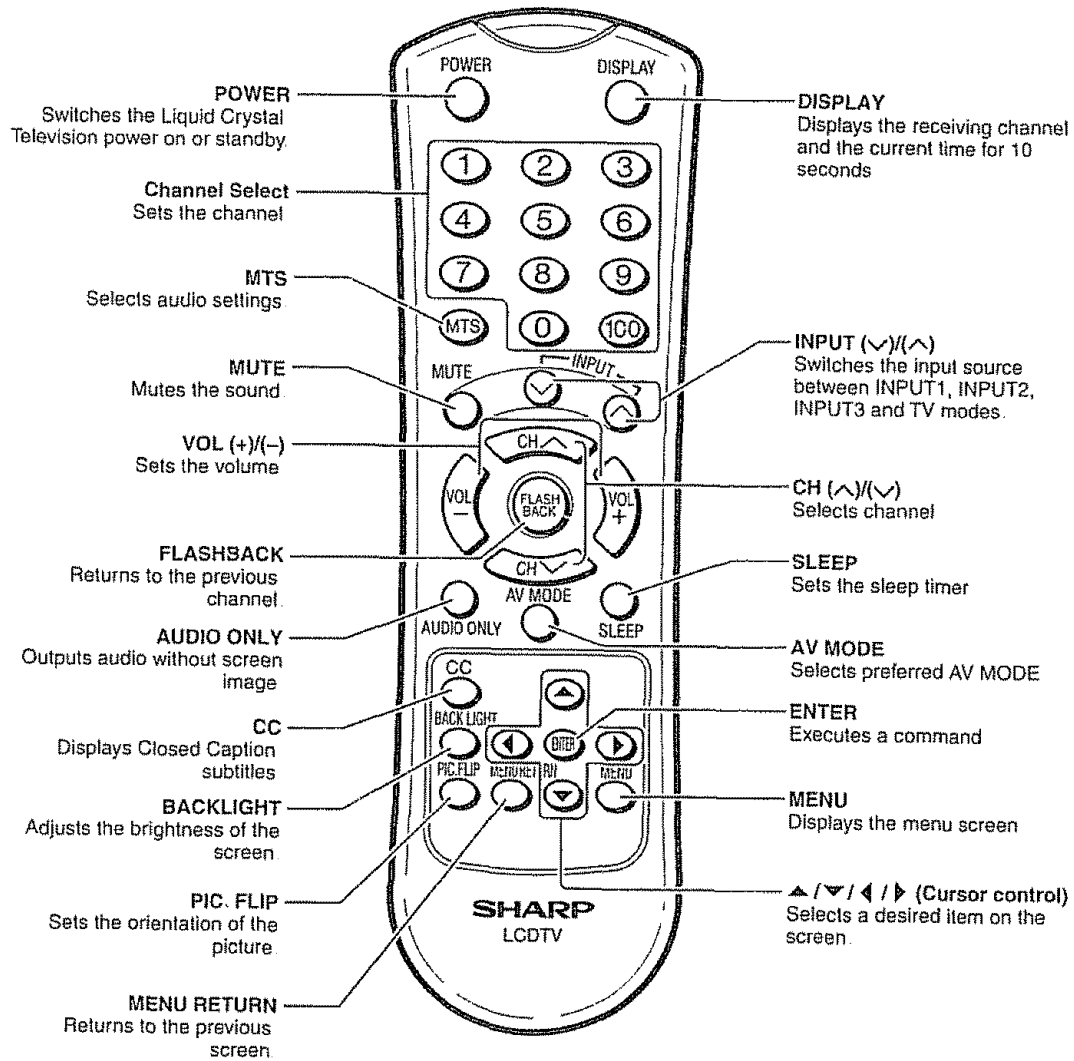

EZ SETUP

EZ SETUP during the First Power On

- When you turn on the TV for the first time, it will automatically memorize the broadcasting channels. Please perform the following instructions before you press POWER.
- (1) Insert the batteries into the remote control
 - (2) Connect the antenna cable to the LCD TV set
 - (3) Plug in the AC cord to the wall outlet

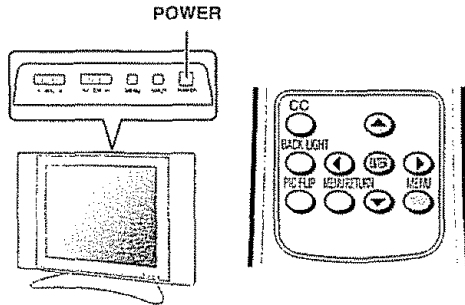

- 1 Press **POWER**, located on the upper side of the main unit, to turn on the TV. The SELECT LANGUAGE mode will be displayed. Press $\blacktriangle/\blacktriangledown$ to select "ENGLISH", "ESPANOL" (Spanish) or "FRANÇAIS" (French)

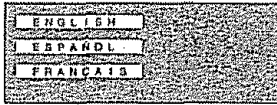

- 2 Press **ENTER** to access CH-SETTING mode. Press $\blacktriangle/\blacktriangledown$ to select "ON" or "OFF". When you select "ON", the LCD TV set will automatically memorize the broadcasting channels.



NOTE

- If you select "OFF", EZ SETUP will be canceled.

- 3 Press **ENTER** to access START EZ SETUP mode. Press $\blacktriangle/\blacktriangledown$ to select "YES", and press **ENTER**.

NOTE

- If you want to stop the EZ SETUP process once it has started, press **MENU** and it will be canceled. If you want to set up again, please see **CH-SETTING**.

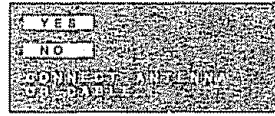

The tuner will automatically search for the broadcasting and cable TV channels. (The channel number will automatically increase when it appears.)



- 4 Once EZ SETUP is completed, the lowest channel number memorized will be displayed.

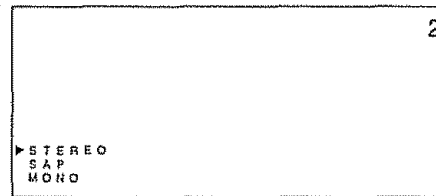

NOTE

- Do not let the EZ SETUP screen remain unattended for a long time.
- If EZ SETUP does not memorize all the channels in your region, please see **CH-SETTING** for more information on manually memorizing the channels using CH-SETTING.
- It may be difficult to preset when the broadcasting signals are weak, the channel cycle frequency is incorrect or the frequency jamming is occurring around the area. Please see **CH-SETTING** for more information on manually memorizing the channels using CH-SETTING.

Basic Operation

Turning On and Off the Main Power

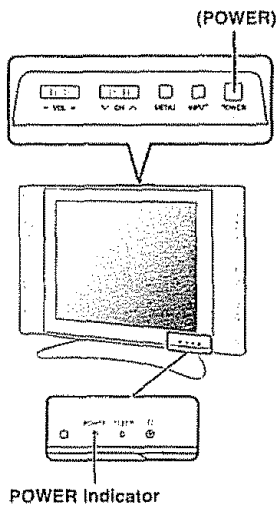

- Press **POWER**. The **POWER** indicator instantly changes from red to green and the LCD TV set is turned on.

On-screen display

ENTERED
SAP
MONO

NOTE

- The On-screen display disappears after a few seconds

- To turn off the main power, press **POWER** again

Standby

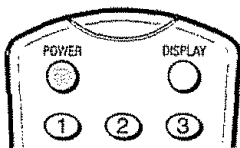

To turn off the LCD TV set

Press **POWER**. The **POWER** indicator will turn red

To turn the LCD TV set back on

Press **POWER** again. The **POWER** indicator will turn green

Switching the Input Modes (INPUT1/INPUT2/INPUT3/TV)

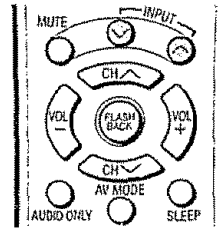

- 1 Turn on the power of the connected video equipment.
- 2 Press **INPUT** (v)/(^) to select the applicable input source. The screen changes in order of **INPUT1**, **INPUT2**, **INPUT3** and **TV** mode each time **INPUT** is pressed.

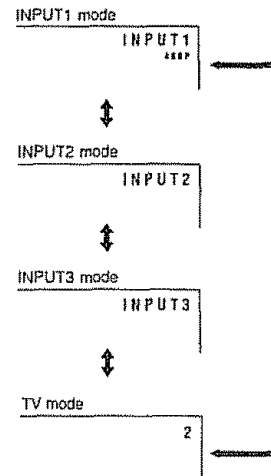

NOTE

- **INPUT1** :
Used for video equipment connected to the **COMPONENT** input terminals
- **INPUT2** :
Used for video equipment connected to the **INPUT2** terminal. The S-video input terminal is additionally provided for the **INPUT2**. If both the S-video terminal and normal video terminals are connected with cables, the S-video input terminal takes priority
- **INPUT3** :
INPUT3 mode is used to adjust the preset settings and **IN** or **OUT** can be selected. **INPUT3** indication is not displayed when **OUT** is selected

Sound Volume

To adjust the volume

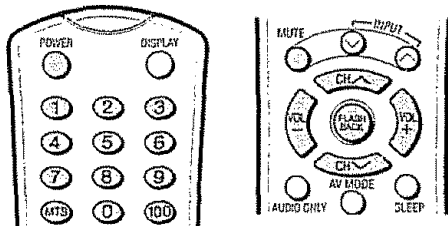

- Press VOL (+) to increase the sound volume. The bar indicator shifts right.

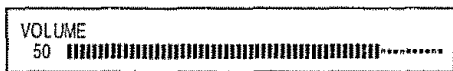

- Press VOL (-) to decrease the sound volume. The bar indicator shifts left.



To mute the sound

- Press MUTE to temporarily turn off the sound. The MUTE mark is displayed for 4 seconds.



- Press MUTE or VOL (+)/(-) to turn the sound back to the previous level. The mute function is automatically turned off when any of the following buttons are pressed: POWER, MUTE, VOL (+)/(-) or MTS.



NOTE

- When VOL (+)/(-) is pressed in the Mute mode, the sound turns on and the volume indicator is displayed.
- The Mute function is canceled when POWER is pressed.

To select MTS (Multichannel TV Sound)

- Press MTS to display the MTS screen.
- Press MTS to select the MTS settings:
 STEREO: stereo audio
 SAP: secondary audio program
 MONO: monophonic audio



NOTE

- "ON AIR" appears when a STEREO or SAP broadcast is being aired.

Changing Channels

You can select channels using Channel Select or CH (▲)/(▼).

This LCD TV set allows you to select up to 125 channels (1 to 125). To select a channel, enter a 2- or 3-digit number.

Using Channel Select

When selecting the channel using Channel Select, complete input of the channel number by holding down the button for the last digit for a moment.

To select a 1- or 2-digit channel number (e.g., Channel 5): Complete the following procedure within 4 seconds.

- Press the 0 button.
- Press the 5 button.

NOTE

- When selecting a 1-digit channel number, do not fail to press the 0 button first.

To select a 3-digit channel number (e.g., Channel 115): Complete the following procedure within 4 seconds.

- Press the 100 button.
- Press the 1 button.
- Press the 5 button.

NOTE

- The 3-digit channel number can be selected only when the receiving mode is set to CABLE in CH-SETTING.

Changing channels with CH (▲)/(▼) on the remote control

Air: Press CH (▲) and the channels change in the order shown below:
 2 → 3 → ... → 68 → 69 → 2 → 3 →
 Press CH (▼) and the channels change in the order shown below:
 3 → 2 → 69 → 68 → ... → 3 → 2 →

Cable: Press CH (▲) and the channels change in the order shown below:
 1 → 2 → 3 → ... → 125 → 1 → 2 → 3 →
 Press CH (▼) and the channels change in the order shown below:
 3 → 2 → 1 → 125 → ... → 3 → 2 → 1 →

Using FLASHBACK

- Press FLASHBACK to switch the currently tuned channel to the previously tuned channel.
- Press FLASHBACK again to switch back to the currently tuned channel.

Selecting Menu Items

The menus can be used to adjust the various settings of your LCD TV set. Select the desired menu item by following the steps below. See the right column for each Menu screen.

NOTE

- The items displayed differ depending on the setting conditions.
- The item selected is displayed in yellow.
- Settings most recently adjusted will be saved in memory.

Using the remote control

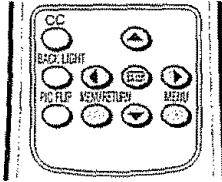

- 1 Press **MENU** on the remote control to display the Menu Screen.
- 2 Press **◀▶** to select the desired menu item.
 - The cursor moves left or right.
 - The cursor indicates the selected menu item.
- 3 Press **▲▼** to select the desired item, and press **◀▶** to adjust the selected item.
 - For "AV MODE", "ADVANCED" and "RESET", press **ENTER** to display the setting screen.

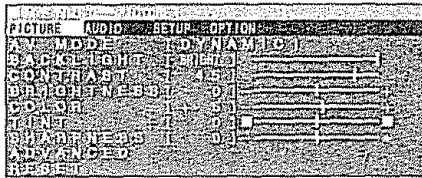

- 4 Press **MENU RETURN** to return to the previous screen, or press **MENU** to exit.

Using the control panel of the main unit

Control panel of the main unit

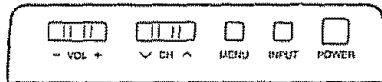

- 1 Press **MENU** on the main unit to display the Menu Screen.
- 2 Press **VOL (-)/(+)** to select the desired menu item.
 - The cursor moves left or right.
 - The cursor indicates the selected menu item.
- 3 Press **CH (v)/(^)** to select the desired item, and press **VOL (-)/(+)** to adjust the selected item.
 - For "AV MODE", "ADVANCED" and "RESET", press **INPUT** to display the setting screen.
- 4 Press **MENU** to exit.

Menu setting screens

NOTE

- The illustrations and on-screen displays in this manual are for explanation purposes and may vary slightly from the actual appearance.
- Depending on the setting condition, such as an input mode, it may not be possible to adjust or set some items. In such cases, a message will be displayed on the menu setting screen.

PICTURE

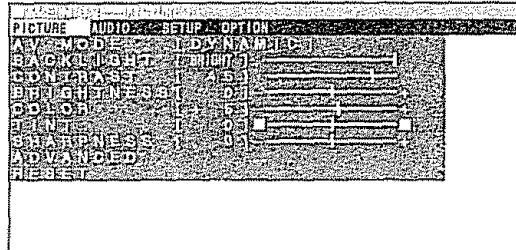

The bar above is an operational guide for the remote control. The bar will change in accordance with each menu setting screen.

AUDIO

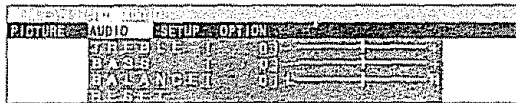

SETUP

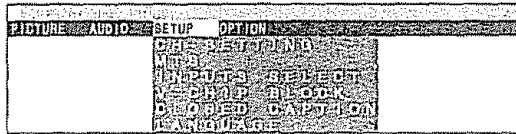

OPTION

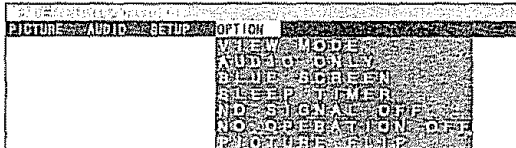

Basic Adjustment Settings

AV MODE

AV MODE gives you preset options to choose from, to best match the image based on room-brightness and playback software used

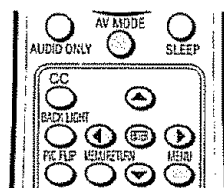

- 1 Press **MENU** to display the Menu Screen
- 2 Press **◀▶** to select "PICTURE"
- 3 Press **▲/▼** to select "AV MODE", and press **ENTER**
- 4 Press **▲/▼** to select desired setting, and press **ENTER**

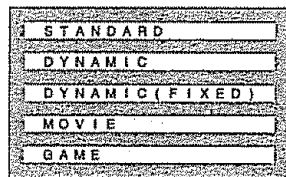

- 5 Press **MENU** to exit

NOTE

- You can select a different AV MODE item for each input mode. (For example, select "STANDARD" for TV input and "DYNAMIC" for VIDEO input.)
- When "AV MODE" is set to "DYNAMIC (FIXED)", "NO PICTURE ADJUSTMENTS AVAILABLE IN [DYNAMIC (FIXED)]" is displayed and the items in the PICTURE screen (except "ADVANCED") cannot be set

Directly setting the AV MODE

- 1 Press **AV MODE**
- 2 Before the AV MODE display disappears, press **AV MODE** again and select your desired setting
 - Each time you press **AV MODE**, the mode changes as shown below

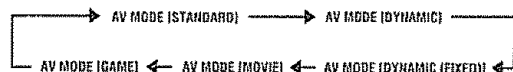

Selected item	Description
STANDARD	Changing image settings to standard values.
DYNAMIC	For a clear-cut image emphasizing high contrast for sports viewing.
DYNAMIC (FIXED)	Changing image settings to factory preset values. No adjustments are allowed.
MOVIE	Controlling the contrast to enable easier viewing of dark images.
GAME	Controlling the brightness of video games and other images for easier viewing.

COLOR TEMPERATURE

You can adjust the color temperature to give a better white balance

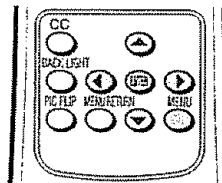

- 1 Press **MENU** to display the Menu screen
- 2 Press **◀▶** to select "PICTURE"
- 3 Press **▲/▼** to select "ADVANCED", and press **ENTER**
- 4 Press **▲/▼** to select "COLOR TEMP", and press **ENTER**

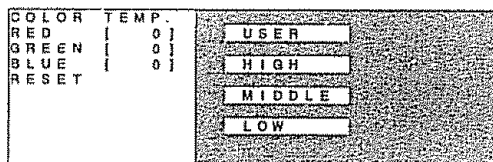

- 5 Press **▲/▼** to select the desired item, and press **ENTER**
- 6 Press **MENU** to exit

Selected item	Description
USER	Can set your desired color
HIGH	White with Bluish tone
MIDDLE	
LOW	White with Reddish tone

*When you select "USER", the following items are adjustable

Selected item	◀ button	▶ button
RED	Weaker red	Stronger red
GREEN	Weaker green	Stronger green
BLUE	Weaker blue	Stronger blue

NOTE

- When resetting the items in the "USER" setting to factory preset values, perform the following procedures.
 - ① Press **▲/▼** to select "RESET" in the ADVANCED screen, and press **ENTER**
 - ② Press **▲/▼** to select "YES", and press **ENTER**

BACKLIGHT

You can adjust the brightness of the picture

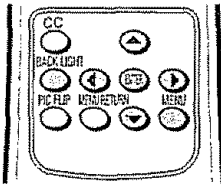

- 1 Press MENU to display the Menu Screen
- 2 Press \leftarrow/\rightarrow to select "PICTURE"
- 3 Press \uparrow/\downarrow to select "BACKLIGHT".

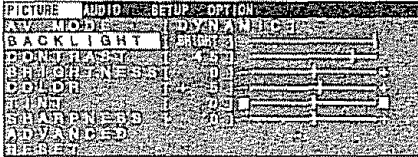

- 4 Press \leftarrow/\rightarrow to adjust the item to your desired position
- 5 Press MENU to exit.

Directly setting the BACKLIGHT

- 1 Press BACKLIGHT to display the BACKLIGHT screen
- 2 Press BACKLIGHT to change the setting



NOTE

- The BACKLIGHT screen automatically disappears in 3 seconds
- [BRIGHT]: Maximum brightness
- [NORMAL]: Suitable for viewing in a well-lit area. Saves energy
- [DARK]: Sufficiently bright when viewing in dim areas
- [VARIABLE]: The brightness can be adjusted to suit your preference using \leftarrow/\rightarrow

PICTURE Adjustments

You can adjust the picture to your preference with the following picture settings

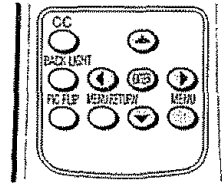

- 1 Press MENU to display the Menu screen
- 2 Press \leftarrow/\rightarrow to select "PICTURE"
- 3 Press \uparrow/\downarrow to select a specific adjustment item

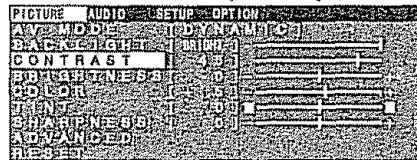

- 4 Press \leftarrow/\rightarrow to adjust the item to your desired position
- 5 Press MENU to exit

Selected Item	\leftarrow button	\rightarrow button
BACKLIGHT	The screen dims	The screen brightens
CONTRAST	For less contrast	For more contrast
BRIGHTNESS	For less brightness	For more brightness
COLOR	For less color intensity	For more color intensity
TINT	Skin tones become purplish	Skin tones become greenish
SHARPNESS	For less sharpness	For more sharpness

NOTE

- When resetting all adjustment items (except for the items on the AV MODE and ADVANCED menus) to factory preset values, perform the following procedures.
 - ① Press \uparrow/\downarrow to select "RESET" in the PICTURE screen, and press ENTER
 - ② Press \uparrow/\downarrow to select "YES", and press ENTER

Basic Adjustment Settings (Continued)

AUDIO Adjustments

You can adjust the sound quality to your preference with the following settings

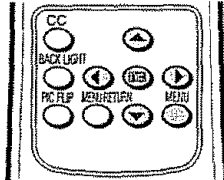

- 1 Press MENU to display the Menu screen
- 2 Press ◀▶ to select "AUDIO"
- 3 Press ▲/▼ to select a specific adjustment item



- 4 Press ◀▶ to adjust the item to your desired position
- 5 Press MENU to exit

Selected item	◀ button	▶ button
TREBLE	For weaker treble	For stronger treble
BASS	For weaker bass	For stronger bass
BALANCE	Decrease audio from the right speaker	Decrease audio from the left speaker

NOTE

- The items on the AUDIO menu cannot be set when "INPUT3 SELECT" is set to "OUT ⓧ VAO"
- When resetting all adjustment items to factory preset values, perform the following procedures.
 - ① Press ▲/▼ to select "RESET", and press ENTER
 - ② Press ▲/▼ to select "YES", and press ENTER

SETUP

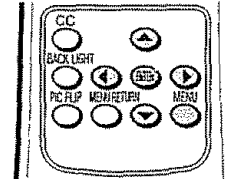

- 1 Press MENU to display the Menu screen
- 2 Press ◀▶ to select "SETUP"
- 3 Press ▲/▼ to select desired item. and press ENTER

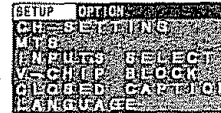

- 4 Press ▲/▼ to change the setting, and press ENTER
- 5 Press MENU to exit

Selected item	Factory setting	Setting options
MTS	[STEREO] Stereo audio	[SAP] Secondary audio program [MONO] Monophonic audio
INPUT3 SELECT	[IN] INPUT3/OUTPUT terminals selected as input terminals	[OUT ⓧ FAO] Line Output is selected, Output volume is fixed. - Speaker output is available.
		[OUT ⓧ VAO] Line Output is selected, Output volume is variable. Speaker output is mute
LANGUAGE	[ENGLISH]	[ESPAÑOL] [FRANÇAIS]

Useful Features

CH-SETTING

■ EZ SETUP

When you move to an area with different broadcasting signals, you may have to set the channel numbers and the time with the EZ SETUP function. To activate EZ SETUP, perform the following procedures.

- ① Press ▲/▼ to select "CH-SETTING" in the SETUP screen, and press ENTER.
- ② Press ▲/▼ to select "EZ SETUP", and press ENTER.
- ③ Press ▲/▼ to select "YES", and press ENTER.

■ Setting the AIR/CABLE

It is necessary to set the receiving mode to AIR or CABLE channels to receive locally broadcast TV programs.

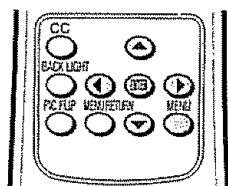

- 1 Press MENU to display the Menu screen.
- 2 Press ◀▶ to select "SETUP".
- 3 Press ▲/▼ to select "CH-SETTING", and press ENTER.
- 4 Press ▲/▼ to select "AIR/CABLE", and press ENTER.
Press ▲/▼ to select desired setting, and press ENTER.

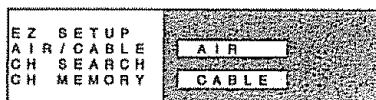

- 5 Press MENU to exit.

NOTE

- Receivable channels of your LCD TV set are:

AIR channels:	CABLE channels:
VHF: 2 through 13	1 (HRC and IRC)
UHF: 14 through 69	2 through 125 (STD. HRC and IRC)

■ Saving broadcast TV channels in the memory

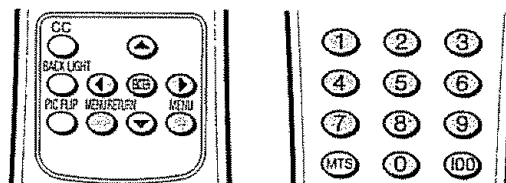

- 1 Press MENU to display the Menu screen.
- 2 Press ◀▶ to select "SETUP".
- 3 Press ▲/▼ to select "CH-SETTING", and press ENTER.
- 4 Press ▲/▼ to select "CH SEARCH", and press ENTER.



- 5 Press ENTER. The tuner will search through all available channels in your area and add them to the TV memory.

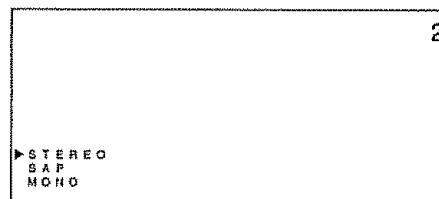

NOTE

- To interrupt CH SEARCH, press MENU RETURN. CH SEARCH will stop at the current channel and will not add any higher channels.

■ Adding weak or additional channels or erasing unwanted channels from TV memory

Individual settings of programs can be adjusted.

- 1 In step 4 above, press ▲/▼ to select "CH MEMORY", and press ENTER.



- 2 Press ▲/▼ to move the cursor to "CHANNEL", and use ◀▶ or Channel Select to select each desired channel to add or erase.
- 3 Press ▲/▼ to move the cursor to "SKIP", and use ◀▶ to select "ON" or "OFF".
- 4 Press MENU to exit.

NOTE

- If CH SEARCH is performed again, the previously memorized channels will be lost.

V-CHIP Settings

V-CHIP

- This function allows TV programs to be restricted and TV usage to be controlled based on FCC data. It prevents children from watching violent or sexual scenes that may be harmful.
- Restriction of TV programs includes two ratings that contain information about the program: the MPAA (Motion Picture Association of America) rating and the TV Parental Guidelines. The MPAA rating is restricted by age. TV Parental Guidelines are restricted by age and content.
- Since a TV program may use either the MPAA rating or the TV Guidelines, both should be adjusted for complete control.

MPAA rating

RATING		
age based	G	GENERAL AUDIENCES. All ages admitted.
	PG	PARENTAL GUIDANCE SUGGESTED. Some material may not be suitable for children.
	PG-13	PARENTS STRONGLY CAUTIONED. Some material may be inappropriate for children under 13.
	R	RESTRICTED. Under 17 requires accompanying parent or adult guardian.
	NC-17	NO ONE 17 AND UNDER ADMITTED.
	X	X is an older rating that is unified with NC-17 but may be encoded in the data of older movies.

MPAA rating

Example 1:
PG-13 in the age-based rating is blocked, this will also automatically block the higher ratings R, NC-17 and X.

1. User setting		2. Block table	
G	-----	G	not to block
PG	-----	PG	not to block
PG-13	BLOCK	PG-13	Select block
R	BLOCK	R	auto-block
NC-17	BLOCK	NC-17	auto-block
X	BLOCK	X	auto-block

Example 2:
R in the age-based rating is blocked, this will also automatically block the higher ratings NC-17 and X.

1. User setting		2. Block table	
G	-----	G	not to block
PG	-----	PG	not to block
PG-13	-----	PG-13	not to block
R	BLOCK	R	Select block
NC-17	BLOCK	NC-17	auto-block
X	BLOCK	X	auto-block

NOTE

- The MPAA rating is only age-based.

TV parental guidelines

Rating		← content based →				
		FV (Fantasy Violence)	V (Violence)	S (Sexual Situation)	L (Adult Language)	D (Sexually Suggestive Dialog)
age based	TV-Y (All children)	☒	☒	☒	☒	☒
	TV-Y7 (Direct to Older Children)	X	☒	☒	☒	☒
	TV-G (General Audience)		☒	☒	☒	☒
	TV-PG (Parental Guidance Suggested)		X	X	X	X
	TV-14 (Parents Strongly Cautioned)		X	X	X	X
	TV-MA (Mature Audience Only)		X	X	X	

- ☒: The content rating can be set, but this rating is not normally broadcast by TV stations.
- X: The content rating can be set.

TV parental guidelines

Example:

When TV-Y7 in the age-based rating is set to BLOCK, this will automatically block the higher ratings: TV-G, TV-PG, TV-14 and TV-MA. In addition, D, L, S, V and FV in BLOCK CONTENT are automatically blocked unless you manually set BLOCK CONTENT.

1. User setting		2. Block table	
TV-Y	-----		
TV-Y7	BLOCK		
TV-G	BLOCK		
TV-PG	BLOCK		
TV-14	BLOCK		
TV-MA	BLOCK		
BLOCK CONTENT (D L S V FV)			

		content based				
		FV	V	S	L	D
age based	TV-Y					
	TV-Y7					
	TV-G					
	TV-PG					
	TV-14					
	TV-MA					

☒ Select block ☒ auto-block

NOTE

- Age-based ratings can be modified by the content-based ratings, but only in the combinations indicated by an X in the table above.
- Choosing a lower age-based rating blocks the higher age-based ratings regardless of content rating settings.
- If you set TV-Y and TV-Y7 to BLOCK, BLOCK CONTENT will display all items.

Canadian Rating Systems

- The TV rating systems in Canada are based on the Canadian Radio-Television and Telecommunications Commission (CRTC) policy on violence in television programming
- While violence is the most important content element to be rated, the structure developed takes into consideration other program content like language, nudity, sexuality and mature themes
- When setting the V-CHIP on the Canadian system, you can choose either the Canadian English ratings or the Canadian French ratings

Canadian English ratings

Rating		Description
Age	C	Children: Intended for younger children under the age of 8 years. Pays careful attention to themes that could threaten their sense of security and well-being.
	C8+	Children over 8 years old: Contains no portrayal of violence as the preferred, acceptable, or only way to resolve conflict; nor encourage children to imitate dangerous acts which they may see on the screen.
	G	General: Considered acceptable for all age groups. Appropriate viewing for the entire family. contains very little violence, physical, verbal or emotional.
	PG	Parental Guidance: Intended for a general audience, but may not be suitable for younger children (under the age of 8) because it could contain controversial themes or issues.
	14+	Over 14 Years: Could contain themes where violence is one of the dominant elements of the storyline, but it must be integral to the development of plot or character. Language usage could be profane and nudity present within the context of the theme.
	18+	Adults: Intended for viewers 18 years and older and might contain depictions of violence, which while related to the development of plot, character or themes, are intended for adult viewing. Could contain graphic language and portrayals of sex and nudity.

Canadian French ratings

Rating		Description
Age	G	General: All ages and children, contains minimal direct violence, but may be integrated into the plot in a humorous or unrealistic manner.
	8ans +	General but inadvisable for young children: May be viewed by a wide public audience, but could contain scenes disturbing to children under 8 who cannot distinguish between imaginary and real situations. Recommended for viewing with parent.
	13ans +	Over 13 years: Could contain scenes of frequent violent scenes and therefore recommended for viewing with parent.
	16ans +	Over 16 years: Could contain frequent violent scenes and intense violence.
	18ans +	Over 18 years: Only for adult viewing. Could contain frequent violent scenes and extreme violence.

V-CHIP Settings (Continued)

V-CHIP settings allow you to set MPAA rating, TV GUIDELINES, Canadian English ratings and Canadian French ratings

Setting V-CHIP

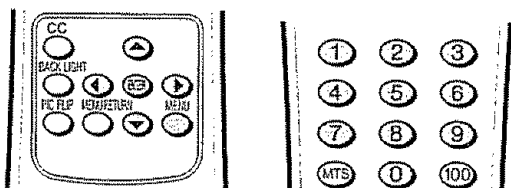

- 1 Press MENU to display the Menu screen
- 2 Press \leftarrow/\rightarrow to select "SETUP"
- 3 Press \uparrow/\downarrow to select "V-CHIP BLOCK", and press ENTER
- 4 "INPUT SECRET NO " will be displayed. Input the 4-digit secret number by using Channel Select.

NOTE

When you input the secret number for the first time, press ENTER to register. Otherwise, continue to step 5



- 5 Press \uparrow/\downarrow to select the desired item, and press ENTER

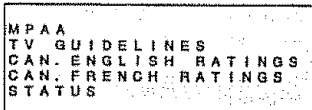

- 6 Press \uparrow/\downarrow to select the desired item, and press \leftarrow/\rightarrow to select "BLOCK"

(MPAA rating)

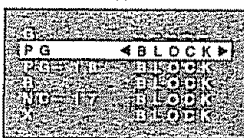

(TV GUIDELINES)

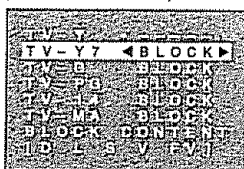

(Canadian English ratings)

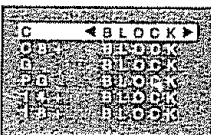

(Canadian French ratings)

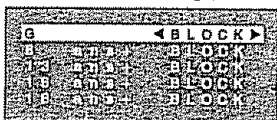

- 7 Press MENU to exit

NOTE

The setting automatically enters "BLOCK" for any ratings below your selection

Setting BLOCK CONTENT (TV GUIDELINES)

- 1 Repeat steps 1 to 4 of Setting V-CHIP
- 2 Press \uparrow/\downarrow to select "TV GUIDELINES", and press ENTER
- 3 Press \uparrow/\downarrow to select "BLOCK CONTENT", and press ENTER

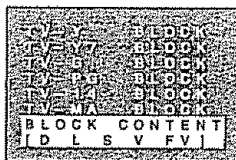

- 4 Press \uparrow/\downarrow to select the desired item, and press \leftarrow/\rightarrow to select "BLOCK" or "-----" (unblock)

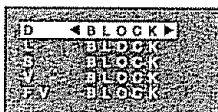

- 5 Press MENU to exit.

■ Activating V-CHIP BLOCK

● Setting STATUS

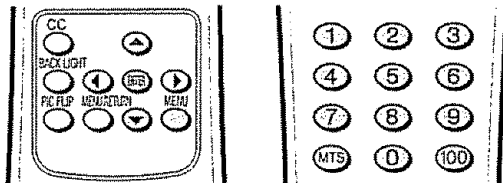

- 1 Repeat steps 1 to 4 of Setting V-CHIP
- 2 Press ▲/▼ to select "STATUS", and press ENTER

```
MPAA
TV GUIDELINES
CAN. ENGLISH RATINGS
CAN. FRENCH RATINGS
STATUS
```

- 3 Press ▲/▼ to select "ON", and press ENTER



NOTE

• If "STATUS" is set to "OFF", V-CHIP BLOCK will not be activated

- 4 Press MENU to exit

■ Canceling the V-CHIP BLOCK screen while V-CHIP BLOCK is activated

- 1 "V-CHIP HAS BEEN ACTIVATED" appears if you watch a program with the same Program Rating data you configured.

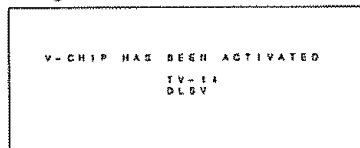

NOTE

• "V-CHIP HAS BEEN ACTIVATED" will not be displayed if "STATUS" is set to "OFF"

- 2 Press MENU to display "INPUT SECRET NO "



- 3 Input the 4-digit secret number by using Channel Select; V-CHIP BLOCK is temporarily canceled. If you input an incorrect secret number, "SECRET NO IS INCORRECT" is displayed. In this case, input the correct secret number

■ Changing V-CHIP BLOCK settings

- 1 Repeat steps 1 to 3 of Setting V-CHIP, then "INPUT SECRET NO " will be displayed



- 2 Input the 4-digit secret number by using Channel Select; the V-CHIP select mode will be displayed. Set the V-CHIP BLOCK again

```
MPAA
TV GUIDELINES
CAN. ENGLISH RATINGS
CAN. FRENCH RATINGS
STATUS
```

■ Changing or clearing the SECRET NUMBER

If you forget the secret number, clear the secret number as follows

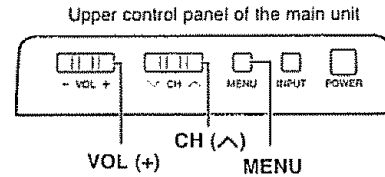

- 1 Repeat steps 1 to 3 of Setting V-CHIP, or 1 and 2 of Canceling the V-CHIP BLOCK screen while V-CHIP BLOCK is activated, then "INPUT SECRET NO " will be displayed
- 2 Press and hold both CH (^) and VOL (+) on the main unit simultaneously until the message "INPUT SECRET NO " blinks
- 3 Press MENU to exit

CLOSED CAPTION

■ Setting CLOSED CAPTION

- This LCD TV set is equipped with an internal Closed Caption decoder. "Closed Caption" is a system which allows conversations, narration, and sound effects in TV programs and home videos to be viewed as captions on the TV screen (see the illustration).
- Not all programs and videos will offer closed captioning. Please look for the "CC" symbol to ensure that captions will be shown.
- The Closed Caption broadcasts can be viewed in two modes: CAPTION and TEXT. For each mode, two channels are available: CH1 and CH2.
- The CAPTION mode shows subtitles of dialogs and commentaries of TV dramas and news programs while allowing a clear view of the picture.
- The TEXT mode displays various information over the picture (such as TV program schedules and weather forecasts, etc.) that is independent of the TV programs.



Setting the CLOSED CAPTION on the Menu screen

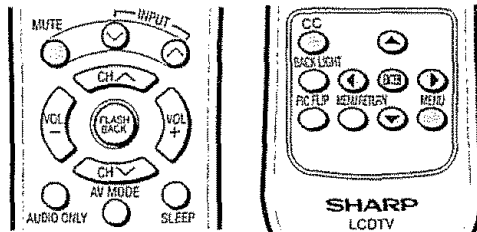

- Press **MENU** to display the Menu screen.
- Press **◀/▶** to select "SETUP".
- Press **▲/▼** to select "CLOSED CAPTION", and press **ENTER**.
- Press **▲/▼** to change the CLOSED CAPTION setting, and press **ENTER**.

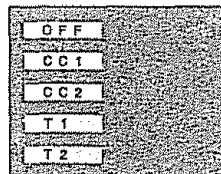

NOTE

- CC1: CLOSED CAPTION mode for CH1 data
- CC2: CLOSED CAPTION mode for CH2 data
- T1: TEXT mode for CH1 data
- T2: TEXT mode for CH2 data

- Press **MENU** to exit.

Directly setting the CLOSED CAPTION

- Press **CC** to display the CC/TEXT screen.

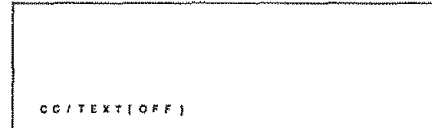

- Press **CC** to change the setting.



NOTE

- CC1: CLOSED CAPTION mode for CH1 data
- CC2: CLOSED CAPTION mode for CH2 data
- T1: TEXT mode for CH1 data
- T2: TEXT mode for CH2 data

NOTE

- If a broadcast contains Closed Caption data and **MUTE** is pressed, the LCD TV set enters CLOSED CAPTION mode automatically. Pressing **MUTE** again will return the LCD TV set to its previous condition.
- Closed Caption may malfunction (white blocks, strange characters, etc.) if signal conditions are poor or if there are problems at the broadcast source. This does not necessarily indicate a problem with your LCD TV set.
- If any button is pressed to call up the On-Screen Display while viewing a Closed Caption broadcast, the closed captions will disappear momentarily.
- If no TEXT broadcast is being received while viewing in the TEXT mode, the screen may become blank for some programs. Should this occur, switch the CLOSED CAPTION mode to OFF.
- If you select "CC1", "CC2", "T1" or "T2" (or **MUTE** is pressed) while "VIEW MODE" is set to "ZOOM" or "STRETCH", then the mode for "VIEW MODE" will be automatically changed to "4:3" or "16:9".

VIEW MODE

You can select the picture display size for the playback image of the DVD player from the following four modes: "4:3", "16:9", "ZOOM" and "STRETCH"

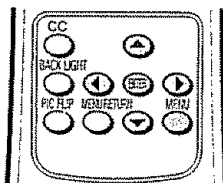

1. Press MENU to display the Menu screen
2. Press \leftarrow/\rightarrow to select "OPTION"
3. Press Δ/∇ to select "VIEW MODE", and press ENTER
4. Press Δ/∇ to select desired setting, and press ENTER

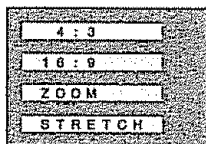

Selected Item	Description
4:3	Displays the image in a 4:3 size.
16:9	Stretches the image horizontally to display it in a 16:9 size.
ZOOM	Displays the center part of the image by enlarging it towards the horizontal and vertical directions.
STRETCH	Stretches the image horizontally

Image type	4:3	16:9	ZOOM	STRETCH
(For an image stretched vertically)				
(For an image stretched vertically with bands at the left and right sides)				
(For a 4:3 image)				

5. Press MENU to exit.

NOTE

- The 4:3 image will be distorted on the screen when the "VIEW MODE" is set to "16:9".
- When the CLOSED CAPTION mode is set to "CC1", "CC2", "T1" or "T2", "ZOOM" and "STRETCH" cannot be set for "VIEW MODE"

AUDIO ONLY

When listening to music from a music program, you can set the Liquid Crystal display off and enjoy audio only

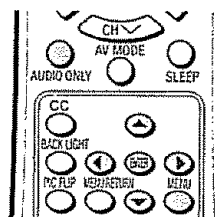

Setting the AUDIO ONLY on the Menu screen

1. Press MENU to display the Menu screen
2. Press \leftarrow/\rightarrow to select "OPTION"
3. Press Δ/∇ to select "AUDIO ONLY", and press ENTER
4. Press Δ/∇ to select "ON", and press ENTER



Selected Item	Description
ON	Audio is output without screen image.
OFF	Both screen images and audio are output.

Directly setting the AUDIO ONLY

1. Press AUDIO ONLY 'PRESS "AUDIO ONLY" FOR VIDEO OFF' is displayed on the screen.

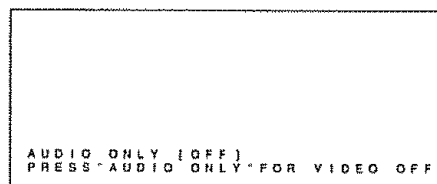

2. Press AUDIO ONLY again The screen image will disappear
3. Press AUDIO ONLY again The screen image will be displayed again

Useful Features (Continued)

BLUE SCREEN

This function automatically turns the screen blue if no broadcast signal is received.

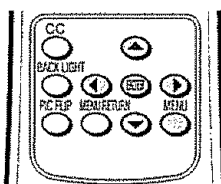

- 1 Press **MENU** to display the Menu screen
- 2 Press **◀▶** to select "OPTION"
- 3 Press **▲/▼** to select "BLUE SCREEN", and press **ENTER**.
- 4 Press **▲/▼** to select "ON", and press **ENTER**



- 5 Press **MENU** to exit

NOTE

- When received signals are weak or interfered with by some other signals, the BLUE SCREEN function may be activated. To watch the TV under such conditions, set "BLUE SCREEN" to "OFF"
- The BLUE SCREEN function is activated when INPUT mode is selected with no signal being input

SLEEP TIMER

You can set the SLEEP TIMER to automatically turn off the TV

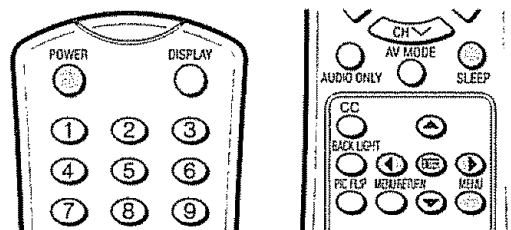

Setting the SLEEP TIMER on the Menu screen

- 1 Press **MENU** to display the Menu screen.
- 2 Press **◀▶** to select "OPTION"
- 3 Press **▲/▼** to select "SLEEP TIMER", and press **ENTER**
- 4 Press **▲/▼/◀▶** to select "30MIN", "60MIN", "90MIN", "120MIN", "150MIN" or "OFF", and press **ENTER**

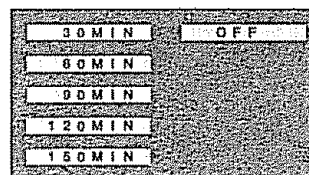

- 5 Press **MENU** to exit.

NOTE

- After you set the SLEEP TIMER, pressing **POWER** on the main unit or on the remote control will cancel the SLEEP TIMER setting.
- 5 minutes before the SLEEP TIMER turns off the LCD TV, "5 MIN REMAINING" is displayed on the screen for 4 seconds. The SLEEP TIMER counts down and shows a similar 4-second display for each remaining minute until the timer turns off the LCD TV set

Directly setting the SLEEP TIMER

- 1 Press **SLEEP** to display the SLEEP TIMER screen



- 2 Press **SLEEP** to set the sleep timer (in minutes)

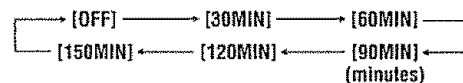

NOTE

- The SLEEP TIMER screen automatically disappears in 3 seconds

NO SIGNAL OFF

Power control setting allows you to save energy. When set to "ENABLE", the power will automatically shut down if no signal inputs for 5 minutes.

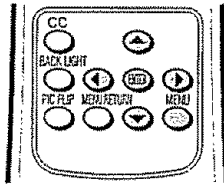

- 1 Press MENU to display the Menu screen.
- 2 Press $\blacktriangleleft/\blacktriangleright$ to select "OPTION".
- 3 Press $\blacktriangle/\blacktriangledown$ to select "NO SIGNAL OFF", and press ENTER.
- 4 Press $\blacktriangle/\blacktriangledown$ to select "ENABLE", and press ENTER.



- 5 Press MENU to exit.

NOTE

- "DISABLE" is factory preset value.
- This function can work only in TV mode.
- If interfered with by other broadcast or radio waves, "NO SIGNAL OFF" may not work properly even when the broadcast is over.

NO OPERATION OFF

When set to "ENABLE", the power will automatically shut down if there is no operation for 3 hours.

- 1 Press MENU to display the Menu screen.
- 2 Press $\blacktriangleleft/\blacktriangleright$ to select "OPTION".
- 3 Press $\blacktriangle/\blacktriangledown$ to select "NO OPERATION OFF", and press ENTER.
- 4 Press $\blacktriangle/\blacktriangledown$ to select "ENABLE", and press ENTER.



- 5 minutes before the power shuts down, remaining time is displayed every minute.

- 5 Press MENU to exit.

NOTE

- "DISABLE" is factory preset value.

PICTURE FLIP

You can set the orientation of the picture.

Setting the PICTURE FLIP on the MENU screen

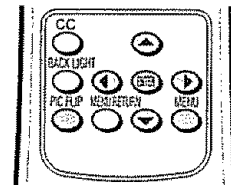

- 1 Press MENU to display the Menu screen.
- 2 Press $\blacktriangleleft/\blacktriangleright$ to select "OPTION".
- 3 Press $\blacktriangle/\blacktriangledown$ to select "PICTURE FLIP", and press ENTER.
- 4 Press $\blacktriangle/\blacktriangledown$ to select the desired mode, and press ENTER.

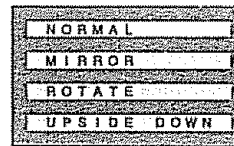

- 5 Press MENU to exit.

Directly setting the PICTURE FLIP

- 1 Press PIC.FLIP to display the PICTURE FLIP screen.
- 2 Press PIC.FLIP to change the setting.

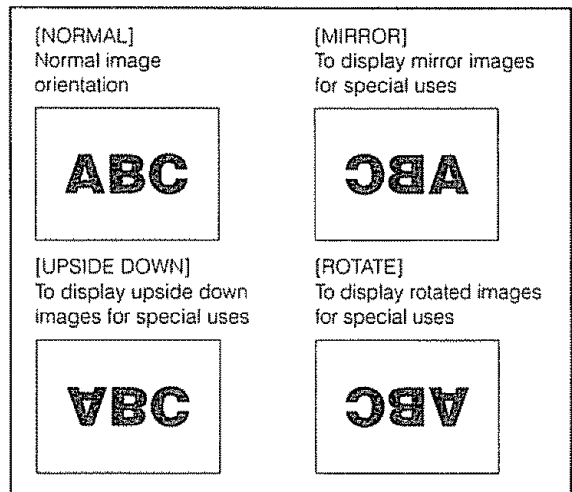
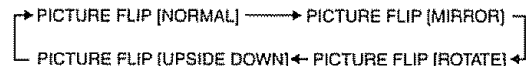

Connecting External Devices

You can enjoy picture and sound by connecting a VCR or a home video game system to the terminals located on the rear of the main unit

When connecting an external device, turn off the **POWER** of the main unit first to prevent any possible damage

Example of External Devices that can be Connected

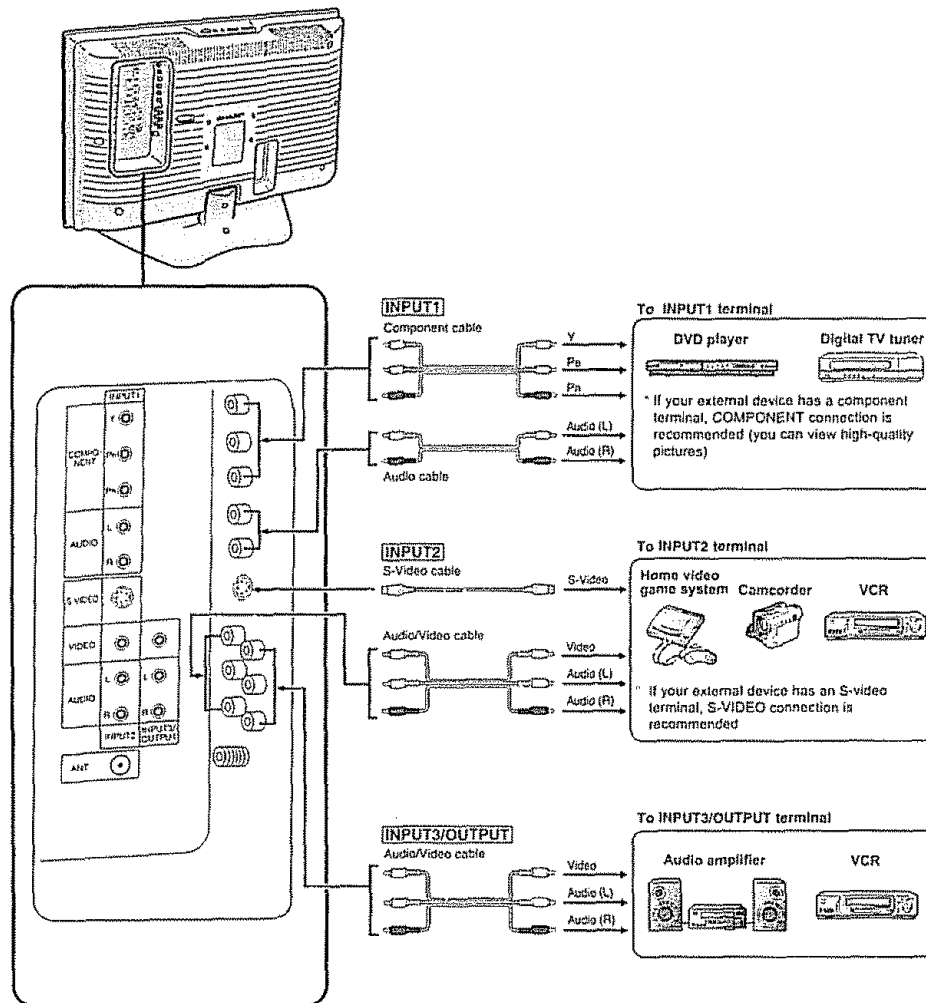

NOTE

- For the cable, use a commercially available audio/video cable
- PC connection is not possible
- For more information about external device connections, see the operation manuals of your external devices.
- Make sure that the corresponding cables are connected to each terminal. Connecting other cables may result in a malfunction
- INPUT2 has two terminals, VIDEO and S-VIDEO terminals. If your external device has an S-VIDEO terminal, S-VIDEO connection is recommended. S-VIDEO provides a finer, more detailed picture. If both terminals are connected, S-VIDEO terminal takes a priority
- Only when 480i or 480P signal is received through the INPUT1, picture can be displayed

Outputting Video and Audio (Video Output)

- You can output video and audio signals from the LCD TV set through the INPUT3/OUTPUT terminals.
- When using INPUT3/OUTPUT as an output terminal, select "SETUP" in the Menu and set "INPUT3 SELECT" to "OUT" or "FAO" or "OUT FAO"





NOTE

- When using the S-VIDEO input for INPUT2 or COMPONENT input for INPUT1, no video signal will be made to the INPUT3/OUTPUT terminal, but audio signal will be made for connection to external audio systems

Troubleshooting

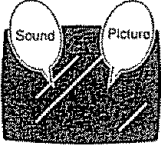
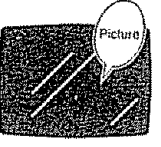
Before calling for repair services, make the following checks for possible remedies to the encountered symptoms

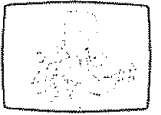
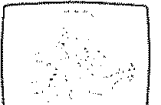
LCD TV set

Problem	Check item
 <p>There is no picture or sound</p>	<ul style="list-style-type: none"> • Make sure the AC cord is properly inserted in the power outlet • Reception other than those of broadcasting stations can be considered • Make sure the input mode is set to TV • Make sure the POWER switch of the main unit is on
 <p>There is no picture. There is no picture from INPUT1/2/3</p>	<ul style="list-style-type: none"> • Make sure the BRIGHTNESS is properly adjusted. • Fluorescent lamp may have reached the end of service life • Make sure the S-VIDEO terminal has nothing connected • Make sure the AUDIO ONLY is not set to ON.
 <p>There is no sound.</p>	<ul style="list-style-type: none"> • Make sure the volume is not set to minimum • Make sure the sound is not set to mute. • Make sure that headphones are not connected
 <p>There is no picture or sound, just noise</p>	<ul style="list-style-type: none"> • Make sure the antenna cable is properly connected. • Bad reception could be the problem.
 <p>Picture is not clear</p>	<ul style="list-style-type: none"> • Make sure the antenna cable is properly connected. • Bad reception could be the problem
 <p>Picture is light or improperly tinted.</p>	<ul style="list-style-type: none"> • Check color adjustment.
 <p>The picture is too dark.</p>	<ul style="list-style-type: none"> • Press the BACKLIGHT button, or set the BACKLIGHT or BRIGHTNESS settings • Check CONTRAST and BRIGHTNESS adjustment • Fluorescent lamp may have reached the end of service life
Remote control does not work.	<ul style="list-style-type: none"> • Check the batteries of the remote control • Make sure the remote sensor window is not under strong lighting
Unit cannot be operated.	<ul style="list-style-type: none"> • External influences such as lightning, static electricity, etc., may cause improper operation. In this case, operate the unit after first turning the power off the LCD TV set, or unplugging the AC cord and re-plugging it in after 1 or 2 minutes

Troubleshooting (Continued)

Antenna

Problem	Check item
The picture is not sharp The picture moves.	<ul style="list-style-type: none"> The reception may be weak The quality of the broadcast may also be bad. Make sure the antenna is facing the correct direction Make sure the outside antenna is connected.
The picture is doubled or tripled	<ul style="list-style-type: none"> Make sure the antenna is facing the correct direction. There may be reflected electric waves from mountains or buildings.
The picture is spotted	<ul style="list-style-type: none"> There may be interference from automobiles, trains, high-voltage lines, neon lights, etc There may be interference between the antenna cable and AC cord. Try positioning them further apart.
There are stripes on the screen or colors fade	<ul style="list-style-type: none"> Is the unit receiving interference from other devices? Transmission antennas of radio broadcasting stations, transmission antennas of amateur radios and cellular phones may also cause interference Use the unit as far apart as possible from devices that may cause possible interference

■ Cautions regarding use in high and low temperature environments

- When the unit is used in a low temperature space (e.g. room, office), the picture may leave trails or appear slightly delayed. This is not a malfunction, and the unit will recover when the temperature returns to normal.
 - Do not leave the unit in a hot or cold location. Also, do not leave the unit in a location exposed to direct sunlight or near a heater, as this may cause the cabinet to deform and the LCD panel to malfunction.
- Storage temperature: -4°F to +140°F (-20°C to +60°C)

Specifications

Model		LC-13SH6U	LC-15SH6U	LC-20SH6U
Items				
LCD panel		13" Advanced Super View & BLACK TFT LCD	15" Advanced Super View & BLACK TFT LCD	20" Advanced Super View & BLACK TFT LCD
Number of dots		921,600 dots VGA		
Video color systems		NTSC		
TV function	TV Standard (CCIR)	NTSC		
	TV Tuning System	PLL 181 ch.		
	STEREO	MTS+SAP		
	CATV	125 ch.		
Brightness		430 cd/m ²		
Lamp life (Fluorescent lamp)		60,000 hours*		
Viewing angles		H: 170° V: 170°		
Audio amplifier		1.0 W x 2		
Speakers		1 ¹³ / ₁₆ x 4 ¹ / ₂ in. (42 x 110 mm), 2 pcs		
Terminals	INPUT1	COMPONENT-IN, AUDIO-IN		
	INPUT2	VIDEO-IN, S-VIDEO-IN, AUDIO-IN		
	INPUT3/OUTPUT	VIDEO-IN, AUDIO-IN / VIDEO-OUT, AUDIO-OUT		
	Antenna	F-Type		
	Headphone	Mini-jack for stereo (ø3.5 mm)		
OSD language		English/Spanish/French		
Power supply		AC 120V, 60Hz		
Power consumption		43 W (0.8 W standby): AC 120V	50 W (0.8 W standby): AC 120V	71 W (0.8 W standby): AC 120V
Weight	Display only	8.0 lbs./ 3.6 kg	9.1 lbs./ 4.1 kg	14.1 lbs./ 6.4 kg
	Display with stand	9.1 lbs./ 4.1 kg	10.2 lbs./ 4.6 kg	16.1 lbs./ 7.3 kg
Operating temperature		+32°F to +104°F (0°C to +40°C)		

* Typical time for power output decrease of about one-half assuming continuous use in a room with normal lighting, normal brightness and temperature at 77°F/25°C

■ As a part of policy of continuous improvement, SHARP reserves the right to make design and specification changes for product improvement without prior notice. The performance specification figures indicated are nominal values of production units. There may be some deviations from these values in individual units.

Dimensional Drawings

LC-13SH6U / 15SH6U / 20SH6U

Unit: inch (mm)

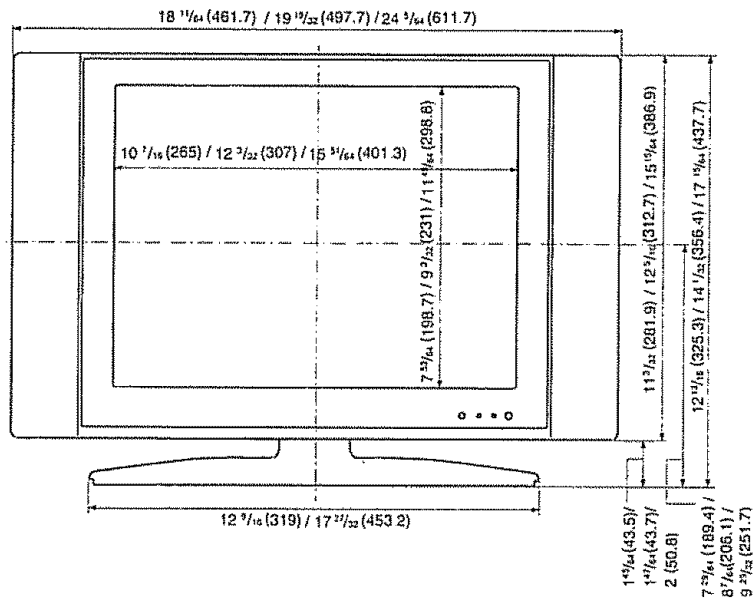

1 1/16 (39.7) / 3 7/8 (98.5) /
 2 2/16 (51.9) / 3 27/32 (97.5) /
 1 5/16 (47.9) / 3 37/64 (99)

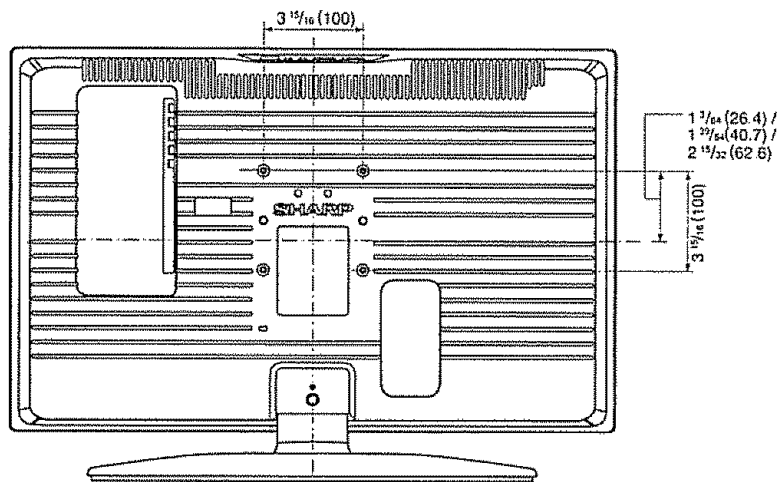
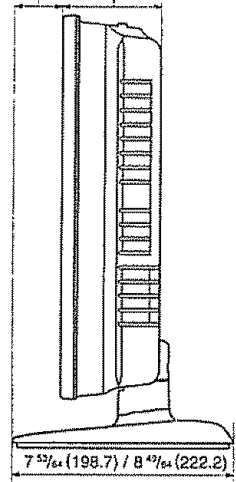

Calling for Service

For location of the nearest Sharp Authorized Service, or to obtain product literature, accessories, supplies, or customer assistance, please call 1-800-BE-SHARP

LIMITED WARRANTY

CONSUMER LIMITED WARRANTY

SHARP ELECTRONICS CORPORATION warrants to the first consumer purchaser that this Sharp brand product (the "Product"), when shipped in its original container, will be free from defective workmanship and materials, and agrees that it will, at its option, either repair the defect or replace the defective Product or part thereof with a new or remanufactured equivalent at no charge to the purchaser for parts or labor for the period(s) set forth below

This warranty does not apply to any appearance items of the Product nor to the additional excluded item(s) set forth below nor to any Product the exterior of which has been damaged or defaced, which has been subjected to improper voltage or other misuse, abnormal service or handling, or which has been altered or modified in design or construction.

In order to enforce the rights under this limited warranty, the purchaser should follow the steps set forth below and provide proof of purchase to the servicer.

The limited warranty described herein is in addition to whatever implied warranties may be granted to purchasers by law. ALL IMPLIED WARRANTIES INCLUDING THE WARRANTIES OF MERCHANTABILITY AND FITNESS FOR USE ARE LIMITED TO THE PERIOD(S) FROM THE DATE OF PURCHASE SET FORTH BELOW. Some states do not allow limitations on how long an implied warranty lasts, so the above limitation may not apply to you.

Neither the sales personnel of the seller nor any other person is authorized to make any warranties other than those described herein, or to extend the duration of any warranties beyond the time period described herein on behalf of Sharp.

The warranties described herein shall be the sole and exclusive warranties granted by Sharp and shall be the sole and exclusive remedy available to the purchaser. Correction of defects, in the manner and for the period of time described herein, shall constitute complete fulfillment of all liabilities and responsibilities of Sharp to the purchaser with respect to the Product, and shall constitute full satisfaction of all claims, whether based on contract, negligence, strict liability or otherwise. In no event shall Sharp be liable, or in any way responsible, for any damages or defects in the Product which were caused by repairs or attempted repairs performed by anyone other than an authorized servicer. Nor shall Sharp be liable or in any way responsible for any incidental or consequential economic or property damage. Some states do not allow the exclusion of incidental or consequential damages, so the above exclusion may not apply to you.

THIS WARRANTY GIVES YOU SPECIFIC LEGAL RIGHTS. YOU MAY ALSO HAVE OTHER RIGHTS WHICH VARY FROM STATE TO STATE.

Model Specific Section

Your Product Model Number & Description:	LC-13SH6U/LC-15SH6U/LC-20SH6U (Be sure to have this information available when you need service for your Product)
Warranty Period for this Product:	One (1) year parts and ninety (90) days labor from the date of purchase
Additional Item(s) Excluded from Warranty Coverage (if any):	Non-rechargeable batteries.
Where to Obtain Service:	From a Sharp Authorized Servicer located in the United States. To find the location of the nearest Sharp Authorized Servicer, call Sharp toll free at 1-800-BE-SHARP.
What to do to Obtain Service:	Ship prepaid or carry in your Product to a Sharp Authorized Servicer. Be sure to have Proof of Purchase available. If you ship the Product, be sure it is insured and packaged securely.

TO OBTAIN PRODUCT INFORMATION, CALL 1-800-BE-SHARP OR VISIT www.sharppusa.com

SHARP®

SHARP ELECTRONICS CORPORATION

Sharp Plaza, Mahwah, New Jersey 07430-2135

SHARP CORPORATION

VALID IN CANADA ONLY

SHARP®

LIMITED WARRANTY

Consumer Electronics Products

Congratulations on your purchase!

Sharp Electronics of Canada Ltd. (hereinafter called "Sharp") gives the following express warranty to the first consumer purchaser for this Sharp brand product, when shipped in its original container and sold or distributed in Canada by Sharp or by an Authorized Sharp Dealer:

Sharp warrants that this product is free, under normal use and maintenance, from any defects in material and workmanship. If any such defects should be found in this product within the applicable warranty period, Sharp shall, at its option, repair or replace the product as specified herein.

This warranty shall not apply to:

- (a) Any defects caused or repairs required as a result of abusive operation, negligence, accident, improper installation or inappropriate use as outlined in the owner's manual.
- (b) Any Sharp product tampered with, modified, adjusted or repaired by any party other than Sharp, Sharp's Authorized Service Centres or Sharp's Authorized Servicing Dealers.
- (c) Damage caused or repairs required as a result of the use with items not specified or approved by Sharp, including but not limited to head cleaning tapes and chemical cleaning agents.
- (d) Any replacement of accessories, glassware, consumable or peripheral items required through normal use of the product including but not limited to earphones, remote controls, AC adapters, batteries, temperature probe, stylus, trays, filters, belts, ribbons, cables and paper.
- (e) Any cosmetic damage to the surface or exterior that has been defaced or caused by normal wear and tear.
- (f) Any damage caused by external or environmental conditions, including but not limited to transmission line/power line voltage or liquid spillage.
- (g) Any product received without appropriate model, serial number and CSA/cUL markings.
- (h) Any products used for rental or commercial purposes.
- (i) Any installation, setup and/or programming charges.

Should this Sharp product fail to operate during the warranty period, warranty service may be obtained upon delivery of the Sharp product together with proof of purchase and a copy of this LIMITED WARRANTY statement to an Authorized Sharp Service Centre or an Authorized Sharp Servicing Dealer. In-home warranty service may be provided at Sharp's discretion on any Sharp television with the screen size of 27" or larger and on any Sharp Over-the-Range Microwave Oven.

This warranty constitutes the entire express warranty granted by Sharp and no other dealer, service centre or their agent or employee is authorized to extend, enlarge or transfer this warranty on behalf of Sharp. To the extent the law permits, Sharp disclaims any and all liability for direct or indirect damages or losses or for any incidental, special or consequential damages or loss of profits resulting from a defect in material or workmanship relating to the product, including damages for the loss of time or use of this Sharp product or the loss of information. The purchaser will be responsible for any removal, reinstallation, transportation and insurance costs incurred. Correction of defects, in the manner and period of time described herein, constitute complete fulfillment of all obligations and responsibilities of Sharp to the purchaser with respect to the product and shall constitute full satisfaction of all claims, whether based on contract, negligence, strict liability or otherwise.

WARRANTY PERIODS:

	Parts & Labour (exceptions noted)
Audio Products	1 year
Camcorder	1 year
DVD Products	1 year
Projector	1 year (lamp 90 days)
LCD & Plasma Display TV	1 year
Microwave Oven	1 year (magnetron component-4 additional years)
Television Products	1 year (picture tube component-1 additional year)
VCR Products	1 year
Vacuum Cleaner	1 year

To obtain the name and address of the nearest Authorized Sharp Service Centre or Dealer, please contact:
SHARP ELECTRONICS OF CANADA LTD. 335 Britannia Road East, Mississauga, Ontario L4Z 1W9

For more information on this Warranty, Sharp Extended Warranty Offers, Sharp Canada Products, Accessory Sales, Dealer or Service Locations, please call (905) 568-7140
Visit our Web site: www.sharp.ca



Revision 04/22/03

Free Manuals Download Website

<http://myh66.com>

<http://usermanuals.us>

<http://www.somanuals.com>

<http://www.4manuals.cc>

<http://www.manual-lib.com>

<http://www.404manual.com>

<http://www.luxmanual.com>

<http://aubethermostatmanual.com>

Golf course search by state

<http://golfingnear.com>

Email search by domain

<http://emailbydomain.com>

Auto manuals search

<http://auto.somanuals.com>

TV manuals search

<http://tv.somanuals.com>