

SHARP®

MODEL

UX-355L

FACSIMILE

OPERATION MANUAL

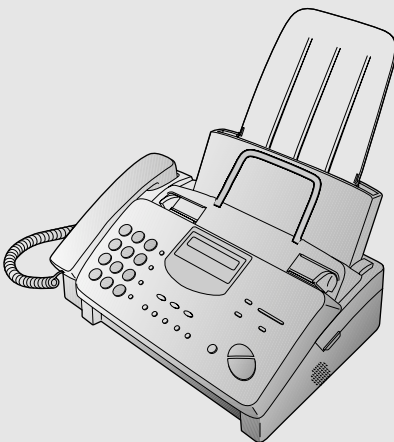

1. Installation
2. Setting Up and Using OpenLCR
3. Sending Documents
4. Receiving Documents
5. Making Copies
6. Making Telephone Calls
7. Answering Machine Hookup
8. Special Functions
9. Printing Lists
10. Maintenance
11. Troubleshooting



www.OpenLCR.com

WARNING - FCC Regulations state that any unauthorized changes or modifications to this equipment not expressly approved by the manufacturer could void the user's authority to operate this equipment.

Note: This equipment has been tested and found to comply with the limits for a Class B digital device, pursuant to Part 15 of the FCC Rules.

These limits are designed to provide reasonable protection against harmful interference in a residential installation.

This equipment generates, uses and can radiate radio frequency energy and, if not installed and used in accordance with the instructions, may cause harmful interference to radio communications. However, there is no guarantee that interference will not occur in a particular installation. If this equipment does cause harmful interference to radio or television reception, which can be determined by turning the equipment off and on, the user is encouraged to try to correct the interference by one or more of the following measures:

- Reorient or relocate the receiving antenna.
- Increase the separation between the equipment and the receiver.
- Connect the equipment into an outlet on a circuit different from that to which the receiver is connected.
- Consult the dealer or an experienced radio/TV technician for help.

ABOUT THE TELEPHONE CONSUMER PROTECTION ACT OF 1991

"The Telephone Consumer Protection Act of 1991 makes it unlawful for any person to use a computer or other electronic device to send any message via a telephone facsimile machine unless such message clearly contains in a margin at the top or bottom of each transmitted page or on the first page of the transmission the following information:

- (1) The date and time of transmission.
- (2) Identification of either the business, business entity or individual sending the message.
- (3) Telephone number of either the sending machine, business, business entity or individual.

In order to program this information into your facsimile machine, please refer to the appropriate instructions in the operation manual."



As an ENERGY STAR® partner, SHARP has determined that this product meets the ENERGY STAR® guidelines for energy efficiency.

FOR YOUR RECORDS

Please record the model number and serial number below, for easy reference, in case of loss or theft. These numbers are located on the rear side of the unit. Space is also provided for other relevant information.

Model Number _____

Serial Number _____

Date of Purchase _____

Place of Purchase _____

Introduction

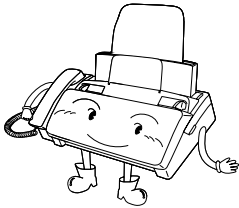

Welcome, and thank you for choosing a Sharp facsimile machine! The features and specifications of your new Sharp fax are shown below.

Automatic dialing

Rapid Key Dialing: 7 numbers
Speed Dialing: 40 numbers

Imaging film

Initial starter roll (included with machine):
32 ft. (10 m) (approx. 30 letter-size pages)

Replacement roll:

UX-3CR 98 ft. (30 m) (two rolls in package, one roll yields approx. 100 letter-size pages)

Memory size*

476 KB (approx. 27 average pages with ECM turned off)

Modem speed

14,400 bps with automatic fallback to lower speeds.

Transmission time*

Approx. 6 seconds (only when ECM is on)

Resolution

Horizontal: 203 pels/inch (8 pels/mm)

Vertical:

Standard: 98 lines/inch (3.85 lines/mm)

Fine /Halftone:

196 lines/inch (7.7 lines/mm)

Super fine:

391 lines/inch (15.4 lines/mm)

Automatic document feeder

10 pages max. (20 lb paper)

Recording system

Thermal transfer recording

*Based on ITU-T Test Chart #1 at standard resolution, excluding time for protocol signals (i.e., ITU-T phase C time only).

Halftone (grayscale)	64 levels
Display	16-digit LCD display
Paper tray capacity (16- to 20-lb. paper)	Letter: 60 sheets Legal: 30 sheets
Compression scheme	MR, MH, MMR
Applicable telephone line	Public switched telephone network
Compatibility	ITU-T (CCITT) G3 mode
Input document size	Automatic feeding: Width: 5.8 to 8.5" (148 to 216 mm) Length: 5.5 to 11" (140 to 279 mm) Manual feeding: Width: 5.8 to 8.5" (148 to 216 mm) Length: 5.5 to 23.6" (140 to 600 mm)
Effective scanning width	8.3" (210 mm) max.
Effective printing width	8.3" (210 mm) max.
Contrast control	Automatic/Dark selectable
Reception modes	TEL/FAX/A.M. (Note: A.M. mode is for connecting an answering machine)
Copy function	Single/Multi/Sort (99 copies/page)
Telephone function	Yes (cannot be used if power fails)
Power requirements	120 V AC, 60 Hz
Operating temperature	41 - 95°F (5 - 35°C)
Humidity	Maximum: 85% RH
Power consumption	Standby: 4.0 W Maximum: 100 W

Dimensions

Width: 13.5" (343 mm)
Depth: 10.1" (256 mm)
Height: 7.2" (182 mm)

Weight

Approx. 7.7 lbs. (3.5 kg)

As a part of our policy of continuous improvement, SHARP reserves the right to make design and specification changes for product improvement without prior notice. The performance specification figures indicated are nominal values of production units. There may be some deviations from these values in individual units.

Important safety information

- Do not disassemble this machine or attempt any procedures not described in this manual. Refer all servicing to qualified service personnel.
- Do not install or use the machine near water, or when you are wet. For example, do not use the machine near a bath tub, wash bowl, kitchen sink or laundry tub, in a wet basement, or near a swimming pool. Take care not to spill any liquids on the machine.
- Unplug the machine from the power outlet and telephone jack and consult a qualified service representative if any of the following situations occur:
 - Liquid has been spilled into the machine or the machine has been exposed to rain or water.
 - The machine produces odors, smoke, or unusual noises.
 - The power cord is frayed or damaged.
 - The machine has been dropped or the housing damaged.
- Do not allow anything to rest on the power cord, and do not install the machine where people may walk on the power cord.
- This machine must only be connected to a 120 V, 60 Hz, grounded (3-prong) outlet. Connecting it to any other kind of outlet will damage the machine and invalidate the warranty.

- Never insert objects of any kind into slots or openings on the machine. This could create a risk of fire or electric shock. If an object falls into the machine that you cannot remove, unplug the machine and consult a qualified service representative.
- Do not place this machine on an unstable cart, stand or table. The machine could be seriously damaged if it falls.
- Never install telephone wiring during a lightning storm.
- Never install telephone jacks in wet locations unless the jack is specifically designed for wet locations.
- Never touch bare telephone wires or terminals unless the telephone line has been disconnected at the network interface.
- Use caution when installing or modifying telephone lines.
- Avoid using a telephone (other than a cordless type) during an electrical storm. There may be a remote risk of electric shock from lightning.
- Do not use a telephone to report a gas leak in the vicinity of the leak.
- The power outlet must be installed near the equipment and must be easily accessible.

Important:

- This facsimile machine is not designed for use on a line which has call waiting, call forwarding, or certain other special services offered by your telephone company. If you attempt to use the fax machine in conjunction with any of these services, you may experience errors during transmission and reception of facsimile messages.
- This facsimile machine is not compatible with digital telephone systems.

Table of Contents

Introduction	1
Important safety information	3
Table of Contents	5
A Look at the Operation Panel	7
1. Installation	9
Unpacking Checklist	9
Connections	10
Loading the Imaging Film	16
Loading Printing Paper	22
Entering Your Name and Fax Number	25
Setting the Date and Time	29
Setting the Reception Mode	32
Volume Adjustment	33
2. Setting Up and Using OpenLCR	35
3. Sending Documents	50
Transmittable Documents	50
Loading the Document	52
Adjusting the Resolution and Contrast	55
Sending a Fax by Normal Dialing	58
Sending a Fax by Automatic Dialing	60
4. Receiving Documents	72
Using FAX Mode	72
Using TEL Mode	74
Substitute Reception to Memory	80
5. Making Copies	81
6. Making Telephone Calls	85

7. Answering Machine Hookup	88
Connecting an Answering Machine	88
Optional A.M. Mode Settings	91
8. Special Functions	93
Caller ID (Requires Subscription to Service)	93
Distinctive Ring (Requires Subscription to Service)	99
Broadcasting	101
Cover Sheet	103
Batch Page Numbering	106
Blocking Reception of Unwanted Faxes	108
Sending Documents From Memory	110
Polling (Requesting a Fax Transmission)	112
Timer Operations	116
9. Printing Lists	119
10. Maintenance	126
11. Troubleshooting	130
Problems and Solutions	130
Messages and Signals	135
Clearing Paper Jams	138
Ordering Parts	141
FCC Regulatory Information	142
Quick Reference Guide	143
Guía de referencia rápida	145
Index	151

- 7 FUNCTION key**
Press this key to select various special functions.
- 8 Panel release**
Grasp this finger hold and pull toward you to open the operation panel.
- 9 Number keys**
Use these keys to dial numbers, and enter numbers and letters when storing auto-dial numbers.
- 10 HOLD/SEARCH key**
Press this key to search for an auto-dial number, or, during a phone conversation, press this key to put the other party on hold.
- 11 SPEAKER key**
Press this key to listen to the line and fax tones through the speaker when faxing a document.
Note: **This is not a speakerphone.** You must pick up the handset to talk with the other party.
- 12 Rapid Dial Keys**
Press one of these keys to dial a fax number automatically.
- 13 OpenLCR key**
Press this key to register for OpenLCR service and receive carrier rate data to your fax.
- 14 STOP key**
Press this key to cancel an operation before it is completed.
- 15 START/MEMORY key**
Press this key to begin transmission when using Speed Dialing, Direct Keypad Dialing, or Normal Dialing.
- 16 COPY/HELP key**
When a document is in the feeder, press this key to make a copy of a document. At any other time, press this key to print out the Help List, a quick reference guide to the operation of your fax machine.

1. Installation

Unpacking Checklist

Before setting up, make sure you have all of the following items.



If any are missing, contact your dealer or retailer.

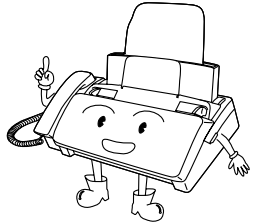

Original document support



Paper tray extension

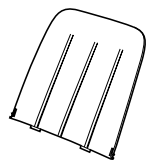

Handset



Rapid key labels



Handset cord

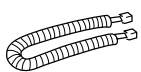

Operation manual

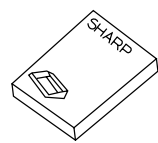

Gears (4)

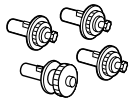

Telephone line cord

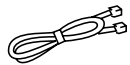

Imaging film (initial starter roll)

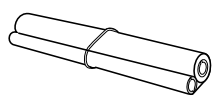

Imaging film cartridge

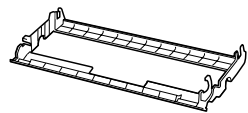

Connections

Points to keep in mind when setting up

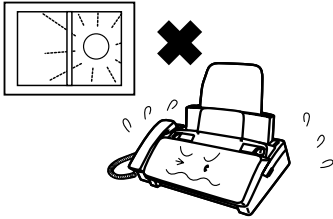

Do not place the machine in direct sunlight.

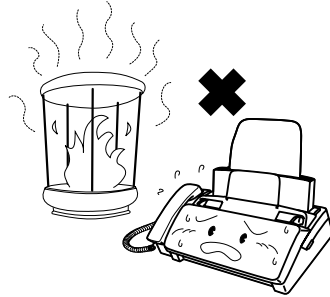

Do not place the machine near heaters or air conditioners.

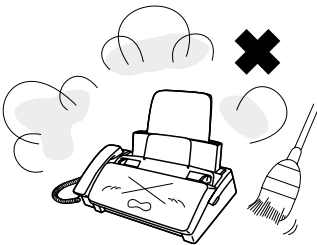

Keep dust away from the machine.

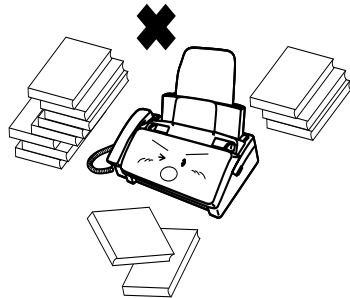

Keep the area around the machine clear.

About condensation

If the machine is moved from a cold to a warm place, it is possible that condensation may form on the scanning glass, preventing proper scanning of documents for transmission. To remove the condensation, turn on the power and wait approximately two hours before using the machine.

Connecting the Handset

Connect the handset as shown and place it on the handset rest.

- ◆ The ends of the handset cord are identical, so they will go into either jack.

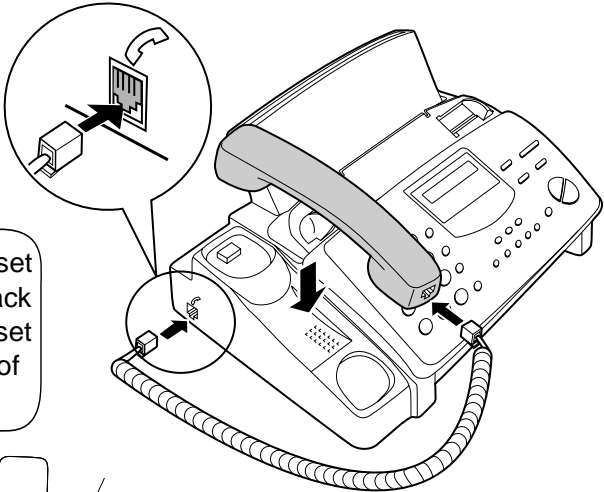

Make sure the handset cord goes into the jack marked with a handset symbol on the side of the machine!

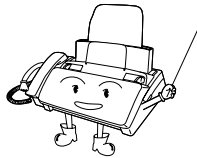

Use the handset to make ordinary phone calls, or to transmit and receive faxes manually.

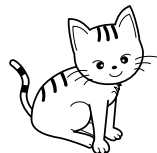

Connecting the power cord

Plug the power cord into a 120 V, 60 Hz, grounded AC (3-prong) outlet.

Caution!

Do not plug the power cord into any other kind of outlet. This will damage the machine and is not covered under the warranty.

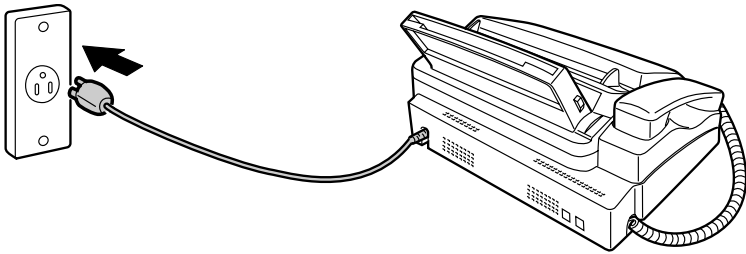

The machine does not have a power on/off switch, so the power is turned on and off by simply plugging in or unplugging the power cord.

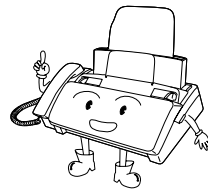

Note: If your area experiences a high incidence of lightning or power surges, we recommend that you install surge protectors for the power and telephone lines. Surge protectors can be purchased at most telephone specialty stores.

Connecting the telephone line cord

Insert one end of the line cord into the jack on the back of the machine marked **TEL. LINE**. Insert the other end into a standard (RJ11C) single-line wall telephone jack.

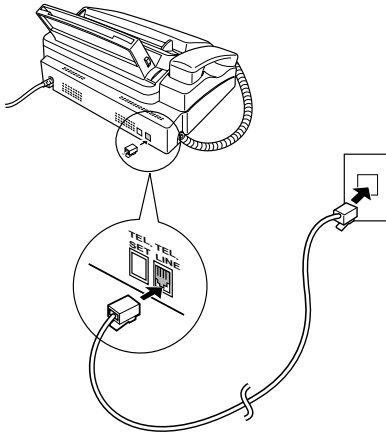

Be sure to insert the line into the **TEL. LINE** jack. **Do not** insert it into the **TEL. SET** jack.

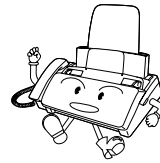

Note: The fax machine is set for tone dialing. If you are on a pulse dial line, you must set the fax machine for pulse dialing. Press the keys on the operation panel as follows:

- 1** Press these keys:

FUNCTION



4



#

#

#

#

The display will show:

DIAL MODE

#

#

#

#

- 2** Press **1** to select tone dialing, or **2** to select pulse dialing.

TONE

PULSE

1

or

2

- 3** Press the **STOP** key to return to the date and time display.

STOP



Attaching the tray extension and document support

Attach the paper tray extension.

- ◆ Pull the paper release plate forward. Insert the paper tray extension horizontally into the notches in the paper tray. Rotate the paper tray extension up until it snaps into place.

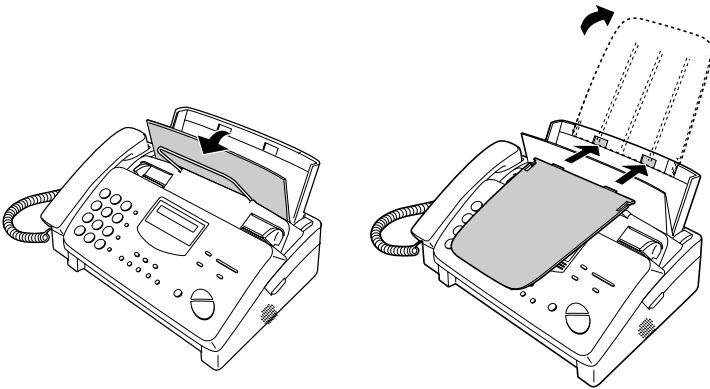

Attach the original document support.

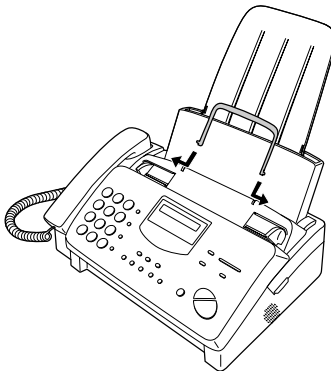

Note: The original document support has a top side and a bottom side. If you cannot insert the tabs on the support into the holes, turn the support over.

Extension phone (optional)

If desired, you can connect an extension phone to the **TEL. SET** jack on the fax.

- ◆ To connect an answering machine to your fax, see Chapter 7, *Answering Machine Hookup* (page 88).

-
- 1** Remove the seal covering the **TEL. SET** jack.

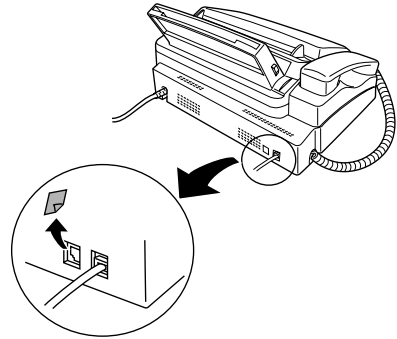

-
- 2** Connect the extension phone line to the **TEL. SET** jack.

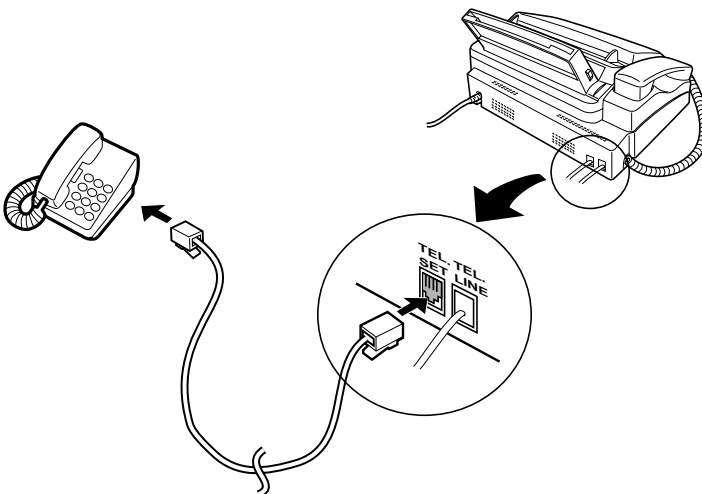

Loading the Imaging Film

Your fax uses a roll of imaging film to create printed text and images. The print head in the fax applies heat to the imaging film to transfer ink to the paper. Follow the steps below to load or replace the film..

The initial starter roll of imaging film included with your fax can print about 30 letter-size pages.



When replacing the film, use a roll of Sharp UX-3CR imaging film. One roll can print about 100 letter-size pages.



Note: If there is paper in the paper tray, pull the paper release plate forward and remove the paper before loading the imaging film.

- 1 Open the operation panel by grasping the finger hold and pulling up.

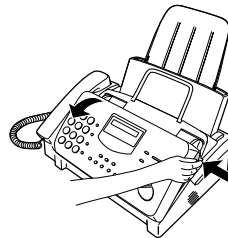

- 2 Pull the green release on the right side of the machine forward, and open the print compartment cover.

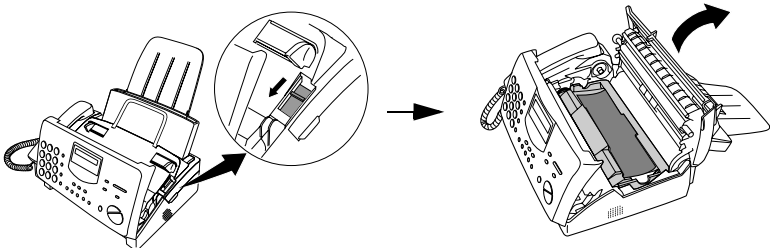

If you are installing the imaging film for the first time, go to Step 6.

- 3** Remove the imaging film cartridge from the print compartment (grasp the handle at the front of the cartridge) and turn it over.

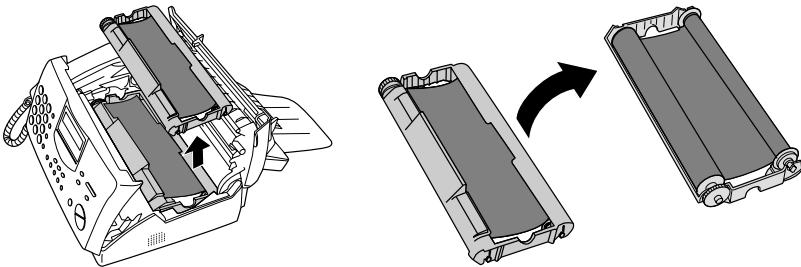

- 4** Remove the used film from the cartridge.

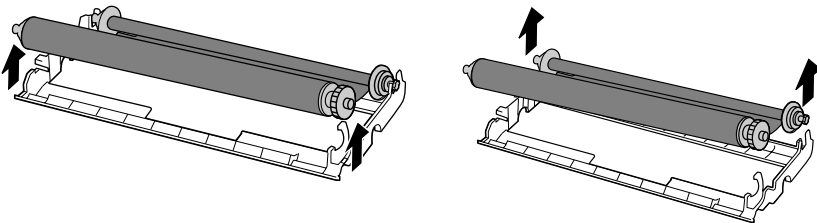

- 5** Remove the four green gears from the used film. **DO NOT DISCARD THE FOUR GREEN GEARS!**

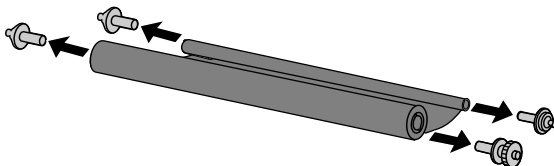

6 Remove the new roll of imaging film from its packaging.

- Do not yet remove the band that holds the rolls together.

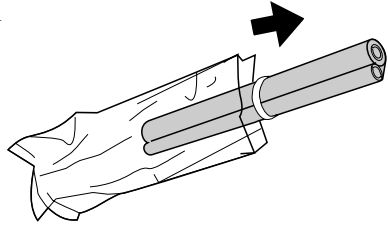

7 Insert the large gear into the green end of the empty spool. Make sure the two protrusions on the large gear fit firmly into the slots in the end of the spool.

Insert the remaining three gears into the spools, making sure the protrusion on each gear fits firmly into one of the slots in the end of each spool.

- If needed, pull the spools apart slightly to allow the gears to fit (the band will stretch).

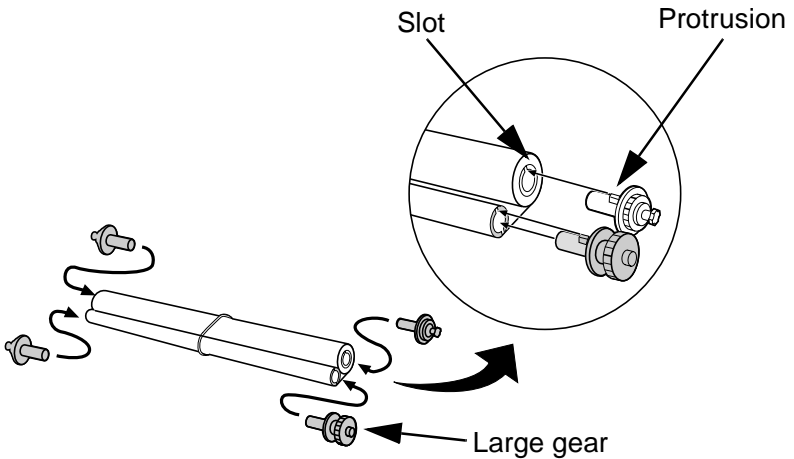

-
- 8** Insert the large gear into the large holder on the imaging film cartridge (make sure it clicks into place), and then insert the small gear on the other end of the spool into its holder.

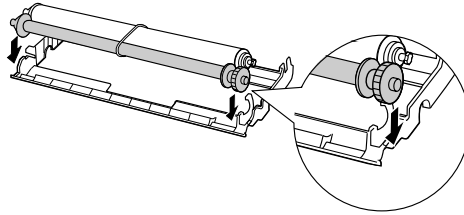

-
- 9** Cut the band that holds the two spools together. Unroll the film slightly and insert the small gears into their holders.

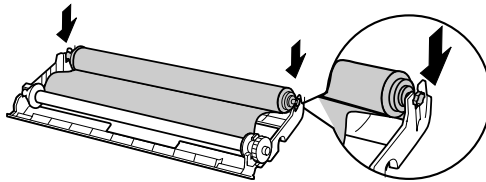

-
- 10** Turn the cartridge over, grasp the handle, and insert the cartridge into the print compartment.

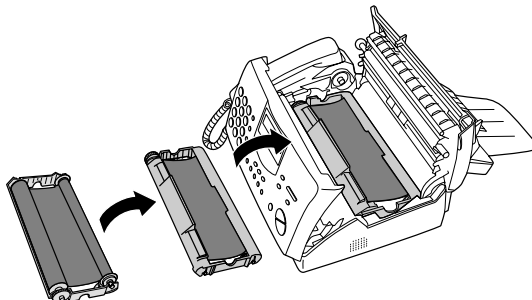

-
- 11** Rotate the large gear toward you until the film is taut.

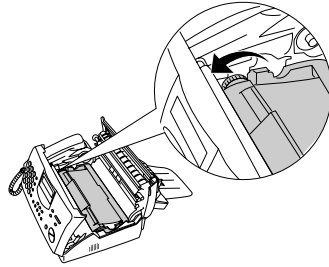

-
- 12** Close the print compartment cover (press down on both sides to make sure it clicks into place), and then close the operation panel.

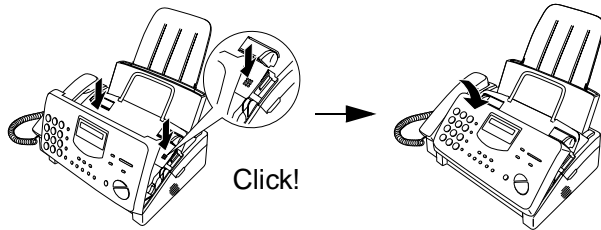

-
- 13** Load paper in the paper tray and then press the following keys to initialize the film.

Note: Paper must be loaded before the film can be initialized. To load paper, see *Loading the Printing Paper* on page 22.

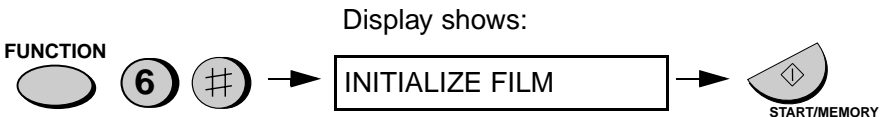

When to replace the imaging film

Replace the imaging film when the display shows:



FILM END

Use the following imaging film, which is available from your dealer or retailer:

Sharp UX-3CR Imaging Film

Loading Printing Paper

You can load letter or legal size paper in the paper tray. The maximum number of sheets depends on the weight and size of the paper you are loading.

- ◆ Paper from 16 to 20 lbs. (60 to 75 g/m²):
Letter size: 60 sheets Legal size: 30 sheets
 - ◆ Paper from 20 to 24 lbs. (75 to 90 g/m²):
Letter size: 50 sheets Legal size: 25 sheets
-

- 1** Fan the paper, and then tap the edge against a flat surface to even the stack.

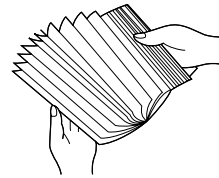

- 2** Pull the paper release plate toward you.

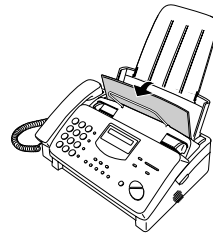

- 3** Insert the stack of paper into the tray, print side down.

- If paper remains in the tray, take it out and combine it into a single stack with the new paper before adding the new paper.

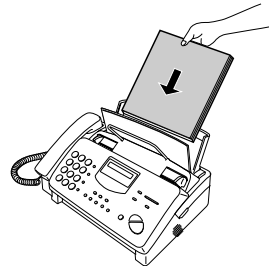

Important:

Be sure to load the paper so that printing takes place on the **print** side of the paper. Printing on the reverse side may result in poor print quality.

- 4** Push the paper release plate back down.
- If the paper release plate is not pushed down, paper feed errors will result.

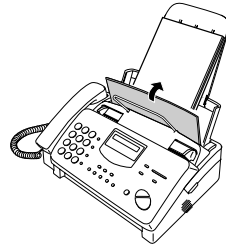

Note: When receiving faxes or copying documents, do not allow a large number of pages to accumulate in the output tray. This may obstruct the outlet and cause paper jams.

- 5** If the display shows the following alternating messages, press the **START/MEMORY** key. (If not, go directly to Step 6.)



- 6** The fax has been set at the factory to scale the size of received faxes to letter size paper. If you have loaded legal paper, you must change the paper size setting to legal. Press these keys:



The display will show:

PAPER SIZE SET

Press **1** to select LETTER or **2** to select LEGAL.

LETTER LEGAL

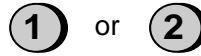

The display will show:



Press the **STOP** key to return to the date and time display.

STOP



7 Your fax has been set at the factory to print at normal contrast. Depending on the type of paper you have loaded, you may find that you obtain better print quality by changing the setting to LIGHT. Press these keys:

FUNCTION



The display will show:



Press **1** to select NORMAL or **2** to select LIGHT.

NORMAL LIGHT

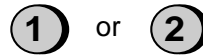

The display will show:

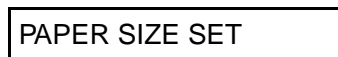

Press the **STOP** key to return to the date and time display.

STOP



Entering Your Name and Fax Number

Before you can begin using your fax, you must enter your name and fax (telephone) number. You also need to set the date and time.



Once you enter this information, it will automatically appear at the top of each fax page you send.

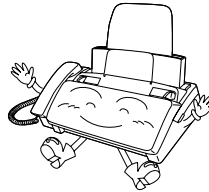

Important!

The law requires that your name, telephone/fax number, and the date and time appear on each fax message you send. Enter your name and fax number here and set the date and time as explained in the following section to have the fax machine include this information automatically at the top of your fax messages.

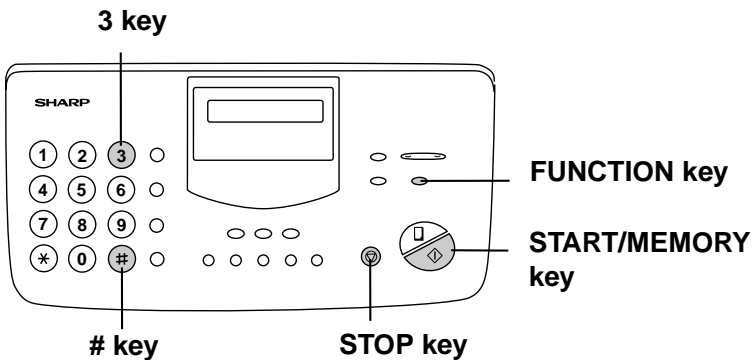

Note: The imaging film and printing paper must be loaded before your name and fax number can be entered.

Entering Your Name and Fax Number

1 Press these keys:

FUNCTION



The display will show:

ENTRY MODE

2 Press the # key twice.



The display will show:

OWN NUMBER SET

3 Press the **START/MEMORY** key.

The display will show:

ENTER FAX #



4 Enter your fax number by pressing the number keys (max. of 20 digits).



- To insert a space between digits, press the # key.



- If you make a mistake, press the **SPEED DIAL** key to backspace and clear the mistake.



(Example)

5 Press the **START/MEMORY** key to enter the fax number in memory.





















































































The display will show:

ENTER YOUR NAME



6 Enter your name by pressing number keys for each letter as shown in the chart below. Up to 24 characters can be entered.

Example: SHARP = 77777 444 22 7777  77

SPACE =  	J =  	T =  
A =  	K =   	U =   
B =   	L =    	V =    
C =    	M =  	W =  
D =  	N =   	X =   
E =   	O =    	Y =    
F =    	P =  	Z =     
G =  	Q =   	
H =   	R =    	
I =    	S =     	

- ◆ To enter two letters in succession that require the same key, press the **SPEAKER** key after entering the first letter. (The **SPEAKER** key moves the cursor forward, and the **HOLD/SEARCH** key moves the cursor backward.)
- ◆ To clear a mistake, press the **SPEED DIAL** key.
- ◆ To change case, press the **REDIAL** key.
- ◆ To enter one of the following symbols, press the # key or the * key repeatedly:
 . / ! " # \$ % & ' () * + , - . : ; < = > ? @ [¥] ^ _ ' { | } → ←

Cursor: A dark square mark in the display that indicates where a number or letter will be entered.

- 7** Press the **START/MEMORY** key.

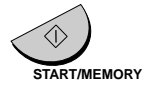

The display will show:

SECURITY SELECT

-
- 8** Press the **STOP** key to return to the date and time display.



Setting the Date and Time

The date and time appear in the display and are printed at the top of every page you fax.

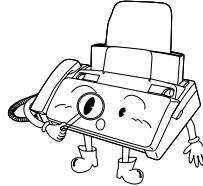

Set the date and time by pressing the keys on the operation panel as shown below.

Do not set the date and time if you are using OpenLCR!

OpenLCR automatically sets the date and time each time your fax calls OpenLCR and receives rate data. To ensure accurate use of the rate data, do not change the date and time setting yourself. OpenLCR also sets the date and time for you if you perform the fax transmission test (see page 40).

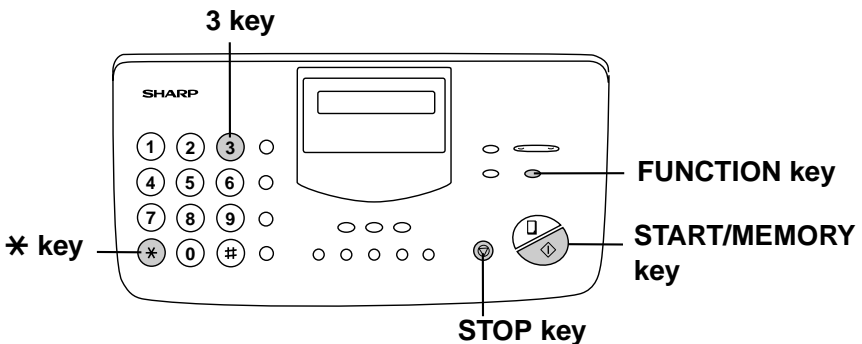

Note: The imaging film and printing paper must be loaded before the date and time can be set.

1 Press these keys:

FUNCTION



The display will show:

ENTRY MODE

2 Press these keys:

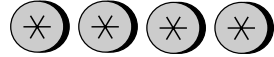

The display will show:

DATE & TIME SET

3 Press the **START/MEMORY** key.

- The currently set date will appear in the display.



4 Enter a two-digit number for the month (“01” for January, “02” for February, “12” for December, etc.).



- To correct a mistake, press the **SPEED DIAL** key to move the cursor back to the mistake and then enter the correct number.

Example: January

5 Enter a two-digit number for the day (“01” to “31”).



Example: the 5th

6 Enter the year (four digits).



Example: 2000

7 Enter a two-digit number for the hour (“01” to “12”) and a two-digit number for the minute (“00” to “59”).



Example: 9:25

- 8** Press the * key to select A.M. or the # key to select P.M.

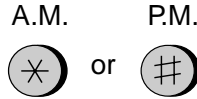

- 9** Press the **START/MEMORY** key to start the clock.



The display will show:

DAY LIGHT SAVING

- 10** Press the **STOP** key to return to the date and time display.



Daylight Saving Time

If desired, you can set the clock to move forward and backward automatically at the beginning and end of Daylight Saving Time. To turn on this function, press the panel keys as follows:

- 1** Press these keys:

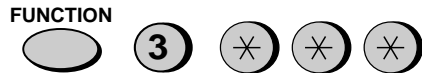

The display will show:

DAY LIGHT SAVING

- 2** Press **1** to turn on the Daylight Saving Time function, or **2** to turn it off.

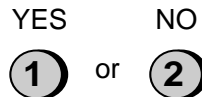

- 3** Press the **STOP** key to return to the date and time display.



Setting the Reception Mode

Your fax has three modes for receiving incoming calls and faxes:

TEL mode:

Select this mode when you want to receive both phone calls and faxes on the line connected to the fax machine. **All calls, including faxes, must be answered by picking up the fax machine's handset** or an extension phone connected to the same line.

FAX mode:

Select this mode when you only want to receive faxes on your line. The fax machine will automatically answer all calls on four rings and receive incoming faxes.

A.M. mode:

Use this mode only if you have connected an answering machine to the fax (see Chapter 7). Select this mode when you go out to receive voice messages in your answering machine and faxes on your fax machine.

Setting the reception mode

Press the **RECEPTION MODE** key until the arrow in the display points to the desired mode.

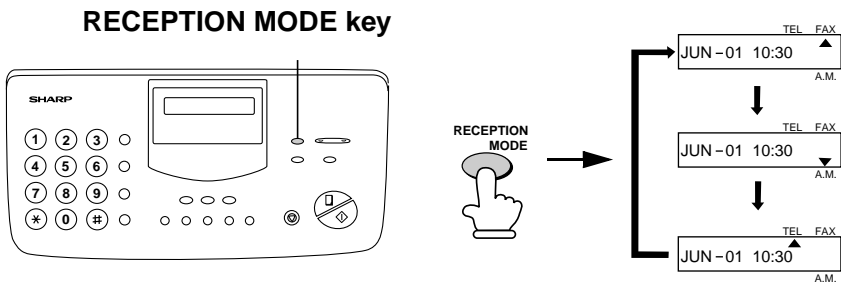

For more information on receiving faxes in TEL and FAX modes, see Chapter 4, *Receiving Documents* (page 72). For more information on using A.M. mode, see Chapter 7, *Answering Machine Hookup* (page 88).

Volume Adjustment

You can adjust the volume of the speaker and ringer using the **UP** and **DOWN** keys.

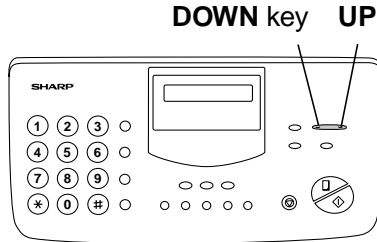

Speaker

- 1 Press the **SPEAKER** key.

SPEAKER



- 2 Press the **UP** or **DOWN** key.

Display:

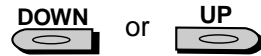
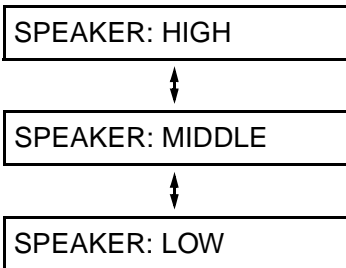

- 3 When the display shows the desired volume level, press the **SPEAKER** key to turn off the speaker.

SPEAKER



Handset

- 1 Lift the handset.



-
- 2** Press the **UP** or **DOWN** key.

Display:

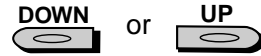
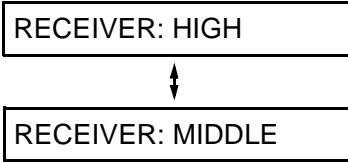

-
- 3** When the display shows the desired volume level, replace the handset.

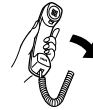

Ringer

-
- 1** Press the **UP** or **DOWN** key. (Make sure the **SPEAKER** key has not been pressed and the handset is not lifted.)

Display:

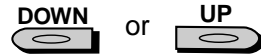
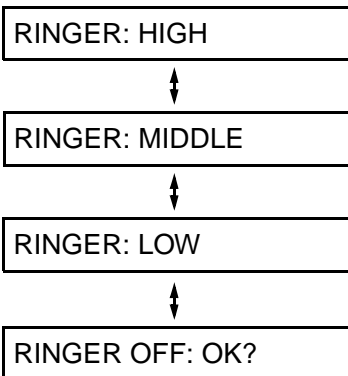

The ringer will ring once at the selected level, then the date and time will reappear in the display.

-
- 2** If you selected **RINGER OFF: OK?**, press the **START/MEMORY** key.

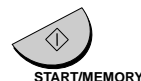

2. Setting Up and Using OpenLCR

Your fax machine features OpenLCR technology, which helps you save money on long distance and international phone calls (both fax and voice) by automatically routing each call for the best available rate.

- ◆ OpenLCR service is free of charge. The only cost to you is that of a periodic call (usually once every three months) to OpenLCR to receive the latest rate data. (Once you have registered with OpenLCR, your fax machine automatically makes this call.)
- ◆ All calls routed by OpenLCR are consolidated on your monthly phone bill.

To take advantage of this feature, you will need to register with OpenLCR and download the rate data to your fax machine.

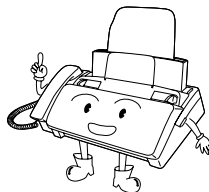

You can register with OpenLCR by fax, phone, or through OpenLCR's Web site (www.OpenLCR.com).

- ◆ Before registering, be sure to read the information on the **Fax Transmission Test and OpenLCR Line Activation Form and Terms of Service** sheet included with your fax machine. If you have any questions, call OpenLCR at 970-206-1207.
- ◆ OpenLCR uses Caller ID for identification purposes when your fax calls OpenLCR to receive rate information. Even if you have requested your telephone company to withhold your Caller ID information when you place calls, your fax will still automatically transmit this information only when it calls OpenLCR.
- ◆ It is possible to register for and use OpenLCR if you do not subscribe to a Caller ID service; however, in some instances where rate data must be changed on an emergency basis, your fax may not

be able to respond automatically to OpenLCR's call to notify your fax that it must receive new rate data. If this occurs, old, incorrect data will continue to be used.

- ◆ Please note that the agreement you enter into by registering is between you and OpenLCR; it is not between you and any carriers.

Registering by fax

To register by fax, fill in the **Fax Transmission Test and OpenLCR Line Activation Form**, and then fax the form as follows:

- 1 Place the form with the side you wrote on face down, and push it gently into the document feeder of the fax machine.

The display will show:

READY TO SEND

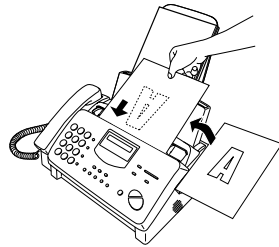

- 2 Press the **OpenLCR** key, the **5** key, and then the **START/MEMORY** key.

- Your fax automatically calls OpenLCR and sends the form. After the form is sent, your fax will automatically receive the rate data. This lasts one or two minutes. When downloading is completed, the display will briefly show **DOWNLOAD OK!!** and then revert to the date and time. Your fax will print out the registration form to confirm that it was received.
- OpenLCR will also program the date and time and your fax number in your fax machine.



Registering by phone

To register by phone, follow these steps:

- 1 Pick up the handset on the fax machine.

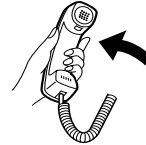

- 2 Press the **OpenLCR** key and then the **1** key.



- 3 If the display shows the alternating messages at right, press the number keys to enter your fax/phone number, including the area code (the number must be 10 digits long). When finished, press the **START/MEMORY** key.

(If the message at right doesn't appear, this step is not necessary.)

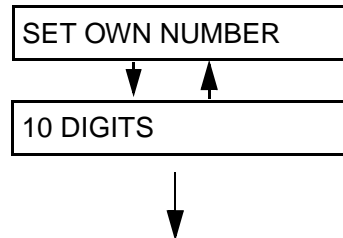

(Example)

Important!

Be sure that you enter your correct area code and fax number. If not, your fax may not dial the correct number to connect to OpenLCR.

4 Follow the instructions you hear.

- ◆ **Note:** If you are on a pulse dial line, press the * key before pressing the number keys to respond.
(This makes your fax temporarily issue tone signals when you press the number keys.)
- ◆ When registration is completed, your fax machine will receive the rate data from OpenLCR. This will last one or two minutes. When downloading is completed, the display will briefly show **DOWNLOAD OK!!** and then revert to the date and time.
- ◆ OpenLCR will also program the date and time and your fax number in your fax machine.

Registering through OpenLCR's Web site

You can also register at OpenLCR's Web site, **www.OpenLCR.com**. After registering you will need to receive the rate data manually (service is not activated until your fax receives the rate data). See *Downloading (receiving) the rate data manually* on the following page.



If you move, you must re-register!

The rate data that you receive is based on the address you provide when registering with OpenLCR. If you move, the rate data will not be correct for your new location. In this case, repeat the registration procedure to give OpenLCR your new address.

Note: If you wish to connect more than one OpenLCR-enabled device to the same line, please call OpenLCR at 970-206-1207.

Note: OpenLCR cannot be used if your fax machine is connected to a Private Branch Exchange (PBX).

Downloading (receiving) the rate data manually

Your fax machine will automatically call OpenLCR and download updated rate data about once every three months. Normally you will not need to download the rate data manually.

- ◆ If you register through OpenLCR's Web site, you must manually download the rate data to activate service.
- ◆ If the fax machine is unplugged or some other interruption occurs in the power, you will need to manually download the rate data.

Press these keys to call OpenLCR and initiate downloading:



Downloading lasts one or two minutes. During this time the display will show:

LCR DOWNLOADING

When downloading is completed, the display will briefly show DOWNLOAD OK!! and then revert to the date and time. OpenLCR will also program the date and time and your fax number in your fax machine.

Fax transmission test

Even if you are not ready to register for OpenLCR service, we recommend that you test your fax setup by filling out Section A of the **Fax Transmission Test and OpenLCR Line Activation Form** and faxing it to OpenLCR as shown below. The test is free of charge and does not place you under any obligation to register with OpenLCR.

- ◆ If the test sheet is successfully transmitted, it will be faxed back to you on the same connection. This lets you confirm that your setup is okay.
- ◆ After receiving the test sheet, the current date and time will automatically be programmed in your fax machine. This saves you the trouble of setting the date and time in the fax yourself.

-
- 1** Place the form with Section A face down, and push it gently into the document feeder of the fax machine.

The display will show:

READY TO SEND

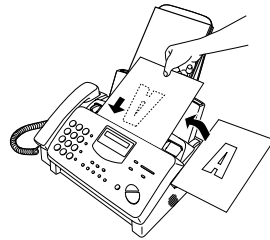

-
- 2** Press the **OpenLCR** key, the **5** key, and then the **START/MEMORY** key.

- Your fax machine will automatically call OpenLCR and send the form. The form will then be faxed back to you, and the current date and time programmed in your fax machine.



Using OpenLCR

When you have registered with OpenLCR and downloaded the rate data to your fax machine, a highlighted “C” will appear in the date and time display to indicate that the OpenLCR feature is activated.

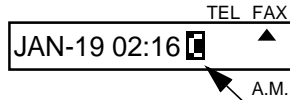

“C” indicates that
OpenLCR is activated

Each time you make a long distance phone or fax call, the fax machine will automatically route the call through the least expensive carrier based on the downloaded rate information.

Don't unplug the fax, or the rate data will be lost!

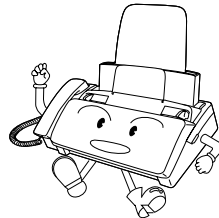







Caution!

If you unplug the fax machine or an interruption occurs in your power supply, the rate data will be erased. If this happens, the highlighted “C” in the display will blink to alert you.

The fax machine will automatically call OpenLCR within the next 24 hours to receive new rate data; however, if you want to use OpenLCR service before that time, you should download the rate table manually as explained on page 39.

- ◆ We recommend that you do not unplug the fax machine on a regular basis (for example at night or on the weekends), as this will result in a large number of calls to OpenLCR and a higher phone bill depending on where you live.

The following table shows marks related to OpenLCR that may appear in the display.

Mark	Meaning
	OpenLCR has been activated and is ready for use.
 (Blinking)	OpenLCR cannot be used because the rate data has been erased. Your fax will automatically call OpenLCR within the next 24 hours to receive new data, or you can download the data manually if you need to use OpenLCR immediately. See <i>Downloading (receiving) the rate data manually</i> on page 39.
	The rate data in the fax is no longer correct and the fax cannot connect to OpenLCR to obtain new data. See <i>What to do if "E" appears in the display</i> on page 45.
	OpenLCR has been temporarily turned off. See <i>Temporarily turning off OpenLCR</i> below.
	Rate data was not yet available when your fax called OpenLCR. Your fax will automatically call OpenLCR again when the rate data is available. Until that time, long distance calls will be routed through your primary carrier.
 (Blinking)	Your fax will automatically call OpenLCR within the next 24 hours to learn when correct rate data will be available.
	Your fax did not receive rate data because OpenLCR was unable to identify it by Caller ID. To remove the "H" display, press the OpenLCR key followed by #, 1, 8, 4, and # . To receive OpenLCR service, you will need to contact your phone company and allow it to send your Caller ID information when you place calls. After this, register once again with OpenLCR.

Temporarily turning off OpenLCR

If needed, you can temporarily turn off OpenLCR.

- ◆ When you temporarily turn off OpenLCR, long distance and international calls will not be routed by OpenLCR. However, your fax will still call OpenLCR periodically to receive rate data.

1 Press these keys:

FUNCTION



The display will show:

LCR DIAL SELECT

2 Press **2** (NO) to turn off OpenLCR.
(Press **1** (YES) to turn it back on.)



- When you turn off OpenLCR, the highlighted “C” in the display will change to “-”.

3 Press the **STOP** key to return to the date and time display.

STOP



To stop using OpenLCR

Press the following sequence of keys if you want to stop using the Open LCR feature.



- ◆ Calls will not be routed by OpenLCR and the fax machine will not call OpenLCR to update data.

To resume use of OpenLCR, press these keys:

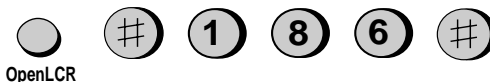

Changing your user profile

To call OpenLCR to change your user profile, follow these steps:

-
- 1** Pick up the handset on the fax machine.

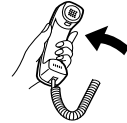

-
- 2** Press the **OpenLCR** key and then the **3** key.



-
- 3** If the display shows the alternating messages at right, press the number keys to enter your fax/phone number, including the area code (the number must be 10 digits long). When finished, press the **START/MEMORY** key.

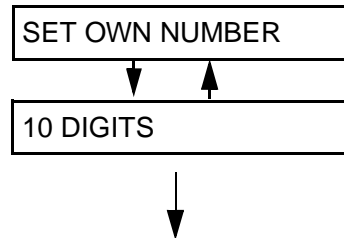

(Note: If the message at right doesn't appear, this step is not necessary.)

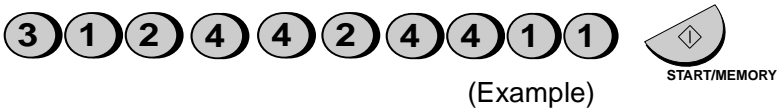

Important!

Be sure that you enter your correct area code and fax number. If not, your fax may not dial the correct number to connect to OpenLCR.

-
- 4** Follow the instructions you hear.

- ◆ **Note:** If you are on a pulse dial line, press the * key before pressing the number keys to respond. (This makes your fax temporarily issue tone signals when you press the number keys.)

What to do if “E” appears in the display

A highlighted “E” will appear in the display in place of “C” if the rate data in the fax is out-of-date and the fax is unable to obtain new data. When this happens, OpenLCR routing will not take place.

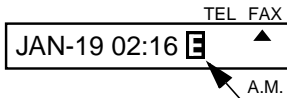

“E” indicates that the rate data is out-of-date.

This will only occur if the fax machine is unable for some reason to make its periodic call to OpenLCR to receive new rate data.

First try downloading the rate data manually by pressing the **OpenLCR** key and **2** key as explained in *Downloading (receiving) the rate data manually* on page 39. If this doesn't work, proceed to the following section, *What to do if you cannot connect to OpenLCR*.

What to do if you cannot connect to OpenLCR

If you are unable to connect to OpenLCR when you use the OpenLCR key to register or manually download data, it is likely that the phone number that the fax machine dials when you press the **OpenLCR** key is no longer correct.

To obtain the correct phone number, call OpenLCR at 970-206-1207, and then program the number into the fax machine as explained on the following page.

- ◆ **Note:** The number that you will obtain is the number for manually downloading rate data (dialed by pressing the **OpenLCR** key and **2**). When you manually download the rate data, the new numbers for registering (dialed by pressing the **OpenLCR** key and **1, 3, or 5**) will also be programmed in your fax machine.

1 Press these keys:

The display will show:

CENTER # MODE



2 Press **1** (SET) to set the new phone number.



- **Note:** If you want to restore the factory-set number, press **2** for CLEAR and then go to Step 4.

3 Press the number keys to enter the new phone number.

4 Press the **START/MEMORY** key to store the number.



5 Press the **STOP** key to return to the date and time display.



6 Press the **OpenLCR** key and **2** to download new rate data.



- If you have not yet registered with OpenLCR, your fax will receive new phone numbers that will allow you to connect to OpenLCR. Register using one of the procedures described at the beginning of this chapter.

Note: The following settings are not required as of the printing of this manual. OpenLCR will inform you through its Web site (www.OpenLCR.com) if the settings become necessary in the future.

Selecting a long or short call

Before you make a long distance or international phone/fax call, select whether the call will be a long call or a short call.

Your fax needs to know whether the call will be long or short to route it for the best rate.

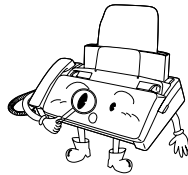

1 Press these keys:

The display will show:

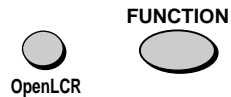
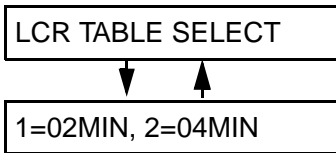

Note: If the display shows TABLE NOT EXIST, you must first download the rate data.

2 Press 1 to select the SHORT TIME setting, or 2 to select the LONG TIME setting.

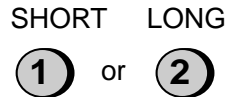

- The initial SHORT TIME setting is 2 minutes, and the initial LONG TIME setting is 4 minutes. If desired, you can change these settings as explained on the following page.
- The short/long time selection will remain in effect for all calls until you change it.

Changing the **SHORT TIME** and **LONG TIME** settings

The initial **SHORT TIME** setting is 2 minutes, and the initial **LONG TIME** setting is 4 minutes. If the typical durations of your short and long calls are different, you should change the time settings to ensure that OpenLCR routes your calls for the best rate.

- ◆ For example, if your fax transmissions normally last about 3 minutes and your phone calls last about 5 minutes, set **03** for the **SHORT TIME** and **05** for the **LONG TIME**. Before sending a fax, select the **SHORT TIME** setting (03MIN) in the procedure on the preceding page. Before making a phone call, select the **LONG TIME** setting (05MIN).
- ◆ When you change the **SHORT TIME** and/or **LONG TIME** setting, the fax machine will automatically call OpenLCR and receive rate data for the new times.

1 Press these keys:

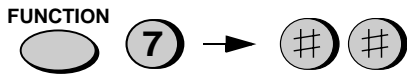

The display will show:

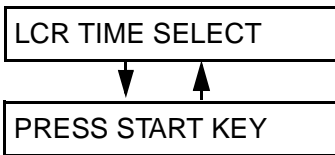

2 Press the **START/MEMORY** key.

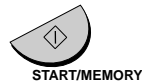

The display will show:

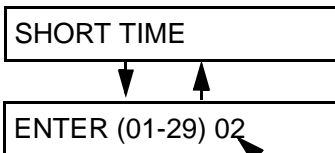

The current setting appears here.

- 3** Enter a 2-digit number (**01 to 29**) for the number of minutes of the **SHORT TIME** setting. (If the number is less than 10, enter a **0** before the number.) The display will show your selection and then show:



Example: 3 minutes

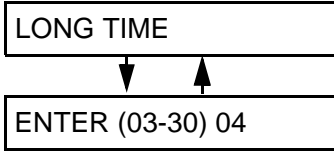

- 4** Enter a 2-digit number for the number of minutes of the **LONG TIME** setting. (The number must be greater than the **SHORT TIME** setting and no more than **30**.) The display will show your selection. If the settings were changed, it will then show:



Example: 5 minutes

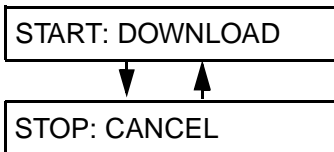

Note: If the display shows **NO SERVICE**, you must first download the rate data.

- 5** Press the **START/MEMORY** key to begin receiving the rate data for the new settings.

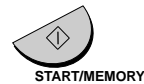

- Your fax calls OpenLCR and receives the data. This lasts one or two minutes.
- **Note:** If you do not press the **START/MEMORY** key to receive new data, the settings will revert to their previous state.

3. Sending Documents

Transmittable Documents

Size and weight

The size and weight of documents that you can load in the document feeder depend on whether you load one page at a time or several pages at once.

Loading one page at a time:

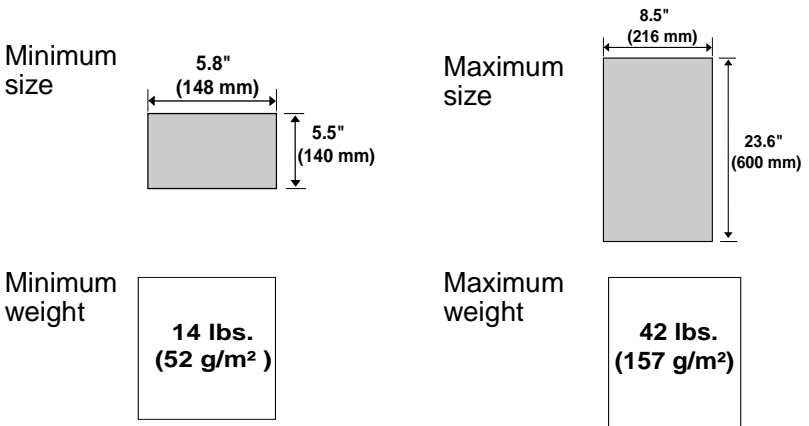

Loading several pages at once:

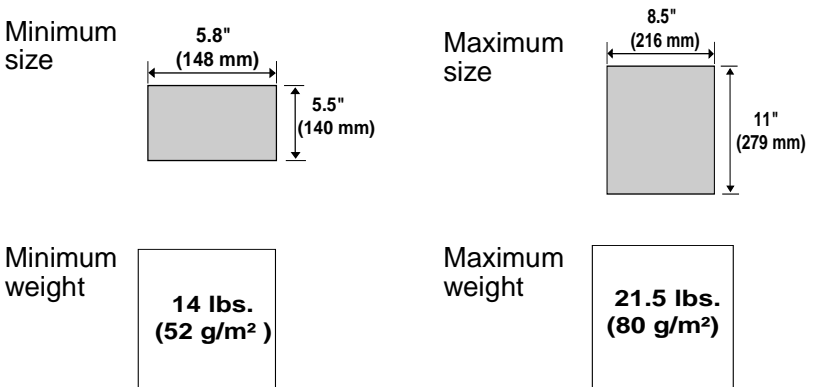

Note: Letters or graphics on the edges of a document will not be scanned.

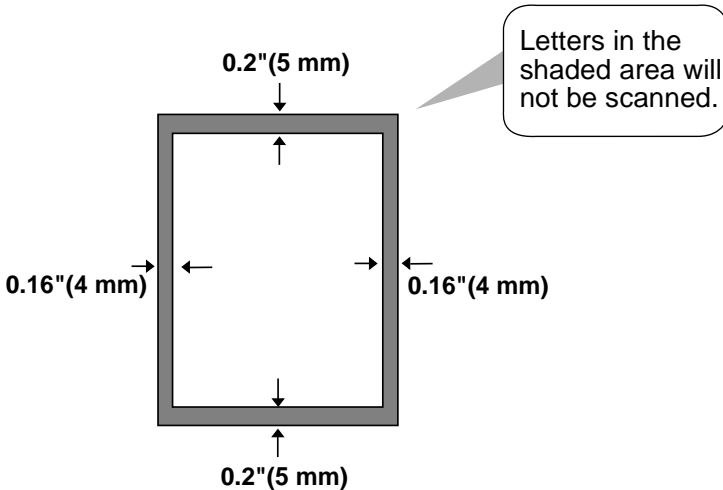

Other restrictions

- ◆ The scanner cannot recognize yellow, greenish yellow, or light blue ink.
- ◆ Ink, glue, and correcting fluid on documents must be dry before they pass through the document feeder.
- ◆ All clips, staples, and pins must be removed from documents before loading in the feeder. If these are not removed, they may damage the machine.
- ◆ Documents which are patched, taped, torn, smaller than the minimum size, carbon backed, easily smudged, or have a slippery coated surface should be photocopied, and the copy loaded in the feeder.

Loading the Document

Up to 10 pages can be placed in the feeder at one time. The pages will automatically feed into the machine starting from the bottom page.

- ◆ If you need to send or copy more than 10 pages, place the additional pages gently and carefully in the feeder just before the last page is scanned. Do not try to force them in, as this may cause double-feeding or jamming.
- ◆ If your document consists of several large or thick pages which must be loaded one at a time, insert each page into the feeder as the previous page is being scanned. Insert gently to prevent double-feeding.

-
- 1** Adjust the document guides to the width of your document.

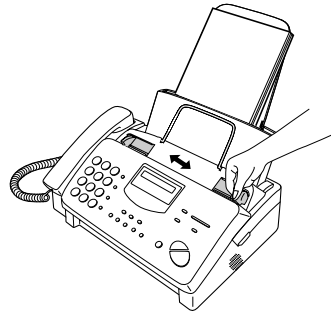

-
- 2** Place the document face down and push it gently into the document feeder. The top edge of the document should enter the machine first.

- The feeder will draw the leading edge of the document into the machine. The display will show:

READY TO SEND

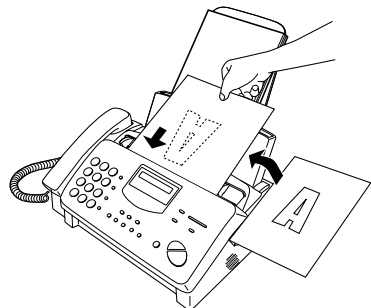

- Adjust the resolution and/or contrast settings (if desired) as explained in *Resolution and Contrast* on page 55, then dial the receiving machine as explained in *Sending a Fax by Normal Dialing* on page 58.



Removing a document from the feeder

If you need to remove a document from the feeder, open the operation panel.

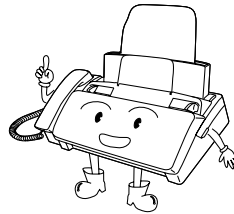

Important!

Do not try to remove a document without opening the operation panel. This may damage the feeder mechanism.

- Grasp the finger hold and pull up to open the operation panel.

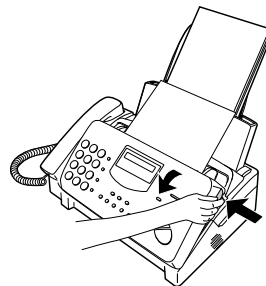

2 Remove the document.

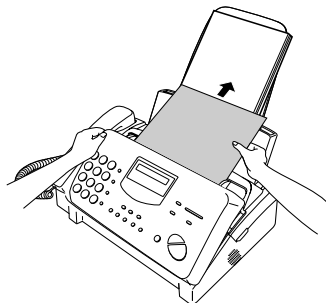

3 Close the operation panel, making sure it clicks into place.

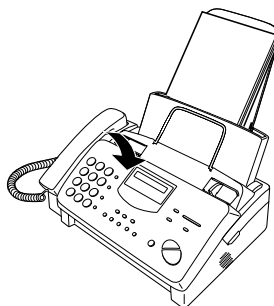

Adjusting the Resolution and Contrast

If desired, you can adjust the resolution and contrast before sending a document.

The default resolution setting is STANDARD and the default contrast setting is AUTO.

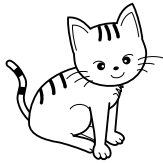

You must adjust the settings each time you don't want to use the default settings.

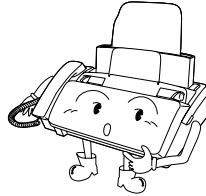

Note: The resolution and contrast settings are only effective for sending a document. They are not effective for receiving a document.

Resolution settings

STANDARD	Use STANDARD for ordinary documents. This setting gives you the fastest and most economical transmission.
FINE	Use FINE for documents containing small letters or fine drawings.
SUPER FINE	Use SUPER FINE for documents containing very small letters or very fine drawings.
HALF TONE	Use HALF TONE for photographs and illustrations. The original will be reproduced in 64 shades of gray.

Contrast settings

AUTO	Use AUTO for normal documents.
DARK	Use DARK for faint documents.

1 Load the document(s).

- The document must be loaded before the resolution and contrast can be adjusted.

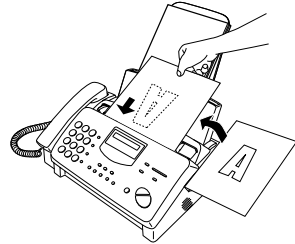

2 Press the **RESOLUTION** key one or more times until the desired resolution and contrast settings appear in the display.

- The first time you move through the list of resolution settings, the contrast setting AUTO will appear next to each resolution setting. The second time you move through the list, the contrast setting DARK will appear.

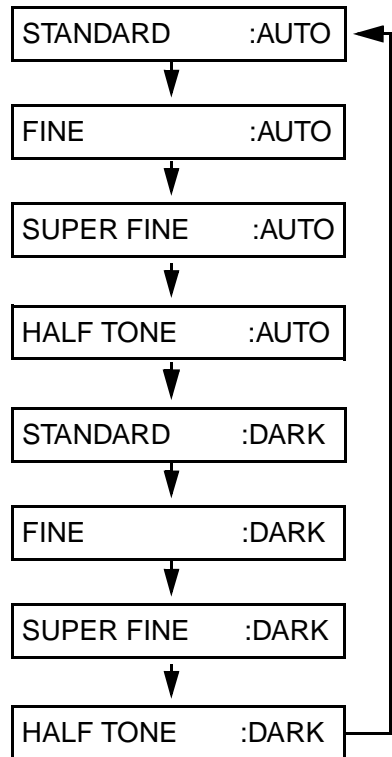

Note: In order to transmit in SUPER FINE resolution, the receiving fax machine must also have that resolution. If it doesn't, your machine will automatically step down to the next best available setting.

Changing the default resolution

If desired, you can change the default resolution for faxing documents to FINE. Follow the steps below.

- 1** Press these keys:

FUNCTION



The display will show:

FINE PRIORITY

- 2** Press **1** (YES) to set the default resolution to FINE, or **2** (NO) to set it to STANDARD.

YES



or

NO



- 3** Press the **STOP** key to return to the date and time display.

STOP



Sending a Fax by Normal Dialing

With Normal Dialing, you pick up the handset (or press the **SPEAKER** key) and dial by pressing the number keys.

- ◆ If a person answers, you can talk with them through the handset before sending the fax. (If you pressed the **SPEAKER** key, you must pick up the handset to talk.)
- ◆ Normal Dialing allows you to listen to the line and make sure the other fax machine is responding.

1 Load the document(s).

The display will show:

READY TO SEND

- Set the resolution and/or contrast if desired.

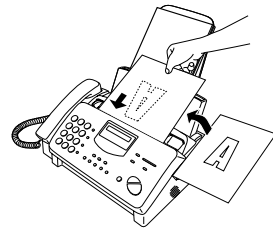

RECEPTION
MODE



2 Pick up the handset or press the **SPEAKER** key. Listen for the dial tone.

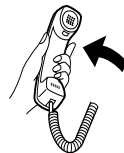

OR

SPEAKER



- 3** Dial the number of the receiving machine by pressing the number keys.



(Example)

- 4** Wait for the connection. Depending on the setting of the receiving machine, you will either hear a facsimile reception tone or the other person will answer.

- If the other party answers, ask them to press their Start key (if you pressed the **SPEAKER** key, pick up the handset to speak with them). This causes the receiving machine to issue a reception tone.



- 5** When you hear the reception tone, press the **START/MEMORY** key. Replace the handset if you used it.

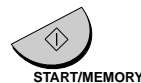

- When transmission is completed, the fax will beep once.

Using the **REDIAL** key

You can press the **REDIAL** key to redial the last number dialed. To send a document, press the **START/MEMORY** key when you hear the fax tone after the connection is established. Note that the speaker is automatically activated when you press the **REDIAL** key.

Sending a Fax by Automatic Dialing

You can dial a fax or telephone number by simply pressing a Rapid Key, or by pressing the **SPEED DIAL** key and entering a two-digit number.

- ◆ To use Automatic Dialing, you must first store the full fax or telephone number in your fax machine.
- ◆ When you store a fax or telephone number, you select a two-digit Speed Dial number for it. Forty-seven Speed Dial numbers are available.

Speed Dial numbers 01 through 07 are for Rapid Key (one-touch) Dialing.



Speed Dial numbers 08 through 47 are for dialing with the **SPEED DIAL** key.

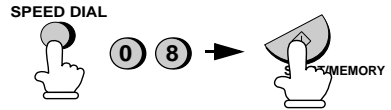

SPEED DIAL key

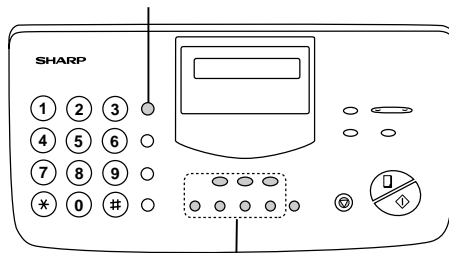

Attach the strips of Rapid Key labels above the Rapid Keys.

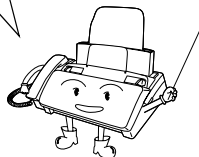

When you store a number in a Rapid Key, write the name of the party on the label.

Storing fax and telephone numbers for Automatic Dialing

1 Press these keys:

FUNCTION



The display will alternately show:

FAX/TEL # MODE



1=SET,2=CLEAR

2 Press the **1** key to select SET.



The display will alternately show:

FAX/TEL # SET



ENTER SPEED #

3 Enter a two-digit Speed Dial number by pressing the number keys (01 to 07 for Rapid Key Dialing, 08 to 47 for Speed Dialing).



(Example)

4 Enter the fax or voice number by pressing the number keys.
(Note: A space cannot be entered.)



(Example)

- To clear a mistake, press the **SPEED DIAL** key.
- ◆ If a pause is required between any of the digits to access a special service or an outside line, press the **REDIAL** key (two seconds per pause). The pause will appear as a hyphen. Several pauses can be entered in a row.

5 Press the **START/MEMORY** key.



6 Enter the name of the party by pressing the number keys as shown below. (If you don't want to enter a name, go directly to Step 7.)

SPACE = (1) (1)	J = (5) (5)	T = (8) (8)
A = (2) (2)	K = (5) (5) (5)	U = (8) (8) (8)
B = (2) (2) (2)	L = (5) (5) (5) (5)	V = (8) (8) (8) (8)
C = (2) (2) (2) (2)	M = (6) (6)	W = (9) (9)
D = (3) (3)	N = (6) (6) (6)	X = (9) (9) (9)
E = (3) (3) (3)	O = (6) (6) (6) (6)	Y = (9) (9) (9) (9)
F = (3) (3) (3) (3)	P = (7) (7)	Z = (9) (9) (9) (9) (9)
G = (4) (4)	Q = (7) (7) (7)	
H = (4) (4) (4)	R = (7) (7) (7) (7)	
I = (4) (4) (4) (4)	S = (7) (7) (7) (7) (7)	

Example: SHARP = 77777 444 22 7777 ^{SPEAKER} 77

- ◆ To clear a mistake, press the **SPEED DIAL** key.
- ◆ To enter two letters in succession that require the same key, press the **SPEAKER** key after entering the first letter.

7 Press the **START/MEMORY** key.



- 8** Return to Step 3 to store another number, or press the **STOP** key to return to the date and time display.

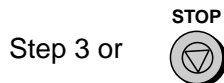

Chain Dialing for area and access codes

You can also store an area code or access code in a Rapid Key or Speed Dial number. To use this number to dial, see *Chain Dialing* on page 86.

Note: An area code or access code stored in a Rapid Key or Speed Dial number can only be used if the handset is lifted or the **SPEAKER** key is pressed before dialing.

Clearing auto-dial numbers

- 1** Press these keys:



The display will show:

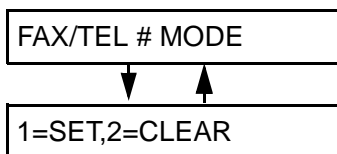

- 2** Press **2** to select CLEAR.



- 3** Enter the Speed Dial number that you want to clear by pressing the number keys.

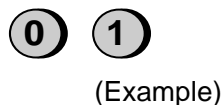

-
- 4** Press the **START/MEMORY** key.



-
- 5** Return to Step 3 to clear another number, or press the **STOP** key to return to the date and time display.

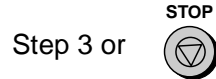

Making changes

To make changes in a number previously stored, repeat the programming procedure. Select the Rapid Key or Speed Dial number for which you want to make changes in Step 3, and then change the number and/or name when they appear in the display in Steps 4 and 6.

Note: The fax machine uses a lithium battery to keep automatic dialing numbers and other programmed data in memory when the power is turned off. Battery power is consumed primarily when the power is off. With the power kept continuously off, the life of the battery is about 5 years. If the battery dies, have your dealer or retailer replace it. Do not try to replace it yourself.

Rapid Key Dialing

If the number you want to dial has been stored for Automatic Dialing as a Speed Dial number from 01 to 07, you can dial it by pressing the corresponding Rapid Key.

1 Load the document(s).

The display will show:

READY TO SEND

- Set the resolution and/or contrast if desired.

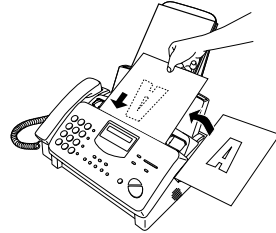

RESOLUTION



2 Press the Rapid Key corresponding to the desired Speed Dial number.

- The name of the receiving party will appear in the display. If no name was stored, the fax number will appear. (If the name or number is incorrect, press the **STOP** key.)
- The document will be automatically transmitted once the connection is established.



Example: To dial Speed Dial number 01, press Rapid Key 01.

Speed Dialing

Speed Dialing can be used to dial any number that has been stored for Automatic Dialing.

1 Load the document(s).

The display will show:

READY TO SEND

- Set the resolution and/or contrast if desired.

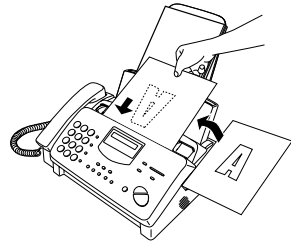

RESOLUTION



2 Press the **SPEED DIAL** key and then enter the Speed Dial number by pressing the numeric keys.

- To enter numbers 1 through 9, first enter 0 and then the number.

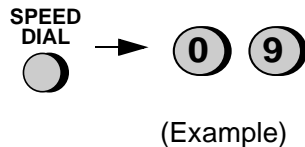

3 Check the display. If the name or number shown is correct, press the **START/MEMORY** key. (If not, press the **STOP** key and then repeat Step 2.)



Direct Keypad Dialing

You can also enter a full number with the number keys and then press the **START/MEMORY** key to begin dialing. You can use this method to dial a full number when you don't need to speak to the other party before faxing.

1 Load the document(s).

The display will show:

READY TO SEND

- Set the resolution and/or contrast if desired.

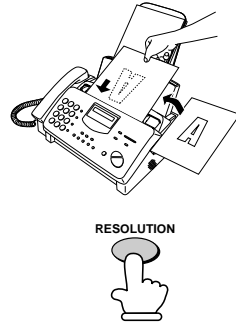

2 Enter the number of the receiving machine by pressing the numeric keys.



- If a pause is required between any of the digits to access a special service or an outside line, press the **REDIAL** key (two seconds per pause). The pause will appear as a hyphen. Several pauses can be entered in a row.

(Example)

3 Check the display. If the number of the receiving machine shown is correct, press the **START/MEMORY** key.

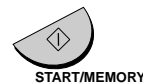

- If it is not correct, press the **STOP** key to backspace and clear one digit at a time, and then re-enter the correct digit(s).

Searching for an auto-dial number

If you don't remember the Rapid Key or Speed Dial number in which you have programmed a particular fax number, you can search for the number by following the steps below. Once you have found the number, you can dial and transmit the loaded document by simply pressing the **START/MEMORY** key.

1 Load the document(s).

The display will show:

READY TO SEND

- Set the resolution and/or contrast if desired.

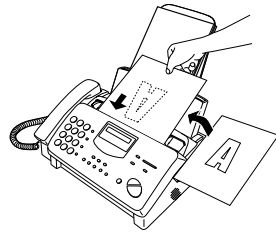

RESOLUTION



2 Press the **HOLD/SEARCH** key and then the **1** key.

**HOLD/
SEARCH**



3 Enter the first letter of the stored name by pressing the appropriate number key (the key below the marked letter) one or more times until the letter appears in the display. If the name begins with a special character or number, press **1**.

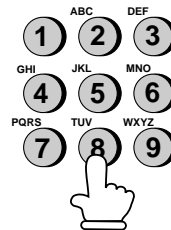

- ◆ If you don't remember the first letter, go to Step 4 (you will scroll through the list from the beginning).
- ◆ If a name wasn't stored for the number, press **0**. This will cause numbers, not names, to appear when you scroll.

4 Press the # key or the * key to scroll through the names (numbers if you pressed 0). Stop when the desired name appears in the display.

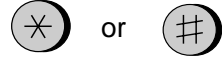

- If no names have been stored that begin with the entered letter, you will scroll from the next name, in alphabetical order, in the list. If no names/numbers have been stored at all, NO DATA will appear.

5 Press the **START/MEMORY** key. The document will be automatically transmitted once the connection is established.

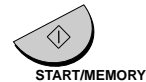

Automatic redialing

If you use automatic dialing (including Direct Keypad Dialing) and the line is busy, the fax machine will automatically redial the number. The fax machine will make up to two redialing attempts at an interval of five minutes.

- ◆ To stop automatic redialing, press the **STOP** key.

Recall Interval for automatic redialing

If desired, you can change the interval at which the fax machine makes automatic redialing attempts.

1 Press these keys:

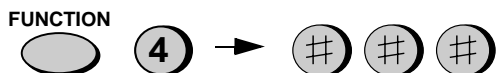

The display will show:

RECALL INTERVAL

-
- 2** Enter a 2-digit number from **01** to **15** for the number of minutes in the interval.



Example:
3 minutes

-
- 3** Press the **STOP** key to return to the date and time display.



Recall times for automatic dialing

If desired, you can change the maximum number of automatic redialing attempts made when the line is busy.

- ◆ Under certain conditions (for example if a person answers the call on a telephone), automatic redialing may stop before the set number of redialing attempts are made.

-
- 1** Press these keys:

FUNCTION



The display will show:

RECALL TIMES

-
- 2** Enter a 2-digit number from **00** to **10** for the maximum number of redial attempts.



Example:
5 attempts

-
- 3** Press the **STOP** key to return to the date and time display.



Error Correction Mode

The fax machine is set to automatically correct any distortions in a transmission due to noise on the telephone line before printing at the receiving end. This function is called Error Correction Mode (ECM). ECM is effective for both transmissions and receptions, and is only effective when the other fax machine has ECM as well.

If desired, you can turn ECM off. This will increase slightly the amount of memory available for memory transmission and reception.

- 1** Press these keys:



The display will show:

ECM MODE

- 2** Press **1** to turn on ECM or **2** to turn it off.

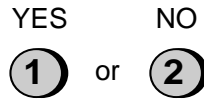

- 3** Press the **STOP** key to return to the date and time display.



4. Receiving Documents

Using FAX Mode

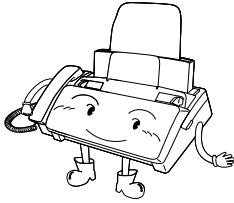

To select FAX mode, press the **RECEPTION MODE** key until the arrow in the display points to FAX.

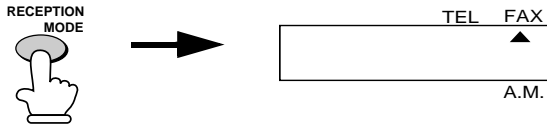

When the reception mode is set to FAX, the fax machine will automatically answer all calls on four rings and receive incoming faxes.

4 rings

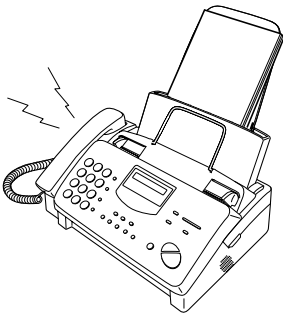

Fax reception



- ◆ If you pick up the handset before the machine answers, you can talk to the other party and/or receive a document as explained in *Using TEL mode* on page 74.

Changing the number of rings

If desired, you can change the number of rings on which the fax machine answers incoming calls in FAX mode. Any number from 2 to 5 can be selected.

- 1** Press these keys:

FUNCTION



The display will show:

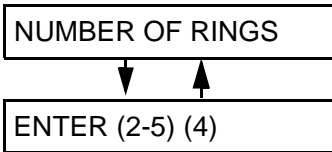

- 2** Enter the desired number of rings (any number from **2** to **5**).



The display will show:

Example: 3 rings



- 3** Press the **STOP** key to return to the date and time display.

STOP



Note: If you are using Distinctive Ring, the fax machine will answer calls after two rings regardless of the above setting.

Using TEL Mode



To select TEL mode, press the **RECEPTION MODE** key until the arrow in the display points to TEL.

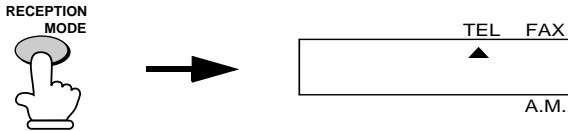

When the reception mode is set to TEL, you must answer all calls by picking up the fax machine's handset or an extension phone connected to the same line.

Answering with the fax's handset

- 1 When the fax machine rings, pick up the handset.

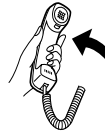

- 2 If you hear a fax tone, wait until the display shows RECEIVING and then replace the handset.

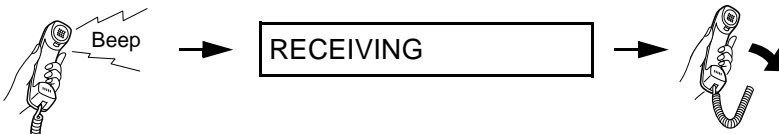

Note: If you have set the Fax Signal Receive setting to NO, press the **START/MEMORY** key to begin reception.

3 If the other party first speaks with you and then wants to send a fax, press the **START/MEMORY** key after speaking. (Press your **START/MEMORY** key before the sender presses their Start key.)

- When RECEIVING appears in the display, hang up.

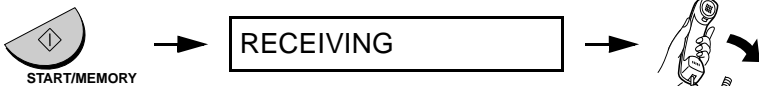

Answering with an extension phone

1 Answer the extension phone when it rings.

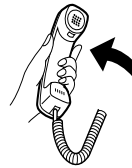

2 If you hear a soft fax tone, wait until your fax responds (the extension phone will go dead if it is connected to your fax, or you will hear pronounced, high-pitched tones if the phone is connected to a separate wall jack), then hang up.

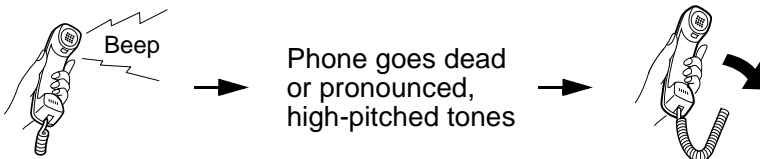

-
- 3** If the fax doesn't respond, or if the other party first talks to you and then wants to send a fax, press **5**, *****, and ***** on the extension phone (only on a tone dial phone). This signals the fax to begin reception. Hang up.

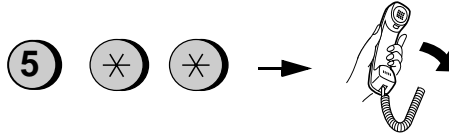

Comments:

- ◆ Your fax will not accept the signal to begin reception (**5****) if a document is loaded in its feeder.
- ◆ If you have set the Fax Signal Receive setting to NO, press **5**, *****, and ***** on the extension phone to begin reception.

Changing the number for remote fax activation

If desired, you can use a number other than **5** to activate fax reception from an extension telephone. You can select any number from **0** to **9**.

-
- 1** Press these keys:

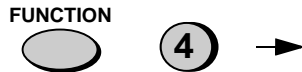

The display will show:



-
- 2** Press a number from **0** to **9** .



(Example)

-
- 3** Press the **STOP** key to return to the date and time display.

STOP



Turning off detection of the Tel/Fax Remote Number

If you don't intend to ever activate fax reception from an extension phone, you can turn off detection of the above Tel/Fax Remote Number. This will ensure that the fax never mistakenly attempts to begin reception if it detects a signal similar to the Tel/Fax Remote Number while you are talking on an extension phone.

-
- 1** Press these keys:

FUNCTION



The display will show:

REMOTE RECEPTION

-
- 2** Press **1** to turn on detection of the TEL/FAX REMOTE NUMBER, or **2** to turn it off.

YES



or

NO



-
- 3** Press the **STOP** key to return to the date and time display.

STOP



Fax Signal Receive

Your fax will automatically begin reception if you hear a soft fax tone after answering a call on your fax or an extension phone. If you use a computer fax modem to send documents on the same line, you must turn this function off in order to prevent your fax from mistakenly attempting to receive documents from the computer fax modem. Follow the steps below to change the setting.

1 Press these keys:

FUNCTION



The display will show:

FAX SIGNAL RX



2 Press **1** to turn on the function, or **2** to turn it off.

YES

NO



or



3 Press the **STOP** key to return to the date and time display.

STOP



2 in 1 Print

To save paper, you can have the size of your incoming faxes reduced by 55%. This will allow you to receive, for example, a 2-page document on one page (note that this may not be possible if the document pages are longer than your printing paper). To turn on this function, follow the steps below.

1 Press these keys:

FUNCTION



The display will show:

2 IN 1 PRINT

-
- 2** Press **1** to turn on the 2 IN 1 function, or **2** to turn it off. YES **1** or NO **2**

-
- 3** Press the **STOP** key to return to the date and time display. **STOP**

Reception Ratio

The fax has been set at the factory to automatically reduce the size of received documents to fit the size of the printing paper. This ensures that data on the edges of the document are not cut off. If desired, you can turn this function off and have received documents printed at full size.

- ◆ If a document is too long to fit on the printing paper, the remainder will be printed on a second page. In this case, the cut-off point may occur in the middle of a line.
- ◆ Automatic reduction may not be possible if the received document is too large, contains too many fine graphics or images, or is sent at high resolution. In this case, the remainder of the document will be printed on a second page.

-
- 1** Press these keys: **FUNCTION** **6** → **#** **#**

The display will show:

RECEPTION RATIO

-
- 2** Press **1** to turn on automatic reduction, or **2** to turn it off. AUTO **1** or 100% **2**

- If you selected AUTO, go to Step 3.
- If you selected 100%, go to Step 4.

-
- 3** If you selected AUTO, select the reception ratio to be used in the event that the memory becomes full (automatic reduction is not possible when the memory is full). Press **1** for 93% or **2** for 100%.

93% 100%
1 or **2**

-
- 4** Press the **STOP** key to return to the date and time display.



Substitute Reception to Memory

In situations where printing is not possible, such as when your fax runs out of paper, the imaging film needs replacement, or the paper jams, incoming faxes will be received to memory.

When you have received a document in memory, FAX RX IN MEMORY will appear in the display, alternating with OUT OF PAPER, FILM END, or PAPER JAM. When you add paper, replace the imaging film, or clear the jam, the stored documents will automatically print out.

- ◆ If you received documents in memory because the fax ran out of paper, be sure to add paper which is the same size as the paper previously used. If not, the document print-out size may not match the size of the printing paper.

Caution!

- ◆ When documents are stored in memory, do not turn the power off. This will erase all of the contents.
- ◆ If documents received in memory are lost due to a power failure or other interruption in the power supply, a CLEAR REPORT will be printed out when the power is restored. This gives information about the receptions lost, including the fax numbers of the transmitting machines if they are available.

5. Making Copies

- ◆ Your fax machine can also be used to make copies. Single and multiple copies (up to 99 per original) can be made, enabling your fax to double as a convenience office copier.

-
- 1 Load the document(s) face down.
(Maximum of 10 pages.)

The display will show:

READY TO SEND

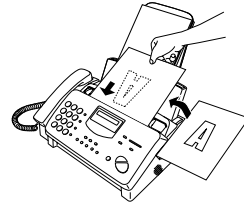

- Set the resolution and/or contrast if desired. (The default setting for copying is SUPER FINE.)

RECEPTION
MODE



-
- 2 Press the **COPY/HELP** key.

The display will show:

COPY MODE

START KEY: SINGLE

COPY KEY: MULTI

COPY/HELP



- ◆ If you are only making one copy of the original (or of each original) and don't want to make a reduction or enlargement setting, press the **START/MEMORY** key twice. Copying will begin.
- ◆ If you are only making one copy of the original (or of each original) and want to make an enlargement or reduction setting, press the **START/MEMORY** key and go to Step 5.

-
- 3** Press the **COPY** key (**MULTI**) if you want to make multiple copies of each original.

The display will show:

ENTER # (01-99)

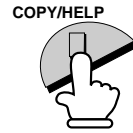

-
- 4** Enter the number of copies per original (if the number is less than 10, enter a "0" before the number).

The display will show:

COPY RATIO



Example: Three copies per original

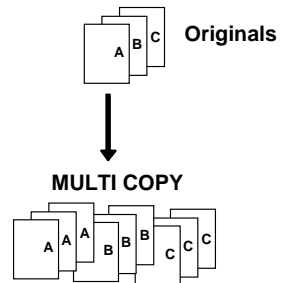

-
- 5** Set the amount of reduction or enlargement by entering a number from **1** to **4** as shown below, or press the **START/MEMORY** key to select 100%. Copying will begin.

2

Example: 50%

- 1:** AUTO (automatic size adjustment to match the size of the printing paper)
- 2:** 50%
- 3:** 125%
- 4:** 135%

Note:

If you place a large number of originals in the feeder, the memory may become full before all of them can be scanned (MEMORY IS FULL will appear in the display). If this happens, press the **START/MEMORY** key to copy the originals which have been scanned, and then repeat the copy procedure for the remaining originals, including the original which was being scanned when the memory became full.

Copy Cut-off

When making a copy of a document that is longer than the printing paper, use the copy cut-off setting to select whether the remaining part of the document will be cut off or printed on a second page. The initial setting is YES (cut off the remainder). To change the setting, follow the steps below.

-
- 1** Press these keys:

The display will show:

COPY CUT-OFF

FUNCTION



-
- 2** Press **1** to set copy cut-off to YES (the remaining part of the document will not be printed), or **2** to set copy cut-off to NO (the remaining part will be printed on a second page).

YES



or

NO



The display will show:

INITIALIZE FILM

-
- 3** Press the **STOP** key to return to the date and time display.

STOP



6. Making Telephone Calls

Your fax machine can be used like a regular telephone to make and receive voice calls.

- ◆ To make or receive a voice call, the power must be on.

-
- 1** Pick up the handset or press the **SPEAKER** key. Listen for the dial tone.

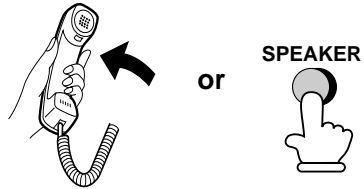

-
- 2** Dial the number using one of the following methods:

- **Normal Dialing:** Enter the full telephone number with the numeric keys.
- **Rapid Key Dialing:** Press the appropriate Rapid Key.
- **Speed Dialing:** Press the **SPEED DIAL** key, and enter the 2-digit Speed Dial number with the numeric keys.



Example: Press Rapid Key 01

-
- 3** Speak with the other party when they answer.

- If you pressed the **SPEAKER** key, pick up the handset to talk.



Comments:

- ◆ While the handset of the fax is lifted (off hook), an extension phone connected directly to the fax cannot be used to speak with the other party.
- ◆ The fax may interrupt a voice call received on an extension phone if the reception mode is set to A.M. and there is a period of silence during the conversation. If you are on a touch-tone phone, you can prevent this by pressing any three keys on the phone immediately after you answer. (Note: Do not enter the code to activate fax reception: 5, ✳ , ✳ .)

Chain Dialing

After lifting the handset, you can dial any combination of Normal Dialing, Rapid Key Dialing and Speed Dialing numbers. For example, if you have stored an area code or an access code for a special service in a Rapid Key, you can press the Rapid Key for that area code or access code, then dial the remainder of the number by pressing a Rapid Key, pressing number keys, or pressing the **SPEED DIAL** key and entering a two-digit Speed Dial number.

Searching for an auto-dial number

You can use the **HOLD/SEARCH** key to search for a Rapid Key or Speed Dial number. First search for the number as described in *Searching for an auto-dial number* on page 68, then pick up the handset or press the **SPEAKER** key. The number will be dialed automatically (do not press the **START/MEMORY** key).

Redial

The last number dialed can be redialed by pressing the **REDIAL** key (it is not necessary to pick up the handset or press the **SPEAKER** key). When the other party answers, pick up the handset to talk.

Hold

You can put the other party on hold during a conversation by pressing the **HOLD/SEARCH** key. When this is done, they cannot hear you. You can put the handset back in the cradle without breaking the connection. When you are ready to speak with them again, pick up the handset. If you did not put the handset back in the cradle, press the **HOLD/SEARCH** key again to resume conversation.

7. Answering Machine Hookup

Connecting an Answering Machine

If desired, you can connect an answering machine to your fax machine's **TEL. SET** jack. This will allow you to receive both voice messages and faxes when you are out.

-
- 1 Remove the seal covering the **TEL. SET** jack.

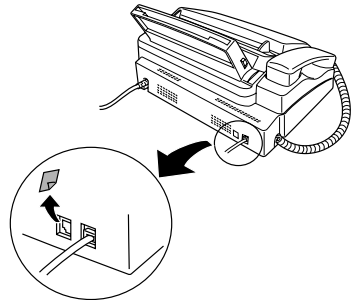

- 2 Connect the answering machine's telephone line jack to the **TEL. SET** jack.

- If desired, you can connect an extension phone to your answering machine's extension phone jack.

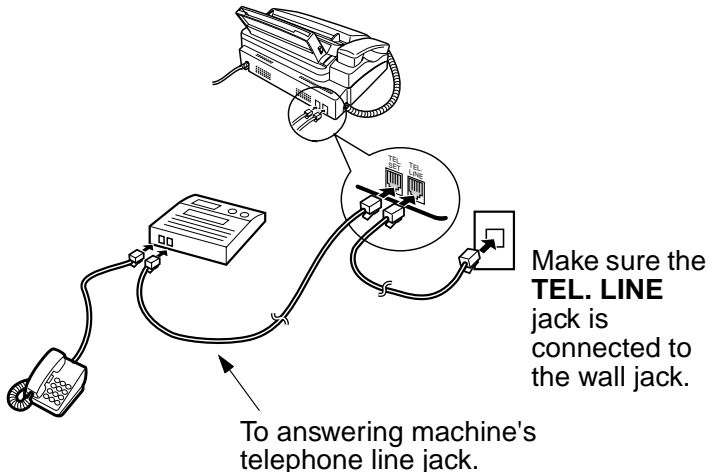

Changing the outgoing message

The outgoing message (OGM) of your answering machine should be changed to inform callers who want to send a fax to press their Start key. For example, your message might go as follows:

"Hello. You've reached the ABC company. No one is available to take your call right now. Please leave a message after the beep or press your facsimile Start key to send a fax. Thank you for calling."

- ◆ Try to keep the length of the message under 10 seconds. If it is too long, you may have difficulty receiving faxes sent by automatic dialing.
- ◆ If your outgoing message must be longer than 10 seconds, leave a pause of about four seconds at the beginning of the message. This will give your fax a chance to detect fax tones sent when automatic dialing is used.

Activating the answering machine connection

Before you go out, activate the answering machine connection as follows:

- 1 Set the reception mode to A.M.

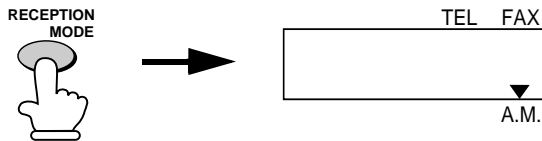

2 Set your answering machine to auto answer.

- ◆ Your answering machine must be set to answer on a maximum of two rings. If not, you may not be able to receive faxes sent by automatic dialing.
- ◆ If your answering machine has a toll saver function, make sure that it will answer by the fourth ring.

Note:

If your answering machine has a remote retrieval function, make sure the code used to activate remote retrieval is different from the code used to activate fax reception with an extension telephone (see page 76). If they are the same, entering the code from an outside telephone to retrieve messages will cause the fax machine to be activated.

How the connection operates

While you are out, all of your incoming calls will be answered by your answering machine and its outgoing message will play. Voice callers can leave a message. During this time, your fax will quietly monitor the line. If your fax detects a fax tone or a duration of silence greater than four seconds, it will take over the line and begin reception.

When you return and turn off your answering machine, be sure to change the reception mode back to FAX or TEL!

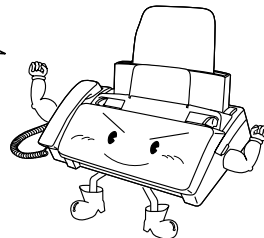

Optional A.M. Mode Settings

If necessary, you can use the following settings to improve the response of the answering machine hookup to incoming calls.

Quiet Detect Time

The fax machine is set to take over the line and begin reception if it detects 4 seconds of silence after the answering machine answers. If needed, you can change this setting to any number of seconds from 1 to 10.

- ◆ We recommend that you do not set Quiet Detect Time under 3 seconds.
- ◆ If the fax machine is interrupting callers before they can leave a message, try a longer Quiet Detect Time setting. If your outgoing message includes a period of silence, make sure that the setting is longer than that period of silence, or re-record your outgoing message to shorten the silence.

Note:

Quiet Detect Time can be turned off by entering "00" for the time. Note, however, that the fax machine may not be able to receive manually-sent faxes from some older fax machines.

1 Press these keys:

FUNCTION



The display will show:



QUIET DETECT TM.

2 Enter a number from **01** to **10**, or enter **00** to turn off the function.



(Example)

-
- 3** Press the **STOP** key to return to the date and time display.



Fax when Answering machine Fails

When this function is turned on, your fax will answer the call after 5 rings if the answering machine for some reason fails to answer before that time. This ensures that you will receive fax messages even if the answering machine's tape fills up or the answering machine is not turned on.

This function has been turned off at the factory. If you want to turn it on, follow the steps below:

Note:

When this function is turned on, make sure that the answering machine is set to answer on 4 rings or less. If it isn't, the fax will always answer first, preventing callers from leaving voice messages.

-
- 1** Press these keys:

FUNCTION

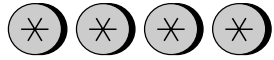

The display will show:



FAX RX TAD FAILS

-
- 2** Press **1** to turn on the function, or **2** to turn it off.

YES

NO



or



-
- 3** Press the **STOP** key to return to the date and time display.



8. Special Functions

Caller ID (Requires Subscription to Service)

If you subscribe to a caller identification service from your telephone company, you can set your fax machine to display the name and number of the caller while the fax rings.

Important:

- ◆ To use this function, you must subscribe to a caller identification service from your telephone company.
- ◆ Your fax may not be compatible with some caller identification services.

1 Press these keys:

FUNCTION



The display will show:

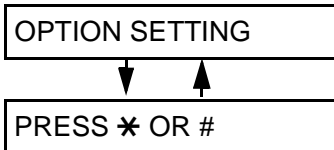

2 Press the * key three times.

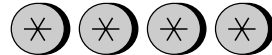

The display will show:

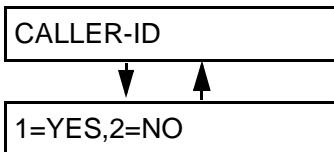

-
- 3** Press **1** to turn on Caller ID, or **2** to turn it off. (If you selected **2** (NO), go to Step 7.)

YES NO
1 or **2**

If you selected **1**, the display will show:

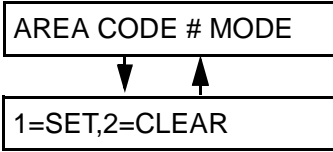

-
- 4** Press **1** to select SET. (To clear a previously programmed area code, press **2** and go to Step 7.)

1

The display will show:

ENTER AREA CODE

-
- 5** Enter the three digits of your area code.

4 **2** **5**

(Example)

-
- 6** Press the **START/MEMORY** key to store your area code.



The display will show:

COVER SHEET

-
- 7** Press the **STOP** key to return to the date and time display.



How Caller ID operates

When you receive a call, the name and phone number of the caller will alternately appear in the display, beginning just before the second ring. The information will continue to be displayed until the line is disconnected.

Note: Some caller ID services may not provide the name of the caller. In this case, only the phone number will appear.

Display example

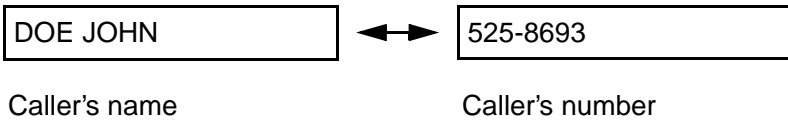

Display messages

One of the following messages will appear while the fax rings if caller information is not available.

NO SERVICE	No caller information was received from your telephone company. Make sure that the telephone company has activated your service.
CALLER-ID ERROR	Noise on the telephone line prevented reception of caller information.
OUT OF AREA	The call was made from an area which does not have a caller identification service, or the caller's service is not compatible with that of your local phone company.
PRIVATE CALL	Caller information was not provided by the telephone company at the caller's request.

Viewing the Caller ID list

If you subscribe to a Caller ID service and have turned on the Caller ID function, your fax machine will keep information on the most recent 20 calls and faxes you have received. You can view this information, which consists of the name and number of each caller, in the Caller ID List.

- ◆ After you have received 20 calls, each new call will delete the oldest call.

Follow the steps below to view the Caller ID List in the display. If desired, you can immediately dial a number when it appears.

1 Press these keys:

HOLD/
SEARCH



The display will show:

REVIEWING CALLS

2 Press the * key to scroll through the list from the most recent call, or the # key to scroll through the list from the oldest call.



or



3 If you want to dial one of the numbers in the list, scroll through the list until the number appears in the display.

- If you want to send a fax, load the document and then press the **START/MEMORY** key.

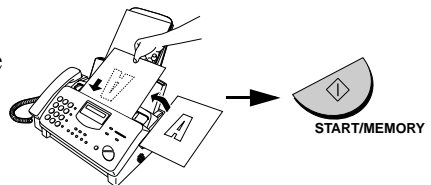

- If you want to make a voice call, pick up the handset or press the **SPEAKER** key. Dialing will begin automatically. (If you pressed the **SPEAKER** key, pick up the handset when the other party answers.)

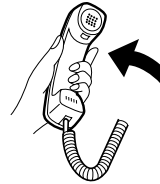

- 4** Press the **STOP** key when you have finished viewing the list.



To delete calls from the Caller ID list

If you want to delete a single call from the caller list, press the **0** key while the call appears in the display. If you want to delete all calls from the list, hold the **0** key down for at least 3 seconds while you are viewing any number in the list.

Priority Call

If desired, you can set your fax to make a special ringing sound when you receive a call from a designated phone number. This lets you know immediately who is calling without having to look at the display.

To use this function, enter the desired phone number by following the steps below (only one phone number can be entered).

- 1** Press these keys:



The display will show:



-
- 2** Press **1** to enter a number, or **2** to clear a number. (If you pressed **2**, go to Step 4.)

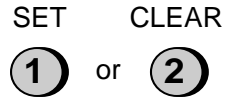

-
- 3** Enter the phone number, including the area code, by pressing the number keys (max. of 20 digits).



(Example)

-
- 4** Press the **START/MEMORY** key and then the **STOP** key.



Blocking voice calls

With Caller ID turned on, you can use the Anti Junk Fax function described in *Blocking Reception of Unwanted Faxes* in this chapter to block voice calls as well as fax receptions (the Anti Junk Fax function normally only blocks faxes).

In this case, when a voice call or a fax transmission comes in from a number you have specified as a "Junk Number", your fax will break the connection as soon as it receives the calling phone number from the caller ID service (before the second ring).

To use this function, turn on the Anti Junk function and then enter the number in the Anti Junk Number List as explained in *Blocking Reception of Unwanted Faxes* in this chapter (see page 108).

Note: This function cannot be used if you are using the Distinctive Ring function.

Distinctive Ring (Requires Subscription to Service)

Important:

- ◆ To use distinctive ring, you must subscribe to a distinctive ring service from your local phone company.
- ◆ Your fax machine may not be compatible with some distinctive ring services.

Distinctive ring is a service offered by some local telephone companies whereby they assign an additional second number to your regular single line. The second number rings differently from your normal number.

If you subscribe to a distinctive ring service, you can set the fax machine to automatically answer when your second number is called. This allows you to use the second number as an exclusive fax number.

To have your fax automatically answer when your second number is called, follow the steps below:

1 Press these keys:

FUNCTION



The display will show:

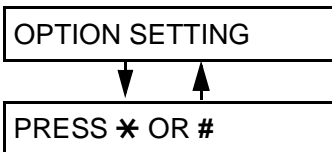

2 Press the * key seven times.

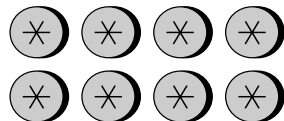

The display will show:

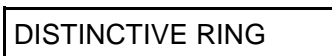

3 Press a number from **1** to **3** to select the ring pattern below that matches your second number's ring pattern. Or, press **4** to have your fax automatically answer your normal telephone number. Press **5** to turn off the distinctive ring function.

- | | | |
|----------|----------------|---|
| 1 | RING PATTERN 1 | Two short rings |
| 2 | RING PATTERN 2 | One short, one long, and one short ring |
| 3 | RING PATTERN 3 | Two short rings and one long ring |
| 4 | STANDARD RING | Your standard (normal) ring pattern |
| 5 | OFF SETTING | Turn distinctive ring off |

The display will show:

FAX SIGNAL RX

4 Press the **STOP** key to return to the date and time display.



5 Set the reception mode to FAX.

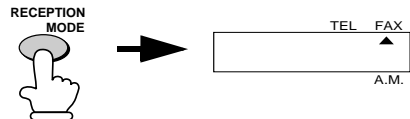

- ◆ When using distinctive ring, you must set the reception mode of your fax machine to FAX. When your designated fax number is dialed, your fax will automatically answer and begin reception after two rings. Note that other devices on the same line will also ring until your fax answers. If one of your other numbers is dialed, the fax will ring; however, it will not answer.

Broadcasting

This function allows you to send the same document to as many as 20 different locations with just one operation. First store the document in memory, then enter the numbers of the receiving machines. The document will be transmitted to each location.

- ◆ You can only use Rapid Keys or Speed Dial numbers to dial the numbers of the receiving machines.

1 Load the document(s).

The display will show:

READY TO SEND

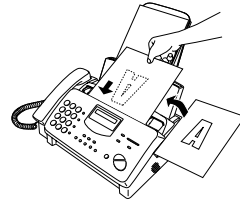

2 Press the **START/MEMORY** key and then 2.



3 Dial the receiving machines (maximum of 20) using one or both of the following methods:

- Enter one or more Speed Dial numbers by pressing the number keys.
- Press one or more Rapid Keys.

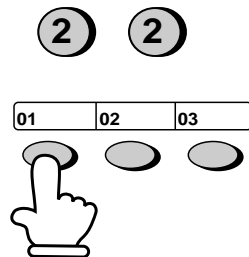

4 Press the **START/MEMORY** key.

- Set the resolution and/or contrast if desired.

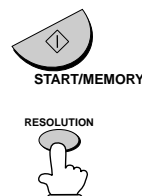

5 Press the **START/MEMORY** key.
Transmission will begin.



- A Transaction Report is automatically printed out after Broadcasting is completed. Check the "Note" column of the report to see if any of the locations are marked "Busy" or have a communication error code. If so, send the document to those locations again.

Cover Sheet

You can have the fax generate a cover sheet and send it as the last page of each of your fax transmissions.

You can select a message.

```

URGENT

  AUTOMATIC COVER SHEET

DATE : JUN-05-2000 03:39 PM
TO   : BBC CORP.
FAX # : 829658742
FROM : ABC CORP.
FAX # : 529658742

   2 PAGES WERE SENT
(INCLUDING THIS COVER SHEET)
  
```

For the recipient's name to appear, you must dial using a Speed Dial or Rapid Key number with the name programmed.

Your name and number must be programmed as explained on page 25.

Follow the steps below to turn on the cover sheet function. Once the cover sheet function is turned on, cover sheets will be included with all transmissions until you turn it off.

1 Press these keys:

FUNCTION



The display will show:

OPTION SETTING

2 Press these keys:



The display will show:

COVER SHEET

-
- 3** Press **1** (YES) to turn on the cover sheet function, or **2** (NO) to turn it off.

YES NO
1 or **2**

The display will show:

AUTO PRINT OUT

-
- 4** Press the **STOP** key to return to the date and time display.



Selecting a header message (optional)

When the cover sheet function is turned on, you can also select a message which will appear as a header at the top of the cover sheet. Note that the message selection is only effective for one transmission.

-
- 1** Load the document(s).
- The document must be loaded before a message can be selected.
 - The cover sheet function must be turned on.

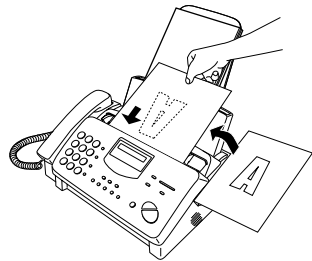

-
- 2** Press these keys:

The display will show:

FUNCTION **5**

COVER SHEET HEAD

-
- 3** Select a message by entering a number from **1** to **4**:

1

(Example)

- 1:** URGENT
- 2:** IMPORTANT
- 3:** CONFIDENTIAL
- 4:** PLS. DISTRIBUTE

-
- 4** Dial the receiving machine and transmit the document.

Note:

To cancel a cover sheet header setting, press the **STOP** key or remove the document from the feeder.

Batch Page Numbering

You can change the page numbering of the transmitted document from simple numbering ("P.01", "P.02", etc.) to batch numbering, which means that a slash and the total number of pages being sent are added after each page number (for example, "P. 01/05", "P.02/05", etc.). This allows the receiver to check for missing pages.

1 Load the document(s).

- The document must be loaded before batch page numbering can be set.

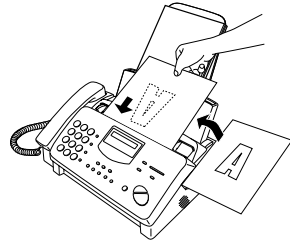

2 Press these keys:

The display will show:

PAGE COUNTER SET

FUNCTION



3 Enter the total number of pages ("01" to "99") by pressing the number keys.

- If you are sending a cover sheet, **do not** include it in the total number of pages (the number will be adjusted automatically).



Example:
Eight pages

4 Dial the receiving machine and transmit the document.

Comments:

- ◆ If you need to cancel a batch number entry, remove the document from the feeder or press the **STOP** key.
- ◆ If the number of pages actually transmitted does not coincide with the batch number entered, the alarm will sound and PAGE COUNT ERROR will appear in the display. PAGE E. will also appear in the NOTE column of the Transaction Report if it has been set to print out.

Blocking Reception of Unwanted Faxes

The Anti Junk Fax function allows you to block reception of faxes from parties which you specify. This saves paper by not printing out unwanted "junk" faxes.

To use this function, follow the steps below to turn it on, and then enter the fax numbers from which you do not want to receive faxes as indicated in the procedure that follows.

1 Press these keys:

FUNCTION

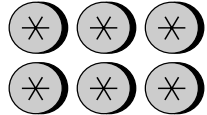

The display will show:

JUNK # CHECK

2 Press **1** to turn on the Anti Junk function, or **2** to turn it off.

YES

NO



or



3 Press the **STOP** key to return to the date and time display.

STOP



Entering Anti Junk numbers

Enter (or clear) a number in the Anti Junk List as shown below. Up to five numbers can be entered.

- ◆ To clear a number from the Anti Junk Number List, you need to know the 1-digit number which identifies it. If you have forgotten this number, print out the Anti Junk Number List as explained on page 119.

1 Press these keys:

The display will show:

STORE JUNK #

FUNCTION



3



2 Press **1** to enter a number in the Anti Junk Number List, or **2** to clear a number from the list.

SET

CLEAR

1

or

2

3 **Entering:** Enter a 1-digit number from **1** to **5** with the numeric keys. This number identifies the fax number that you will enter in the next step.

1

(Example)

Clearing: Enter the 1-digit number that identifies the fax number you want to clear, and go to Step 5.

4 Enter the fax number.

2 3 2 4 5 6 7

(Example)

5 Press the **START/MEMORY** key.



START/MEMORY

6 Return to Step 3 to enter (or clear) another fax number, or press the **STOP** key to return to the date and time display.

Step 3 or



Sending Documents From Memory

With this function, the original document is scanned immediately, stored in memory, and then transmitted once the connection to the receiving machine is made. This is convenient when transmitting to places where the line is often busy, as it saves you from waiting to pick up the original document and frees the feeder for other operations. After transmission, the document will be cleared from memory.

- ◆ Only one memory transmission can be set at a time.
- ◆ The amount of memory currently occupied appears as a percentage in the display while the document is being scanned.

1 Load the document(s).

The display will show:

READY TO SEND

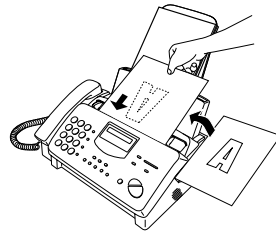

- Set the resolution and/or contrast if desired.



2 Press the **START/MEMORY** key and then **1**.

The display will show:

ENTER STATION #



- 3** Enter the number of the receiving machine using one of the following methods:

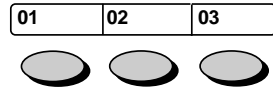

(Example)

- Press a Rapid Key.
- Press the **SPEED DIAL** key and enter a Speed Dial number.
- Enter a full telephone number by pressing the number keys.

- 4** Press the **START/MEMORY** key if you entered a Speed Dial number or a full number.

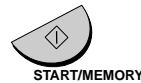

- The document will be scanned and stored in memory. Your fax will then dial the receiving machine and transmit the document (redialing will take place automatically if necessary).

If the memory becomes full...

If the memory becomes full while the document is being scanned, MEMORY IS FULL will appear in the display.

- ◆ Press the **START/MEMORY** key if you want to transmit the pages which have been stored up to that point in memory. The remaining pages will be ejected from the feeder. After transmission, the memory will be cleared and you can transmit the remaining pages. You will also need to transmit the page which was being scanned when the memory filled up.
- ◆ Press the **STOP** key if you want to cancel the entire transmission.

Polling (Requesting a Fax Transmission)

Polling allows you to call another fax machine and have it send a document (previously loaded in its feeder) to your machine without operator assistance. In other words, the receiving fax machine, not the transmitting fax machine, initiates the transmission.

To use the polling function, you must first set Rapid Key 07/POLL for use as a polling key.

- ◆ When Rapid Key 07/POLL is set as a polling key, it cannot be used for Rapid Key dialing.

1 Press these keys:

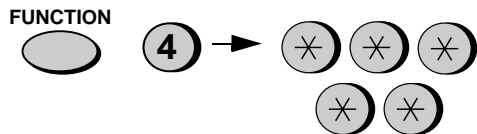

The display will show:

POLLING

2 Press **1** to turn on the function, or **2** to turn it off.

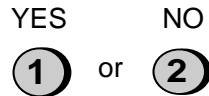

3 Press the **STOP** key to return to the date and time display.



Requesting transmission

Note: Rapid Dial Keys cannot be used for polling. To dial a Rapid Dial location, press the **SPEED DIAL** key and then enter the 2-digit number corresponding to the Rapid Key.

1 Dial the fax machine you want to poll using one of the following methods:

- Pick up the handset (or press the **SPEAKER** key) and dial the full number. Wait for the fax answerback tone.
- Press the **SPEED DIAL** key and enter a 2-digit Speed Dial number.
- Enter the full number using the numeric keys.

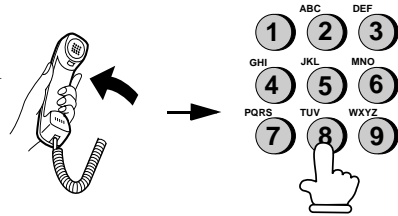

(Example)

2 Press Rapid Key 07/POLL.

- If you used the handset, replace it when POLLING appears in the display. Reception will begin.

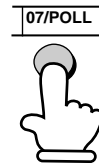

Being polled (polling standby)

To let another fax machine poll your fax, press the **RECEPTION MODE** key to set the reception mode to FAX and load the document(s).

Transmission will take place when the other fax machine calls your machine and activates polling. Automatic reception is possible while your fax is on polling standby.

Polling security

Polling Security allows you to prevent unauthorized polling of your machine. When this function is turned on, polling will only take place when the fax number of the polling fax machine has been entered in your machine's list of permitted fax numbers (called "passcode numbers"). The number of the polling fax must also be correctly programmed into itself for identification.

To use Polling Security, follow the steps below to turn the function on, and then enter permitted numbers as shown on the following page.

1 Press these keys:

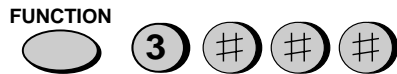

The display will show:



2 Press **1** to turn polling security on, or **2** to turn it off.

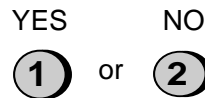

3 Press the **START/MEMORY** key and then the **STOP** key.



Storing and clearing fax numbers for polling permission

You can store up to 10 fax numbers in your machine's list of permitted numbers.

1 Press these keys:

FUNCTION



The display will show:

PASSCODE # MODE

2 Press **1** to store a number, or **2** to clear a number.

SET

CLEAR



or



3 Storing: Enter a 2-digit number from 01 to 10. This number identifies the fax number you will store in the next step.

Clearing: Enter the number which identifies the fax number you want to clear, and go to Step 5.



(Example)

4 Enter the fax number.



(Example)

5 Press the **START/MEMORY** key.



START/MEMORY

6 Return to Step 3 to enter (or clear) another number, or press **STOP** to return to the date and time display.

Step 3 or

STOP



Timer Operations

The Timer function allows you to set a transmission and/or polling operation to be performed automatically at a time you specify. One transmission operation and one polling operation can be set at any one time, and the times they will be performed can be specified up to 24 hours in advance.

- ◆ You can use this function to take advantage of lower off-peak telephone rates without having to be there when the operation is performed.

Note: Only a Speed Dial number can be used to dial the receiving machine.

Setting a timer operation

- 1** Press these keys:

FUNCTION



The display will show:

TIMER MODE

- 2** Press # to set a transmission operation (SEND MODE), or * to set a polling operation (POLLING MODE).

SEND



or

POLLING



- 3** Press 1 to select SET.



- 4** Enter the time at which you want the operation to take place (2 digits for the hour and 2 digits for the minute).



Example: 9:25

- 5** Press the * key to select A.M. or the # key to select P.M.

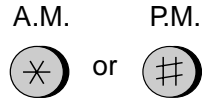

- 6** Press the **START/MEMORY** key.



- 7** Enter the Speed Dial number of the receiving fax machine.



- If this is a polling operation, go to Step 10.

(Example)

- 8** Press the **START/MEMORY** key.



- 9** Adjust the resolution and/or contrast if desired (skip to the next step if you don't want to change settings).



- 10** Press the **START/MEMORY** key and then the **STOP** key. If this is a transmission operation, load the document in the feeder sometime before the specified time of transmission.



To cancel a timer operation

If you need to cancel a timer operation after it has been set, follow the steps below.

1 Press these keys:

FUNCTION



The display will show:

TIMER MODE

2 Press # to cancel a transmission operation, or * to cancel a polling operation.

SEND



or

POLLING



3 Press 2 to select CLEAR.



4 Press the **START/MEMORY** key and then the **STOP** key.



START/MEMORY

STOP



9. Printing Lists

You can print lists showing settings and information entered in the fax machine. You can also print out reports on recent activity and individual operations after they are completed. The lists and reports are described on the following pages.

To print a list, follow the steps below.

- 1** Press the **FUNCTION** key and **2**.

FUNCTION



The display will show:

LISTING MODE

- 2** Press the ***** key or the **#** key until the desired list appears in the display.



or



- 3** Press the **START/MEMORY** key to print the list.



START/MEMORY

Activity Report

This report shows information on your most recently performed send and receive operations (a combined maximum of 30 operations can appear). The report is divided into two parts: the **TRANSMISSIONS ACTIVITY REPORT**, which shows information on transmissions, and the **RECEPTIONS ACTIVITY REPORT**, which shows information on receptions.

- ◆ All information is erased after a report is printed out. If automatic print-out is turned off and the report is not printed manually for 30 operations, the information on the oldest operation will be overwritten each time a new operation is performed.

```

*****
*
*
*          TRANSMISSIONS ACTIVITY REPORT
*
*          JUN-05-2000 03:51 PM
*
*          FOR: Johe Doe Corp.          201 555 1234
*
*-----*
*NO.  DATE   START   RECEIVER          TX TIME  PAGES  TYPE          NOTE
*-----*
* 1  JUN-05 03:34 PM  N.Y.           41"     1  SEND          OK
* 2  JUN-05 03:35 PM                   1'21"   2  BROADCAST
* 3  JUN-05 03:38 PM  JACK SMITH     58"     2  SEND(M)      OK
* 4  JUN-05 03:45 PM  JACK SMITH     40"     1  TIMER SEND   OK
*-----*
*
*          TOTAL          3'41"    6
*
*          GRAND TOTAL TIME:      4M 21S
*          PAGES:                  7
*
*****
    
```

Explanation of headings

SENDER/RECEIVER The name or fax number of the other machine involved in the transaction. If that machine does not have an ID function, the communication mode will appear (for example, "G3").

START The time at which transmission/reception started.

TX/RX TIME Total time taken for transmission/reception.

PAGES Number of pages transmitted/received.

NOTE (One of the following notes will appear under **NOTE** in the report to indicate whether the transaction was successful, and if not, the reason for the failure.)

OK - Transmission/reception was successful.

P.FAIL - A power failure prevented the transaction.

JAM - The printing paper or document jammed, preventing the transaction.

NO PAPER - You ran out of paper during reception.

BUSY - The fax was not sent because the line was busy.

COM.E-0 to COM.E-7 - A telephone line error prevented the transaction. See *Line Error* on page 130.

CANCEL - The transaction was cancelled because the **STOP** key was pressed, no document was in the feeder, or the other machine requested transmission using a function which your fax machine does not have. If you were attempting to fax, make sure a document is in the feeder. If you were receiving, contact the faxing party to see how they are trying to send to you.

If desired, you can set the Activity Report to automatically print out whenever information on 30 operations has accumulated. (A report can still be printed on demand at any time.) Follow the steps below:

1 Press these keys:

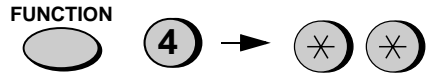

The display will show:



2 Press **1** to turn on automatic print-out, or **2** to turn it off.

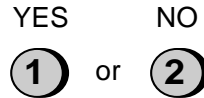

3 Press the **STOP** key to return to the date and time display.



Timer List

This list shows the timer operations that are currently set.

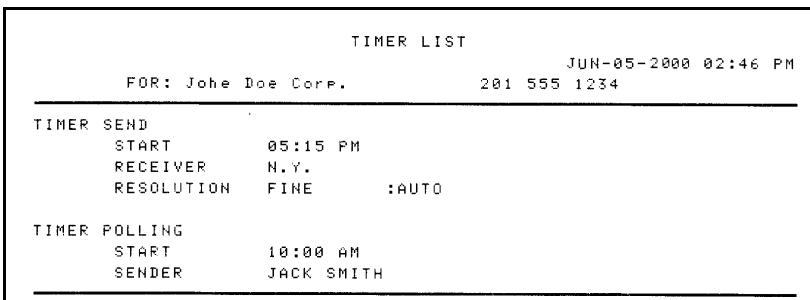

Telephone Number List

This list shows the fax numbers that have been programmed for automatic dialing.

TELEPHONE NUMBER LIST		
FOR: Johe Doe Corp.		JUN-05-2000 02:41 PM
		201 555 1234
SPEED #	NAME	TELEPHONE #
01	N.Y.	123-785-6340
02	JACK SMITH	125-563-8462
03	ANDERSON	230-347-6385
04	JANE	812-937-0142
05	MACDONALD	370-552-2836

Passcode List

This list shows settings made for polling security, your name and fax/telephone number as entered in the machine, a sample of the header printed at the top of every page you transmit (**HEADER PRINT**), and settings related to OpenLCR.

PASSCODE LIST	
FOR: Johe Doe Corp.	
JUN-05-2000 11:24 AM	
POLLING MODE	SECURITY OFF
PASSCODE #	01
	02
	03
	04
	05
	06
	07
	08
	09
	10
PRIORITY CALL #	
DAY LIGHT SAVING TIME	NO
SENDER'S NAME	
SENDER'S TELEPHONE NUMBER	
HEADER PRINT	
JUN-05-2000 11:24 AM	P.01
LCR FUNCTION ON/OFF	ON
(#186#/#184#)	
LCR DIAL SELECT	YES
LCR TIME SELECT	02,04 MINUTES
LCR TABLE SELECT	TABLE NOT EXIST
CENTER #	19703772160

Option Setting List

This list shows the current status of the option settings.

OPTIONS SETTING LIST		
FOR: AL		JUN-05-2000 06:02 PM
		123 3536
NO.	ITEM	SETTING
1	FINE PRIORITY	NO
2	NUMBER OF RINGS IN AUTO ANSWER MODE	4 RINGS
3	RECALL INTERVAL	05 MINUTES
4	RECALL TIMES	02 TIMES
5	TEL/FAX REMOTE #	(5)**
6	REMOTE RECEPTION	YES
7	TRANSACTION PRINT SELECT	ERROR ONLY
8	DIAL MODE	TONE
9	QUIET DETECT TIME	04 SECONDS
10	FAX ANSWER WHEN TAD FAILS	NO
11	DISTINCTIVE RINGING	OFF
12	FAX SIGNAL RECEIVE	YES
13	JUNK # CHECK	NO
14	POLLING	NO
15	CALLER-ID	YES
16	COVER SHEET	YES
17	AUTO PRINT OUT	NO
18	ECM MODE	YES

Anti Junk Number List

This list shows the numbers that are blocked by the Anti Junk function.

ANTI JUNK NUMBER LIST	
JUN-05-2000 02:50 PM	
ANTI JUNK # CHECK : NO	
STORED LOCATION	JUNK FAX #
1	2015546621
2	2014573321
3	1023570251

Caller ID List

This list shows information about your 20 most recent calls. (This list is only available if you are using the Caller ID function.)

CALLER-ID LIST					
AREA CODE: 123			JUN-05-2000 03:20 PM		
FOR: John Doe Corp.			201 555 1234		
NO.	DATE	RX TIME	NAME	TELEPHONE #	MODE
01	JUN-05	03:10 PM	ANDERSON ALLEN	201-556-8267	FAX
02	JUN-05	03:11 PM	MACDONALD MIKE	102-872-6621	FAX
03	JUN-05	03:11 PM	SMITH SHARON	202-441-3900	A.M.
04	JUN-05	03:12 PM	JONES JENNIFER	963-4451	TEL

Print Setup List

This list shows the current status of the printing settings accessed by pressing the **FUNCTION** key and the **6** key.

PRINT SET UP LIST		
FOR:		JUN-05-2000 09:36 AM
NO.	ITEM	SETTING
1	INITIALIZE FILM	FEB-01-1999
2-1)	RECEPTION RATIO	AUTO
2-2)	PRINTING RATIO IN MEMORY FULL	93%
3	2 IN 1 PRINT	NO
4	PRINT CONTRAST	NORMAL
5	PAPER SIZE SET	LETTER
6	COPY CUT OFF	YES

Transaction Report

This report is printed out automatically after an operation is completed to allow you to check the result. Your fax machine is set at the factory to print out the report only when an error occurs.

- ◆ The same headings appear in the Transaction Report as in the Activity Report. See page 120 for an explanation of the headings.
- ◆ The Transaction report cannot be printed on demand.

If desired, you can change the condition under which a report is printed out. Follow the steps below.

1 Press these keys:

FUNCTION



The display will show:



2 Press a number from **1** to **5** to select the condition for printing.

- | | | |
|----------|---------------|--|
| 1 | ALWAYS PRINT | A report will be printed after each transmission, reception, or error. |
| 2 | ERR/TIMER/MEM | A report will be printed after an error, timer operation, or memory operation. |
| 3 | SEND ONLY | A report will be printed after each transmission. |
| 4 | NEVER PRINT | A report will never be printed. |
| 5 | ERROR ONLY | A report will be printed only when an error occurs. |

3 Press the **STOP** key to return to the date and time display.



10. Maintenance

Print head

Clean the print head frequently to assure optimum printing performance.

- 1** Unplug the power cord.

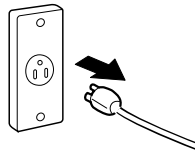

- 2** Pull the paper release plate forward and remove the paper.

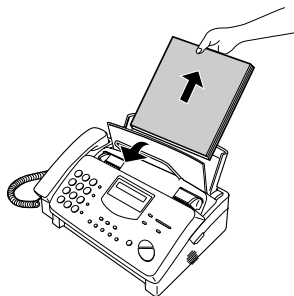

- 3** Open the operation panel (grasp the finger hold and pull up), and then pull the release on the right side of the machine forward to open the print compartment cover.

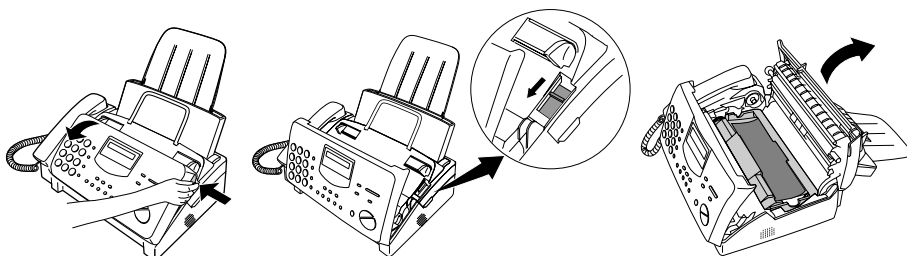

-
- 4** Take the imaging film cartridge out of the print compartment and place it on a sheet of paper.

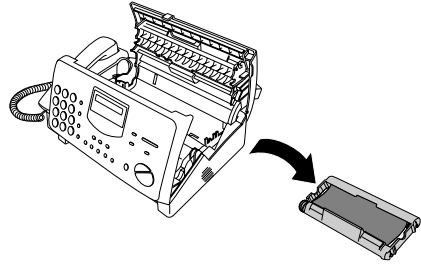

-
- 5** Wipe the print head and roller with denatured alcohol.

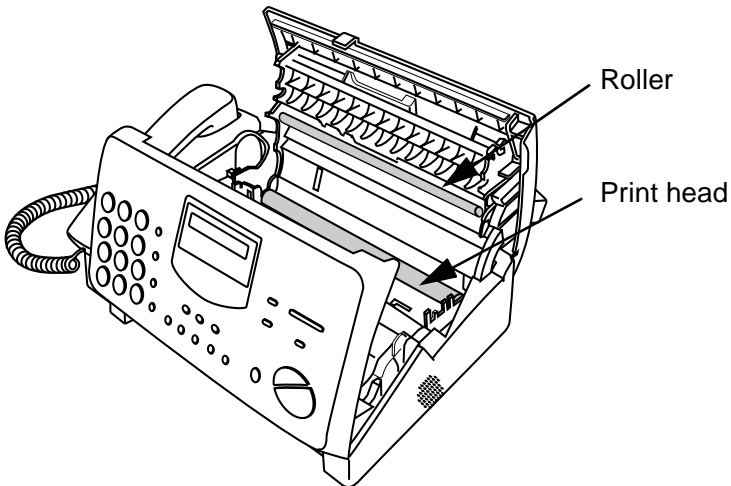

Caution!

- ◆ Do not use benzene or thinner. Avoid touching the print head with hard objects.
- ◆ The print head may be hot if your fax machine has just received a large number of documents. If this is the case, allow the print head to cool prior to cleaning.

-
- 6** Place the imaging film cartridge back in the print compartment.

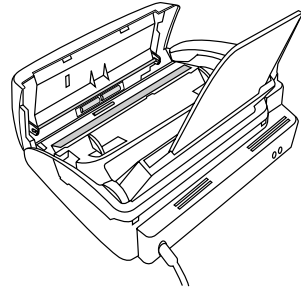

-
- 7** Close the print compartment cover (press down on both sides to make sure it clicks into place), and then close the operation panel.

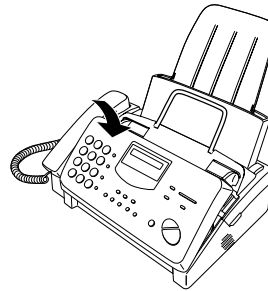
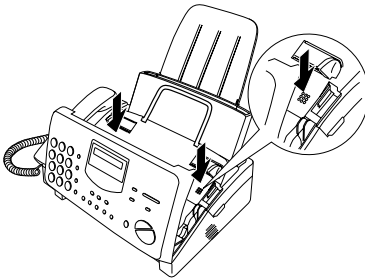

-
- 8** Reinsert the paper in the paper tray and push the paper release plate back down.

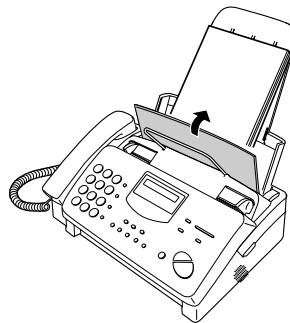
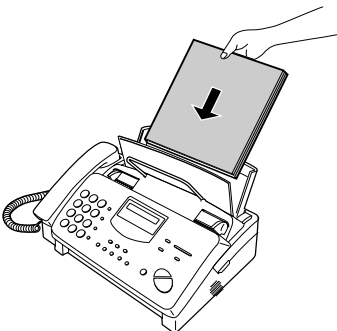

Scanning glass and rollers

Clean the scanning glass and rollers frequently to ensure the quality of transmitted images and copies. Open the operation panel (grasp the finger hold and pull up), and wipe the scanning glass and rollers with a soft cloth.

- ◆ Make sure that all dirt and stains (such as correcting fluid) are removed, as dirt and stains will cause vertical lines on transmitted images and copies.
- ◆ Adhesive cellophane tape is useful for removal of debris from the rollers.

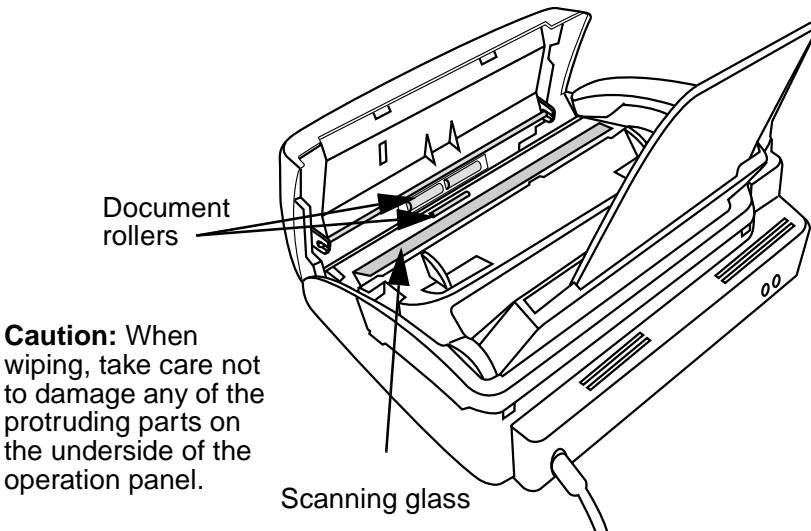

Caution: When wiping, take care not to damage any of the protruding parts on the underside of the operation panel.

The housing

Wipe the external parts and surface of the machine with a dry cloth.

Caution!

- ◆ Do not use benzene or thinner. These solvents may damage or discolor the machine.

11. Troubleshooting

Problems and Solutions

If you have any problems with your fax, first refer to the following troubleshooting guide. If you cannot solve the problem, call Sharp's Customer Assistance Center at 1-800-BE SHARP.

Line error

Problem	Solution
LINE ERROR appears in the display.	<p>Try the transaction again. If the error persists, check the following:</p> <ul style="list-style-type: none">• Check the connection. The cord from the TEL. LINE jack to the wall jack should be no longer than six feet.• Make sure there are no modem devices sharing the same telephone line.• Check with the other party to make sure their fax machine is functioning properly.• Have your telephone line checked for line noise.• Try connecting the fax machine to a different telephone line.• If the problem still occurs, your fax machine may need service.

Dialing and transmission problems

Problem	Solution
No dial tone when you pick up the handset or press the SPEAKER key.	<ul style="list-style-type: none"> • Make sure the handset cord is connected to the correct jack. See <i>Connecting the handset</i> on page 11.
Dialing is not possible.	<ul style="list-style-type: none"> • Make sure the power cord is properly plugged into a power outlet. • Make sure that the telephone line is properly connected to both the TEL. LINE jack and the wall jack. • Make sure that the fax machine is set to the correct dialing mode for your telephone line. See <i>Connecting the telephone line cord</i> on page 13.
The power is on, but no transmission takes place.	<ul style="list-style-type: none"> • Make sure that the receiving machine has paper. • Make sure that the telephone line cord is plugged into the TEL. LINE jack, and not the TEL. SET jack. • If the receiving machine is in manual mode with no attendant, reception will not be possible. • Check the display for error messages. • Pick up the handset and check for a dial tone.
Nothing is printed at the receiving end.	<ul style="list-style-type: none"> • Make sure that the document for transmission is placed face down in the feeder.
A distorted image is received at the other end.	<ul style="list-style-type: none"> • Noise on the telephone line may cause distortion. Try sending the document again. • Make a copy of the document on your fax machine. If the copy is also distorted, your fax machine may need service.

Reception and copying problems

Problem	Solution
<p>The fax machine doesn't receive documents automatically.</p>	<ul style="list-style-type: none"> • Make sure that the reception mode is set to FAX. If you subscribe to a distinctive ring service, make sure that the Distinctive Ring function is set to the correct ring pattern. If you do not subscribe to a distinctive ring service, make sure that Distinctive Ring is set to OFF SETTING. (See <i>Distinctive Ring</i> on page 99.)
<p>The power is on, but no reception takes place.</p>	<ul style="list-style-type: none"> • Make sure that the telephone line cord is plugged into the TEL. LINE jack, and not the TEL. SET jack.
<p>The printing paper comes out blank when you try to receive a document.</p>	<ul style="list-style-type: none"> • Make sure that the document is loaded properly in the feeder of the transmitting machine. Make a copy or print a report to confirm the printing ability of your machine.
<p>General print quality is poor.</p>	<ul style="list-style-type: none"> • It is important to select a paper that is appropriate for the thermal transfer printer in your fax. We recommend using laser quality paper that has a very smooth finish. Copier paper will work, but it sometimes tends to yield a lighter print quality.
<p>The received document is faint.</p>	<ul style="list-style-type: none"> • Ask the other party to send higher contrast documents. If the contrast is still too low, your fax machine may need service. Make a copy or print a report to check your machine's printing ability.
<p>Received images are distorted.</p>	<ul style="list-style-type: none"> • Noise on the telephone line may cause distortion. Have the other party try sending the document again. • The print head may be dirty. See <i>Print head</i> on page 126. • Make a copy or print a report on your fax machine. If the copy or report is also distorted, your fax machine may need service.

A received document or copy prints out in strips.	<ul style="list-style-type: none"> • Make sure the operation panel and the printer compartment cover under the operation panel are completely closed (press down on both sides of each). (To close the printer compartment cover, grasp the top of the operation panel and pull to open it, and then press down on both sides of the printer compartment cover.)
The quality of copies is poor and/or black spots appear.	<ul style="list-style-type: none"> • Any dirt or material on the scanning glass will cause spots to appear on copies and transmitted faxes. Clean the scanning glass as explained on page 129.
Reception/copying is interrupted.	<ul style="list-style-type: none"> • If reception or copying takes place continuously for a long time, the print head may overheat. Turn off the power and let it cool down.

Answering machine connection

Problem	Solution
The answering machine connection does not operate properly.	<ul style="list-style-type: none"> • Make sure your fax machine's reception mode is set to A.M. • Make sure your fax machine's TEL. LINE jack is connected to the wall jack. Make sure your fax machine's TEL. SET jack is connected to your answering machine's telephone line jack (not the answering machine's extension phone jack). • Make sure your answering machine's outgoing message is under 10 seconds. • Make sure that the Quiet Detect Time setting is set to three or four seconds (see page 91). • Make sure that the Distinctive Ring function is set to OFF SETTING (see page 99). • If you have checked all of the above and the hookup still doesn't operate properly, call the Customer Assistance Center.

General problems

Problem	Solution
Information cannot be programmed in the fax.	<ul style="list-style-type: none"> • Make sure the fax is plugged in and the imaging film and paper have been loaded. (Programming is not possible if the imaging film and printing paper have not been loaded.) See <i>Loading the Imaging Film</i> and <i>Loading Printing Paper</i> in Chapter 1.
Nothing appears in the display.	<ul style="list-style-type: none"> • Make sure the power cord is properly plugged into a power outlet. • Connect another electrical appliance to the outlet to see if it has power.
The machine does not respond when you press any of its keys.	<ul style="list-style-type: none"> • If a beep sound is not made when you press the keys, unplug the power cord and then plug it in again several seconds later.
Automatic document feeding does not work for transmission or copying.	<ul style="list-style-type: none"> • Check the size and weight of the document (see <i>Transmittable Documents</i> on page 50).
Voice calls taken on an extension phone are interrupted by the fax.	<ul style="list-style-type: none"> • The fax may interrupt during a voice call if the reception mode is set to A.M. To prevent interruption on a tone dial extension phone, press any three keys on the extension phone after answering. (Note: Do not enter the code to activate fax reception.)
No reception occurs when polling is attempted.	<ul style="list-style-type: none"> • Make sure you have not run out of paper. • Make sure the transmitting machine is set to answer automatically. • If the transmitting machine has polling security, make sure that your fax number has been entered both in your machine and in the transmitting machine.

Messages and Signals

Display messages

Note: If you have turned on the Caller ID function, see Caller ID in Chapter 8 for display messages related to Caller ID.

CHECK PAPER SIZE	The paper size setting is incorrect. Change the paper size setting as explained on page 23.
COVER OPEN	The print compartment cover (under the operation panel) is open. Open the operation panel (grasp the top and pull toward you), and then press down firmly on both sides of the print compartment cover to close it.
DOCUMENT JAMMED	The original document is jammed. See the following section, <i>Clearing Paper Jams</i> .
FAX RX IN MEMORY	A fax has been received in memory because the imaging film needs replacement, you have run out of printing paper, or the paper is jammed. The fax will print out automatically when the problem is fixed.
FILM END	The imaging film may need replacement. Check the film and replace if necessary.
FUNCTION MODE	The FUNCTION key has been pressed.
HOLD	The HOLD/SEARCH key has been pressed to put the other party on hold during a phone conversation. Press the HOLD/SEARCH again to take the other party off hold.
LCR DOWNLOADING	The fax machine has called OpenLCR and is receiving carrier rate data. This message only appears if you have registered with OpenLCR.
DOWNLOAD ERROR	The fax machine was unable to download rate data from OpenLCR. Try downloading the data manually as explained in <i>Downloading (receiving) the rate data manually</i> on page 39.

Messages and Signals

LINE ERROR	Transmission or reception was not successful. Press the STOP key to clear the message and then try again. If the error persists, see <i>Line Error</i> on page 130.
LINE IS IN USE	An extension phone connected to the fax is being used. Do not lift the fax's handset or attempt transmission at this time, as this will interrupt the conversation on the extension phone.
MEMORY IS FULL	The memory is full. This may occur during fax reception if too much data is received before the pages can be printed out. If faxes have been received to memory because printing is not possible (an additional message will indicate the problem), resolve the problem so that printing can continue (see <i>Substitute Reception to Memory</i> on page 80). If you are attempting to transmit from memory, see <i>If the memory becomes full</i> on page 111.
MEMORY PRINTING	The fax is preparing to or printing out a document from memory.
NO DATA	This appears if you attempt to search for an automatic dialing number when none have been stored.
NO SERVICE	This appears if you haven't registered with OpenLCR and press the FUNCTION key and 7 .
NO # STORED	You have tried to dial or clear a Rapid Key or Speed Dial number that hasn't been programmed (a full number hasn't been assigned to it).
OFF HOOK	This appears if you forgot to replace the handset after using it to dial and send a fax. Replace the handset or press the STOP key to clear the message.
ON HOOK DIAL	The SPEAKER key has been pressed and the fax machine is waiting for you to dial.
OUT OF PAPER	You are out of printing paper (or the paper release plate is open). Load paper as explained in <i>Loading Printing Paper</i> on page 22.

OVER HEAT	The print head has overheated. Operation can be continued after it cools.
PAPER JAMMED	The printing paper is jammed. See the following section, <i>Clearing Paper Jams</i> .
READY TO SEND	A document has been loaded and the fax machine is waiting for you to begin faxing or copying.
RECALLING	This appears if you attempt to send a fax by automatic dialing and the line is busy or the receiving fax machine does not answer. Your fax machine will automatically reattempt the call. (See page 69.)
SEARCH DIAL	The HOLD/SEARCH key has been pressed. Press # or * to search for an automatic dialing number, or press the STOP key to return to the date and time display. (See <i>Searching for an auto-dial number</i> on page 68.)
TOTAL PAGE(S) 01	Number of pages transmitted, received, or copied.

Audible signals

Continuous tone	3 seconds	Indicates the end of transmission, reception, or copying.
Intermittent tone (3 beeps)	5 seconds (1 second on, 1 second off)	Indicates incomplete transmission, reception, or copying.
Rapid intermittent tone	35 seconds (0.7 seconds on, 0.3 seconds off)	Indicates that the handset is off hook.

Clearing Paper Jams

Clearing a jammed document

If the original document doesn't feed properly during transmission or copying, or DOCUMENT JAMMED appears in the display, first try pressing the **START/MEMORY** key. If the document doesn't feed out, open the operation panel and remove it.

Important:

Do not try to remove a document without opening the operation panel. This may damage the feeder mechanism.

-
- 1 Open the operation panel by grasping the finger hold and pulling up.

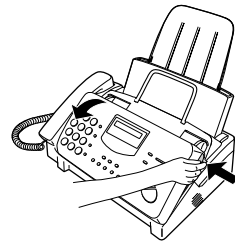

-
- 2 Remove the document.

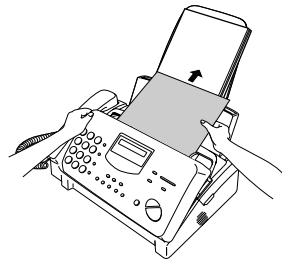

-
- 3 Close the operation panel, making sure it clicks into place.

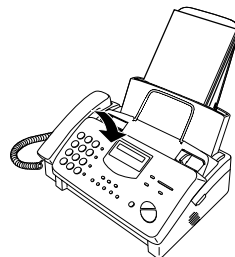

Clearing jammed printing paper

- 1 Pull the paper release plate forward and remove the paper.

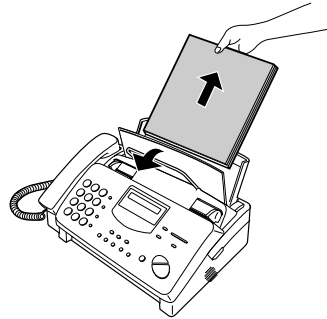

- 2 Open the operation panel (grasp the finger hold and pull up), and then pull the release on the right side of the machine forward to open the print compartment cover.

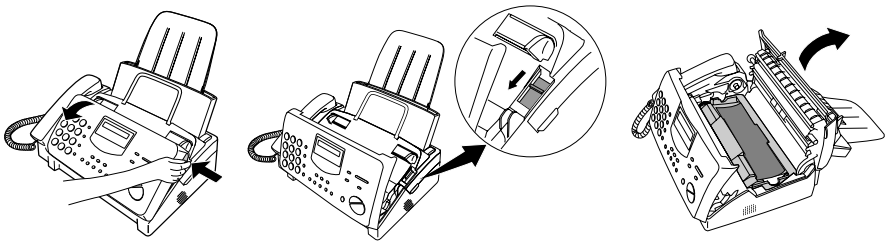

- 3 Gently pull the jammed paper out of the machine, making sure no torn pieces of paper remain in the print compartment or rollers.

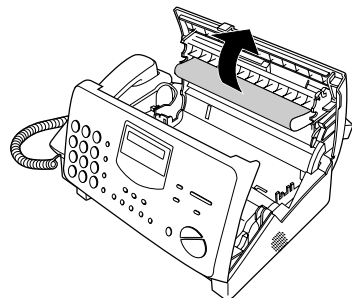

-
- 4** Close the print compartment cover (press down on both sides to make sure it clicks into place), and then close the operation panel.

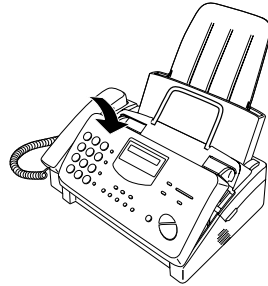
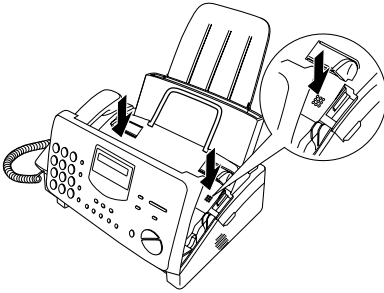

-
- 5** Reinsert the paper in the paper tray and push the paper release plate back down.

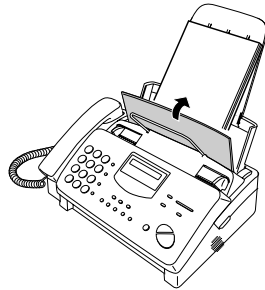

Ordering Parts

To order parts, contact the parts distribution center located nearest you. When ordering a part, use the part order number shown below.

Operation manual	TINSE4132XHZZ
Rapid Key labels	TLABH481AXHZZ
Handset cord	QCNW-289ASCOW
Telephone line cord	QCNW-290ASCZZ
Handset	DUNTK464BXHLW
Original document support	PHOP-2102XHZZ
Imaging film cartridge	CPLTP3002XHB1
Gears	NGERH2455XHZZ (large gear) NGERH2456XHZZ

Part distribution centers

Panson Electronics 1-80 and New Maple Ave. Pine Brook, NJ 07058	Tel: 1-800-255-5229 Fax: 1-800-332-3922
Tritronics, Inc. 1306 Continental Drive Abingdon, MD 21009	Tel: 1-800-638-3328 Fax: 1-800-888-FAXD
Tritronics, Inc. 1015 NW 52nd Street Ft. Lauderdale, FL 33309	Tel: 1-800-365-8030 Fax: 1-800-999-FAXD
Fox International, Ltd. 23600 Aurora Road Bedford Heights, OH 44146	Tel: 1-800-321-6993 Fax: 1-800-445-7991
Andrews Electronics 25158 Avenue Stanford Santa Clarita, CA 91355	Tel: 1-800-274-4666 Fax: 1-805-295-5126
Sharp Accessories and Supply Center 2130 Townline Road Peoria, IL 61615	Tel: 1-800-642-2122

FCC Regulatory Information

This equipment complies with FCC rules, Part 68. On this equipment is a label that contains, among other information, the FCC Registration Number and Ringer Equivalence Number (REN) for this equipment. If requested, this information must be provided to your telephone company.

An FCC compliant telephone cord and modular plug is provided with this equipment. This equipment is designed to be connected to the telephone network or premises wiring using a compatible modular jack which is Part 68 compliant. This equipment connects to the telephone network through a standard USOC RJ-11C network interface jack.

The REN is used to determine the quantity of devices which may be connected to your telephone line and still have all of those devices ring when your number is called. Too many devices on one line may result in the devices not ringing in response to an incoming call. In most, but not all, areas as the sum of the RENs of all devices should not exceed five (5.0). To be certain of the number of devices that may be connected to your line, as determined by the total REN, contact your local telephone company.

If this equipment causes harm to the telephone network, your telephone company may disconnect your service temporarily. If possible, they will notify you in advance. If advance notice is not practical, you will be notified as soon as possible. You will also be advised of your right to file a complaint with the FCC.

Your telephone company may make changes in its facilities, equipment, operations, or procedures that could affect the operation of your equipment. If this happens, the telephone company will provide advance notice in order for you to make necessary modifications to maintain uninterrupted service. If the equipment is causing harm to the telephone network, your telephone company may ask you to disconnect the equipment until the problem resolved.

If you have any questions or problems which cannot be solved by reading this manual, please contact Sharp's Customer Assistance Center. The number is 1-800-BE SHARP.

This equipment may not be used on coin service provided by the telephone company. Connection to party lines is subject to state tariffs. Contact your state's public utility commission, public service commission, or corporation commission for more information.

This equipment is hearing-aid compatible.

When programming and/or making test calls to emergency numbers:

- ◆ Remain on the line and briefly explain to the dispatcher the reason for the call.
- ◆ Perform such activities in the off-peak hours, such as early morning or late evening.

Quick Reference Guide

Entering Your Name and Number

1. Press:

Display shows: OWN NUMBER SET

2. Press:

3. Enter your fax number (max. of 20 digits) by pressing the number keys.

- To insert a space between digits, press the # key.
- If you make a mistake, press the **SPEED DIAL** key to backspace and clear the mistake.

4. Press:

5. Enter your name by pressing the appropriate number keys as shown below.

- To enter two letters in succession that require the same key, press the **SPEAKER** key after entering the first letter.

SPACE =	J =	T =
A =	K =	U =
B =	L =	V =
C =	M =	W =
D =	N =	X =
E =	O =	Y =
F =	P =	Z =
G =	Q =	
H =	R =	
I =	S =	

- To change case, press the **REDIAL** key. Press # or * to scroll through symbols and special characters.

6. When finished, press:

Setting the Date and Time

1. Press:

Display shows: DATE & TIME SET

2. Press:

- Enter two digits for the month (01 to 12).
- Enter two digits for the day (01 to 31).
- Enter four digits for the year (Ex: 2000)
- Enter two digits for the hour (01 to 12) and two digits for the minute (00 to 59).
- Press * for A.M. or # for P.M.

8. When finished, press:

Storing and Clearing Auto Dial Numbers

1. Press:

Display shows: FAX/TEL # MODE

- Press 1 to store a number or 2 to clear a number.
- Enter a 2-digit Speed Dial number (from 01 to 07 for Rapid Key Dialing, or 08 to 47 for Speed Dialing). (If you are clearing a number, go to Step 7.)
- Enter the full fax/telephone number.

5. Press:

6. Enter the name of the location by pressing number keys. (Refer to the letter entry table in *Entering Your Name and Number*.)

7. Press:

Sending Faxes

Place your document (up to 10 pages) face down in the document feeder.

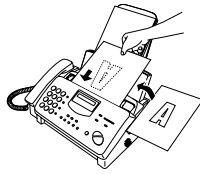

Normal Dialing

1. Lift the handset or press  **SPEAKER**
2. Dial the fax number.
3. Wait for the reception tone (if a person answers, ask them to press their Start key).

4. Press:  **START/MEMORY**

Rapid Key Dialing

Press the appropriate Rapid Key. Transmission will begin automatically.

Speed Dialing

1. Press:  **SPEED DIAL**
2. Enter the 2-digit Speed Dial number.
3. Press:  **START/MEMORY**

Receiving Faxes

Press the **RECEPTION MODE** key until the arrow in the display points to the desired reception mode.

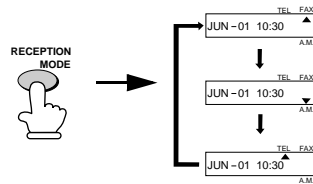

FAX mode: The fax machine automatically answers on four rings and receives the incoming document.

TEL mode:

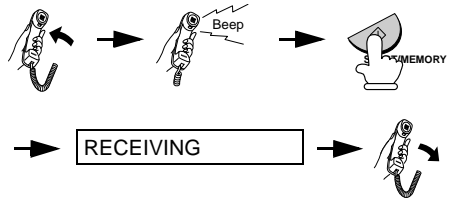

A.M. mode: Select this mode when an answering machine is connected to the fax and the answering machine is turned on.

Guía de referencia rápida

Introducción de su nombre y número

1. Pulse:

El visor muestra:

OWN NUMBER SET

2. Pulse:



3. Introduzca su número de telefax (20 dígitos como máx.) mediante pulsación de las teclas numéricas.

- Pulse la tecla # para introducir un espacio libre.
- Si cometiera un error, pulse la tecla **SPEED DIAL** (marcación rápida) para volver un puesto y corregirlo.

4. Pulse:



5. Introduzca su nombre mediante pulsación de las teclas numéricas adecuadas como se muestra a continuación.

- Para introducir dos letras sucesivas que requieran el mismo código, pulse la tecla **SPEAKER** (altavoz) después de introducir la primera letra.

SPACE =	J =	T =
A =	K =	U =
B =	L =	V =
C =	M =	W =
D =	N =	X =
E =	O =	Y =
F =	P =	Z =
G =	Q =	
H =	R =	
I =	S =	

- Para cambiar de mayúscula a minúscula y viceversa, pulse la tecla **REDIAL** (repetición de llamada). Pulse la tecla # o * para hojear por los símbolos y caracteres especiales.

6. Una vez finalizado pulse:



Ajuste de la fecha y hora

1. Pulse:

El visor muestra:

DATE & TIME SET

2. Pulse:



- Introduzca dos dígitos para el mes (01 hasta 12).
- Introduzca dos dígitos para el día (01 hasta 31).
- Introduzca cuatro dígitos para el año (Ej.: 2000).
- Introduzca dos dígitos para la hora (01 hasta 12) y dos dígitos para los minutos (00 hasta 59).
- Pulse * para A.M. o # para P.M.
- Una vez finalizado pulse



Memorización y borrado de números de marcación automática

1. Pulse:

El visor muestra: FAX/TEL # MODE

- Pulse 1 para guardar un número ó 2 para borrarlo.
- Introduzca un número de marcación abreviada de dos dígitos (desde 01 hasta 07 para marcación rápida o desde 08 hasta 47 para marcación abreviada). (Vaya al paso 7 si está borrando un número)
- Introduzca el número de telefax/teléfono completo.
- Pulse:
- Introduzca el número del puesto mediante pulsación de las teclas numéricas. (Consulte la tabla para introducción de letras en la *Introducción de su nombre y número*).

7. Pulse:

Transmisión de mensajes telefax Recepción de mensajes telefax

Coloque el original (hasta 10 páginas) cara abajo en el alimentador de documentos.

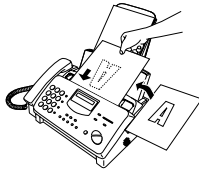

Marcación normal

1. Levante el auricular o pulse **SPEAKER**
2. Marque el número de telefax.
3. Espere hasta escuchar el tono de recepción (si contestara una persona, pídale pulsar su tecla Start).
4. Pulse:



Marcación rápida

Pulse la tecla de marcación rápida adecuada. La transmisión se inicia automáticamente.

Marcación abreviada

1. Pulse: **SPEED DIAL**
2. Introduzca el número de dos dígitos de marcación abreviada.
3. Pulse:



Pulse la tecla **RESOLUTION/RECEPTION MODE** (Resolución/Modo de recepción) hasta que la flecha en el visor señale el modo de recepción deseado (asegúrese de que el alimentador de originales está vacío).

RESOLUTION

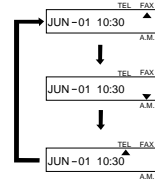

Modo FAX: El aparato telefax contesta automáticamente tras cuatro llamadas del timbre y recibe el documento entrante.

Modo TEL:

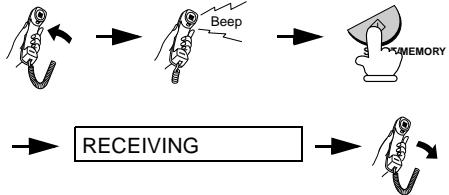

Please check the bottom righthand corner of the product number UX-3CR on the film box, or the final digit of the manufacturing number on the label at the beginning of the roll of ink film. If an "F" appears, please read pages 147 to 148. If an "F" does not appear, please read pages 149 to 150.

S H A R P

Revised date : _____
 Issued date : DEC.2.1999

MATERIAL SAFETY DATA SHEET (1/2)

MSDS No B-1021

Section 1. Product Identification

Product Code : UX-3CR Imaging Film

Section 2. Supplier's Name and Address

Sharp Corporation

22-22 Nagaike-cho, Abeno-ku, Osaka, Japan

Local suppliers are listed below. Please contact the nearest supplier for additional information.

(Country)	(Name and Telephone Number)
U.S.A.	Sharp Document Network System of America Telephone number for information: 1-800-237-4277 Emergency telephone number : 1-800-255-3924
Canada	Sharp Electronics of Canada Ltd. Telephone number for information: 905-890-2100 Emergency telephone number : 1-800-424-9300
United Kingdom	Sharp Electronics (U.K.) Ltd. Telephone number for information: 01923-474013

Section 3. Ingredients

Ingredients	Cas No.	Proportion	OSHA PEL	ACGIH TLV	Other Limits
Carbon Black	1333-86-4	9%	3.5 mg/m ³	3.5 mg/m ³	-
Paraffin Wax (fume)	8002-74-2	23%	-	2.0 mg/m ³	-
Polyethylene terephthalate	25038-59-9	50 - 55%	-	-	-
Ethylene-vinyl acetate copolymer	24937-78-8	1 - 5%	-	-	-
Ester wax	8015-86-9	1 - 5%	-	-	-
Polyester resin	27923-68-8	1 - 5%	-	-	-
Synthetic wax	68989-34-4	1 - 5%	-	-	-
Others	-	1 - 5%	-	-	-

Section 4. Hazardous Identification (Emergency Overview)

This product is ink film for thermal transfer facsimile.

"Ink film" is a thin film coated with ink.

It is no special hazard under normal use condition.

Section 5. Health Hazard Data

Route(s) of Entry :	Inhalation?	Skin?	Ingestion?
	Not applicable	Not applicable	Possible but very unusual

Health Hazards : The ingredients are not listed in ACGIH(1986) and OSHA(1989) except carbon black and paraffin wax.

Carcinogenicity : In 1996 the IARC reevaluated carbon black as a Groupe 2B carcinogen (possible human carcinogen).

This classification is given to chemicals for which there is inadequate human evidence, but sufficient animal evidence on which to base an opinion of carcinogenicity. The classification is based upon the development of lung tumors in rats receiving chronic inhalation exposures to free carbon black at levels that induce particle overload of the lung. Studies performed in animal models other than rats did not show any association between carbon black and lung tumors.

Signs and Symptoms of Exposure : no data available

Medical Conditions Generally Aggravated by Exposure : no data available

Emergency and First Aid Procedures :

SKIN-----Wash away ink on skin

EYE-----Wash away water and consult a doctor promptly.

INHALATION---Not applicable

OTHERS-----No data available

S H A R P

MATERIAL SAFETY DATA SHEET (2/2)

MSDS No. B-1021

Section 6. Physical Chemical Characteristics

Boiling/Melting Point	No data available	Specific Gravity	No data available
Vapor Pressure	No data available	Solubility in Water	Negligible
Vapor Density	No data available	PH	No data available
Evaporation Rate	No data available	Viscosity	No data available
Appearance	Thin film coated with ink	Color	Black
Odor	Slight wax odor		

Section 7. Fire and Explosion Data

Flash Point (Method Used)	: >150°C for ink
Ignition Temperature	: No data available
Flammable Limits	: (LEL); No data available (UEL); No data available
Extinguishing Media	: Water mist, Foam, Dry powder, CO ₂ gas, others
Special Fire Fighting Procedure	: No data available
Unusual Fire and Explosion Hazard	: None
Sensitivity to Mechanical Impact	: No hazardous effect by mechanical impact
Sensitivity to Static Charge	: Not applicable

Section 8. Reactivity Data

Stability	: Stable
Incompatibility (Materials to Avoid)	: None
Hazardous Decomposition	: None
Hazardous Polymerization	: Will not occur

Section 9. Precautions for Safe Handling and Use

Personal Protection Information (Respiratory, Eye Protection and Protective Glove)	: Hnad protection : Desireble in some cases
Engineering Control / Ventilation	: No data available
Work / Hygienic Practice	: None
Steps to be taken in case of Spill or Leak	: If inadvertently released, rewind ribbon.
Waste Disposal Method	: Disposal in accordance with local, state and federal regulations.

Section 10. Regulatory Information

NFPA Rating (U.S.A.)	: No information
WHMIS Legislation (Canada)	: Not controlled
Transport Information	: No information
UN No.	: Not applicable

Section 11. Other Information

References : IARC(1996) Monographs on the Evaluation of the Carcinogenic Risk of Chemicals to Humans, Vol. 65, Printing Process and Printing Inks, Carbon Black and Some Nitro Compounds, Lyon, pp-149-261
H. Muhle, B. Bellmann, O. Creutzenberg, C. Dasenbrock, H. Ernst, R. Kilpper, J. C. Mackenzie, P. Morrow, U. Mohr, S. Takenaka, and R. Mermelstein (1991) Pulmonary Response to Toner upon Chronic Inhalation Exposure in Rats. Fundamental and Applied Toxicology 17, pp. 280-299

S H A R P

Date Revised: _____

Date Issued : Dec. 22, 1998

MATERIAL SAFETY DATA SHEET (1/2)

MSDS No. B-1006

Section 1. Product Identification

Product Code : UX-3CR Imaging Film

Section 2. Supplier's Name and Address

Sharp Corporation

22-22 Nagaike-cho, Abeno-ku, Osaka, Japan

Local suppliers are listed below. Please contact the nearest supplier for additional information.

(Country)	(Name and Telephone Number)
U.S.A.	Sharp Document Network System of America Telephone number for information: 1-800-237-4277 Emergency telephone number : 1-800-255-3924
Canada	Sharp Electronics of Canada Ltd. Telephone number for information: 905-890-2100 Emergency telephone number : 1-800-424-9300
United Kingdom	Sharp Electronics (U.K.) Ltd. Telephone number for information: 01923-474013

Section 3. Ingredients

Ingredients	CAS No.	Proportion	OSHA PEL	ACGIH TLV	Other Limits
Polyethylene terephthalate	25038-59-9	51.0%	-	-	-
Carbon Black	1333-86-4	8.5%	3.5 mg/m ³	3.5 mg/m ³	-
Ethylene-vinyl acetate copolymer	24937-78-8	3.1%	-	-	-
Ester wax	8015-86-9	5.6%	-	-	-
Parraffin Wax	8002-74-2	12.5%	-	2 mg/m ³ (fume)	-
Microcrystalline wax	63231-60-7	15.2%	-	-	-
Modified wax	8016-60-2	1.3%	-	-	-
Polyester resin	27923-68-8	1.3%	-	-	-
Others	-	1.5%	-	-	-

Section 4. Hazardous Identification (Emergency Overview)

This product is ink film for thermal transfer facsimile. "Ink film" is a thin film coated with ink.

It is no special hazard under normal use condition.

Section 5. Health Hazard Data

Route(s) of Entry :	Inhalation?	Skin?	Ingestion?
	Not applicable	Not applicable	Possible but very unusual

Health Hazards : The ingredients are not listed in ACGIH(1986) and OSHA(1989) except carbon black and paraffin wax.**Carcinogenicity** : In 1996 the IARC reevaluated carbon black as a Groupe 2B carcinogen (possible human carcinogen). This classification is given to chemicals for which there is inadequate human evidence, but sufficient animal evidence on which to base an opinion of carcinogenicity. The classification is based upon the development of lung tumors in rats receiving chronic inhalation exposures to free carbon black at levels that induce particle overload of the lung. Studies performed in animal models other than rats did not show any association between carbon black and lung tumors.**Signs and Symptoms of Exposure** : not applicable**Medical Conditions Generally Aggravated by Exposure** : not applicable**Emergency and First Aid Procedures** : not applicable

S H A R P

Date Revised: _____

Date Issued : Dec. 22, 1998

MATERIAL SAFETY DATA SHEET (2/2)

MSDS No. B-1006

Section 6. Physical Chemical Characteristics

Boiling/Melting Point	m.p. about 70 C for ink	Specific Gravity	about 1
Vapor Pressure	Not applicable	Solubility in Water	Negligible
Vapor Density	Not applicable	PH	Not applicable
Evaporation Rate	Negligible	Viscosity	Not applicable
Appearance	Thin film coated with ink	Color	Black
Odor	Slight wax odor		

Section 7. Fire and Explosion Data

Flash Point (Method Used)	: about 250°C for ink
Ignition Temperature	: Not applicable
Flammable Limits	: (LEL): Not applicable(UEL): Not applicable
Extinguishing Media	: CO2, water , dry chemicals and form etc.
Special Fire Fighting Procedure	: None
Unusual Fire and Explosion Hazard	: None
Sensitivity to Mechanical Impact	: No hazardous effect by mechanical impact
Sensitivity to Static Charge	: Not applicable

Section 8. Reactivity Data

Stability	: Stable
Incompatibility (Material to Avoid)	: None
Hazardous Decomposition	: Not applicable
Hazardous Polymerization	: Not applicable

Section 9. Precautions for Safe Handling and Use

Personal Protection Information (Respiratory, Eye Protection and Protective Glove)	: Not required
Engineering Control / Ventilation	: Not required
Work / Hygienic Practice	: None
Steps to be taken in case of Spill or Leak	: If rumple the product and wax layer peel off, sweep up or clean with vacuum cleaner.
Waste Disposal Method	: If it dirty skin, wash with water and soap. If it clothes, wash by suitable method. Dispose in an approved incinerator or contract with licensed chemical disposal agency. Ensure conformity with governmental diaposal regulations. (Dispose by the same method of ordinary plastic products.)

Section 10. Regulatory Information

NFPA Rating (U.S.A.)	: No information
WHMIS Legislation (Canada)	: Not controlled
Transport Information	: No information
UN No.	: No information

Section 11. Other Information

References : IARC(1996), IARC Monographs on the Evaluation of the Carcinogenic Risk of Chemicals to Humans, Vol. 65, Printing Process and Printing Inks, Carbon Black and Some Nitro Compounds, Lyon, pp-149-261
H. Muhle, B. Bellmann, O. Creutzenberg, C. Dasenbrock, H. Ernst, R. Kilpper, J. C. Mackenzie, P. Morrow, U. Mohr, S. Takenaka, and R. Mermelstein (1991) Pulmonary Response to Toner upon Chronic Inhalation Exposure in Rats. Fundamental and Applied Toxicology 17, pp. 280-299

Index

A

- A.M. reception mode, 32, 89
- Activity Report, 119
 - Auto print-out, 121
- Answering machine hookup
 - Activating, 89
 - Connecting, 88
 - Fax reception when TAD fails, 92
 - Quiet Detect Time, 91
 - Troubleshooting, 133
- Anti Junk Fax, 108 - 109
- Anti Junk Number List, 123
- Audible signals, 137
- Auto-dial numbers, storing, 61

B

- Batch page numbering, 106

C

- Caller ID, 93 - 98
- Caller ID List, 124
- Chain Dialing, 63, 86
- Contrast, 55
- Copies, 81 - 83
- Copy cut-off setting, 84
- Cover sheet, 103 - 105

D

- Date, setting, 29
- Daylight Saving Time, 31
- Dial mode, 13
- Dialing
 - Chain, 63, 86
 - Direct Keypad, 67
 - Normal, 58, 85
 - Rapid Key, 65, 85
 - Speed, 66, 85

- Direct Keypad Dialing, 67
- Display messages, 135
- Distinctive ring, 99
- Document feeder, 52
- Document guides, 52
- Document restrictions, 51
- Document sizes, 50
- Document, maximum scanning size, 51

E

- ECM (Error Correction Mode), 71
- Extension telephone
 - Connecting, 15
 - Using, 75

F

- FAX reception mode, 32, 72
- Fax Signal Receive, 78
- Fine resolution priority, 57

H

- Halftone setting, 55
- Handset, 11
- Handset receiver volume, 33
- Hold, 87
- Housing, cleaning, 129

I

- Imaging film, loading and replacing, 16 - 21
- Initialize film setting, 20

J

- Jams, clearing, 138 - 140

L

- Letters, entering, 27

Index

Line error, 130
Loading printing paper, 22 - 23
Loading the document, 52

M

Memory
 Sending documents from, 110
 Substitute reception to, 80

N

Normal Dialing, 58, 85
Number of rings in FAX reception mode,
73

O

OpenLCR, 35 - 49
Option Setting List, 123
Ordering parts, 141
Original document support, 14

P

Paper jams, clearing, 138 - 140
Paper size setting, 23
Paper, loading, 22 - 23
Passcode List, 122
Pauses in automatic dialing, 61
Polling, 112 - 115
Power cord, 12
Print contrast setting, 24
Print head, cleaning, 126 - 128
Print Setup List, 124
Priority Call, 97

R

Rapid Key Dialing, 65, 85

Recall interval, 69
Recall times, 70
Reception mode
 A.M. mode, 32, 89
 FAX mode, 32, 72
 Setting, 32
 TEL mode, 32, 74
Reception Ratio setting, 79
Redialing, 59, 69, 86
Remote reception setting, 77
Removing original document, 53
Resolution, 55
Ringer volume, 34

S

Scanning glass, cleaning, 129
Search Dial, 68, 86
Sender's name and number, entering, 25
- 28
Speaker volume, 33
Speed Dialing, 66, 85

T

TEL reception mode, 32, 74
TEL. LINE jack, 13
TEL. SET jack, 15, 88
Tel/Fax Remote Number, 76, 77
Telephone line cord, 13
Telephone Number List, 122
Time, setting, 29
Timer List, 121
Timer operations, 116 - 118
Transaction Report, 124
 Setting print-out condition, 125
Two-in-one printing, 78

LIMITED WARRANTY

SHARP ELECTRONICS CORPORATION warrants to the first end user purchaser that this Sharp brand product (the "Product"), when shipped in its original container, will be free from defective workmanship and materials, and agrees that it will, at its option, either repair the defect or replace the defective Product or part thereof with a new or remanufactured equivalent at no charge to the purchaser for parts or labor for the period(s) set forth below.

This warranty does not apply to any appearance items of the Product nor to the additional excluded item(s) set forth below nor to any product the exterior of which has been damaged or defaced, which has been subjected to misuse, abnormal service or handling, or which has been altered or modified in design or construction.

In order to enforce the rights under this limited warranty, the purchaser should follow the steps set forth below and provided proof of purchase to the servicer.

To the extent permitted by applicable state law, the warranties set forth herein are in lieu of, and exclusive of, all other warranties, express or implied. Specifically, ALL OTHER WARRANTIES OTHER THAN THOSE SET FORTH ABOVE ARE EXCLUDED. ALL EXPRESS AND IMPLIED WARRANTIES INCLUDING THE WARRANTIES OF MERCHANTABILITY, FITNESS FOR USE, AND FITNESS FOR A PARTICULAR PURPOSE ARE SPECIFICALLY EXCLUDED. If, under applicable state law, implied warranties may not validly be disclaimed or excluded, the duration of such implied warranties is limited to the period(s) from the date of purchase set forth below.

Neither the sales personnel of the seller nor any other person is authorized to make any warranties other than those described above, or to extend the duration of any warranties beyond the time period described above on behalf of Sharp.

The warranties described herein shall be the sole and exclusive warranties granted by Sharp and shall be the sole and exclusive remedy available to the purchaser. Correction of defects, in the manner and for the period of time described herein, shall constitute complete fulfillment of all liabilities and responsibilities of Sharp to the purchaser with respect to the Product, and shall constitute full satisfaction of all claims, whether based on contract, negligence, strict liability or otherwise. In no event shall Sharp be liable, or in any way responsible, for any damages or defects in the Product which were caused by repairs or attempted repairs performed by anyone other than an authorized servicer. Nor shall Sharp be liable or in any way responsible for any incidental or consequential economic or property damage. Some states do not allow limits on warranties or on remedies for breach in certain transactions; in such state the limits herein may not apply.

Your Product:

Warranty Period for this Product:

Additional items excluded

from warranty coverage:

Where to obtain service:

What to do to obtain service:

Personal Facsimile

Ninety (90) days parts and labor from date of purchase.

Any consumable items such as paper supplied with the Product.

At a Sharp Authorized Servicer located in the United States.

To find out the location of the nearest Sharp Authorized Servicer, call Sharp toll free at 1--800-BE-SHARP.

Ship (prepaid) or carry in your Product to a Sharp Authorized Servicer.

Be sure to have proof of purchase available. If you ship or mail the Product, be sure it is packaged carefully.

For product information or customer assistance, please visit <http://www.sharp-usa.com> on the World Wide Web or call **1-800-BE SHARP**.

SHARP DOCUMENT NETWORK SYSTEM OF AMERICA

Sharp Plaza,

Mahwah, New Jersey 07430-2135

SHARP®
**SHARP DOCUMENT NETWORK SYSTEM OF
AMERICA**

Sharp Plaza, Mahwah, New Jersey 07430-2135

SHARP CORPORATION

PRINTED IN THAILAND
(TINSE4132XHZZ)

Free Manuals Download Website

<http://myh66.com>

<http://usermanuals.us>

<http://www.somanuals.com>

<http://www.4manuals.cc>

<http://www.manual-lib.com>

<http://www.404manual.com>

<http://www.luxmanual.com>

<http://aubethermostatmanual.com>

Golf course search by state

<http://golfingnear.com>

Email search by domain

<http://emailbydomain.com>

Auto manuals search

<http://auto.somanuals.com>

TV manuals search

<http://tv.somanuals.com>