

SHARP

DVD CINEMA

MODEL

HT-DV40H HT-DV50H

OPERATION MANUAL



Note:

This product is not compatible with MTP and AAC file systems.

Thank you for purchasing this SHARP product. To obtain the best performance from this product, please read this manual carefully. It will guide you in operating your SHARP product.

This manual contains two different home cinema systems, and may not be available in all countries.

- HT-DV40H DVD Cinema consisting of HT-DV40H (main unit), CP-DV40H (speaker) and CP-SW40H (subwoofer system).
- HT-DV50H DVD Cinema consisting of HT-DV50H (main unit), CP-DV50H (speaker) and CP-SW40H (subwoofer system).

MODEL : HT-DV40H

SPEAKERS : CP-DV40H

SUBWOOFER : CP-SW40H

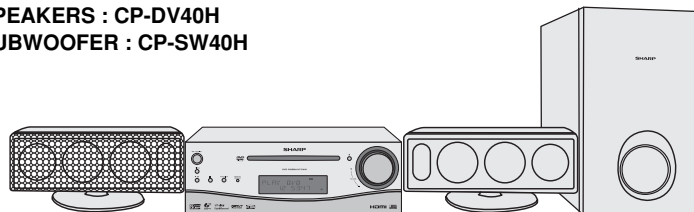

MODEL : HT-DV50H

SPEAKERS : CP-DV50H

SUBWOOFER : CP-SW40H

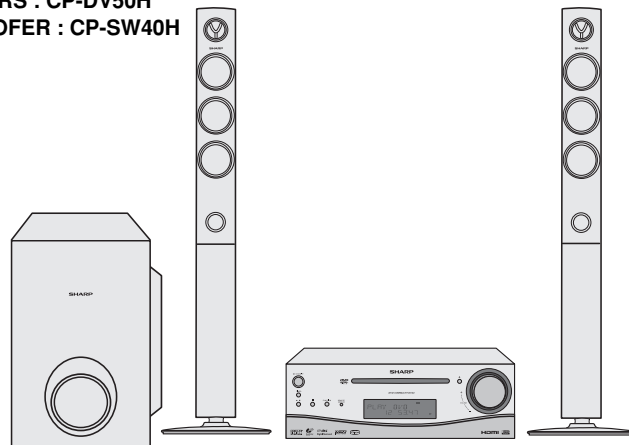

Special Notes

WARNINGS

- When the ON/STAND-BY button is set at STAND-BY position, mains voltage is still present inside the unit. When the ON/STAND-BY button is set at STAND-BY position, the unit may be brought into operation by the timer mode or remote control.
- This unit contains no user serviceable parts. Never remove covers unless qualified to do so. This unit contains dangerous voltages, always remove mains plug from the socket before any service operation and when not in use for a long period.
- To prevent fire or shock hazard, do not expose this appliance to dripping or splashing. No objects filled with liquids, such as vases, shall be placed on the apparatus.
- Do not turn the volume on to full at switch on. Listen to music at moderate levels. Excessive sound pressure from earphones and headphones can cause hearing loss.

Note for users in United Kingdom:

Recording and playback of any material may require consent, which SHARP is unable to give. Please refer particularly to the provisions of the Copyright Act 1956, the Dramatic and Musical Performers Protection Acts 1958, the Performers Protection Acts 1963 and 1972 and to any subsequent statutory enactments and orders.

Note for users in Australia:

Copyright may exist in material you wish to record. Copying or broadcasting such material without permission of the relevant licenses or owners of the copyright is prohibited by law. SHARP is not in a position to authorise the copying or broadcasting of copyright materials and nothing in this OPERATION MANUAL should be implied as giving that authority.

For other countries:

Audio-visual material may consist of copyrighted works which must not be recorded without the authority of the owner of the copyright. Please refer to the relevant laws in your country.

CAUTIONS

- This product is classified as a CLASS 1 LASER PRODUCT.
- This unit contains a low power laser device. To ensure continued safety do not remove any cover or attempt to gain access to the inside of the product. Refer all servicing to qualified personnel.

NOTES

Copyright Information:

- Unauthorised copying, broadcast, public display, transmission, public performance and rental (regardless of whether or not such activities are for profit) of disc contents are prohibited by law.
- This system is equipped with copy protection technology that causes substantial degradation of images when the contents of a disc are copied to a video tape.

Copy Protection:

This unit supports Macrovision copy protection. On DVD discs that include a copy protection code, if the contents of the DVD disc are copied using a VCR, the copy protection code prevents the videotape copy from playing normally.

Apparatus Claims of U.S. Patent Nos. 4,631,603, 4,577,216, 4,819,098, and 4,907,093, licensed for limited viewing uses only.

This product incorporates copyright protection technology that is protected by method claims of certain U.S. patents and other intellectual property rights owned by Macrovision Corporation and other rights owners.

Use of this copyright protection technology must be authorised by Macrovision Corporation, and is intended for home and other limited viewing uses only unless otherwise authorised by Macrovision Corporation.
Reverse engineering or disassembly is prohibited.

Manufactured under license under U.S. Patent #'s: 5,451,942; 5,956,674; 5,974,380; 5,978,762; 6,487,535 & other U.S. and world wide patents issued & pending. DTS and DTS Digital Surround are registered trademarks and the DTS logos and Symbol are trademarks of DTS, Inc. © 1996-2007 DTS, Inc. All Rights Reserved.

Manufactured under license from Dolby Laboratories. "Dolby", "Pro Logic", the double-D symbol, Audistry and the sound shell logo are trademarks of Dolby Laboratories.

"HDMI, the HDMI logo and High-Definition Multimedia Interface are trademarks or registered trademarks of HDMI Licensing LLC."



DivX[®], DivX[®] Certified and associated logos are trademarks of DivX[®]-Networks, Inc. and are used under license.







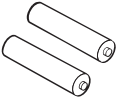
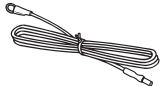
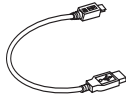

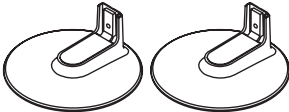

Special Note

Supply of this product does not convey a license nor imply any right to distribute content created with this product in revenue-generating broadcast systems (terrestrial, satellite, cable and/or other distribution channels), revenue-generating streaming applications (via Internet, intranets and/or other networks), other revenue-generating content distribution systems (pay-audio or audio-on-demand applications and the like) or on revenue-generating physical media (compact discs, digital versatile discs, semiconductor chips, hard drives, memory cards and the like). An independent license for such use is required. For details, please visit <http://mp3licensing.com>
MPEG Layer-3 audio coding technology licensed from Fraunhofer IIS and Thomson.

Accessories

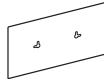
Please confirm that the following accessories are included.

 <p>Remote control × 1</p>	 <p>“AA” size batteries (UM/SUM-3, R6, HP-7 or similar) × 2</p>
 <p>FM aerial × 1</p>	 <p>USB cable × 1</p>
 <p>HDMI cable × 1</p>	

 <p>Cleaning cloth × 1</p>	 <p>Subwoofer wire × 1</p>		
 <p>Stands × 2</p>  <p>Special screws × 4</p>  <p>Flush screws × 2</p>		 <p>Stand covers × 2</p>  <p>Pattern paper × 1</p>	 <p>Deco back covers × 2</p>  <p>Speaker wires × 2</p>
<p>CP-DV40H</p>			
 <p>Screws × 4</p>		 <p>Washer screws × 6</p>	
<p>CP-DV50H</p>			

Contents

	Page		Page
■ General Information		■ CD, CD-R and CD-RW Operation	
Precautions	5	Listening to a CD or MP3/WMA disc	46
Controls and indicators	6 - 10	Advanced CD or MP3/WMA disc playback	47
Description of discs	11 - 12	DivX and JPEG disc operation	
■ Preparation for Use		Playback on the DivX and JPEG menu screen.	48
System installation	13	Zoom function	49
System connections	14 - 19	Rotating a picture	49
Connecting to a conventional TV/monitor	20	■ USB Memory Playback	
Audio connection to other equipment	21	Playback on USB memory device	50
Remote control	22	To remove USB memory device	50 - 51
Changing the set up menu	23 - 29	Advanced USB playback	51 - 52
■ Basic Operation		■ Radio Operation	
General control	30	Listening to the radio	52 - 53
Setting the clock (Remote Control only).	31	■ Advanced Features	
Enjoying surround sound (sound mode)	32 - 35	Using the Radio Data System (RDS)	54 - 58
■ DVD Operation		Timer and sleep operation (Remote Control only).	59 - 62
Playing a disc		Headphone connection	62
Playback	36 - 37	■ References	
Various disc functions	37 - 38	Troubleshooting chart	63 - 65
To resume playback after stopping (resume play)	38	Maintenance	65
DVD mode operation indicators	38	Specifications	66 - 67
Basic operation			
To locate the beginning of a chapter track (skip)	39		
Fast forward/Fast reverse (search)	39		
To start playback from the desired point (direct play)	40		
Useful operation			
Still picture/Frame advance	41		
Slow motion play.	41		
To change the angle	42		
To zoom images (zoom)	42		
To play the contents between the specified points repeatedly (A-B repeat)	42		
To select a subtitle or audio language from the disc menu	42		

Precautions

■ General

- Please ensure that the equipment is positioned in a well-ventilated area and ensure that there is at least 10 cm (4") of free space along the sides, top and back of the equipment.

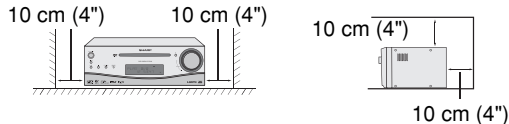

- Do not place subwoofer system on the same surface as main unit to prevent sound interruption during playback.
- Use the unit on a firm, level surface free from vibration.
- Keep the unit away from direct sunlight, strong magnetic fields, excessive dust, humidity and electronic/electrical equipment (home computers, facsimiles, etc.) which generate electrical noise.
- Do not place anything on top of the unit.
- Do not expose the unit to moisture, to temperatures higher than 60°C (140°F) or to extremely low temperatures.
- If your system does not work properly, disconnect the AC power lead from the wall socket. Plug the AC power lead back in, and then turn on your system.
- In case of an electrical storm, unplug the unit for safety.
- Hold the AC power plug by the head when removing it from the wall socket, as pulling the lead can damage internal wires.
- The AC power plug is used as a disconnect device and shall always remain readily operable.
- **Do not remove the outer cover, as this may result in electric shock. Refer internal service to your local SHARP service facility.**
- The ventilation should not be impeded by covering the ventilation openings with items, such as newspapers, tablecloths, curtains, etc.

- No naked flame sources, such as lighted candles, should be placed on the apparatus.
- Attention should be drawn to the environmental aspects of battery disposal.
- This unit should only be used within the range of 5°C - 35°C (41°F - 95°F).
- The apparatus is designed for use in moderate climates.

Warning:

The voltage used must be the same as that specified on this unit. Using this product with a higher voltage other than that which is specified is dangerous and may result in a fire or other type of accident causing damage. SHARP will not be held responsible for any damage resulting from use of this unit with a voltage other than that which is specified.

■ Cooling fan

This unit is fitted with a cooling fan at the rear for improved cooling. Do not cover the opening in this section with any obstacles.

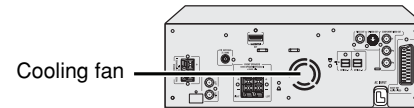

Caution:

The unit will get warm whilst being used. Do not touch the warm areas of the unit for prolonged periods to avoid injury.

■ Volume control

The sound level at a given volume setting depends on speaker efficiency, location, and various other factors. It is advisable to avoid exposure to high volume levels. Do not turn the volume on to full at switch on. Listen to music at moderate levels. Excessive sound pressure from earphones and headphones can cause hearing loss.

Controls and indicators

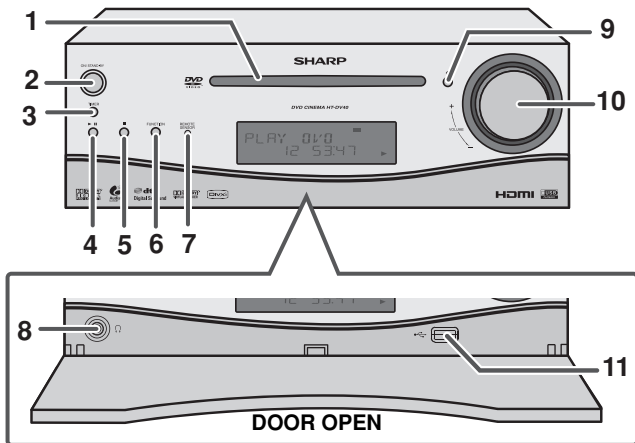

■ Front panel

	Reference page
1. CD Compartment	36
2. On/Stand-by Button	30, 36, 43, 52, 61, 64
3. Timer Indicator	60
4. DVD/CD/USB Play/Pause Button	37, 41, 46, 50
5. Disc or USB Stop Button	37, 50
6. Function Button	30
7. Remote Sensor	22
8. Headphone Socket	62
9. Disc Eject Button	37
10. Volume Control	30
11. USB Terminal	50

■ Rear panel

	Reference page
1. HDMI Socket	20
2. FM 75 Ohms Aerial Socket	19
3. Subwoofer Terminals	14, 15, 19
4. Auxiliary Input Sockets	21
5. Front Speaker Terminals	14, 15
6. Cooling Fan	5
7. Optical Digital Input 1 Socket	21
8. Optical Digital Input 2 Socket	21
9. Video Output Socket	20
10. S-Video Output Socket	20
11. Component Video Out Sockets	20
12. SCART Output Socket (Audio + Video)	20
13. AC Power Lead	19

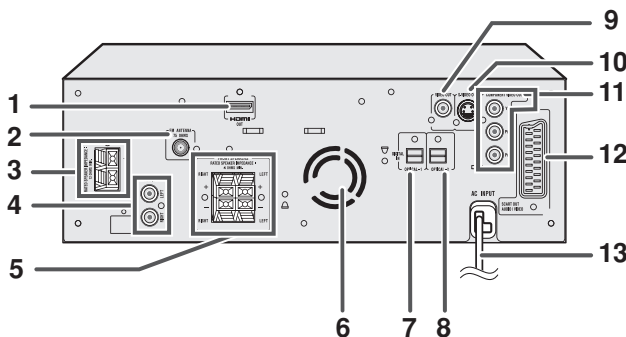

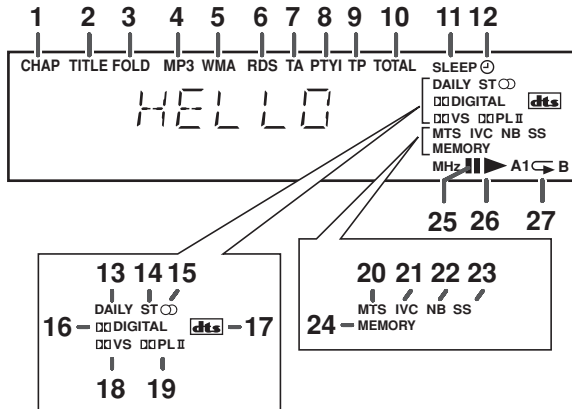

■ Display

Reference page

1. Chapter Indicator	44
2. Title Indicator	44
3. Folder Indicator	48
4. MP3 Indicator	45
5. WMA Indicator	46
6. RDS Indicator	54
7. Traffic Announcement Indicator	54
8. Dynamic PTY Indicator	54
9. Traffic Programme Indicator	54
10. Total Indicator	38
11. Sleep Indicator	62
12. Timer Play Indicator	60
13. Daily Timer Indicator	60
14. FM Stereo Mode Indicator	53
15. FM Stereo Receiving Indicator	53
16. Dolby Digital Signal Indicator	45
17. DTS Indicator	25
18. Dolby Virtual Speaker Indicator	34
19. Dolby Pro Logic II Indicator	34
20. Mono to Stereo Indicator	35
21. Intelligent Volume Indicator	35
22. Natural Bass Indicator	35
23. Sound Space Indicator	35
24. Memory Indicator	43
25. Disc or USB Pause Indicator	37
26. Disc or USB Play Indicator	36
27. Disc or USB Repeat Indicator	44, 51

Controls and indicators (continued)

CP-DV40H

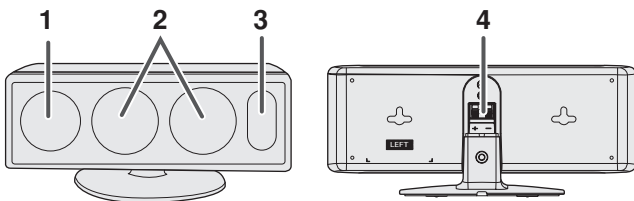

■ Speaker system (CP-DV40H)

1. Tweeter
2. Woofers
3. Bass Reflex Duct
4. Speaker Terminals

Speaker grilles are removable:
Make sure nothing comes into contact with the speaker diaphragms when you remove the speaker grilles.

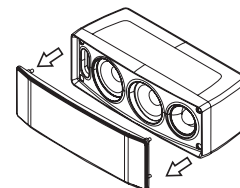

CP-DV50H

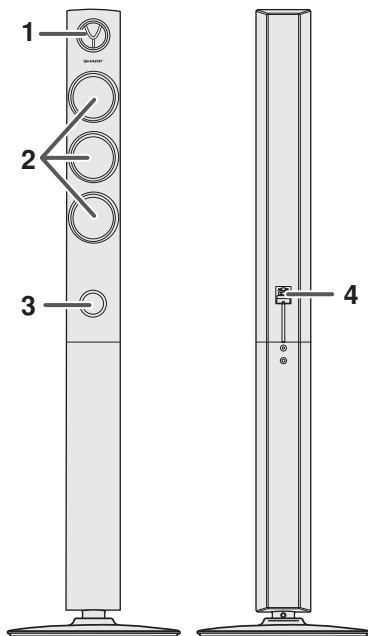

■ Speaker system (CP-DV50H)

1. Tweeter
2. Woofers
3. Bass Reflex Duct
4. Speaker Terminals

Speaker grilles are not removable.

■ Subwoofer (CP-SW40H)

1. Subwoofer
2. Bass Reflex Duct
3. Speaker Terminals

Subwoofer grilles are not removable.

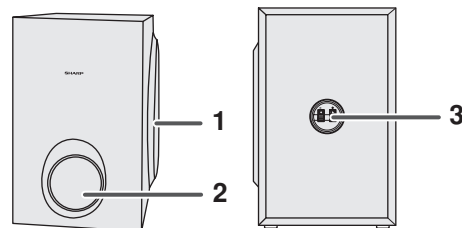

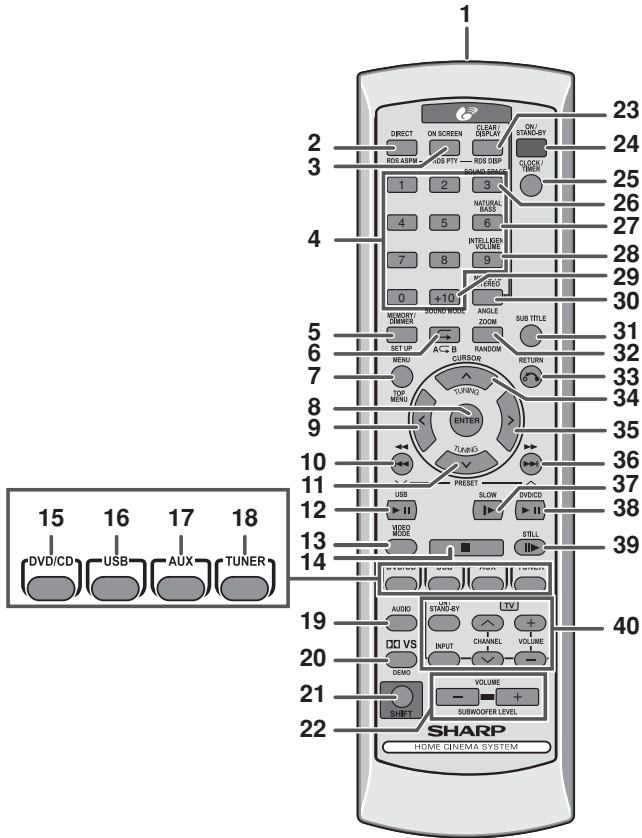

■ Remote control

Reference page

1. Remote Control Transmitter	22
2. DVD Direct Button	40
3. DVD On Screen Button	44
4. Direct Search Buttons	29, 40, 43, 47, 48
5. Memory or Dimmer Button	30, 31, 43, 53, 55, 59, 61
6. DVD/CD/MP3/WMA Repeat Button	44, 51
7. Menu Button	42
8. Enter Button	23, 29, 36, 40, 42, 43, 48, 50
9. Cursor Left Button	23, 36, 40, 42, 43, 48, 49, 50
10. DVD Chapter Skip/DVD/MP3/WMA Fast Reverse/CD/MP3/WMA Track Down/Tuner Preset Down and Time Down Button	31, 37, 39, 53, 55, 56, 59, 61
11. Tuning Down or Cursor Down Button	23, 36, 42, 43, 49, 52
12. USB Play or Pause Button	50
13. Video Mode Button	27
14. DVD/CD/MP3/WMA/Stop Button	37, 47
15. DVD/CD/MP3/WMA Button	36
16. USB Button	50, 60
17. Auxiliary Button	21
18. Tuner Button	52, 55, 56
19. Audio Button	12, 45
20. Dolby Virtual Speaker Button	33
21. Shift Button	19, 23, 30, 33, 34, 42, 47, 51, 55, 56
22. Volume Up or Down Buttons	30
23. Clear or Display Button	44, 53, 55
24. On/Stand-by Button	22, 23, 30, 31, 36, 52, 53, 55, 59, 64
25. Clock or Timer Button	31, 59, 61
30. DVD Angle Button	12, 42
31. DVD Subtitle Button	12, 45
32. DVD Zoom Button	42, 49
33. Return Button	36
34. Tuning Up or Cursor Up Button	23, 36, 42, 43, 49, 52





Controls and indicators (continued)

35. Cursor Right Button	23, 36, 40, 42, 43, 48, 49, 50
36. DVD Chapter Skip/DVD/MP3/WMA Fast Forward/CD/MP3/ WMA Track Up/Tuner Preset Up and Time Up Button	31, 37, 39, 53, 55, 56, 61
37. DVD Slow Button	41
38. DVD/CD/MP3/WMA Play or Pause Button	37, 41
39. DVD/CD/MP3/WMA Still Button	41
40. TV Operation Buttons	10

■ Remote control with shift button

	Reference page
2. RDS ASPM Button	55
3. RDS PTY Button	56
5. Set Up Button	23
6. A-B Repeat Button	42
7. Top Menu Button	42
20. Demo Button	19
22. Subwoofer level - or + Button	30
23. RDS DISP Button	54
26. Sound Space Button	33, 34, 35
27. Natural Bass Button	33, 34, 35
28. Intelligent Volume Button	33, 34, 35
29. Sound Mode Button	33
30. Mono to Stereo Button	33, 34, 35
32. Random Button	47, 51

TV Operation Buttons (Only SHARP TV):

On/Stand-by Button 	Set the TV power to "ON" or "STAND-BY".	Input Select Button (TV) 	Press the button to switch the input source.
Volume Up and Down Buttons 	Turn up/down the TV volume.	Channel Up and Down Buttons 	Switch up/down the TV channels.

Note:

Some models of SHARP TV may not be operable.

Description of discs

Types of playable discs

The DVD player can play back discs bearing any of the following marks:

Disc type	Disc contents
DVD Video Disc 	Audio and video (movies)
DVD-R  Disc recorded in Video Mode (*1)(*2)	Audio and video (movies)
DVD-RW  Disc recorded in Video Mode (*2)	Audio and video (movies)
Audio CD 	Audio
CD-R/CD-RW (*1)(*2)  Or CD-R/CD-RW recorded in JPEG format (*3) (*4)	Audio and picture
DivX® Video disc (Ver 6 and below) 	Audio and video (movies)

(*1): Playability depends on recording device or disc condition (special disc, scratches, dirt or dirt on pick up).

(*2): The DVD-R/DVD-RW/CD-R/CD-RW may not be played back properly depending on the recording equipment or the disc.

(*3): JPEG or JPG picture discs are also playable on this unit. However, pictures may not be clear (depends on resolution and recording method).

(*4): If the file size is larger than 10 Mb, it will take some time for the file to be displayed.

- For unplayable discs, see page 12.

Types of playable DVD discs vary depending on the region. This unit can play back only DVDs with the same region number written on the back of the unit.

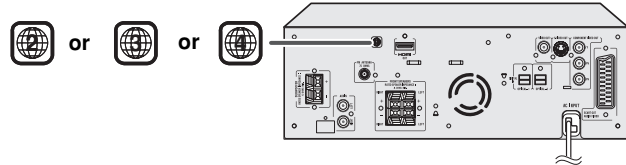

Icons used in this operation manual

Some functions may not be available depending on discs. The following icons indicate the discs that can be used in the section.

-  ... Indicates DVDs.
-  ... Indicates audio CDs.
-  ... Indicates CD-R/RW with MP3 recording.
-  ... Indicates CD-R/RW with WMA recording.
-  ... Indicates CD-R/RW with JPEG recording.
-  ... Indicates CD-R/RW with DivX® recording.

- Some operations may not be performed depending on discs even if they are described in this manual.
- During operation, "INVALID KEY" may be displayed on the screen. This means that the operations described in this manual are prohibited by the disc.

Description of discs (continued)

■ Discs that cannot be played

- DVDs without the region number on the back of the unit.
- DVDs with SECAM system
- DVD-ROM
- DVD-RAM
- DVD-Audio
- CDG
- CDV
- Photo CD
- CD-ROM
- SACD
- Discs recorded in special formats, etc.
- DVD+R
- DVD+RW

- The discs above cannot be played at all, or no sound is heard although images appear on the screen or vice versa.
 - Incorrect operation may damage the speakers and can have an adverse effect on your hearing when played at high volume settings.
 - You cannot play illegally produced discs.
- Notes:**
- A disc which has scratches or fingerprints may not play properly. Refer to "Care of compact discs" (page 65) and clean the disc.
 - Do not play discs of special shapes (heart or octagon shaped) as they can be ejected whilst rotating and cause injury.

■ Title, chapter and track

DVDs are divided into "titles" and "chapters". If the disc has more than one movie on it, each movie is a separate "title". "Chapters" are subdivisions of titles.

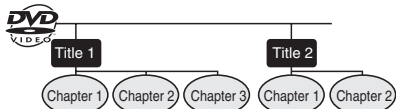

Audio CDs consist of "tracks".
A "track" is each tune on an audio CD.

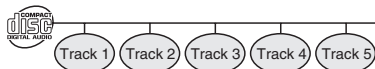

Note:

Title, chapter, or track numbers may not be recorded on some discs.

■ DivX®

- Official DivX Certified™ product
- Plays all versions of DivX® video (including DivX® 6) with standard playback of DivX® media files (DivX version cannot be upgraded on this product.)



■ Icons used on DVD discs

Check the icons on the DVD case before playing your discs.

Display	Description
	DVD discs are programmed with region numbers indicating countries in which they can be played. This system can play discs with region number on the back of the unit.
	To adopt the video format to the connected TVs ("wide-screen TV" or "4:3 size TV").
	Recorded in 4:3.
	You can enjoy wide images on a wide-screen TV and letterbox size images on the 4:3 size TV.
	You can enjoy wide images on a wide-screen TV and 4:3 images with the side edges cut on the 4:3 size TV.
	Recorded subtitle languages. Language can be selected with the SUBTITLE button.
	Number of angles recorded on the DVD. Angles can be selected with the ANGLE button.
	The number of audio tracks and audio recording systems are indicated. ● The audio recorded on the DVD can be switched by using the AUDIO button. ● The number of audio tracks and recording systems vary depending on the DVD. Check them in the DVD's manual.

HT-DV40H

Installation image:

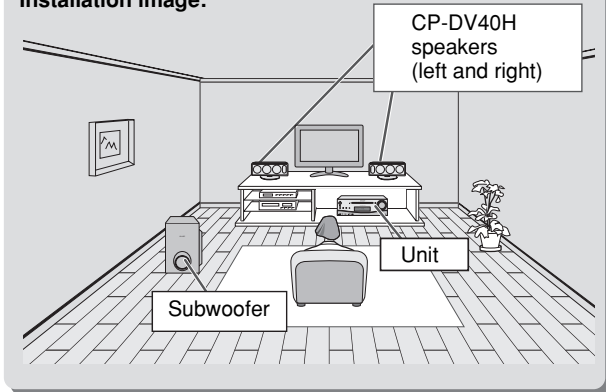

■ Magnetically shielded speakers

The speakers can be placed beside or near the TV as they are magnetically shielded. However, uneven colours may appear on the screen depending on the type of TV.

If colour variation occurs:

Turn off the TV (from the power switch). After 15 - 30 minutes, turn the TV on again.

If the colour variation is still present:

Move the speakers further away from the TV. Refer to the operation manual of the TV for details.

Note:

The speakers and subwoofer are magnetically shielded.

HT-DV50H

Installation image:

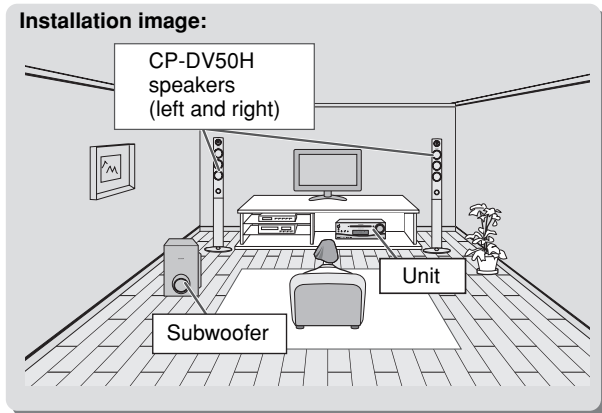

System connections

Make sure to unplug the AC power lead before making any connections.

HT-DV40H

Preparation for Use

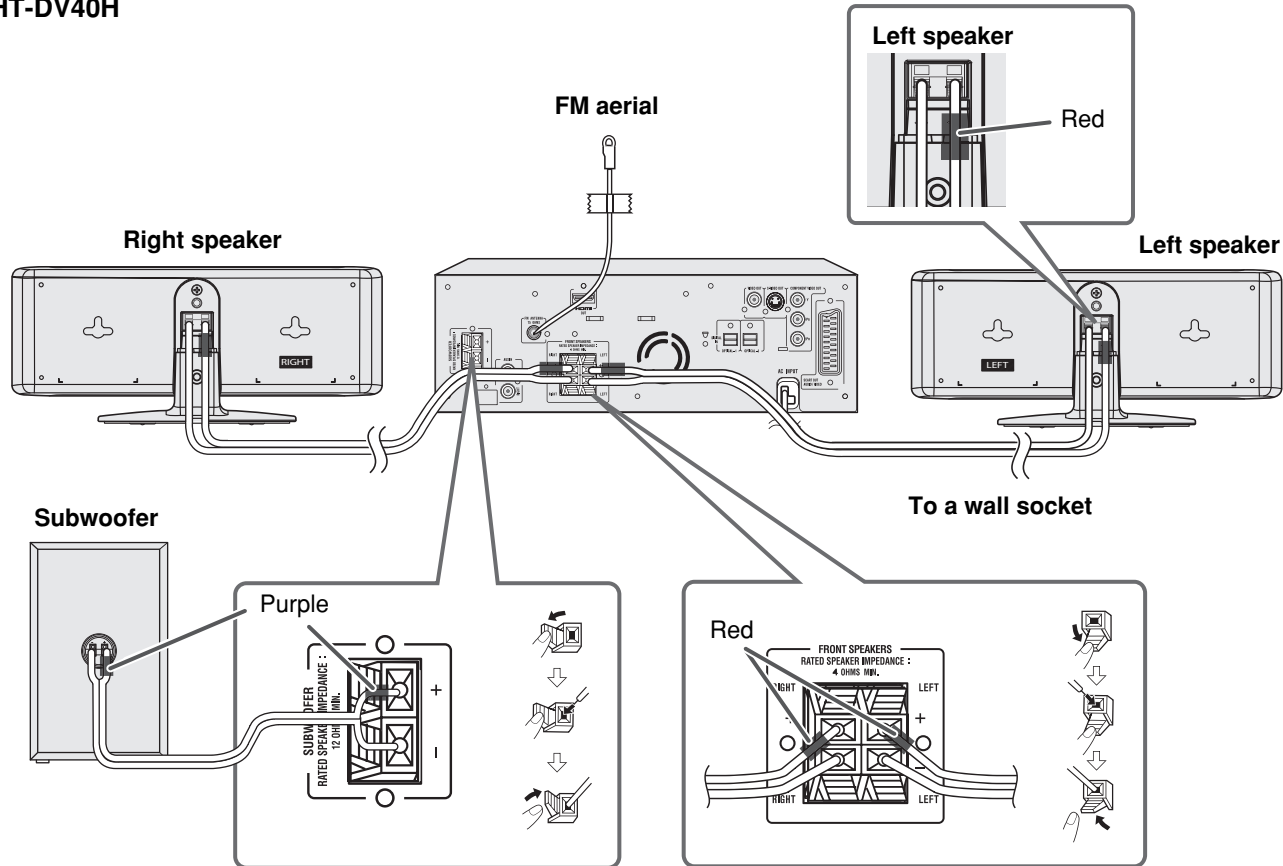

HT-DV50H

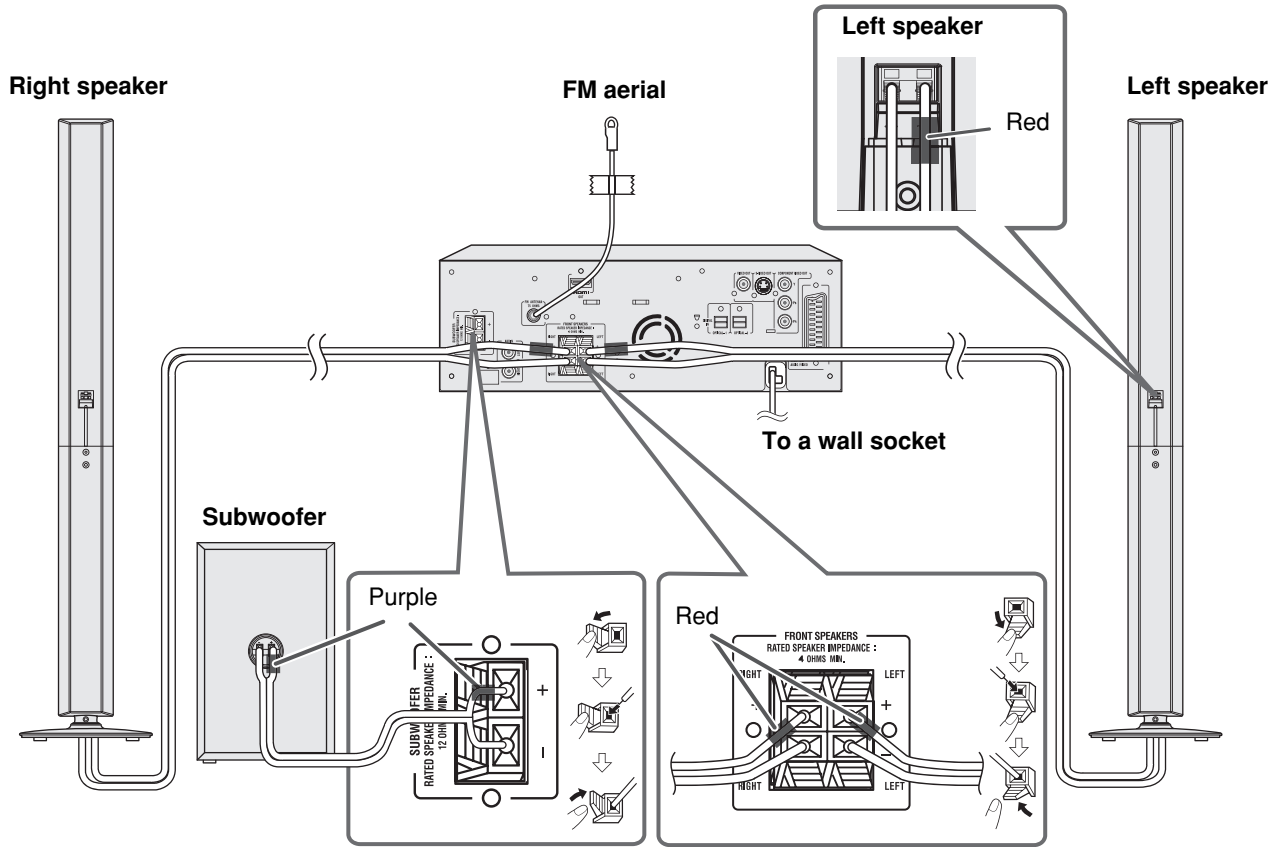

Preparation for Use

System connections (continued)

Make sure to leave the AC power lead disconnected when connecting the speakers.

To prevent accidental short circuits between + and - terminals, connect the speaker wires to the speakers first, then to the unit.

■ CP-DV40H

To install the speaker stand

- 1 Align the hole on the speaker stand to the hole on speaker. Fix them securely with the special screw provided.

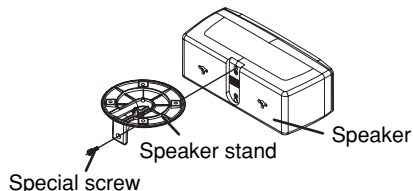

- 2 Route the speaker wire through the speaker stand hole. Connect the wire without insulation tube to the speaker minus (-) terminal, and the wire with red insulation tube to the speaker plus (+) terminal.

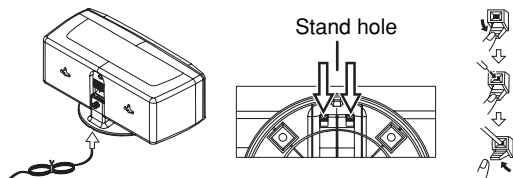

- 3 Connect the other end to the main unit.
- 4 Attach the stand cover.

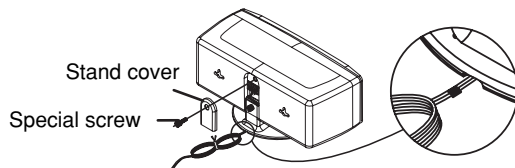

To mount the speakers on the wall

Caution:

- Be very careful to prevent the speaker [2.1kg (4.6 lbs.)] from falling when mounting on the wall.
- Before mounting, check the wall strength. (Do not put on the veneer plaster or whitewashed wall. The speakers may fall.) If unsure, consult a qualified service technician.
- Mounting screws are not supplied. Use appropriate ones.
- Check all mounting screws for looseness and that they are engaged in the speakers.
- Mount the speakers on the wall using 2 screws each for horizontal position and using 1 screw each for vertical position.
- Select a good location. If not, accidents may occur or the speaker may get damaged.
- Avoid placing on a bed, sofa, water tank, sink and hallway wall.
- To avoid accidents, fix the speaker wires to the wall. You may trip over them.
- SHARP is not responsible for accidents resulting from improper installation.

■ Driving screws

SHARP designed the speakers so you may hang them on the wall. Use proper screws (not supplied). See below for size and type.

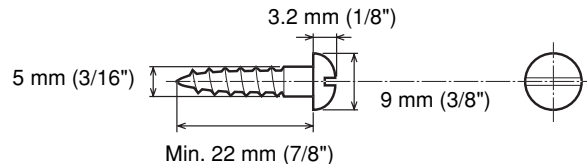

- 1 Horizontal position** : Fix the pattern paper and fix two screws into the wall with a distance of 160 mm (6-5/16") in between.
- Vertical position** : Fix the pattern paper and screws into the wall.

(Horizontal position)

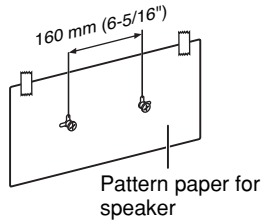

(Vertical position)

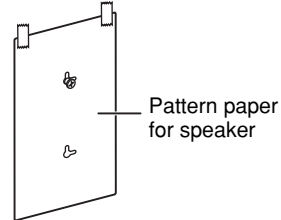

- 2 Make a hole in the wall using a drill.**

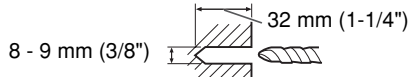

- 3 Fix a wall mount plug into the hole using a hammer, until it is flush with the wall surface.**

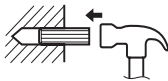

- 4 Fix screws into the wall for the speaker, as shown in the illustration.**

- Make sure that the screw and the wall can support a load of 20 kg (45 lbs).
- Fix the screws, so the screw head extends about 5.5 mm (7/32") from the wall.

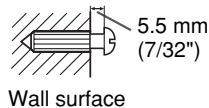
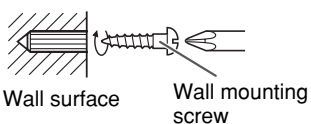

■ Installing the speakers

- 1 Align the deco back cover to the hole on the speaker. Fix them securely with the flush screw.**

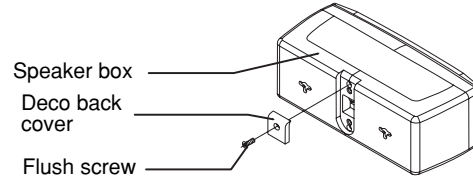

- 2 Tighten the screws and remove the paper. Hook the speaker on the screw heads and make sure it is properly secured.**

(Horizontal position)

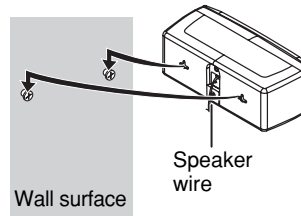

(Vertical position)

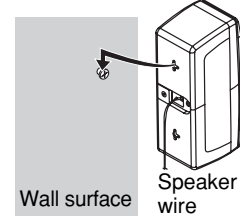

System connections (continued)

■ CP-DV50H

- 1 Route the speaker wire through a stand hole and attach the bottom cabinet to stand.
- 2 Fix them securely with the supplied 3 washer screws.

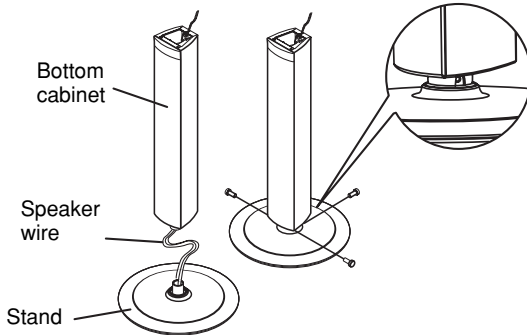

- 3 Attach the top cabinet to bottom cabinet and fix them securely with the supplied 2 screws.

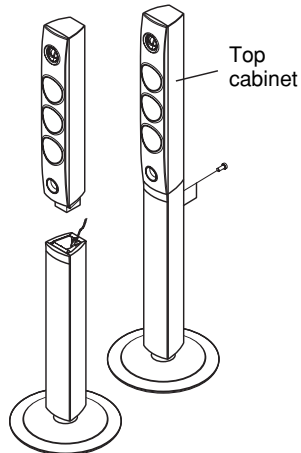

- 4 Connect the wire without insulation tube to the speakers minus (-) terminal, and the wire with red insulation tube to the speakers plus (+) terminal.

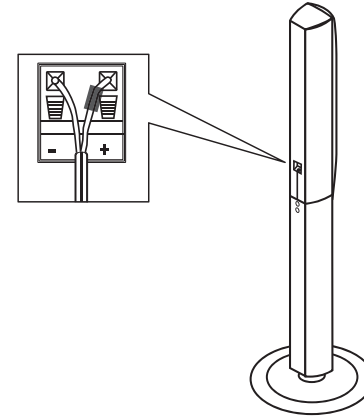

- 5 Connect the other end of speaker wire to the main unit.

Warning:

- Fix the speaker stand properly according to this manual. Improper fixing may cause speaker to fall leading to injury or breakage.
- To ensure a proper fixing, contact your dealer or installer.
- During fixing, be careful not to pinch your fingers.
- Do not modify or change the stand. It may cause the speaker to fall leading to injury or breakage.

■ Subwoofer

- 1 Connect the wire without insulation tube to the SUBWOOFER minus (-) terminal, and the wire with purple insulation tube to the SUBWOOFER plus (+) terminal.

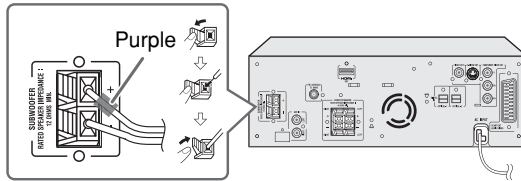

Caution:

- Never mistake the FRONT SPEAKERS and the SUBWOOFER terminals. The unit or the speakers may be damaged.
- If you use other speakers with an impedance lower than that specified, the unit may be damaged. Front speakers: 4 ohms, Subwoofer: 12 ohms.
- Do not mistake the right and the left channels. The right speaker is the one on the right side when you face the unit.
- **Do not let the bare speaker wires touch each other.**
- Do not allow any objects to fall into or to be placed in the bass reflex duct.
- Do not stand or sit on the subwoofer/speakers. You may be injured.

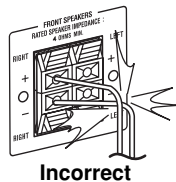

■ Aerial connection

Supplied FM aerial:

Connect the FM aerial wire to the FM 75 OHMS socket and position the FM aerial wire in the direction where the strongest signal can be received.

Note:

Placing the aerial on the unit or near the AC power lead may cause noise pickup. Place the aerial away from the unit for better reception.



■ External FM aerial

Use an external FM aerial if you require better reception. Consult your dealer.

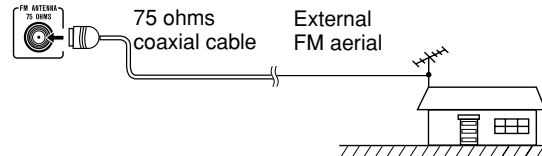

Note:

When an external FM aerial is used, disconnect the supplied FM aerial wire.

■ AC power connection

After checking all the connections have been made correctly, plug the AC power lead of this unit into the wall socket. If you plug in the unit first, the unit will enter the stand-by mode.

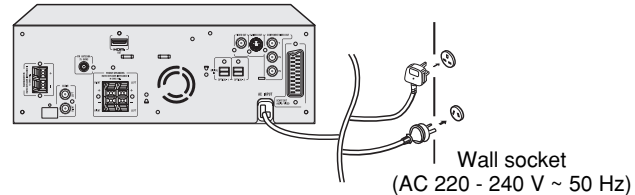

Note:

Unplug the AC power lead from the wall socket if the unit will not be in use for a prolonged period of time.

■ Demonstration mode

The first time the unit is plugged in, the unit will enter the demonstration mode. You will see words scroll.

To cancel the demonstration mode:

When the unit is in the power stand-by mode (demonstration mode), press the SHIFT and DEMO buttons on the remote control. The unit will enter the low power consumption mode.

To return to the demonstration mode:

When the unit is in the power stand-by mode, press the SHIFT and DEMO buttons on the remote control again.

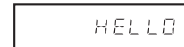

Connecting to a conventional TV/monitor

Caution:

Turn off all other equipment before making connections.

- If the TV/monitor has video input, connect it to the VIDEO OUT socket on the rear of the unit.

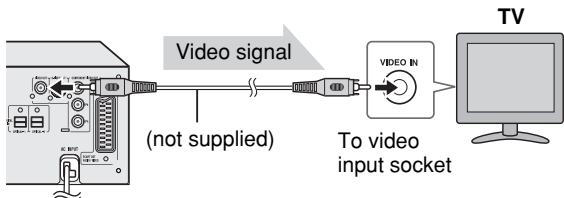

- If the TV/monitor has S-video input, connect it to the S-VIDEO OUT socket on the rear of the unit.

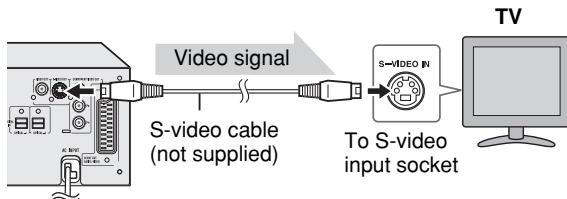

- If the TV/monitor has component video input, connect it to the COMPONENT VIDEO OUT socket on the rear of the unit.

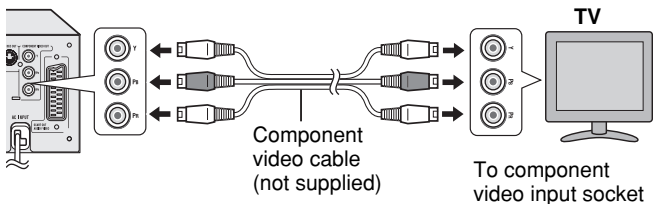

Notes:

- Change the TV input in accordance with the connected socket.
- Do not connect other equipment between the TV and this unit. If they are connected via a VCR, pictures may be distorted.
- If your TV has different indications for the component video inputs (Y, CB and CR or Y, B-Y and P-Y), connect sockets with its matching colour.
- Do not connect to a component video input socket designed for the high-vision system, which is not DVD-compatible (the images may be distorted or not appear).

- If the TV/monitor has scart input, connect it to the SCART OUT socket on the rear of the unit. (Do not connect the SCART cable to equipment other than the TV/monitor)

- To select SCART function:
- On main unit: Press FUNCTION button repeatedly until SCART is displayed.
- On remote control: Press AUX button repeatedly until SCART is displayed.

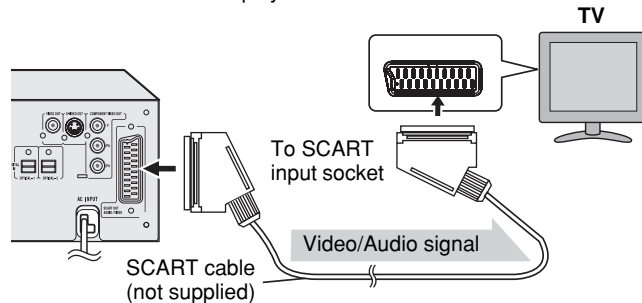

- If the TV/monitor has HDMI input, connect it to the HDMI socket on the rear of the unit.

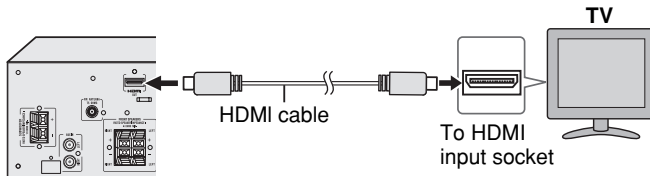

Audio connection to other equipment

You can hear the sound of other equipment via this product. Connect the DVD player, VCR or digital tuner to a TV directly to receive the images (refer to the operation manual of each equipment).

Caution:

Turn off the other equipment before making this connection.

■ **Connection for the analogue sound (VCR, etc.)**

To select AUX function:

- On main unit: Press FUNCTION button repeatedly until AUX is displayed.
- On remote control: Press AUX button repeatedly until AUX is displayed.

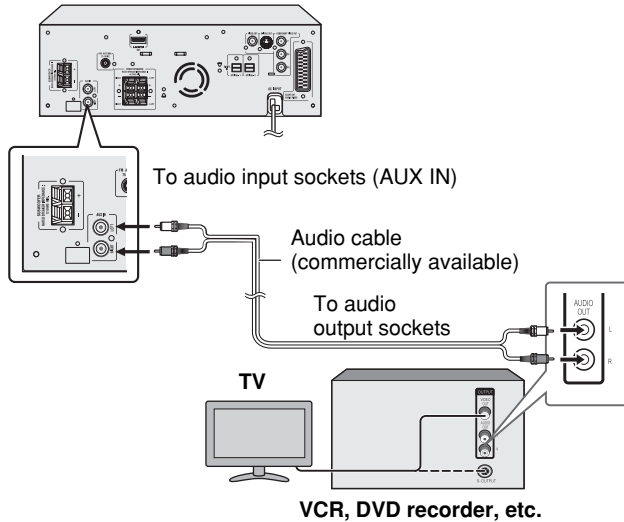

■ **Connection for the digital tuner sound (or other optical digital equipment such as an MD player)**

If the digital equipment has an optical output socket, you can enjoy better sound by connecting it to the optical digital input socket of the main unit using the optical digital cable.

To select OPTICAL 1 or OPTICAL 2 function:

- On main unit: Press FUNCTION button repeatedly until OPTICAL 1 or OPTICAL 2 is displayed.
- On remote control: Press AUX button repeatedly until OPTICAL 1 or OPTICAL 2 is displayed.

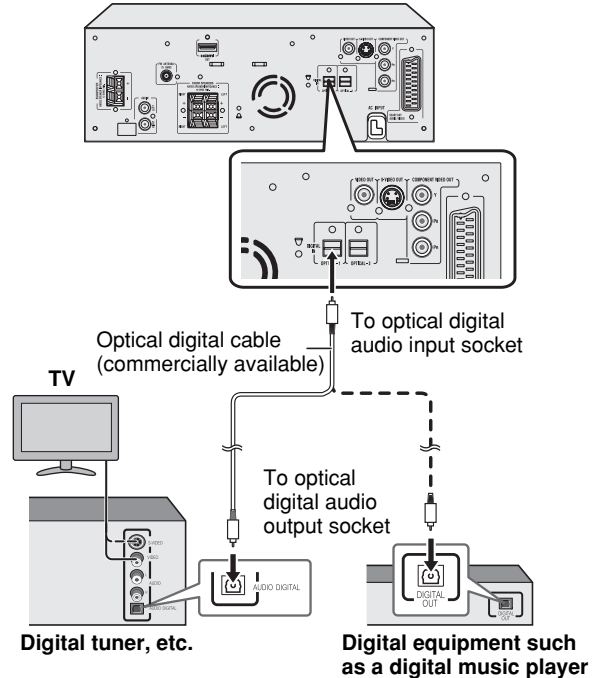

Remote control

■ Battery installation

- 1 **Open the battery cover.**
- 2 **Insert the supplied batteries according to the direction indicated in the battery compartment.**

When inserting or removing the batteries, push them towards the ⊖ battery terminals.

- 3 **Close the cover.**

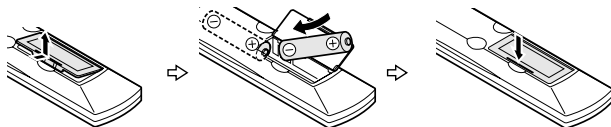

Precautions for battery use:

- Replace all old batteries with new ones at the same time.
- Do not mix old and new batteries.
- Remove the batteries if the unit will not be used for long periods of time. This will prevent potential damage due to battery leakage.

Caution:

- Do not use rechargeable batteries (nickel-cadmium battery, etc.).
- Installing the batteries incorrectly may cause the unit to malfunction.
- Batteries (battery packed or batteries installed) shall not be exposed to excessive heat such as sunshine, fire or the like.

Battery removal:

Open the battery cover and pull up the battery to take out.

Notes concerning use:

- Replace the batteries if the operating distance is reduced or if the operation becomes erratic. Purchase 2 "AA" size batteries (UM/SUM-3, R6, HP-7 or similar).
- Periodically clean the transmitter on the remote control and the sensor on the unit with a soft cloth.
- Exposing the sensor on the unit to strong light may interfere with operation. Change the lighting or the direction of the unit if this occurs.
- Keep the remote control away from moisture, heat, shock, and vibrations.

■ Test of the remote control

After installing the unit (see pages 13 - 21), check that the remote control operates correctly.

Point the remote control directly at the remote sensor on the unit.

The remote control can be used within the range shown below: Press the ON/STAND-BY button. Does the power turn on? Now, you can use the unit.

Remote sensor

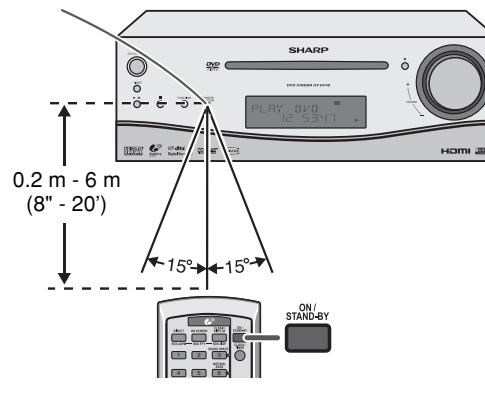

Changing the set up menu

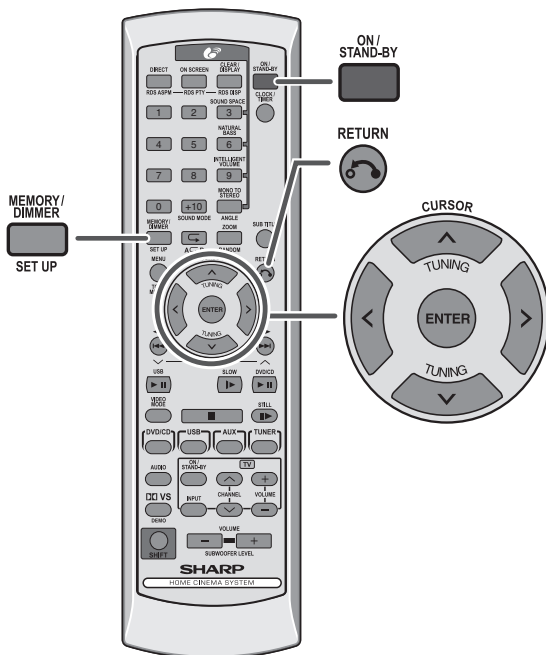

- 1 Turn on the TV.**
- 2 Set the TV to the correct input, eg. "AV1", "VIDEO", etc.**
- 3 Turn on the unit by pressing the ON/STAND-BY button.**
 - The SHARP startup screen appears.

Note:
Startup screen will be displayed when both S-Video cable and SCART cable are connected to the TV. If only the S-Video cable is connected, the screen may be blank. To set up S-Video mode, use video out cable or SCART cable.

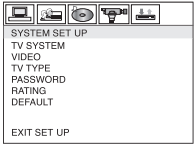
- 4 Press the SHIFT and SET UP buttons.**

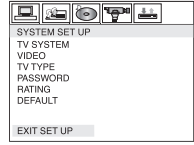



SYSTEM SET UP
TV SYSTEM
VIDEO
TV TYPE
PASSWORD
RATING
DEFAULT
EXIT SET UP
- 5 Press the < or > button to select a menu.**
 - See the list on pages 24 - 29 for set up menu.
- 6 Press the ^, v, < or > button to change the setting and press the ENTER button.**
- 7 After setting is completed, select "EXIT SET UP", then press the ENTER button to return to the main page.**

SYSTEM SET UP
TV SYSTEM
VIDEO
TV TYPE
PASSWORD
RATING
DEFAULT
EXIT SET UP

Notes:

- The setting are stored even if the unit is set to stand-by mode.
- The backup function protects the stored setting for a few hours should there be a power failure or AC power lead disconnection.
- System set up can be performed during playback mode.

Changing the set up menu (continued)

Set up menu	Selectable parameters (* indicates default setting)	Description
SYSTEM SET UP  SYSTEM SET UP TV SYSTEM VIDEO TV TYPE PASSWORD RATING DEFAULT EXIT SET UP	TV SYSTEM NTSC PAL* AUTO	Select the correct colour system (TV standard). (for details, see page 28)
	VIDEO S-VIDEO SCART* COMP. P-SCAN ON COMP. P-SCAN OFF	Select "S-VIDEO or SCART or COMP. P-SCAN ON or COMP. P-SCAN OFF" mode if connecting unit to TV (for details, see page 20). Selection can also be made using remote control VIDEO MODE button.
	TV TYPE 4:3 PS* 4:3 LB 16:9	The screen mode should be set according to the connected TV type (for details, see page 28).
	PASSWORD - - - - 	Change the password (for details, see page 29).
	RATING 1 KID SAFE 2 G 3 PG 4 PG-13 5 PG-R 6 R 7 NC-17 8 ADULT*	Set a restriction level for DVD viewing (for details, see page 29). Enter a 4-digit password. It is set to 0000 by default.
	DEFAULT RESTORE	This resets all settings, except for PARENTAL to the factory defaults.
LANGUAGE SET UP  LANGUAGE SET UP OSD LANGUAGE AUDIO LANG SUBTITLE LANG MENU LANG DivX [R] VOD EXIT SET UP	OSD LANGUAGE ENGLISH* FRENCH SPANISH CHINESE GERMAN ITALIAN PORTUGUESE DUTCH	You can select the desired OSD (On Screen Display) language for the set up menu or playback control screen. Example: To select German language, choose "GERMAN" from the menu. Press ENTER button and below screen will appear in German.

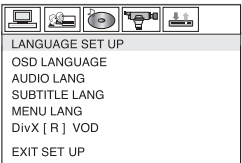
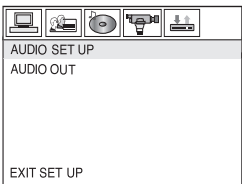

Set up menu	Selectable parameters (* indicates default setting)	Description	
LANGUAGE SET UP 	AUDIO LANG	ENGLISH* FRENCH SPANISH CHINESE GERMAN ITALIAN	Select the language audible from the speakers.
	SUBTITLE LANG	ENGLISH* FRENCH SPANISH CHINESE GERMAN ITALIAN OFF	Select the subtitle displayed on the TV screen.
	MENU LANG	ENGLISH* FRENCH SPANISH CHINESE GERMAN ITALIAN	Select the disc menu language.
	DivX [R] VOD	REGISTRATION CODE * * * * *	SHARP provide you the DivX registration code that allows you to rent and purchase videos using the DivX service. Please go to www.divx.com/vod for more information.
AUDIO SET UP 	AUDIO OUT	SP DIF/OFF SP DIF/RAW SP DIF/PCM*	Useful whilst using HDMI cable. When playing a disc recorded with Dolby Digital or DTS, the corresponding digital signals will be output from the HDMI output socket. <ul style="list-style-type: none"> ● PCM : Choose this setting if the TV with HDMI technology cannot support Dolby Digital or DTS to avoid noise or mute from the TV. ● RAW : Choose this setting if the TV with HDMI technology can support Dolby Digital or DTS.

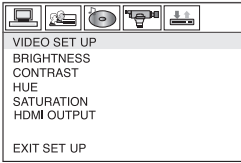
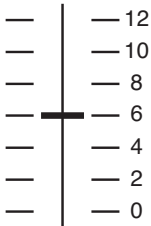
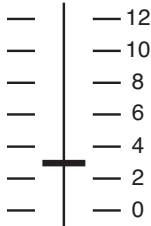
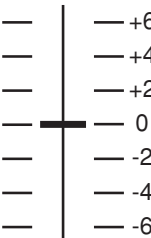

Changing the set up menu (continued)

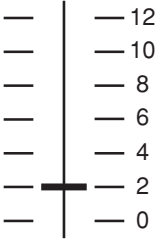
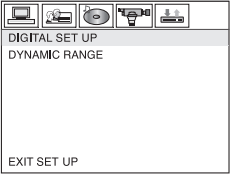
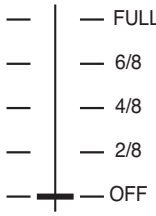
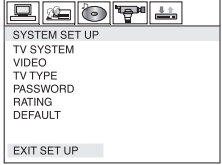
Set up menu	Selectable parameters (* indicates default setting)	Description
VIDEO SET UP 	BRIGHTNESS 	To adjust TV screen brightness level.
	CONTRAST 	To adjust TV screen contrast level.
	HUE 	To adjust TV screen hue level.

Set up menu	Selectable parameters (* indicates default setting)	Description
	<p>SATURATION</p> 	To adjust TV screen saturation level.
	<p>HDMI OUTPUT</p> <p>480P/576P 720P* 1080 I</p>	To select HDMI resolution.
DIGITAL SET UP	 <p>DYNAMIC RANGE</p> 	<p>Dynamic Range Control can be set from OFF to FULL.</p> <p>FULL : Dynamic Range Control set to maximum.</p> <p>OFF : Dynamic Range Control set to off.</p>
EXIT SET UP		The setting is completed.

Changing the set up menu (continued)

■ TV display setting

Indicator	Setting
4:3 PS	<p>When playing a wide image (16:9) disc, the left and right sides of the image are cut (pan scan) to display a natural-looking 4:3 size image. A wide image disc without pan scan [PS] is played back in 4:3 letterbox.</p> <p>A 4:3 disc is played in 4:3.</p> 
4:3 LB	<p>When playing a wide image (16:9) disc, black bands are inserted at the top and bottom and you can enjoy full wide images (16:9) on a 4:3 size TV.</p> <p>A 4:3 disc is played in 4:3.</p> 
16:9	<p>A wide image (16:9) is displayed when playing a wide image (16:9) disc.</p>  <ul style="list-style-type: none"> ●When playing a 4:3 image disc, the image size depends on the setting of the connected TV. ●If you play back a wide image (16:9) disc with this unit connected to a 4:3 TV, the vertically shrunk image is displayed.

Note:

When playing disc with a fixed video format, the display setting will not change even if the TV screen size is changed.

■ TV system setting

Indicator	Setting
NTSC	Select this mode for the NTSC TV.
PAL	Select this mode for the PAL TV.
AUTO	Select this mode for the multi-system TV.



Note:

To achieve optimal picture setting when playing back a DVD disc, ensure the setting of the main unit TV system are the same as the disc video system.

Refer pages 23 - 27 "Changing the set up menu" and follow the changing steps provided.

DVD disc type	Unit setting
NTSC	NTSC
PAL	PAL

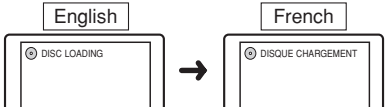
■ Language setting

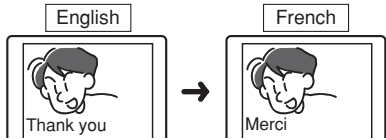
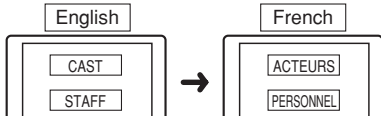
Indicator	Setting
OSD LANGUAGE	<p>A language for screen display can be set for the set up menu, message, etc.</p> 
AUDIO LANG	<p>A language for audio can be set. You can specify a language for conversation and narration.</p> 
SUBTITLE LANG	<p>A language for subtitle can be set. The subtitle are displayed in a specified language.</p> 
MENU LANG	<p>A language for disc menus can be set. Menu screens are displayed in a specified language.</p> 

■ **Rating setting**

- 1 Select "SYSTEM SET UP" on the Set up menu screen (see steps 1 - 6 on page 23).
- 2 Before setting "RATING", ensure password is unlocked "🔓". The "RATING" level cannot be set if the password is locked "🔒".
- 3 After selecting "RATING" in steps 1 - 6 on page 23, select the rating level and press the ENTER button to confirm.
- 4 After entering rating level, select "PASSWORD" to lock the password key.
- 5 Enter a 4-digit password using the Direct Search buttons and press the ENTER button.

*If this is the first time, enter "0000" as factory default password.

Indicator	Setting
1 KID SAFE	Only DVD software intended for children can be played back.
2G to 7 NC-17	Only DVD software intended for general use and children can be played back.
8 ADULT	DVD software of any grade (adult/general/children) can be played back.

* Level 8: for most restrictive viewing ==> Level 1: for general audiences viewing.

The smaller the number, the greater the level of restriction.

Note:

Whilst playing a disc with parental lock, the display may appear requesting a password in order to watch some restricted scenes. In such case, enter the password to temporarily change the parental level.

■ **Password setting**

From the set up menu, select "SYSTEM SET UP", "PASSWORD" and choose "----- 🔓".

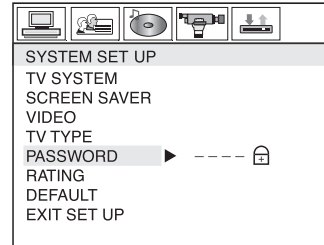

- 1 When setting the password for the first time, enter the factory default password by pressing "0000". The "🔓" will be unlocked.
- 2 Enter your new password (maximum 4-digits) using the Direct Search buttons and press ENTER button to return. The "🔒" will be locked.
- 3 Enter again the same new password and press ENTER button to return. The "🔓" will be unlocked.
- 4 To change to another password, repeat steps 2 - 3.
- 5 Exit set up.

Note:

If you forget your password, cancel the current password by pressing "0000" using the Direct Search buttons.

General control

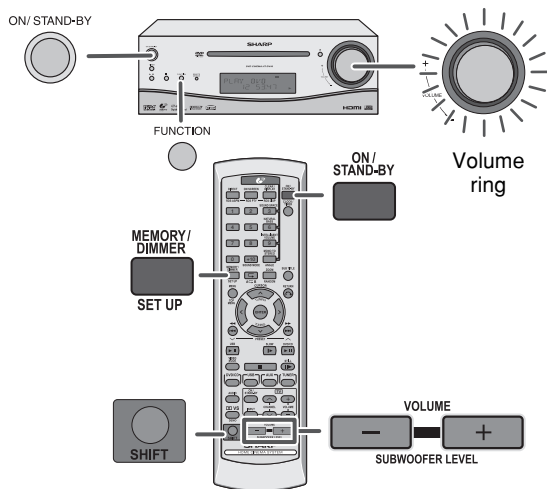

■ To turn the power on

Press the ON/STAND-BY button to turn the power on.

After use:

Press the ON/STAND-BY button to enter the power stand-by mode.

■ Illumination light control

Press the MEMORY/DIMMER button for more than 2 seconds to adjust the brightness of the display and volume ring.

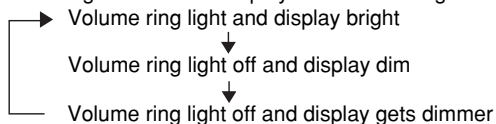

■ Auto power off function

In the stop mode of discs/USB operation, the main unit enters the stand-by mode after 15 minutes of inactivity.

■ Volume auto fade-in

- If you turn off and on the main unit with volume set to 34 or higher, the volume starts at 20 and fades in to the last set level.
- If you turn off and on the main unit with the volume level set to less than 34, the volume starts at the last level volume setting.

■ Volume control

Main unit operation:

When the VOLUME control is turned clockwise, the volume will increase. When it is turned anti-clockwise, the volume will decrease.

Remote control operation:

Press the VOLUME (+ or -) button to increase or decrease the volume.



■ Subwoofer level control

The subwoofer level can be adjusted.

To increase the level, hold down the SHIFT button and press the SUBWOOFER LEVEL + button.

To decrease the level, hold down the SHIFT button and press the SUBWOOFER LEVEL - button.

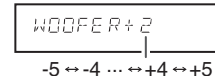

Notes:

- When sound from the subwoofer is distorted, decrease the subwoofer level.
- When changing the subwoofer level, the output level of the SUBWOOFER PRE OUT is also changed.

■ Function

When the FUNCTION button on main unit is pressed, the current function will change to different mode. Press the FUNCTION button repeatedly to select desired function.

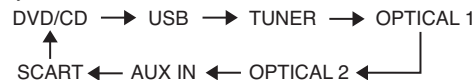

Note:

The backup function will protect the memorised function mode for a few hours should there be a power failure or the AC power lead becomes disconnected.

Setting the clock (Remote Control only)

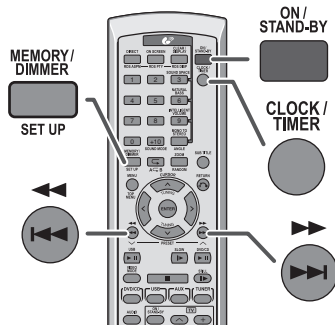

In this example, the clock is set for the 24-hour (0:00) display.

- 1 Press the ON/STAND-BY button to turn the power on.**
- 2 Press the CLOCK/TIMER button.**
- 3 Within 10 seconds, press the ◀◀ or ▶▶ button to select "CLOCK", and press the MEMORY/DIMMER button.**
- 4 Press the ◀◀ or ▶▶ button to select 24-hour or 12-hour display and then press the MEMORY/DIMMER button.**

→ "0:00" ↓ → "AM 12:00" ↓ → "AM 0:00"	→	The 24-hour display will appear. (0:00 - 23:59) The 12-hour display will appear. (AM 12:00 - PM 11:59) The 12-hour display will appear. (AM 0:00 - PM 11:59)
---	---	---

- 5 Press the ◀◀ or ▶▶ button to adjust the hour and then press the MEMORY/DIMMER button.**



Press the ◀◀ or ▶▶ button once to advance the time by 1 hour. Hold it down to advance continuously.

- 6 Press the ◀◀ or ▶▶ button to adjust the minutes and then press the MEMORY/DIMMER button.**



Press the ◀◀ or ▶▶ button once to advance the time by 1 minute. Hold it down to change the time in 5-minute intervals.

To confirm the time display:

[When the unit is in the stand-by mode]

Press the CLOCK/TIMER button.

The time display will appear for about 10 seconds.

[When the power is on]

Press the CLOCK/TIMER button.

Within 10 seconds, press the ◀◀ or ▶▶ button to display the time.

The time display will appear for about 10 seconds.

Note:

The "CLOCK" will appear or time will flash to confirm the time display when the AC power supply is restored after a power failure or unplugging the unit. If incorrect, readjust the clock as follows.

To readjust the clock:

Perform "Setting the clock" from step 1. If the "CLOCK" does not appear in step 3, step 4 (for selecting the 24-hour or 12-hour display) will be skipped.

To change the 24-hour or 12-hour display:

- 1 Clear all the programmed contents. [Refer to "Factory reset, clearing all memory" on page 64 for details.]
- 2 Perform "Setting the clock" from step 1.

Enjoying surround sound (sound mode)

■ Preset sound modes and sound image

STANDARD

You can enjoy normal stereo sounds.

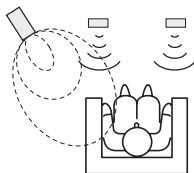

CINEMA

Enjoy a wide sound field like 5.1ch as well as enhanced powerful bass sounds.

Suitable for movies, etc.

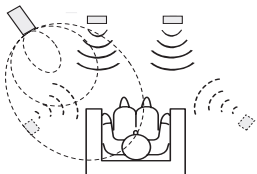

NEWS

Easy to listen to bass sounds such as voice of narration (even at low volume) due to well-controlled bass sounds.

Suitable for news, etc.

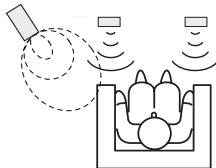

MUSIC

Enhanced bass sounds create clear-cut and spacious sounds at 2.1ch.

Appropriate for music, etc.

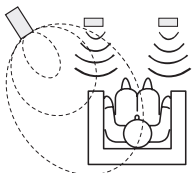

SPORT

Voice of narration comes out from the centre; you can hear cheers and feel the atmosphere in the theatre with a wide sound field like 5.1ch.

Appropriate for sports broadcasting such as baseball and football.

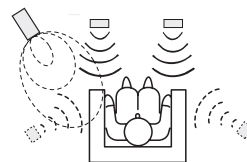

NIGHT

Words are easy to hear and loud sounds are controlled; even at low volume, you can enjoy a wide sound field like 5.1ch.

Suitable for listening to sounds of movies at low volume.

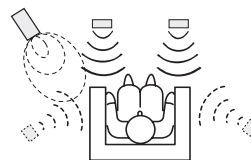

BASS

Bass frequencies are emphasised. You can select the BASS level.

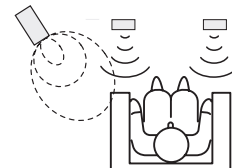

TREBLE

Treble frequencies are emphasised. You can select the TREBLE level.

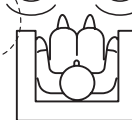

Notes:

- Subwoofer sound levels for preset sound modes are set to the recommended levels.
- You can adjust a subwoofer sound level by each preset sound mode (see page 30). Return the settings to default by resetting (see page 64).

■ Preset sound mode

Select any of the 8 preset modes already set to the optimal sound quality levels.

Select a desired sound mode by pressing the **SHIFT** and **SOUND MODE** buttons simultaneously.

Preset sound mode	Display
STANDARD	STANDARD
CINEMA	CINEMA
NEWS	NEWS
MUSIC	MUSIC
SPORT	SPORT
NIGHT	NIGHT
BASS	BASS
TREBLE	TREBLE

■ Bass control

1. Press the **SHIFT** and **SOUND MODE** buttons simultaneously to select "BASS".
2. Within 10 seconds, press the **VOLUME (+ or -)** button to adjust the bass.



■ Treble control

1. Press the **SHIFT** and **SOUND MODE** buttons simultaneously to select "TREBLE".
2. Within 10 seconds, press the **VOLUME (+ or -)** button to adjust the treble.

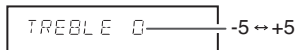

■ Dolby Virtual Speaker (DVS) sound mode

The Dolby Virtual Speaker (DVS) creates virtual surround sound comparable to the 5.1ch sound produced by the 2.1ch speaker.

When setting DVS to "ON" for 2 channel stereo signals, Dolby Pro Logic II (see page 34) brings out virtual sound effects through the signals converted into 5.1ch.

Press the DVS button.

The Dolby Virtual Speaker indicator lights up and set change to DVS WIDE mode. Press DVS button again to change to DVS REFERENCE mode.

Press the DVS button again to return to "DVS OFF".

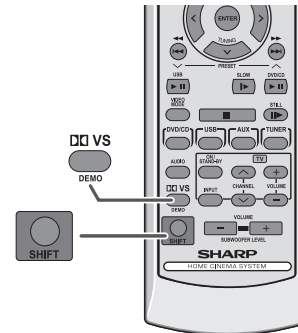

Notes:

- The DVS default setting is "WIDE" mode.
- When setting the DVS mode to "WIDE" or "REFERENCE", the preset sound mode and Audistry (SOUND SPACE mode, MONO TO STEREO mode) are cancelled. (The NATURAL BASS mode and the INTELLIGENT VOLUME mode are not cancelled.)
- Monaural signals do not generate surround effects.
- In case input signal is Dual mono type and DVS is set to "WIDE" or "REFERENCE", the sound may not be output correctly.
- When unit is turned on for the first time, selecting BASS mode using the SOUND MODE button will automatically set the DVS to OFF. Subsequently, when BASS mode is selected again, the DVS setting will follow the current user setting.
- When headphone is inserted, DVS setting and BASS/TREBLE setting, set earlier by user will be cancelled. However the DVS setting will not be recovered when the headphone is unplugged.

Enjoying surround sound (sound mode) (continued)

ON The Dolby Virtual Speaker creates multichannel-like sound effects.

Compared with the cinema mode, the bass sound level is slightly reduced.

The Dolby Pro Logic II indicator also lights up if 2ch sound signals are detected.

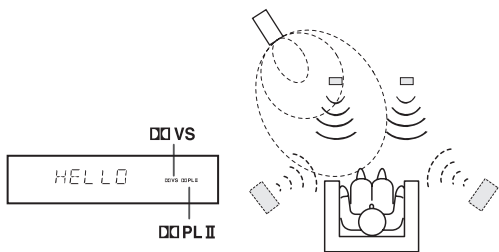

OFF The Dolby Virtual Speaker is deactivated.

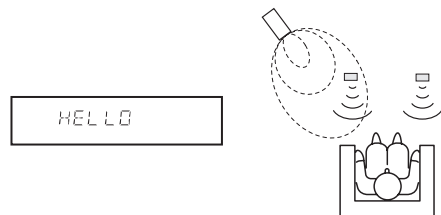

■ Audistry sound mode



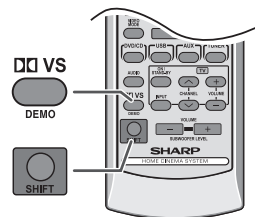
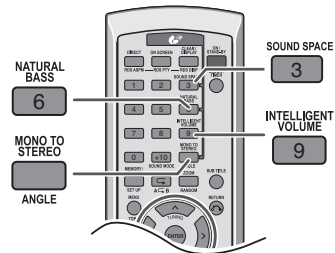

Enjoy a variety of sounds by each or any combination of the 4 modes.

Press the SHIFT and desired mode button simultaneously.
Press it again to cancel.



Possible combinations ○ :Enabled × :Disabled

	SOUND SPACE	NATURAL BASS	INTELLIGENT VOLUME	MONO TO STEREO
When you select "SOUND SPACE"	/	○	○	○
When you select "NATURAL BASS"	○	/	○	○
When you select "INTELLIGENT VOLUME"	○	○	/	○
When you select "MONO TO STEREO"	○	○	○	/
When you select "DVS"	×	○	○	×

<p>SOUND SPACE (Sound stage expansion)</p> <p>The 4 speakers create spacious stereo sounds.</p>	<p>SS</p>  <p>(The SOUND SPACE indicator lights up.)</p>
<p>NATURAL BASS (Bass sound expansion)</p> <p>The system's low-frequency characteristics realise the optimal bass sounds.</p>	<p>NB</p>  <p>(The NATURAL BASS indicator lights up.)</p>
<p>INTELLIGENT VOLUME (Peak limiter and expander)</p> <p>Appropriate listener-friendly volumes realised; the volume is decreased during loud sounds, and increased during low sounds.</p>	<p>IVC</p>  <p>(The INTELLIGENT VOLUME indicator lights up.)</p>
<p>MONO TO STEREO (Mono → Stereo conversion)</p> <p>You can enjoy monaural sound sources with a stereo-like effect.</p>	<p>MTS</p>  <p>(The MONO TO STEREO indicator lights up.)</p>

Notes:

- When setting each mode of Audistry to “ON”, the preset sound mode setting is cancelled.
- When setting the SOUND SPACE or MONO TO STEREO mode to “ON”, the DVS setting is also cancelled. (It is not cancelled even if the NATURAL BASS or INTELLIGENT VOLUME mode is set to “ON”.)

Playing a disc

Turn on the TV, and switch the input to the "VIDEO 1", "VIDEO 2", etc. accordingly.

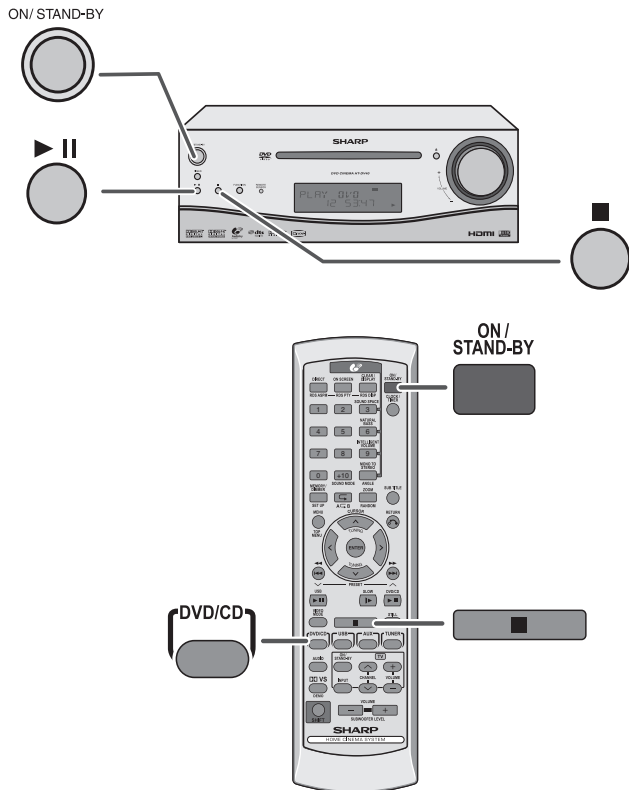

■ Playback DVD CD MP3 WMA JPEG DivX

1 Press the ON/STAND-BY button to turn the power on.

2 "SHARP" startup screen appears on the TV screen.

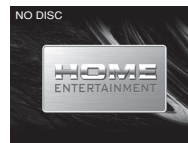

3 Press the DVD/CD button on the remote control.

4 Insert the disc into the disc slot, label side up.

- The disc must be fully inserted into the disc slot before playing. If "NO DISC" appears due to improper disc insertion, switch off the AC power supply and then switch it on again.

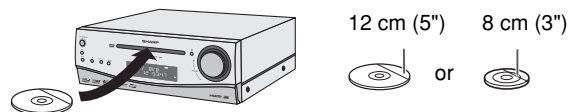

- 8 cm disc can be inserted without an adaptor.
- Due to the structure of the disc information, it takes longer to read an MP3/WMA disc than a normal CD (approximately 20 to 90 seconds).

5 Some discs play automatically. If playback does not start, press the ► II (DVD/CD ► II) button.



When the menu appears on the TV screen:

On DVD:

- Select item by using cursor (▲, ▼, < or >) button and press ENTER button.
- To return to the previous display, press the RETURN button.

- Playback will begin from track 1.
- After the last track on the disc is played, the unit will stop automatically.

To remove the disc:
In the stop mode, press the  button.

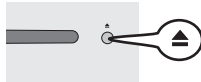

Caution:











- Do not play discs of special shapes (heart, octagon, etc). They may cause malfunctions.
- Do not push the disc whilst it is moving.
- If the power fails whilst the disc is moving, wait until the power is restored.
- If TV or radio interference occurs during CD operation, move the unit away from the TV or radio.

■ Auto power on function

When you press any of these buttons during stand-by mode, the units turns on.

- **FUNCTION** button (main unit): The unit turns on and the last of previous function is activated. (DVD/CD/USB/TUNER/OPTICAL 1/OPTICAL 2/AUX IN/SCART)
- **▶ / ||** button (main unit): The unit turns on and start playback the last of previous function of DVD/CD or USB.
- **DVD/CD** button (remote control): The unit turns on and the “DVD/CD” function is activated.
- **USB** button (remote control): The unit turns on and the “USB” function is activated.
- **AUX** button (remote control): The unit turns on and the last of previous function is activated. (OPTICAL 1/OPTICAL 2/AUX IN/SCART).
- **TUNER** button (remote control): The unit turns on and the “TUNER” function is activated.
- **USB ▶ / ||** button (remote control): The unit turns on and start playback the “USB” function.
- **DVD/CD ▶ / ||** button (remote control): The unit turns on and start playback the “DVD/CD” function.

■ Various disc functions

Function	Main unit	Remote control	Operation
Play 			Press in the stop mode.
Stop			Press in the playback mode.
Pause 			Press in the playback mode. Press the ▶ / button to resume playback from the paused point.
Track up/ Track down			Press in the playback or stop mode. If you press the button in the stop mode, press the ▶ / button to start the desired track.
Fast forward/ Fast reverse			Press and hold down in the playback mode. Release the button to resume playback.

Notes for CD or MP3/WMA disc:

- When the end of the last track is reached during fast forward, playback will stop. When the beginning of the first track is reached during fast reverse, the unit will enter the playback mode.
- Rewritable multi-session discs with unfinished writing, can still be played.

Playing a disc (continued)

To interrupt playback

Press the ► || (DVD/CD ► ||) button.

To resume playback from the same point, press the ► || (DVD/CD ► ||) button.

To stop playback

DVD:

Press the ■ button twice.

Audio CD/MP3/WMA/JPEG/DivX:

Press the ■ button.

CD:

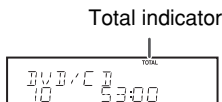

Caution:

- The unit gets slightly warm when used for a long time. It does not mean the unit is damaged.
- When attempting to play disc with scratches or of a different region number, or unplayable or restricted (*1) discs, an error message will appear on the TV display and the disc will not play.

(*1) Viewing is prohibited on some DVDs according to the audience age.

Notes:

- Stop positions may be recorded on some discs. When you play such a disc, playback stops here.
- During an operation, "INVALID KEY" may appear indicating that the operation is disabled by the disc.

■ To resume playback after stopping (resume play) DVD

You can resume playback from the point playback is stopped.

- 1 Whilst a disc is playing, press the ■ button.
The system stores the point you stopped.



- 2 To restart play, press the ► || (DVD/CD ► ||) button.

To cancel the resume playback:

Press the ■ button twice.

Notes:

- The resume playback feature is disabled on some discs.
- Depending on the disc, playback may resume from slightly before the stopped position.

■ DVD mode operation indicators

The following are examples of operation indicators that appear during DVD playback.

Operation	TV screen	Unit display
When the unit is on without a disc.		NO DISC
Disc data is being read.	READ	TOC READING
First time stop	PRE STOP ►■	DVD/CD RESUME
Second time stop	STOP ■	DVD/CD STOP
Play	SEQ PLAY	DVD/CD 01:00 .
Pause	PAUSE	DVD/CD 01:00 .

Basic operation

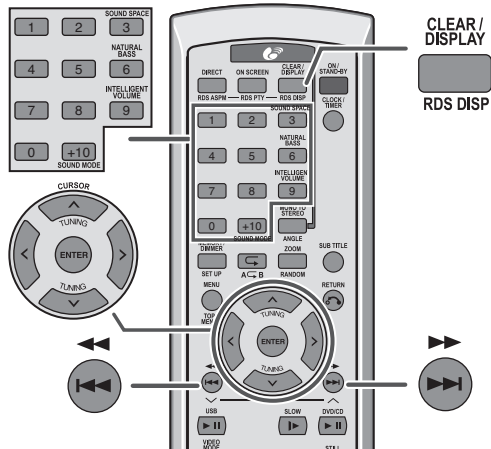

■ To locate the beginning of a chapter track (skip)

DVD CD MP3 WMA JPEG DivX

You can move to other tracks with simple operations.

Whilst a disc is playing, press the **⏪ ⏩ or **⏮ ⏭** button.**

- Use the **⏮ ⏭** button to skip to the next chapter (track).
- Use the **⏪ ⏩** button twice to skip to the previous chapter (track).

Notes:

- Some discs do not display the chapter (track) and the skip feature is disabled.
- On a DVD, skip does not operate between titles.

■ Fast forward/Fast reverse (search)

DVD CD MP3 WMA DivX

You can search the desired point as you play the disc.

1 Whilst a disc is playing, press and hold the **⏮ ⏩** or **⏮ ⏭** button.

The scanning speed will change as follows at each press of the button.

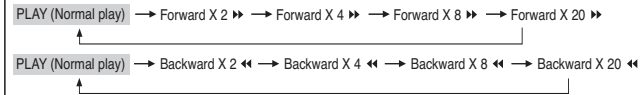

The disc is forwarded by the **⏮ ⏭** button and backward by the **⏪ ⏩** button.

2 Press the **▶ II (DVD/CD ▶ II)** button to return to the normal playback.

Notes:

- On some discs, the search is disabled.
- On a DVD, search does not operate between titles.
- On audio CD, the search can be operated between tracks.
- Whilst searching on a DVD, the sound is not heard and the subtitles only appear at x 2 speed search.
- When search is performed during the DVD playback, pictures may not be forwarded or reversed in the search speed specified in this manual, depending on the disc or the scene being played.
- The search does not operate on JPEG discs.
- Whilst searching on an audio CD, MP3 or WMA disc, the sound can only be heard at x 2 speed search.

Basic operation (continued)

■ To start playback from the desired point (direct play) **DVD**

To select and play the desired title and chapter:

1 Whilst in the stop or playback mode, press the DIRECT button.

TV screen

TT 00/02 CH 000/025 ⊖ 01:41:14

2 Select the title or chapter by pressing the < or > button and enter the title or chapter number using the Direct Search buttons.

Example:

To select chapter 1: Press "1".

To select chapter 12: Press "1" and "2".

To select chapter 22: Press "2" and "2".

3 Press the ENTER button after confirm.

Notes:

- Direct play feature is disabled on some discs.
- Some DVD discs may not display the chapter number. You can specify the desired point only in the current title and not in other titles.

To play by specifying time (time search):

You can play back from the desired point by specifying the time.

1 Press DIRECT button.

startup

TV screen

TT 01/03 CH 000/025 ⊖ 00:00:00

Input desired time here

hour min sec

2 Press > button on the remote control to select time column.

The time will be reset as "00:00:00".

3 Specify the time with the Direct Search buttons, and then press the ENTER button.

TT 01/03 CH 000/025 ⊖ 01:23:40

- To specify 1 hour 23 minutes and 40 seconds, enter "01:23:40".
- If you enter the wrong number, press < or > button for the desired time.

Notes:

- Some discs cannot play from the specified point.
- Time search feature is disabled on some discs.

Useful operation

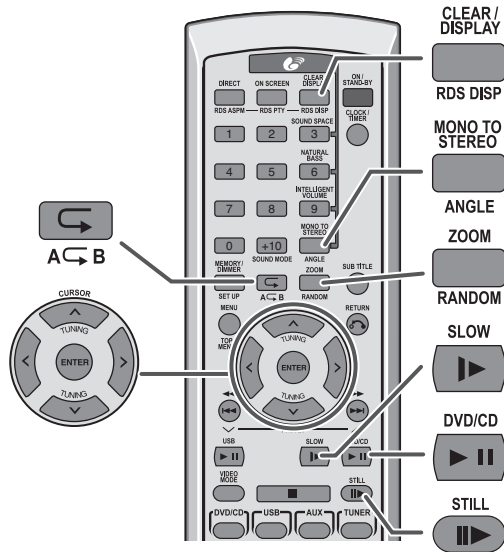

■ Slow motion play **DVD** **DivX**

You can slow down the playback speed.

- 1 Whilst a disc is playing, press the **SLOW** **▶** button repeatedly to select the desired speed.

The speed changes as follows:

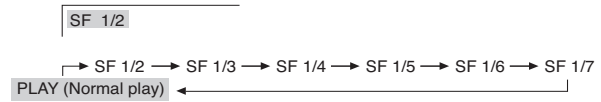

- 2 Press the **▶ ||** (DVD/CD **▶ ||**) button to return to the normal playback.

Notes:

- On some discs with movies inside, the slow-motion play function is disabled.
- The sound is muted during slow-motion play.

■ Still picture/Frame advance **DVD** **DivX**

You can freeze the picture during playback.

- 1 Whilst a disc is playing, press the **STILL** **||▶** button. TV screen

STEP **||▶**

- 2 Each press of the **STILL** **||▶** button advances the frame in the still mode.

- 3 Press the **▶ ||** (DVD/CD **▶ ||**) button to return to the normal playback.

Note: The sound is muted during still picture.

Useful operation (continued)

■ To change the angle **DVD**

You can change the angle of view when playing a DVD disc that contains scenes recorded from multiple angle.

When “” is displayed in the upper left corner of the TV screen, press the **ANGLE** button repeatedly to select the desired angle number.

Notes:

- The angle number is not displayed if angles are not recorded on the disc.
- Refer to the manual of the disc as the operation may vary depending on the disc.

■ To zoom images (zoom) **DVD DivX JPEG**

You can zoom in and zoom out the image during playback.

1 Whilst a disc is playing, press the **ZOOM** button.

Each press of the **ZOOM** button cycles through the zoom setting as follows:

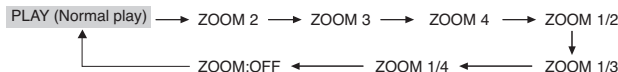

2 To shift the view and display the desired part of a zoomed image, press the **↑**, **↓**, **←** or **→** button repeatedly.

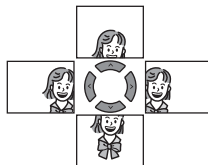

To return to normal view:

Press the **ZOOM** button repeatedly to select “**ZOOM:OFF**”.

Notes:

- Images may become distorted when zoomed.
- Subtitles cannot be zoomed.
- For **JPEG ZOOM** function, please refer page 49 for details.

■ To play the contents between the specified points repeatedly **(A-B repeat)**

DVD CD DivX MP3 WMA

You can play the desired portion repeatedly by specifying it during playback.

1 Whilst a disc is playing, press **SHIFT** and **A < B** button simultaneously.

TV screen

REPEAT A -

Unit display

POINTA → A

This registers the start point (A).

2 Press **SHIFT** and **A < B** button simultaneously again to enter the end point (B).

TV screen

REPEAT A - B

Unit display

POINTB → B — — — — — → A < B

This starts A-B repeat from the start point (A) to the end point (B).

3 Press **SHIFT** and **A < B** button simultaneously to return to the normal playback.

Notes:

- A-B repeat play is disabled on some discs.
- A-B repeat play for DVD is possible only within a chapter.
- Some scenes on DVD may not allow A-B repeat play.

■ To select a subtitle or audio language from the disc menu **DVD**

You can select the desired subtitle or audio language and sound system [Dolby Digital (5.1ch) or Dolby Digital (2ch)] on your DVD if it has disc menu.

1 Whilst in the stop or playback mode, press the **TOP MENU/MENU** button to display the disc menu.

2 Press the **↑**, **↓**, **←** or **→** button to change the setting and press the **ENTER** button.

Note:

The procedure shown here provides only general steps. The actual procedure for using the disc menu depends on the disc. See the disc jacket for details.

■ To play in the desired order (programmed play)

DVD CD MP3 WMA JPEG DivX

You can play back the desired tracks in a specific order. Maximum of 16 tracks can be programmed.

1 Whilst in the stop mode, press the MEMORY/DIMMER button.

The PROGRAM screen shows as follows on CD and USB:

TV screen

PROG			
1	5	9	13
2	6	10	14
3	7	11	15
4	8	12	16
PLAY		CLEAR	

Unit display

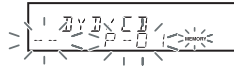

2 Enter a track and chapter number with the Direct Search buttons.

The PROGRAM screen shows as follows on DVD:

TV screen

PROG			
T	C	T	C
1 01:12	5	9	13
2	6	10	14
3	7	11	15
4	8	12	16
PLAY		CLEAR	

Unit display



2) ENTER CHAPTER



The PROGRAM screen shows as follows on CD and USB:

TV screen

PROG			
1 0 0 1 5	5	9	13
2 0 0 1 3	6	10	14
3 0 1 0 2	7	11	15
4	8	12	16
PLAY		CLEAR	

Unit display

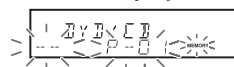

- For the next entry, repeat the procedure above to enter other track numbers by pressing Direct Search buttons after pressing ENTER button.
- If you enter the wrong number, you can change the title/track number by pressing Direct Search buttons again before pressing ENTER button.
- If the track number is 2 digits or more, example track 12, just press "1" and "2" by Direct Search buttons.
- Folder programmed is not possible.

3 Select "PLAY" at the PROGRAM menu by pressing ^, v, < or > button and press ENTER button on remote control to start play.

To change the programmed contents:
Repeat the above procedure from step 1.

To cancel the programmed play mode:
Select "CLEAR" at the PROGRAM menu by pressing ^, v, < or > button and press ENTER button on remote control to cancel the programmed play mode.

Notes:

- If the disc is ejected, the programmed sequence will be cancelled.
- The programme will be automatically cancelled if you press the ON/STAND-BY button to enter the stand-by mode or change the function from DVD/CD to another.
- During the programme operation, pressing the RANDOM button will automatically cancel the programme.
- Removing the USB memory device will automatically cancel the programmed sequence.
- Select "CLEAR" at the PROGRAM menu and press ENTER button, the programmed sequence will be cancelled.

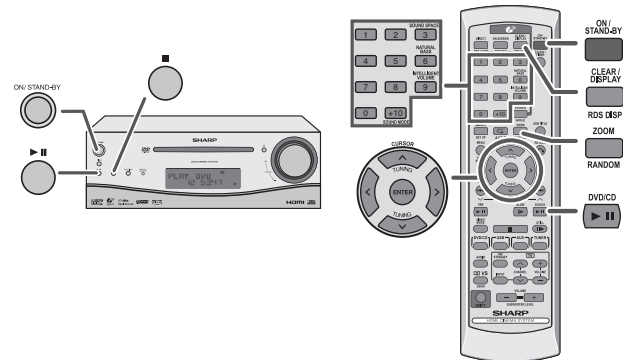

Useful operation (continued)

■ To play repeatedly (repeat play)

DVD CD MP3 WMA JPEG DivX

You can play a chapter (track) or a title repeatedly by specifying it during playback.

1 Whilst a disc is playing, press the **◀** button to Repeat 1. TV screen Unit display



Each time the button is pressed, the repeat play mode changes in the following order.

The repeat play mode changes as follows on DVD:

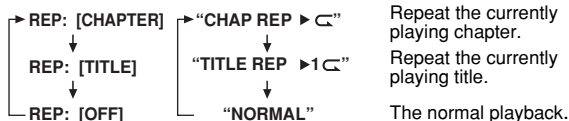

The repeat play mode changes as follows on audio CD:

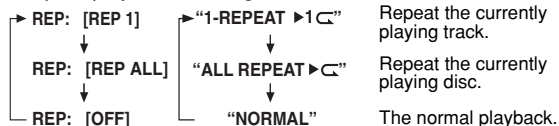

The repeat play mode changes as follows on MP3/WMA:

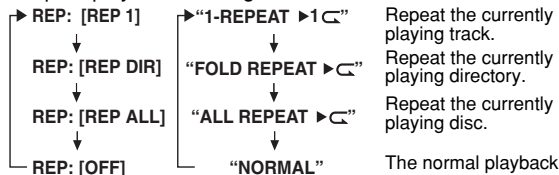

2 To return to the normal playback, press the **◀** button repeatedly to select "NORMAL".

Notes:

- After performing repeat play, be sure to press the **■** button. Otherwise, the disc will play continuously.
- On some discs, the repeat play function is disabled.

■ To change the display on TV screen **DVD DivX**

You can display or hide the operation indicators on the TV screen. Whilst a disc is playing, press the ON SCREEN button. (The display is changed at each press.)

DVD:

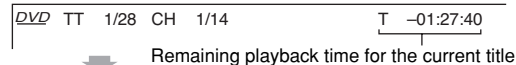
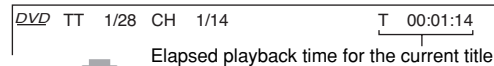
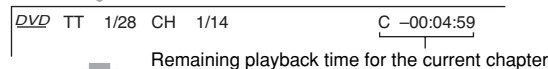
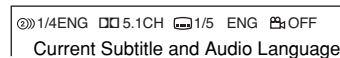
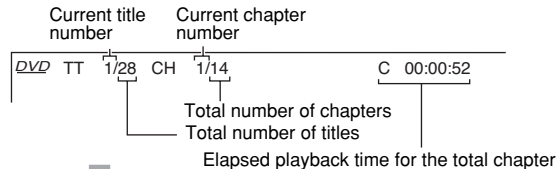

OFF

■ To change the display on main unit

DVD MP3 WMA

Whilst a disc is playing, press the CLEAR/DISPLAY button. (The display is changed at each press.)

DVD:

CHAPTER Indicator

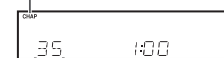

Current chapter number

TITLE Indicator

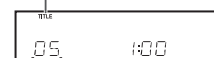

Current title number

MP3/WMA:

- Title, Artist and Album name is displayed if it is recorded on the disc.
- Display content can be changed by pressing the CLEAR/DISPLAY button on remote control.

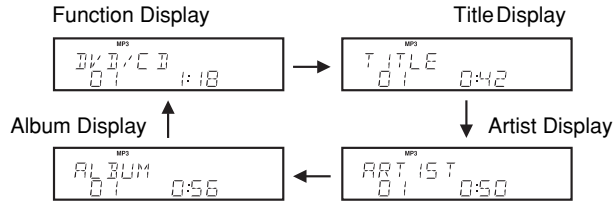

Note:

If "UNKNOWN" is displayed, it means Title or Artist or Album name is not recorded.

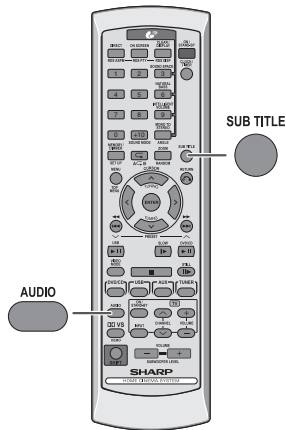

The subtitle language, audio language and TV type you select during playback are reset each time you set this unit to stand-by mode or switch the input. To keep your own settings, set them in the Set up menu (see page 23).

■ To change the subtitle language DVD

You can change the subtitle language or hide subtitles during playback.

Whilst a disc is playing, press the SUBTITLE button repeatedly to select the desired subtitle language.



Notes:

- On some discs, the subtitle language cannot be changed.
- If no subtitles are recorded on the disc, "OFF" is displayed.
- It may take time to switch the subtitle language to the selected one.
- Subtitles cannot be hidden on some DVDs.

■ To change the audio language (audio output) DVD

DVD

During playback, you can change the audio language (audio output).

Whilst a disc is playing, press the AUDIO button repeatedly to select the desired audio number.



You can select desired languages.

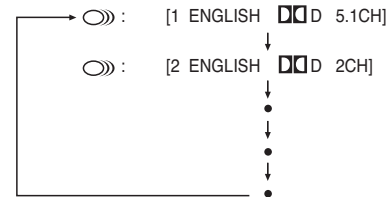

Notes:

- On some discs, the audio language cannot be changed.
- For the audio language and audio system, refer to the manual of the disc.

Listening to a CD or MP3/WMA disc

This system can play back a standard CD, CD-R/RW in the CD format and CD-R/RW with MP3 or WMA files, but cannot record on them. Some audio CD-R and CD-RW discs may not be playable due to the state of the disc or the device that was used for recording.

MP3:

MP3 is a form of compression. It is an acronym which stands for MPEG Audio Layer 3.

MP3 is a type of audio code which is processed by significant compression from the original audio source with very little loss in sound quality.

- This system supports MPEG 1 Layer 3 and VBR files.
- During VBR file playback, time counter in the display may differ from its actual playback time.
- Bitrate which is supported by MP3 is 32 ~ 320 kbps.

WMA:

WMA files are Advanced System Format files that include audio files which are compressed with Windows Media Audio codec. WMA is developed by Microsoft as an audio format file for Windows Media Player.

- "MP3" and "WMA" indicator will light up after the unit reads information on an MP3 or WMA disc.
- Bitrate which is supported by WMA is 64 ~ 160 kbps.

The following playback functions are the same as DVD operations.

	Page
Playing a disc	36 - 38
To locate the beginning of a chapter track (skip)	39
Fast forward/Fast reverse (search)	39
To start playback from the desired point (direct play)	40
To play the contents between the specified points repeatedly (A-B repeat)	42
To play in the desired order (programmed play)	43
To play repeatedly (repeat play)	44
To change the display on TV screen	44
To change the display on main unit	44

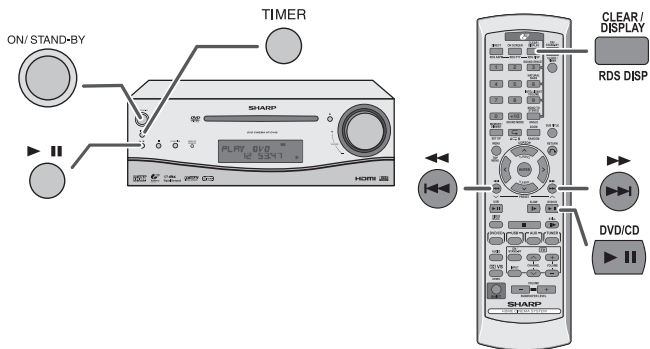

Advanced CD or MP3/WMA disc playback

■ To play in random order (random play)

CD **JPEG** **MP3** **WMA**

The tracks on the disc play back can be played in random order automatically.

In the stop or playback mode, press the SHIFT button and then the RANDOM button.

All the tracks play in random order.

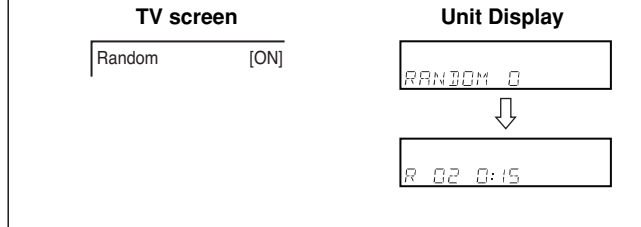

To cancel random play:

To cancel random playback, press the SHIFT and RANDOM buttons, so that the random "R**" character will disappear.

Notes:

- On some disc, this function cannot be used.
- If RANDOM button is pressed whilst in programmed playback, playback will enter random mode and programme is cancelled.
- In random play, the unit will select and play tracks automatically. (You cannot select the order of the tracks.)
- If you press the **◀◀** or **▶▶** button during random play, you can move to the track selected next by the random operation.
- In random function, playback will continue until **■** button is pressed.

■ To start playback from the desired point (direct play)

By using the Direct Search buttons, the desired tracks on the current disc can be played.

Use the Direct Search buttons on the remote control to select the desired track whilst playing or in the stop mode.



Selected track number

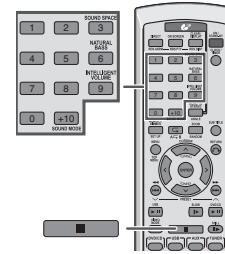

Notes:

- A track number higher than the number of tracks on the disc cannot be selected.
- During random play, direct search is not possible.
- For CD-R/RW discs recorded in the MP3 or WMA format, you can select the track number but cannot select the folder by pressing the Direct Search buttons.

Notes:

- This unit only supports "MPEG-1 Audio Layer-3" and "MPEG-2 Audio Layer-3" format. (Sampling Frequency is 32, 44.1, 48kHz)
- "MPEG-2.5 Audio Layer-3" and MP1, MP2 format are not supported.
- Playback order for MP3 files may differ sometimes depending on the writing software used during file downloading.
- Bitrate which is supported by MP3 is 32~320 kbps, WMA is 64~160 kbps.
- For MP3/WMA files, please put ".MP3" ".WMA" extension. Files cannot be played back if there is no MP3/WMA extension.
- Playlists are not supported on this unit.
- This unit only supports MP3 ID3-Tag version 1.x.
- The display playback time may not be displayed correctly when playing back a variable bitrate file.
- Copyright protected WMA files cannot be played back.

DivX and JPEG disc operation

	Page
Playing a disc	36 - 38
To locate the beginning of a chapter track (skip)	39
Fast forward/Fast reverse (search)	39
To start playback from the desired point (direct play)	40
Still picture/Frame advance	41
Slow motion play (DivX only)	41
To change the angle	42
To zoom images (zoom)	42
To play the contents between the specified points repeatedly (A-B repeat)	42
To select a subtitle or audio language from the disc menu	42
To play in the desired order (programmed play)	43
To play repeatedly (repeat play)	44
To change the display on TV screen	44
To change the display on main unit	44
To change the audio language	45

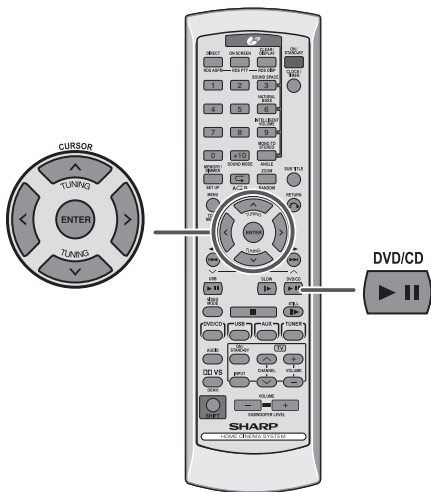





■ Playback on the DivX and JPEG menu screen

DivX JPEG

You can play CD-R/RW recorded in the DivX and JPEG formats.



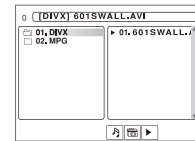

1 Load a disc containing DivX and JPEG files, the menu screen appears.

-  indicates folders
-  indicates JPEG data
-  indicates MP3/WMA data
-  indicates DivX or MPEG data



2 Press the < or > button to select , , or and then press the ENTER button.

3 Select a folder or a track using the ^, v, < or > button.

- Playback starts when you press  (DVD/CD ) or ENTER button.
- The next file picture can be automatically displayed after a while for JPEG format if you select  (DVD/CD ) button to start playback.
- Using the Direct Search buttons, you can open file directly.

■ **Zoom function** **JPEG** **DivX**

1 During playback, press the ZOOM button.

2 Each press of the ZOOM button cycles through the zoom setting as follows:

NORMAL PLAY (ZOOM : OFF) → ZOOM 2 → ZOOM 3 → ZOOM 4
 ↓
 ZOOM 1/4 ← ZOOM 1/3 ← ZOOM 1/2

3 To shift the view and display the desired part of a zoomed image, press the ^, v, < or > button repeatedly.

Press the ^ button.

Press the > button.

Press the < button.

Press the v button.

To return to normal view:
 Press the ZOOM button again, "ZOOM:OFF" will appear on the screen.

■ **Rotating a picture** **JPEG**

1 During playback, press the ^, v, < or > button.

The image rotates as below:

> button : 90° rotation in a clockwise direction.

< button : 90° rotation in an anti-clockwise direction.

^ button : Horizontal mirror image.

v button : Vertical mirror image.

Playback on USB memory device

■ Playback on USB memory device

JPEG MP3 WMA

You can play USB recorded in JPEG, MP3 and WMA formats.

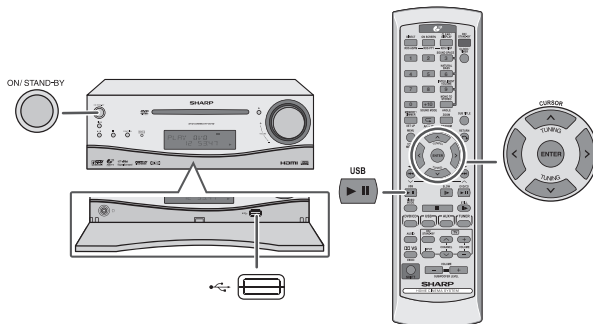

Note:

This product is not compatible with MTP and AAC file systems.

1 Open the bottom door. Connect the USB device. Press the **▶ II (USB ▶ II)** button.

- To select USB function, press the **▶ II (USB ▶ II)** button.

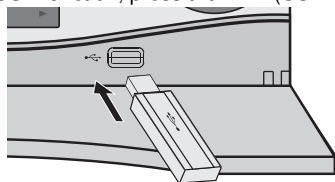

2 Press the **<** or **>** button to select data types recorded in USB memory device.

3 Press **ENTER** button to choose folder types.

4 Select desired track to be played back by pressing **^**, **v**, **<** or **>**. Then press **ENTER** or **▶ II (USB ▶ II)** button. This function is only visible when connected to TV.

To remove USB memory device

■ To remove USB memory device

1 Press the **■** button.

2 Disconnect USB memory device from the USB terminal.

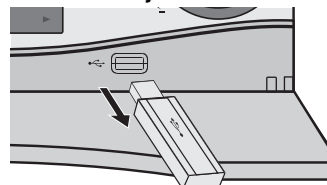

The following functions are the same as DVD or CD operations:

	Page
To locate the beginning of a chapter track (skip)	39
Fast forward/Fast reverse (search)	39
To start playback from the desired point (direct play)	40
Slow motion play	41
To zoom images (zoom)	42
To play the contents between the specified points repeatedly (A-B repeat)	42
To play in the desired order (programmed play)	43
Random play	47

Note:

If USB memory device is not connected, "NO MEDIA" will be shown on the display.

Advanced USB playback

Notes:

- SHARP will not be held liable for the loss of data whilst the USB memory device is connected to the audio system.
- Files compressed in MP3 and / or WMA format can be played back when connected to the USB terminal.
- This USB memory's format support FAT 16 or FAT 32.
- SHARP cannot guarantee that all USB memory devices will work on this audio system.
- This USB memory cannot be operated via USB hub.
- If "UNSUPPORT WMA" is displayed, it means "Copyright protected WMA file" is selected.
- The USB terminal in this unit is not intended for a PC connection but is used for music streaming with a USB memory device.
- The larger the capacity of the USB storage device, the longer it will take for the data to be read.
- Some USB multi-reader devices may not work correctly with the USB terminal on this unit.
- External storage devices cannot be played back using the USB terminal on this unit.
- This unit only supports "MPEG-1 Audio Layer-3" and "MPEG-2 Audio Layer-3" format. (Sampling Frequency is 32, 44.1, 48kHz)
- "MPEG-2.5 Audio Layer-3" and MP1, MP2 format are not supported.
- Playlists are not supported on this unit.
- The playback time may not be displayed correctly when playing back a variable bitrate file.
- Use only the supplied USB cable.

■ Repeat play (REMOTE CONTROL ONLY)

Repeat play can play single track and all track sequence continuously.

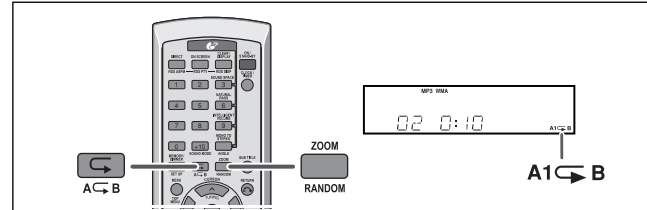

Whilst a disc is playing, each time the button is pressed, the repeat mode changes in the following order:

In case of an USB mode:

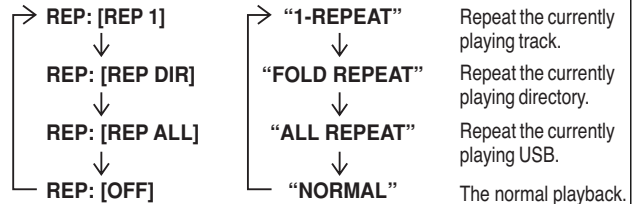

■ Random play (REMOTE CONTROL ONLY)

The tracks can be played in random order automatically.

To random play all tracks:

Press the SHIFT and RANDOM buttons on the remote control so that random indicator lights up in the display window.



Advanced USB playback (continued)

To cancel random playback, press again the SHIFT and RANDOM buttons, so that the random indicator will disappear.

Notes:

- If you press the ◀◀◀ or ▶▶▶ button during random play, you can move to the track selected next by the random operation.
- In random play, the unit will select and play tracks automatically. (You cannot select the order of the tracks.)
- If you press the REPEAT button during random play, playback will enter repeat mode and random will be cancelled.
- In random function, playback will continue until ■ button is pressed.

Caution:

After performing repeat, be sure to press the ■ button. Otherwise, it will play continuously.

Notes:

- This unit only supports “MPEG-1 Audio Layer-3” and “MPEG-2 Audio Layer-3” format. (Sampling Frequency is 32, 44.1, 48kHz)
- “MPEG-2.5 Audio Layer-3” and MP1, MP2 format are not supported.
- Playback order for MP3 files may differ sometimes depending on the writing software used during file download.
- Bitrate which is supported by MP3 is 32~320 kbps, WMA is 64~160 kbps.
- For MP3/WMA files, please put “.MP3” “.WMA” extension. Files cannot be played back if there is no MP3/WMA extension.
- Playlists are not supported on this unit.
- This unit only supports MP3 ID3-Tag version 1.x.
- The display playback time may not be displayed correctly when playing back a variable bitrate file.
- Copyright protected WMA files cannot be played back.

Listening to the radio

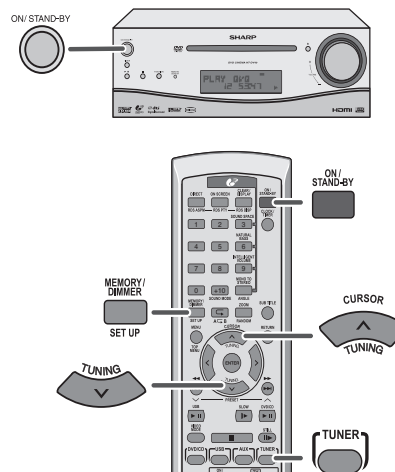

■ Tuning

- 1 Press the ON/STAND-BY button to turn the power on.**
- 2 Press the TUNER button on the remote control.**
- 3 Press the TUNING (∨ or ∧) button to tune in to the desired station.**

Manual tuning:

Press the TUNING (∨ or ∧) button as many times as required to tune in to the desired station.

Auto tuning:

When the TUNING (∨ or ∧) button is pressed for more than 0.5 seconds, scanning will start automatically and the tuner will stop at the first receivable broadcast station.

Notes:

- When radio interference occurs, auto scan tuning may stop automatically at that point.
- Auto scan tuning will skip weak signal stations.
- To stop the auto tuning, press the TUNING (∨ or ∧) button again.
- When an RDS (Radio Data System) station is tuned in, the frequency will be displayed first, and then the RDS indicator will light up. Finally, the station name will appear.
- Full auto tuning can be achieved for RDS stations "ASPM", see page 55.

To receive an FM stereo transmission:

Press the TUNER button to select stereo mode and "ST" indicator will be displayed.

- "CD" will appear when an FM broadcast is in stereo.
- If the FM reception is weak, press the TUNER button to extinguish the "ST" indicator. The reception changes to monaural, and the sound becomes clearer.

FM stereo receiving indicator



FM stereo mode indicator

■ **Memorising a station**

Up to 30 stations for FM band can be stored and recalled at the push of a button. (PRESET (∨ or ∧))

- 1 Perform steps 1 - 3 in "Tuning" on page 52.**
- 2 Press the MEMORY/DIMMER button to enter the preset tuning saving mode.**

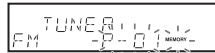

- 3 Within 30 seconds, press the PRESET (∧ or ∨) button to select the preset channel number.**

Store the stations in memory, in order, starting with preset channel 1.

- 4 Within 30 seconds, press the MEMORY/DIMMER button to store that station in memory.**



If the "MEMORY" and preset number indicators disappear before the station is memorised, repeat the operation from step 2.

- 5 Repeat steps 1 - 4 to set other stations, or to change a preset station.**

When a new station is stored in memory, the station previously memorised for that preset channel number will be erased.

Note:

The backup function protects the memorised stations for a few hours should there be a power failure or the AC power lead become disconnected.

■ **To recall a memorised station**

Press the PRESET (∨ or ∧) button for less than 0.5 seconds to select the desired station.

■ **To scan the preset stations**

The station saved in memory can be scanned automatically. (Preset memory scan)

- 1 Press the PRESET (∨ or ∧) button for more than 0.5 seconds. The preset number will flash and the programmed stations will be tuned in sequentially, for 5 seconds each.
- 2 Press the PRESET (∨ or ∧) button again when the desired station is located.

■ **To erase entire preset memory**

- 1 Press the ON/STAND-BY button to enter the stand-by mode.
- 2 Press and hold CLEAR/DISPLAY button until "TUNER CLEAR" appears.

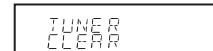

Using the Radio Data System (RDS)

RDS is a broadcasting service which a growing number of FM stations provide. These FM stations send additional signals along with their regular programme signals. They send their station names, and information about the type of programme such as sport, music, etc.

When tuned to an RDS station, "RDS" and the station name will be displayed.

"TP" (Traffic Programme) will appear on the display when the received broadcast carries traffic information, and "TA" (Traffic Announcement) will appear whilst a traffic information is on air.

"PTYI" (Dynamic PTY Indicator) will appear whilst the Dynamic PTY station is received.

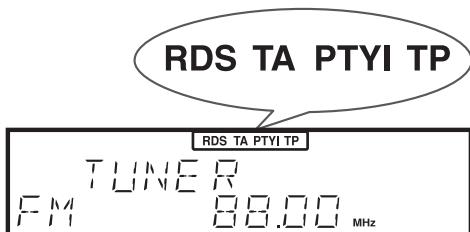

You can control the RDS by using the buttons on the remote control only.

Information provided by RDS

Each time the RDS DISP button is pressed, the display will switch as follows:

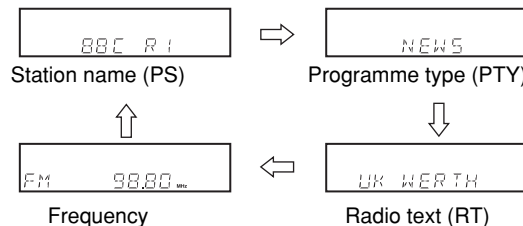
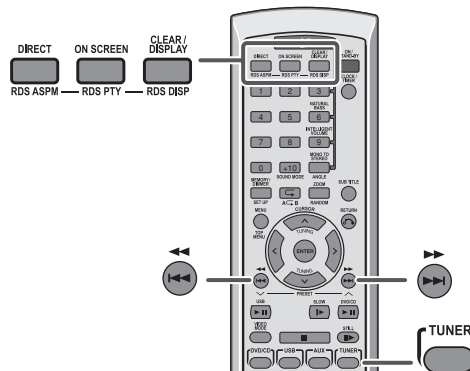

When tuning in to a station other than an RDS station or to an RDS station which sends weak signal, the display will change in the following order:

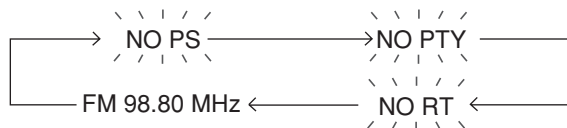

■ Using the Auto Station Programme Memory (ASPM)

Whilst in the ASPM operation mode, the tuner will automatically search for new RDS stations. Up to 30 stations can be stored. If you have already stored some stations in memory, the number of new stations you can store will be less.

1 Press the TUNER button to select the FM band.

2 Press and hold down the SHIFT and RDS ASPM button on the remote control for at least 3 seconds.

- 1 After "ASPM" has flashed for about 4 seconds, scanning will start (87.50 - 108.00 MHz).

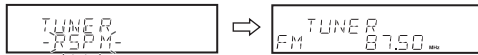

- 2 When an RDS station is found, "RDS" will appear for a short time and the station will be stored in memory.

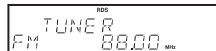

- 3 After scanning, the number of stations stored in memory will be displayed for 4 seconds, and then "END" will appear for 4 seconds.



To stop the ASPM operation before it is complete:

Press the SHIFT and RDS ASPM button whilst it is scanning for stations.

The stations which are already stored in memory will be kept there.

Notes:

- If the same station is broadcasting on different frequencies, the strongest frequency will be stored in memory.
- Any station which has the same frequency as the one stored in memory will not be stored.
- If 30 stations have already been stored in memory, the scan will be aborted. If you want to redo the ASPM operation, erase the preset memory.
- If no station is stored in memory, "END" will appear for about 4 seconds.
- If the RDS signals are very weak, station names may not be stored in memory.

To erase all of the contents of preset memory:

- 1 Press the ON/STAND-BY button to enter the power stand-by mode.
 - 2 Press CLEAR/DISPLAY button for more than 2 seconds until "TUNER CLEAR" appears.
- After performing this operation, all of the preset memory information will be erased.

To store a station name again if the wrong name was stored in memory:

It may be impossible to store station names in memory using the ASPM function if there is lots of noise or if the signal is too weak. In this case, perform as follows.

- 1 Press the PRESET (^ or v) button to check whether the names are correct.
 - 2 If you find a wrong name whilst receiving the station, wait until the correct name is displayed and then press the MEMORY/DIMMER button.
 - 3 Within 30 seconds, press the MEMORY/DIMMER button whilst the preset channel number is flashing.
- The new station name has been stored in memory correctly.

Using the Radio Data System (RDS) (continued)

Notes:

- The same station name can be stored in different channels.
- In a certain area or during certain time periods, the station names may temporarily be different.

■ Notes for RDS operation

If any of the following events occur, it does not mean that the unit is faulty:

- “PS”, “NO PS” and a station name appear alternately, and the unit does not operate properly.
- If a particular station is not broadcasting properly or a station is conducting tests, the RDS reception function may not work properly.
- When you receive an RDS station whose signal is too weak, information like the station name may not be displayed.
- “NO PS”, “NO PTY” or “NO RT” will flash for about 5 seconds, and then the frequency will be displayed.



Notes for radio text:

- The first 10 characters of the radio text will appear for 4 seconds and then they will scroll across the display.
- If you tune in to an RDS station which is not broadcasting any radio text, “NO RT” will be displayed when you switch to the radio text position.
- Whilst radio text data is received or when the text contents change, “RT” will be displayed.

■ To recall stations in memory

To specify programmed types and select stations (PTY search):

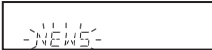
You can search a station by specifying the programme type (news, sports, traffic programme, etc. ... see pages 57 - 58) from the stations in memory.

1	Press the TUNER button to select the FM band.
2	Press the SHIFT and RDS PTY button on the remote control.  <p>“SELECT” and “PTY TI” will appear alternately for about 6 seconds.</p>
3	Within 6 seconds, press the PRESET (^ or v) button to select the programme type.  <p>Each time the button is pressed, the programme type will appear. If the button is held down for more than 0.5 seconds, the programme type will appear continuously.</p>
4	Whilst the selected programme type is flashing (within 6 seconds), press the SHIFT and RDS PTY button again.  <p>After the selected programme type has been lit for 2 seconds, “SEARCH” will appear, and the search operation will start.</p>

Notes:

- If the display has stopped flashing, start again from step 2. If the unit finds a desired programme type, the corresponding channel number will flash for about 4 seconds, and then the station name will flash for 7 seconds, which will remain lit.
- If you want to listen to the same programme type of another station, press the SHIFT and RDS PTY button whilst the channel number or station name is flashing. The unit will look for the next station.
- If no station can be found, "NOT FOUND" will appear for 4 seconds.

If you select the traffic programme:

If you select the traffic programme (TP) in step 3, "TP" will appear. (This does not mean that you can listen to the traffic information at that time.)

When the traffic information is broadcast, "TA" will appear.

Descriptions of the PTY (Programme Type) codes, TP (Traffic Programme) and TA (Traffic Announcement).

You can search for and receive the following PTY, TP and TA signals.

NEWS	Short accounts of facts, events and publicly expressed views, reportage and actuality.
AFFAIRS	Topical programme expanding or enlarging upon the news, generally in different presentation style or concept, including debate, or analysis.
INFO	Programmes whose purpose is to impart advice in the widest sense.
SPORT	Programme concerned with any aspect of sport.
EDUCATE	Programme intended primarily to educate, of which the formal element is fundamental.
DRAMA	All radio plays and serials.
CULTURE	Programmes concerned with any aspect of national or regional culture, including language, theatre, etc.
SCIENCE	Programmes about the natural sciences and technology.
VARIED	Used for mainly speech-based programmes usually of light-entertainment nature, not covered by other categories. Examples include: quizzes, panel games, personality interviews.
POP M	Commercial music, which would generally be considered to be of current popular appeal, often featuring in current or recent record sales charts.
ROCK M	Contemporary modern music, usually written and performed by young musicians.
EASY M	Current contemporary music considered to be "easy-listening", as opposed to Pop, Rock or Classical, or one of the specialised music styles, Jazz, Folk or Country. Music in this category is often but not always, vocal, and usually of short duration.

Using the Radio Data System (RDS) (continued)

LIGHT M	Classical music for general, rather than specialist appreciation. Examples of music in this category are instrumental music, and vocal or choral works.
CLASSICS	Performances of major orchestral works, symphonies, chamber music, etc., and including Grand Opera.
OTHER M	Musical styles not fitting into any of the other categories. Particularly used for specialist music of which Rhythm & Blues and Reggae are examples.
WEATHER	Weather reports and forecasts and meteorological information.
FINANCE	Stock Market reports, commerce, trading, etc.
CHILDREN	For programmes targeted at a young audience, primarily for entertainment and interest, rather than where the objective is to educate.
SOCIAL	Programmes about people and things that influence them individually or in groups. Includes: sociology, history, geography, psychology and society.
RELIGION	Any aspect of beliefs and faiths, involving a God or Gods, the nature of existence and ethics.
PHONE IN	Involving members of the public expressing their views either by phone or at a public forum.
TRAVEL	Features and programmes concerned with travel to near and far destinations, package tours and travel ideas and opportunities. Not for use for announcements about problems, delays, or roadworks affecting immediate travel where TP/TA should be used.
LEISURE	Programmes concerned with recreational activities in which the listener might participate. Examples include, Gardening, Fishing, Antique collecting, Cooking, Food & Wine, etc.
JAZZ	Polyphonic, syncopated music characterised by improvisation.

COUNTRY	Songs which originate from, or continue the musical tradition of the American Southern State characterised by a straightforward melody and narrative story line.
NATION M	Current Popular Music of the Nation or Region in that country's language, as opposed to International "Pop" which is usually US or UK inspired and in English.
OLDIES	Music from the so-called "golden age" of popular music.
FOLK M	Music which has its roots in the musical culture of a particular nation, usually played on acoustic instruments. The narrative or story may be based on historical events or people.
DOCUMENT	Programme concerned with factual matters, presented in an investigative style.
TEST	Broadcast when testing emergency broadcast equipment or receivers.
ALARM !	Emergency announcement made under exceptional circumstances to give warning of events causing danger of a general nature.
NONE	No programme type (receive only).
TP	Broadcasts which carry traffic announcements.
TA	Traffic announcements are being broadcast.

Timer and sleep operation (Remote Control only)

Timer playback:

The unit turns on and plays the desired source (DVD/CD, USB, TUNER, OPTICAL 1, OPTICAL 2, AUX IN, SCART) at a preset time.

This unit has 2 types of timer: ONCE TIMER and DAILY TIMER.

Once timer: Once timer play works for one time only at a preset time.

Daily timer: Daily timer play works at the same preset time every day.

For example, set the timer as a wake-up call every morning.

Using the once timer and daily timer in combination:

For example, use the once timer to listen to a radio programme, and use the daily timer to wake up.

- 1 Set the daily timer (pages 59 - 61).
- 2 Set the once timer (pages 59 - 61).

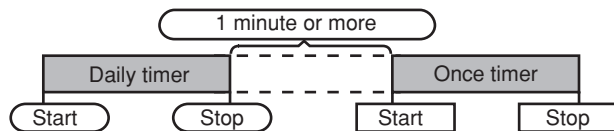

Note:

When set times for the daily timer and once timer overlap, the once timer takes priority. Allow an interval of at least 1 minute between operations.

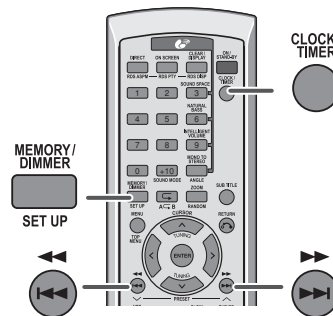

■ Timer playback

Before setting timer:

- 1 Check that the clock is set to the correct time (refer to page 31). If it is not set, you cannot use the timer function.
- 2 For timer playback: Load discs to be played.



- 1 Press the ON/STAND-BY button to turn the power on.
- 2 Press the CLOCK/TIMER button.
- 3 Within 10 seconds, press the ◀◀ or ▶▶ button to select "ONCE" or "DAILY", and press the MEMORY/DIMMER button.



Set the clock to the correct time if "ONCE" or "DAILY" does not appear.

Continued to the next page

Timer and sleep operation (Remote Control only) (continued)

- 4** Within 10 seconds, press the **◀◀** or **▶▶** button to select “ONCE SET” or “DAILY SET”, and press the **MEMORY/DIMMER** button.



- 5** Press the **◀◀** or **▶▶** button to adjust the hour and then press the **MEMORY/DIMMER** button.



The illustrations show the timer playback setting in the daily timer mode.

- 6** Press the **◀◀** or **▶▶** button to adjust the minutes and then press the **MEMORY/DIMMER** button.



- 7** Set the time to finish as in steps 5 and 6 above.

- 8** Switch input with the **◀◀** or **▶▶** button, and then press the **MEMORY/DIMMER** button.

To select the timer playback source: DVD/CD, USB, OPTICAL 1, OPTICAL 2, AUX IN, SCART or TUNER.

- When you select the tuner, select a station by pressing the **◀◀** or **▶▶** button, and then press the **MEMORY/DIMMER** button.
- If a station has not been programmed, “NO PRESET” will be displayed and timer setting will be cancelled.

- 9** Adjust the volume using the **VOLUME** control, and then press the **MEMORY/DIMMER** button.

Do not turn the volume up too high.

- 10** Press the **ON/STAND-BY** button to enter the power stand-by mode.

The “TIMER” indicator lights up and the unit is ready for timer playback.



- 11** When the preset time is reached, playback will start.

The volume will increase gradually until it reaches the preset volume.

- 12** When the timer end time is reached, the system will enter the power stand-by mode automatically.

Once timer:

The timer will be cancelled.

The “☺” indicator will blink during timer playback.

Daily timer:

The timer will operate at the same time every day. It will continue until the daily timer setting is cancelled. Cancel the daily timer when it is not in use.

The “DAILY ☺” indicator will blink during timer playback.

Note:

When performing timer playback using another unit connected to the USB terminal/OPTICAL 1/OPTICAL 2/AUX IN/SCART sockets, select USB or OPTICAL 1 or OPTICAL 2 or AUX or SCART in step 8. This unit will turn on or enter the power stand-by mode automatically. However, the connected unit to USB terminal/OPTICAL 1/OPTICAL 2/AUX IN/SCART sockets will not turn on or off.

Checking the timer setting in the timer stand-by mode:

- 1 Press the CLOCK/TIMER button.
- 2 Within 10 seconds, press the ◀◀ or ▶▶ button to select "ONCE" or "DAILY", and press the MEMORY/DIMMER button.
- 3 Within 10 seconds, press the ◀◀ or ▶▶ button to select "ONCE CALL" or "DAILY CALL", and press the MEMORY/DIMMER button.
The unit returns to the timer stand-by mode after displaying the settings in order.

Cancelling the timer setting in the timer stand-by mode:

- 1 Press the CLOCK/TIMER button.
- 2 Within 10 seconds, press the ◀◀ or ▶▶ button to select "ONCE" or "DAILY", and press the MEMORY/DIMMER button.
- 3 Within 10 seconds, press the ◀◀ or ▶▶ button to select "ONCE OFF" or "DAILY OFF", and press the MEMORY/DIMMER button.
Timer will be cancelled (the setting will not be cancelled).

Reusing the memorised timer setting:

The timer setting will be memorised once it is entered. To reuse the same setting, perform the following operations.

- 1 Turn the power on and press the CLOCK/TIMER button.
- 2 Within 10 seconds, press the ◀◀ or ▶▶ button to select "ONCE" or "DAILY", and press the MEMORY/DIMMER button.
- 3 Within 10 seconds, press the ◀◀ or ▶▶ button to select "ONCE ON" or "DAILY ON", and press the MEMORY/DIMMER button.
- 4 Press the ON/STAND-BY button to enter the power stand-by mode.

■ Sleep operation

The radio, discs and USB can all be turned off automatically.

1 Play back the desired sound source.**2 Press the CLOCK/TIMER button.**

- 3 Within 10 seconds, press the ◀◀ or ▶▶ button to select "SLEEP", and press the MEMORY/DIMMER button.

**4 Press the ◀◀ or ▶▶ button to select the time.**

(Maximum: 3 hours - Minimum: 1 minute)

- 3 hours - 5 minutes → 5-minute intervals
- 5 minutes - 1 minute → 1-minute intervals

5 Press the MEMORY/DIMMER button.

"SLEEP" will appear.

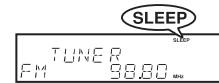
**6 The unit will enter the power stand-by mode automatically after the preset time has elapsed.**

The volume will be turned down 1 minute before the sleep operation finishes.

To confirm the remaining sleep time:

- 1 Whilst "SLEEP" is indicated, press the CLOCK/TIMER button.
 - 2 Within 10 seconds, press the ◀◀ or ▶▶ button to select "SLEEP X : XX".
"X : XX" is sleep remaining time.
- The remaining sleep time is displayed for about 10 seconds.
 - You can change the remaining sleep time whilst it is displayed by pressing the MEMORY/DIMMER button (steps 4 - 5).

Timer and sleep operation (Remote Control only) (continued)

To cancel the sleep operation:

Press the ON/STAND-BY button whilst "SLEEP" is indicated.

To cancel the sleep operation without setting the unit to the stand-by mode, proceed as follows.

- 1 Whilst "SLEEP" is indicated, press the CLOCK/TIMER button.
- 2 Within 10 seconds, press the ◀◀ or ▶▶ button to select "SLEEP OFF", and press the MEMORY/DIMMER button.

■ To use timer and sleep operation together

Sleep and timer playback:

For example, you can fall asleep listening to the radio and wake up to CD the next morning.

- 1 Set the sleep time (see left, steps 1 - 5).
- 2 Whilst the sleep timer is set, set the timer playback (steps 2 - 10, pages 59 - 60).

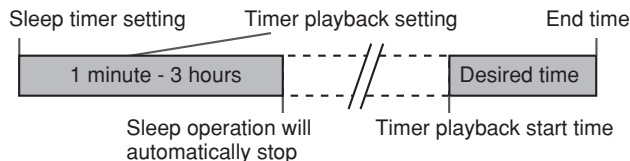

Headphone connection

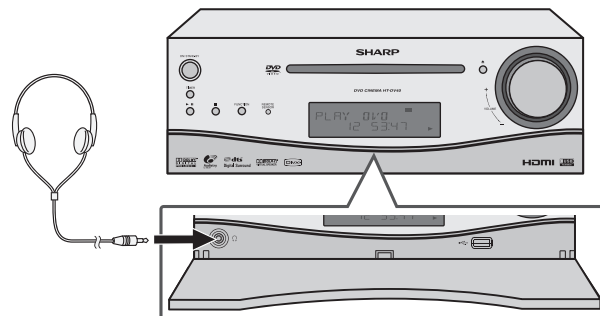

- Do not turn the volume on to full at switch on. Listen to music at moderate levels. Excessive sound pressure from earphones and headphone can cause hearing loss.
- Before plugging in or unplugging the headphone, reduce the volume.
- Be sure your headphone have a 3.5 mm (1/8") diameter plug and impedance between 16 and 50 ohms. The recommended impedance is 32 ohms.
- Plugging in the headphone disconnects the speakers automatically. Adjust the volume using the VOLUME control.

Troubleshooting chart

Many potential problems can be resolved by the owner without calling a service technician.

If something is wrong with this product, check the following before calling your authorised SHARP dealer or service centre.

■ General

Symptom	Possible cause
<ul style="list-style-type: none"> ● The power is not turned on. 	<ul style="list-style-type: none"> ● Is the unit unplugged?
<ul style="list-style-type: none"> ● No sound is heard. 	<ul style="list-style-type: none"> ● Is the volume level set to "0"? ● Are the headphones connected? ● Are the speaker wires disconnected?
<ul style="list-style-type: none"> ● The sounds from speakers are not well balanced. 	<ul style="list-style-type: none"> ● Are the speaker wires connected to the wrong channels?
<ul style="list-style-type: none"> ● Noise is heard during playback. 	<ul style="list-style-type: none"> ● Move the unit away from any computers or mobile phones.
<ul style="list-style-type: none"> ● When a button is pressed, the unit does not respond. 	<ul style="list-style-type: none"> ● Set the unit to the power stand-by mode and then turn it back on. ● If the unit still malfunctions, disconnect the unit from the mains for 30 seconds, then reconnect.
<ul style="list-style-type: none"> ● Interference or noise occurs on the TV image. 	<ul style="list-style-type: none"> ● Is the unit placed near TV with internal aerial? Use an external aerial.
<ul style="list-style-type: none"> ● The display on the unit is dark. 	<ul style="list-style-type: none"> ● Is the display in the dimmer mode?
<ul style="list-style-type: none"> ● No images are displayed. 	<ul style="list-style-type: none"> ● Is the TV turned on? ● Is the TV input switched on?

■ DVD player

Symptom	Possible cause
<ul style="list-style-type: none"> ● Even though a disc is loaded, "No Disc" is displayed. 	<ul style="list-style-type: none"> ● Is the disc loaded upside down? ● Is the disc very dirty? ● Does the disc satisfy the standards? ● Is the unit located near excessive vibrations?
<ul style="list-style-type: none"> ● Playback sounds are skipped. 	<ul style="list-style-type: none"> ● Is condensation formed inside the unit?
<ul style="list-style-type: none"> ● The control buttons do not function. Music or video playback is interrupted. 	<ul style="list-style-type: none"> ● Is the disc very dirty? ● Does the disc satisfy the standards? ● Is the unit located near excessive vibrations? ● Is condensation formed inside the unit?
<ul style="list-style-type: none"> ● Pictures and sound are skipped. 	<ul style="list-style-type: none"> ● Is the disc very dirty? ● Is the unit located near excessive vibrations? ● Is condensation formed inside the unit?
<ul style="list-style-type: none"> ● The unit does not operate even if the power is on. 	<ul style="list-style-type: none"> ● Is a disc other than a DVD (region number at the back of the unit), audio CD, CD-R or CD-RW loaded?
<ul style="list-style-type: none"> ● Images cannot be played back. (Sound is not heard.) 	<ul style="list-style-type: none"> ● Are the video and audio cables connected improperly? ● Is a disc other than a DVD (region number 2 or ALL), audio CD, CD-R or CD-RW loaded? ● Is the disc very dirty? ● Is the disc loaded upside down? ● Is the optical pick up dirty? ● Is the TV input set to video (VIDEO 1, VIDEO 2, etc.)? ● Is the unit turned on?

Troubleshooting chart (continued)

■ USB

Symptom	Possible cause
<ul style="list-style-type: none"> ● Device cannot be detected. 	<ul style="list-style-type: none"> ● Is there any MP3/WMA file available? ● Is the device properly connected? ● Is it MTP device? ● Does the device contain AAC files only?
<ul style="list-style-type: none"> ● Playback does not start. 	<ul style="list-style-type: none"> ● Is it a copyright protected WMA file? ● Is it a false MP3 file?
<ul style="list-style-type: none"> ● Wrong time display. ● Wrong file name display. 	<ul style="list-style-type: none"> ● Is Variable Bitrate file being played back? ● Is the File Name written in Chinese or Japanese characters?

■ Remote control

Symptom	Possible cause
<ul style="list-style-type: none"> ● The remote control does not operate. 	<ul style="list-style-type: none"> ● Is the AC power lead of the unit plugged in? ● Is the battery polarity correct? ● Are the batteries dead? ● Is the distance or angle incorrect? ● Is there a strong light shining on the remote sensor?

■ Tuner

Symptom	Possible cause
<ul style="list-style-type: none"> ● The radio makes unusual noises continuously. 	<ul style="list-style-type: none"> ● Is the unit placed near the TV or computer? ● Is the FM aerial or AM loop aerial placed properly? Move the aerial away from the AC power lead if it is located nearby.

■ Condensation

Sudden temperature changes, storage or operation in an extremely humid environment may cause condensation inside the cabinet (CD pickup, etc.) or on the transmitter on the remote control. Condensation can cause the unit to malfunction. If this happens, leave the power on with no disc in the unit until normal playback is possible (about 1 hour). Wipe off any condensation on the transmitter with a soft cloth before operating the unit.

■ If trouble occurs

When this product is subjected to strong external interference (mechanical shock, excessive static electricity, abnormal supply voltage due to lightning, etc.) or if it is operated incorrectly, it may malfunction.

- 1 Set the unit to the stand-by mode and turn the power on again.
- 2 If the unit is not restored in the previous operation, unplug and plug in the unit, and then turn the power on.

Note:

If neither operation above restores the unit, clear all the memory by resetting it.

■ Before transporting the unit

Remove the CD from the unit. Make sure there is no CD in the disc tray. Then, set the unit to the power stand-by mode. Carrying the unit with disc left inside can damage the unit.

■ Factory reset, clearing all memory

- 1 Press the ON/STAND-BY button to enter the power stand-by mode.
- 2 Whilst pressing down the ▲ button, press the ON/STAND-BY button until "CLEAR ALL" appears.



Caution:

This operation will erase all data stored in memory including clock, timer settings, tuner preset and CD programme.

■ Error indicators and warning

When you load an unplayable disc or fail to perform operations properly, the following messages are displayed on the unit and the TV screen.

Display	Meaning
E7	<ul style="list-style-type: none"> ● Malfunction of surround circuit. ● Place the unit away from noise source and plug the AC power lead into another wall socket. (*)
ERROR	<ul style="list-style-type: none"> ● The unit considers the DVD mechanism is defective. (*)
FAN LOCK	<ul style="list-style-type: none"> ● The cooling fan on the rear of the unit does not run. Unplug the AC power lead and check if foreign object get caught around the cooling fan.
NO DISC	<ul style="list-style-type: none"> ● The disc is not loaded.
NO SIGNAL	<ul style="list-style-type: none"> ● The digital audio input socket is not connected properly. ● Unspecified signal is received and cannot be recognised.
NO SUPPORT	<ul style="list-style-type: none"> ● When copyright protected WMA file is played back.

(*): Set the main unit to the stand-by mode and turn the power on again, or unplug and plug it back in. Should the same message appear, contact your authorised SHARP dealer or service centre.

■ Care of compact discs

Compact discs are fairly resistant to damage, however mistracking can occur due to an accumulation of dirt on the disc surface. Follow the guidelines below for maximum enjoyment from your CD collection and player.

- Do not write on either side of the disc, particularly the non-label side from which signals are read. Do not mark this surface.
- Keep your discs away from direct sunlight, heat, and excessive moisture.
- Always hold the CDs by the edges. Fingerprints, dirt, or water on the CDs can cause noise or mistracking. If a CD is dirty or does not play properly, clean it with a soft, dry cloth, wiping straight out from the centre, along the radius.

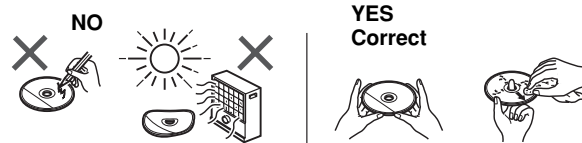

Maintenance

■ Cleaning the cabinet

Periodically wipe the cabinet with a soft cloth and a diluted soap solution, then with a dry cloth.

Caution:

- Do not use chemicals for cleaning (petrol, paint thinner, etc.). It may damage the cabinet finish.
- Do not apply oil to the inside of the unit. It may cause malfunctions.

■ Cleaning the CD pickup lens

Poor performance during CD playback (skipping or jumping) can be caused by a dirty or contaminated CD laser pick up lens. If this happens then the use of a commercially available CD lens cleaning discs may restore normal operation. Contact your supplier or local CD software dealer to obtain CD lens cleaning discs. Ensure all included instructions/documentation are carefully followed.

Specifications

As part of our policy of continuous improvement, SHARP reserves the right to make design and specification changes for product improvement without prior notice. The performance specification figures indicated are nominal values of production units. There may be some deviations from these values in individual units.

■ Main unit

Power source	AC 220 - 240 V ~ 50 Hz
Power consumption	Power on: 82 W Power stand-by: 0.6 W (*)
Output power	Speaker: RMS: 150 W (75 W + 75 W) (10% T.H.D.) RMS: 90 W (45 W + 45 W) (0.9% T.H.D.) Subwoofer: RMS: 100 W (10% T.H.D.) RMS: 55 W (0.9% T.H.D.)
Video output terminals	SCART output: SCART terminal x 1 Video output: RCA type x 1 S-video output: S-terminal x 1 Component video output: (Y/P _B /P _R) x 1 HDMI output : HDMI x 1 Support 480p/570p/1080i output formats.
Audio input terminals	Optical digital input (DIGITAL 1): Square type x 1 Optical digital input (DIGITAL 2): Square type x 1 Analogue input : 500 mV/47 k ohms
Audio output terminals	Speakers: 4 ohms Subwoofer: 12 ohms Headphones: 16 - 50 ohms (recommended: 32 ohms)
Dimensions	Width: 300 mm (11-13/16") Height: 106 mm (4-1/8") Depth: 300 mm (11-13/16")
Weight	3.8 kg (8.4 lbs.)

(*) This power consumption value is obtained when the demonstration mode is cancelled in the power stand-by mode. Refer to page 19 to cancel the demonstration mode.

■ USB

USB host interface	<ul style="list-style-type: none"> ● Complies with USB 1.1/2.0 (Full Speed) Mass Storage Class. ● Support Bulk only and CBI protocol.
Support file	<ul style="list-style-type: none"> ● MPEG 1 Layer 3 ● MPEG 2 Layer 3 ● WMA (Non DRM)
Bitrate support	<ul style="list-style-type: none"> ● MP3 (32 - 320 kbps) ● WMA (64 - 160 kbps)
Other	<ul style="list-style-type: none"> ● Maximum total number of MP3/WMA files is 1200. ● The ID3TAG information supported are TITLE, ARTIST and ALBUM only. ● Support ID3TAG version 1 and version 2.
File system support	<ul style="list-style-type: none"> ● Support USB devices with Microsoft Windows/DOS/FAT 12/FAT 16/FAT 32. ● 2 kbyte block length for sector.

■ Tuner

Frequency range	FM: 87.5 - 108 MHz
Other	Maximum station can be stored is 30 preset.

■ DVD player

Signal system	PAL/NTSC colour	
Supported disc types	DVD (with the same region number at the back of the unit), audio CD, CD-R, CD-RW, JPEG, DivX (version 3 ~ 6)	
Video signal	Horizontal resolution: 500 lines S/N ratio: 70 dB	
Audio signal	Frequency characteristics	Linear PCM DVD: 20 Hz to 20 kHz (sampling rate: 48 kHz) 20 Hz to 20 kHz (sampling rate: 96 kHz) CD: 20 Hz to 20 kHz
	S/N ratio	CD: 94 dB (1 kHz)
	Dynamic range	Linear PCM DVD: 95 dB CD: 94 dB
	Total harmonic distortion ratio	0.01% maximum

■ CP-DV40H Speaker

Type	2-way type speaker system 2.5 cm (1") tweeter 8 cm (3-1/8") woofer (x 2)
Maximum input power	150 W
Rated input power	75 W
Impedance	4 ohms
Dimensions	Width: 300 mm (11-13/16") Height: 129 mm (5-1/16") Depth: 160 mm (6-5/16")
Weight	2.1 kg (4.6 lbs.)/each

■ CP-DV50H Speaker

Type	2-way type speaker system 2.5 cm (1") tweeter 6.5 cm (2-1/2") woofer (x 3)
Maximum input power	150 W
Rated input power	75 W
Impedance	4 ohms
Dimensions	Width: 100 mm (3-15/16") Height: 1243 mm (48-15/16") Depth: 114 mm (4-1/2")
Weight	7.1 kg (15.65 lbs.)/each

■ Subwoofer

Type	Subwoofer system 20 cm (8 ") subwoofer
Maximum input power	200 W
Rated input power	100 W
Impedance	12 ohms
Dimensions	Width: 220 mm (8-11/16") Height: 354 mm (13-15/16") Depth: 438 mm (17-1/4")
Weight	7.6 kg (16.7 lbs.)

SHARP

SHARP CORPORATION

TINSEA226AWZZ
07M R AS ①

Free Manuals Download Website

<http://myh66.com>

<http://usermanuals.us>

<http://www.somanuals.com>

<http://www.4manuals.cc>

<http://www.manual-lib.com>

<http://www.404manual.com>

<http://www.luxmanual.com>

<http://aubethermostatmanual.com>

Golf course search by state

<http://golfingnear.com>

Email search by domain

<http://emailbydomain.com>

Auto manuals search

<http://auto.somanuals.com>

TV manuals search

<http://tv.somanuals.com>