

SHARP®

LIQUID CRYSTAL DISPLAY CAMCORDER

MODEL

**VL-WD450U
VL-WD650U**

■ OPERATION MANUAL ■

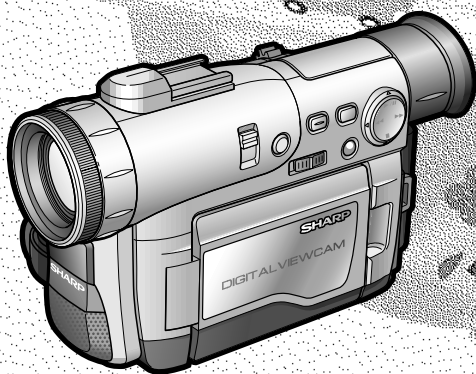

SHARP VIEWCAM

Mini **DV**

•The **Mini DV** logo is a trademark.

Please read this operation manual carefully before using the VIEWCAM.

Important

For assistance in reporting the theft or loss of this product, record on the line below the model number and serial number which are located on the bottom of the unit. Please retain this information.

Model No.:

Serial No.:

- See page 93 for use of Demo mode.
- The images of the VIEWCAM in this operation manual are based upon the VL-WD450U.

Thank you for purchasing this camcorder from SHARP. The camcorder will enhance your home video enjoyment and allow you to capture those special moments. Please read this operation manual to familiarize yourself with the camcorder's features, so that you will get the most out of it. The video techniques section will help you fully enjoy the many features this camcorder offers, and expand your video world.

Important Information for Consumers in the U.S.

WARNING: TO REDUCE THE RISK OF FIRE OR ELECTRIC SHOCK, DO NOT EXPOSE THIS APPLIANCE TO RAIN OR MOISTURE.



CAUTION:
TO REDUCE THE RISK OF ELECTRIC SHOCK, DO NOT REMOVE COVER. NO USER-SERVICEABLE PARTS INSIDE. REFER SERVICING TO QUALIFIED SERVICE PERSONNEL.

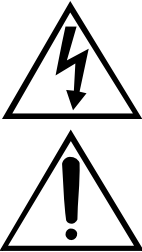

This symbol warns the user of uninsulated voltage within the unit that can cause dangerous electric shocks.

This symbol alerts the user that there are important operating and maintenance instructions in the literature accompanying this unit.

CAUTION

(applies to the supplied AC adapter)

TO PREVENT ELECTRIC SHOCK, MATCH WIDE BLADE OF PLUG TO WIDE SLOT, FULLY INSERT.

CAUTION

If the AC adapter is misplaced or needs to be replaced, obtain the same type of adapter from a SHARP service center of your dealer.

PRODUCT DISPOSAL

This Product utilizes tin-lead solder, and a fluorescent lamp containing a small amount of mercury. Disposal of these materials may be regulated due to environmental considerations. For disposal or recycling information, please contact your local authorities or the Electronics Industries Alliance: www.eiae.org.

BATTERY DISPOSAL

CONTAINS LITHIUM-ION RECHARGEABLE BATTERY. MUST BE RECYCLED OR DISPOSED OF PROPERLY. CONTACT LOCAL AGENCIES FOR INFORMATION ON RECYCLING AND DISPOSAL PLANS IN YOUR AREA.

WARNING—FCC Regulations state that any unauthorized changes or modifications to this equipment not expressly approved by the manufacturer could void the user's authority to operate this equipment.

NOTE

This equipment has been tested and found to comply with the limits for a Class B digital device pursuant to Part 15 of the FCC Rules. These limits are designed to provide reasonable protection against harmful interference in a residential installation. This equipment generates, uses, and can radiate radio frequency energy and, if not installed and used in accordance with the instructions, may cause harmful interference to radio communications. However, there is no guarantee that interference will not occur in a particular installation. If this equipment does cause harmful interference to radio or television reception, which can be determined by turning the equipment off and on, the user is encouraged to try to correct the interference by one or more of the following measures:

- Reorient or relocate the receiving antenna.
- Increase the distance between the equipment and receiver.
- Connect the equipment into an outlet on a circuit different from that to which the receiver is connected.
- Consult the dealer or an experienced radio/TV technician for help.

A shielded I/F cable is required to insure compliance with FCC regulations for Class B computing equipment.

DECLARATION OF CONFORMITY

Sharp Camcorder

This device complies with Part 15 of the FCC Rules. Operation is subject to the following two conditions: (1) This device may not cause harmful interference, and (2) this device must accept any interference received, including interference that may cause undesired operation.

RESPONSIBLE PARTY:

SHARP ELECTRONICS CORPORATION
Sharp Plaza, Mahwah, New Jersey 07430
Phone: 1-800-BE-SHARP

CAUTION ON LITHIUM BATTERY (MEMORY BACKUP BATTERY)

If a battery is reversed (positive end where the negative end belongs and vice versa), it can overheat and rupture. This has happened when young children install batteries backwards. Warn children *not* to take out batteries or install them. *Parents should install the lithium battery in the camcorder.*

COPYRIGHT WARNING: It is the intent of SHARP that this unit be used in full compliance with the copyright laws of the United States and that prior permission be obtained from copyright owners whenever necessary.

NOTE

The camcorder's LCD panel is a very high technology product with more than 61,000 (VL-WD450U)/close to 90,000 (VL-WD650U) thin-film transistors*, giving you fine picture detail. Occasionally, a pixel may appear on the screen as a fixed point of blue, green, red, or black. Please note that this does not affect your camcorder's performance.

*Specifications are subject to change without notice.

Trademarks

- SmartMedia is a trademark of Toshiba Corporation.
- DPOF is a trademark of CANON INC., Eastman Kodak Company, Fuji Photo Film Co., Ltd. and Matsushita Electric Industrial Co., Ltd.
- All other brand or product names are registered trademarks or trademarks of their respective holders.

IMPORTANT SAFEGUARDS

1. Read Instructions—All the safety and operating instructions should be read before the product is operated.
2. Retain Instructions—The safety and operating instructions should be retained for future reference.
3. Heed Warnings—All warnings on the product and in the operating instructions should be adhered to.
4. Follow Instructions—All operating and use instructions should be followed.
5. Cleaning—Unplug this product from the wall outlet before cleaning. Do not use liquid cleaners or aerosol cleaners. Use a damp cloth for cleaning.
6. Attachments—Do not use attachments not recommended by the product manufacturer as they may cause hazards.
7. Water and Moisture—Do not use this product near water—for example, near a bath tub, wash bowl, kitchen sink, or laundry tub; in a wet basement; or near a swimming pool; and the like.
8. Accessories—Do not place this product on an unstable cart, stand, tripod, bracket, or table. The product may fall, causing serious injury to a child or

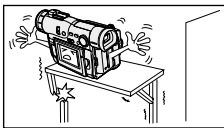

adult, and serious damage to the product. Use only with a cart, stand,

tripod, bracket, or table recommended by the manufacturer, or sold with the product. Any mounting of the product should follow the manufacturer's instructions, and should use a mounting accessory recommended by the manufacturer.

9. A product and cart combination should be moved with care. Quick stops, excessive force, and uneven surfaces may cause the product and cart combination to overturn.



10. Ventilation—Slots and openings in the cabinet are provided for ventilation and to ensure reliable operation of the product and to protect it from overheating, and these openings must not be blocked or covered. The openings should never be blocked by placing the

product on a bed, sofa, rug, or other similar surface. This product should not be placed in a built-in installation such

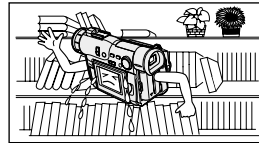

as a bookcase or rack unless proper ventilation is provided or

the manufacturer's instructions have been adhered to.

11. Power Sources—This product should be operated only from the type of power source indicated on the marking label. If you are not sure of the type of power supply to your home, consult your product dealer or local power company. For products intended to operate from battery power, or other sources, refer to the operating instructions.
12. Grounding or Polarization—This product may be equipped with a polarized alternating-current line plug (a plug having one blade wider than the other). This plug will fit into the power outlet only one way. This is a safety feature. If you are unable to insert the plug fully into the outlet, try reversing the plug. If the plug should still fail to fit, contact your electrician to replace your obsolete outlet. Do not defeat the safety purpose of the polarized plug.
13. Power-Cord Protection—Power-supply cords should be routed so that they are not likely to be walked on or pinched by items placed upon or against them, paying particular attention to cords at plugs, convenience receptacles, and the point where they exit from the product.
14. Lightning—For added protection for this product during a lightning storm, or when it is left unattended and unused for long periods of time, unplug it from the wall outlet and disconnect the antenna or cable system. This will prevent damage to the product due to lightning and power-line surges.

-
15. Power Lines—An outside antenna system should not be located in the vicinity of overhead power lines or other electric light or power circuits, or where it can fall into such power lines or circuits. When installing an outside antenna system, extreme care should be taken to keep from touching such power lines or circuits as contact with them might be fatal.
 16. Overloading—Do not overload wall outlets, extension cords, or integral convenience receptacles as this can result in a risk of fire or electric shock.
 17. Object and Liquid Entry—Never push objects of any kind into this product

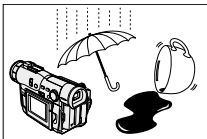

through openings as they may touch dangerous voltage points or short-out parts that could result in a fire or electric shock. Never spill liquid of any kind on the product.

18. Servicing—Do not attempt to service this product yourself as opening or removing covers may expose you to dangerous voltage or other hazards. Refer all servicing to qualified service personnel.
19. Damage Requiring Service—Unplug this product from the wall outlet and refer servicing to qualified service personnel under the following conditions:
 - a. When the power-supply cord or plug is damaged,
 - b. If liquid has been spilled, or objects have fallen into the product,
 - c. If the product has been exposed to rain or water,
 - d. If the product does not operate normally by following the operating instructions. Adjust only those controls that are covered by the operating instructions as an improper adjustment of other controls may result in damage and will often require extensive work by a qualified technician to restore the product to its normal operation,
 - e. If the product has been dropped or damaged in any way, and

- f. When the product exhibits a distinct change in performance—this indicates a need for service.
20. Replacement Parts—When replacement parts are required, be sure the service technician has used replacement parts specified by the manufacturer or have the same characteristics as the original part. Unauthorized substitutions may result in fire, electric shock, or other hazards.
21. Safety Check—Upon completion of any service or repairs to this product, ask the service technician to perform safety checks to determine that the product is in proper operating condition.
22. Wall or Ceiling Mounting—The product should be mounted to a wall or ceiling only as recommended by the manufacturer.
23. Heat—The product should be situated away from heat sources such as radiators, heat registers, stoves, or other products (including amplifiers) that produce heat.

Quick Operation Guide

Please consult this operation manual further for details on these and other functions of your camcorder.

Charging the Battery Pack

- 1 Connect the supplied power cord to the AC power socket on the AC adapter/ battery charger, and insert the AC plug into a power outlet.
- 2 Align the ▼ mark on the battery pack with the ▲ mark on the charger (①) and guide the battery into the groove. Pressing the battery (②), slide it in the direction of the arrow (③) until it locks into place.

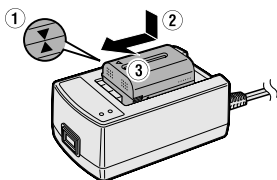

Attaching the Battery Pack

- 1 Make sure that the Power switch is set to OFF.
- 2 Lift up the viewfinder.
- 3 Align the ■ mark on the side of the battery pack with the ◀ mark on the camcorder (①), and slide the battery pack down completely until it locks into place (②).

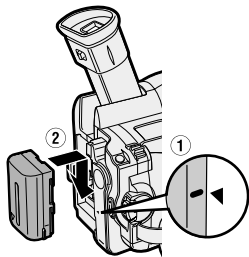

Turning the Power on

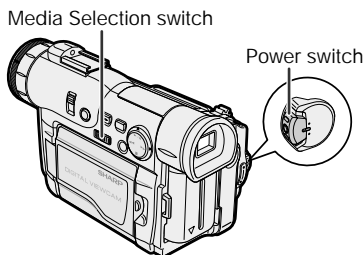

To use the camera recording functions, hold down the Lock button and set the Power switch to CAMERA.

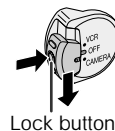

To use the playback and editing functions, hold down the Lock button and set the Power switch to VCR.

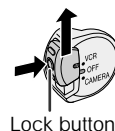

Switching the Media

To use a mini DV cassette for recording and playing back images, set the Media Selection switch to TAPE.

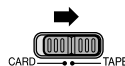

To use a SmartMedia card for recording and playing back still images, set the Media Selection switch to CARD.

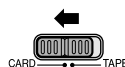

Turning the Power off

Set the Power switch to OFF without pressing the Lock button.

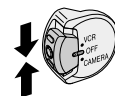

Inserting a Mini DV Cassette

- 1 Attach the power source to the camcorder, then slide the cassette compartment door release and open the cassette compartment door.

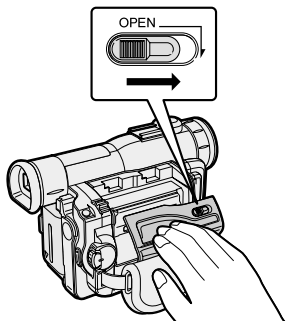

- 2 Insert the cassette fully with the window facing outwards, and with the erasure protect tab facing upwards.

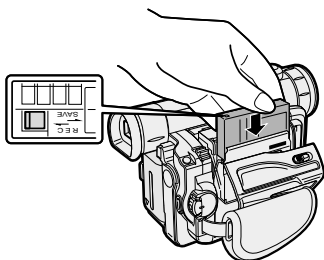

- 3 Press the **PUSH/押し** mark gently until the cassette holder clicks into place. Close the compartment door by pressing the center until it clicks into place.

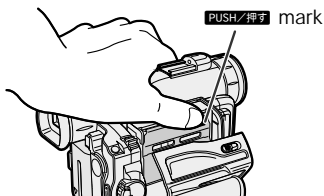

Inserting a SmartMedia Card

- 1 Make sure that the power switch is set to OFF.
- 2 Open the LCD monitor.

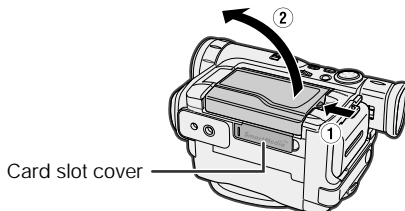

- 3 Open the card slot cover in the direction of arrow.

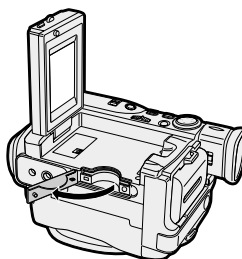

- 4 Insert a SmartMedia card into the slot as shown below, and push it in as far as it will go.

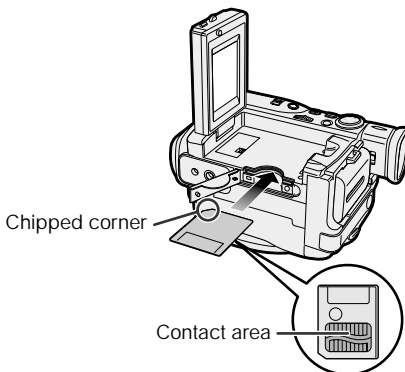

- 5 Close the card slot cover.

Easy Camera Recording on Tape

- 1 Make sure that a cassette is inserted.
- 2 Remove the lens cap, and lift up the viewfinder.
- 3 Set the Media Selection switch to TAPE.
- 4 Hold down the Lock button and set the Power switch to CAMERA.
- 5 Press the REC START/STOP button to begin recording.

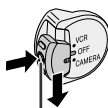

Lock button

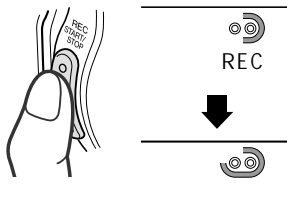

Zooming

Push the Power Zoom control to T (1) (telephoto) or W (2) (wide angle) side.

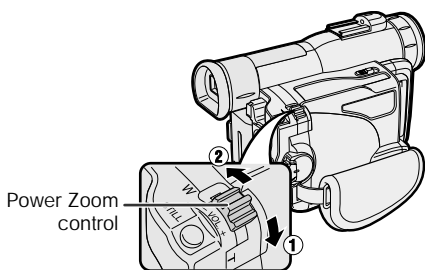

Tape Playback

- 1 Press the LCD monitor OPEN release button (1), and open the LCD monitor to a 90° angle to the camcorder body (2).

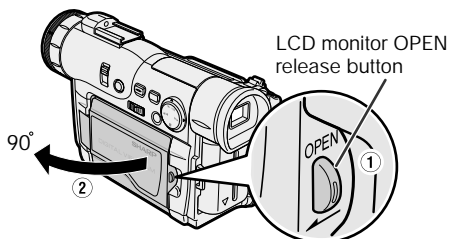

- 2 Adjust the LCD monitor to an angle that allows easy viewing on the on-screen picture.

- 3 Set the Media Selection switch to TAPE.

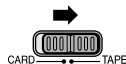

- 4 Hold down the Lock button and set the Power switch to VCR.

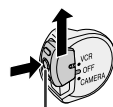

Lock button

- 5 Press ◀◀ (or ▶▶) on the Operation button to rewind (or fast forward) the tape to the desired point.

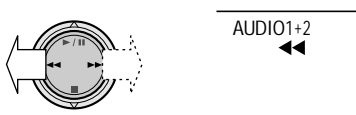

- 6 Press ▶▶ to begin playback.

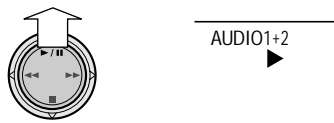

To stop playback

Press ■.

Card Recording

- 1 Make sure that a SmartMedia card is inserted.
- 2 Remove the lens cap, and lift up the viewfinder.
- 3 Set the Media Selection switch to CARD.
- 4 Hold down the Lock button and set the Power switch to CAMERA.
- 5 Press the STILL button to begin recording.

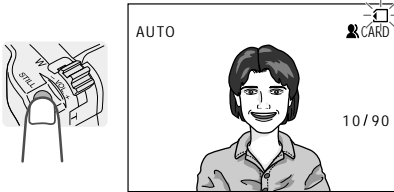
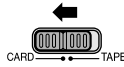

Card Playback

- 1 Press the LCD monitor OPEN release button (①), and open the LCD monitor to a 90° angle to the camcorder body (②).

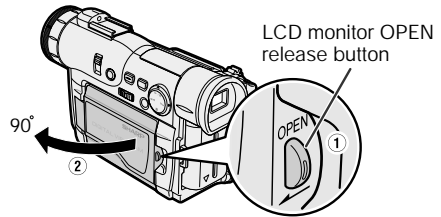

- 2 Adjust the LCD monitor to an angle that allows easy viewing on the on-screen picture.

- 3 Set the Media Selection switch to CARD.

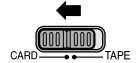

- 4 Hold down the Lock button and set the Power switch to VCR.

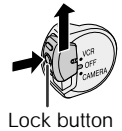

- 5 Press ◀ or ▶ on the Operation button to move the selection frame to the desired image.

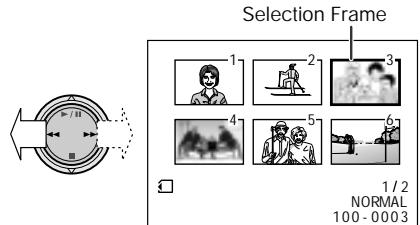

- 6 Press ▶ / II.

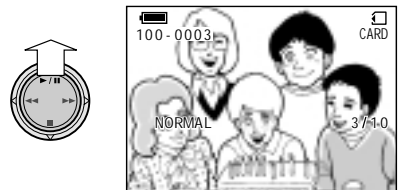

Supplied Accessories

 <p>Battery pack BT-L221^{*1}</p>	 <p>AC adapter/ battery charger UADP-0321TAZZ^{*1}</p>	 <p>Power cord QACCD0031TAPZ</p>	 <p>DC cable QCNW-1957TAZZ</p>
 <p>Remote control RRMCG0100TASA</p>	 <p>AA battery for remote control × 2</p>	 <p>CR2025 type lithium battery</p>	 <p>Audio/video cable (RCA type) QCNW-2016TAZZ</p>
 <p>Lens cap GCOVH1271TASA</p>	 <p>Shoulder strap UBNSD0010TASA</p>	 <p>PixLab Video Capture Software (Lite Version) CDSKA0059TA01</p>	 <p>PC connecting cable QCNW-2022TAZZ</p>
 <p>3.3 V type 8 MB SmartMedia™ card^{*2}</p>	 <p>SmartMedia card protective case</p>	 <p>Zoom microphone RMICC0098TAZZ</p>	 <p>Windscreen</p>

^{*1}The part numbers for the AC adapter/battery charger and battery pack supplied with this camcorder are valid only in the U.S. and Latin America. If this camcorder was purchased outside of these areas, the part numbers may be different. Please refer to the part numbers printed on the labels of the supplied AC adapter/battery charger and battery pack.

^{*2}Including 2 index labels and 4 write-protect seals.

Optional Accessories



Standard-life
battery pack
BT-L221

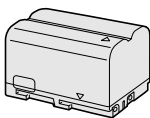

Extended-life
battery pack
BT-L441

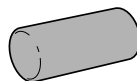
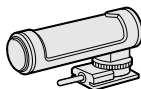

Zoom microphone
VR-5MCN

Note: The listed model names are for U.S. accessories.

For optional and additional accessories, contact your local dealer, call the Sharp Accessories and Supply Center at 1-800-642-2122, or visit SHARP's website (<http://www.sharp-usa.com>).

Precautions

- **When the camcorder is not in use, remember to remove the cassette tape, turn off the power, and disconnect the camcorder from the power source.**

- **Do not aim the lens at the sun.**

Do not allow direct sunlight to strike the camcorder lens or LCD monitor screen, whether or not recording is in progress, as it may damage the CCD sensor or LCD screen surface. Be particularly careful when recording outside.

- When shooting in dark places, avoid sudden brightly lit objects or light sources, such as the sun. Otherwise, the image may white out. Should this happen, point the lens in a different direction until the picture returns to normal.

- **Avoid magnetic sources.**

Using the camcorder near strong fluorescent lights, motors, televisions, or other magnetic sources may adversely affect recorded images.

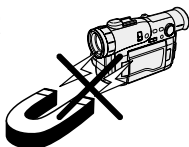

- **Using the camcorder near a broadcasting station or other powerful transmission source may cause buzzing or picture deterioration.**

- **Avoid shocks and dropping.**

Do not drop or otherwise subject the camcorder to hard shocks or strong vibrations. Bumping or striking the unit during recording will generate noise in the recorded image.

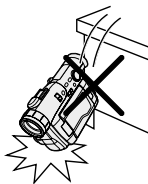

- **Avoid placing the camcorder in close proximity to lighting equipment.**

The heat from incandescent lights may deform the camcorder, or cause it to malfunction.

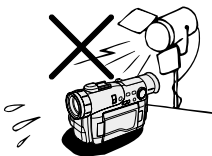

- **Always respect prohibitions or restrictions on the use of electronic equipment on commercial flights or in other sensitive areas.**

- **Be aware of the temperature and humidity.**

You can use your camcorder at 32°F to 104°F (0°C to +40°C), and at 30% to 80% relative humidity. Do not store the unit in an unventilated car in the summer, in direct sunlight, or near strong heat sources; this can result in severe damage to the unit casing and circuitry.



- **Avoid situations where water, sand, dust or other foreign matter could get on or inside the camcorder, and do not use or leave your camcorder in areas with excessive smoke, steam or moisture.**

Such environments can cause malfunctions or cause mildew to form on the lenses. Be sure to keep the unit in a well-ventilated location.

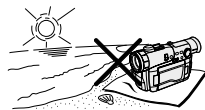

- **Some small, portable tripods may be difficult to attach and may not be sturdy enough to support your camcorder. Be sure to use only a strong, stable tripod.**



- **When using your camcorder in a cold environment, the LCD monitor screen often appears less bright immediately after the power is turned on. This is not a malfunction. To prevent the camcorder from becoming too cold, wrap it in a thick cloth (a blanket, etc.).**

Contents

Operation References

Part Names	1
Quick Reference List	4
On-screen Display Index	5
Warning Indicators	7

Preparation

Charging the Battery Pack	9
Attaching and Removing the Battery Pack	10
Powering the Camcorder from an AC Outlet	11
Inserting and Removing a Mini DV Cassette	12
Installing the Lithium Memory Battery	13
Selecting the Language for the On-screen Display	14
Setting the Area, Date and Time	15
Displaying the Date and Time of Recording	16
Adjusting the Hand Strap	17
Using the Lens Cap	17
Attaching the Shoulder Strap	17
Using the Viewfinder	18
Using the LCD Monitor	19

Basic Operations

Camera Recording

Easy Camera Recording on Tape in Full Auto Mode	20
Zooming	21
Tips on Recording Positions	21
Remaining Recording Time Display	22
Remaining Battery Power Display	22

Playback

Tape Playback	23
Volume Control	23
Watching the Playback on a TV	24
Video Search	25
Still	25

Useful Features

Selecting the Camcorder Mode	26
Using the Controls	27
Selecting the User Mode	28
Using the Menu Screens	29

Camera Recording

Recording in LP (Long Play Recording) Mode	30
Selecting the 16-bit Audio Recording Mode	31
Digital Image Stabilization (DIS)	31
Setting the Digital Zoom	32
Gamma Brightness Compensation	33
Gain-up	34
Night Recording (Super Cat's Eye)	35

Contents

Useful Features

Quick Return	36
Edit Search	36
Fade In and Fade Out	37
Wide Screen (16:9)	38
Still Recording on Tape	39
Still Recording Effects	40
Letting the Subject Monitor the Shot	42
Auto Focus	43
Macro Shots	43
Using the Remote Control	43

Playback

Playback Functions with the Remote Control	45
Using the Time Code	46

Advanced Features

Camera Recording

Manual Focus	47
Setting the Shutter Speed	49
Manual Exposure	51
White Balance Lock	52
Digital Picture Effects	53
Scene Menu (Program AE)	54
Using the Zoom Microphone	55
Windbreak	56
Setting the Confirmation Sounds	56
World Clock	57
Selecting Daylight Saving Time	59

Playback

Playback Zoom	60
Gamma Playback	61
Multiple Strobe Playback	61
Playback Effects	62
Picture Effect Playback	63
Picture/Backlight Adjustments	64
Editing	65
Recording from an External Source	66
Editing with the DV Terminal (IEEE1394)	67
Audio Dubbing Feature	68
Selecting the Audio Playback Mode	70
Configuring Software for PC Connection	71

SmartMedia Card Features

Camera Recording

Inserting and Removing a SmartMedia Card	73
Card Recording	74
Selecting the Picture Resolution	75
Recording with the Self-timer	76
Formatting a SmartMedia Card	77

Playback

Card Playback	78
Slide Show Playback	79
Delete-protection	80
Deleting One Stored Image	81
Deleting All Stored Images	82
Print Order	83
Transferring the Data on a SmartMedia Card to a Computer	85

Appendix

Useful Information	86
Demonstration Mode	93
Before Requesting Service	94
Specifications	96

- Guía de operación rápida en español
- Visualizaciones en pantalla en español
- Affichages sur écran en français

97
101
103

Operation References

Part Names

For details on the use of each part, refer to the page number indicated in brackets.

Left view

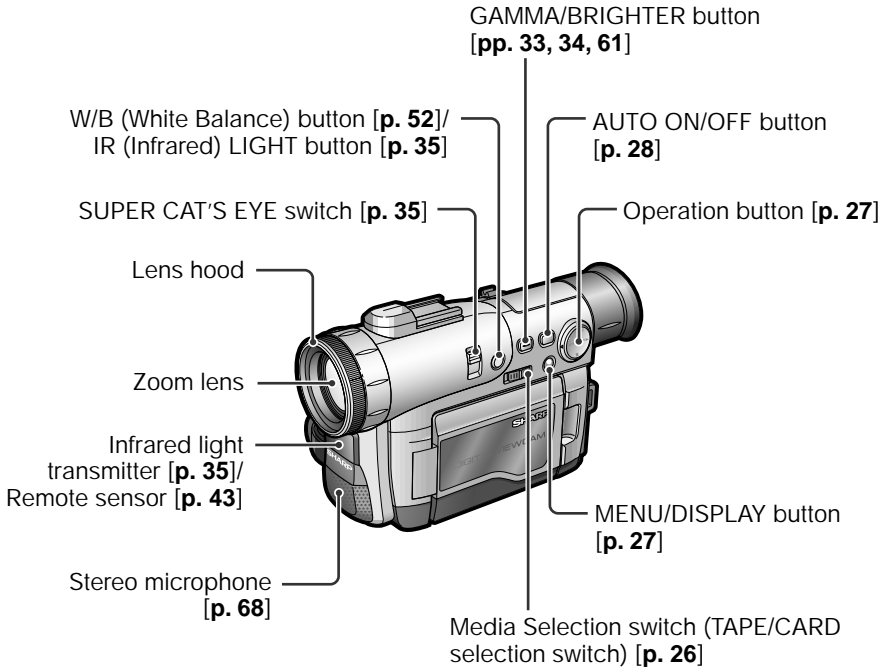

Left view

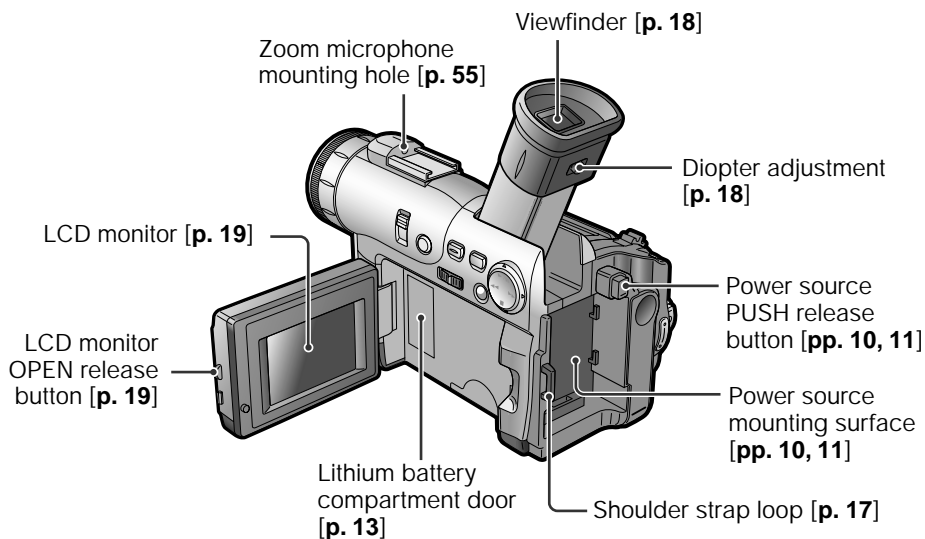

Bottom view

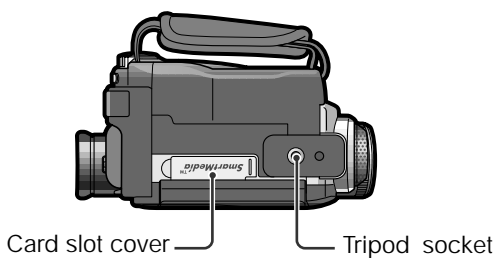

Operation References

Right view

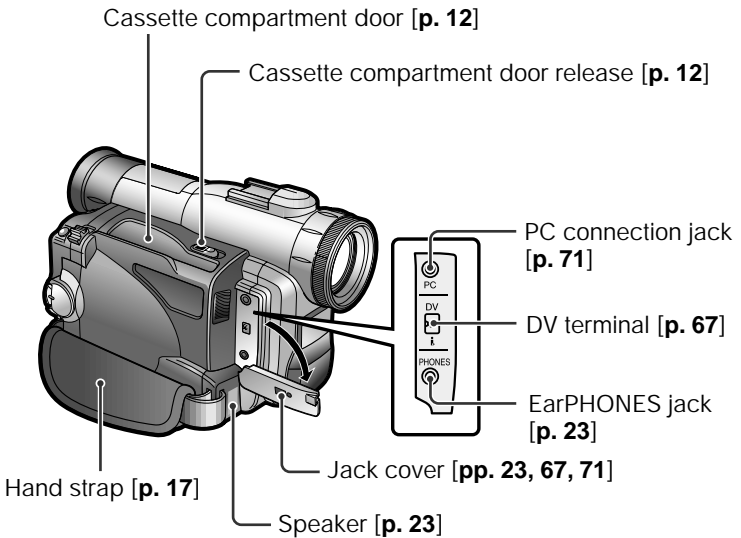
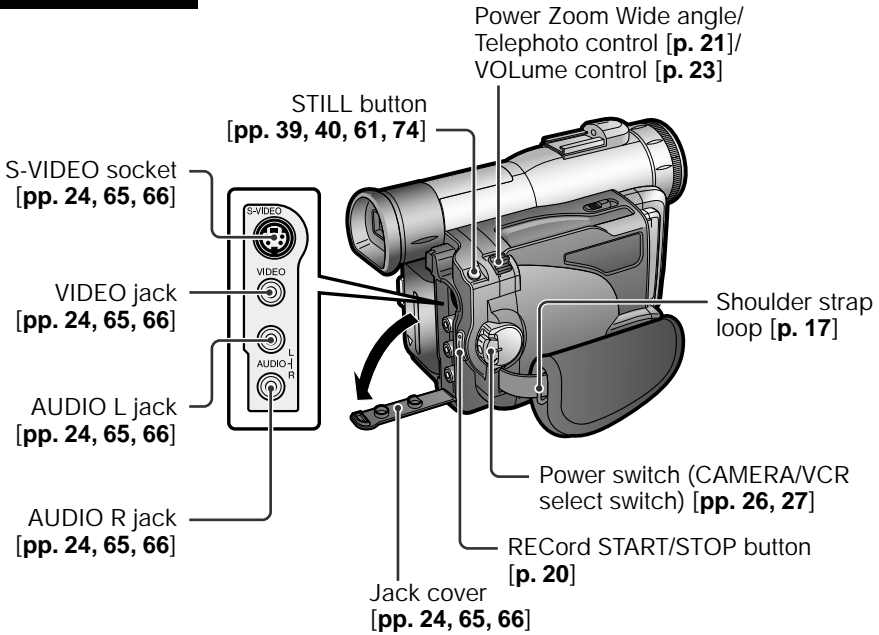

Quick Reference List

Below are some examples of camcorder's features.

- To record the subject with higher-quality audio.
 - See **page 31** (Selecting the 16-bit Audio Recording Mode)
- To record powerful close-up images.
 - See **page 32** (Setting the Digital Zoom)
- To record a backlit subject.
 - See **page 33** (Gamma Brightness Compensation) or **page 51** (Manual Exposure)
- To record subjects at night, e.g. a nocturnal animal.
 - See **page 35** (Night Recording)
- To quickly return the tape to the end of the last recorded scene after playback.
 - See **page 36** (Quick Return)
- To record yourself in the scene while monitoring the shot.
 - See **page 42** (Letting the Subject Monitor the Shot)
- To focus on an off-centered subject.
 - See **page 47** (Manual Focus)
- To turn off the confirmation sounds which are made when you operate the camcorder.
 - See **page 56** (Setting the Confirmation Sounds)
- To enlarge any part of the picture during playback.
 - See **page 60** (Playback Zoom)
- To brighten the dark portion of the playback images without changing the bright portion.
 - See **page 61** (Gamma Playback)
- To record still images on a SmartMedia card so that the images may be easily read into a computer.
 - See **page 74** (Card Recording)

CARD-CAMERA mode

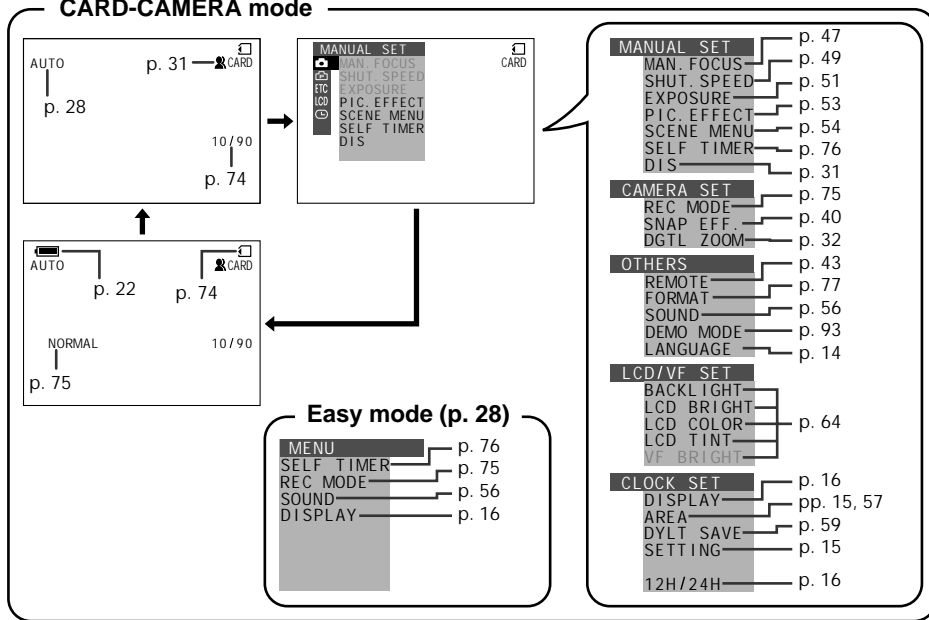

CARD-VCR mode

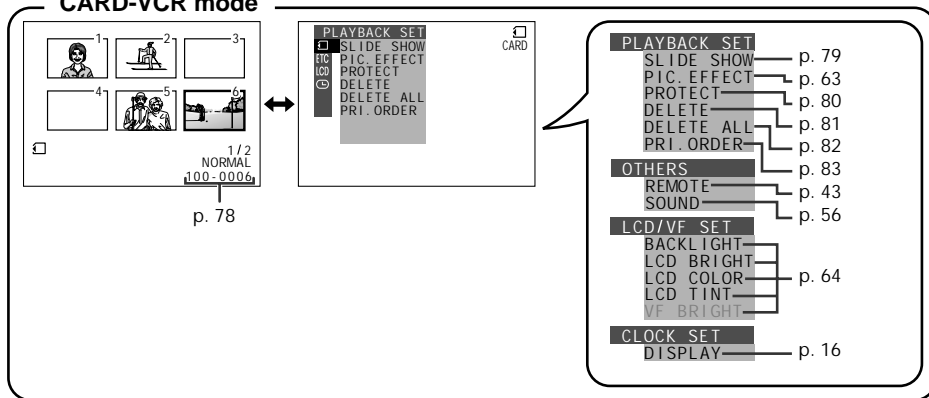

Note:

- See pages 26 to 29 for the procedure to display the desired screen.

Operation References

Warning Indicators

If a warning indicator appears on the screen, follow the specified instructions.

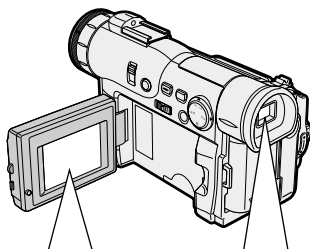

Displayed for the first 3 seconds	Displayed after 3 seconds	Description of warning
INSERT A CASSETTE.		There is no video cassette in the camcorder. Insert a cassette (see page 12).
EJECT THE CASSETTE.	EJECT THE CASSETTE.	The video cassette is defective and should be removed (see page 12).
CASSETTE NOT RECORDABLE.	-PROTECT. TAB-	The erasure protect tab on the video cassette has been slid to the record-protect position, preventing recording (see page 88).
THE TAPE ENDS SOON.	-TAPE END-	The tape is about to end. Prepare a new cassette (see page 12).
CHANGE THE CASSETTE.	TAPE END	The tape has reached the end. Replace it with a new cassette (see page 12).
BATTERY IS TOO LOW.		The battery is almost depleted. Replace it with a fully charged battery pack (see page 10).
DEW	-DEW-	Dew has formed inside the camcorder. Wait for a few hours until the dew disappears (see page 91). About 10 seconds after this warning appears, the camcorder automatically turns off.
		The video heads are clogged and should be cleaned (see page 92).
LAMP	LAMP	The fluorescent lamp behind the LCD monitor is close to the end of its service life. Call your local authorized Sharp dealer to have it replaced.
		When the vertical rotation of the LCD monitor is between 135° and 180° in TAPE-CAMERA or CARD-CAMERA mode, all warnings will be indicated by displayed in the center of the viewfinder and the LCD screen. To check the type of warning, rotate the monitor back to within 135°.

Displayed for 5 seconds	Description of warning
NO MEMORY CARD	The SmartMedia card is not inserted or is inserted improperly. Check how the card is inserted (see page 73).
MEMORY CARD FULL	The capacity of the SmartMedia card is full and cannot store any more images. Delete unnecessary images (see page 81) or replace the card with a new one (see page 73).
NO DATA ON MEMORY CARD	The SmartMedia card has no images recorded in the format the camcorder can recognize.
MEMORY CARD ERROR	The images in the SmartMedia card are corrupted or recorded in a format which is not compatible with this camcorder. Format the card to use it with this camcorder (see page 77).
FORMAT MEMORY CARD	The SmartMedia card has not been formatted with this camcorder. Format the card (see page 77).
MEMORY CARD PROTECTED	A SmartMedia card with a write-protect seal is inserted. Remove the write-protect seal to record images on the card (see page 89).
DATA PROTECTED	You are trying to delete a protected image. Cancel the protection setting (see page 80).
MEMORY CARD READ ERROR	The selected image cannot be read by this camcorder. Format the card to use it with this camcorder (see page 77).
CANNOT STORE DATA	The SmartMedia card cannot record any data due to a problem with the card or data on the card. Replace the SmartMedia card (see page 73).

Note:

-  indicates a flashing display.

Preparation

Charging the Battery Pack

Charge the battery pack with the supplied AC adapter/battery charger before use.

Note:

- Remove the DC cable from the AC adapter/battery charger when charging the battery pack.

- 1 Connect the supplied power cord to the AC power socket on the AC adapter/battery charger, and insert the AC plug into a power outlet.

- The POWER indicator lights up.

POWER indicator

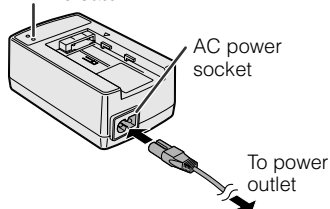

- 2 Align the ▼ mark on the battery pack with the ▲ mark on the charger (1) and guide the battery into the groove. Pressing the battery (2), slide it in the direction of the arrow (3) until it locks into place.

- The CHARGE indicator lights up.

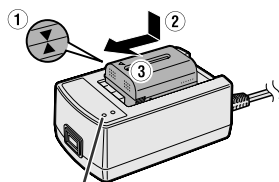

- The CHARGE indicator turns off when the battery is fully charged.

- 3 Slide the battery pack in the direction of the arrow (1), and remove it (2). Then, remove the AC plug of the power cord from the power outlet.

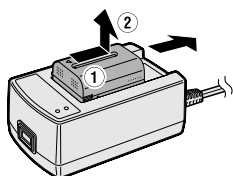

Charging time and maximum continuous recording and playback times in TAPE modes

Model	VL-WD450U	VL-WD650U			
Battery pack	BT-L221	BT-L441			
Charging time	100	160			
Max. continuous recording time	LCD closed	120	240	120	240
	LCD open	100	200	90	180
Max. continuous playback time on LCD	100	200	90	180	

- The chart specifies the approximate times in minutes.

Notes:

- Charge the battery pack between 50°F and 86°F (10°C and 30°C). The battery pack may not charge properly at temperatures too low or too high.
- The battery pack and charger become warm during charging. This is not a malfunction.
- Using the zoom (see page 21) and other functions or turning the power on and off frequently will increase power consumption. This may result in a decrease of more than 50% in the actual recording time compared to the maximum continuous recording time listed above.
- The charging time and recording time may vary depending on the ambient temperature and the condition of the battery pack.
- See page 90 for more information on using the battery pack.

Caution:

- Charge only SHARP model BT-L221 or BT-L441 battery packs. Other types of battery packs may burst, causing personal injury and damage.

Extending battery pack life

Even when the battery pack is not used, the capacity of the battery pack will naturally deteriorate over time. To limit the deterioration of the capacity, it is recommended to perform the following procedure at least once every six months:

- 1 Charge the battery pack until the CHARGE indicator of the charger turns off.
- 2 Attach the battery pack to the camcorder, and set the Power switch to CAMERA without inserting a cassette. Allow the battery power to fully discharge by leaving it on the camcorder until the camcorder power automatically turns off.
- 3 Remove the battery pack and store it between 50°F and 68°F (10°C and 20°C).

Attaching and Removing the Battery Pack

Attaching the Battery Pack

- 1 Make sure that the Power switch is set to OFF.

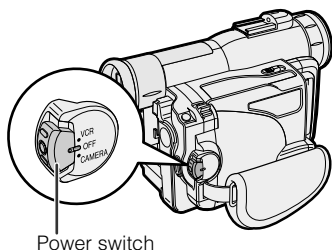

- 2 Lift up the viewfinder.

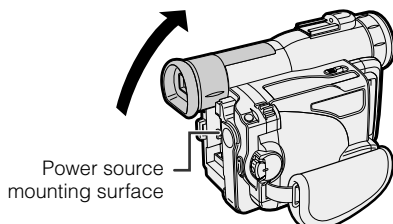

- 3 Align the ■ mark on the side of the battery pack with the ◀ mark on the camcorder (①), and slide the battery pack down completely until it locks into place (②).

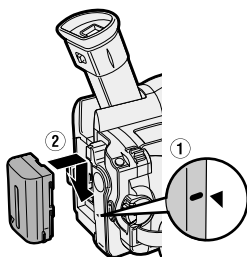

- 4 Lower the viewfinder.

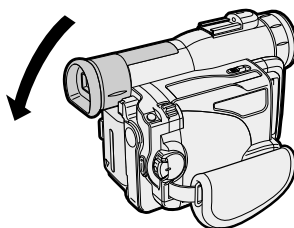

Removing the Battery Pack

- 1 Perform steps 1 and 2 above.
- 2 Press the power source PUSH release button (①), and slide the battery pack up and take it out (②).

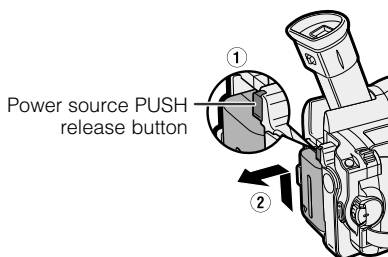

Cautions:

- **BEFORE REMOVING THE BATTERY PACK, ALWAYS STOP RECORDING OR PLAYBACK AND TURN THE POWER OFF.** Removing the battery pack while shooting or during playback may damage the tape by causing it to wrap around the video head drum or may destroy the SmartMedia card, rendering it unreadable and unwritable.
- Remove the battery pack from the camcorder if you will not use the camcorder for a long period of time.
- Use only SHARP model BT-L221 or BT-L441 battery packs with this camcorder. Use of other batteries may present a risk of fire or explosion.



Preparation

Powering the Camcorder from an AC Outlet

You can also power the camcorder from a power outlet by using the supplied AC adapter/battery charger and DC cable.

Caution:

- The supplied AC adapter/battery charger is specially designed for use with this camcorder, and should not be used as a power supply for other camcorders.

- 1 Make sure that the Power switch is set to OFF.
- 2 Lift up the viewfinder.
- 3 Align the  mark on the side of the DC cable connecting plate with the  mark on the camcorder (①), and slide the connecting plate down completely until it locks into place (②).

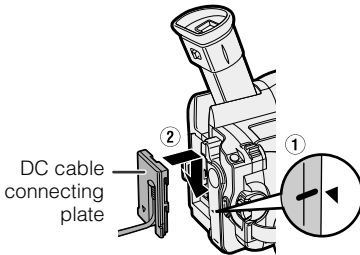

- 4 Lower the viewfinder.

- 5 Insert the DC cable plug into the DC OUT jack on the AC adapter. Connect the supplied power cord to the AC adapter, and insert the AC plug into a power outlet.
 - The POWER indicator on the AC adapter lights up, and the camcorder is supplied power.

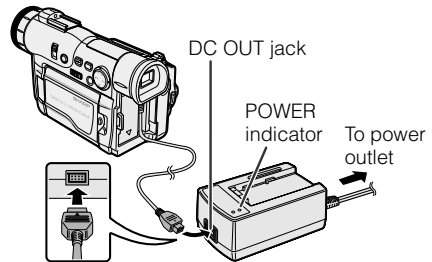

Note:

- When the AC adapter/battery charger is used to power the camcorder, it cannot be used to charge the battery pack.

Removing the DC cable from the camcorder

Perform steps 1 and 2 above. Press the power source PUSH release button (①), and slide the connecting plate up and take it out (②).

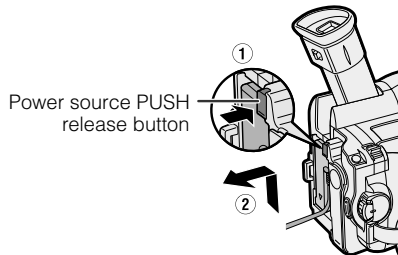

Cautions:

- **BEFORE REMOVING THE DC CABLE, ALWAYS STOP RECORDING OR PLAYBACK AND TURN THE POWER OFF.** Removing the DC cable while shooting or during playback may damage the tape by causing it to wrap around the video head drum or may destroy the SmartMedia card, rendering it unreadable and unwritable.
- Disconnect the camcorder from the AC adapter if you will not use the camcorder for a long period of time.

Inserting and Removing a Mini DV Cassette

Inserting a Cassette

- 1 Attach the power source to the camcorder, then slide the cassette compartment door release and open the cassette compartment door.
 - A confirmation sound is made, and the cassette holder extends automatically.

Cassette compartment door release

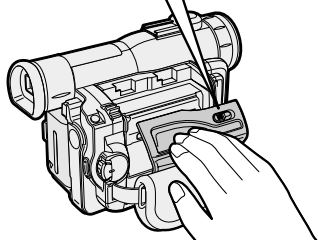
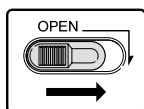

Note:

- If the hand strap is pulled too tight, it can obstruct the opening of the cassette compartment door and the cassette holder may be unable to extend. Should this occur, loosen the hand strap and open the cassette compartment door completely.

- 2 Insert the cassette fully with the window facing outwards, and with the erasure protect tab facing upwards.

Erasure protect tab

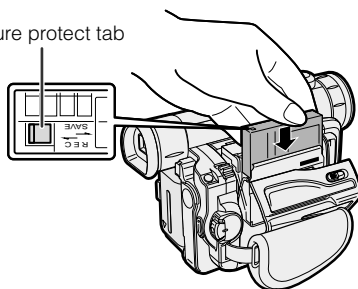

- 3 Press the **PUSH/押し** mark gently until the cassette holder clicks into place.
 - A confirmation sound is made, and the cassette holder retracts automatically.

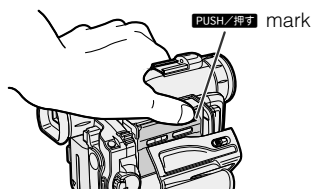

- 4 Wait for the cassette holder to fully retract. Close the compartment door by pressing the center until it clicks into place.

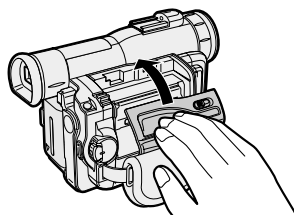

Removing a Cassette

Perform step 1 above, then take out the cassette.

Cautions:

- Do not try to close the cassette compartment door while the cassette holder is extending or retracting.
- Be careful not to get your fingers caught in the cassette holder.
- Do not apply force to the cassette holder except when pressing the **PUSH/押し** mark to close it.
- Do not tilt the camcorder or hold it upside down when you are inserting or removing a cassette. It may damage the tape.
- Remove the cassette if you will not use the camcorder for a long period of time.
- If you do not correctly close the cassette holder in step 3, the cassette protection mechanism of the camcorder might eject the cassette. If this happens, repeat the insertion procedure.
- Do not attempt to pick up the camcorder by the cassette compartment door.

Notes:

- If the battery power is too low, you may not be able to eject the cassette. Replace the battery pack with a fully charged one.
- See page 88 for more information on the video cassette tapes intended for use with this camcorder.

Installing the Lithium Memory Battery

Installing the Lithium Battery

The supplied lithium battery is used to store the memory of the date and time settings.

- 1 Press the LCD monitor OPEN release button (①) and open the LCD monitor (②).

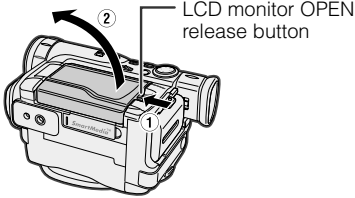

- 2 Open the lithium battery compartment door using the tip of a ballpoint pen or other pointed object.

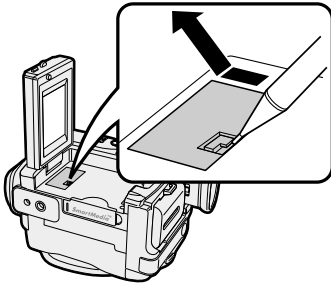

- 3 Insert the lithium battery into the compartment with the + side facing out.

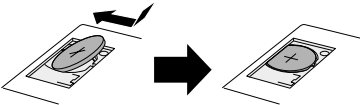

- 4 Replace the compartment door, and close it firmly until it clicks into place.



- 5 Close the LCD monitor until it clicks into place.

Removing the lithium battery

Perform steps 1 and 2 above. Lift up the battery using a pointed object, and take it out.

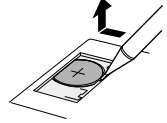

Note:

- Replace the battery with a new CR2025 lithium battery when the time indicator of the camcorder starts to fall behind the correct time.

Notes on the Use of the Lithium battery

REPLACE BATTERY WITH TOSHIBA, MATSUSHITA OR HITACHI MAXELL TYPE CR2025 ONLY. USE OF A DIFFERENT BATTERY MAY PRESENT A RISK OF FIRE OR EXPLOSION.

WARNING KEEP THIS BATTERY AWAY FROM CHILDREN. IF SWALLOWED, CONSULT A PHYSICIAN IMMEDIATELY FOR EMERGENCY TREATMENT.

CAUTION BATTERY MAY EXPLODE IF MISUSED OR INSTALLED WITH POLARITY REVERSED. DO NOT RECHARGE, DISASSEMBLE OR DISPOSE OF IN FIRE.

- Do not short-circuit, recharge, disassemble, or heat the lithium battery.
- Should the lithium battery leak, wipe the battery compartment clean, and then insert a new battery.
- The lithium battery will last about one year under normal usage.

Selecting the Language for the On-screen Display

This camcorder allows you to choose from among English, French or Spanish for the on-screen display language.

Note:

- The operation procedures in the following sections of this operation manual are based on the use of on-screen displays in English.

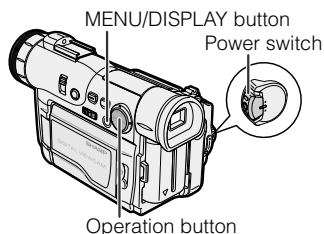

Setting the Language

When using the camcorder for the first time, select the desired language for the on-screen display by performing the procedure below.

- 1 Press the LCD monitor OPEN release button (1) and open the LCD monitor (2).

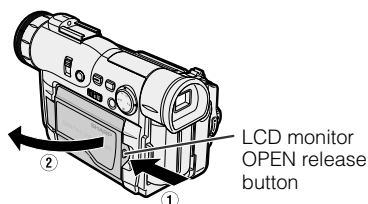

- 2 Hold down the Lock button and set the Power switch to CAMERA.

- The language selection screen appears on the LCD screen.



- 3 Press ■ or ►/■ (1) on the operation button to select the desired language, then press ◀ (2).

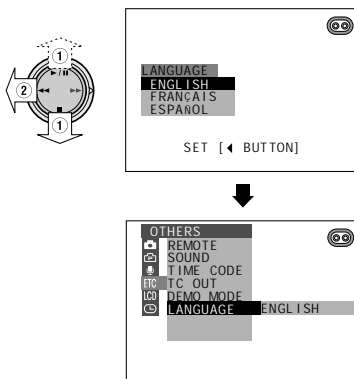

Changing the Language

- 1 Set the camcorder to TAPE-CAMERA or CARD-CAMERA mode.
- 2 Press the MENU/DISPLAY button until the menu screen appears.
- 3 Select ETC, then press ► on the Operation button. Select "LANGUAGE" ("LANGUE" or "IDIOMA") (1), then press ►► (2).
 - The language selection screen appears.

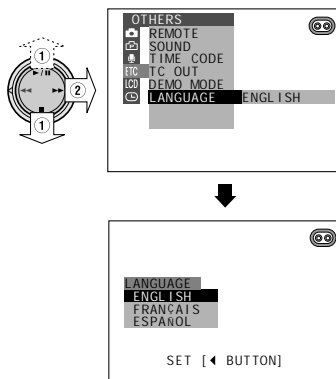

- 4 Perform step 3 in "Setting the Language".
 - The menu screen is displayed in the language selected.
- 5 Press the MENU/DISPLAY button to turn off the menu screen.

Preparation

Setting the Area, Date and Time

Example: Setting the date to June 2, 2002 (JUN. 2. 2002) and the time to 10:30 am (10:30 AM) in New York.

Notes:

- Before performing the procedure below, make sure that the lithium battery has been installed (see page 13).
- If you are in an area that observes daylight saving time, set the time to the standard time. You can then correct it for daylight saving time by performing the procedure on page 59.

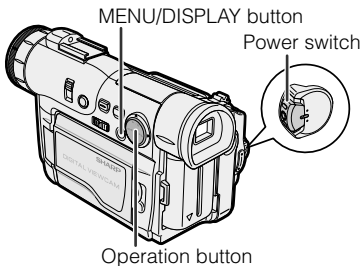

- 1 Press the LCD monitor OPEN release button (1) and open the LCD monitor (2).

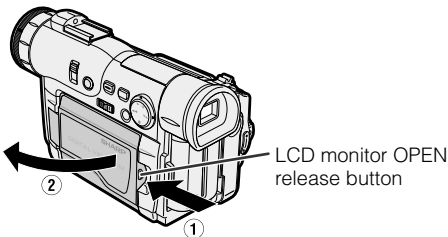

- 2 Hold down the Lock button and set the Power switch to CAMERA.



- 3 Press the MENU/DISPLAY button until the menu screen appears.

- 4 Press ►► on the Operation button.

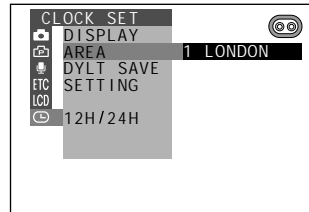
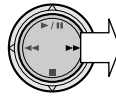

- 5 Press ■ or ►/|| (1) until "20 NEW YORK" appears, then press ◀◀ (2).

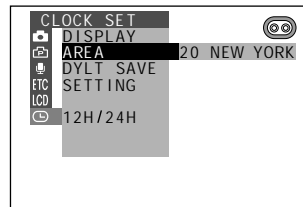
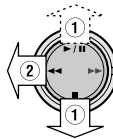

Note:

- See "Time Zone Chart" and "Area Table" on pages 57 and 58 for the area number and name of the representative city for your time zone.

- 6 Press ■ or ►/|| (1) to select "SETTING", and then press ►► (2).

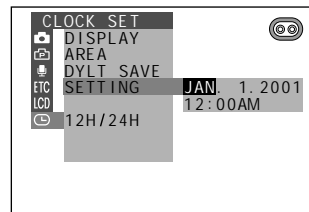
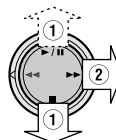

- 7 Press ■ or ►/|| to select "JUN" (month), and then press ►►.



- 8 Press ■ or ►/|| to select "2" (day), and then press ►►.



- 9 Press **■** or **▶/||** to select “2002” (year), and then press **▶▶**.

SETTING JUN. 2. 2002
12:00AM

- 10 Press **■** or **▶/||** to select “10 AM” (hour), and then press **▶▶**.

SETTING JUN. 2. 2002
10:00AM

- 11 Press **■** or **▶/||** to select “30” (minute), and then press **◀◀**.
- The internal clock now starts operating.

SETTING JUN. 2. 2002
10:30AM

- 12 Press the MENU/DISPLAY button to turn off the menu screen.

Changing to the 24-hour Time Mode

- 1 After performing step 11 above, press **■** or **▶/||** (①) to select “12H/24H”, and then press **▶▶** (②).

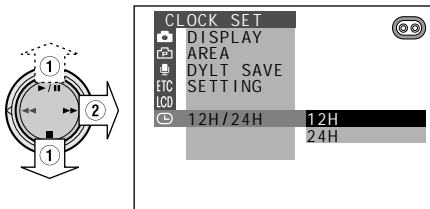

- 2 Press **■** or **▶/||** to select “24H”, and then press **◀◀**.

12H/24H 24H

- 3 Press the MENU/DISPLAY button to turn off the menu screen.

Notes:

- The date and time, once set, are internally recorded even when not displayed on the screen.
- The menu screen automatically turns off if no settings are made within 5 minutes.

Displaying the Date and Time of Recording

Follow the procedure below to display the date, or both the date and time, of recording on the screen. You can display the date and time during both recording and playback.

- The example screens for this feature are for TAPE-CAMERA mode.

- 1 Hold down the Lock button and set the Power switch to CAMERA or VCR.
- 2 Press the MENU/DISPLAY button until the menu screen appears.
- 3 Select **☺**, then press **▶▶** on the Operation button. Select “DISPLAY” (①), then press **▶▶** (②).

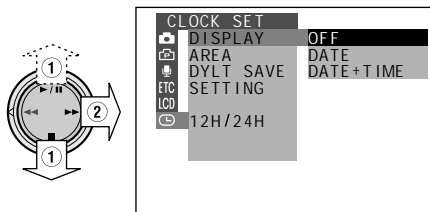

- 4 Press **■** or **▶/||** to select “DATE” or “DATE + TIME”, and then press **◀◀**.

DISPLAY DATE+TIME

- 5 Press the MENU/DISPLAY button to turn off the menu screen.

- The date (or the date and time) is displayed.

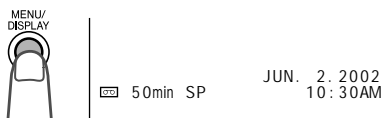

Notes:

- Before recording, make sure that the date and time have been correctly set. If they have not been set, the display will be left blank when playing back the recording. (The display will also be left blank for unrecorded or damaged portions of the tape.)
- In TAPE-VCR or CARD-VCR mode, the current date and time are displayed when the tape or SmartMedia card is not being played back.

Preparation

Adjusting the Hand Strap

- 1 Open the hand strap flap (1) and the grip strap (2).

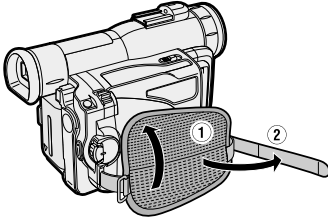

- 2 Loosen the grip strap, pass your right hand through the loop, and put your thumb on the REC START/STOP button. Then, pull the grip strap tight until it fits snugly.

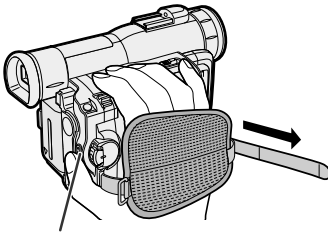

REC START/STOP button

- 3 Seal the velcro fasteners of the grip strap and the hand strap flap.

Caution:

- Do not swing the camcorder by the hand strap.

Using the Lens Cap

Attach the strap of the lens cap to the hand strap as shown below.

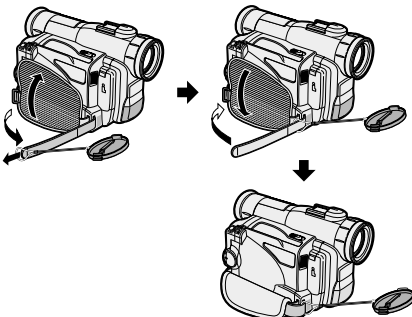

When attaching or removing the lens cap, press both tabs on the top and bottom of the cap.

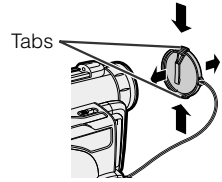

When recording, hang the hook of the lens cap on the hand strap so that the cap will not get in the way.

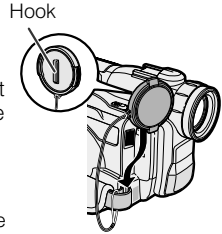

Note:

- Always replace the lens cap on the lens when the camcorder is not in use.

Attaching the Shoulder Strap

- 1 Remove the battery pack.
- 2 Hold one end of the strap and thread it through the loop on the left side of the power source mounting surface.
- 3 Loosen the strap in the buckle, then feed the end of the strap through the buckle, as shown.
- 4 Draw the strap in the direction of the arrow to secure.
- 5-7 To attach the other end of the strap to the loop on the left side of the hand strap, open the hand strap flap, perform the same procedure, and then attach the battery pack.

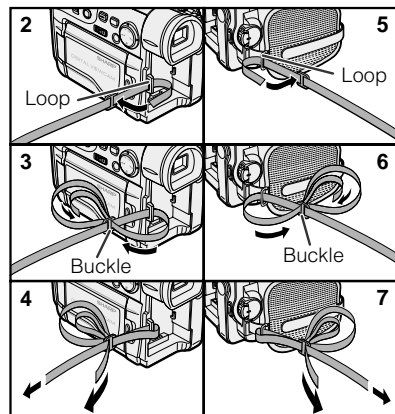

Using the Viewfinder

You can record the subject using the electronic LCD viewfinder. You can also watch playback through the viewfinder.

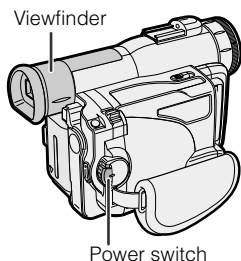

1 Lift up the viewfinder.

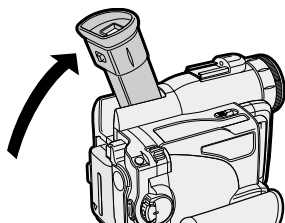

Note:

- You can raise the viewfinder to aim the camcorder better depending on your position.

2 Hold down the Lock button and set the Power switch to CAMERA or VCR.

- A picture is displayed in the viewfinder.

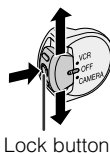

Closing the viewfinder

Lower the viewfinder.

Cautions:

- Do not use excessive force when moving the viewfinder.
- Do not pick up the camcorder by the viewfinder.

Notes:

- The viewfinder automatically turns off when the LCD monitor is opened. When the vertical rotation of the monitor is between 135° and 180°, however, the viewfinder is on and the subject is displayed both in the viewfinder and on the monitor (see page 42).
- Be sure to close the viewfinder after use.

Adjusting the Diopter

Adjust the diopter according to your eyesight when the picture in the viewfinder is not clear.

1 Lift up the viewfinder.

2 Hold down the Lock button and set the Power switch to CAMERA.

3 While looking through the viewfinder, turn the Diopter adjustment until the indicators in the viewfinder are clearly visible.

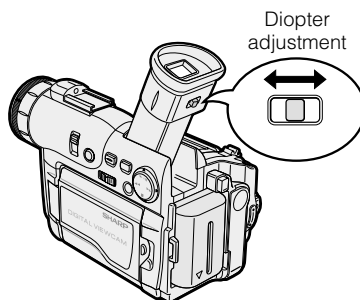

Preparation

Using the LCD Monitor

You can use the LCD monitor to play back recordings that you have made. You can also watch the subject on the LCD monitor while recording.

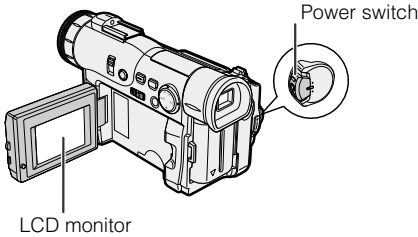

- 1 Press the LCD monitor OPEN release button (1), and open the LCD monitor to a 90° angle to the camcorder body (2).

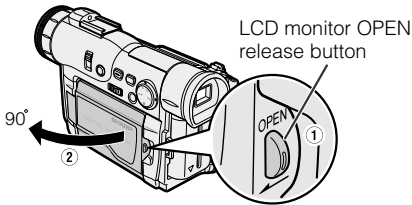

- 2 Adjust the LCD monitor to an angle that allows easy viewing on the on-screen picture.
 - The LCD monitor rotates 270° vertically.

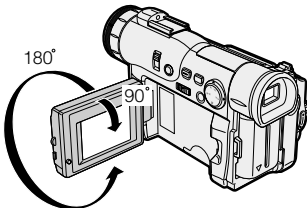

Note:

- You can also fold the LCD monitor into the camcorder with the screen facing out for watching playback on the monitor.

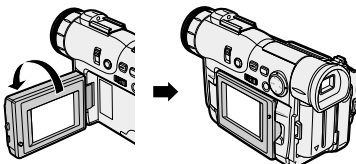

- 3 Hold down the Lock button and set the Power switch to CAMERA or VCR.

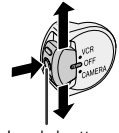

Notes:

- Battery consumption is larger when the LCD monitor is open. Use the viewfinder instead of the LCD monitor when you want to save battery power.
- Use the viewfinder if the LCD screen becomes difficult to see in bright daylight.

Closing the LCD monitor

Return the LCD monitor to the vertical 90° position with the screen facing in, and fold it into the camcorder until it clicks into place.

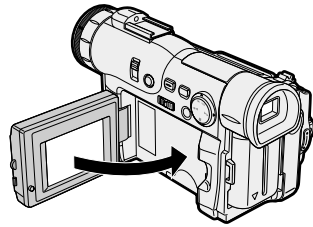

Cautions:

- Do not use excessive force when moving the LCD monitor.
- Do not try to rotate the LCD monitor vertically until the monitor is completely opened.
- When closing the LCD monitor, do not tilt it; otherwise the monitor may not close properly and may become damaged.
- Do not pick up the camcorder by the LCD monitor.
- Do not expose the LCD monitor to shocks.
- Do not apply pressure to the LCD screen surface.
- Do not place the camcorder with the LCD screen facing down.

Notes:

- Take care not to touch the LCD screen with your fingers, as perspiration and dirt will smudge it.
- Close the LCD monitor completely with the screen facing in when not in use.
- Use a soft cloth to clean the LCD screen.

Basic Operations

Camera Recording

Easy Camera Recording on Tape in Full Auto Mode

- Before you start recording, perform the operations described on pages 9 through 19 to prepare your camcorder for recording.

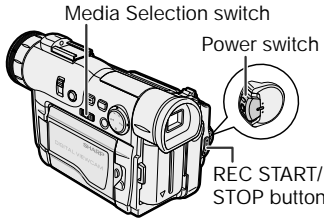

- 1 Remove the lens cap, and lift up the viewfinder.
- 2 Set the Media Selection switch to TAPE.
- 3 Hold down the Lock button and set the Power switch to CAMERA.
 - The picture from the lens is now displayed in the viewfinder.
 - The camcorder is now ready to record (Recording Standby mode).

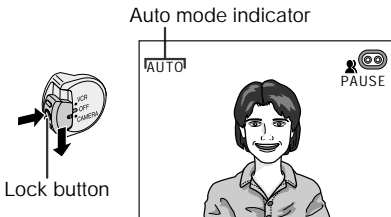
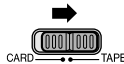

Note: If "MANUAL" is displayed at this time, press the AUTO ON/OFF button to set the camcorder to Auto mode.

- 4 Press the REC START/STOP button to begin recording.

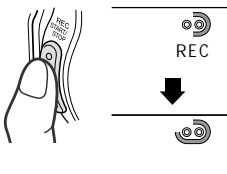

To pause recording

Press the REC START/STOP button again. Recording pauses, and the camcorder enters Recording Standby mode.

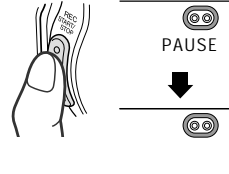

To turn the power off

Set the Power switch to OFF without pressing the Lock button.

Notes:

- Battery power is consumed in Recording Standby mode. Turn off the power if you will not be recording again soon.
- If the camcorder remains in Recording Standby mode for more than 5 minutes in TAPE-CAMERA mode, the power will automatically turn off to save battery power and to protect the tape from being damaged. To resume recording, set the Power switch to OFF and then back to CAMERA. (The camcorder will make a confirmation sound when it is left in Recording Standby mode for about 4 minutes.)

Maximum continuous recording and actual recording times in TAPE-CAMERA mode

Model		VL-WD450U		VL-WD650U	
Battery pack		BT-L221	BT-L441	BT-L221	BT-L441
Max. continuous recording time	LCD closed	120	240	120	240
	LCD open	100	200	90	180
Actual recording time	LCD closed	60	120	60	120
	LCD open	50	100	45	90

- The chart specifies the approximate times in minutes.

Note:

- Using the zoom (see page 21) and other functions or turning the power on and off frequently will increase power consumption. This may result in a decrease of more than 50% in the actual recording time compared to the maximum continuous recording time listed above.

Zooming

Zooming allows you to move visually closer to or farther from a subject without physically changing your position.

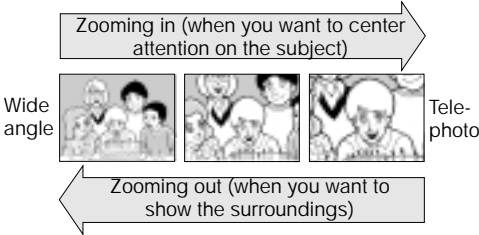

To zoom in

Push the Power Zoom control to the T (tele-photo) side to get a close-up view (①).

To zoom out

Push the Power Zoom control to the W (wide angle) side to get a wide field of view (②).

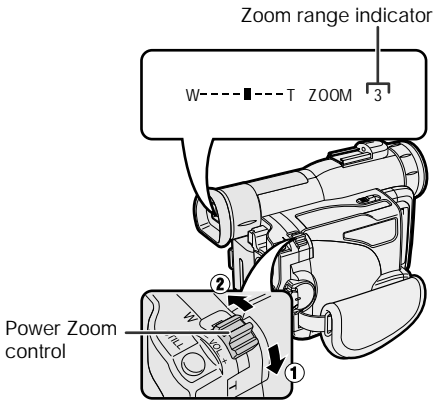

- The zoom range indicator shows you the current zoom setting.
- The zoom speed depends on how far you push the Power Zoom control.

Notes:

- The camcorder is unable to focus when zooming in on subjects within 6 feet (1.8 m). The camcorder will automatically zoom out until it is able to focus on the subject. (See page 43 for recording macro shots.)
- See page 32 for use of the digital zoom.

Tips on Recording Positions

To create images that are easy to watch during playback, try to record with a stable posture while steadying your camcorder to prevent the image from shaking.

Holding the camcorder

Put your right hand through the hand strap, and place your left hand under the camcorder for support.

Basic posture

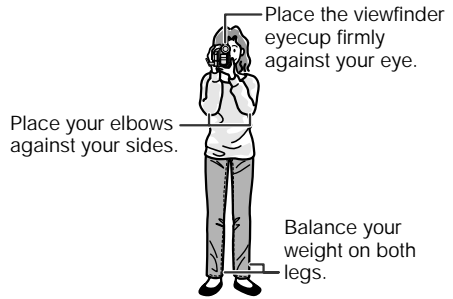

Shooting from a high angle

Turn the LCD monitor so that the screen faces downward.



Shooting from a low angle

Using the viewfinder

Raise the viewfinder to view the subject.



Using the LCD monitor



Turn the LCD monitor so that the screen faces upward.

Note:

- Take care not to touch the microphone with your fingers during recording. It will cause noise on the audio track.

Remaining Recording Time Display

When the camcorder is recording in TAPE-CAMERA mode, an on-screen indicator displays the approximate remaining tape time in minutes.

During camera recording in TAPE-CAMERA mode, press the MENU/DISPLAY button until the remaining recording time indicator appears.

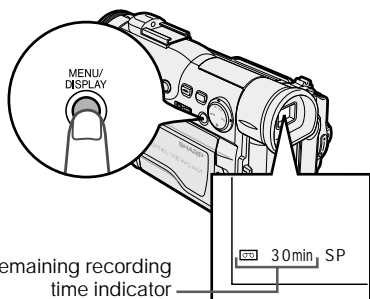

To turn off the indicator, press the MENU/DISPLAY button again.

Notes:

- The remaining recording time indicator appears 10 seconds after pressing the REC START/STOP button to begin recording.
- The remaining recording time indicator only shows the approximate time left. Also, it varies slightly depending on the length of tape used. (This function is based on the DVM60 tape standard.)

When the remaining recording time reaches 1 minute, a warning indicator will appear. Prepare a new cassette.

Warning indicator	Approx. remaining time
THE TAPE ENDS SOON. ↓ -TAPE END-	Less than 1 min.
CHANGE THE CASSETTE. ↓ TAPE END	(The tape has reached the end.)

Remaining Battery Power Display

When using the camcorder with the battery pack as the power source, you can turn on and off the remaining battery power indicator by pressing the MENU/DISPLAY button. If the battery power becomes very low, a warning indicator will appear. Replace the battery pack.

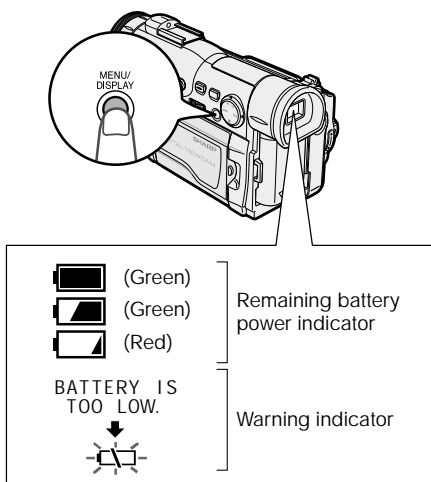

Notes:

- Use the remaining battery power indicator only as an approximate indication.
- The remaining battery power indicator may change to either a higher or lower level if you set the Power switch to OFF and then back to CAMERA or VCR.
- In cold environments, the red remaining battery power indicator may appear sooner. The battery pack, however, can be used until the warning indicator appears.
- Use of the zoom functions when the warning indicator is displayed may cause the camcorder to suddenly lose power.

Basic Operations

Playback

Tape Playback

The LCD monitor screen functions as a handy playback monitor. Nothing needs to be connected, allowing instant on-screen playback with the sound through the built-in speaker.

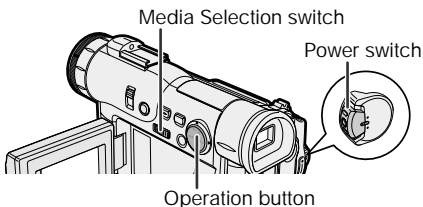

- 1 Open the LCD monitor and adjust the angle (see page 19).
- 2 Set the Media Selection switch to TAPE.

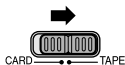

- 3 Hold down the Lock button and set the Power switch to VCR.

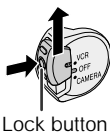

- 4 Press ◀◀ (or ▶▶) on the Operation button to rewind (or fast forward) the tape to the desired point.

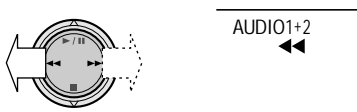

- 5 Press ▶▶/⏸ to begin playback.



To stop playback

Press ■ .

To turn the power off

Set the Power switch to OFF without pressing the Lock button.

Notes:

- The tape is automatically rewound when playback reaches the end of the tape.
- Stereo earphones with a 3.5 mm diameter plug can be plugged directly into the PHONES jack. When you use this jack, the speaker automatically turns off.

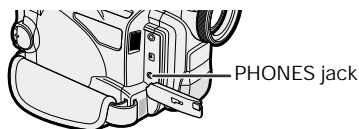

Watching the Playback in the Viewfinder

You can also watch the playback in the viewfinder by closing the LCD monitor with the screen facing in. You cannot monitor the sound through the speaker when watching the playback in the viewfinder.

Volume Control

When the camcorder is in TAPE-VCR mode, push the Volume control to the + or - side to increase (1) or decrease (2) the volume.

The volume level indicator will appear on the LCD screen during adjustment only. Once the Volume control is released, the volume level indicator will disappear shortly afterwards.

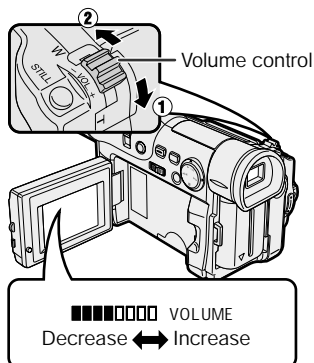

Watching the Playback on a TV

You can connect the camcorder to a TV to allow a larger audience to enjoy playback.

1 Open the jack cover on the camcorder.

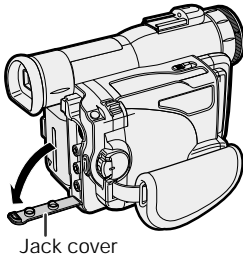

2 Connect the camcorder to your TV (or VCR) with the supplied audio/video cable, as shown.

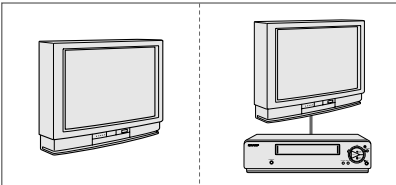

Yellow: To video input jack
 White: To audio input (L) jack
 Red: To audio input (R) jack

To S-video input socket

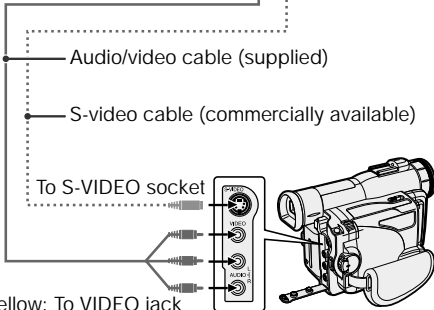

Yellow: To VIDEO jack
 White: To AUDIO L jack
 Red: To AUDIO R jack

- 3** Turn on the TV and set it to the “AV” or “VIDEO” channel. (See the operation manual of your TV.)
- When connecting to a TV via a VCR, turn on the VCR and set it to the “AV” or “LINE” input channel. Operate the TV as you normally do to see the signal from the VCR. (See the operation manuals of your TV and VCR.)
- 4** Set the Power switch on the camcorder to VCR, and begin playback (see page 23).

Caution:

- Make sure that the camcorder, TV, VCR and other equipment to be connected have been turned off before you make connections. Making connections with any of the components left turned on may cause picture noise or malfunction.

Notes:

- If your TV or VCR has only one audio input jack, use the white plug for the audio connection on the TV or VCR.
- If your TV or VCR has an S-video input socket, you can connect it to the S-VIDEO socket on the camcorder with a commercially available S-video cable.
- When the camcorder is connected to a TV for playback, the picture on the TV screen may flicker if the volume on the camcorder is set to maximum. Should this occur, turn the volume down (see page 23).
- Close the jack cover after use.

About the S-video socket

S-video sockets are used to separately pass the chroma (color) and luminance (brightness) components of video signals. They serve to improve the picture quality in both recording and playback.

Basic Operations

Playback

Video Search

The video search function makes it easy to search for a desired scene on the tape.

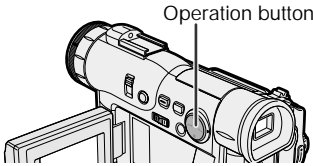

- 1 During playback in TAPE-VCR mode, press ►► (or ◀◀) on the Operation button.
 - The playback picture fast forwards (or reverses).

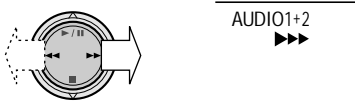

- 2 When you find the desired scene, press ►/|| to return to normal playback.

Notes:

- The sound is off during search.
- Some picture noise appears during search. This is not a malfunction.

Still

The still function makes it possible to pause playback in TAPE-VCR mode.

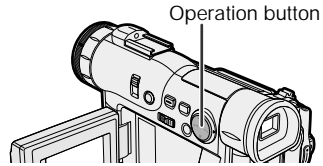

During playback in TAPE-VCR mode, press ►/|| on the Operation button.

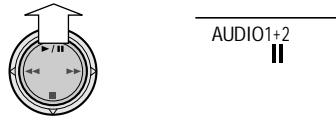

To return to normal playback, press ►/|| again.

Notes:

- The sound is off in Still mode.
- To protect the tape, the camcorder automatically returns to normal playback if it is left in Still mode for more than 5 minutes.





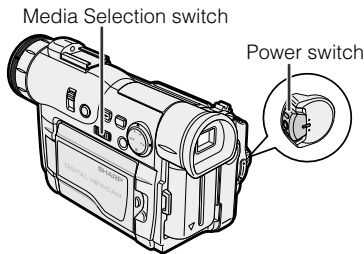

Useful Features

Selecting the Camcorder Mode

This camcorder includes functions for use as both a video camera for recording and playing back images on tapes and as a digital still camera for recording and playing back still images on SmartMedia cards. One of the following camcorder modes needs to be set before starting any operations.

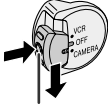

Camcorder modes

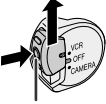
<p>TAPE-CAMERA mode</p> <p>For recording motion and still images on tapes.</p> <ol style="list-style-type: none"> 1 Set the Media Selection switch to TAPE.  <ol style="list-style-type: none"> 2 Hold down the Lock button and set the Power switch to CAMERA.  <p>Lock button</p>	<p>TAPE-VCR mode</p> <p>For playing back or editing motion and still images recorded on tapes.</p> <ol style="list-style-type: none"> 1 Set the Media Selection switch to TAPE.  <ol style="list-style-type: none"> 2 Hold down the Lock button and set the Power switch to VCR.  <p>Lock button</p>
<p>CARD-CAMERA mode</p> <p>For recording still images on SmartMedia cards.</p> <ol style="list-style-type: none"> 1 Set the Media Selection switch to CARD.  <ol style="list-style-type: none"> 2 Hold down the Lock button and set the Power switch to CAMERA.  <p>Lock button</p>	<p>CARD-VCR mode</p> <p>For playing back still images recorded on SmartMedia cards.</p> <ol style="list-style-type: none"> 1 Set the Media Selection switch to CARD.  <ol style="list-style-type: none"> 2 Hold down the Lock button and set the Power switch to VCR.  <p>Lock button</p>

Caution:

- Do not change the camcorder mode by operating the Media Selection switch during recording or playback, as this may cause damage to the tape or SmartMedia card.

Using the Controls

The following controls on the camcorder can be used to select and operate the various functions, settings and on-screen displays.

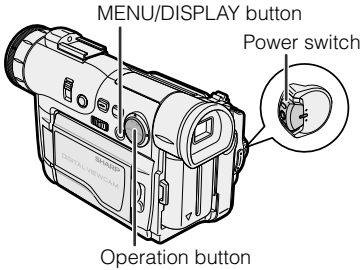

Power switch

To turn the power on, hold down the Lock button and set the Power switch to CAMERA or VCR.

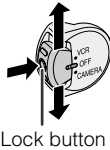

Lock button

To turn the power off, set the Power switch to OFF without pressing the Lock button.

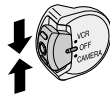

MENU/DISPLAY button

The MENU/DISPLAY button is used to turn the on-screen indicators and the menu screens on or off. Each time you press the MENU/DISPLAY button, the on-screen display changes as shown below.



Example

Indicators off

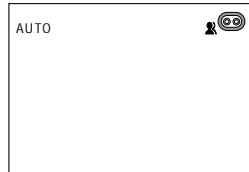

Menu screen

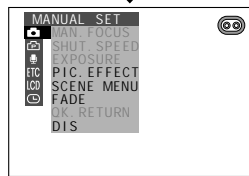

Indicators on

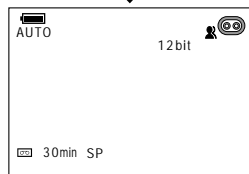

Note:

- The warning indicators and some other indicators cannot be turned off by pressing the MENU/DISPLAY button.

Operation button

The Operation button is used to select and set the various menu settings by pressing

▶ / || (1), ◀◀ (2), ■ (3) or ▶▶ (4).

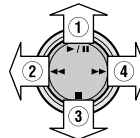

Selecting the User Mode

This camcorder features three user modes for the camera recording functions. The selectable items on the menu screen are different depending on the user mode.

User mode

Auto mode (AUTO): Lets you adjust all menu settings except manual settings.

Manual mode (MANUAL): Lets you adjust all settings including the following manual settings.

—MAN. FOCUS, SHUT. SPEED, EXPOSURE

Easy mode (EASY): Lets you adjust only the following basic menu settings.

—FADE, QK. RETURN, PHOTO SNAP, SNAP EFF., WIND, SOUND, DISPLAY, SELF TIMER, REC MODE

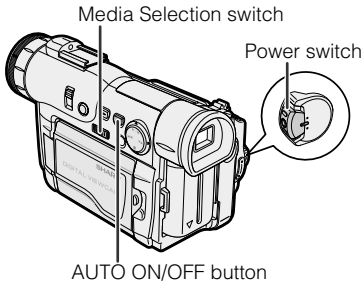

- 3 Press the AUTO ON/OFF button.
 - Each time you press the AUTO ON/OFF button, the user mode changes between Auto mode and Manual mode.
 - **To select Easy mode**, hold down the AUTO ON/OFF button for more than two seconds.



Notes:

- All manual settings in Manual mode will be canceled when you press the AUTO ON/OFF button to return to Auto mode.
- **To cancel Easy mode**, hold down the AUTO ON/OFF button for more than two seconds.
- There is no user mode for playback functions.
- The example screens in this operation manual assume the use of Auto mode unless otherwise indicated.

- 1 Set the Media Selection switch to TAPE or CARD.

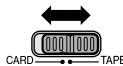

- 2 Hold down the Lock button and set the Power switch to CAMERA.
 - The user mode indicator is displayed.

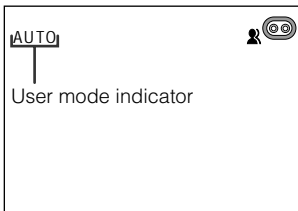
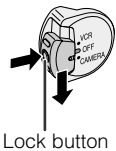

Using the Menu Screens

The menu screens can be used to adjust the various settings of camcorder.

- 1 Set the Media Selection switch to TAPE or CARD.

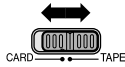

- 2 Hold down the Lock button and set the Power switch to CAMERA or VCR.

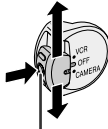

Lock button

- 3 Press the MENU/DISPLAY button until the menu screen appears.

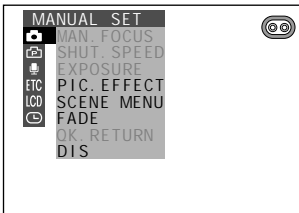

- 4 Press \blacksquare or $\blacktriangleright/\blacksquare$ (1) on the Operation button to select the desired menu screen, then press \blacktriangleright (2).

Example

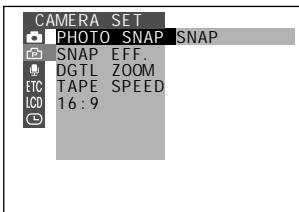
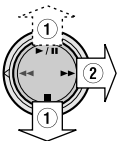

- 5 Press \blacksquare or $\blacktriangleright/\blacksquare$ (1) to select the desired menu item, then press \blacktriangleright (2).

Example

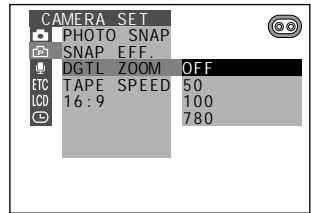

- 6 Press \blacksquare or $\blacktriangleright/\blacksquare$ (1) to select the desired menu setting, then press \blacktriangleleft (2).
 - To adjust another menu item, press \blacktriangleleft , then perform steps 4 to 6.

Example

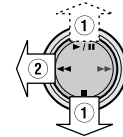
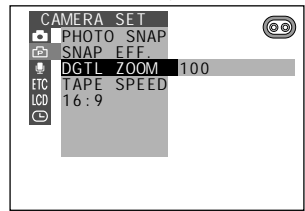

To turn off the menu screen

Press the MENU/DISPLAY button.

Notes:

- Certain menu items are common among Camcorder modes. If the REMOTE menu item, for example, is set to "OFF" in TAPE-CAMERA mode, it will be automatically set to "OFF" in other modes.
- The menu screen automatically turns off if no settings are made within five minutes.

Useful Features



Camera Recording

Recording in LP (Long Play Recording) Mode

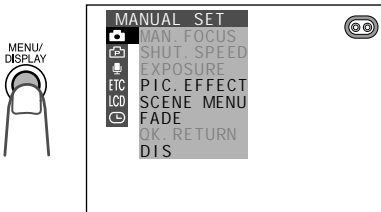

This camcorder allows you to record in LP (Long Play Recording) mode for approximately 50% more recording time with the same picture quality as that in SP (Standard Play Recording) mode.

- 1 Set the camcorder to TAPE-CAMERA mode.
- 2 Press the MENU/DISPLAY button until the menu screen appears.

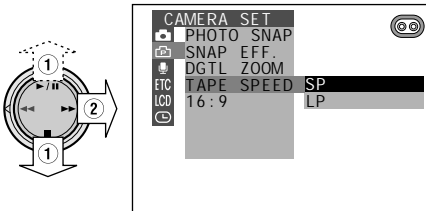

- 3 Select , then press  on the Operation button. Select "TAPE SPEED" (1), then press  (2).



- 4 Press  or /|| to select "LP", then press .



- 5 Press the MENU/DISPLAY button to turn off the menu screen.
 - The recording mode indicator changes from "SP" to "LP".

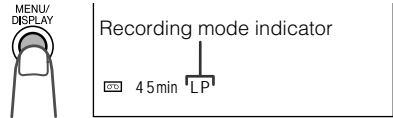

To return to SP mode

Select "SP" in step 4 above.

Notes on the use of LP mode

- To record in LP mode, be sure to use a Mini DV cassette labeled for use with LP mode.
- Frozen images, mosaic-pattern picture noise, audio interruptions or audio loss may occur in the following cases:
 - When using a tape which is not designated for use with LP mode.
 - When a tape recorded in LP mode under high-temperature conditions is played back.
 - When a tape recorded in LP mode with the camcorder is played back on a Mini DV player or camcorder from another manufacturer.
 - When a tape recorded in LP mode is played back on a Mini DV player or camcorder without an LP function.
- Audio dubbing is not possible with LP mode recording.

Useful Features Camera Recording

Selecting the 16-bit Audio Recording Mode

This camcorder allows you to select between the 12-bit and 16-bit audio recording modes. The camcorder normally records audio in the 12-bit audio recording mode. For higher-quality audio recording, select the 16-bit audio recording mode.

- 1 Set the camcorder to TAPE-CAMERA mode.
- 2 Press the MENU/DISPLAY button until the menu screen appears.
- 3 Select , then press **▶▶** on the Operation button. Select "AUDIO MODE" (①), then press **▶▶** (②).

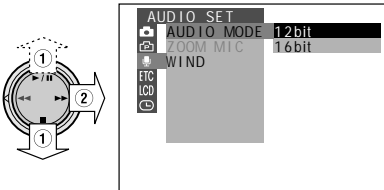

- 4 Press **■** or **▶/||** to select "16bit", then press **◀◀**.

AUDIO MODE 16bit

- 5 Press the MENU/DISPLAY button to turn off the menu screen.

- The audio recording mode indicator changes from "12bit" to "16bit".

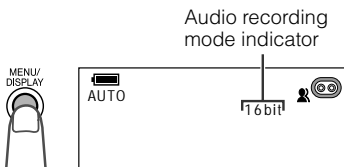

To return to 12-bit audio recording mode

Select "12bit" in step 4 above.

Note:

- When using Audio Dubbing with 16-bit audio recordings, both the dubbed and original sounds will be recorded in mono (see page 68).

Digital Image Stabilization (DIS)

The digital image stabilization (DIS) function is factory preset to on to stabilize the image by electronically compensating for relatively minor image shaking that is often annoying in close-up shots.



Note:

- The DIS function cannot compensate for excessive image shaking.

Turning Off the DIS Function

When image shaking does not occur (e.g. when using the camcorder on a tripod), turn off the DIS function. The picture will appear more natural when the DIS function is off.

- 1 Set the camcorder to TAPE-CAMERA or CARD-CAMERA mode.
- 2 Press the MENU/DISPLAY button until the menu screen appears.
- 3 Select , then press **▶▶** on the Operation button. Select "DIS" (①), then press **▶▶** (②).

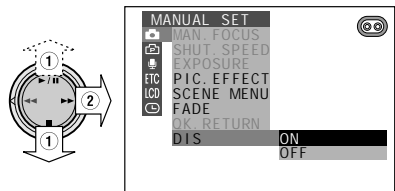

- 4 Press **■** or **▶/||** to select "OFF", then press **◀◀**.

DIS OFF

- 5 Press the MENU/DISPLAY button to turn off the menu screen.

- The  indicator is turned off.

To return to DIS mode

Select "ON" in step 4 above.

Setting the Digital Zoom

You can select from among four different zoom ranges: 1–26× (optical zoom), 26–50× (digital zoom), 26–100× (digital zoom) or 26–780× (digital zoom). The digital zoom allows you to record powerful close-up pictures with the same operation as normal zooming.

Notes:

- The digital zoom is in addition to the optical zoom giving a combined maximum zoom range of 1–780×.
- **As the image is enlarged digitally, the picture quality decreases when higher digital zoom settings are used.**

- 1 Set the camcorder to TAPE-CAMERA or CARD-CAMERA mode.
- 2 Press the MENU/DISPLAY button until the menu screen appears.

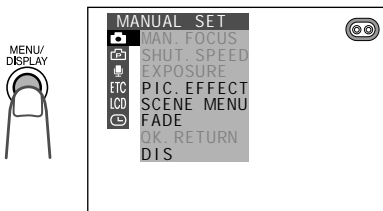

- 3 Select , then press **▶▶** on the Operation button. Select "DGTL ZOOM" (①), then press **▶▶** (②).

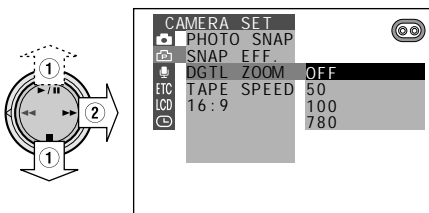

- 4 Press **■** or **▶/||** to select "50", "100" or "780", then press **◀◀**.

DGTL ZOOM 100

- 5 Press the MENU/DISPLAY button to turn off the menu screen.
 - The "D" digital zoom indicator is displayed during digital zooming.

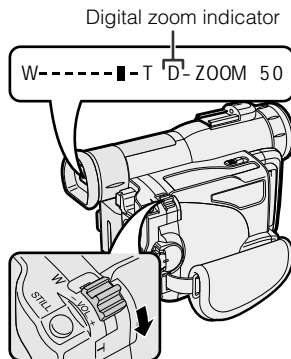

To use optical zoom only

Select "OFF" in step 4 above.

Gamma Brightness Compensation

When the subject is backlit, the image will appear dark if it is recorded normally. The gamma brightness compensation function improves the picture by increasing the brightness of the subject while leaving the brighter portion of the image unaffected.

GAMMA/BRIGHTER button

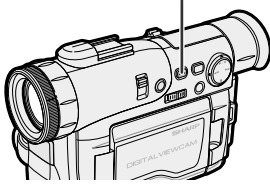

In TAPE-CAMERA or CARD-CAMERA mode, press the GAMMA/BRIGHTER button once.

- "GAMMA" appears, indicating that Gamma Brightness Compensation is now working.

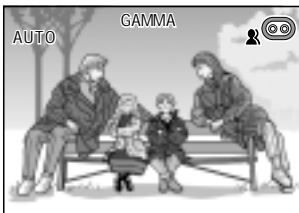

To obtain a brighter picture

Press the GAMMA/BRIGHTER button again.

- The  indicator appears.

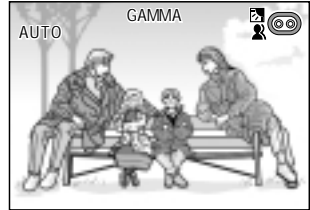

Note:

- When the  indicator is displayed, the background will become slightly brighter.

To cancel Gamma Brightness Compensation

Press the GAMMA/BRIGHTER button until "GAMMA" disappears.

Gain-up

When you are recording in a dark or poorly-illuminated location, "LIGHT" is displayed on the screen. Use the gain-up function to record a brighter picture.

Note:

- At locations where lighting is adequate, "LIGHT" will not appear. The gain-up function cannot be used in this case.

GAMMA/BRIGHTER button

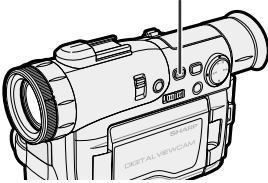

In TAPE-CAMERA or CARD-CAMERA mode, press the GAMMA/BRIGHTER button once.

- "GAMMA" appears, indicating that the gain-up function is now working.

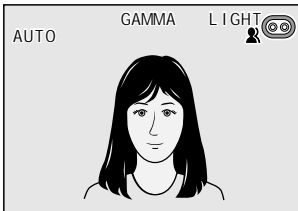
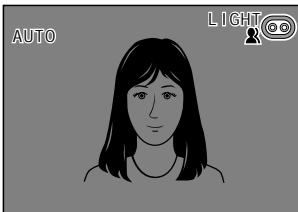

To obtain a brighter picture

Press the GAMMA/BRIGHTER button again.

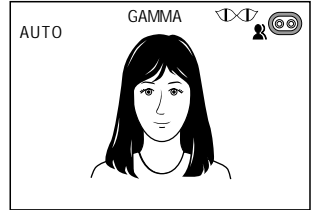

- The  indicator appears.



To cancel the gain-up function

Press the GAMMA/BRIGHTER button until "GAMMA" disappears.

Notes:

- Some picture noise appears in Gain-up mode. The picture noise increases when the  indicator is displayed.
- When the  indicator is displayed, a residual image may appear behind a subject that exhibits a lot of movement.
- Fine brightness adjustment is possible using the manual exposure function (see page 51).

Useful Features Camera Recording

Night Recording (Super Cat's Eye)

The night recording function allows you to record the subject in absolute darkness. This is useful when you want to record subjects at night, e.g. a nocturnal animal, without artificial light.

Note:

- Use Night Recording when "LIGHT" is displayed. Do not use in a bright location such as outdoors in broad daylight.

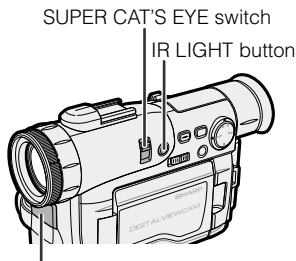

Infrared light transmitter

In TAPE-CAMERA or CARD-CAMERA mode, set the SUPER CAT'S EYE switch to ON.

- "SUPER CAT'S EYE" appears, and the picture becomes brighter.

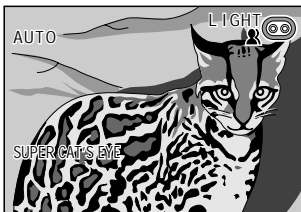

To obtain a brighter picture

Press the IR LIGHT button.

- "SUPER CAT'S EYE" changes to "IR LIGHT", and the camcorder emits infrared light from the transmitter.
- The picture becomes monochrome.

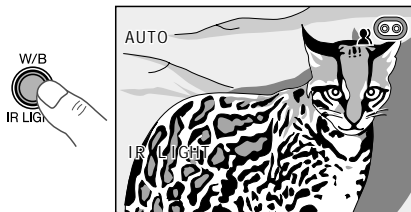

To cancel Night Recording



Set the SUPER CAT'S EYE switch to OFF.

Notes:



- The picture will turn white if you use Night Recording in a bright location.
- The camcorder may not be able to focus correctly when using Night Recording. In such cases, use the manual focus function to obtain proper focus (see page 47).
- Infrared light emitted from the camcorder illuminates an area up to about 10 feet (3 m) away.
- The following functions do not work when using Night Recording.
 - Manual shutter speed
 - Manual exposure
 - White balance lock
 - Scene menu
- You can obtain a much brighter picture of the subject by pressing the GAMMA/BRIGHTER button to select Gain-up mode and then setting the SUPER CAT'S EYE switch to ON.

Quick Return

When you have been playing back what you have recorded on the tape, and wish to quickly return to recording from the end of the last recorded scene, use the quick return function.

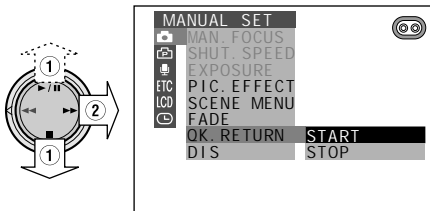
- 1 Set the camcorder to TAPE-CAMERA mode.
- 2 In Recording Standby mode, press the MENU/DISPLAY button until the menu screen appears.
- 3 Select , then press  on the Operation button. Select "QK. RETURN" (1), then press  (2).



- 4 Press  or /|| to select "START", then press .
 - "SEARCH" flashes, and the tape begins fast forwarding or rewinding to the end of the last recorded scene.



When the tape reaches the end of the last recorded scene, "FINISHED" is displayed, and the camcorder enters Recording Standby mode.

- 5 Press the MENU/DISPLAY button to turn off the menu screen.

Notes:



- To cancel the quick return function, press  to select "STOP", then press .
- If the cassette has been removed since the last recording or if no recording has been made since the cassette was loaded, the quick return function cannot be used.

Edit Search

The edit search function lets you search, without switching from TAPE-CAMERA mode to TAPE-VCR mode, for the point on the tape where you wish to start recording next.

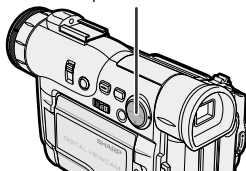
Operation button



- 1 Set the camcorder to TAPE-CAMERA mode.
- 2 In Recording Standby mode, press and hold down  (forward edit search) or  (reverse edit search) on the Operation button.
- 3 When you find the point where you want to begin recording, release the button.

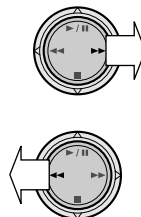

Notes:

- The sound is off during search.
- Forward edit search is performed at the same speed as normal playback, and reverse edit search at 5.5 times the normal playback speed.
- Some picture noise appears during reverse edit search.

Useful Features

Camera Recording

Fade In and Fade Out

The fade function allows you to gradually bring the image and sound in or out at the beginning or end of a scene for creating scene transitions. This is especially effective for indicating a dramatic change in scenery.

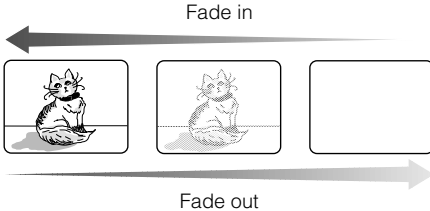

- Press the MENU/DISPLAY button to turn off the menu screen.
 - “FADE” is displayed.

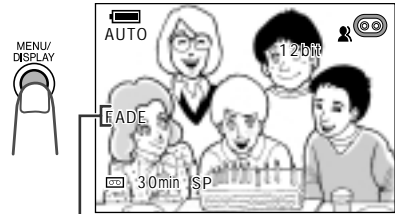

FADE indicator

Using Fade Mode

- Press the REC START/STOP button to begin recording.
 - The picture turns white, and the image and sound fade in.

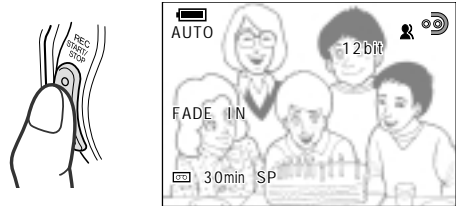

- Press the REC START/STOP button at the point where you wish to stop recording.
 - The image and sound fade out as the picture gradually turns white. The camcorder then returns to Recording Standby mode.



Setting Fade Mode

- Set the camcorder to TAPE-CAMERA mode.
- Press the MENU/DISPLAY button until the menu screen appears.
- Select , then press on the Operation button. Select “FADE” (1), then press (2).

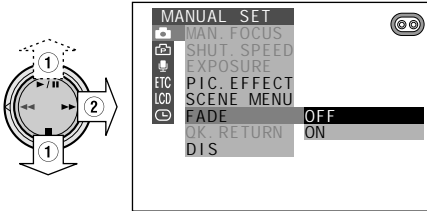

- Press or to select “ON”, then press .



To cancel Fade mode

Select "OFF" in step 4 in "Setting Fade Mode".

To use Fade Out only

- 1 During camera recording in TAPE-CAMERA mode, perform steps 2 to 5 in "Setting Fade Mode" to display "FADE".
- 2 Press the REC START/STOP button at the point where you wish to stop recording.



Note:

- Fade mode is automatically canceled after Fade Out.



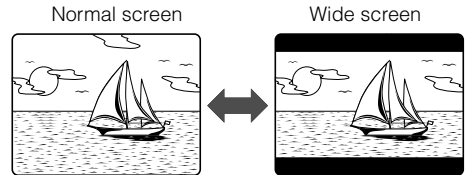

Wide Screen (16:9)

The wide screen function lets you record scenes with the wide-screen feel of a movie shown in a theater. The top and bottom of the picture are masked with black bands to produce an effective screen aspect ratio of 16:9.

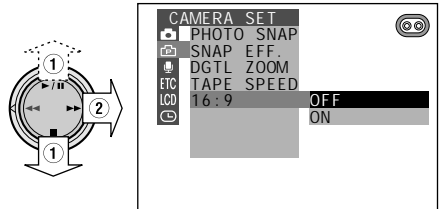

- 1 Set the camcorder to TAPE-CAMERA mode.
- 2 Press the MENU/DISPLAY button until the menu screen appears.
- 3 Select , then press  on the Operation button. Select "16:9" (1), then press  (2).



- 4 Press  or  /  to select "ON", then press .
- 
- 5 Press the MENU/DISPLAY button to turn off the menu screen.
 - The picture is displayed with the top and bottom portions masked.

To return to normal screen

Select "OFF" in step 4 above.

Notes:

- You can only use the wide screen function when the camcorder is in TAPE-CAMERA mode.
- Each frame picture will not be displayed in Wide Screen mode when a still recording effect is set during Wide Screen mode.

Useful Features

Camera Recording

Still Recording on Tape



You can record still images of subjects with normal sound on a tape by selecting one of two still recording modes.

Type of Still Recording modes



SNAP: A still picture is recorded for 6 seconds.

STILL: A continuous still image is recorded.

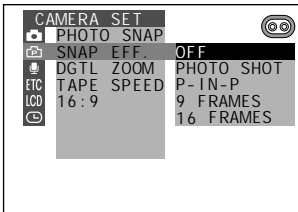
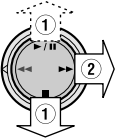

Selecting Still Recording Mode

- 1 Set the camcorder to TAPE-CAMERA mode.
- 2 Press the MENU/DISPLAY button until the menu screen appears.
- 3 Select , then press  on the Operation button. Select "SNAP EFF" (1), then press  (2).



- 4 Press  or  to select "OFF", then press .

SNAP EFF. OFF

- 5 Press  (1) to select "PHOTO SNAP", then press  (2).

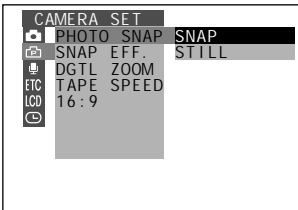
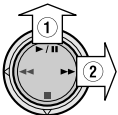



- 6 Press  or  to select the desired still recording mode, then press .

PHOTO SNAP STILL

- 7 Press the MENU/DISPLAY button to turn off the menu screen.

Using Still Recording

- 1 Set the camcorder to TAPE-CAMERA mode.

- 2 In Recording Standby mode, press the STILL button.

- A still image of the subject is displayed.

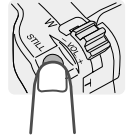

- 3 Press the REC START/STOP button.

- The still image of the subject will be recorded.

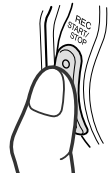

In SNAP mode, the camcorder returns to Recording Standby mode after recording a still image for 6 seconds.

To pause recording

Press the REC START/STOP button.

To cancel the still image

In SNAP mode, press the STILL button while the camcorder is in Recording Standby mode.

In STILL mode, press the STILL button.

Notes:

- Still Recording can also be used during recording by pressing the STILL button.
- The picture quality in Still Recording mode will be slightly lower than normal pictures.

Still Recording Effects

You can select one of these still recording effects to record the still images with an effect.

Type of Still Recording Effects

PHOTO SHOT: A still picture is recorded following the sound and visual effects of a camera shutter closing.

P-IN-P: A still image is recorded within an inset image displayed on a motion picture.

9 FRAMES: A still picture is recorded at intervals of 1/10 of a second using a 9-frame picture.

16 FRAMES: A still picture is recorded at intervals of 1/10 of a second using a 16-frame picture.

Selecting a still recording effect

- 1 Set the camcorder to TAPE-CAMERA or CARD-CAMERA mode.
 - 2 Press the MENU/DISPLAY button until the menu screen appears.
 - 3 Select , then press **▶▶** on the Operation button.
- Note:**
- In TAPE-CAMERA mode, select the desired still recording mode (see page 39).
- 4 Press **■** or **▶/||** (①) to select "SNAP EFF", then press **▶▶** (②).

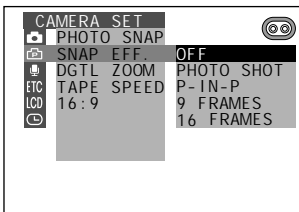
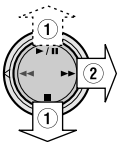

- 5 Press **■** or **▶/||** to select the desired still recording effect, then press **◀◀**.

SNAP EFF. PHOTO SHOT

- 6 Press the MENU/DISPLAY button to turn off the menu screen.

Using PHOTO SHOT, 9 FRAMES or 16 FRAMES mode

- 1 Perform the steps in "Selecting a still recording effect" to select "PHOTO SHOT", "9 FRAMES" or "16 FRAMES".
- 2 In Recording Standby mode, press the STILL button.
 - In TAPE-CAMERA mode, a still image of the subject is displayed with the selected effect. Perform step 3.
 - In CARD-CAMERA mode, the still image of the subject will be recorded with the selected effect. Omit step 3.
- 3 Press the REC START/STOP button.
 - The still image of the subject will be recorded on tape.

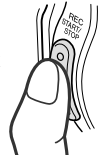
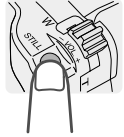

To cancel the still image in TAPE-CAMERA mode

In **SNAP mode**, press the STILL button while the camcorder is in Recording Standby mode.

In **STILL mode**, press the STILL button.

Notes:

- Still recording effects can also be used during recording on tape by pressing the STILL button.
- If you use PHOTO SHOT during recording on tape, the visual effects of a camera shutter closing are recorded.
- You can use PHOTO SHOT without the sound effect of a camera shutter closing by setting the SOUND menu item to "OFF" (see page 56).
- The picture quality in Still Recording Effects mode will be slightly lower than normal pictures.

Useful Features

Camera Recording

Using P-IN-P mode

- 1 Perform the steps in “Selecting a still recording effect” to select “P-IN-P” (see page 40).
- 2 In Recording Standby mode, press the STILL button.
 - An inset image of the subject is displayed.



- To change the position of the inset image, press ◀ or ▶ on the Operation button. The inset image moves as shown below.

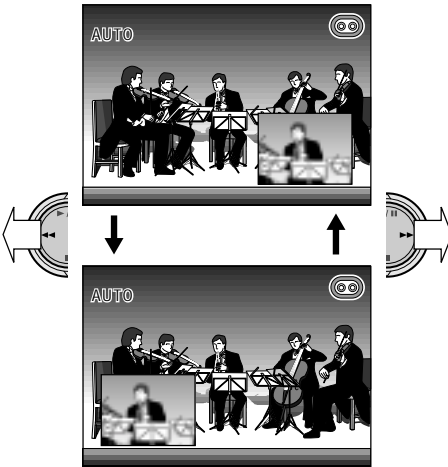

- 3 Adjust the Power Zoom control to frame the inset subject.

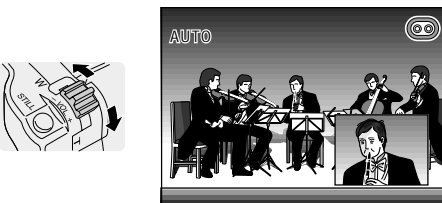

- 4 Press ▶ / || to freeze the inset image.

Note:

- Pressing ▶ / ||, ◀◀ or ▶▶ while the inset image is frozen cancels the still image.

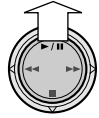

- 5 Press the REC START/ STOP button.

- The still image of the subject will be recorded.
- In CARD-CAMERA mode, press the STILL button, instead of the REC START/ STOP button.

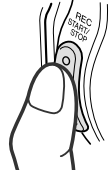

To pause recording on tape

Press the REC START/STOP button.

To turn off the inset image

Press the MENU/DISPLAY button.

To cancel still recording effects

Select “OFF” in step 5 of “Selecting a still recording effect”.

Note:

- P-IN-P mode cannot be used together with the following functions.
 - Mosaic picture effect
 - DIS
 - 16:9
 - Brighter mode (◁▷) of the gain-up function
 - Digital zoom

Letting the Subject Monitor the Shot

Open the LCD monitor and rotate it 180° vertically so that the screen faces the other way and the subject can monitor the shot while you are recording with the viewfinder.

If the camcorder is steadied, you can record yourself in the scene by watching yourself on the LCD monitor. The supplied remote control is useful for such occasions.

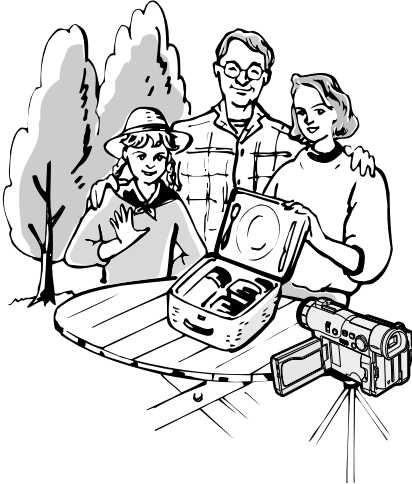

- 1 Open the LCD monitor to a 90° angle to the camcorder body (①), and then rotate it 180° vertically (②).

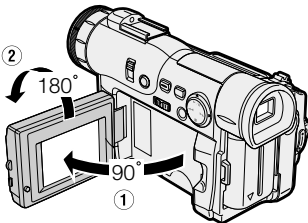

- 2 Set the Power switch to CAMERA.
 - The subject is displayed in the viewfinder, and a mirror image of the subject is displayed on the LCD monitor.

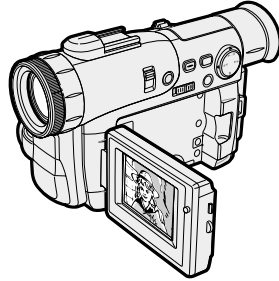

- 3 Set the Media Selection switch to TAPE or CARD, and begin recording.

Caution:

- Do not invert the image by rotating the monitor during recording.

Notes:

- The screen image is automatically inverted when the vertical rotation of the monitor is between 135° and 180°. When the monitor is rotated back to within 135°, the image returns to normal.
- If the \diamond indicator flashes when the monitor is in the inverted position, this indicates a warning. To check the type of warning, rotate the monitor back to within 135°. (See pages 7 and 8 for descriptions of the warning indicators.)

Useful Features

Camera Recording

Auto Focus

The camcorder is preset to Auto Focus mode, which is designed to focus on most types of subjects. In Auto Focus mode, the camcorder automatically focuses on whatever is in the center of the scene. Always keep the subject in the center of the scene.

Notes:

- If no subject is in the center of the scene, the focus area will expand and the subject nearest the center will be focused on.
- If no subject is displayed, the camcorder will automatically zoom out until a subject comes into the frame.
- Auto Focus may not work in the situations described on page 47. In these situations, use the manual focus function.

Macro Shots

This camcorder lets you shoot close-up images of small objects such as flowers and insects, or make title frames for your videos. When you want to record a magnified image of a subject which is within approximately 6 feet (1.8 m) of the camcorder, do not zoom in on it. Instead, zoom out all the way by pushing the Power Zoom control to the W side, and then move the camcorder closer to the subject until you obtain the desired angle of view. The camcorder will automatically focus on the subject when the lens is set for the widest angle.

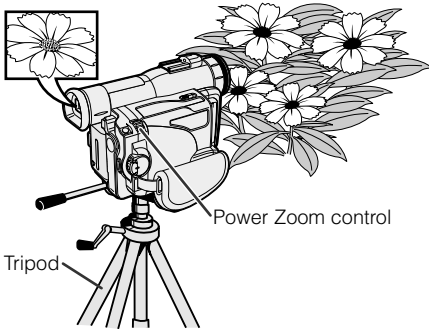

Notes:

- When you are recording a macro shot, be sure that the subject receives sufficient illumination.
- It is recommended that you use a tripod for recording macro shots, to prevent image shaking.

Using the Remote Control

Use the supplied remote control to operate the camcorder from a distance, such as when you want to record yourself in a scene, or when the camcorder is connected to a TV for use as a VCR.

Installing the Batteries in the Remote Control

- 1 Open the battery compartment cover.
- 2 Insert the two supplied AA (R6 or UM/SUM-3) batteries with the battery poles positioned as indicated.

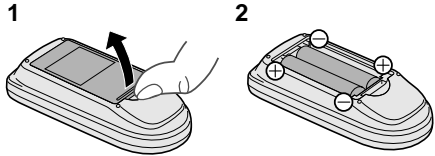

- 3 Replace the cover.

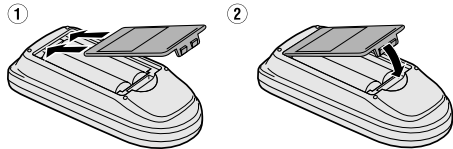

Caution:

- Do not use old and new batteries together or batteries of different brands together.

Turning on the Remote Control Mode

- 1 Press the MENU/DISPLAY button until the menu screen appears.
- 2 Select ETC, then press ►► on the Operation button. Select "REMOTE" (①), then press ►► (②).

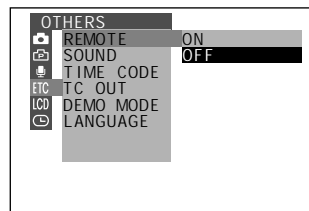
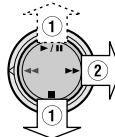

- 3 Press **■** or **▶/||** to select "ON", then press **◀◀**.

REMOTE **ON**

- 4 Press the MENU/DISPLAY button to turn off the menu screen.

Operating the Remote Control

- 1 Open the LCD monitor completely (①), then rotate it 180° vertically (②).

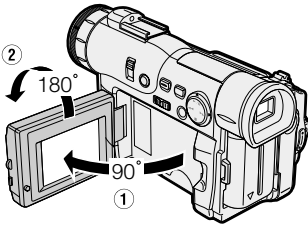

- 2 Set the Media Selection switch on the camcorder to TAPE or CARD.
- 3 Set the Power switch on the camcorder to CAMERA or VCR.
- 4 Aim the remote control at the remote sensor of the camcorder, and press the control buttons for operation.

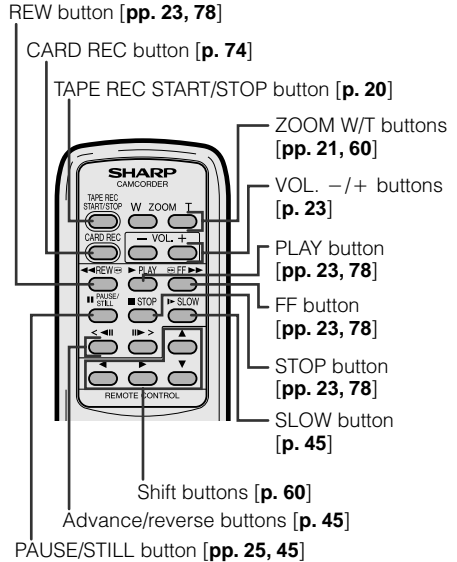
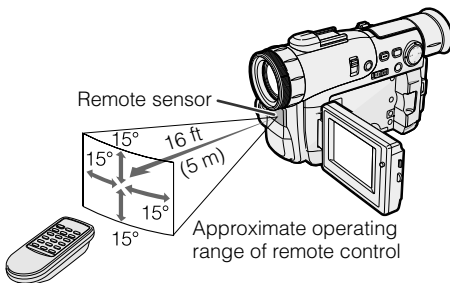

Notes:

- Be careful not to allow direct sunlight or bright light from interior illumination to fall onto the remote sensor, as this may prevent the remote control from operating properly.
- Be sure that there are no obstacles between the remote control and the remote sensor.
- When the batteries are depleted and the remote control does not operate, replace them with new AA (R6 or UM/SUM-3) batteries.

Useful Features

Playback

Playback Functions with the Remote Control

These playback functions can be operated using the supplied remote control. (See pages 43 and 44 for use of the remote control.)

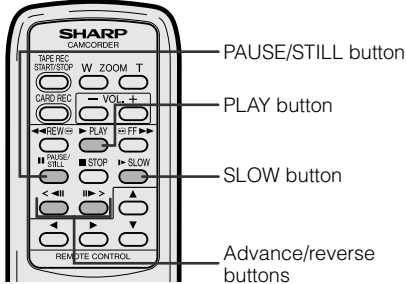

Reverse Playback

The reverse playback function allows you to play back video in reverse.

During playback in TAPE-VCR mode, press the ◀◀ button.

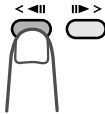

To return to normal playback, press the PLAY button (▶).

Slow

The slow function allows you to play back images in slow motion.

During playback in TAPE-VCR mode, press the ▶SLOW button.



To view slow playback in reverse, press the ◀◀ button.

To return to normal playback, press the PLAY button (▶).

Note:

- To protect the tape, the camcorder automatically returns to normal playback if it is left in Slow mode for more than 10 minutes.

Frame Advance

The frame advance function allows you to play back still images frame by frame.

- 1 During playback in TAPE-VCR mode, press the PAUSE/STILL button (||) to pause playback.



- 2 Press the ||▶ (or ◀||) button.
 - Each time you press the button, the picture advances one frame forward (or backward).

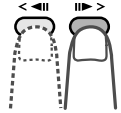

To return to normal playback, press the PLAY button (▶).

Notes:

- The sound is off during reverse, slow, and frame advance playback.
- If you use the slow or frame advance function with the tape recorded in LP mode, the picture may advance several frames at a time.
- Clearer still images can be achieved by recording with a fast shutter speed (see page 49).

Using the Time Code

The time code shows the hour, minute and second of recording, and the frame number (1 frame = approx. 1/30 sec.). This is automatically recorded along with the subject when you are recording on the tape. You can display the time code on the screen as an accurate counter in both TAPE-VCR and TAPE-CAMERA modes.

Display format

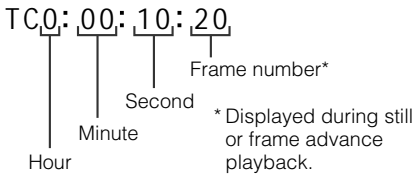

• The example screens for this feature are for TAPE-VCR mode.

- 1 During playback or camera recording in TAPE modes, press the MENU/DISPLAY button until the menu screen appears.
- 2 Select ETC, then press ►► on the Operation button. Select "TIME CODE" (①), then press ►► (②).

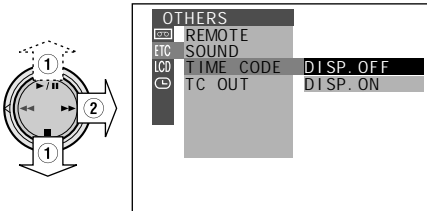

- 3 Press ■ or ►/|| to select "DISP. ON", then press ◀◀.



- 4 Press the MENU/DISPLAY button to turn off the menu screen.
 - The time code appears.

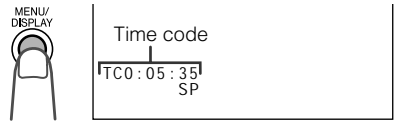

To turn off the time code

Select "DISP. OFF" in step 3 above.

Note:

- When the tape reaches an unrecorded section, the time code returns to zero (TC0:00:00). Once recorded, the time code cannot be changed.

Displaying the time code on a TV during playback

- 1 In TAPE-VCR mode, select ETC, then press ►► on the Operation button. Select "TC OUT" (①), then press ►► (②).

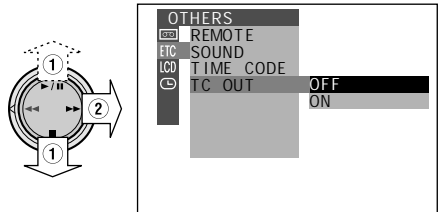

- 2 Press ■ or ►/|| to select "ON", then press ◀◀.











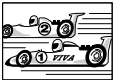

Advanced Features

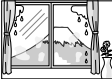
Camera Recording

Manual Focus

Auto Focus may not be able to focus on the subject in the situations shown below. In such situations, set the camcorder to Manual Focus mode and focus manually.

 Subject is too dark.	 Lack of contrast, e.g. snow scene.
 Fast-moving subject.	 Background is too bright.
 Subject has horizontal stripes.	 Subject is being shot through a dirty or wet window.
 Light reflects off the subject.	 Two subjects at different distances overlap in the same scene.
 Subject has fine, repeated patterns.	 Subjects at different distances appear in the center of the scene at the same time.
 Fast-speed shutter being used under fluorescent lighting.	

- 1 Set the camcorder to TAPE-CAMERA or CARD-CAMERA mode.
- 2 Press the AUTO ON/OFF button to select Manual mode.
- 3 Press the MENU/DISPLAY button until the menu screen appears.
- 4 Select , then press **▶▶** on the Operation button. Select "MAN. FOCUS" (①), then press **▶▶** (②).

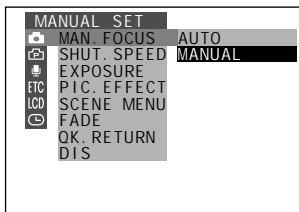
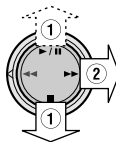

- 5 Press **◀◀** to display the focus setting screen.

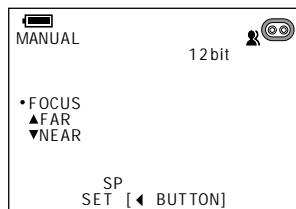
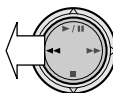

- 6 Adjust the Power Zoom control to frame the subject as you desire.



7 Press **■** or **▶/■** (1) to focus on the subject, then press **◀** (2).

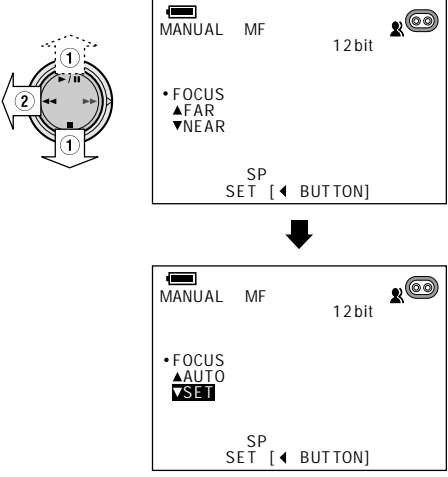

To cancel Manual Focus mode

After performing step 4 above, select "AUTO", then press **◀**.

Notes:

- The camcorder may not be able to focus correctly if the subject is within approximately 6 feet (1.8 m). Set the zoom control to wide angle, and then try refocusing.
- If the lens is dirty or fogged, the camcorder may not be able to correctly focus.
- When "MF" is displayed, you can manually adjust the focus by pressing **■** or **▶/■**, even if the focus setting screen is not displayed.
- When you want to cancel all manual settings and return to Auto mode, press the AUTO ON/OFF button.

8 Press **◀**.

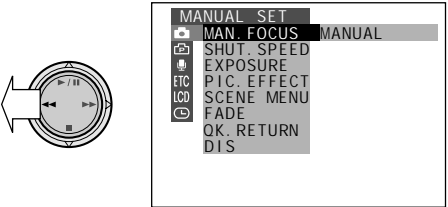

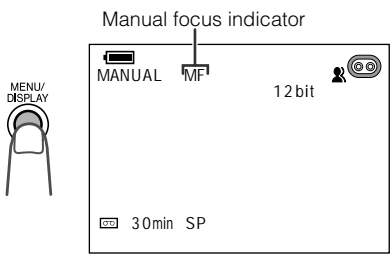

9 Press the MENU/DISPLAY button to turn off the menu screen.

- "MF" is displayed.





Setting the Shutter Speed

The shutter speed is preset to auto mode, which automatically chooses the optimal shutter speed for the ambient light. However, depending on the subject or situation, you may want to set the shutter speed manually to create a high-quality picture.

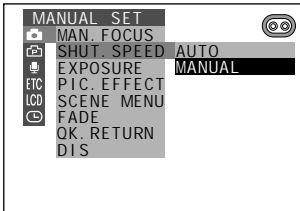
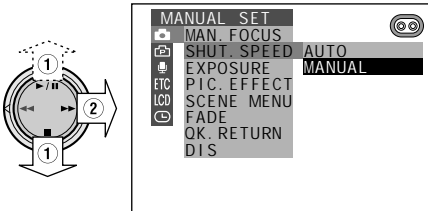
- 1 Set the camcorder to TAPE-CAMERA or CARD-CAMERA mode.
- 2 Press the AUTO ON/OFF button to select Manual mode.
- 3 Press the MENU/DISPLAY button until the menu screen appears.
- 4 Select , then press  on the Operation button. Select "SHUT. SPEED" (1), then press  (2).



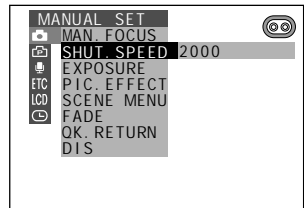
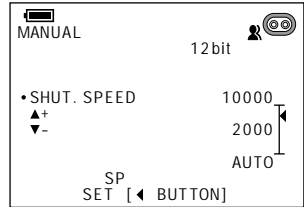
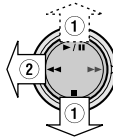

- 6 Press  or  (1) to select the desired shutter speed, then press  (2).
 - The selected shutter speed is displayed on the menu screen.



- 7 Press the MENU/DISPLAY button to turn off the menu screen.

To return to Auto Shutter Speed mode

After performing step 4 above, select "AUTO", then press .

- 5 Press  to display the shutter speed setting screen.

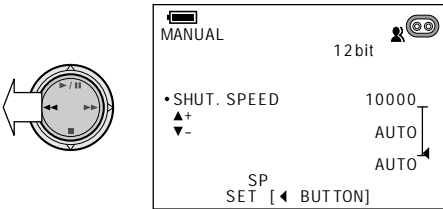

Shutter speed indicator	Shutter speed
10000	1/10,000 sec.
4000	1/4,000 sec.
2000	1/2,000 sec.
1000	1/1,000 sec.
500	1/500 sec.
250	1/250 sec.
100	1/100 sec.
60	1/60 sec.
AUTO	Variable

Recommended Shutter Speeds

The faster the shutter speed, the darker the picture becomes. Select the most appropriate shutter speed for the ambient light.

Situation	Recommended shutter speed
<ul style="list-style-type: none"> Recording sports action in bright daylight. Recording in bright daylight at a ski resort. 	1/10,000 sec. 1/1,000 sec.
<ul style="list-style-type: none"> Recording outdoor sports on a partially cloudy day. Recording an outside scene through a car window (when you want to minimize blur caused by the camera shaking). 	1/1,000 sec. 1/250 sec.
<ul style="list-style-type: none"> When you want to reduce the light by half. Use as a substitute for an ND2 filter. 	1/100 sec.

Notes:

- Recording with a shutter speed faster than 1/60 sec. tends to darken the picture. Record in bright locations when you use a fast shutter speed.
- Using a fast shutter speed under fluorescent lighting will cause flickering in the picture and possibly periodic color shifts.
- The manual shutter speed setting will be canceled if a scene setting is selected thereafter.**
- The manual shutter speed setting cannot be used with Night Recording.**
- When you want to cancel all manual settings and return to Auto mode, press the AUTO ON/OFF button.

Tips on Using the Manual Shutter Speed

- Fast shutter speeds can be used with the still recording function (see page 39) to record higher quality still images of fast-moving subjects.
- If the on-screen picture flickers when recording under fluorescent lighting, you may be able to compensate by setting the shutter speed to 1/100 sec.

Manual Exposure

The camcorder is preset to Auto Exposure mode, which automatically chooses the optimal aperture. When there is too much contrast in brightness between the subject and background, however, you may not be able to record a clear image. In this case, use the manual exposure function to correct the exposure level.

Background is too bright and subject too dark (backlit subject).

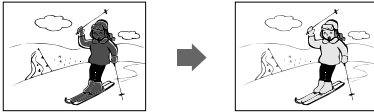

- Increase the exposure level to allow more light through the lens.





Subject is too bright against background.

- Decrease the exposure level to allow less light through the lens.



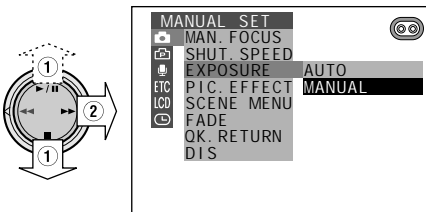

- 1 Set the camcorder to TAPE-CAMERA or CARD-CAMERA mode.
- 2 Press the AUTO ON/OFF button to select Manual mode.
- 3 Press the MENU/DISPLAY button until the menu screen appears.
- 4 Select , then press  on the Operation button. Select "EXPOSURE" (1), then press  (2).

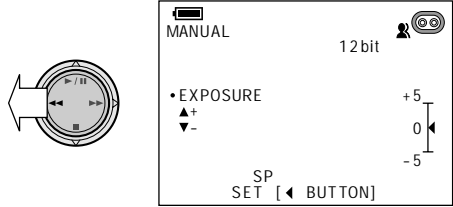

- 5 Press  to display the exposure setting screen.



- 6 Press  or  to select the desired exposure level.
 - The number shown is the selected exposure level. The adjustment range is from -5 (least light) to +5 (most light).

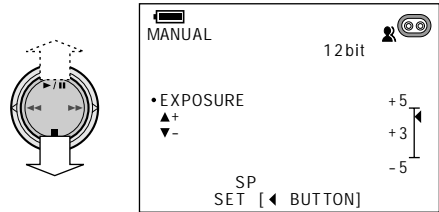

- 7 Press .
 - The selected exposure level is displayed on the menu screen.

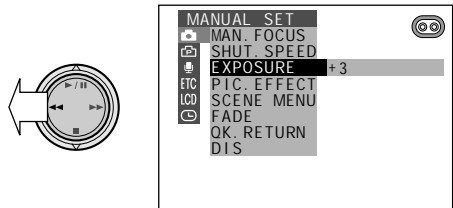

- 8 Press the MENU/DISPLAY button to turn off the menu screen.

To cancel Manual Exposure mode

After performing step 4 above, select "AUTO", then press .

Notes:

- **Manual Exposure mode will be canceled if a scene setting is selected thereafter.**
- **Manual Exposure cannot be used with Night Recording.**
- When you want to cancel all manual settings and return to Auto mode, press the AUTO ON/OFF button.

White Balance Lock

The color of the subject on the screen tends to look different depending on the lighting condition. The camcorder is preset to Auto White Balance mode, which automatically adjusts the hue of the picture for the current lighting condition.

Auto White Balance may not work properly for the following subjects. In this case, use the white balance lock function.

- Subjects with one dominant color or subjects against background with one dominant color
- Subjects under very bright light source, e.g. video lights
- Subjects under light source with red hue, e.g. glow of sunset
- Close-up images of small objects

Note:

- **White Balance Lock cannot be set when the camcorder is in Easy mode or the SUPER CAT'S EYE switch is set to ON.**

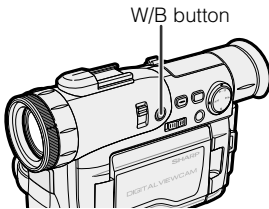

- 1 Set the camcorder to TAPE-CAMERA or CARD-CAMERA mode.
- 2 Press the W/B button to display the white balance lock screen.



- 3 Aim the lens at a white object.
 - Adjust the distance of the object so that the entire screen is white.

- 4 Press the MENU/DISPLAY button to set the white balance lock.

- "W/B LOCK" flashes during the locking procedure. To cancel the locking procedure, press the MENU/DISPLAY button while "W/B LOCK" flashes.

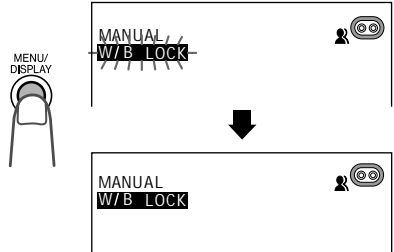

- 5 Press the W/B button to turn off the white balance lock screen.

- "W/B LOCK" is displayed.

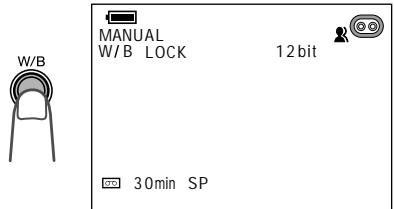

To cancel White Balance Lock

- 1 Press the W/B button, then press the MENU/DISPLAY button.
 - "W/B LOCK" changes to "WHITE BAL.".
- 2 Press the W/B button to turn off the white balance lock screen.

Notes:

- If the light source changes or if you move from indoors to outdoors, or vice versa, when recording with the white balance locked, the white balance may shift. Reset the white balance.
- Do not move the camcorder while "W/B LOCK" is flashing in step 4.
- If "W/B LOCK" does not stop flashing in step 4, press the MENU/DISPLAY button to cancel the locking procedure, and repeat step 4.
- **White Balance Lock will be canceled if a scene setting is selected thereafter.**

Advanced Features

Camera Recording

Digital Picture Effects

These digital picture effects let you record the subject with a more dramatic effect.

Type of Digital Picture Effects

B/W: To record in black-and-white.

SEPIA: To record in sepia color similar to that of an old photograph.



MOSAIC: To record a picture divided up into tiles.

SOLARI: To record with enhanced contrast, creating a unique artistic image.



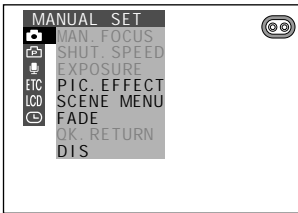

NEGA: To record a picture whose blacks and whites of the image are reversed and colors of the image are inverted.

- 1 Set the camcorder to TAPE-CAMERA or CARD-CAMERA mode.
- 2 Press the MENU/DISPLAY button until the menu screen appears.

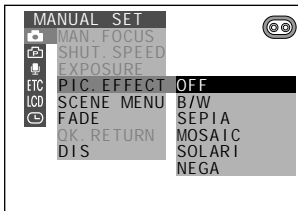
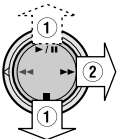

- 3 Select , then press  on the Operation button. Select "PIC. EFFECT" (1), then press  (2).



- 4 Press  or /  to select the desired digital picture effect, then press .
 - The selected digital picture effect is displayed on the menu screen.

PIC. EFFECT B/W

- 5 Press the MENU/DISPLAY button to turn off the menu screen.

To cancel the digital picture effect

Select "OFF" in step 4 above.

Note:

- Digital picture effects cannot be used when a still image is displayed.

Scene Menu (Program AE)

You can set the camcorder to the shooting mode that will create the best results for a specific situation. Just select one of four scene settings shown below. The camcorder will automatically set the exposure, white balance, and shutter speed to produce the optimum picture quality for the selected situation.

Type of Scene Settings

SPORT: When you want to record a fast-moving subject.

SUNLIGHT: When the background is very bright.

DUSK: When you want to faithfully record the red of the setting sun, and the surrounding twilight.

PARTY: When the illumination is from a spotlight or candles.

1 Set the camcorder to TAPE-CAMERA or CARD-CAMERA mode.

2 Press the MENU/DISPLAY button until the menu screen appears.

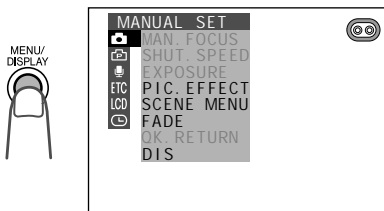

3 Select , then press **▶▶** on the Operation button. Select "SCENE MENU" (①), then press **▶▶** (②).

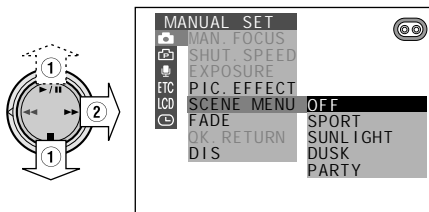

4 Press **■** or **▶/||** to select the scene setting that best fits the recording situation, then press **◀◀**.

- The selected scene setting is displayed on the menu screen.

SCENE MENU SPORT

5 Press the MENU/DISPLAY button to turn off the menu screen.

- The selected scene setting indicator is displayed.

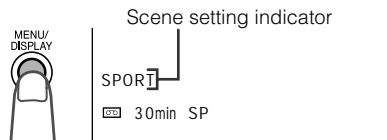

To cancel the scene setting

Select "OFF" in step 4 above.

Note:

- Scene settings cannot be used when Night Recording is used or a still image is displayed.

Using the Zoom Microphone

With the zoom microphone, you can record audio according to the magnification of the zoom lens for producing the optimum sound. You can also set the zoom microphone to record only sounds at a distance.

Mounting the Zoom Microphone

- 1 Align the mounting pin of the zoom microphone with the mounting hole on the camcorder, and slide the zoom microphone in the direction of the arrow until it locks into place.

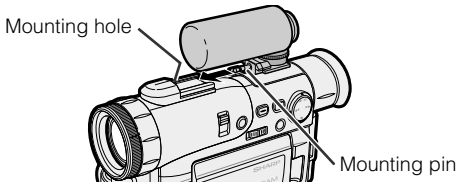

- 2 Turn the screw in the direction of the arrow to secure the zoom microphone.

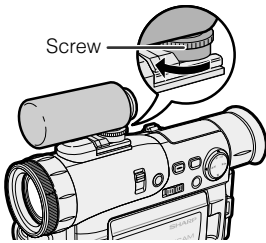

Removing the zoom microphone

Turn the screw in the opposite direction than when mounting, and then pull off the zoom microphone.

Caution:

- Do not pick up the camcorder by the zoom microphone, as this may cause the camcorder or zoom microphone to break down.

Selecting Zoom Microphone Mode



Select a Zoom Microphone mode when the zoom microphone is mounted.

Type of Zoom Microphone modes



AUTO: The camcorder automatically selects the optimum sound according to the magnification of the zoom lens. When the zoom lens is at a wide-angle setting, the built-in microphone is used to record sounds. As the zoom magnification increases, the sounds from the zoom microphone and built-in microphone are mixed according to the zoom setting.

TELE: The zoom microphone is fixed to record sounds at a distance. (The built-in microphone is turned off.)

OFF: The zoom microphone is turned off. (The built-in microphone is on.)

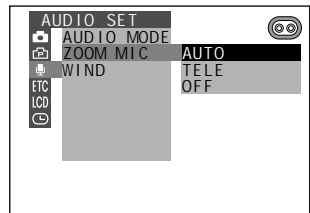
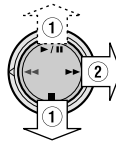
- 1 Mount the zoom microphone to the camcorder.
- 2 Set the camcorder to TAPE-CAMERA mode.
- 3 Press the MENU/DISPLAY button until the menu screen appears.
- 4 Select , then press  on the Operation button. Select "ZOOM MIC" (①), then press  (②).



- 5 Press  or  to select the desired zoom microphone mode, then press .
 - The selected zoom microphone mode is displayed on the menu screen.

ZOOM MIC **AUTO**

- 6 Press the MENU/DISPLAY button to turn off the menu screen.

Note:

- When the camcorder is in Easy mode, the Zoom Microphone mode is fixed to "AUTO" and cannot be selected on the menu screen.

Windbreak

The windbreak function allows you to reduce annoying noise from strong winds when recording.

- 1 Set the camcorder to TAPE-CAMERA mode.
- 2 Press the MENU/DISPLAY button until the menu screen appears.
- 3 Select , then press **▶▶** on the Operation button. Select "WIND" (①), then press **▶▶** (②).

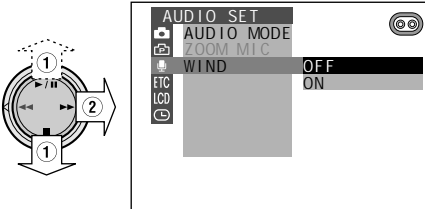

- 4 Press **■** or **▶/||** to select "ON", then press **◀◀**.

WIND ON

- 5 Press the MENU/DISPLAY button to turn off the menu screen.

To cancel Windbreak

Select "OFF" in step 4 above.

Note:

- Keep the windbreak function off during normal recording. If it is left on, the recorded audio may sound somewhat muffled when played back.

Setting the Confirmation Sounds

A confirmation sound is made when you turn on or off the Power switch, press the REC START/STOP button, or perform other designated operations. Use the procedure below to change the type of sound or to turn off the confirmation sounds altogether.

Type of Confirmation Sound Settings

CHIME: A chiming sound is made.

BEEP: An electronic beeping sound is made.

OFF: No confirmation sound is made.

- 1 Press the MENU/DISPLAY button until the menu screen appears.
- 2 Select **ETC**, then press **▶▶** on the Operation button. Select "SOUND" (①), then press **▶▶** (②).

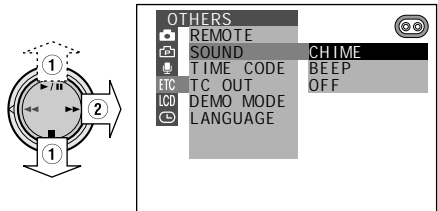

- 3 Press **■** or **▶/||** to select the desired sound setting, then press **◀◀**.

SOUND BEEP

- 4 Press the MENU/DISPLAY button to turn off the menu screen.

Note:

- If "OFF" is selected, the sound effect of a camera shutter closing in PHOTO SHOT mode and CARD-CAMERA mode will also be turned off.

Advanced Features

Camera Recording

World Clock

The world clock function allows you to easily adjust the clock to the local time when you use the camcorder while travelling anywhere around the world.

- Set the area, date and time for your home time zone if they have not already been set (see page 15).

Example: Changing the clock from New York time to Los Angeles time.

- 1 Set the camcorder to TAPE-CAMERA or CARD-CAMERA mode.

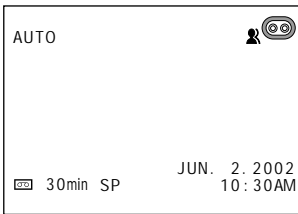

- 2 Press the MENU/DISPLAY button until the menu screen appears.



- 3 Select , then press on the Operation button. Select "AREA" (1), then press (2).

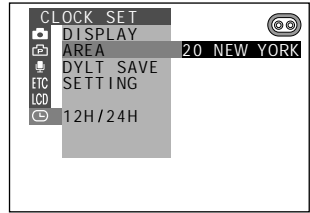
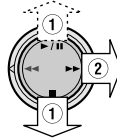

- 4 Press or (1) to select "17 L.A.", then press (2).
 - The camcorder is now set to Los Angeles time.

AREA 17 L. A.

- 5 Press the MENU/DISPLAY button to turn off the menu screen.

Time Zone Chart

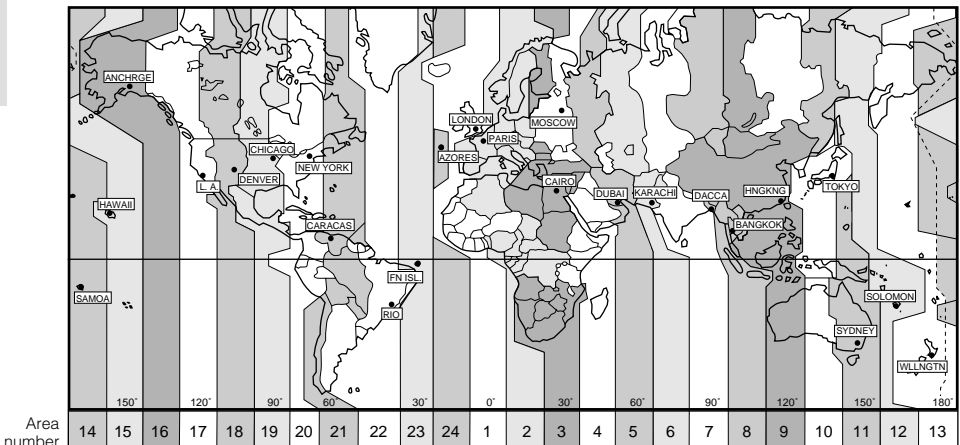

Area Table

Area number	Area name	Countries or areas*
1	LONDON	England, Morocco, GMT (Greenwich mean time)
2	PARIS	Austria, France, Germany, Italy, Netherlands, Spain, Sweden, Switzerland, Portugal, CST (Continental Standard Time), Tunisia
3	CAIRO	Egypt, Finland, Greece, Turkey
4	MOSCOW	Ethiopia, Iraq, Kenya, Mauritius, Saudi Arabia, Seychelles, Russia (Moscow)
5	DUBAI	United Arab Emirates
6	KARACHI	Maldives, Pakistan
7	DACCA	Bangladesh, India, Myanmar
8	BANGKOK	Cambodia, Indonesia (Jakarta), Thailand, Vietnam
9	HNGKNG	Australia (Perth), China, Hong Kong, Indonesia (Borneo, Bali), Malaysia, Philippines, Singapore, Taiwan
10	TOKYO	Japan, Korea
11	SYDNEY	Australia (Sydney)
12	SOLOMON	New Caledonia
13	WLLNGTN	Fiji, New Zealand
14	SAMOA	Western Samoa
15	HAWAII	Hawaii Is., Tahiti, HST (Hawaii Standard Time)
16	ANCHRGE	U.S.A. (Alaska), AST (Alaska Standard Time)
17	L.A.	U.S.A. (Los Angeles, San Francisco), PST (Pacific Standard Time)
18	DENVER	U.S.A. (Denver), MST (Mountain Standard Time)
19	CHICAGO	Mexico (Mexico City), U.S.A. (Chicago), CST (Central Standard Time)
20	NEW YORK	Canada (Montreal), Jamaica, Peru, U.S.A. (New York, Washington D.C.), EST (Eastern Standard Time)
21	CARACAS	Chile, Dominican Republic, Venezuela
22	RIO	Argentina, Brazil, Uruguay
23	FN ISL.	Fernando de Noronha
24	AZORES	Azores Islands

*These are commonly used names. The formal names may be different.

Selecting Daylight Saving Time

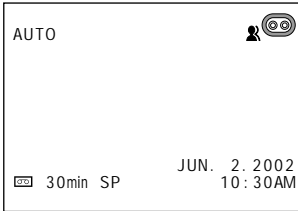

Perform the procedure below to advance the clock of the camcorder one hour to daylight saving time.

- 1 Set the camcorder to TAPE-CAMERA or CARD-CAMERA mode.



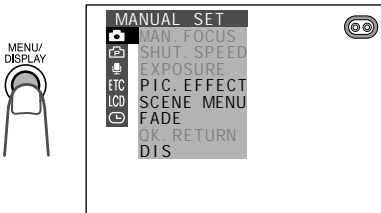

- 2 Press the MENU/DISPLAY button until the menu screen appears.

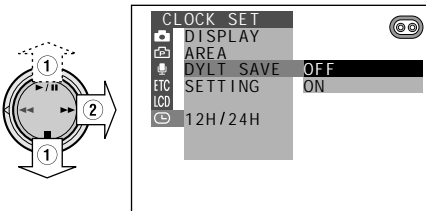

- 3 Select , then press  on the Operation button. Select "DYLT SAVE" (1), then press  (2).



- 4 Press  or  to select "ON", then press .
 - The time automatically changes to daylight saving time.

DYLT SAVE ON

- 5 Press the MENU/DISPLAY button to turn off the menu screen.
 - The  indicator appears when the date/time is displayed.



Daylight saving time indicator

To reset to standard time

Select "OFF" in step 4 above.

Advanced Features

Playback

Playback Zoom

The playback zoom function allows you to magnify the playback picture up to 10 times its original size and to shift the magnified picture by using the remote control (see pages 43 and 44 for use of the remote control).

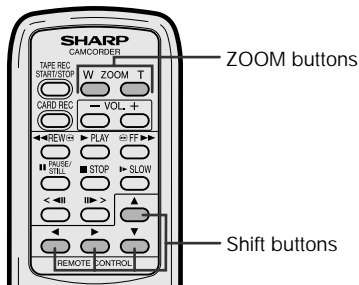

To cancel Playback Zoom

Press the ZOOM W button to zoom out to the widest angle.

Notes:

- Use of Playback Zoom may cause a reduction in picture quality for still images.
- Images in Playback Zoom mode cannot be transferred via DV or PC connect cable to a personal computer.

- The example screens for this feature are for TAPE-VCR mode.

- 1 During playback in TAPE-VCR (or CARD-VCR) mode, press the ZOOM T button to zoom in.



- 2 Press the Shift ◀, ▶, ▲, or ▼ button to shift the displayed image.

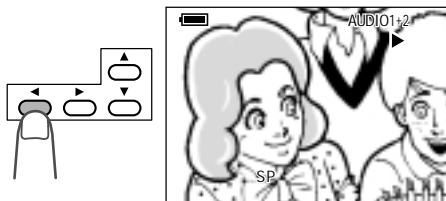

Gamma Playback

The gamma playback function improves the playback picture in TAPE-VCR mode by increasing the brightness of the subject while leaving the brighter portions of the image unaffected.

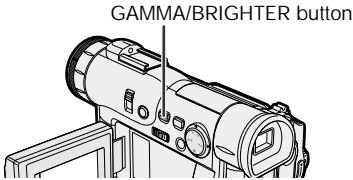

During playback in TAPE-VCR mode, press the GAMMA/BRIGHTER button once.

- "GAMMA1" appears, and the picture becomes brighter.

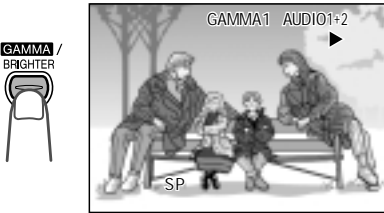

To obtain a brighter picture, press the GAMMA/BRIGHTER button again.

- "GAMMA2" appears.

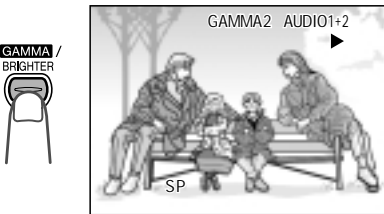

To cancel Gamma Playback



Press the GAMMA/BRIGHTER button until "GAMMA1" and "GAMMA2" disappear.

Note:



- Gamma playback has no effect during still playback.

Multiple Strobe Playback

The multiple strobe playback function can be used to capture the action of a fast-moving subject at intervals of 1/10 of a second using a 9- or 16-frame picture. This is useful when you want to check your form in sports such as tennis or golf.

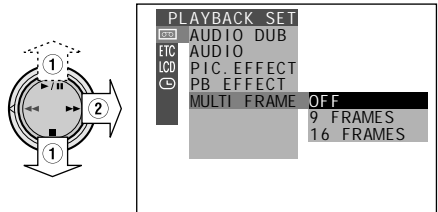
- 1 In TAPE-VCR mode, press the MENU/DISPLAY button until the menu screen appears.
- 2 Select , then press  on the Operation button. Select "MULTI FRAME" (1), then press  (2).



- 3 Press  or  to select "9 FRAMES" (9-frame picture) or "16 FRAMES" (16-frame picture), then press .

MULTI FRAME 16 FRAMES

- 4 Press the MENU/DISPLAY button to turn off the menu screen, and then begin playback.

- 5 Press the STILL button at the point where you want to begin the multiple strobe playback.
 - A multi-frame picture of the image is displayed.

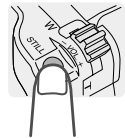

To cancel Multiple Strobe Playback

Press the STILL button again.

Note:

- Multiple Strobe Playback cannot be used during video search, still or slow playback.

Playback Effects

Playback effects can be used to create an interesting scene transition between a still image and the following image during playback in TAPE-VCR mode.

Type of Playback Effects

OVERLAP: A still image fades out as the next image fades in, replacing the previous image. The two scenes momentarily dissolve.

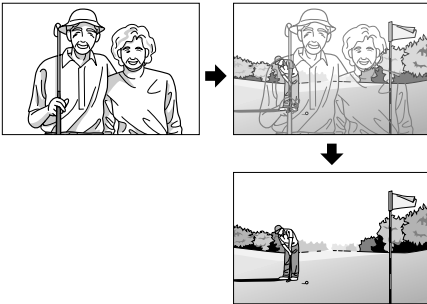

WIPE: A still image is replaced with the next image first appearing in the middle of the screen and gradually expanding to fill the screen.

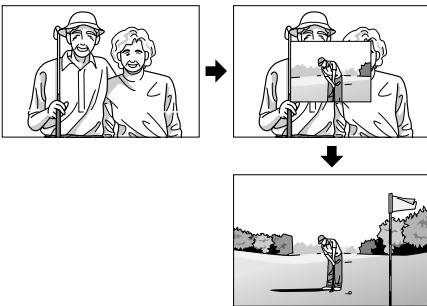



Preparation

Plan the scene transition, and record still images with the still recording function (see page 39).



Notes:

- Playback effects can also be used to provide a transition from a still image to a moving image.
- Record images for 6 seconds or longer. An image recorded for less than 6 seconds may not dissolve properly.

Using Playback Effect

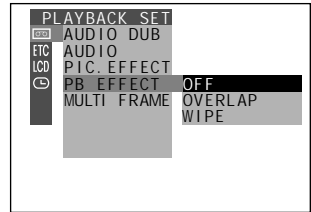
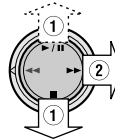
- 1 In TAPE-VCR mode, press the MENU/DISPLAY button until the menu screen appears.
- 2 Select , then press  on the Operation button. Select "PB EFFECT" (①), then press  (②).



- 3 Press  or  to select "OVERLAP" or "WIPE", then press .

PB EFFECT **WIPE**

- 4 Press the MENU/DISPLAY button to turn off the menu screen.
- 5 Rewind or fast forward the tape to just before the position where you want to use the playback effect, and then begin playback.
 - The still image is replaced with the next image with the selected playback effect.

To cancel the playback effect

Select "OFF" in step 3 above.

Notes:

- Playback effects will be canceled if Multiple Strobe Playback is used thereafter.
- Scene transition does not occur if Playback Zoom or Picture Effect Playback is used thereafter.
- Playback effects will be canceled if the power source is interrupted.

Advanced Features Playback

Picture Effect Playback

These picture effects let you play back images with a more dramatic effect.

Type of Picture Effects

B/W: The picture is displayed in black-and-white.

SEPIA: The picture is displayed in sepia color similar to that of an old photograph.



MOSAIC*: The picture is divided up into tiles.

SOLARI: The contrast of the subject is enhanced, creating a unique artistic image.



NEGA: The blacks and whites of the image are reversed and colors of the image are inverted.

*Available only in TAPE-VCR mode.

• The example screens for this feature are for TAPE-VCR mode.

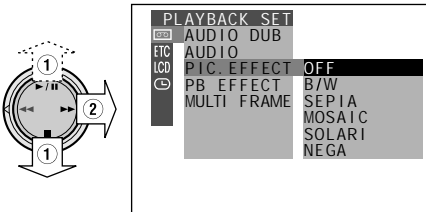
- 1 During playback in TAPE-VCR or CARD-VCR mode, press the MENU/DISPLAY button until the menu screen appears.
- 2 Select , then press  on the Operation button. Select "PIC. EFFECT" (1), then press  (2).



- 3 Press  or  to select the desired picture effect, then press .

PIC. EFFECT B/W

- 4 Press the MENU/DISPLAY button to turn off the menu screen.

To cancel Picture Effect Playback

Select "OFF" in step 3 above.

Notes:

- Images in Picture Effect Playback mode cannot be transferred via DV or PC connecting cable to a personal computer.
- **Picture Effect Playback cannot be used with Multiple Strobe Playback or Slide Show Playback.**

Picture/Backlight Adjustments

If the picture is difficult to see due to ambient lighting or other factors, adjust the monitor picture settings.

- The example screens for this feature are for TAPE-CAMERA mode.

Adjusting the Picture

- 1 Press the MENU/DISPLAY button until the menu screen appears.
- 2 Press **■** or **▶/■** to select LCD (①), then press **▶▶** (②) on the Operation button.

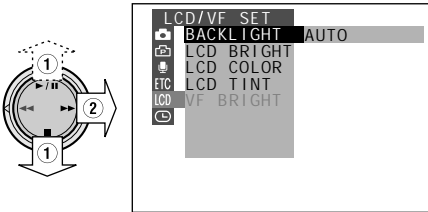

- 3 Press **■** or **▶/■** to select the item you wish to adjust, then press **▶▶**.
- 4 Press **■** or **▶/■** to adjust the item to the desired setting.

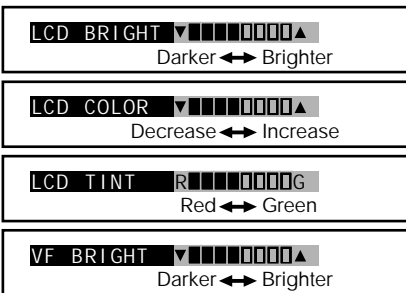

Note:

- Close the LCD monitor to turn on the viewfinder when adjusting the "VF BRIGHT".

- 5 Press **◀◀**, then press the MENU/DISPLAY button to turn off the menu screen.

Adjusting the Backlight

- 1 Press the MENU/DISPLAY button until the menu screen appears.
- 2 Select LCD, then press **▶▶** on the Operation button. Press **■** or **▶/■** to select "BACKLIGHT" (①), then press **▶▶** (②).

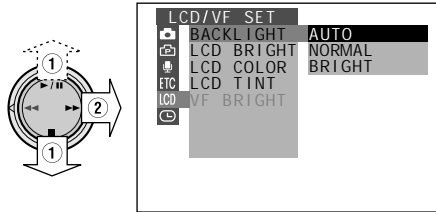

- 3 Press **■** or **▶/■** to select "AUTO", "NORMAL" or "BRIGHT", then press **◀◀**.



AUTO: The camcorder automatically switches between "NORMAL" and "BRIGHT" depending on the ambient lighting. This mode is only available in TAPE-CAMERA or CARD-CAMERA mode.

NORMAL: For use indoors or under moderate lighting conditions.

BRIGHT: For use outdoors under strong lighting conditions, such as bright daylight.

- 4 Press the MENU/DISPLAY button to turn off the menu screen.

Note:

- When the color or tint is adjusted, the picture on the LCD monitor may differ from the picture actually recorded. Do not change the color and tint settings unless it is necessary. (These adjustments only affect the monitor picture, not the recorded image.)

Editing

Video editing lets you refine your videos by removing unwanted sequences from your tape, or transposing one sequence with another. This camcorder lets you monitor the source program on the built-in LCD monitor without having to connect it to an external TV or video monitor.

Connect the camcorder to a VCR with the supplied audio/video cable, as shown.

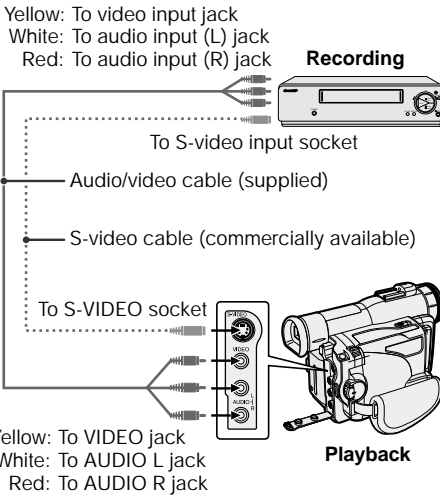

Notes:

- If your VCR has only one audio input jack, use the white plug for the audio connection on the VCR.
- If your VCR has an S-video input socket, you can use a commercially available S-video cable for the video connection. (The yellow video plug does not need to be connected to the VCR.)

Cutting Unwanted Sequences

- 1 Play back the tape to be edited on the camcorder, and locate the beginning and end of the sequence you wish to cut. Write down the time code reading at the beginning and end of that sequence (see page 46). Then, rewind the tape to before the beginning of the portion that you wish to keep.
- 2 Load a video cassette into the recording VCR.
- 3 Press **▶/||** on the camcorder to begin playback, and then press the Record button on the VCR to begin recording.
- 4 Press the Pause/Still button on the VCR to pause recording when the source tape reaches the beginning of the sequence to be cut.
- 5 Press the Pause/Still (or Record) button on the VCR to resume recording when the source tape reaches the end of the sequence to be cut.

To stop editing

Press **■** on the camcorder and press the Stop button on the VCR.

Notes:

- Some of the transitions between edited sequences may be slightly off.
- There may be picture noise during video search or still playback. This does not imply a defect in the camcorder.
- The time code display will be recorded along with the edited sequences if the TC OUT item is set to "ON". Set to "OFF" before editing (see page 46).

Recording from an External Source

You can use this camcorder to record or edit videos from another source, such as a VCR, TV, or video disc player.

Connect the camcorder to the source equipment with the supplied audio/video cable, as shown.

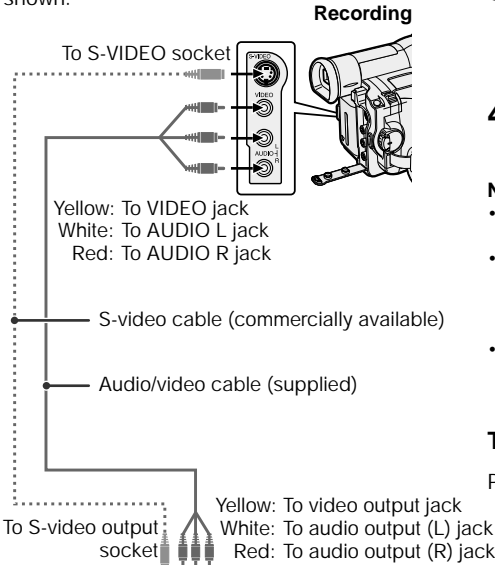

Recording

To Record from an External Source

- 1 Set the camcorder to TAPE-VCR mode.
- 2 Begin playback on the source equipment connected to the camcorder.
 - Check the camcorder screen to see if the picture is being properly received.
- 3 Press the REC START/STOP button on the camcorder.
 - The camcorder enters the Recording Standby mode.
- 4 Press ►/|| on the Operation button to begin recording.

Notes:

- To pause recording, press ►/||. Press ►/|| again to resume recording.
- To operate by remote control, perform steps 1 and 2 above, and press the TAPE REC START/STOP button, then press the PAUSE/STILL button (||).
- If "NO SIGNAL" is displayed on the camcorder screen, check that the S-video cable or audio/video cable is properly connected.

To stop recording

Press ■ on the Operation button.

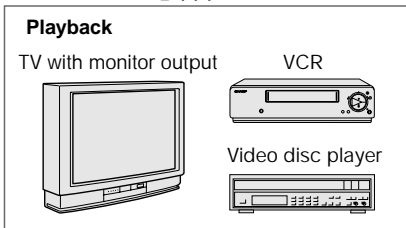

Playback

TV with monitor output

VCR

Video disc player

Notes:

- If the source equipment has only one audio output jack, use the white plug for the audio connection on the source equipment. (The input audio will only be recorded on the left channel of the tape.)
- If the source equipment has an S-video input socket, you can use a commercially available S-video cable for the video connection. (The yellow video plug does not need to be connected to the VCR.)

Editing with the DV Terminal (IEEE1394)

This camcorder enables you to perform digital video editing. Connect the camcorder to video equipment with a DV terminal using a commercially available DV cable. A DV cable is able to transfer all dubbing signals including video and audio.

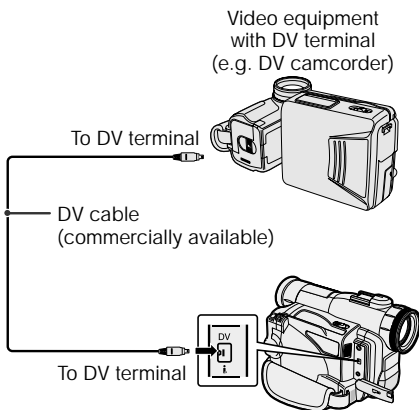

To Record to Video Equipment

See "Cutting Unwanted Sequences" on page 65, using the video equipment as the recording source.

Note:

- Make sure that the video equipment to which you are recording can input dubbing signals via the DV terminal.

To Record from Video Equipment

- 1 Set the camcorder to TAPE-VCR mode, and insert a Mini DV cassette.
- 2 Begin playback on the video equipment connected to the camcorder.
 - Check the camcorder screen to see if the picture is being properly received.
- 3 Press the REC START/STOP button on the camcorder.
 - The camcorder enters the Recording Standby mode.
- 4 Press ► / || on the Operation button to begin recording.

To stop recording

Press ■ on the Operation button.

Cutting Unwanted Sequences

- 1 Press ► / || to pause recording when the source tape reaches the beginning of the sequence to be cut.
- 2 Press ► / || to resume recording when the source tape reaches the end of the sequence to be cut.

Notes:

- Make sure that the video equipment from which you are recording can output dubbing signals via the DV terminal.
- If the video equipment is not set to the playback mode or the DV cable is not properly connected, "NO SIGNAL" is displayed on the camcorder screen.
- If no picture or sound is input to the camcorder even if the DV cable is properly connected and you are playing back the source media from the video equipment, set the Power switch on the camcorder to OFF and then back to VCR, or disconnect the DV cable and connect it again.
- If a digital video recording with a copyright protection signal is used as the playback source, "COPYRIGHT PROTECTED." appears on the camcorder monitor and the recording function is disabled (see page 88).

Audio Dubbing Feature

You can add narration to recordings made with this camcorder, while preserving the original audio and video recordings.

Microphone for Audio Dubbing

You can use the built-in stereo microphone to record narration.

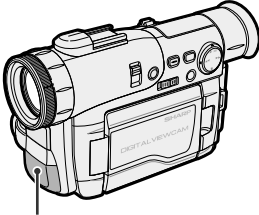

Built-in stereo microphone

Note:

- Audio dubbing cannot be performed via the DV terminal.

Audio Recording

In normal recording mode

12-bit audio recording

The audio is recorded in stereo on Audio 1.

Audio 1: Stereo (left and right) sound

Audio 2: No audio

16-bit audio recording

The audio is recorded in stereo with the left and right sound on two separate channels.

Audio 1: Left sound

Audio 2: Right sound

In Audio Dubbing mode

12-bit audio recording

The dubbed audio is recorded on Audio 2.

Audio 1: Original stereo (left and right) sound

Audio 2: Dubbed stereo (left and right) sound

16-bit audio recording

The dubbed audio is recorded on Audio 2 over the original right sound. Both the dubbed and original sounds are in mono.

Audio 1: Original left sound

Audio 2: Dubbed sound

Note:

- You can select the 12-bit or 16-bit audio recording mode by performing the procedure on page 31.

Advanced Features

Playback

Audio Dubbing

- 1 Play back the recorded Mini DV cassette and locate the tape position where you wish to start audio dubbing.
- 2 Press ►/|| to pause playback.
- 3 Press the MENU/DISPLAY button until the menu screen appears.
- 4 Select , then press ►► on the Operation button. Select "AUDIO DUB" (1), then press ►► (2).
 - The audio dubbing screen appears.

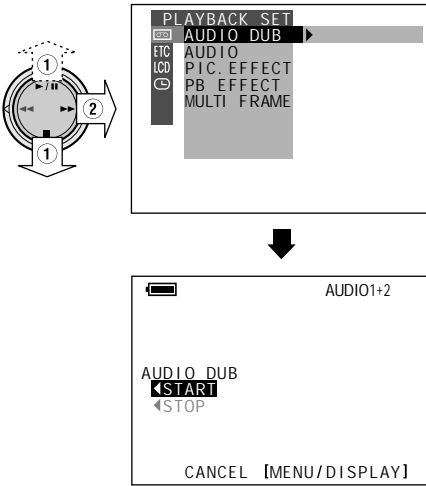

- 5 Press ◀ to begin audio dubbing. Record your narration.

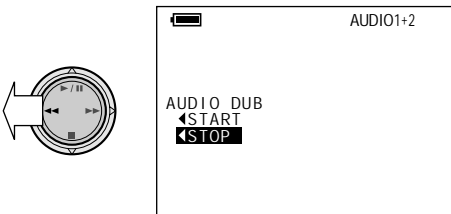

To pause audio dubbing

Press ◀◀.

To quit audio dubbing

Press the MENU/DISPLAY button. The audio dubbing screen disappears.

If you wish to change the dubbed audio or dub additional scenes

- 1 Press the MENU/DISPLAY button to turn off the audio dubbing screen.
- 2 Repeat steps 1 to 5 above.

Notes:

- Audio dubbing cannot be used with recordings made in LP mode.
- It is recommended that you use Audio Dubbing only with recordings made with this camcorder. Use of recordings made with other digital video equipment may result in poor audio quality.
- Audio dubbing will automatically pause if the original audio changes from 12-bit mode to 16-bit mode or vice versa. Press ◀◀ to resume operation.
- Audio dubbing will automatically stop if a portion recorded in LP mode is encountered.
- You can play back the dubbed audio and the original audio together or separately (see "Selecting the Audio Playback Mode" on next page).

Selecting the Audio Playback Mode

You can select any of the following audio playback modes.

Audio 1+2

- 12-bit recording in stereo (Audio 1 and Audio 2 channels)
- 16-bit recording in stereo (left and right channels)

Audio 1

- 12-bit recording in stereo (Audio 1 channel only)
- 16-bit recording in mono (left channel only)

Audio 2

- 12-bit recording in stereo (Audio 2 channel only)
- 16-bit recording in mono (right channel only)

- 1 Play back a Mini DV cassette with dubbed audio.
- 2 Press the MENU/DISPLAY button until the menu screen appears.
- 3 Select , then press **▶▶** on the Operation button. Select "AUDIO" (①), then press **▶▶** (②).

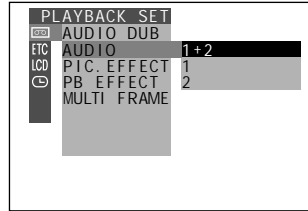
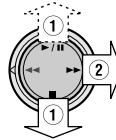

- 4 Press **■** or **▶▶/||** to select the desired audio playback mode, then press **◀◀**.



- 5 Press the MENU/DISPLAY button to turn off the menu screen.
 - The selected audio playback mode indicator is displayed.

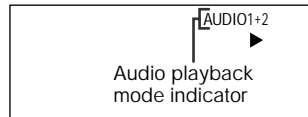

Note:

- The audio playback mode indicator, "AUDIO", is displayed in different colors depending on the recording mode (12- or 16-bit) used for the recording being played back. A white display indicates 12-bit recording mode, and a green display, 16-bit recording mode.

Configuring Software for PC Connection

This camcorder can transfer still playback images in TAPE-VCR mode or still images in TAPE-CAMERA and CARD modes to a personal computer by using the supplied Video Capture Software.

System Requirements

- IBM PC/AT or compatible with Intel® Pentium® 133 MHz or faster processor
- Microsoft Windows® 95B, Windows® 95C, Windows® 98, Windows® 98 Second Edition, Windows® 2000 Professional*, or Windows® Me operating system
- 32 MB or more of RAM
- 9 MB minimum of available hard-disk space
- SVGA (800 × 600 pixels) color display monitor with 16-bit color or higher
- CD-ROM drive (for installation)
- RS-232C serial port
- Mouse or other pointing device

* In the Windows® 2000 Professional environment, only the system administrator has installation access rights.

Installing the Software

- 1 Turn on the PC and start up Windows.
- 2 Insert the CD-ROM of the Video Capture Software into the CD-ROM drive.
- 3 Double click on the "My Computer" icon.
- 4 Double click on the "CD-ROM" drive icon.
- 5 Double click on the "Setup.exe" file.
- 6 Follow the instructions as they appear on the PC monitor until the installation is complete.
- 7 Restart the PC.

Connecting the camcorder to a Personal Computer

- 1 Turn off the PC.
- 2 Connect the camcorder as shown below.
 - Before connecting the camcorder to the PC, make sure that the PC power is off to insure that images are transferred properly.

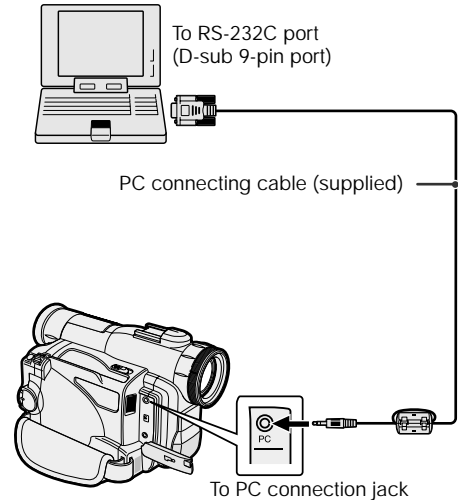

- 3 Turn on the PC.

Notes:

- It is recommended to use the AC adapter/battery charger as a power source for extended periods of use.
- Images with the following functions cannot be transferred to a personal computer.
 - TAPE-VCR/CARD-VCR mode: Playback Zoom, Picture Effect Playback
 - TAPE-CAMERA/CARD-CAMERA mode: Digital Zoom, Digital Picture Effects, Scene Menu
- Using a commercially available floppy disk adapter or PC card adapter, it is possible to directly transfer still images on a SmartMedia card to a PC (see page 85).
- To edit still images transferred with the Video Capture Software, use a commercially available image editing software.

Using the Software

For tips on how to use the Video Capture Software, refer to the operation manual located on the CD-ROM in PDF format. Follow the steps below to open the PDF file containing the manual.

Note:

- For the latest product information, be sure to read the "Readme" text file located in the "Readme" folder of the Video Capture Software CD-ROM. Select the "Readme" text file you prefer. The letters between "Readme" and ".txt" define the language: for example, "en" in "Readmeen.txt" stands for English, etc.

Installing Adobe Acrobat Reader

Adobe Acrobat Reader 4.0 or later is required for viewing the PDF manual of the Video Capture Software. If the Adobe Acrobat Reader is not installed on your PC, perform steps below to install one.

Language	File name
Chinese, Simplified	ar40chs.exe
Chinese, Traditional	ar405cht.exe
Dutch	ar405dut.exe
English	ar405eng.exe
French	ar405fre.exe
German	ar405deu.exe
Italian	ar405ita.exe
Korean	ar405kor.exe
Portugese, Brazilian	ar405por.exe
Spanish, Castilian	ar405esl.exe
Swedish	ar405swe.exe

- 1 Insert the CD-ROM of the Video Capture Software into the CD-ROM drive.
- 2 Double click on the "My Computer" icon.

- 3 Double click on the "CD-ROM" drive icon.
- 4 Double click on the "Acroread" folder.
- 5 Double click on the desired language version.
- 6 Follow the instructions as they appear on the PC monitor until the installation is complete.
- 7 Restart the PC.

Opening the PDF Manual

- 1 Insert the CD-ROM of the Video Capture Software into the CD-ROM drive.
- 2 Double click on the "My Computer" icon.
- 3 Double click on the "CD-ROM" drive icon.
- 4 Double click on the "Manual" folder.
- 5 Double click on the PDF file of the desired language version.
 - Adobe Acrobat Reader launches and the selected PDF manual opens.

Note:

- If the PDF file does not open, Adobe Acrobat Reader may not be properly installed. Refer to the steps of "Installing Adobe Acrobat Reader" to check the installation procedure.

Printing the PDF Manual

Print out the PDF manual so that you can consult it whenever necessary.

- 1 Open the PDF manual.
- 2 Select "Print" in the "File" menu.
 - Note:**
 - The menu expressions such as "Print" and "File" may vary according to the language version of Adobe Acrobat Reader installed on the PC.
- 3 Select your print settings, then click "OK".

SmartMedia Card Features

Camera Recording

Inserting and Removing a SmartMedia Card

Inserting a SmartMedia Card

- 1 Make sure that the Power switch is set to OFF.
- 2 Open the LCD monitor.

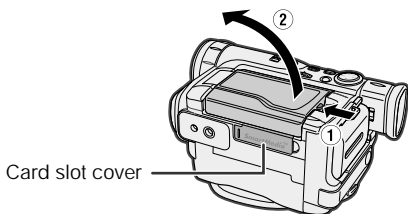

- 3 Open the card slot cover in the direction of the arrow.

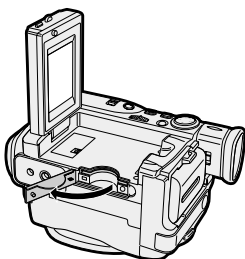

- 4 Insert a SmartMedia card into the slot as shown below, and push it in as far as it will go.

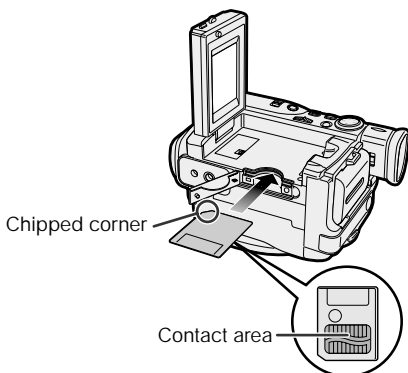

- 5 Close the card slot cover.

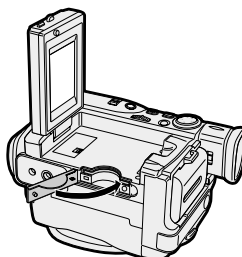

Removing a SmartMedia Card

Perform steps 1 and 2 above, and then pull the SmartMedia card straight out as shown below.

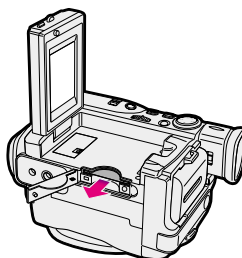

Notes:

- The supplied SmartMedia card is preformatted for immediate use.
- Be sure not to apply pressure to the card slot cover, as the camcorder may not record the still image properly.

Card Recording

It is possible to take a still picture in the same way as you do with a standard camera and record that image on the SmartMedia card.

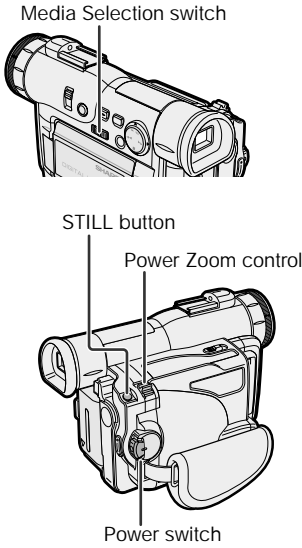

- 1 Insert a SmartMedia card into the camcorder.
- 2 Remove the lens cap, and lift up the viewfinder.
- 3 Set the Media Selection switch to CARD.
- 4 Hold down the Lock button and set the Power switch to CAMERA.
 - The picture from the lens is now displayed in the viewfinder.

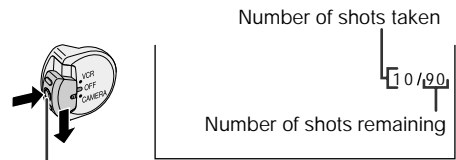
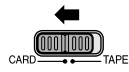

- 5 Perform steps in "Selecting a still recording effect" to select the desired still recording effect (see page 40).

- 6 Adjust the Power Zoom control to frame the subject as you desire.

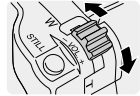

- 7 Press the STILL button to begin recording.

- The  indicator flashes red while data is being recorded on the SmartMedia card, and returns to white when recording completes.

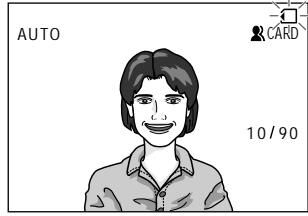
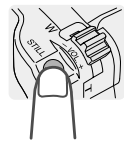
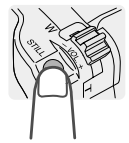

Notes:

- Recording under insufficient lighting may result in blurred images. It is recommended that you use a tripod to record insufficiently illuminated subjects.
- Recording under the light of a fluorescent, mercury, or sodium lamp may cause flickering in the image and, depending on the timing of the shot, may result in changes to color hue in the image.

Caution:

- Do not turn the power off while the  indicator is flashing in step 6.

SmartMedia Card Features

Camera Recording

Selecting the Picture Resolution

The picture quality of still images recorded on the SmartMedia card depends on the resolution setting. Select the appropriate setting to match the purpose of recording.

Type of resolution settings

NORMAL: Records images with standard picture quality.

FINE: Records images with higher quality than in NORMAL mode but with a lower number of recordable images.

ECONOMY: Allows you to take more shots than in NORMAL mode but with a lower quality.

Approximate number of recordable images for each resolution setting

Capacity of SmartMedia card	Resolution setting		
	NORMAL	FINE	ECONOMY
8 MB	104	65	195
16 MB	211	132	395
32 MB	424	265	795
64 MB	849	531	1,592

Note:

- The number of recordable images differs depending on the combination of resolution settings being used and the images being shot.

- In CARD-CAMERA mode, press the MENU/DISPLAY button until the menu screen appears.
- Select , then press **▶▶** on the Operation button. Select "REC MODE" (①), then press **▶▶** (②).

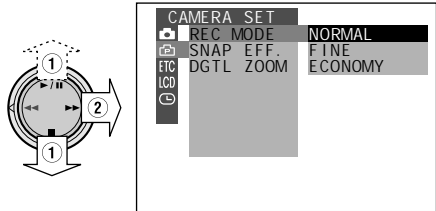

- Press **■** or **▶/||** to select the desired setting, then press **◀◀**.



- Press the MENU/DISPLAY button to turn off the menu screen.
 - The selected resolution setting indicator is displayed.

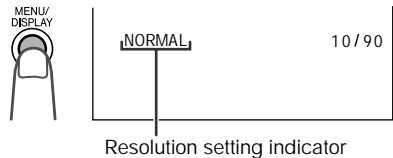

Note:

- The resolution setting indicator is also displayed in CARD-VCR mode. The resolution setting indicator displayed during playback is based on the amount of data for that recorded image. Since the amount of data differs depending on factors such as image detail, sometimes the resolution setting indicator displayed during playback may not match the resolution setting used during recording.

Recording with the Self-timer

The self-timer function allows you to record images after a time-lag of 10 seconds. This is convenient when you want to record an image of you and your friends together.

1 In CARD-CAMERA mode, press the MENU/DISPLAY button until the menu screen appears.

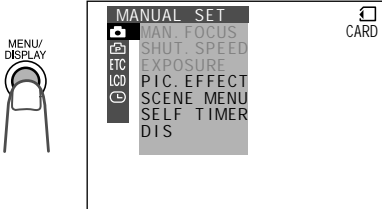

2 Select , then press **▶▶** on the Operation button. Select "SELF TIMER" (1), then press **▶▶** (2).

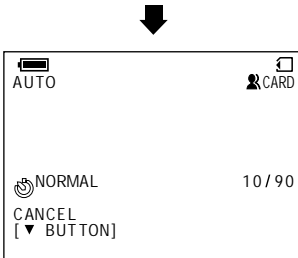
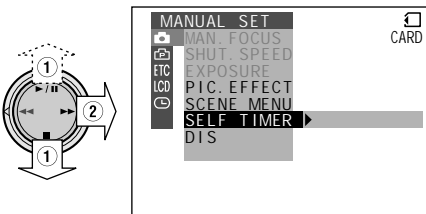

3 Frame the subject, and then press the STILL button to set the timer.

- The self-timer operating indicator flashes while the timer counts down.
- The shutter will be automatically released 10 seconds after, and a still image of the subject is recorded.

Self-timer operating indicator

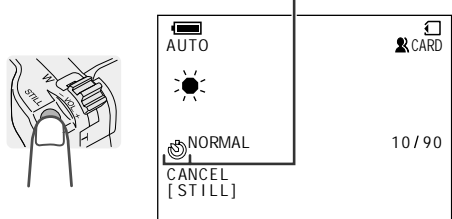

Notes:

- When recording with the self-timer, stabilize the camcorder in the horizontal plane by attaching it to a tripod, etc.
- To cancel the self-timer, press the STILL button again in step 3 above.
- Self-timer mode will be canceled after recording one image. Repeat steps 1 to 3 to record another image with the self-timer.

Caution:

- Do not turn the power off or remove the SmartMedia card once the self-timer operating indicator begins flashing.

SmartMedia Card Features

Camera Recording

Formatting a SmartMedia Card

In order to use a commercially available SmartMedia card with this camcorder, formatting is necessary before its first use. You also need to format a SmartMedia card when one of the following warning indicators appears, in order to use the card with the camcorder.

- "FORMAT MEMORY CARD"
- "MEMORY CARD ERROR"
- "MEMORY CARD READ ERROR"
- "CANNOT STORE DATA"

Cautions:

- **Formatting a SmartMedia card deletes all images on the card including the delete-protected images. Be sure to copy important data on your computer or other media before formatting the card (see pages 71 and 72).**
- Do not remove the power source during formatting, as this may cause damage to the camcorder or SmartMedia card. It is recommended that you use the AC outlet for the power supply.

- 1 Insert a SmartMedia card to be formatted into the camcorder.
- 2 Set the camcorder to CARD-CAMERA mode.
- 3 Press the MENU/DISPLAY button until the menu screen appears.

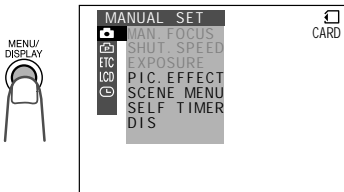

- 4 Select ETC, then press ►► on the Operation button. Select "FORMAT" (①), then press ►► (②) to display the format screen.

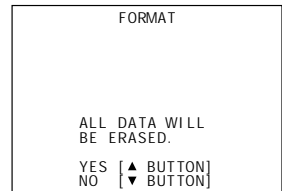
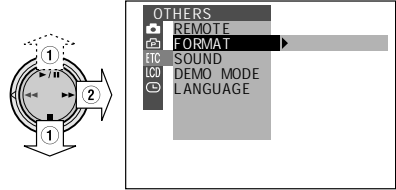

- To cancel formatting, press ■.

- 5 Press ►/|| to begin formatting.

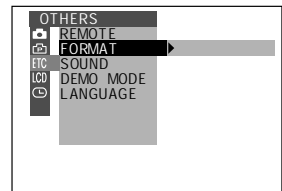
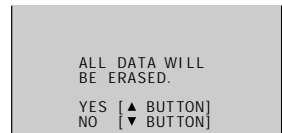
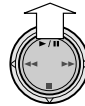

- 6 Press the MENU/DISPLAY button to turn off the menu screen.

Notes:

- The supplied SmartMedia card is preformatted for immediate use.
- **Use this camcorder to format a SmartMedia card.** The camcorder may not recognize the images on a card formatted by a computer or other equipment.
- You cannot format a SmartMedia card with a write-protect seal affixed.

SmartMedia Card Features

Playback

Card Playback

It is possible to play back and view still images recorded on a SmartMedia card on the LCD monitor.

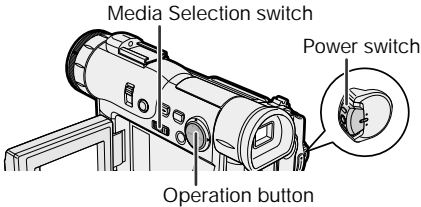

- 1 Open the LCD monitor and adjust the angle.
- 2 Set the Media Selection switch to CARD.
- 3 Hold down the Lock button and set the Power switch to VCR.
 - The images recorded on the SmartMedia card are displayed in a thumbnail format.

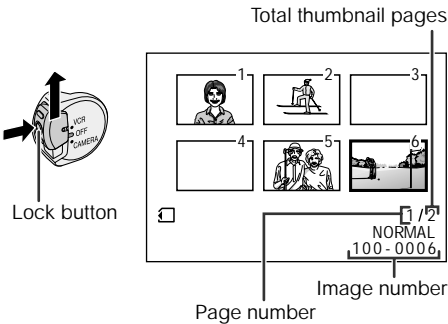
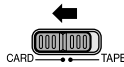

- 4 Press ◀ or ▶ on the Operation button to move the selection frame to the desired image.
 - Each time you press ◀ or ▶, the selection frame moves backward or forward.

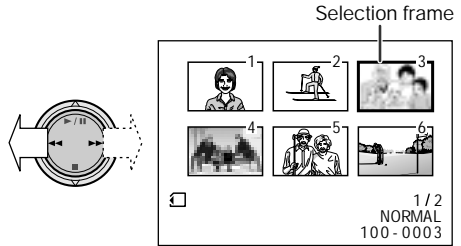

Notes:

- You can display a thumbnail of the previous (or next) 6 images by pressing ◀ (or ▶) when the selection frame is on the image at the top left (or bottom right).
- Holding down ◀ or ▶ increases the speed of motion of the selection frame.

- 5 Press ▶/■.
 - The selected image is displayed in full-screen.

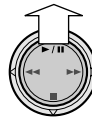

Available Operations during Full-screen Display

- You can display the full-screen picture of the previous or next image by pressing ◀ or ▶.
- To return to a thumbnail of the images, press ■.

Note:

- Depending on the amount of data for the recorded image, the resolution setting indicator displayed during playback may not match the resolution setting used during recording.

SmartMedia Card Features Playback

Slide Show Playback

It is possible to automatically play back consecutive still images recorded on a SmartMedia card at intervals of 5 seconds. This is useful when confirming the data recorded on a SmartMedia card.

- 1 Set the camcorder to CARD-VCR mode.
- 2 Press ◀ or ▶ to select the image from which you want to begin slide show playback.

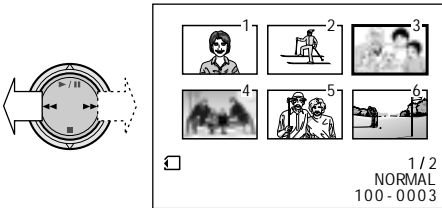

- 3 Press the MENU/DISPLAY button until the menu screen appears.
- 4 Select , then press ▶ on the Operation button. Select "SLIDE SHOW" (1), then press ▶ (2).

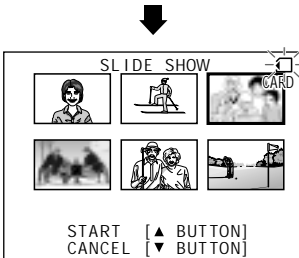
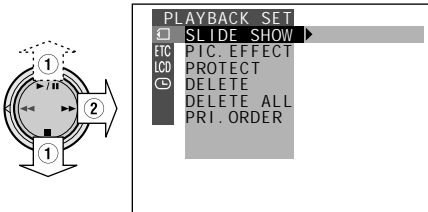

- 5 Press ▶ / ||.
 - Beginning from the image selected in step 2, the recorded images will be displayed in full-screen one after another in order of recording.



After playing back all the images on the SmartMedia card once, Slide Show Playback automatically stops.



- 6 Press the MENU/DISPLAY button to turn off the menu screen, then press  to display a thumbnail of images.

To stop Slide Show Playback



During slide show playback, press , then press the MENU/DISPLAY button to turn off the menu screen.

Delete-protection

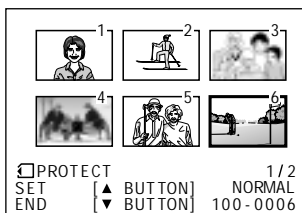
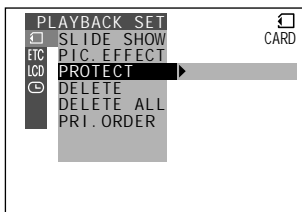
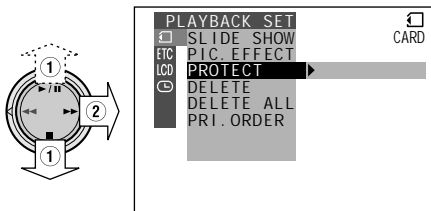

It is possible to prevent your important images recorded on the SmartMedia card from being accidentally erased.

- In CARD-VCR mode, press the MENU/DISPLAY button until the menu screen appears.
- Select , then press  on the Operation button. Select "PROTECT" (1), then press  (2).

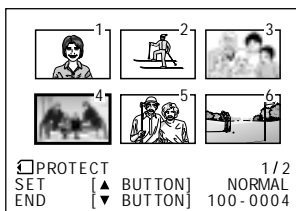
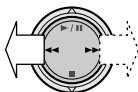

- Press the  or  to select the image to be protected.



- Press  /  to set the protection.
 - The  indicator appears.

Delete-protection indicator

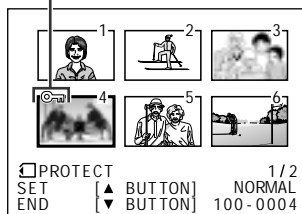
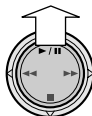





- If you want to protect another image, repeat steps 3 and 4.

- Press , then press the MENU/DISPLAY button to turn off the menu screen.

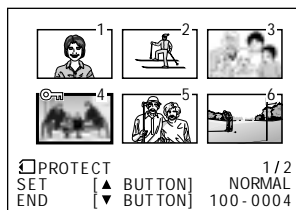
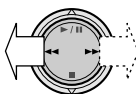
To cancel the protection setting

- Select the image for which the protection setting is to be canceled in step 3 above.



- Press  /  to cancel the protection.
 - The  indicator disappears.

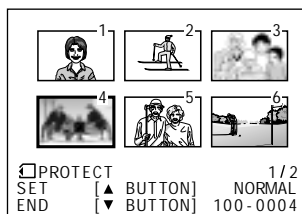
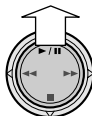

- Press , then press the MENU/DISPLAY button to turn off the menu screen.

Note:

- Formatting a SmartMedia card deletes all images on it, including the ones with the delete-protection setting.



SmartMedia Card Features Playback

Deleting One Stored Image



You can delete unwanted images to free up memory of a SmartMedia card for new images.

Note:

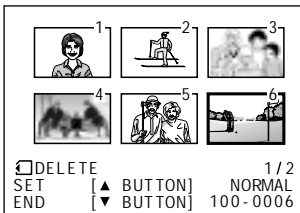
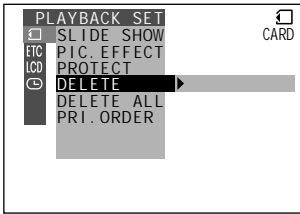
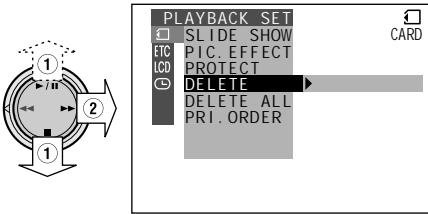

- Deleted images cannot be restored. Check whether or not you want the images before performing the procedure below.

- In CARD-VCR mode, press the MENU/DISPLAY button until the menu screen appears.
- Select , then press  on the Operation button. Select "DELETE" (1), then press  (2).



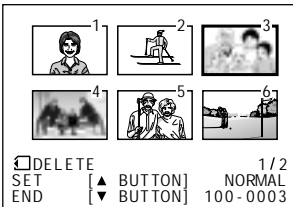
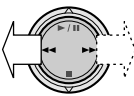

- Press  or  to select the image to be deleted.



- Press  /  to set the image.
 - To cancel deletion, press .



- Press  /  to delete the image.

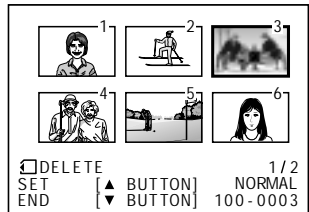
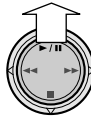

- If you want to delete another image, repeat steps 3 to 5.

- Press , then press the MENU/DISPLAY button to turn off the menu screen.

Notes:

- The protected images cannot be deleted. Cancel the protection setting to delete the image (see page 80).
- You cannot delete images on the SmartMedia card with a write-protect seal affixed.

Caution:

- Do not turn the power off while deleting an image.

Deleting All Stored Images



You can delete all images stored on a SmartMedia card in one operation.

Notes:

- Deleted images cannot be restored. Check whether or not you want the images before performing the procedure below.
- If you want to keep some images on the SmartMedia card, first delete-protect them (see page 80), and then perform the procedure below.

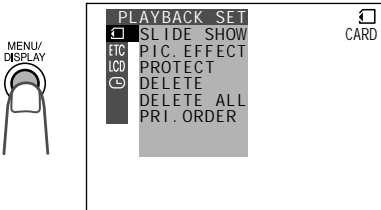

- In CARD-VCR mode, press the MENU/DISPLAY button until the menu screen appears.

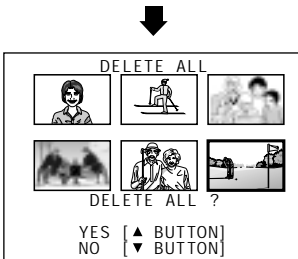
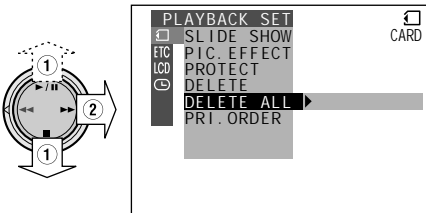

- Select , then press  on the Operation button. Select "DELETE ALL" (1), then press  (2).



- To cancel deletion, press .

- Press  /  to delete all the images.

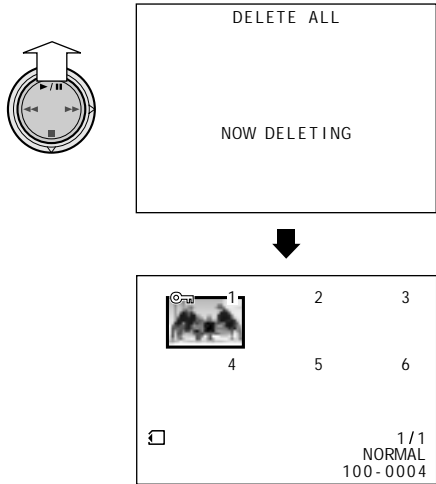

Notes:

- The protected images cannot be deleted. Cancel the protection setting to delete the image (see page 80).
- You cannot delete images on the SmartMedia card with a write-protect seal affixed.
- Deleting all stored images will not erase DPOF assigned images with delete-protection setting.

Caution:

- Do not turn the power off while deleting images.

SmartMedia Card Features Playback

Print Order

The print order function allows you to add print information called DPOF to still images recorded on a SmartMedia card.

About DPOF



DPOF is an abbreviation of "Digital Print Order Format". This format defines print information such as the specified number of pages to be printed. In the future, it will be possible to easily print still images using the DPOF feature when you use a DPOF-compatible printer or visit a shop with a service for printing DPOF images.

Notes:



- It is possible to print an image even if no print order has been assigned.
- You cannot assign a print order to images on a SmartMedia card with a write-protect seal affixed.

Assigning Print Order to an Image

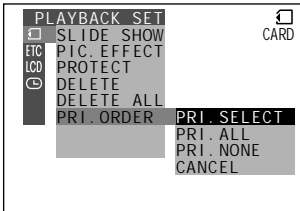
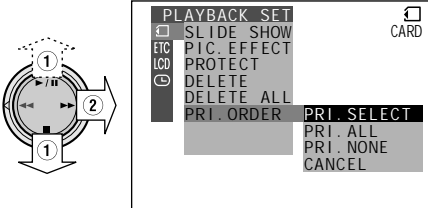

1 In CARD-VCR mode, press the MENU/DISPLAY button until the menu screen appears.

2 Select , then press  on the Operation button. Select "PRI. ORDER" (1), then press  (2).



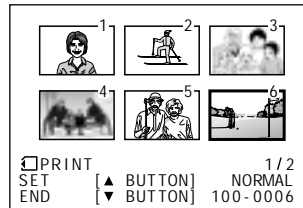
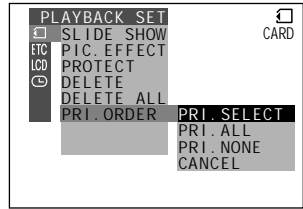
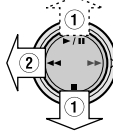

3 Press  or  (1) to select "PRI. SELECT", then press  (2) to display a thumbnail of the recorded images.

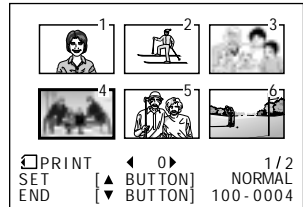
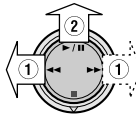

4 Press  or  (1) to select the image to which you want to assign a print order, then press  (2).



5 Press  or  to select the number of printouts.
 • 1 through 99 can be set for the number of printouts.

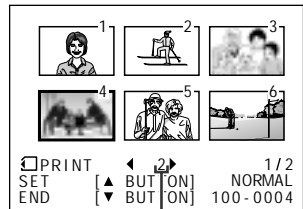
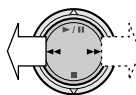

Number of printouts

- 6** Press **▶/||** to set the print order, then press **■**.
- The **■** indicator appears.
 - If you want to assign another print order, repeat steps 4 to 6.

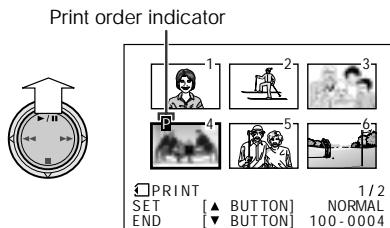

- 7** Press **■**, then press the MENU/DISPLAY button to turn off the menu screen.

To cancel the print order for an image

- 1 Select the image for which you want to cancel the print order in step 4 above, then press **▶/||**.
- 2 Press **◀◀** (1) to select "0", and press **▶/||** (2), then press **■**.
 - The **■** indicator disappears.

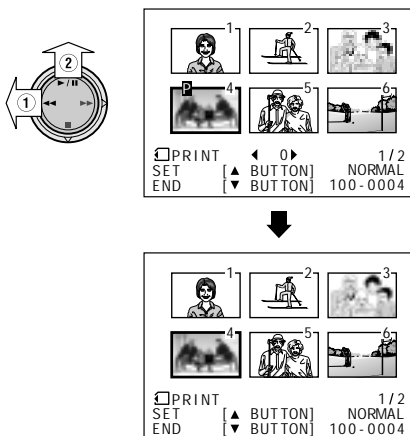

- 3** Press **■**, then press the MENU/DISPLAY button to turn off the menu screen.

Assigning Print Order to All Images

- 1 Perform steps 1 and 2 in "Assigning Print Order to an Image".
- 2 Press **■** or **▶/||** (1) to select "PRI. ALL", then press **◀◀** (2).

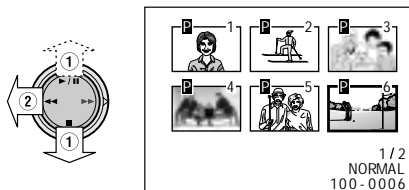

To cancel the print order for all images

- 1 Perform steps 1 and 2 in "Assigning Print Order to an Image".
- 2 Press **■** or **▶/||** (1) to select "PRI. NONE", then press **◀◀** (2) to cancel the print order for all images.

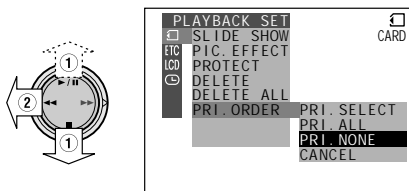

- The **■** indicators are turned off.

SmartMedia Card Features Playback

Transferring the Data on a SmartMedia Card to a Computer

In addition to using the supplied PC connecting cable, it is possible to directly transfer still images on the SmartMedia card by using a commercially available floppy disk adapter or PC card adapter.

Image Folders and File Names

Still images recorded using the camcorder are stored on a SmartMedia card as shown below.

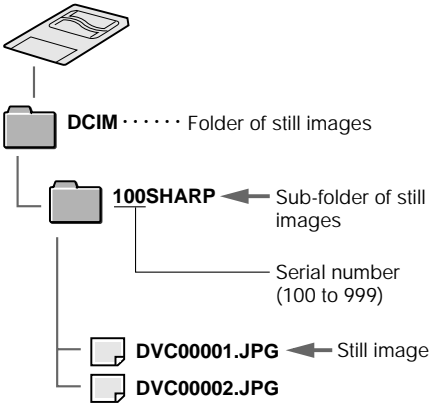

Adapters for the SmartMedia Card

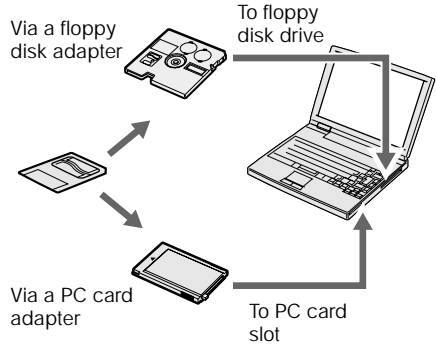

Notes:

- Be careful when using a floppy disk adapter as it is possible to write and erase data even when a write-protect seal is affixed to the SmartMedia card.
- Remove the write-protect seal from the SmartMedia card before inserting the card to a PC card adapter.
- For details, see the operation manuals of the computer, floppy disk adapter, and PC card adapter.

Useful Information

Hints for Better Shooting

- Position the subject in the center of the scene. When you are using auto focus, whatever is in the center of the scene is kept in focus.



Position the subject in the center.



Focus manually when you need to position the subject off center (see pages 47 and 48).

- Avoid backlit subjects. For the best picture, shoot with the light source behind you. When the background is brighter than the subject, the subject often becomes too dark. If you have to record with this lighting, use Gamma Brightness Compensation or correct the exposure level to improve the picture (see pages 33 and 51).

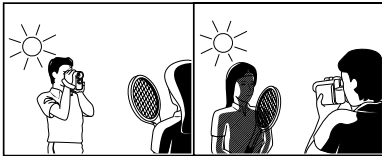

Light from behind

Backlighting

- Before zooming, think about how to best frame the shot. Frequent zooming produces unattractive pictures. It also increases the battery power consumption.
- When image shaking is noticeable during zoomed-in telephoto shooting, use a tripod or push the Power Zoom control to the W side to zoom out.
- Horizontal panning (lateral movement) and tilting (vertical movement) should be done slowly to emphasize the wide expanse of a scene or the height of a building, and to make scenes easy to watch during playback.
- Use a wide-angle setting for fast-moving subjects.

Note:

- It may take longer to focus when zooming and panning are used frequently.

Lighting

For clear, good-quality recording, 500 to 100,000 lux is needed. Recording is possible with less light, but the picture quality may suffer. Adequate lighting is also essential for correct white balance.

Brightness (Lux)	Situation (Lux)	Optimal lighting range
100,000	Blue sky Clear day at noon (100,000)	
10,000	Clear day at 10 am (65,000) Clear day at 3 pm (35,000) Cloudy day at noon (32,000) Cloudy day at 10 am (25,000)	
1,000	Cloudy day, one hour after sunrise (2,000) Clear day, one hour before sunset (1,000) Fluorescent light near window (1,000)	
100	Factory floor (700–800) Sales counter in department store (500–700) Bowling alley (500) Library (400–500) Office with fluorescent lighting (400–500)	
	Fluorescent desk lamp (400) Flashlight at 3 ft (1 m) (250) Shop stairway (100)	
10	During intermission at movie theater (15–35) Cigarette lighter at 1 ft (30 cm) (15–20) Candles on birthday cake at 8 inches (20 cm) (10–15) Candlelight	

Note: The figures in the chart are approximations.

Tips on good lighting

In most outdoor, daytime scenes, natural lighting is adequate for home videos. Indoors, however, artificial lighting is usually required. Video lights with halogen lamps provide the most natural artificial light over a long operating life.

DV Technology

Digital video, DV, is a revolutionary technology that enables recording and playback of high quality images with the use of special digital features previously unavailable with conventional analog formats.

- **High horizontal resolution**
Detailed, accurate images with the highest level of horizontal resolution for home use.
- **Clear color reproduction with virtually no color contamination**
Provides three times the color resolution of conventional VCRs (based on Sharp models). Clear images with virtually no distracting color contamination (which usually appears as red).
- **Standard use of TBC (Time Base Corrector) to prevent jittery images**
Ensures stable images with a high signal-to-noise ratio.
- **PCM digital recording**
PCM digital recording gives you high-quality stereo sound that puts you in the middle of the action.

The "DV" trademark can only be used on digital VCR products which have been evaluated and have met the specifications set by the **HD Digital VCR Conference for Standardization of Consumer Use Digital VCR Formats**.

This product incorporates copyright protection technology that is protected by method claims of certain U.S. patents and other intellectual property rights owned by Macrovision Corporation and other rights owners. Use of this copyright protection technology must be authorized by Macrovision Corporation, and is intended for home and other limited viewing uses only unless otherwise authorized by Macrovision Corporation. Reverse engineering or disassembly is prohibited.

DV and conventional video cassette tapes

There are two kinds of DV-format video cassette tapes: the Mini DV cassette and the larger DV cassette used for extended playback and recording. This camcorder only operates with Mini DV cassettes. DV cassettes cannot be used. Be sure to use Mini DV cassettes with the ^{Mini}DV mark.

Mini DV cassette



DV cassette

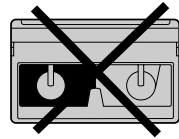

8 mm, VHS, and Beta cassettes cannot be used for playback or recording with this camcorder.

8 mm cassette



VHS cassette

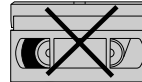

Beta cassette

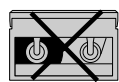

Note:

- This camcorder reproduces the highest picture quality when used with an ME tape. It is recommended you use an ME tape for high-quality recording and playback.

Mini DV Cassette

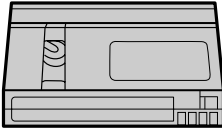

Precautions when using a Mini DV cassette

- **Be sure to use only Mini DV cassettes with the ^{Mini}DV mark.**
- **This camcorder can record and play back using Mini DV cassettes with cassette memory, but it cannot record or play back this memory.**
- **To record in LP mode, use a Mini DV cassette labeled for use with LP mode.**
- Do not insert anything into the holes on the bottom of the Mini DV cassette or block them in any way.
- Avoid placing the Mini DV cassette in an area conducive to dust or mold.
- Do not place the Mini DV cassette near magnetic sources such as electric clocks or magnetic devices as this may adversely affect recorded material.
- When a previously recorded Mini DV cassette is used again for recording, the previously recorded material will be automatically erased.
- The Mini DV cassette will not operate if inserted in the wrong direction.
- Do not repeatedly insert and eject the Mini DV cassette without running the tape as this may cause uneven tape winding and damage the tape.
- Do not place the Mini DV cassette in direct sunlight, near strong heat sources, or in areas with excessive steam.
- Store the Mini DV cassette in its case and stand it in an upright position.
- If the tape is not properly wound, rewind the tape.
- Do not drop the Mini DV cassette or subject it to excessive shocks.

To protect recordings against accidental erasure

Slide the protect tab on the rear of the Mini DV cassette to the "SAVE" position.

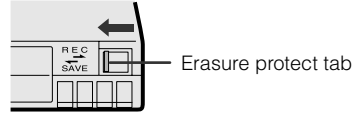

To record over a previously recorded tape, slide the protect tab to the "REC" position.

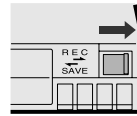

Copyright Protection

The digital VCR has far superior recording and playback ability than the traditional analog VCR, and in order to protect digital video software copyrights, a system for managing copyrights has been established. Some digital video recording with pre-recorded copyright protection signals can still be played back on this camcorder. However, these recordings cannot be output to a TV or an external monitor. If you play a digital video recording that has a copyright protection signal on video equipment with a DV terminal and attempt to record a copy of that software on this camcorder, "COPYRIGHT PROTECTED." appears on the screen and the recording is disabled.

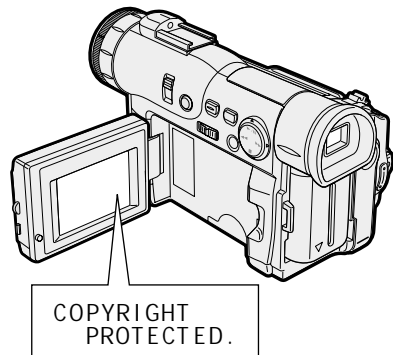

SmartMedia™ Card

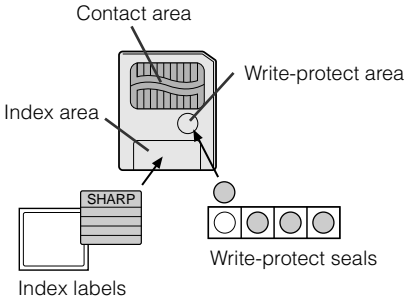

Contact area

- The contact area shows hardware connections.
- Be careful not to scratch the contact area.
- Do not touch or allow dirt or foreign matter to attach to the contact area. If the contact area becomes dirty, gently wipe with a soft, dry cloth.

Index area

- Affix the supplied index labels to the index area. Do not affix other commercially available labels. Use of labels other than those supplied may result in damage to the card.

Write-protect area

- Affixing one of the supplied write-protect seals to the write-protect area will disable recording and erasure of the card, making it read-only. (This prevents accidental erasure and recording.) Removing the seal will once again enable recording and erasure.
- Affix the supplied write-protect seals to the write-protect area. Do not affix other commercially available seals. Use of seals other than those supplied may result in damage to the card.

Write-protect seals

- Affix write-protect seals so that they do not stick beyond the write-protect area, come loose or peel off.
- If the write-protect seal becomes dirty, wipe it gently with a soft, dry cloth.
- Do not reuse a write-protect seal once it has been affixed and removed.

Precautions on handling the SmartMedia card

- The card is a precision device. Do not bend, apply excessive pressure, subject to shock, or drop.
- Do not store or use in a location subject to a strong electromagnetic field or electronic noise.
- When not in use, store the card in the supplied protective case to prevent damage from static electricity.
- Do not put the card in your pocket or other unprotected location as it may break due to pressure applied when you sit.
- Do not store or use in an environment subject to high temperature, humidity, lots of dust, or corrosion.
- Do not expose the card to fire.
- The card has a life expectancy. After a long period of use, the card will become incapable of recording new information.
- Do not remove the card from the camcorder or turn off the camcorder power while recording or erasing data as this may result in accidental erasure of data or damage to the card.
- Remove the write-protect seal (if any) before attaching a card to a commercially available PC card adapter.
- Be careful when operating using a commercially available floppy disk adapter as it is possible to write and erase data even when a write-protect seal is affixed to the card.
- Always format cards on this camcorder. This camcorder may not recognize the data on cards formatted on your computer.

Battery Pack

This camcorder uses a lithium-ion type battery pack.

Charging

- Charge the battery pack immediately (or a day) before use. The battery pack gradually self-discharges even if stored in a fully charged state.
- Charge the battery pack between 50°F and 86°F (10°C and 30°C).
- Fully charge the battery pack. Use of an insufficiently charged battery pack will shorten actual time of use.
- Refresh (discharging before charging) is unnecessary.

Use

- To conserve battery power, be sure to turn off the camcorder power when not in use.
- Battery consumption may vary depending on the condition of use. Recording with many starts and stops, frequent zooming, and recording in low temperatures will shorten actual recording times.
- Use of a weak battery pack may cause loss of power while operating the camcorder. Use a fully charged battery pack to protect both the battery pack and the unit.
- It is recommended that you have enough battery packs on hand to handle two or three times your estimated recording time. See page 20 for the approximate times of actual recording for the battery packs.

Battery power is consumed even when the camcorder power is turned off. If you are not going to use your camcorder immediately, remove the battery pack (see page 10).

Note:

- Use only SHARP BT-L221 or BT-L441 battery packs. These are designed specifically for use with this camcorder.

Storage

- Store the battery pack in a fully discharged state.
- Store the battery pack in a dry, cool place.
- When storing a fully charged battery pack, put the cover on it so that the “CHARGE” mark printed on the label is seen through the window, as shown.

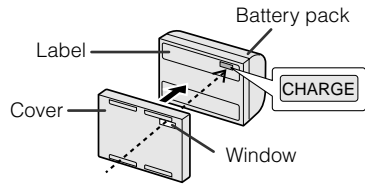

When storing a battery pack that is not fully charged, put the cover upside down so that only the battery pack casing can be seen through the window.

Cautions:

- Improper handling of the battery pack may present a risk of fire or explosion. Pay close attention to the following:
 - Do not allow metallic objects to come in contact with the terminals. This can cause a short circuit.
 - Do not disassemble or repair the battery pack by yourself.
 - Do not use any battery charging equipment other than that designed for use with these battery packs.
 - Do not place the battery pack under direct sunlight or in excessively hot places (over 140°F or 60°C) such as the dashboard of cars.
 - Do not expose the battery pack to moisture or water.
 - Do not drop the battery pack or subject it to strong force.
 - Keep the battery pack out of reach of children.
 - Dispose of used battery packs promptly. Do not dispose of them in fire.
- To protect the terminals, put the cover on the battery pack when it is not being used.

Notes:

- The battery pack will become warm during charging and use. This is not a malfunction.
- The battery pack has a limited service life. If the period of use becomes noticeably shorter with a normal charge, the battery pack is at the end of its service life. Replace it with a new battery pack.
- If the terminals of the battery pack are dirty, wipe the terminals with a soft, dry cloth.

AC Adapter/Battery Charger

- The AC adapter/battery charger may interfere with reception if used near a radio.
- Prevent flammables, liquids, and metal objects from entering the adapter/charger.
- The adapter/charger is a sealed unit. Do not attempt to open or modify it.
- Do not damage, drop, or subject the adapter/charger to vibration.
- Do not leave the adapter/charger in direct sunlight.
- Avoid using the adapter/charger in humid or extremely hot places.

Replacing the Fluorescent Lamp

This camcorder uses a fluorescent lamp to backlight the LCD monitor. If the monitor becomes dark or difficult to view, the fluorescent lamp may need to be replaced. Contact the nearest SHARP service center or your dealer for further advice.

Dew Formation

• What is “dew formation”?

When cold water is poured into a glass, dew drops form on the glass. This clinging of water drops is called dew formation.

• When dew forms in your camcorder.

Dew will gradually form on the head drum of your camcorder and make the video tape stick to the head. This causes damage both to the head and the tape. When dew formation occurs, recording and playback may not function properly.

Dew is likely to form in the following circumstances:

- When moving the camcorder from a cold place to a warm place.
- When placing the camcorder in a cold room which is then heated rapidly.
- When moving the camcorder outdoors from an air conditioned room.
- When placing the camcorder in the direct path of air blowing from an air conditioner.
- When placing the camcorder in a humid room.



• How to prevent trouble due to dew formation.

When using the camcorder in a place where dew formation is likely to occur, allow the camcorder and the video tape to acclimate to the surroundings for about one hour. For example, when bringing the camcorder indoors after skiing, place it in a plastic bag.

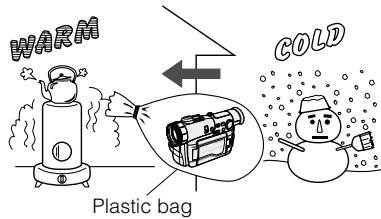

- ① Be sure to tightly seal the plastic bag containing the camcorder.
- ② Remove the bag when the air temperature inside it reaches the temperature of the room.

• “Dew” warning feature

If dew forms, the word “DEW” flashes on the screen, and the power will automatically turn off in approximately 10 seconds.

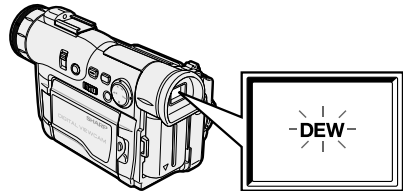

- ① If “DEW” flashes, remove the cassette, leave the cassette compartment open, and wait for a few hours to allow the camcorder to acclimate to the surrounding temperature.
- ② To use the camcorder again, turn on the power after waiting for a few hours. Be sure that “DEW” has disappeared.
- ③ Do not insert a cassette while “DEW” is flashing; this may result in damage to the tape.
- ④ Since dew forms gradually, it may take 10 to 15 minutes before the dew warning feature engages.

Dirty Video Heads

Using the camcorder when the video tape is dirty may cause the heads to clog, producing noise on the recorded image or preventing the image from being recorded at all.

If the video heads become clogged, the  indicator appears on the screen. Contact the nearest SHARP service center or your dealer for further advice.

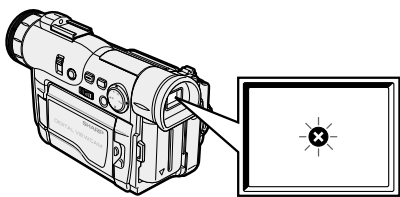

Using a Cleaning Tape (Commercially Available)

Video head cleaning can be done by using a commercially available cleaning tape.

Notes:

- **Excessive use of the cleaning tape, however, may cause damage to the video heads. Please read the instructions accompanying the cleaning tape carefully before using it.**
- The fast forward and rewind functions cannot be used when the cleaning tape is in the camcorder.

- 1 Insert a cleaning tape into the camcorder.
- 2 Set the camcorder to TAPE-VCR mode.
 - The video head cleaning screen appears.
- 3 Press  on the Operation button to begin video head cleaning.
 - "NOW CLEANING" flashes during cleaning.

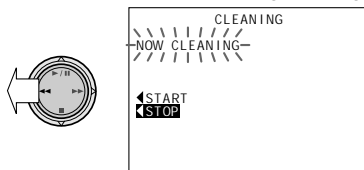

After about 20 seconds, video head cleaning automatically finishes, and "EJECT THE CASSETTE." is displayed.

- 4 Remove the cleaning tape.

To cancel cleaning, press .

Cleaning

- Many plastic parts are used in the camcorder casing. Do not use thinner, benzene or other strong chemical cleaners. These may cause discoloration and damage to the casing.
- Clean the casing with a soft, dry cloth. If the casing is particularly dirty, wipe the casing with a tightly wrung cloth dampened with a diluted, neutral detergent. Then wipe it again with a soft, dry cloth.
- Use a soft cloth to wipe finger marks and other soiling off the LCD screen.
- Use a soft cloth, or compressed air and lens paper designed for photographic lenses to clean the lens and the viewfinder eyepiece.

Using Your Camcorder Abroad

Television signal standards and electrical voltages and frequencies vary substantially from country to country. When you are abroad, check the sections below before using the AC adapter/battery charger or connecting the camcorder to a TV.

AC Adapter/Battery Charger (Supplied Accessory)

The supplied AC adapter/battery charger is compatible with 50 Hz and 60 Hz electrical systems in the range of 110 V to 240 V AC. An AC plug adapter may be required depending on the design of the electrical outlet.

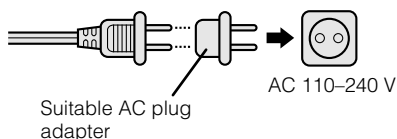

Television Signal Standards

In any country, you can always watch the video picture by using the LCD monitor screen.

However, if you want to watch the picture on a TV screen, the TV must be NTSC-M system compatible. NTSC-M is used in the following areas:

The Bahamas, Barbados, Bermuda, Myanmar (previously Burma), Canada, Chile, Colombia, Costa Rica, Cuba, the Dominican Republic, Ecuador, El Salvador, Greenland, Guam, Guatemala, Haiti, Honduras, Jamaica, Japan, South Korea, Mexico, the Netherland Antilles, Nicaragua, Panama, Peru, the Philippines, Puerto Rico, St. Kitts, St. Lucia, Surinam, Taiwan, Trinidad, the U.S.A., Venezuela, Southern Vietnam, and the Virgin Islands.

Demonstration Mode

You can watch a brief demonstration of the special camcorder features in Demo mode. If the demonstration appears on the screen when you turn on the camcorder for the first time, cancel the Demo mode to use your camcorder.

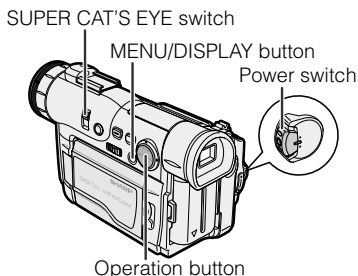

Note:

- The demonstration is only displayed in English.

Watching the Demonstration

- 1 Remove the Mini DV cassette from the camcorder (see page 12), and set the SUPER CAT'S EYE switch to OFF.
- 2 Hold down the Lock button and set the Power switch to CAMERA.
- 3 Press the MENU/DISPLAY button until the menu screen appears.

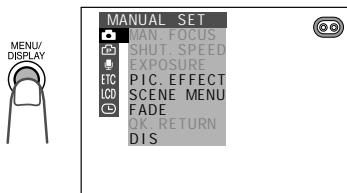

- 4 Select ETC, then press ►► on the Operation button. Select "DEMO MODE" (①), then press ►► (②).

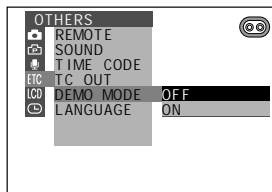
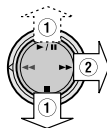

- 5 Press ◼ or ►/|| to select "ON", then press ◀◀.



- 6 Set the Power switch to OFF, then hold down the Lock button and set the Power switch to CAMERA.
 - The demonstration begins.

Canceling Demo Mode

- 1 During the demonstration, press the MENU/DISPLAY button to pause the demonstration.
- 2 Select ETC, then press ►► on the Operation button. Select "DEMO MODE", then press ►►.
- 3 Press ◼ or ►/|| to select "OFF", then press ◀◀.
- 4 Press the MENU/DISPLAY button to turn off the menu screen.



Note:

- The demonstration will pause if you press the MENU/DISPLAY button. If you leave it for 60 seconds, or turn the power off temporarily and then set the Power switch to CAMERA, the demonstration will begin again.

Before Requesting Service

Before calling for service, please check the following troubleshooting table.

	Symptom	Possible cause	Suggested solution
Power	No power.	Power source is not properly connected.	Connect power source properly (pp. 10, 11) .
		Battery pack is not charged.	Charge battery pack sufficiently (p. 9) .
		Dew in camcorder.	Wait until dew dries (p. 91) .
		Safety function is in effect.	Set Power switch to OFF and remove battery pack; wait for 2 seconds, then reinstall battery pack and turn on power (p. 10) .
Recording mode	REC START/STOP button does not work.	Erasure protect tab on video cassette is open.	Close tab or use a new cassette (p. 88) .
	Power suddenly turns off.	Camcorder left in Recording Standby mode for 5 minutes in TAPE-CAMERA mode.	Set Power switch to OFF and then back to CAMERA.
	Auto focus does not work.	Manual Focus mode is engaged.	Set to Auto Focus mode (p. 48) .
		Zoom used on close subject.	Zoom out from subject (p. 21) .
		Subject has little contrast in brightness, or is full of horizontal or vertical stripes.	Focus manually (p. 47) .
	Bright subject produces wide vertical lines.	Occurs when shooting subject with strong contrast to the background. Does not indicate a malfunction.	—
	Automatically zooms out without operating Power Zoom control.	Camcorder is unable to focus when zooming in on subject within 6 feet (1.8 m), and automatically zooms out until it focuses on subject.	—
		No subject in the field of view.	Direct lens to some subject, or set zoom to widest angle before shooting (p. 21) .
On-screen displays automatically change.	Camcorder is in Demo mode.	Set DEMO MODE menu item to "OFF" (p. 93) .	
Playback mode	No image appears on connected TV screen.	Video input channel on TV or TV channel is not selected properly.	Select video input channel or TV channel properly (p. 24) .
		Audio/video cable is not properly connected.	Connect audio/video cable properly (p. 24) .

Appendix

	Symptom	Possible cause	Suggested solution
Playback mode	Cannot play back, rewind or fast forward tape.	Position at beginning or end of tape.	Rewind or fast forward tape to desired point (p. 23).
	Video noise in image.	Dirty video heads.	Call for service (p. 96), or use a commercially available video head cleaning tape (p. 92).
		Old or worn tape.	Use a new cassette.
Card mode	Cannot delete image on SmartMedia card.	Write-protect seal is affixed to card.	Remove write-protect seal (p. 89).
		Image is delete-protected.	Cancel the protection setting (p. 80).
	Cannot format SmartMedia card.	Write-protect seal is affixed to card.	Remove write-protect seal (p. 89).
General	Cassette will not eject.	Power source is not properly connected.	Connect power source properly (pp. 10, 11).
		Battery pack is not charged.	Charge battery pack sufficiently (p. 9).
		Camcorder is recording.	Stop tape and try again (p. 20).
	Viewfinder picture is hard to see.	Viewfinder diopter is not properly adjusted.	Adjust diopter (p. 18).
	LCD monitor picture is hard to see.	Inappropriate picture adjustments.	Adjust picture (p. 64).
	Cannot edit to connected video equipment.	Audio/video or DV cable is not properly connected.	Connect audio/video or DV cable properly (pp. 65–67).
	Remote control does not function.	REMOTE menu item is set to "OFF".	Set REMOTE menu item to "ON" (pp. 43, 44).
		Remote control battery has run down.	Replace remote control batteries with new ones (p. 43).
		Remote control used beyond operating range.	Use remote control within operating range (p. 44).
		Intense daylight falling on camcorder remote sensor.	Protect remote sensor from exposure to intense daylight (p. 44).
		Obstacle between remote control and camcorder remote sensor.	Remove obstacle or use remote control from different angle (p. 44).

Notes:

- This unit is equipped with a microprocessor. Its performance could be adversely affected by external electrical noise or interference. If this should happen, turn off the power and disconnect the unit from any power sources, including the lithium battery, etc. Then reconnect the power sources to resume operation.
- If the characters displayed in the viewfinder or on the LCD monitor appear to malfunction, disconnect the power source and remove the lithium battery, then reconnect the power source, insert the lithium battery, and turn the power on again. The characters should be normal. Set the date and time, then resume operation.

Specifications

Camcorder

Signal System:	NTSC standard
Recording System:	2 rotary heads, helical scanning system
Cassette:	Digital VCR Mini DV video cassette
Recording/Playback Time:	90 minutes (DVM60, LP mode)
Tape Speed:	SP mode: 18.812 mm/second LP mode: 12.555 mm/second
Pickup Device:	1/4" (6.4 mm, effective size: 4.5 mm) CCD image sensor (with approx. 460,000 pixels including optical black)
Lens:	26× optical/780× digital power zoom lens (F1.6, f=3.5–91.0 mm), full-range auto focus
Lens Filter Diameter:	37 mm
Viewfinder:	Electronic LCD color viewfinder
Monitor:	2.5" (6.3 cm) (VL-WD450U)/3" (7.5 cm) (VL-WD650U) full-color LCD screen (TFT active matrix)
Microphone:	Electret stereo microphone
Color Temperature Compensation:	Auto white balance with white balance lock
Minimum Illumination:	1 lux (9 lux measured by EIA standard) (with gain-up, F1.6)
Still Image Compression	
System/Recording Format:	JPEG base line conformance/JPEG (Exif2.1)
Still Image Recording Medium:	3.3 V type SmartMedia™ card (SSFDC)
Power Requirement:	DC 7.4 V
Power Consumption:	4.0 W (during camera recording using the viewfinder in Full Auto mode with zoom motor off) 4.8 W (VL-WD450U)/5.1 W (VL-WD650U) (during camera recording using the LCD monitor in Full Auto mode with zoom motor off and backlight in normal mode)
Operating Temperature:	32°F to 104°F (0°C to +40°C)
Operating Humidity:	30% to 80%
Storage Temperature:	–4°F to 140°F (–20°C to +60°C)
Dimensions (approx.):	3 1/16" (W) × 4 21/32" (H) × 7 11/32" (D) [93.7 mm (W) × 118 mm (H) × 186.5 mm (D)]
Weight (approx.):	1.58 lbs (715 g) (VL-WD450U)/1.62 lbs (735 g) (VL-WD650U) (without battery pack, lithium battery, video cassette and lens cap)

AC Adapter/Battery Charger (UADP-0321TAZZ)

Power Requirement:	AC 110–240 V, 50/60 Hz
DC Output:	7.3 V
Power Consumption:	23 W
Dimensions (approx.):	2 23/32" (W) × 1 11/16" (H) × 4 7/16" (D) [69 mm (W) × 43 mm (H) × 113 mm (D)]
Weight (approx.):	0.35 lbs (160 g)

SmartMedia™ Card (Supplied Accessory)

Memory Capacity:	8 MB
Memory Type:	NAND flash EEPROM
Power Requirement:	3.3 V
Operating Temperature:	32°F to 104°F (0°C to +40°C)
Storage Temperature:	–4°F to 149°F (–20°C to +65°C)

Specifications are subject to change without notice.

SERVICE INFORMATION (For the U.S.)

For the location of the nearest Sharp Authorized Service, or to obtain product literature, accessories, supplies or customer assistance, please call 1-800-BE SHARP (1-800-237-4277) or visit SHARP's website (<http://www.sharp-usa.com>).

Guía de operación rápida en español

Carga de la batería

- 1 Conecte el cable de alimentación suministrado al zócalo de alimentación de CA del adaptador de CA/cargador de baterías, y enchufe la clavija de CA en una toma de corriente.
- 2 Alinee la marca ▼ de la batería con la marca ▲ del cargador (1) e introduzca la batería guiándola en la ranura. Presionando la batería (2), deslícela en el sentido de la flecha (3) hasta que quede bloqueada en posición.

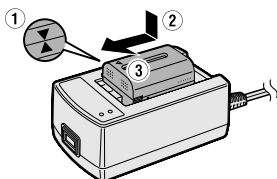

Colocación de la batería

- 1 Asegúrese de que el interruptor de alimentación esté en OFF.
- 2 Levante el visor.
- 3 Alinee la marca ■ del costado de la batería con la marca ◀ de la videocámara (1), y deslice la batería completamente hacia abajo hasta que quede bloqueada en posición (2).

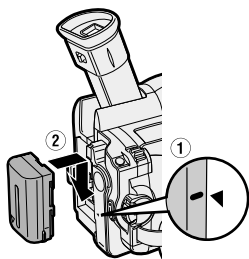

Conexión de la alimentación

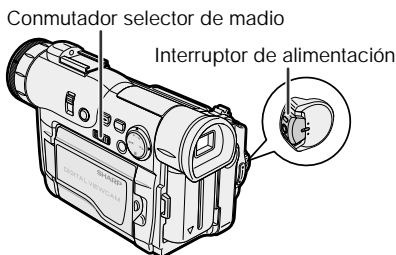

Para utilizar las funciones de grabación de la cámara, mantenga pulsado el botón de bloqueo y ponga el interruptor de alimentación en CAMERA.

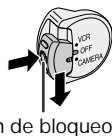

Botón de bloqueo

Para utilizar las funciones de reproducción y edición, mantenga pulsado el botón de bloqueo y ponga el interruptor de alimentación en VCR.

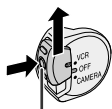

Botón de bloqueo

Cambio de medio

Para utilizar un minivideocasete DV y poder grabar y reproducir imágenes, ponga el conmutador selector de medio en TAPE.

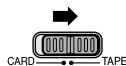

Para utilizar una tarjeta SmartMedia y poder grabar y reproducir imágenes fijas, ponga el conmutador selector de medio en CARD.

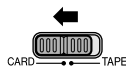

Desconexión de la alimentación

Ponga el interruptor de alimentación en OFF sin pulsar el botón de bloqueo.

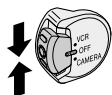

Inserción de un minivideocasete DV

- 1 Coloque la fuente de alimentación en la videocámara, y luego deslice el control de apertura de la puerta del compartimento del videocasete y abra la puerta del compartimento del videocasete.

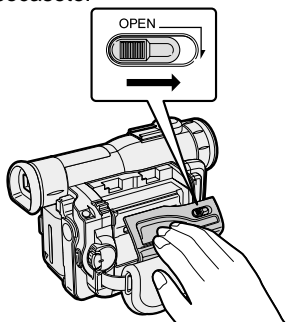

- 2 Inserte completamente el videocasete con la ventanilla hacia fuera y con la lengüeta de protección contra borrado hacia la parte superior.

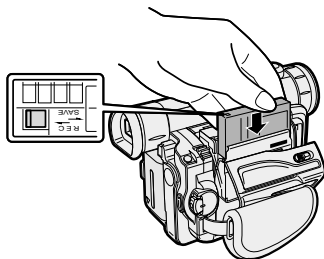

- 3 Pulse suavemente la marca **PUSH/押す** hasta que el portavideocasete encaje en posición produciendo un chasquido. Cierre la puerta del compartimento pulsando sobre el centro hasta que quede cerrada produciendo un chasquido.

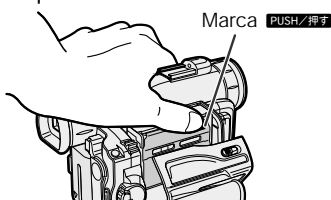

Inserción de una tarjeta SmartMedia

- 1 Asegúrese de que el interruptor de alimentación esté en OFF.
- 2 Abra el monitor LCD.

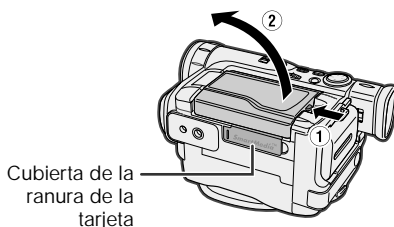

- 3 Abra la cubierta de la ranura de la tarjeta en el sentido de la flecha.

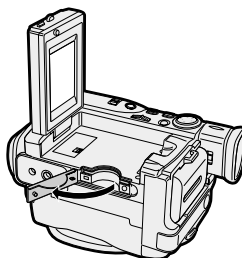

- 4 Inserte una tarjeta SmartMedia en la ranura como se muestra abajo y empújela hasta el fondo.

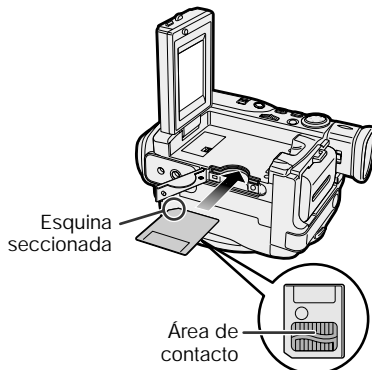

- 5 Cierre la cubierta de la ranura de tarjeta.

Grabación fácil con la videocámara en una cinta

- 1 Asegúrese de que se encuentre insertado un casete.
- 2 Quite la tapa del objetivo y levante el visor.
- 3 Ponga el conmutador selector de medio en TAPE.
- 4 Mantenga pulsado el botón de bloqueo y ponga el interruptor de alimentación en CAMERA.
- 5 Pulse el botón REC START/STOP para iniciar la grabación.

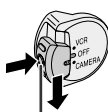
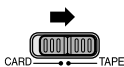

Botón de bloqueo

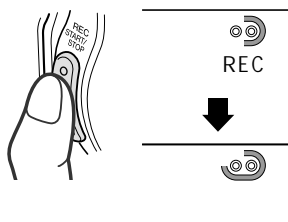

Empleo del zoom

Pulse el control del zoom motorizado hacia el lado de la T (1) (telefoto) o el lado de la W (2) (granangular).

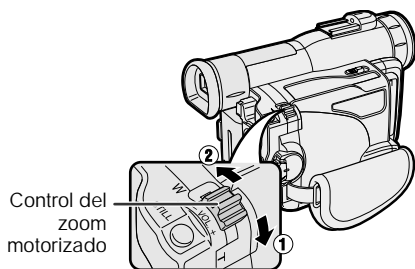

Control del zoom motorizado

Reproducción de cinta

- 1 Pulse el botón de apertura del monitor LCD (OPEN) (1) y abra el monitor LCD de manera que forme un ángulo de 90° con el cuerpo de la videocámara (2).

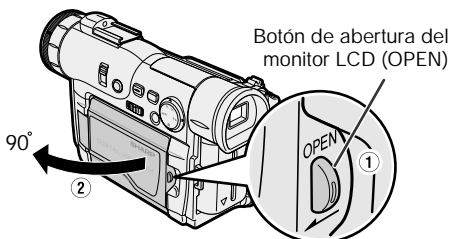

Botón de apertura del monitor LCD (OPEN)

- 2 Ajuste el monitor LCD con un ángulo que permita ver fácilmente las imágenes de la pantalla.
- 3 Ponga el conmutador selector de medio en TAPE.
- 4 Mantenga pulsado el botón de bloqueo y ponga el interruptor de alimentación en VCR.
- 5 Pulse ◀◀ (o ▶▶) del botón de operación para rebobinar (o avanzar rápidamente) la cinta hasta el punto deseado.

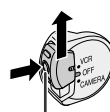

Botón de bloqueo

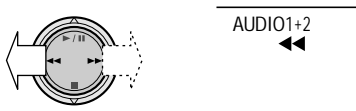

- 6 Pulse ▶/|| para iniciar la reproducción.



Para detener la reproducción

Pulse ■ .

Grabación con tarjeta

1 Asegúrese de que se encuentre insertado una tarjeta SmartMedia.

2 Quite la tapa del objetivo y levante el visor.

3 Ponga el conmutador selector de medio en CARD.



4 Mantenga pulsado el botón de bloqueo y ponga el interruptor de alimentación en CAMERA.

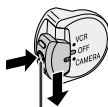

Botón de bloqueo

5 Pulse el botón STILL para iniciar la grabación.

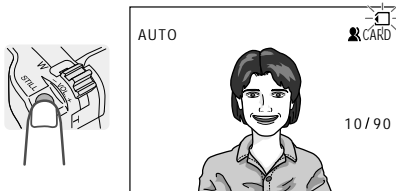

Reproducción de tarjeta

1 Pulse el botón de apertura del monitor LCD (OPEN) (1) y abra el monitor LCD de manera que forme un ángulo de 90° con el cuerpo de la videocámara (2).

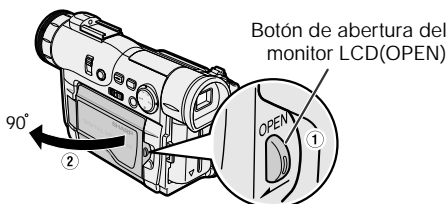

Botón de apertura del monitor LCD(OPEN)

90°

2 Ajuste el monitor LCD con un ángulo que permita ver fácilmente las imágenes de la pantalla.

3 Ponga el conmutador selector de medio en CARD.



4 Mantenga pulsado el botón de bloqueo y ponga el interruptor de alimentación en VCR.

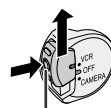

Botón de bloqueo

5 Pulse ◀◀ o ▶▶ del botón de operación para mover el cuadro de selección hasta la imagen deseada.

Cuadro de selección

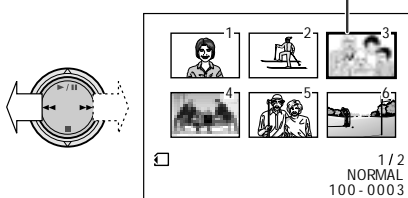

6 Pulse ▶ / II.

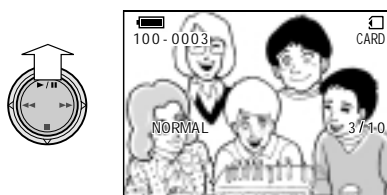

Visualizaciones en pantalla en español

Cuando se selecciona "ESPAÑOL" como idioma de la visualización en pantalla aparecen las siguientes visualizaciones indicadas a continuación.

Modo TAPE-CAMERA

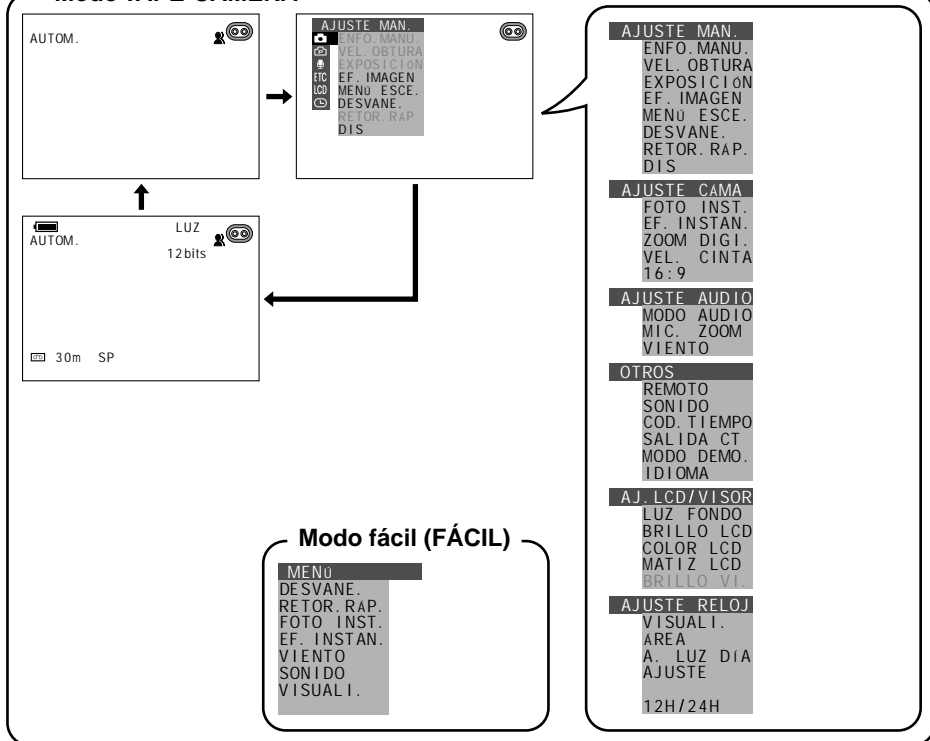

Modo TAPE-VCR

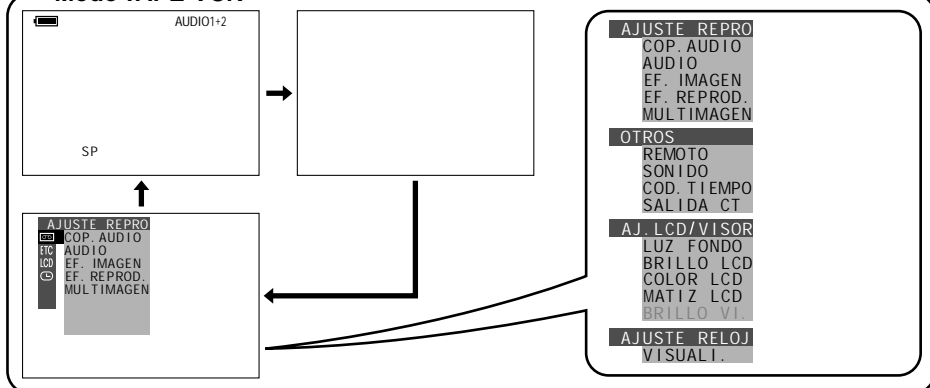

Modo CARD-CAMERA

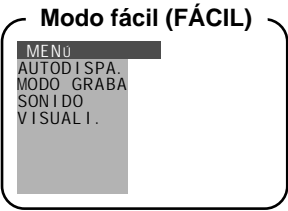
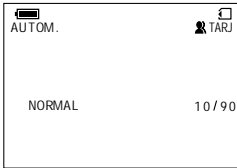
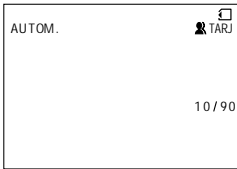

AJUSTE MAN.
 ENFO. MANU.
 VEL. OBSTURA
 EXPOSICION
 EF. IMAGEN
 MENU ESCE.
 AUTODISPA.
 DIS

AJUSTE CAMA
 MODO GRABA
 EF. INSTAN.
 ZOOM DIGI.

OTROS
 REMOTO
 FORMATO
 SONIDO
 MODO DEMO.
 IDIOMA

AJ. LCD/VISOR
 LUZ FONDO
 BRILLO LCD
 COLOR LCD
 MATIZ LCD
 BRILLO VI.

AJUSTE RELOJ
 VISUALI.
 AREA
 A. LUZ DIA
 AJUSTE
 12H/24H

Modo CARD-VCR

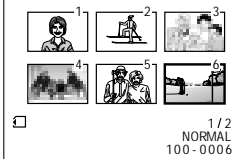

AJUSTE REPRO
 DIAPOSIT.
 EF. IMAGEN
 PROTEGER
 BORRAR
 BORR. TODO
 ORDEN IMP.

OTROS
 REMOTO
 SONIDO

AJ. LCD/VISOR
 LUZ FONDO
 BRILLO LCD
 COLOR LCD
 MATIZ LCD
 BRILLO VI.

AJUSTE RELOJ
 VISUALI.

Affichages sur écran en français

Les affichages sur écran suivants apparaissent lorsque "FRANÇAIS" est sélectionné pour la langue de l'affichage.

Mode TAPE-CAMERA

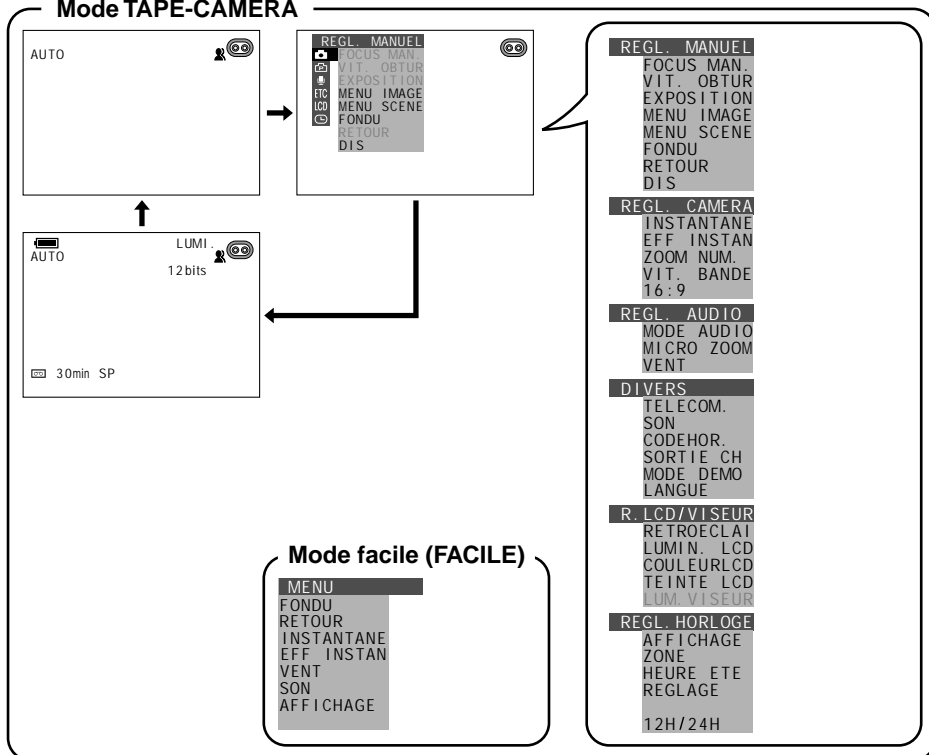

Mode TAPE-VCR

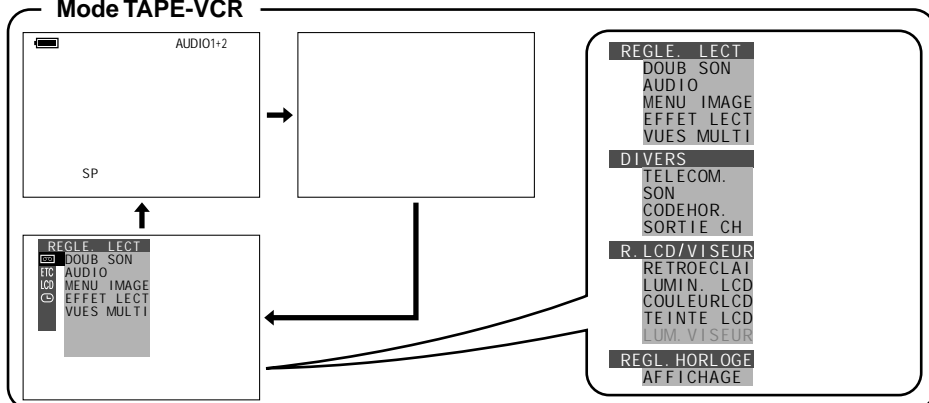

Mode CARD-CAMERA

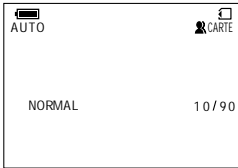
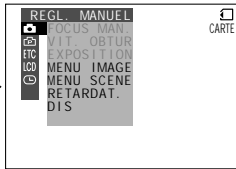
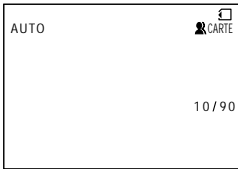

Mode facile (FACILE)

MENU
RETARDAT.
MODE ENREG
SON
AFFICHAGE

REGL. MANUEL
FOCUS MAN.
VIT. OBTUR
EXPOSITION
MENU IMAGE
MENU SCENE
RETARDAT.
DIS

REGL. CAMERA
MODE ENREG
EFF INSTAN
ZOOM NUM.

DIVERS
TELECOM.
FORMAT
SON
MODE DEMO
LANGUE

R. LCD/VISEUR
RETROECLA
LUMIN. LCD
COULEURLCD
TEINTE LCD
LUM. VISEUR

REGL. HORLOGE
AFFICHAGE
ZONE
HEURE ETE
REGLAGE
12H/24H

Mode CARD-VCR

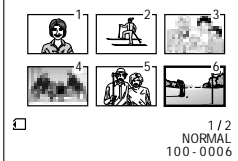

REGLE. LECT
PRES. DIAPO
MENU IMAGE
PROTGER
EFFACER
EFFACER TT
ORD. IMPRES

DIVERS
TELECOM.
SON

R. LCD/VISEUR
RETROECLA
LUMIN. LCD
COULEURLCD
TEINTE LCD
LUM. VISEUR

REGL. HORLOGE
AFFICHAGE

CONSUMER LIMITED WARRANTY

SHARP ELECTRONICS CORPORATION warrants to the first consumer purchaser that this Sharp brand product (the "Product"), when shipped in its original container, will be free from defective workmanship and materials, and agrees that it will, at its option, either repair the defect or replace the defective Product or part thereof with a new or remanufactured equivalent at no charge to the purchaser for parts or labor for the period(s) set forth below.

This warranty does not apply to any appearance items of the Product nor to the additional excluded item(s) set forth below nor to any Product the exterior of which has been damaged or defaced, which has been subjected to improper voltage or other misuse, abnormal service or handling, or which has been altered or modified in design or construction.

In order to enforce the rights under this limited warranty, the purchaser should follow the steps set forth below and provide proof of purchase to the servicer.

The limited warranty described herein is in addition to whatever implied warranties may be granted to purchasers by law. ALL IMPLIED WARRANTIES INCLUDING THE WARRANTIES OF MERCHANTABILITY AND FITNESS FOR USE ARE LIMITED TO THE PERIOD(S) FROM THE DATE OF PURCHASE SET FORTH BELOW. Some states do not allow limitations on how long an implied warranty lasts, so the above limitation may not apply to you.

Neither the sales personnel of the seller nor any other person is authorized to make any warranties other than those described herein, or to extend the duration of any warranties beyond the time period described herein on behalf of Sharp.

The warranties described herein shall be the sole and exclusive warranties granted by Sharp and shall be the sole and exclusive remedy available to the purchaser. Correction of defects, in the manner and for the period of time described herein, shall constitute complete fulfillment of all liabilities and responsibilities of Sharp to the purchaser with respect to the Product, and shall constitute full satisfaction of all claims, whether based on contract, negligence, strict liability or otherwise. In no event shall Sharp be liable, or in any way responsible, for any damages or defects in the Product which were caused by repairs or attempted repairs performed by anyone other than an authorized servicer. Nor shall Sharp be liable or in any way responsible for any incidental or consequential economic or property damage. Some states do not allow the exclusion of incidental or consequential damages, so the above exclusion may not apply to you.

THIS WARRANTY GIVES YOU SPECIFIC LEGAL RIGHTS. YOU MAY ALSO HAVE OTHER RIGHTS WHICH VARY FROM STATE TO STATE.

Model Specific Section**Your Product Model****Number & Description:**

VL-WD450U/VL-WD650U Camcorder

(Be sure to have this information available when you need service for your Product.)

Warranty Period for this Product:

One (1) year parts and ninety (90) days labor from date of purchase except for the rechargeable battery incorporated in this Product which is warranted for thirty (30) days from date of purchase.

Additional Item(s) Excluded from Warranty Coverage (if any):

Disk Media supplied with this Product is warranted for replacement only and limited to ninety (90) days from date of purchase. Non-rechargeable batteries are excluded from warranty coverage.

Where to Obtain Service:

From a Sharp Authorized Servicer located in the United States. To find the location of the nearest Sharp Authorized Servicer, call Sharp toll free at 1-800-BE-SHARP.

What to do to Obtain Service:Ship prepaid or carry in your Product to a Sharp Authorized Servicer. Be sure to have **Proof of Purchase** available. If you ship the Product, be sure it is insured and packaged securely.TO OBTAIN SUPPLY, ACCESSORY OR PRODUCT INFORMATION, GO TO OUR WEBSITE AT www.sharp-usa.com

OR CALL 1-800-BE-SHARP

SHARP®**SHARP ELECTRONICS CORPORATION**

Sharp Plaza, Mahwah, New Jersey 07430-2135

SHARP CORPORATION

Osaka, Japan

Printed in Malaysia

TINSE0391TAZZ ©

Free Manuals Download Website

<http://myh66.com>

<http://usermanuals.us>

<http://www.somanuals.com>

<http://www.4manuals.cc>

<http://www.manual-lib.com>

<http://www.404manual.com>

<http://www.luxmanual.com>

<http://aubethermostatmanual.com>

Golf course search by state

<http://golfingnear.com>

Email search by domain

<http://emailbydomain.com>

Auto manuals search

<http://auto.somanuals.com>

TV manuals search

<http://tv.somanuals.com>